



The Future of Analog IC Technology®

MP3398E

4-String, Max 400mA/String, 80V Return,
Step-Up, WLED Controller

DESCRIPTION

The MP3398E is a step-up controller with four current channels designed to drive WLED arrays for large LCD panel backlighting applications. The MP3398E is able to expand the number of LED channels with two or more ICs in parallel sharing a single power source.

The MP3398E employs peak-current mode with a fixed switching frequency. The frequency is programmable through an external setting resistor. The MP3398E drives an external MOSFET to boost up the output voltage from a 4.5V to 33V input supply and regulates the current in each LED string to the value set by an external current-setting resistor.

The MP3398E applies four internal current sources for current balancing. The current matching achieves 2.3% regulation accuracy between strings. The low regulation voltage on the LED current sources reduces power loss.

The MP3398E supports direct PWM dimming and analog dimming with PWM input. Full protection features include over-current protection (OCP), over-temperature protection (OTP), under-voltage protection (UVP), over-voltage protection (OVP), LED short/open protection, and inductor/diode short protection.

The MP3398E is available in TSSOP-16EP, SOIC-16 and PDIP-16 packages.

FEATURES

- 4-String, Max 400mA/String WLED Driver
- 4.5V to 33V Input Voltage Range
- 80V ABS Rating for Each String
- 2.3% Current Matching Accuracy between Each String
- Direct PWM Dimming Mode
- Analog Dimming Mode with PWM Input
- Cascading Capability with a Single Power Source
- LED Open and Short Protection
- Programmable Recoverable Over-Voltage Protection (OVP)
- 202mV Latch-Off Cycle-by-Cycle Current Limit Threshold
- Latch-Off Over-Temperature Protection (OTP)
- Short Inductor/Diode Protection
- Available in TSSOP-16EP, SOIC-16 and PDIP-16 Packages

APPLICATIONS

- Desktop LCD Flat Panel Displays
- All-in-One PCs
- 2D/3D LCD TVs

All MPS parts are lead-free, halogen-free, and adhere to the RoHS directive. For MPS green status, please visit the MPS website under Quality Assurance. "MPS" and "The Future of Analog IC Technology" are registered trademarks of Monolithic Power Systems, Inc.

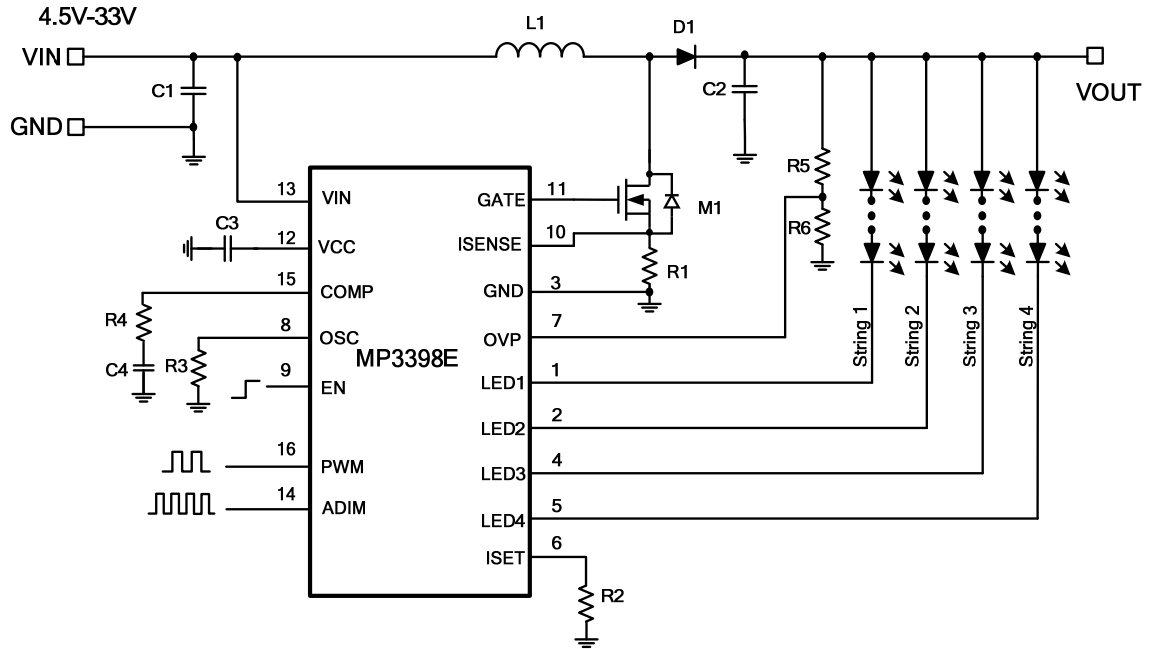
TYPICAL APPLICATION

ORDERING INFORMATION

Part Number	Package	Top Marking
MP3398EGF*	TSSOP-16EP	See Below
MP3398EGP**	PDIP-16	See Below
MP3398EGS***	SOIC16 ⁽¹⁾	See Below

* For Tape & Reel, add suffix -Z (e.g. MP3398EGF-Z)

** For Tape & Reel, add suffix -Z (e.g. MP3398EGP-Z)

*** For Tape & Reel, add suffix -Z (e.g. MP3398EGS-Z)

NOTE:

1) For the MP3398E with the SOIC16 package, check with the factory to ensure that the product is in stock.

TOP MARKING (MP3398EGF)

MPSYYWW

MP3398E

LLLLLL

MPS: MPS prefix
 YY: Year code
 WW: Week code
 MP3398E: Part number
 LLLLLL: Lot number

TOP MARKING (MP3398EGP)

MPSYYWW

MP3398E

LLLLLLLL

MPS: MPS prefix
 YY: Year code
 WW: Week code
 MP3398E: Part number
 LLLLLLLL: Lot number

TOP MARKING (MP3398EGS)

MPSYYWW

MP3398E

LLLLLL

MPS: MPS prefix
 YY: Year code
 WW: Week code
 MP3398E: Part number
 LLLLLLLL: Lot number

PACKAGE REFERENCE

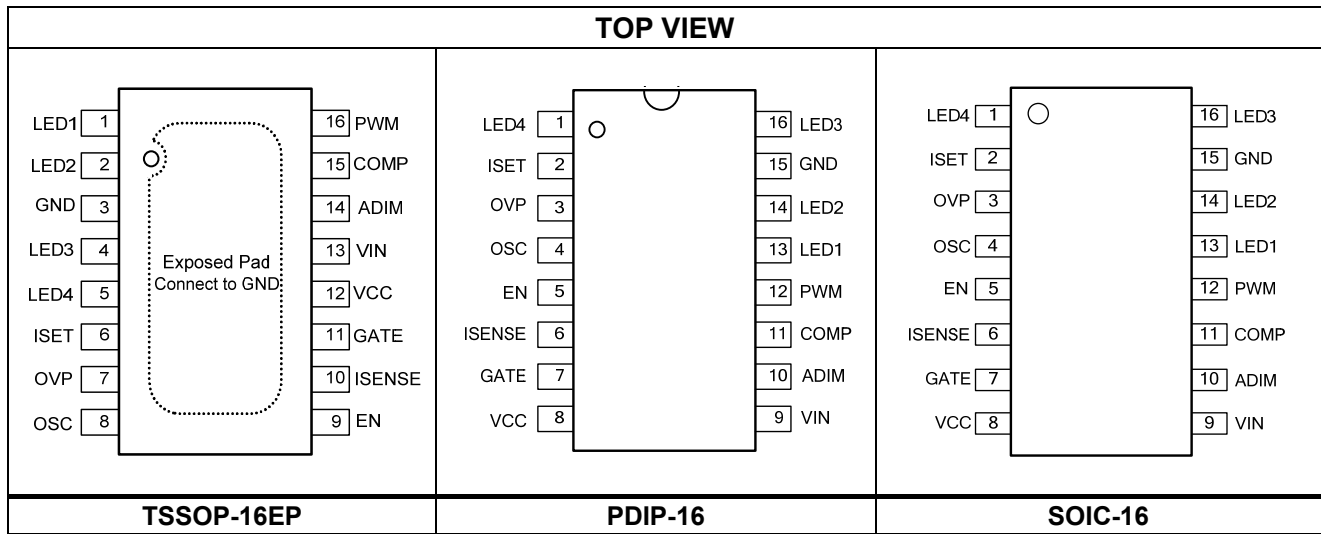

ABSOLUTE MAXIMUM RATINGS ⁽¹⁾

V _{IN}	-0.3V to +40V
V _{LED1} to V _{LED4}	-0.3V to +80V
All other pins.....	-0.3V to +6.5V
Continuous power dissipation (T _A = 25°C) ⁽²⁾	
TSSOP-16EP.....	2.78W
PDIP16.....	1.39W
SOIC16.....	1.56W
Junction temperature.....	150°C
Lead temperature.....	260°C
Storage temperature.....	-60°C to +150°C

Recommended Operating Conditions ⁽³⁾

Supply voltage (V _{IN}).....	4.5V to 33V
Max LED current.....	400mA
Operating junction temp.....	-40°C to +125°C

Thermal Resistance ⁽⁴⁾

	θ_{JA}	θ_{JC}
TSSOP-16 EP.....	45	10
PDIP-16.....	90	25
SOIC-16.....	80	35

NOTES:

- 1) Exceeding these ratings may damage the device.
- 2) The maximum allowable power dissipation is a function of the maximum junction temperature T_J (MAX), the junction-to-ambient thermal resistance θ_{JA} , and the ambient temperature T_A. The maximum allowable continuous power dissipation at any ambient temperature is calculated by P_D (MAX) = (T_J (MAX)-T_A)/ θ_{JA} . Exceeding the maximum allowable power dissipation produces an excessive die temperature, causing the regulator to go into thermal shutdown. Internal thermal shutdown circuitry protects the device from permanent damage.
- 3) The device is not guaranteed to function outside of its operating conditions.
- 4) Measured on JESD51-7, 4-layer PCB.

ELECTRICAL CHARACTERISTICS

$V_{IN} = 12V$, $V_{EN} = 5V$, $T_A = 25^{\circ}C$, unless otherwise noted.

Parameters	Symbol	Condition	Min	Typ	Max	Unit
General						
Operating input voltage	V_{IN}		4.5		33	V
Supply current (quiescent)	I_Q	$V_{IN} = 12V$, no switching		3.85	4.5	mA
Supply current (shutdown)	I_{ST}	$V_{EN} = 0V$, $V_{IN} = 12V$			1	μA
LDO output voltage	V_{CC}	$7V < V_{IN} < 28V$, $0 < I_{VCC} < 10mA$	5.5	5.9	6.3	V
VCC UVLO threshold	V_{IN_UVLO}	Rising edge	3.7	4	4.3	V
VCC UVLO hysteresis				350		mV
EN high voltage	V_{EN_HIGH}	V_{EN} rising	1.5			V
EN low voltage	V_{EN_LOW}	V_{EN} falling			0.6	V
Step-Up Converter						
Gate driver sourcing impedance		$V_{CC} = 5.9V$, $V_{GATE} = 5.9V$		4		Ω
Gate driver sinking impedance		$V_{CC} = 5.9V$, $I_{GATE} = 10mA$		2.5		Ω
Switching frequency	f_{SW}	$R_{OSC} = 100k\Omega$	305	382	460	kHz
OSC voltage	V_{OSC}	$R_{OSC} = 100k\Omega$, $f_{SW} = 382kHz$	0.77	0.8	0.83	V
Maximum duty cycle	D_{MAX}	$R_{OSC} = 100k\Omega$	90			%
Cycle-by-cycle ISENSE current limit			180	202	224	mV
COMP source current limit	I_{COMP_SOLI}	$1V < COMP < 2.9V$		30		μA
COMP sink current limit	I_{COMP_SILI}	$1V < COMP < 2.9V$		18		μA
COMP transconductance	G_{COMP}	$\Delta I_{COMP} = \pm 10\mu A$		120		$\mu A/V$
Current Dimming						
PWM input low threshold	V_{PWM_LO}	V_{PWM} falling			0.4	V
PWM input high threshold	V_{PWM_HI}	V_{PWM} rising	1.5			V
ADIM input low threshold	V_{ADIM_LO}	V_{ADIM} falling			0.4	V
ADIM input high threshold	V_{ADIM_HI}	V_{ADIM} rising	1.5			V
Current Regulation						
ISET voltage	V_{ISET}		1.95	2	2.05	V
LEDX average current	I_{LED}	$R_{ISET} = 100.8k\Omega$	192	202	212	mA
Current matching ⁽⁵⁾		$I_{LED} = 200mA$			2.3	%
LEDX regulation voltage		$I_{LED} = 200mA$		430		mV
		$I_{LED} = 60mA$		285		mV

ELECTRICAL CHARACTERISTICS (continued)
 $V_{IN} = 12V, V_{EN} = 5V, T_A = 25^{\circ}C$, unless otherwise noted.

Parameters	Symbol	Condition	Min	Typ	Max	Unit
Protection						
OVP threshold	V_{OVP_OV}		1.9	2.0	2.1	V
OVP UVLO threshold	V_{OVP_UV}	Step-up converter fails		55		mV
LEDX UVLO threshold	V_{LEDX_UV}			200		mV
LEDX over-voltage threshold	V_{LEDX_OV}		7.2	8	8.8	V
Thermal protection threshold	T_{ST}			130		$^{\circ}C$

NOTE :

5) Matching is defined as the difference between the maximum to minimum current divided by 2 times the average current.

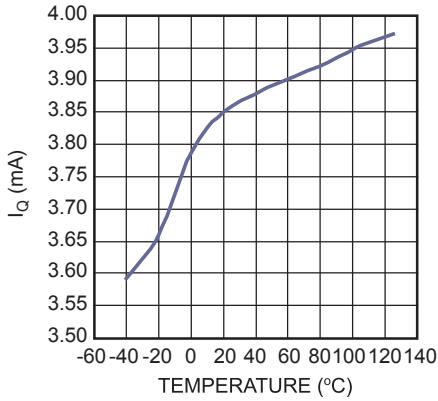
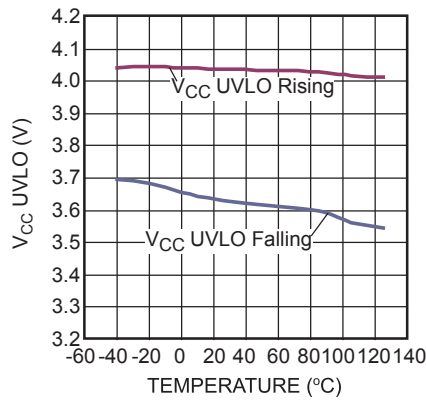
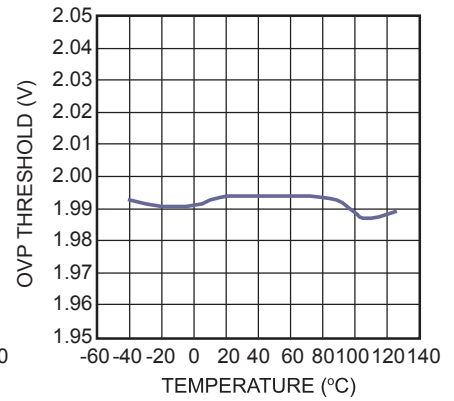
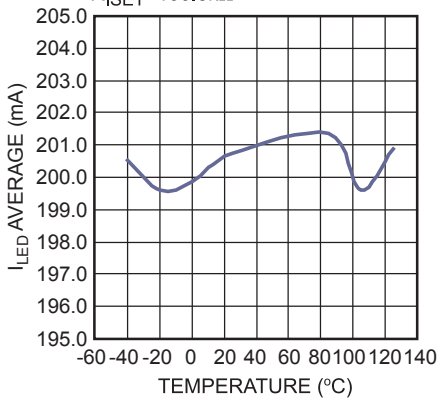
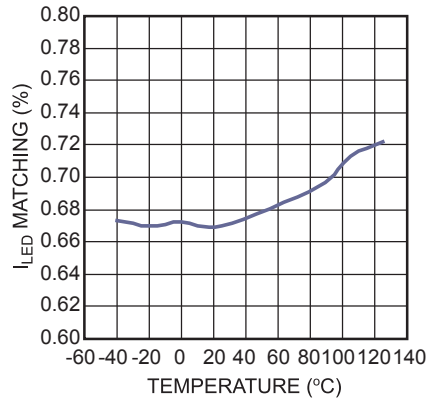
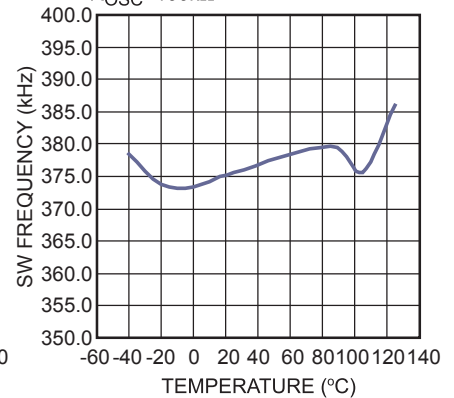
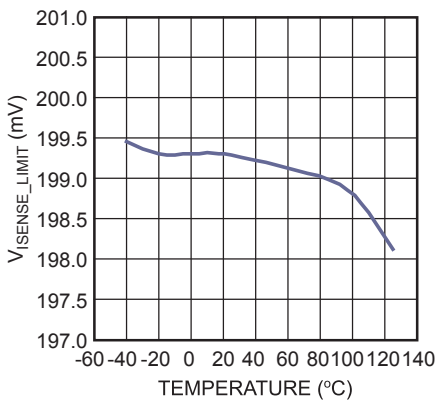
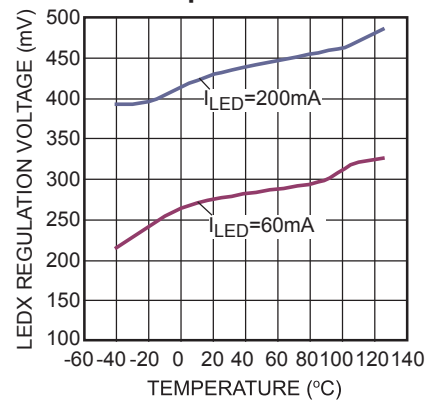
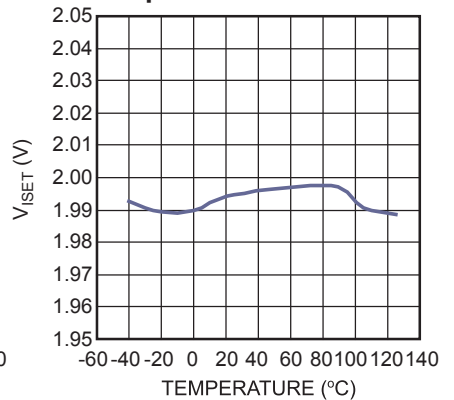
TYPICAL CHARACTERISTICS
 I_Q vs. Temperature
 $V_{IN}=12V$, No Switching

 V_{CC} UVLO vs. Temperature

OVP Threshold vs. Temperature

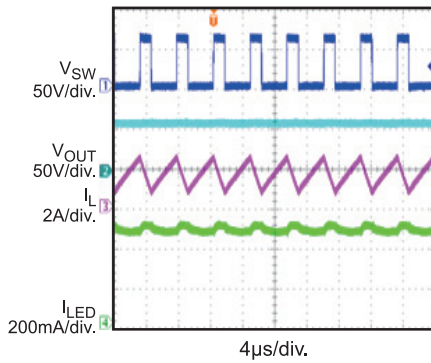
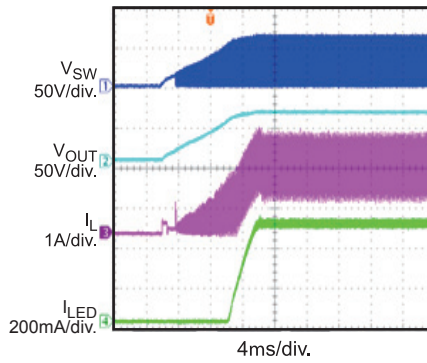
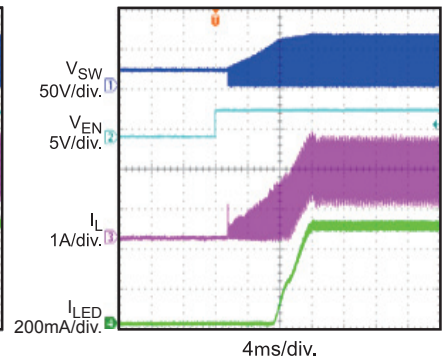
 I_{LED} Average vs. Temperature
 $R_{ISET}=100.8k\Omega$

 I_{LED} Matching vs. Temperature

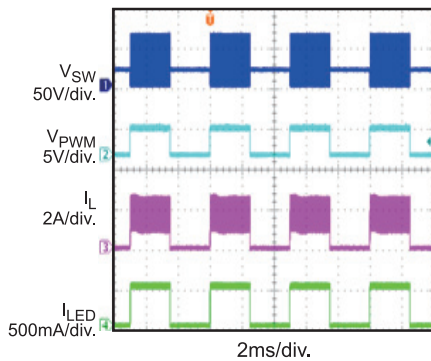
SW Frequency vs. Temperature
 $R_{OSC}=100k\Omega$

 V_{ISENSE_LIMIT} vs. Temperature

LEDX Regulation Voltage vs. Temperature

 V_{ISET} Matching vs. Temperature

TYPICAL PERFORMANCE CHARACTERISTICS

$V_{IN} = 19V$, $V_{EN} = 3.3V$, 120mA/string, 4 strings, 20 LEDs in series, $T_A = 25^\circ C$, unless otherwise noted.

Steady State

 V_{IN} Power On

EN On

PWM Dimming

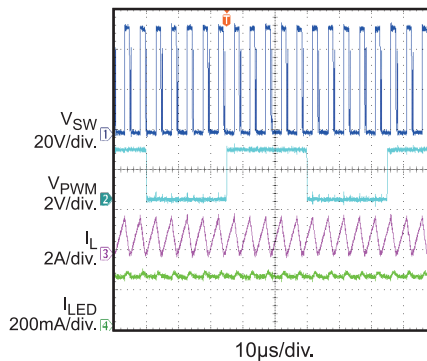
$f_{SW}=200Hz$, $D_{PWM}=50\%$

Analog Dimming

$f_{PWM}=20kHz$, $D_{PWM}=50\%$

Open LED Protection

Open One LED String at Working

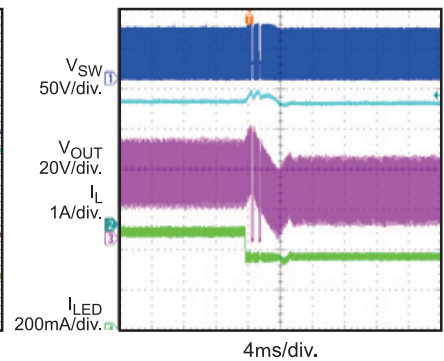
Short LED Protection

Short One LED String at Working

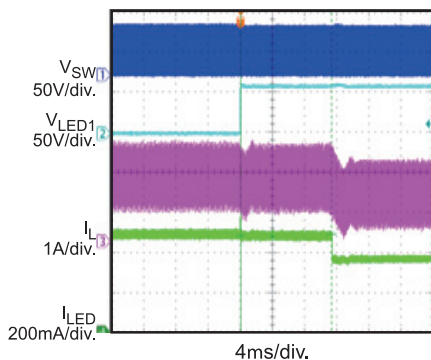

Short-Inductor Protection

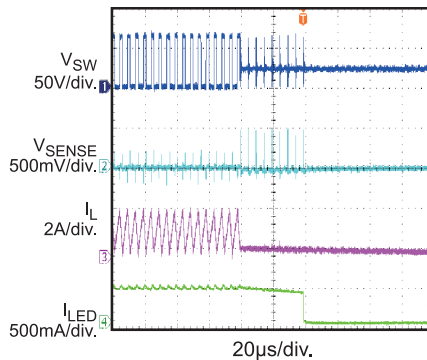
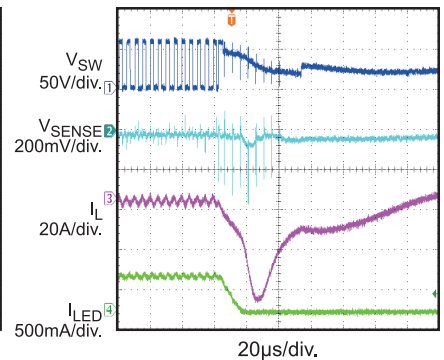
$V_{IN}=19V$, 20S4P, 120mA/string

Short-Diode Protection

PIN FUNCTIONS

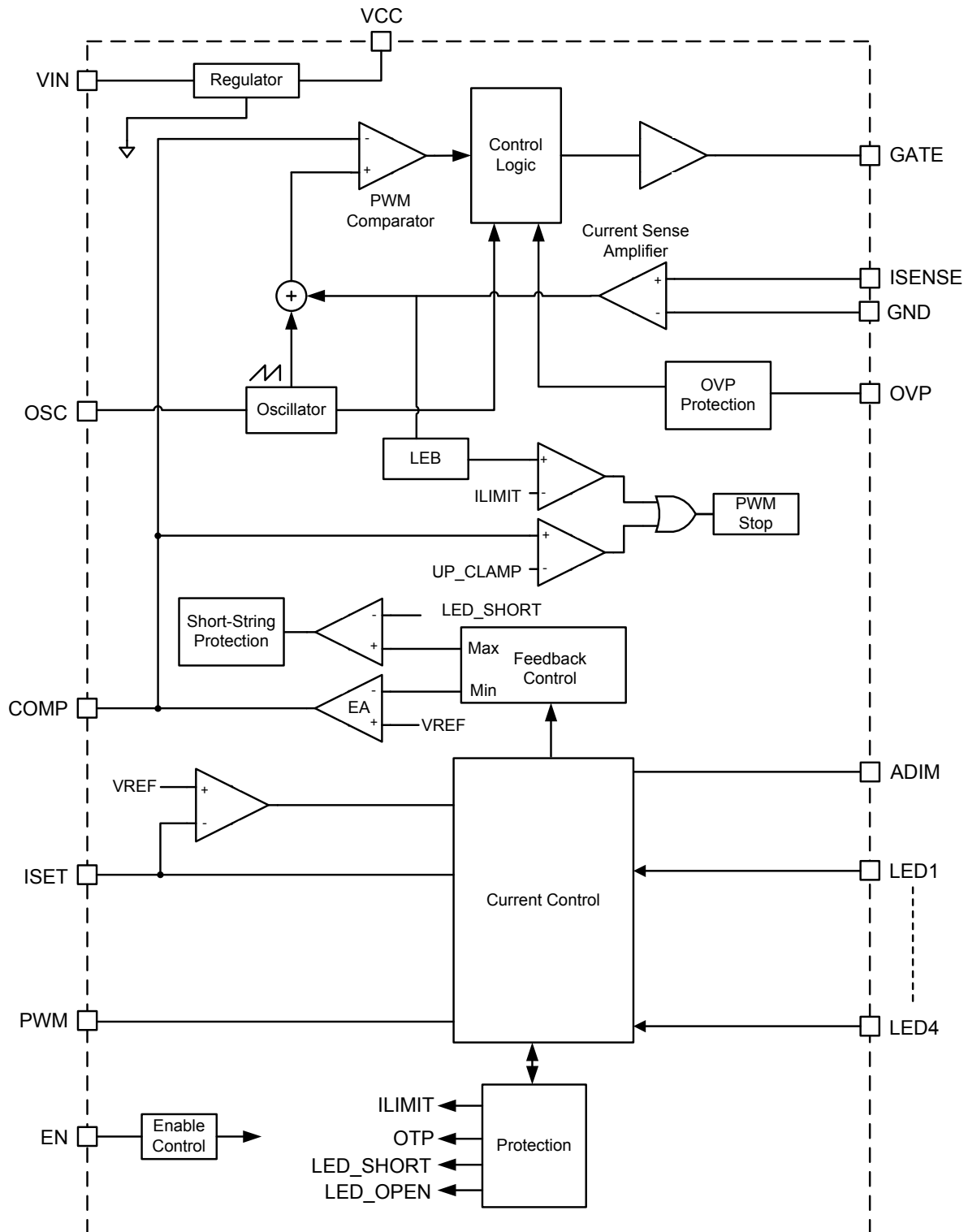
TSSOP-16 Pin #	PDIP-16/ SOIC-16 Pin #	Name	Description
1	13	LED1	LED string 1 current input. LED1 is the open-drain output of an internal dimming control switch. Connect the LED string 1 cathode to LED1.
2	14	LED2	LED string 2 current input. LED2 is the open-drain output of an internal dimming control switch. Connect the LED string 2 cathode to LED2.
3	15	GND	Ground.
4	16	LED3	LED string 3 current input. LED3 is the open-drain output of an internal dimming control switch. Connect the LED string 3 cathode to LED3.
5	1	LED4	LED string 4 current input. LED4 is the open-drain output of an internal dimming control switch. Connect the LED string 4 cathode to LED4.
6	2	ISET	LED current set. Tie a current-setting resistor from ISET to ground to program the current in each LED string.
7	3	OVP	Output over-voltage protection. Connect a resistor divider from output to OVP to program the OVP threshold.
8	4	OSC	Switching frequency set. Connect a resistor between OSC and GND to set the step-up converter switching frequency. The clock frequency is proportional to the current source from OSC.
9	5	EN	Enable control input. A voltage greater than 1.5V turns the part on; a voltage less than 0.6V turns the part off. Do not float EN.
10	6	ISENSE	Current sense input. During normal operation, ISENSE senses the voltage across the external inductor current-sensing resistor (R_{SENSE}) for peak-current-mode control. ISENSE also limits the inductor current during every switching cycle. For cascading applications, tie ISENSE of the slave IC to GND. Do not float ISENSE.
11	7	GATE	Step-up converter power switch driver output. GATE drives the external power N-channel MOSFET device.
12	8	VCC	The internal 5.9V linear regulator output. VCC provides the power supply for the external MOSFET switch gate driver and the internal control circuitry. Bypass VCC to GND with a ceramic capacitor.
13	9	VIN	Supply input. VIN must be bypassed locally.
14	10	ADIM	Input for analog brightness control. The LED current amplitude is determined by the duty cycle of the PWM signal applied to ADIM. An internal R-C filter (10M Ω resistor and 100pF capacitor) is integrated into ADIM. A frequency greater than 20kHz is recommended to achieve a better PWM signal filtering performance and ensure that the high-level voltage of V_{ADIM} is above 1.5V and the low-level voltage is below 0.4V. If Analog dimming is not required, pulling this pin to high voltage ($1.5V < V_{ADIM} \leq 5V$).
15	11	COMP	Step-up converter compensation. COMP compensates for the regulation control loop. Connect a ceramic capacitor or a resistor and capacitor from COMP to GND.
16	12	PWM	Input signal for PWM brightness control. By applying a PWM signal on PWM, the LED current is chopped, and the average current is equal to $ISET \times D_{DIM}$, where ISET is the LED current value set by a resistor between ISET and GND, and D_{DIM} is the duty cycle of the PWM dimming duty cycle. Ensure that the high level voltage is above 1.5V and the low-level voltage is below 0.4V. If PWM is floating, weakly pull it to GND internally. If PWM dimming is not required, pulling this pin to high voltage ($1.5V < V_{PWM} \leq 5V$).

BLOCK DIAGRAM

Figure 1: Functional Block Diagram

OPERATION

The MP3398E is a programmable constant frequency, peak-current mode, step-up converter with 4-channel regulated current sources to drive an array of up to four strings of white LEDs.

Internal 5.9V Regulator

The MP3398E includes an internal linear regulator (VCC). When VIN is greater than 6.5V, this regulator outputs a 5.9V power supply to the external MOSFET switch gate driver and the internal control circuitry. The VCC voltage drops to 0V when the chip shuts down. The MP3398E features under-voltage lockout (UVLO). The chip is disabled until VCC exceeds the UVLO threshold. The UVLO hysteresis is approximately 350mV.

System Start-Up

When enabled, the MP3398E checks the topology connection first. The chip monitors the over-voltage protection (OVP) pin to determine if the Schottky diode is connected or if the boost output is shorted to GND. An OVP voltage higher than 55mV allows the chip to switch normally; otherwise, switching is disabled. The MP3398E also checks other safety limits, including UVLO, over-temperature protection (OTP), and over-current protection (OCP) after passing the OVP test. If all protection tests pass, the chip then begins boosting the step-up converter with an internal soft start.

It is recommended that the enable signal occur after the establishment of the input voltage and PWM dimming signal during the start-up sequence to prevent a large inrush current.

Step-Up Converter

At the beginning of each switching cycle, the internal clock turns on the external MOSFET. During normal operation, the minimum turn-on time is around 150ns. A stabilizing ramp added to the output of the current sense amplifier prevents subharmonic oscillations for duty cycles greater than 50%. This result is fed into the PWM comparator. When the summed voltage reaches the output voltage of the error amplifier (V_{COMP}), the external MOSFET turns off.

The output voltage of the internal error amplifier is an amplified signal of the difference between the reference voltage and the feedback voltage. The converter chooses the lowest active LEDX pin voltage automatically to provide a high enough bus voltage to power all of the LED arrays.

If the feedback voltage drops below the reference, the output of the error amplifier increases. This results in more current flowing through the MOSFET, increasing the power delivered to the output and forming a closed loop that regulates the output voltage.

Under light-load operation, especially in the case of $V_{OUT} \approx V_{IN}$, the converter runs in pulse-skipping mode. In this mode, the MOSFET turns on for a minimum on time, and then the converter discharges the power to the output for the remaining period. The external MOSFET remains off until the output voltage needs to be boosted again.

Dimming Control

The MP3398E provides two dimming methods: PWM and analog dimming mode.

For PWM dimming, apply a PWM signal to PWM. The LED current is chopped by this PWM signal, and the average LED current is equal to $I_{SET} \times D_{DIM}$, where D_{DIM} is the duty cycle of the PWM dimming signal, and I_{SET} is the LED current amplitude.

For analog dimming, apply a PWM signal to ADIM. An internal R-C filter (10M Ω resistor and 100pF capacitor) is integrated to ADIM. This PWM signal is filtered to the DC voltage by the internal R-C filter. The LED current amplitude is equal to $I_{SET} \times D_{DIM}$, where D_{DIM} is the duty cycle of the PWM dimming signal, and I_{SET} is the LED current amplitude. A PWM signal 20kHz or higher is recommended for better filtering.

Operation Switching Frequency

The converter operating frequency is set through an external resistor on OSC. This helps optimize both the size of the external components and the system efficiency.

Open-String Protection

Open-string protection is achieved through detecting the voltage of OVP and LED (1 to 4). If one or more strings are open, the respective LEDX pins are pulled to ground, and the IC continues charging the output voltage until it reaches the over-voltage protection (OVP) threshold. If the OVP point has been triggered, the chip stops switching and marks off the strings that have an LEDX pin voltage lower than 200mV. Once marked, the remaining LED strings force the output voltage back into tight regulation. The string with the largest voltage drop determines the output regulation.

The MP3398E always attempts to light at least one string. If all strings are open, the MP3398E shuts down the step-up converter. The strings remain in this marked state until the chip resets.

Short-String Protection

The MP3398E monitors the LEDX pin voltages to determine if a short-string fault has occurred. If one or more strings are shorted, the respective LEDX pins tolerate high-voltage stress. If an LEDX pin voltage is higher than the protection threshold, this condition triggers the detection of a short-string fault. When a short-string fault remains for 10ms, the fault string is marked off and disabled. Once a string is marked off, it disconnects from the output voltage loop until VIN or EN restarts.

To prevent mistriggering a short LED protection when the LED string is open, the short LED protection function is disabled when V_{LEDX} of all used LED channels is higher than 2.1V.

Cycle-by-Cycle Current Limit

To prevent the external components from exceeding their current stress ratings, the IC employs cycle-by-cycle current-limit protection. When the current exceeds the current limit value, the IC latches off until the power resets.

Short Inductor/Diode Protection

When the external inductor or diode is shorted, the IC provides protection by detecting the current flowing through the power MOSFET. When the current sense voltage across the sense resistor (connected between ISENSE and GND) reaches the current protection threshold and lasts for eight switching cycles, the IC stops switching and latches.

Thermal Shutdown

To prevent the IC from operating at exceedingly high temperatures, thermal shutdown is implemented by monitoring the silicon die temperature. When the die temperature exceeds the threshold (T_{ST}), the IC latches off until the power resets.

APPLICATION INFORMATION

Selecting the Switching Frequency

The switching frequency of the step-up converter is recommended to be between 100kHz and 900kHz for most applications. A resistor on OSC sets the internal oscillator frequency for the step-up converter according to Equation (1):

$$F_{sw}(\text{kHz}) = \frac{38200}{R_{osc}(\text{k}\Omega)} \quad (1)$$

For $R_{osc} = 100\text{k}\Omega$, the switching frequency is set to 382kHz.

Setting the LED Current

The current in each LED string can be set through the current setting resistor on ISET and can be calculated with Equation (2):

$$I_{LED}(\text{mA}) = \frac{20362}{R_{ISET}(\text{k}\Omega)} \quad (2)$$

For $R_{ISET} = 100.8\text{k}\Omega$, the LED current is set to 202mA. Do not leave ISET open.

Selecting the Input Capacitor

The input capacitor reduces the surge current drawn from the input supply and the switching noise from the device. The input capacitor impedance at the switching frequency should be less than the input source impedance to prevent the high-frequency switching current from passing through to the input. Ceramic capacitors with X5R or X7R dielectrics are recommended for their low ESR and small temperature coefficients. For most applications, use a $4.7\mu\text{F}$ ceramic capacitor in parallel with a $220\mu\text{F}$ electrolytic capacitor.

Selecting the Inductor and Current-Sensing Resistor

A larger value inductor results in less ripple current and lower peak inductor current, which reduces stress on the N-channel MOSFET. However, the larger value inductor has a larger physical size, a higher series resistance, and a lower saturation current. Choose an inductor that will not saturate under the worst-case load conditions. Select the minimum inductor value to ensure that the boost converter works in continuous conduction mode with high efficiency and good EMI performance.

Calculate the required inductance value using Equation (3) and Equation (4):

$$L \geq \frac{\eta \times V_{OUT} \times D \times (1-D)^2}{2 \times f_{sw} \times I_{LOAD}} \quad (3)$$

$$D = 1 - \frac{V_{IN}}{V_{OUT}} \quad (4)$$

Where V_{IN} and V_{OUT} are the input and output voltages, f_{sw} is the switching frequency, I_{LOAD} is the LED load current, and η is the efficiency.

The switching current is used for peak-current-mode control. To avoid reaching the current limit, the voltage across the sensing resistor (R_{SENSE}) must be less than 80% of the current limit voltage (V_{SENSE}) in the worst-case scenario. Calculate R_{SENSE} and $I_{L(PEAK)}$ with Equation (5) and Equation (6):

$$R_{SENSE} = \frac{0.8 \times V_{SENSE}}{I_{L(PEAK)}} \quad (5)$$

$$I_{L(PEAK)} = \frac{V_{OUT} \times I_{LOAD}}{\eta V_{IN}} + \frac{V_{IN} \times (V_{OUT} - V_{IN})}{2 \times L \times F_{sw} \times V_{OUT}} \quad (6)$$

Selecting the Power MOSFET

The MP3398E is capable of driving a wide variety of N-channel power MOSFETS. The critical parameters of selection for a MOSFET are maximum drain-to-source voltage ($V_{DS(MAX)}$), maximum current ($I_{D(MAX)}$), on resistance ($R_{DS(ON)}$), gate source charge (Q_{GS}) and gate drain charge (Q_{GD}), and total gate charge (Q_G).

Ideally, the off-state voltage across the MOSFET is equal to the output voltage. Considering the voltage spike when it turns off, $V_{DS(MAX)}$ should be greater than 1.5 times the output voltage.

The maximum current through the power MOSFET occurs at the minimum input voltage and the maximum output power. The maximum RMS current through the MOSFET is given using Equation (7) and Equation (8):

$$I_{RMS(MAX)} = I_{IN(MAX)} \times \sqrt{D_{MAX}} \quad (7)$$

$$D_{MAX} \approx \frac{V_{OUT} - V_{IN(MIN)}}{V_{OUT}} \quad (8)$$

The current rating of the MOSFET should be greater than $1.5 \times I_{RMS}$.

The on resistance of the MOSFET determines the conduction loss, which is given by Equation (9):

$$P_{\text{cond}} = I_{\text{RMS}}^2 \times R_{\text{DS(on)}} \times k \quad (9)$$

Where k is the temperature coefficient of the MOSFET.

The switching loss is related to Q_{GD} and Q_{GS1} , which determine the commutation time. Q_{GS1} is the charge between the threshold voltage and the plateau voltage when a driver charges the gate, which can be read in the V_{GS} vs. Q_{G} chart in the MOSFET datasheet. Q_{GD} is the charge during the plateau voltage. These two parameters are needed to estimate the turn-on and turn-off losses and can be calculated with Equation (10):

$$P_{\text{SW}} = \frac{Q_{\text{GS1}} \times R_{\text{G}}}{V_{\text{DR}} - V_{\text{TH}}} \times V_{\text{DS}} \times I_{\text{IN}} \times f_{\text{SW}} + \frac{Q_{\text{GD}} \times R_{\text{G}}}{V_{\text{DR}} - V_{\text{PLT}}} \times V_{\text{DS}} \times I_{\text{IN}} \times f_{\text{SW}} \quad (10)$$

Where V_{TH} is the threshold voltage, V_{PLT} is the plateau voltage, V_{DS} is the drain-source voltage, and R_{G} is the gate resistance. R_{G} is recommended to be 10-20Ω.

Please note that calculating the switching loss is the most difficult part of loss estimation. The formula above provides a simplified equation. For more accurate estimates, the equation becomes much more complex.

The total gate charge (Q_{G}) is used to calculate the gate drive loss and can be calculated with Equation (11):

$$P_{\text{DR}} = Q_{\text{G}} \times V_{\text{DR}} \times f_{\text{SW}} \quad (11)$$

Where V_{DR} is the drive voltage.

Selecting the Output Capacitor

The output capacitor keeps the output voltage ripple small and ensures feedback loop stability. The output capacitor impedance must be low at the switching frequency. Ceramic capacitors with X7R dielectrics are recommended for their low ESR characteristics. A 4.7μF ceramic capacitor in parallel with a 22~47μF electrolytic capacitor is sufficient for most applications.

Setting the Over-Voltage Protection (OVP)

Open-string protection is achieved through the detection of the voltage on OVP. In some cases, an LED string failure results in the feedback voltage always being zero. The MP3398E continues boosting the output voltage higher and higher. If the output voltage reaches the programmed OVP threshold, the protection is triggered.

To ensure that the chip functions properly, an appropriate OVP voltage is required. The recommended OVP point is about 1.1 to 1.2 times higher than the output voltage for normal operation. The OVP voltage is set by an external resistor on OVP and can be calculated with Equation (12):

$$V_{\text{OVP}} = 2(V) \times \left(1 + \frac{R_{\text{HIGH}}}{R_{\text{LOW}}}\right) \quad (12)$$

Expanding LED Channels

The MP3398E can expand the number of LED channels by using two or three ICs in parallel. To connect two ICs for a total of eight LED strings, tie the VCC pins of the master IC and the slave IC together to power the slave IC internal logic circuitry. Tie the COMP pins of the slave IC and the master IC together to regulate the voltage of all eight LED strings. The slave IC MOSFET driving signal is not used; the boost converter can be driven by the master IC only. Do not leave the ISENSE of the slave IC floating; tie it to ground. Apply the EN and DIM signals to both ICs.

PCB Layout Guidelines

Efficient PCB layout is critical for stable operation and reducing EMI noise. For best results, follow the guidelines below:

1. Ensure that the loop among the external MOSFET, the output diode, and the output ceramic capacitor is as small and short as possible since it carries a high-frequency pulse current.
2. Separate the power ground (PGND) and signal ground (GND) to reduce noise affection.
3. Connect PGND and GND together. All logic signals refer to the signal ground.
4. Place ceramic capacitors as close to VIN and VCC as possible.

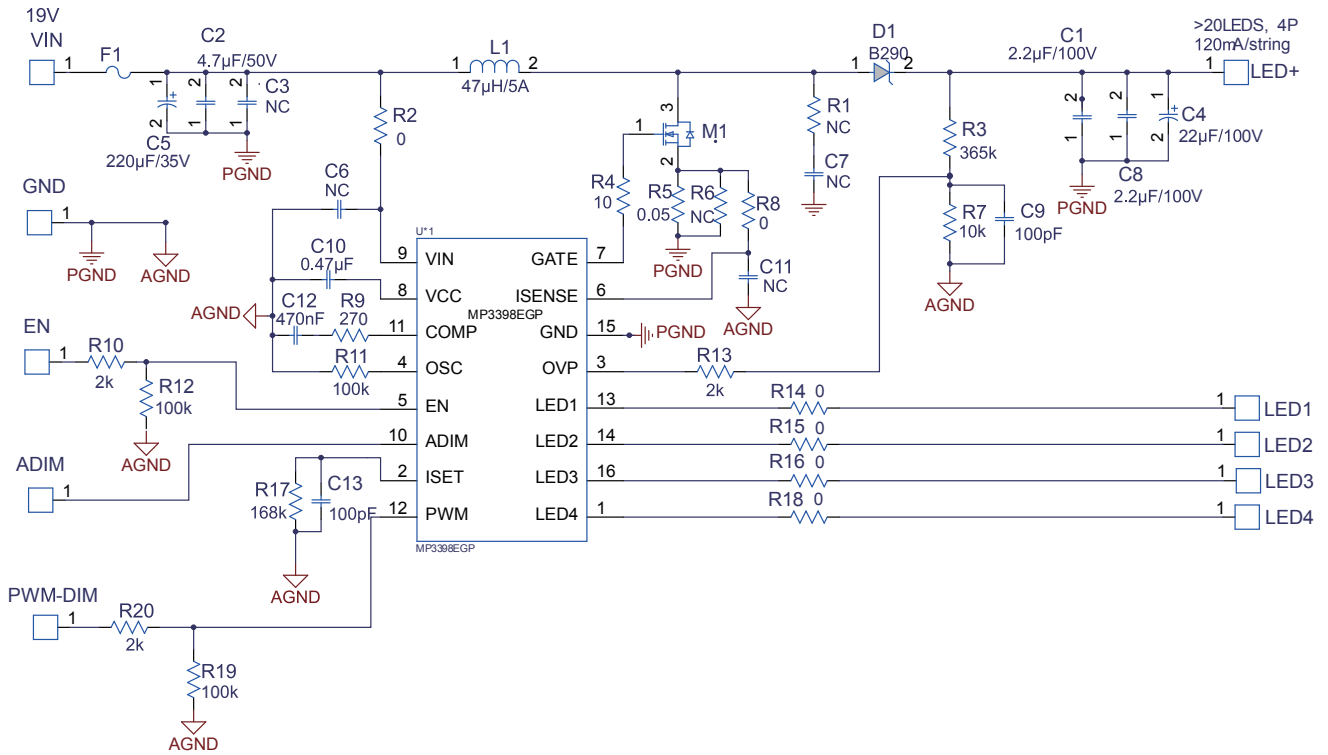
TYPICAL APPLICATION CIRCUIT

Figure 2: 4-String, 20 LEDs in Series, 120mA/String Application

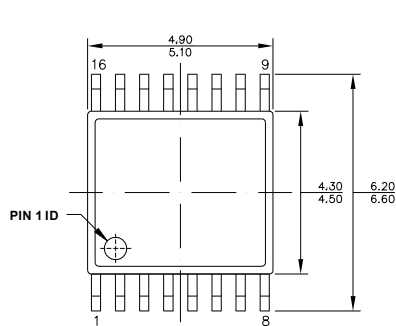
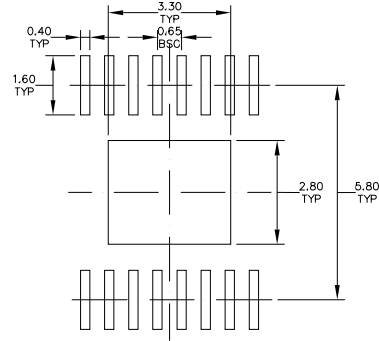
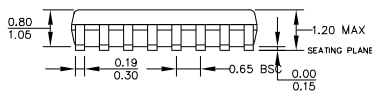
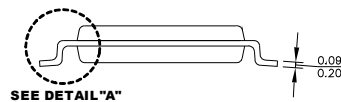
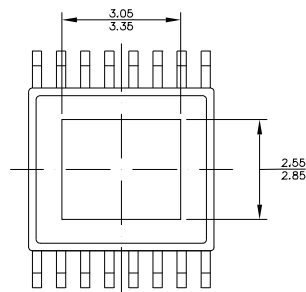
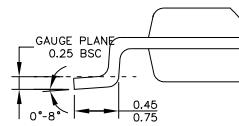
NOTE: Some components are reasonably adjustable based on real cases.

PACKAGE INFORMATION
TSSOP-16 EP

TOP VIEW

RECOMMENDED LAND PATTERN

FRONT VIEW

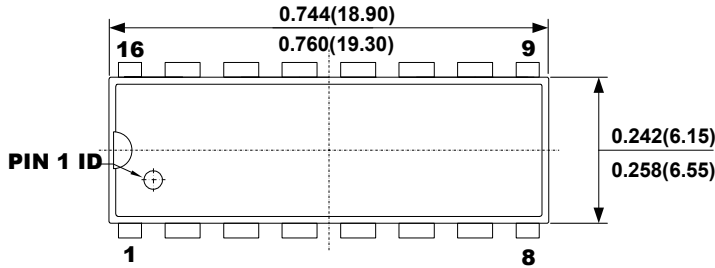
SIDE VIEW

BOTTOM VIEW

DETAIL "A"
NOTE:

- 1) ALL DIMENSIONS ARE IN MILLIMETERS
- 2) PACKAGE LENGTH DOES NOT INCLUDE MOLD FLASH, PROTRUSION OR GATE BURR.
- 3) PACKAGE WIDTH DOES NOT INCLUDE INTERLEAD FLASH OR PROTRUSION.
- 4) LEAD COPLANARITY (BOTTOM OF LEADS AFTER FORMING) SHALL BE 0.10 MILLIMETERS MAX
- 5) DRAWING CONFORMS TO JEDEC MO-153, VARIATION ABT.
- 6) DRAWING IS NOT TO SCALE

PACKAGE INFORMATION *(continued)*

PDIP-16



TOP VIEW

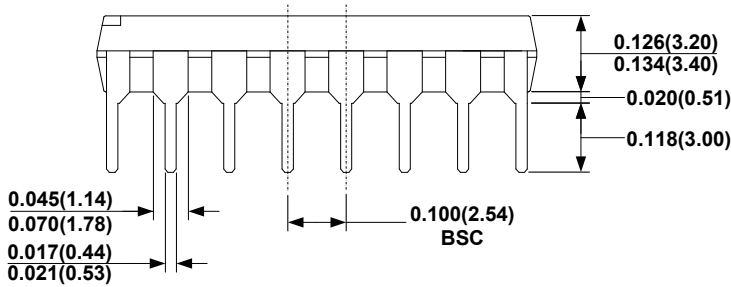

FRONT VIEW

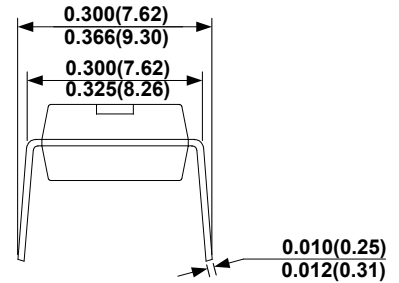

SIDE VIEW

NOTE:

- 1) CONTROL DIMENSION IS IN INCHES. DIMENSION IN BRACKET IS IN MILLIMETERS.
- 2) PACKAGE LENGTH AND WIDTH DO NOT INCLUDE MOLD FLASH, OR PROTRUSIONS.
- 3) DRAWING CONFORMS TO JEDEC MS-001.VARIATION BB.
- 4) DRAWING IS NOT TO SCALE.

PACKAGE INFORMATION

SOIC16

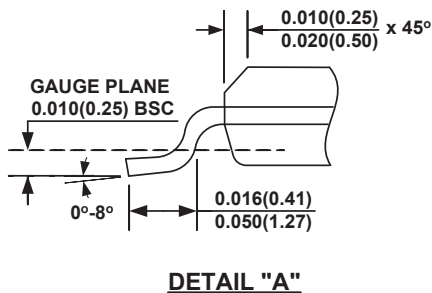
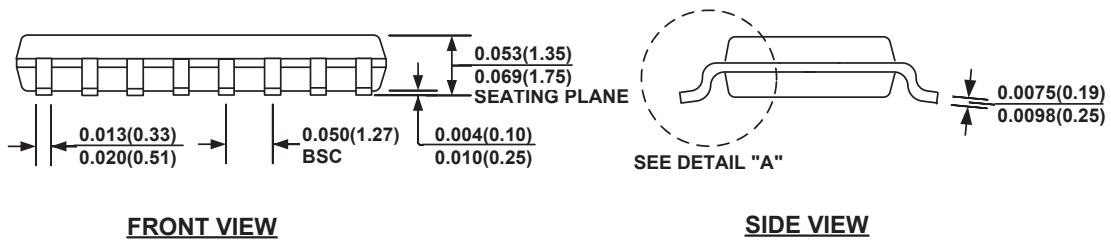
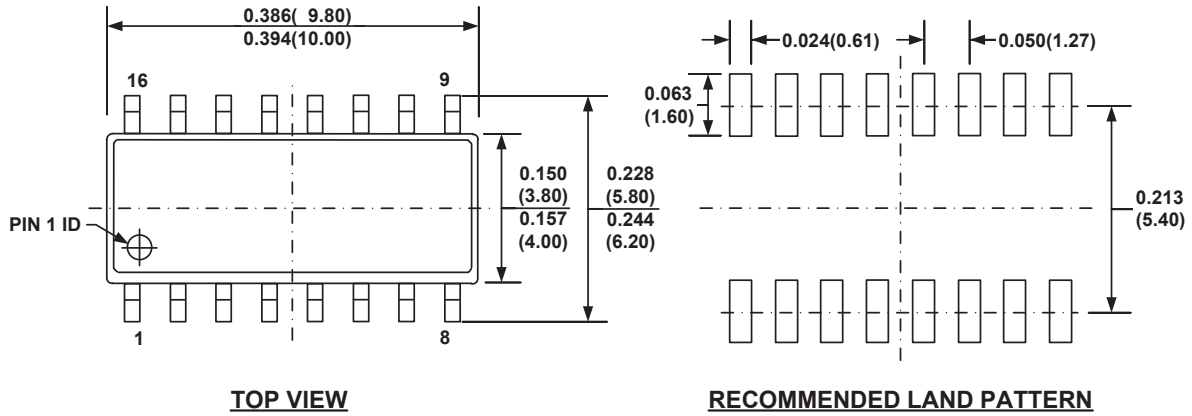

NOTE:

- 1) CONTROL DIMENSION IS IN INCHES. DIMENSION IN BRACKET IS IN MILLIMETERS.
- 2) PACKAGE LENGTH DOES NOT INCLUDE MOLD FLASH, PROTRUSIONS OR GATE BURRS.
- 3) PACKAGE WIDTH DOES NOT INCLUDE INTERLEAD FLASH OR PROTRUSIONS.
- 4) LEAD COPLANARITY (BOTTOM OF LEADS AFTER FORMING) SHALL BE 0.004" INCHES MAX.
- 5) DRAWING CONFORMS TO JEDEC MS-012, VARIATION AC.
- 6) DRAWING IS NOT TO SCALE.

Revision History

Revision #	Revision Date	Description	Pages Updated
1.05	1/26/2021	1. For the ADIM pin description, add “If Analog dimming is not required, pulling this pin to high voltage (1.5V<VADIM <=5V)” 2. For PWM pin description, add “If PWM dimming is not required, pulling this pin to high voltage (1.5V <VPWM<=5V)”	Page 9

NOTICE: The information in this document is subject to change without notice. Please contact MPS for current specifications. Users should warrant and guarantee that third party Intellectual Property rights are not infringed upon when integrating MPS products into any application. MPS will not assume any legal responsibility for any said applications.

X-ON Electronics

Largest Supplier of Electrical and Electronic Components

Click to view similar products for [LED Lighting Drivers](#) category:

Click to view products by [Monolithic Power Systems](#) manufacturer:

Other Similar products are found below :

[LV5235V-MPB-H](#) [MB39C602PNF-G-JNEFE1](#) [MIC2871YMK-T5](#) [AL1676-10BS7-13](#) [AL1676-20AS7-13](#) [AP5726WUG-7](#) [ICL8201](#)
[IS31BL3228B-UTLS2-TR](#) [IS31BL3506B-TTLS2-TR](#) [AL3157F-7](#) [AP5725FDCG-7](#) [AP5726FDCG-7](#) [LV52204MTTBG](#) [AP5725WUG-7](#)
[STP4CMPQTR](#) [NCL30086BDR2G](#) [CAT4004BHU2-GT3](#) [LV52207AXA-VH](#) [AP1694AS-13](#) [TLE4242EJ](#) [AS3688](#) [IS31LT3172-GRLS4-TR](#)
[TLD2311EL](#) [KTD2694EDQ-TR](#) [KTZ8864EJAA-TR](#) [IS32LT3174-GRLA3-TR](#) [ZXLD1374QESTTC](#) [MP2488DN-LF-Z](#) [NLM0010XTSA1](#)
[AL1676-20BS7-13](#) [ZXLD1370QESTTC](#) [MPQ7220GF-AEC1-P](#) [MPQ7220GR-AEC1-P](#) [MPQ4425BGJ-AEC1-P](#) [MPQ7220GF-AEC1-Z](#)
[MPQ7220GR-AEC1-Z](#) [MPQ4425BGJ-AEC1-Z](#) [NCL30486A2DR2G](#) [IS31FL3737B-QFLS4-TR](#) [IS31FL3239-QFLS4-TR](#) [KTD2058EUAC-](#)
[TR](#) [KTD2037EWE-TR](#) [DIO5662ST6](#) [IS31BL3508A-TTLS2-TR](#) [MAX20052CATC/V+](#) [MAX25606AUP/V+](#) [BD6586MUV-E2](#)
[BD9206EFV-E2](#) [BD9416FS-E2](#) [LYT4227E](#)