



MP4436/MP4436A

45V, 6A, Low I_Q,
Synchronous Step-Down Converter

DESCRIPTION

The MP4436/MP4436A is a synchronous, step-down switching regulator with a configurable frequency and integrated internal high-side and low-side power MOSFETs. It provides a maximum 6A of highly efficient output, as well as current mode control for a fast loop response.

The wide 3.3V to 45V input range accommodates a variety of step-down applications in an automotive input environment. A 1.7 μ A shutdown mode quiescent current allows the part to be used in battery-powered applications.

High power conversion efficiency across a wide load range is achieved by scaling down the switching frequency in light-load conditions to reduce the switching and gate driver losses.

An open-drain power good signal indicates that the output is within 93% to 106% of its nominal voltage.

Frequency foldback helps prevent inductor current runaway during start-up. Thermal shutdown provides reliable, fault-tolerant operation.

High duty cycle and low-dropout mode are provided for automotive cold crank conditions.

The MP4436/MP4436A is available in a QFN-20 (4mmx4mm) package.

FEATURES

- Wide 3.3V to 45V Operating Voltage Range
- 6A Continuous Output Current
- 1.7 μ A Low Shutdown Supply Current
- 18 μ A Sleep Mode Quiescent Current
- Internal 48m Ω High-Side and 20m Ω Low-Side MOSFET
- 350kHz to 530kHz Configurable Switching Frequency for Car Battery Applications
- Synchronize to External Clock
- Multi-Phase Capability
- Out-of-Phase Synchronized Clock Output
- MP4436A: Frequency Spread Spectrum (FSS) Option for Low EMI
- Symmetric V_{IN} for Low EMI
- Power Good Output
- External Soft Start
- 100ns Minimum On Time
- Selectable Advanced Asynchronous Mode (AAM) or Forced Continuous Conduction Mode (FCCM)
- Low-Dropout Mode
- Hiccup Mode for Over-Current Protection
- Available in a QFN-20 (4mmx4mm) Package

APPLICATIONS

- Automotive Infotainment
- Automotive Clusters
- Advanced Driver Assistance Systems (ADAS)
- Industrial Power Systems

All MPS parts are lead-free, halogen free, and adhere to the RoHS directive. For MPS green status, please visit the MPS website under Quality Assurance. "MPS", the MPS logo, and "Simple, Easy Solutions" are registered trademarks of Monolithic Power Systems, Inc. or its subsidiaries.

TYPICAL APPLICATION

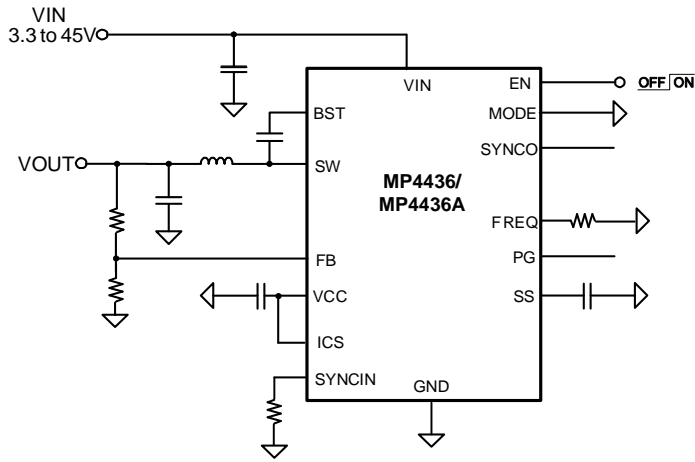

Efficiency vs. Load Current

V_{OUT} = 3.3V, f_{sw} = 470kHz, L = 3.3μH, AAM

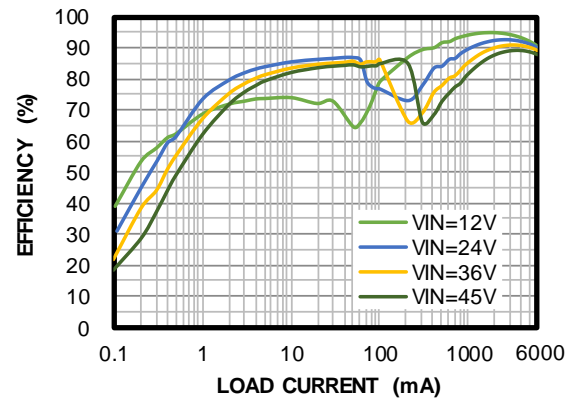

ORDERING INFORMATION

Part Number*	Package	Top Marking	MSL Rating**
MP4436GR	QFN-20 (4mmx4mm)	See Below	1
MP4436AGR	QFN-20 (4mmx4mm)	See Below	1

* For Tape & Reel, add suffix -Z (e.g. MP4436GR-Z).

**Moisture Sensitivity Level Rating.

TOP MARKING (MP4436GR and MP4436AGR)

MPSYWW
MP4436
LLLLLL

MPS: MPS prefix
 Y: Year code
 WW: Week code
 MP4436: Part number
 LLLLLL: Lot number

PACKAGE REFERENCE

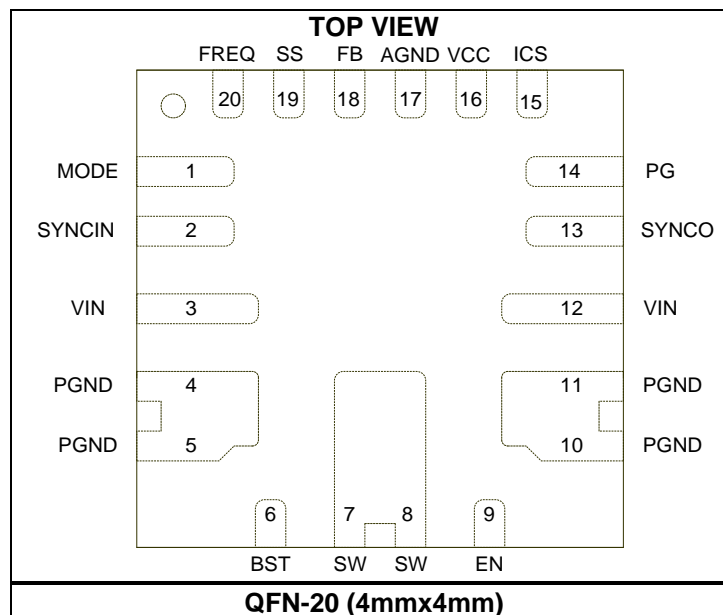

PIN FUNCTIONS

Pin #	Name	Description
1	MODE	AAM or FCCM select pin. Pull the MODE pin high to force the part into forced continuous conduction mode (FCCM). Pull MODE low for advanced asynchronous mode (AAM) under light-load conditions. Do not float MODE.
2	SYNCIN	SYNC input. Connect a 51kΩ resistor between SYNCIN and GND. Apply a 350kHz to 530kHz clock signal to this pin to synchronize the internal oscillator frequency to the external clock. This pin is also used for multi-phase operation. Connect SYNCIN to GND if it is not used. Do not float SYNCIN.
3, 12	VIN	Input supply. VIN supplies power to all the internal control circuitry and to the power switch connected to SW. To minimize switching spikes, it is recommended to place a decoupling capacitor to ground close to VIN.
4, 5, 10, 11	PGND	Power ground.
6	BST	Bootstrap. BST is the positive power supply for the high-side MOSFET driver connected to SW. Connect a bypass capacitor between BST and SW. See the Setting the BST Capacitor section on page 31 to calculate the size of this capacitor.
7, 8	SW	Switch node. SW is the output of the internal power switch.
9	EN	Enable. Pull this pin below the specified threshold (0.85V) to shut down the chip. Pull EN above the specified threshold (1V) to enable the chip.
13	SYNCO	SYNC output. Output a clock signal 180° out of phase with the internal oscillator signal or opposite to the clock signal applied at the SYNCIN pin. Float SYNCO if it is not used.
14	PG	Power good indicator. The output of PG is an open drain. If PG is used, connect a pull-up resistor to the power source. PG goes high if the output voltage is within 93% to 106% of the nominal voltage, and goes low if the output voltage is above 107.5% or below 91% of the nominal voltage.
15	ICS	Current sharing pin. In a multi-phase application, connect the ICS pins of the ICs in parallel to improve current sharing between different phases. Do not float ICS. In a single-phase application, connect ICS to the VCC or VOUT pin, and ensure that the voltage is above 3V.
16	VCC	Bias supply. VCC supplies power to the internal control circuit and gate drivers. A decoupling capacitor to ground must be placed close to this pin. See the Setting the VCC Capacitor section on page 31 to calculate the size of this capacitor.
17	AGND	Analog ground.
18	FB	Feedback input. Connect FB to the center point of the external resistor divider from the output to AGND to set the output voltage. The feedback threshold voltage is 0.815V. Place the resistor divider as close to FB as possible. Avoid placing vias on the FB traces.
19	SS	Soft start input. Place a capacitor from SS to GND to set the soft-start period. The MP4436/MP4436A sources 6μA from the SS pin to the soft-start capacitor during start-up. As the SS voltage rises, the feedback threshold voltage increases to limit inrush current during start-up.
20	FREQ	Switching frequency program. Connect a resistor from this pin to ground to set the switching frequency. To set the frequency, see the f _{SW} vs. R _{FREQ} curve in the Typical Performance Characteristics (TPC) section on page 14.

ABSOLUTE MAXIMUM RATINGS ⁽¹⁾

VIN, EN	-0.3V to +50V
SW	-0.3V to V _{IN (MAX)} + 0.3V
BST	V _{SW} + 6V
All other pins	-0.3V to +6V
Continuous power dissipation (T _A = 25°C) ⁽²⁾	
QFN-20 (4mmx4mm)	2.84W
Operating junction temperature	+150°C
Lead temperature	+260°C
Storage temperature	-65°C to +150°C

ESD Ratings

Human body model (HBM)	±2kV
Charged device model (CDM)	±750V

Recommended Operating Conditions

Supply voltage (V _{IN})	3.3V to 45V
Operating junction temp (T _J)	-40°C to +125°C ⁽³⁾

Thermal Resistance	θ_{JA}	θ_{JC}
QFN-20 (4mmx4mm)		
JESD51-7 ⁽⁴⁾	44.....	9.....°C/W
EVQ4436-R-00A ⁽⁵⁾	23.....	2.5..°C/W

Notes:

- 1) Exceeding these ratings may damage the device.
- 2) The maximum allowable power dissipation is a function of the maximum junction temperature T_{J (MAX)}, the junction-to-ambient thermal resistance θ_{JA}, and the ambient temperature T_A. The maximum allowable continuous power dissipation at any ambient temperature is calculated by P_{D (MAX)} = (T_{J (MAX)} - T_A) / θ_{JA}. Exceeding the maximum allowable power dissipation can lead to excessive die temperature, and the regulator may into thermal shutdown. Internal thermal shutdown circuitry protects the device from permanent damage.
- 3) The device may be able to support an operating junction temperature above 125°C. Contact MPS for details.
- 4) Measured on JESD51-7, 4-layer PCB.
- 5) Measured on EVQ4436-R-00A, 9cmx9cm, 4-layer PCB.

ELECTRICAL CHARACTERISTICS

V_{IN} = 12V, V_{EN} = 2V, T_J = -40°C to +125°C ⁽⁶⁾, typical values are at T_J = 25°C, unless otherwise noted.

Parameter	Symbol	Condition	Min	Typ	Max	Units
VIN UVLO rising threshold	IN _{UVLO_RISING}		2.8	3.0	3.2	V
VIN UVLO falling threshold	IN _{UVLO_FALLING}		2.45	2.65	2.85	V
VIN UVLO hysteresis	IN _{UVLO_HYS}			250		mV
VCC voltage	V _{CC}	I _{VCC} = 0A	4.6	4.9	5.2	V
VCC regulation		I _{VCC} = 30mA		1	4	%
VCC current limit	I _{LIMIT_VCC}	V _{CC} = 4V	100			mA
VIN quiescent current	I _Q	FB = 0.85V, no load (sleep mode)		18	26	μA
VIN quiescent current (switching) ⁽⁷⁾	I _{Q_ACTIVE}	MODE = GND (AAM), switching, no load, R _{FB_UP} = 1MΩ, R _{FB_DOWN} = 316kΩ		20		μA
		MODE = high (FCCM), switching, f _{SW} = 2MHz, no load		40		mA
		MODE = high (FCCM), switching, f _{SW} = 470kHz, no load		9.5		mA
VIN shutdown current	I _{SHDN}	EN = 0V		1.7	2.5	μA
FB voltage	V _{FB}	VIN = 3.3V to 45V, T _J = 25°C	0.807	0.815	0.823	V
		VIN = 3.3V to 45V	0.799	0.815	0.831	V
FB current	I _{FB}	V _{FB} = 0.85V	-50	0	+50	nA
Switching frequency	f _{SW}	R _{FREQ} = 62kΩ	420	470	520	kHz
Minimum on time ⁽⁷⁾	t _{ON_MIN}			100		ns
Minimum off time ⁽⁷⁾	t _{OFF_MIN}			80		ns
SYNCIN voltage rising threshold	V _{SYNC_RISING}		1.8			V
SYNCIN voltage falling threshold	V _{SYNC_FALLING}				0.4	V
SYNCIN clock range	f _{SYNC}	External clock	350		530	kHz
SYNCO high voltage	V _{SYNCO_HIGH}	I _{SYNCO} = -1mA	3.3	4.5		V
SYNCO low voltage	V _{SYNCO_LOW}	I _{SYNCO} = 1mA			0.4	V
SYNCO phase shift		SYNCIN or FREQ sets the switching frequency		180		deg
HS current limit	I _{LIMIT}	Duty cycle = 30%	10	13	16	A
LS valley current limit	I _{LIMIT_VALLEY}		8	10	12	A
ZCD current	I _{ZCD}	AAM	-0.15	0.1	+0.35	A
LS reverse current limit	I _{LIMIT_REVERSE}	FCCM	2	4.5	6.5	A

ELECTRICAL CHARACTERISTICS (continued)

V_{IN} = 12V, V_{EN} = 2V, T_J = -40°C to +125°C ⁽⁶⁾, typical values are at T_J = 25°C, unless otherwise noted.

Parameter	Symbol	Condition	Min	Typ	Max	Units
Switch leakage current	I _{SW_LKG}			0.01	1	μA
HS switch on resistance	R _{ON_HS}	V _{BST} - V _{SW} = 5V		48	80	mΩ
LS switch on resistance	R _{ON_LS}	V _{CC} = 5V		20	40	mΩ
Soft-start current	I _{SS}	V _{SS} = 0V	4	6	8	μA
EN rising threshold	V _{EN_RISING}		0.8	1	1.2	V
EN falling threshold	V _{EN_FALLING}		0.65	0.85	1.05	V
EN hysteresis voltage	V _{EN_HYS}			180		mV
MODE rising threshold	V _{MODE_RISING}		1.8			V
MODE falling threshold	V _{MODE_FALLING}				0.4	V
PG rising threshold (V _{FB} / V _{REF})	P _G _{RISING}	V _{FB} rising	88.5%	93%	97.5%	V _{REF}
		V _{FB} falling	101.5%	106%	110.5%	
PG falling threshold (V _{FB} / V _{REF})	P _G _{FALLING}	V _{FB} falling	86.5%	91%	95.5%	
		V _{FB} rising	103%	107.5%	112%	
PG output voltage low	V _{PG_LOW}	I _{SINK} = 1mA		0.1	0.3	V
PG rising delay	t _{PG_R_DELAY}			30		μs
PG falling delay	t _{PG_F_DELAY}			30		μs
Thermal shutdown ⁽⁷⁾	t _{SD}			170		°C
Thermal shutdown hysteresis ⁽⁷⁾	t _{SD_HYS}			20		°C

Notes:

6) Guaranteed by over-temperature correlation. Not tested in production.

7) Derived from bench characterization. Not tested in production.

TYPICAL CHARACTERISTICS

V_{IN} = 12V, T_J = -40°C to +125°C, unless otherwise noted.

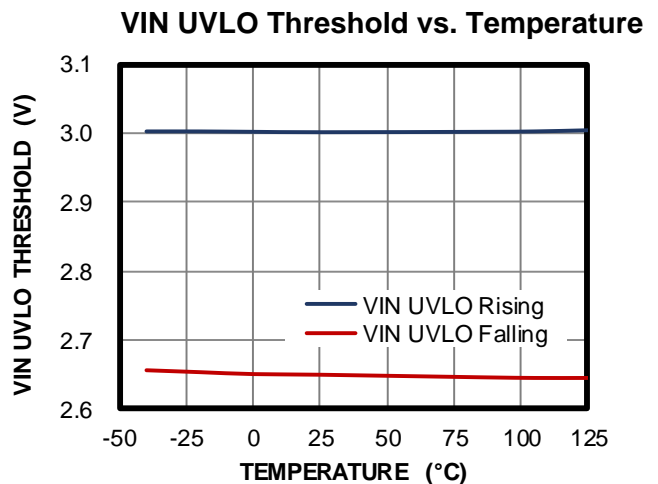
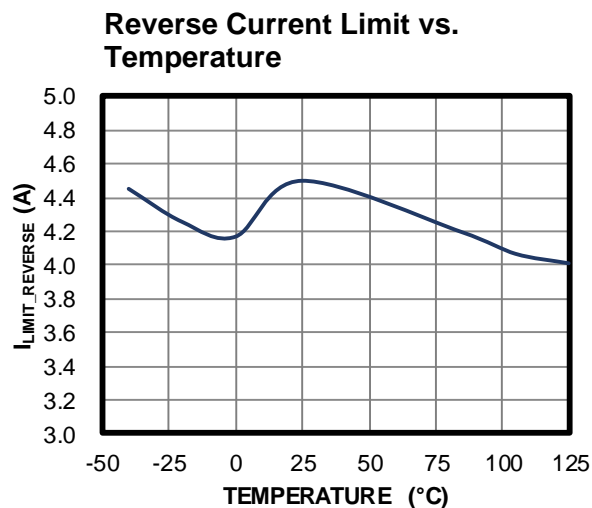
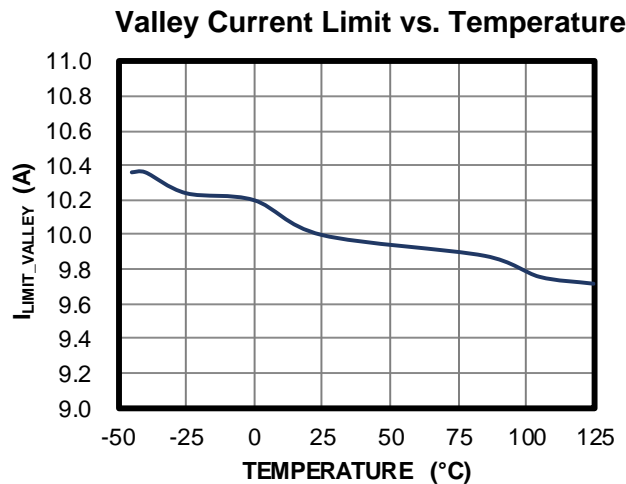
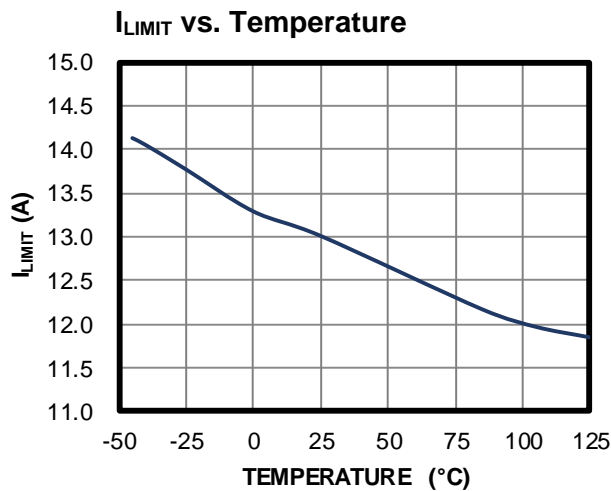
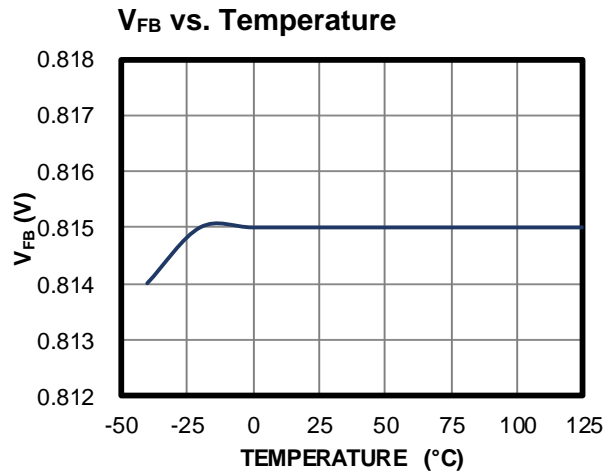
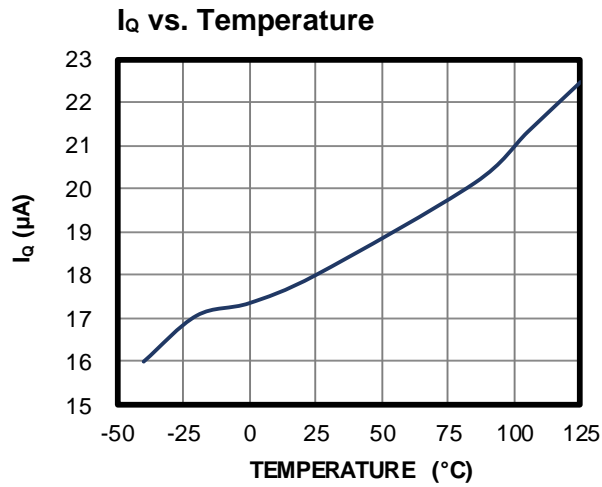

TYPICAL CHARACTERISTICS (continued)

V_{IN} = 12V, T_J = -40°C to +125°C, unless otherwise noted.

EN UVLO Threshold vs. Temperature

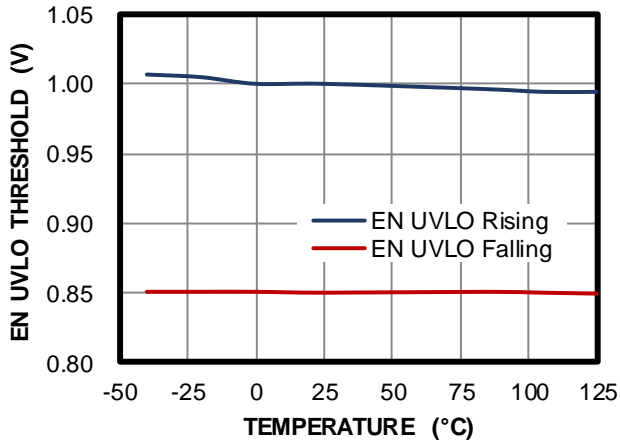

PG Rising/Falling Threshold vs. Temperature

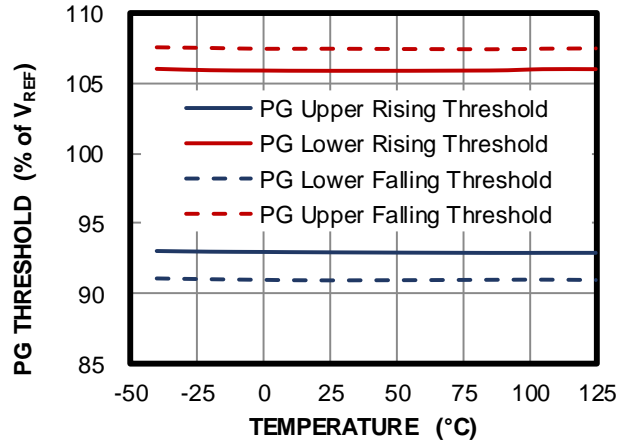

VIN Shutdown Current vs. Temperature

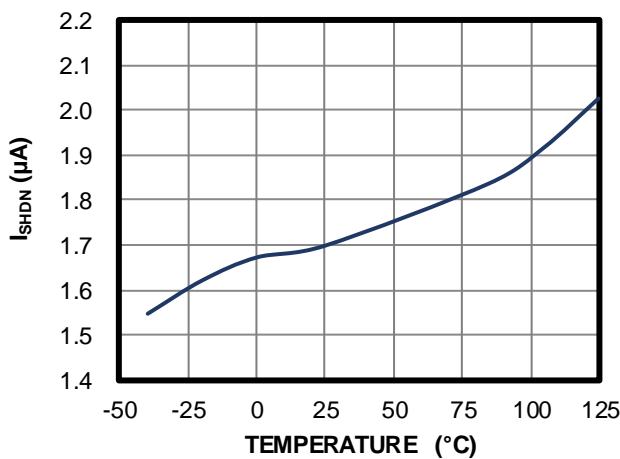

R_{HS_ON} vs. Temperature

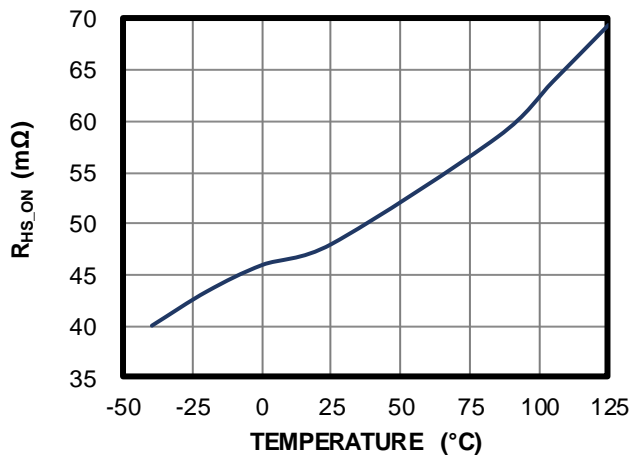

R_{LS_ON} vs. Temperature

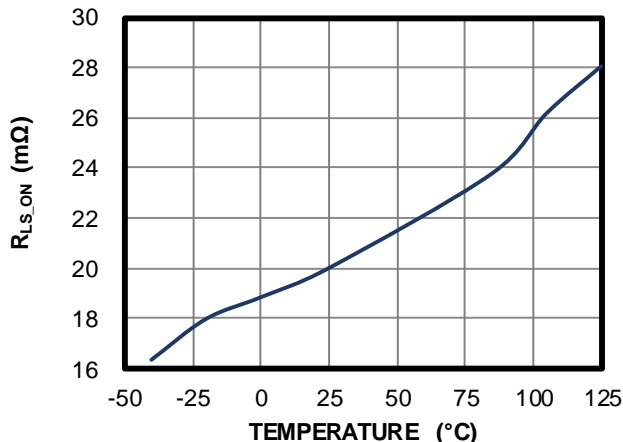

V_{CC} vs. Temperature

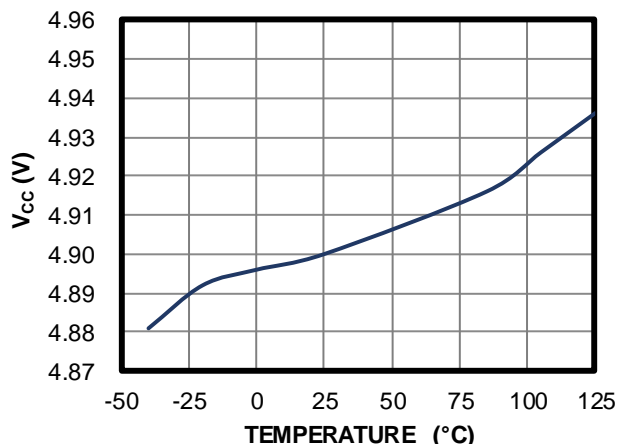

TYPICAL CHARACTERISTICS (continued)

V_{IN} = 12V, T_J = -40°C to +125°C, unless otherwise noted.

Soft-Start Current vs. Temperature

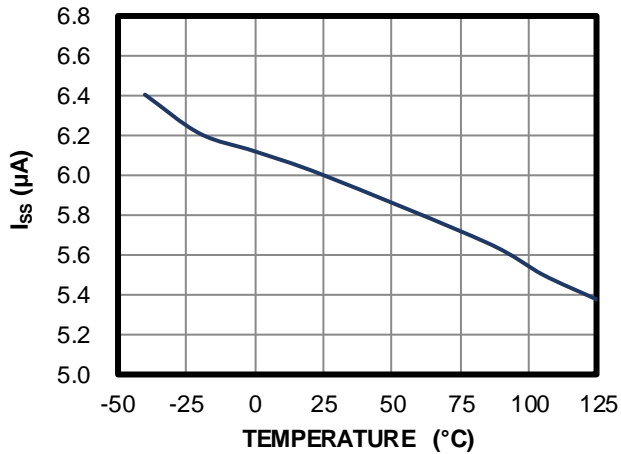

ZCD vs. Temperature

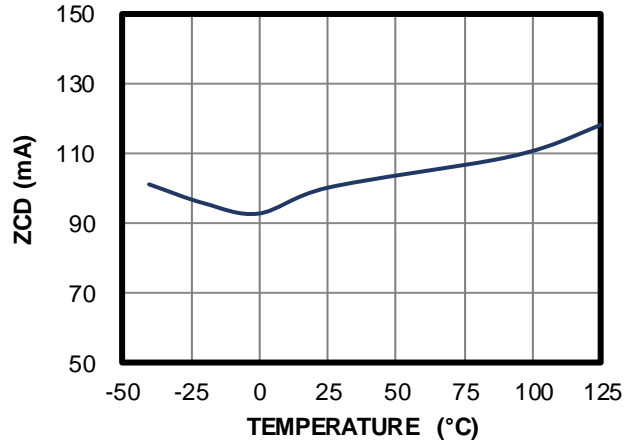

f_{sw} vs. Temperature

R_{FREQ} = 62kΩ

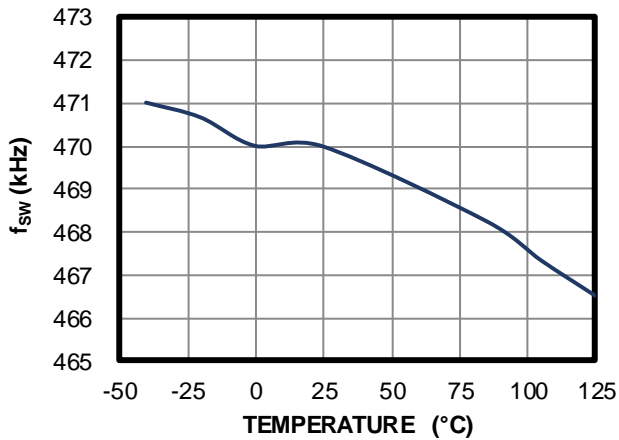

TYPICAL PERFORMANCE CHARACTERISTICS

V_{IN} = 12V, V_{OUT} = 3.3V, L = 4.7μH, f_{sw} = 470kHz, AAM, T_A = 25°C, unless otherwise noted.

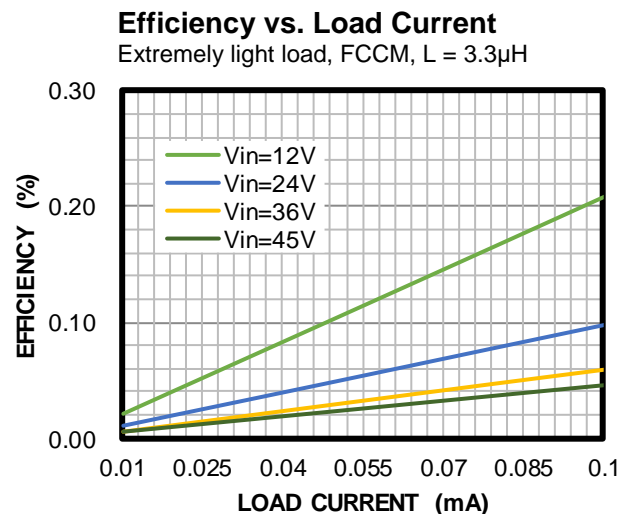
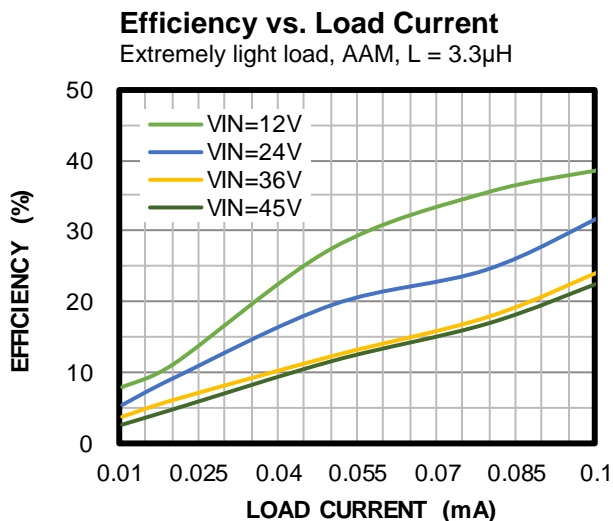
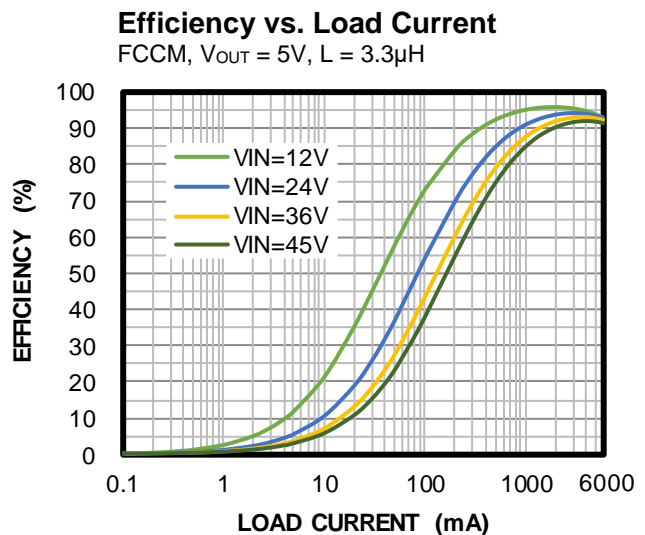
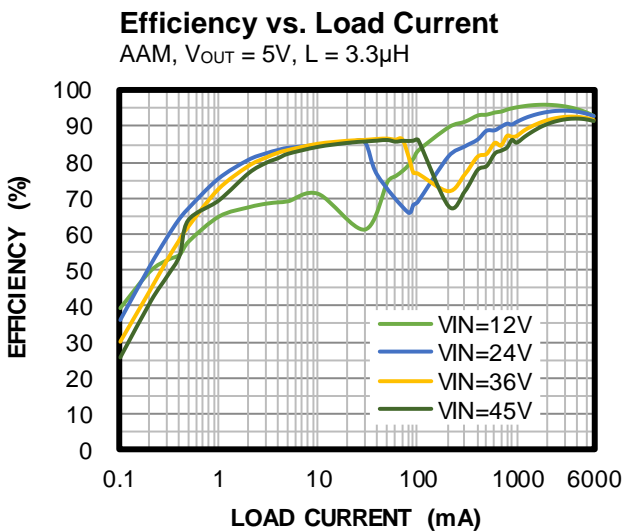
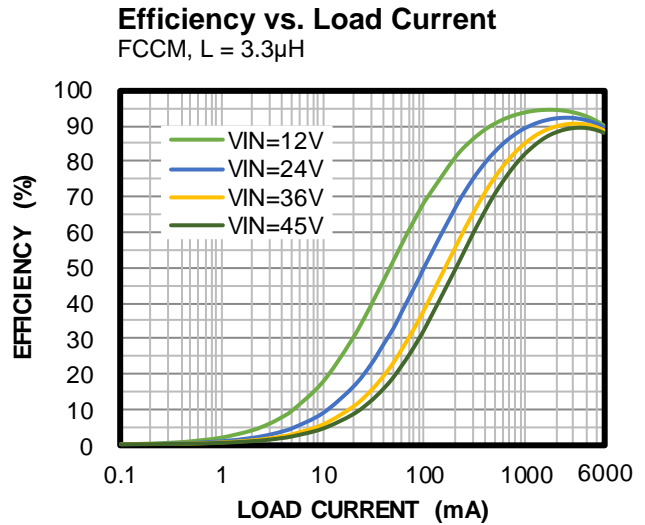
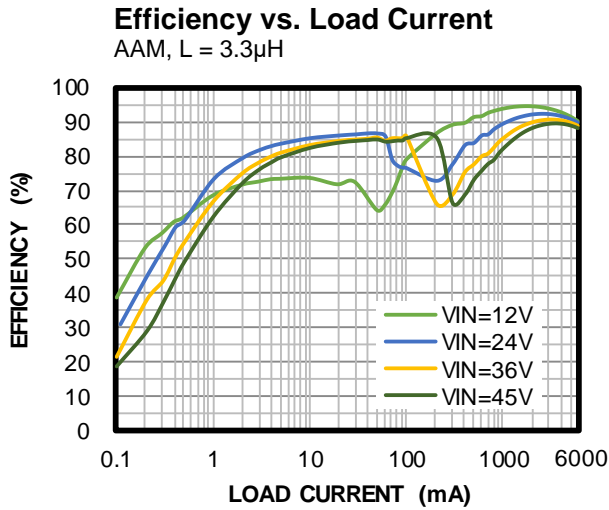

TYPICAL PERFORMANCE CHARACTERISTICS (continued)

V_{IN} = 12V, V_{OUT} = 3.3V, L = 4.7μH, f_{sw} = 470kHz, AAM, T_A = 25°C, unless otherwise noted.

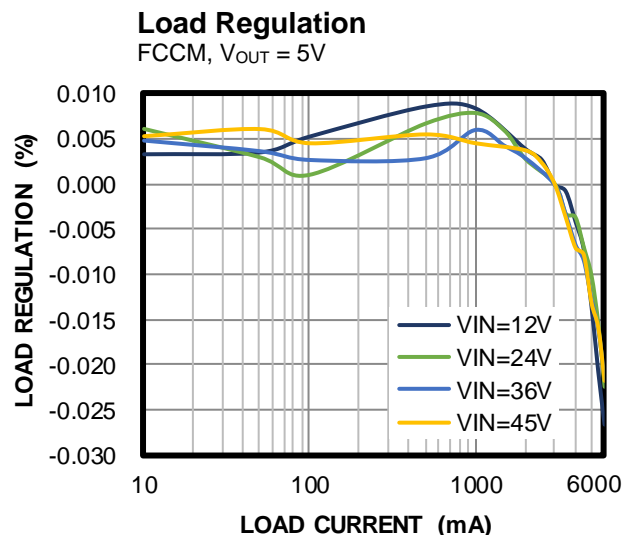
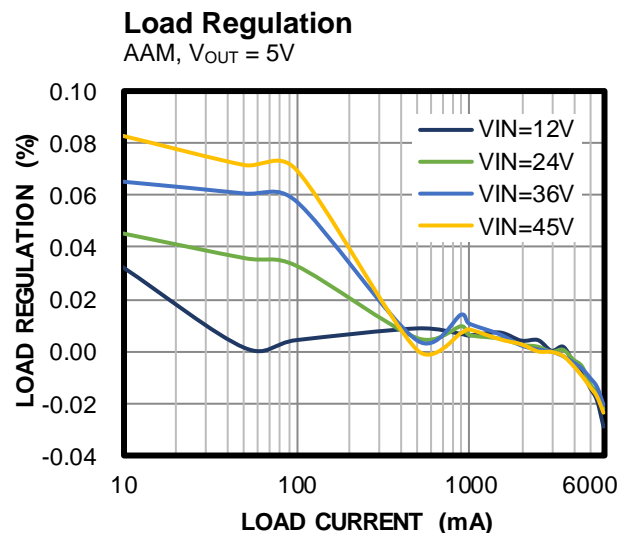
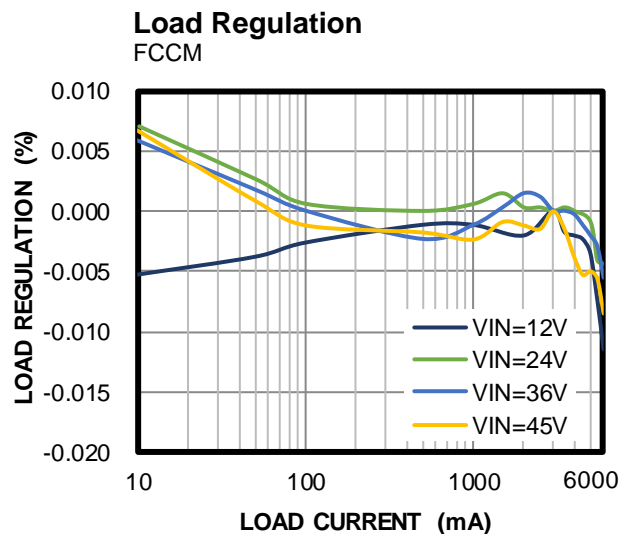
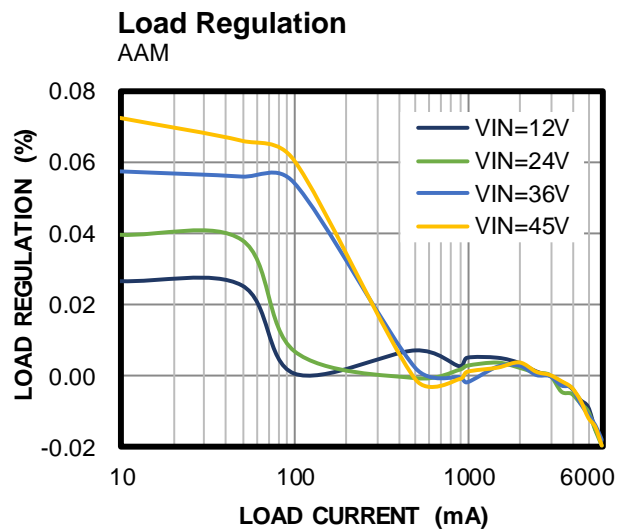
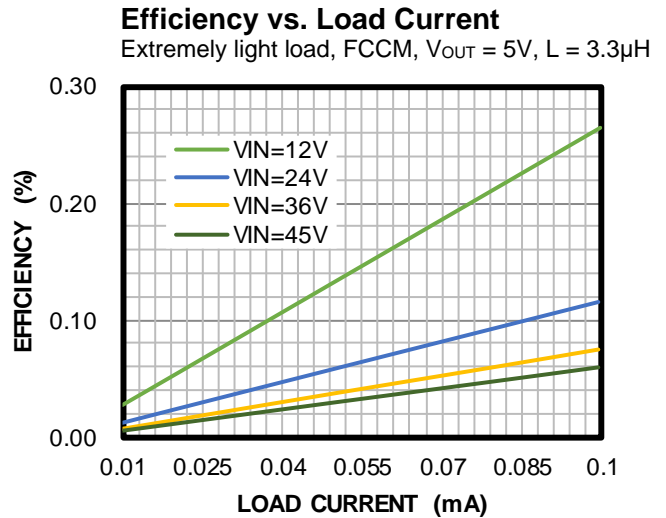
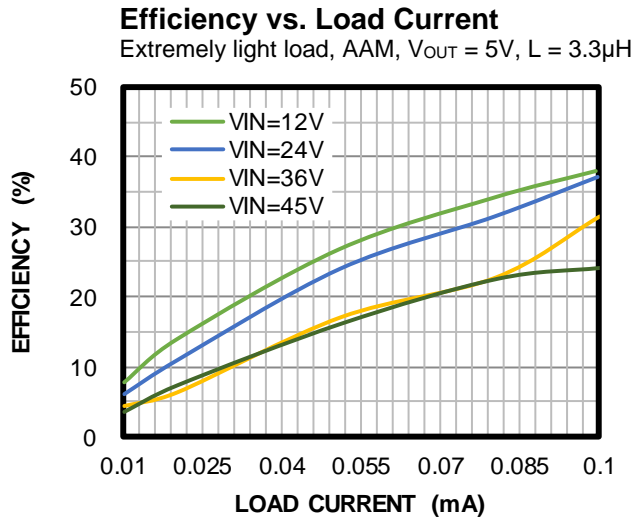

TYPICAL PERFORMANCE CHARACTERISTICS (continued)

V_{IN} = 12V, V_{OUT} = 3.3V, L = 4.7μH, f_{sw} = 470kHz, AAM, T_A = 25°C, unless otherwise noted.

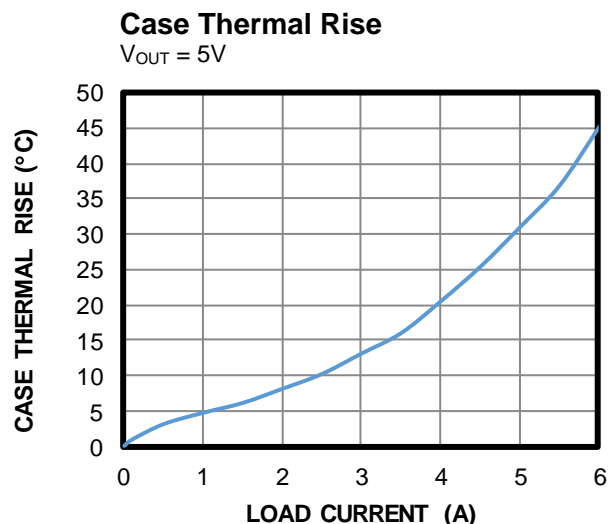
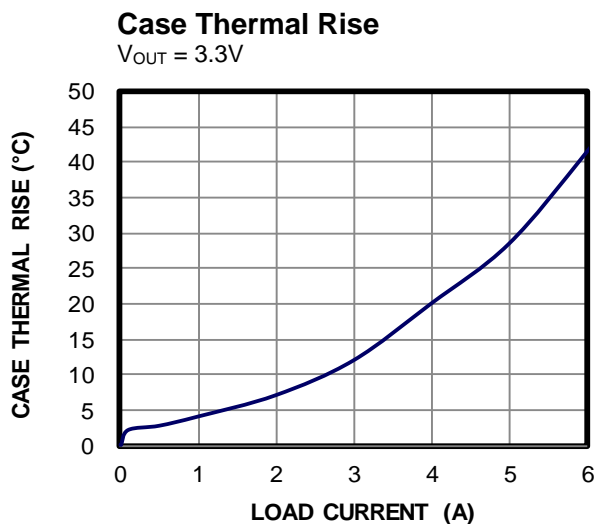
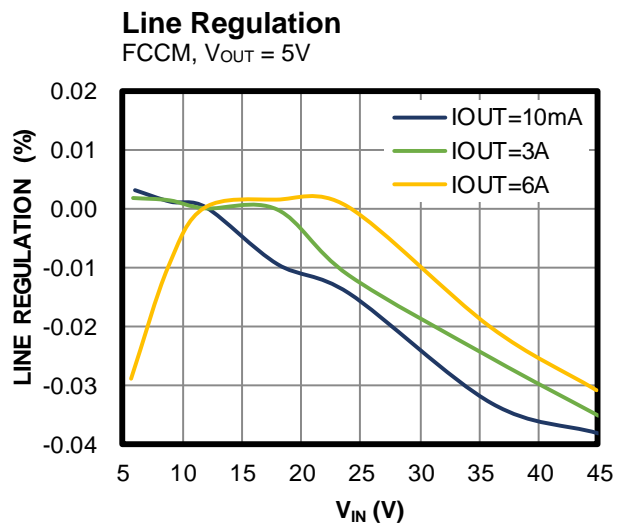
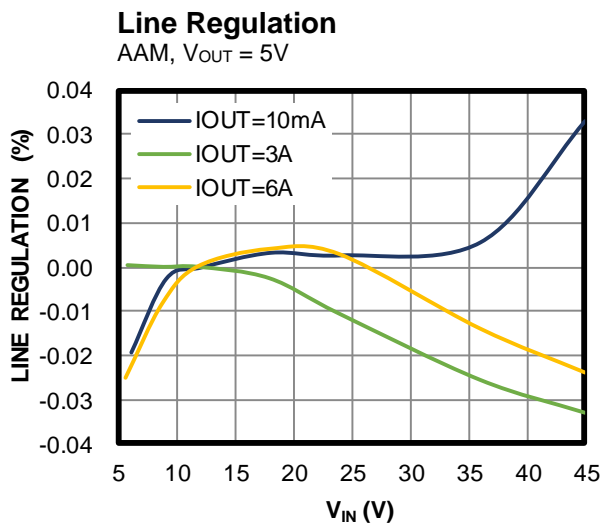
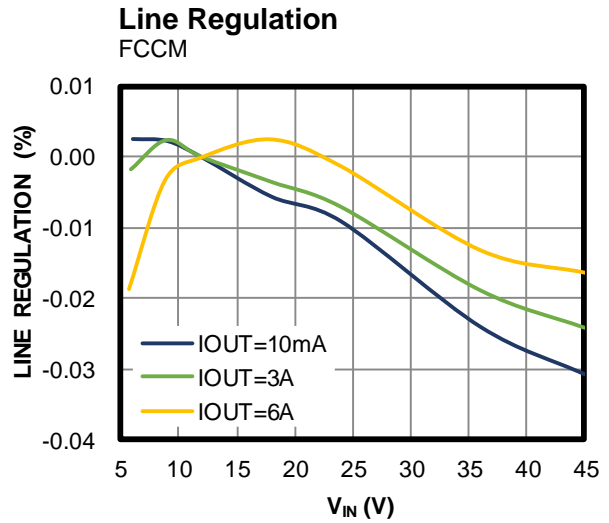
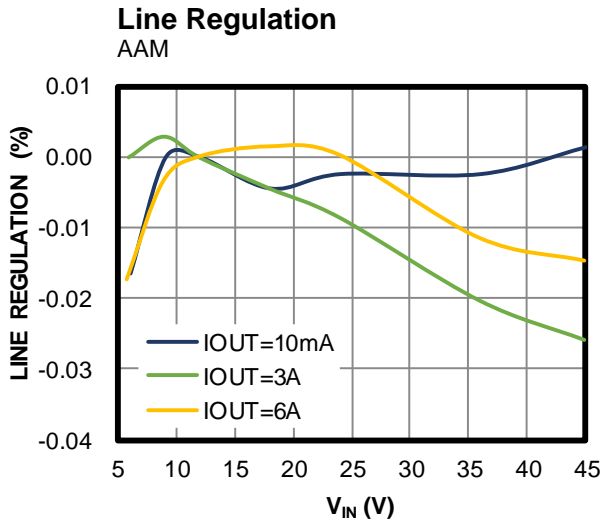

TYPICAL PERFORMANCE CHARACTERISTICS (continued)

V_{IN} = 12V, V_{OUT} = 3.3V, L = 4.7μH, f_{sw} = 470kHz, AAM, T_A = 25°C, unless otherwise noted.

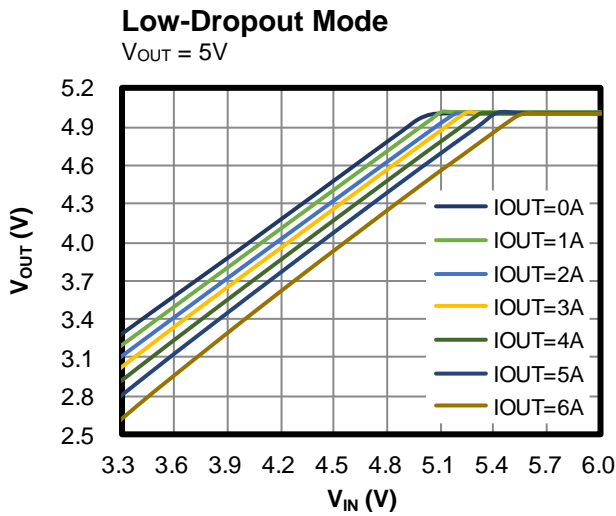
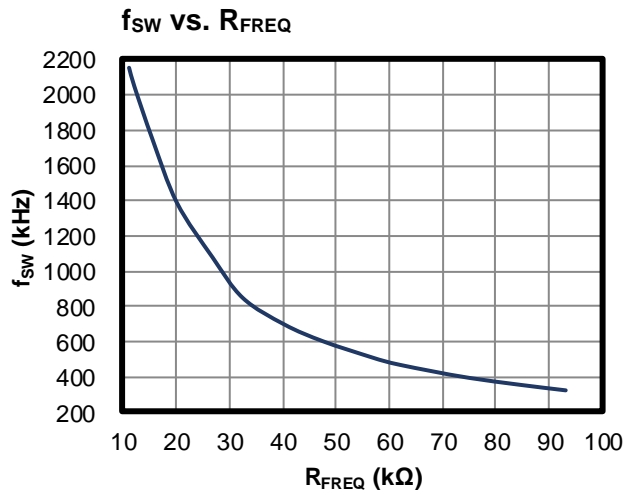
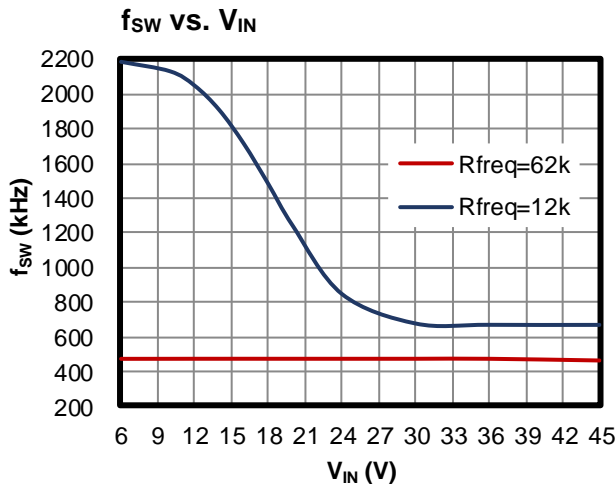

TYPICAL PERFORMANCE CHARACTERISTICS (continued)

V_{IN} = 12V, V_{OUT} = 5V, I_{OUT} = 6A, L = 4.7μH, f_{SW} = 410kHz, T_A = 25°C, with FSS (MP4436A only), unless otherwise noted. ⁽⁸⁾

CISPR25 Class 5 Peak Conducted Emissions

150kHz to 108MHz

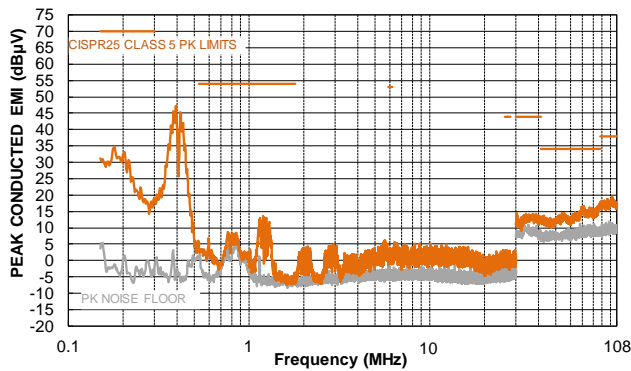

CISPR25 Class 5 Average Conducted Emissions

150kHz to 108MHz

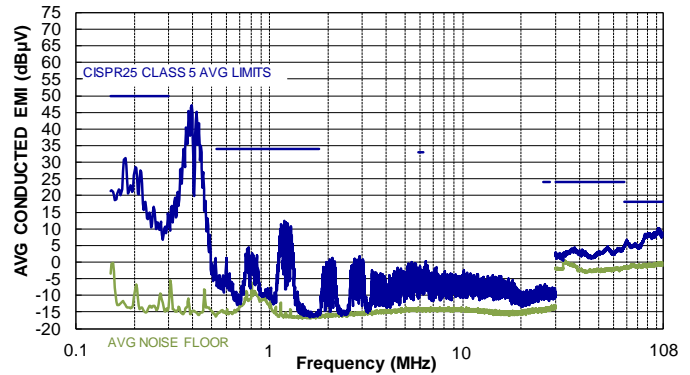

CISPR25 Class 5 Peak Radiated Emissions

150kHz to 30MHz

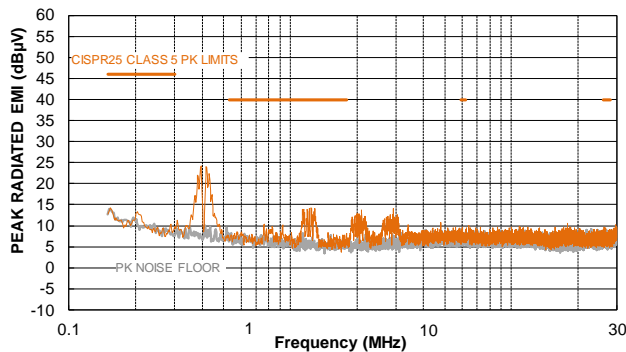

CISPR25 Class 5 Average Radiated Emissions

150kHz to 30MHz

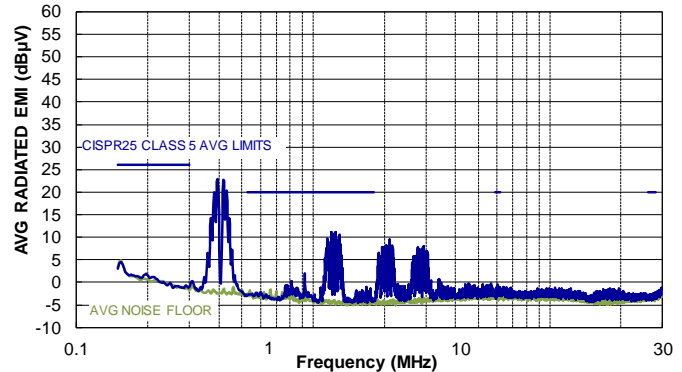

CISPR25 Class 5 Peak Radiated Horizontal

30MHz to 1GHz

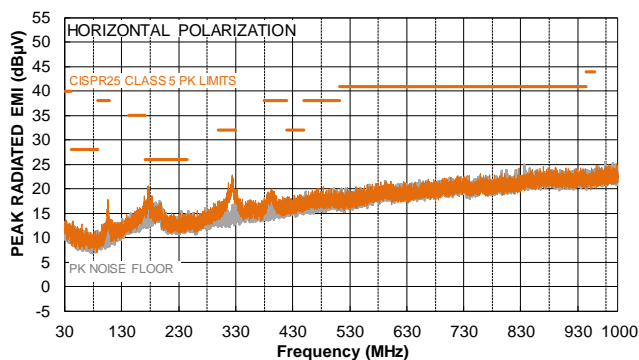

CISPR25 Class 5 Average Radiated Horizontal

30MHz to 1GHz

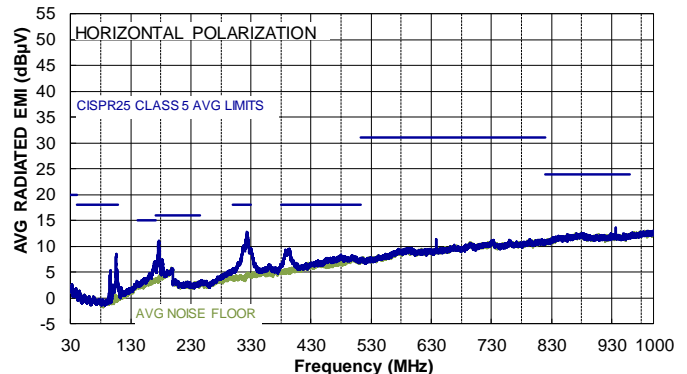

TYPICAL PERFORMANCE CHARACTERISTICS *(continued)*

V_{IN} = 12V, V_{OUT} = 5V, I_{OUT} = 6A, L = 4.7μH, f_{SW} = 410kHz, T_A = 25°C, with FSS (MP4436A only), unless otherwise noted. ⁽⁸⁾

CISPR25 Class 5 Peak Radiated Emissions

Vertical, 30MHz to 1GHz

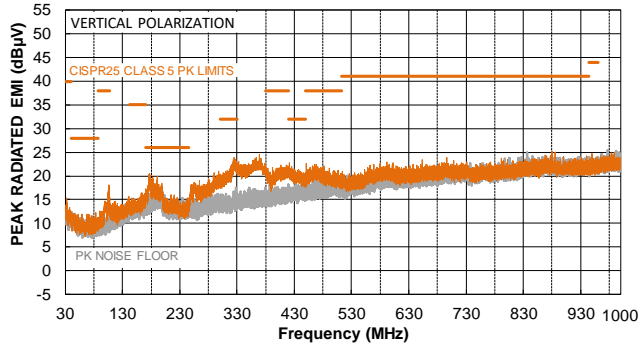

CISPR25 Class 5 Average Radiated Emissions

Vertical, 30MHz to 1GHz

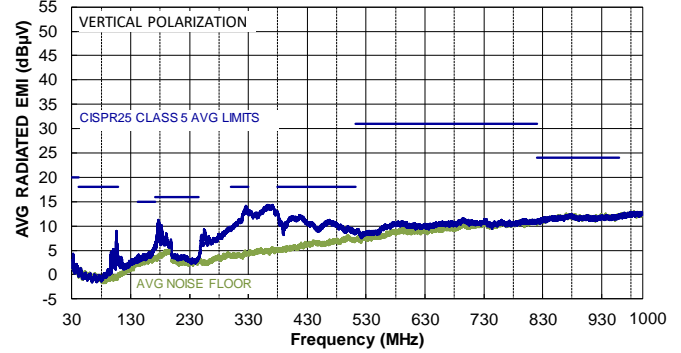

Note:

8) The EMC test results are based on the application circuit with EMI filters (see Figure 13 on page 34).

TYPICAL PERFORMANCE CHARACTERISTICS (continued)

V_{IN} = 12V, V_{OUT} = 3.3V, L = 4.7μH, f_{sw} = 470kHz, AAM, T_A = 25°C, unless otherwise noted.

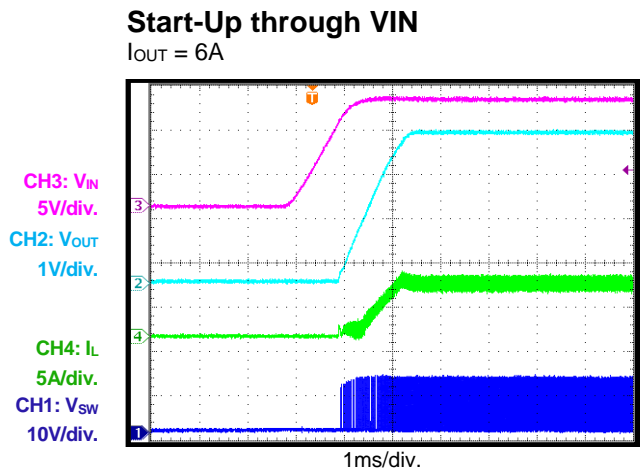
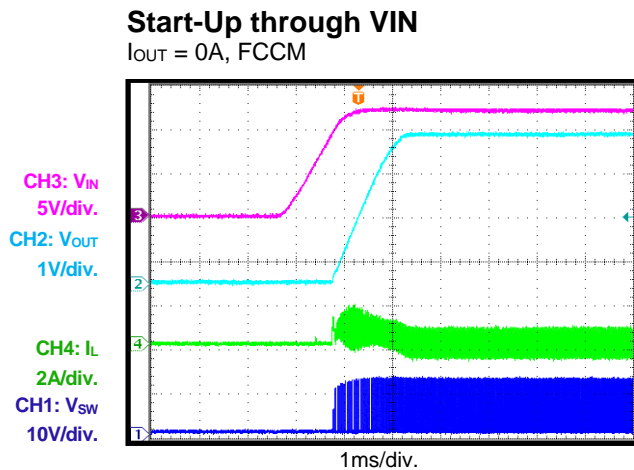
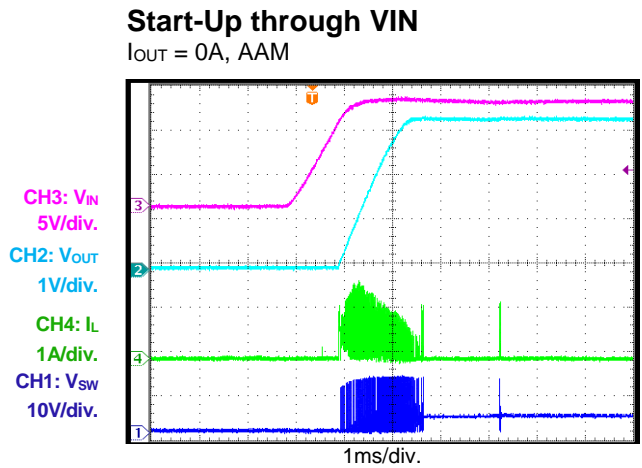
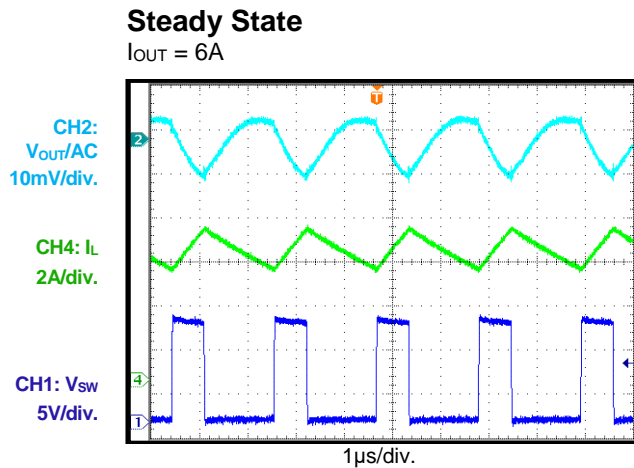
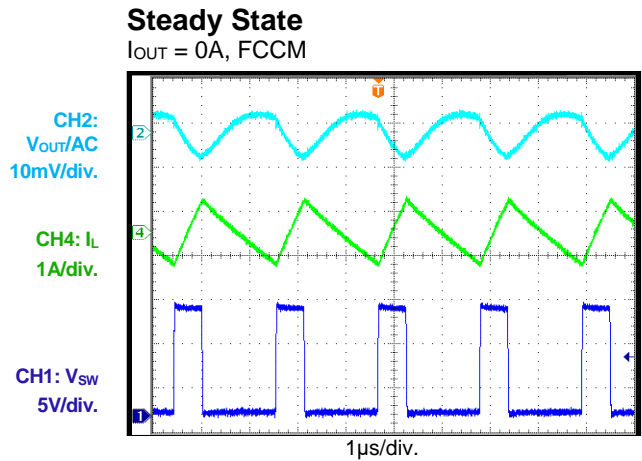
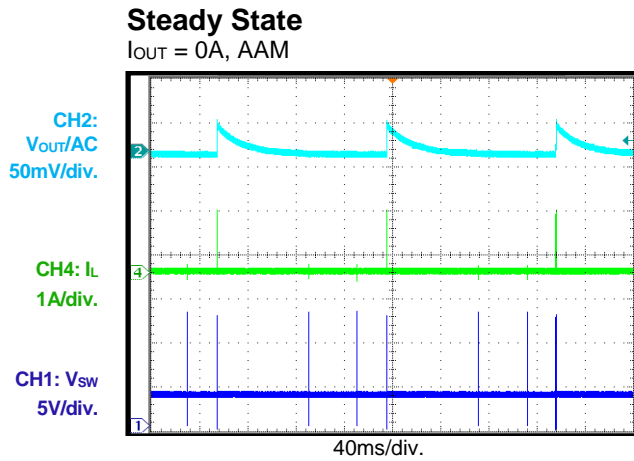

TYPICAL PERFORMANCE CHARACTERISTICS (continued)

V_{IN} = 12V, V_{OUT} = 3.3V, L = 4.7μH, f_{sw} = 470kHz, AAM, T_A = 25°C, unless otherwise noted.

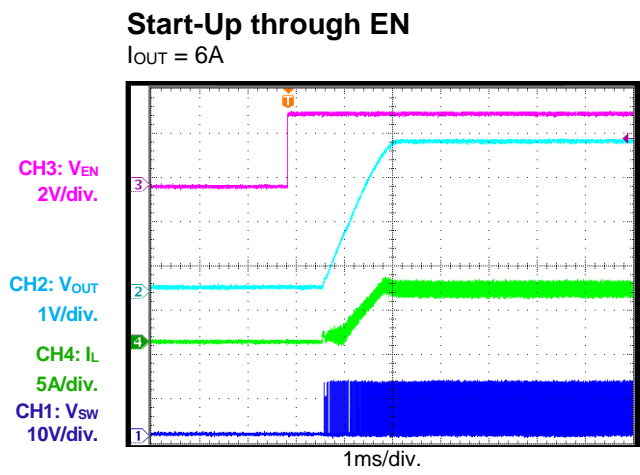
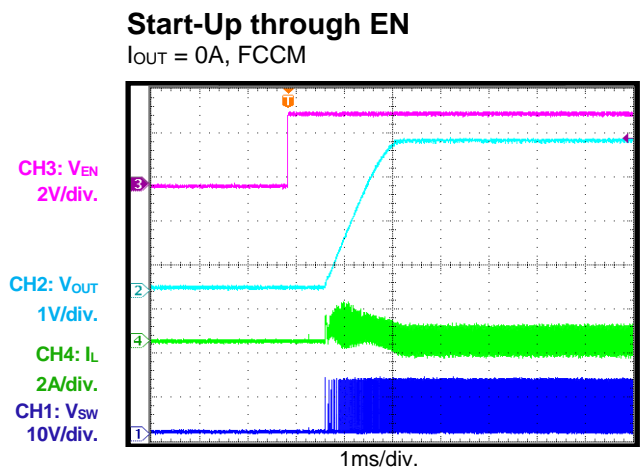
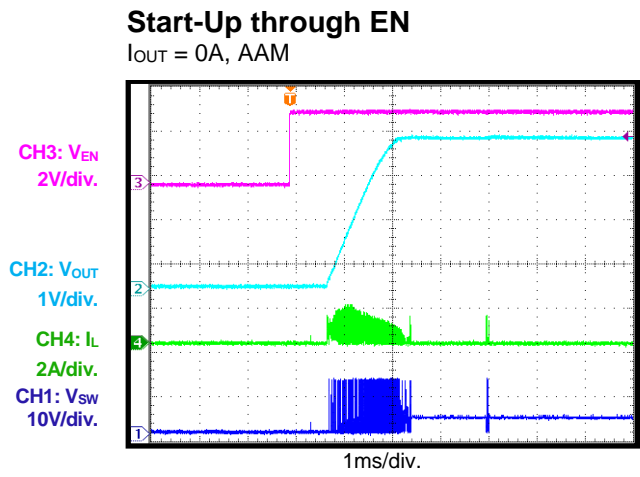
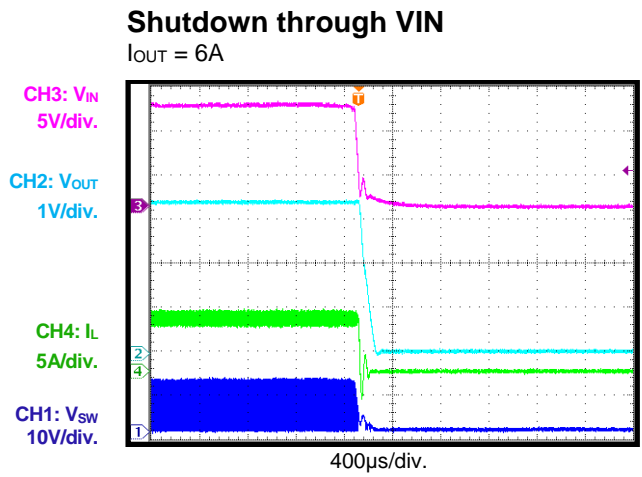
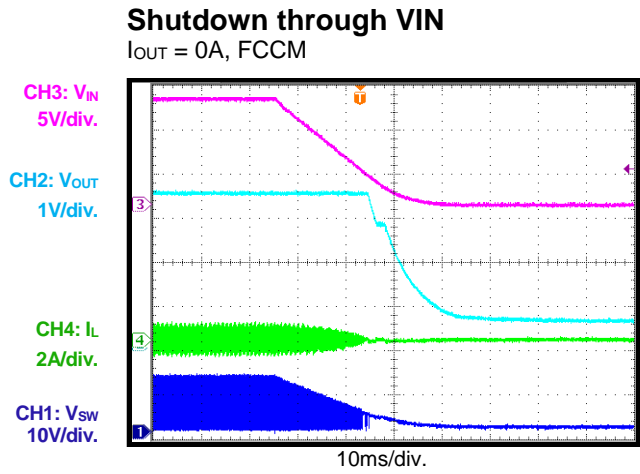
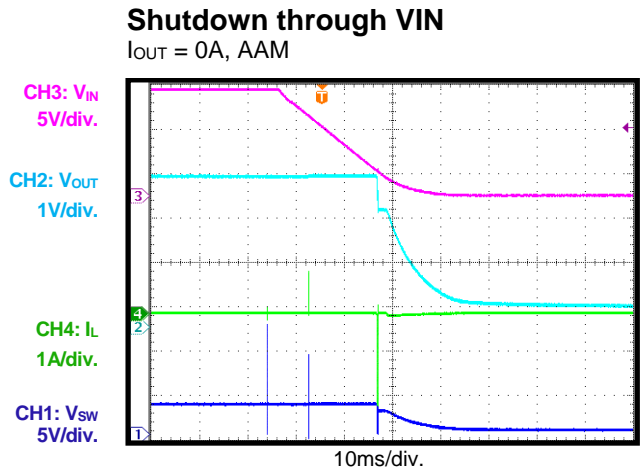

TYPICAL PERFORMANCE CHARACTERISTICS (continued)

V_{IN} = 12V, V_{OUT} = 3.3V, L = 4.7μH, f_{sw} = 470kHz, AAM, T_A = 25°C, unless otherwise noted.

Shutdown through EN

I_{OUT} = 0A, AAM

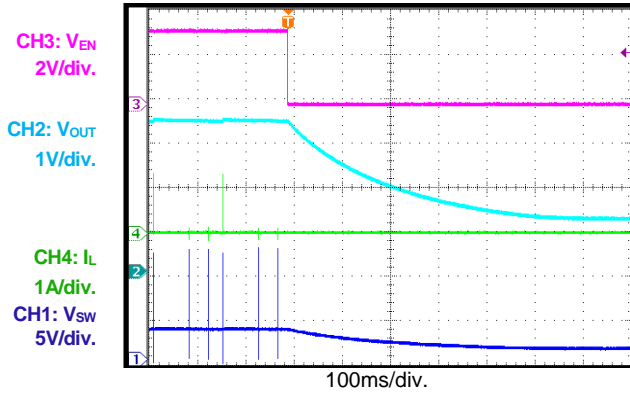

Shutdown through EN

I_{OUT} = 0A, FCCM

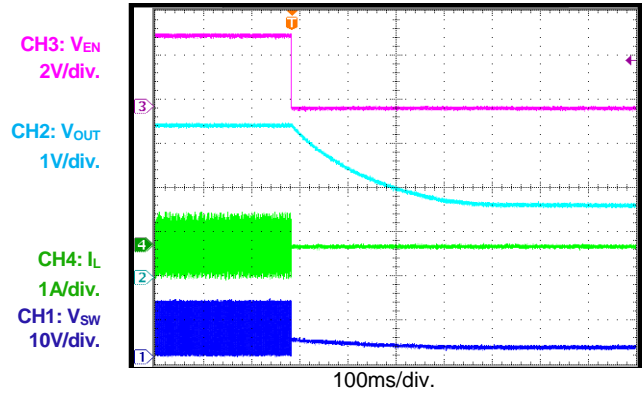

Shutdown through EN

I_{OUT} = 6A

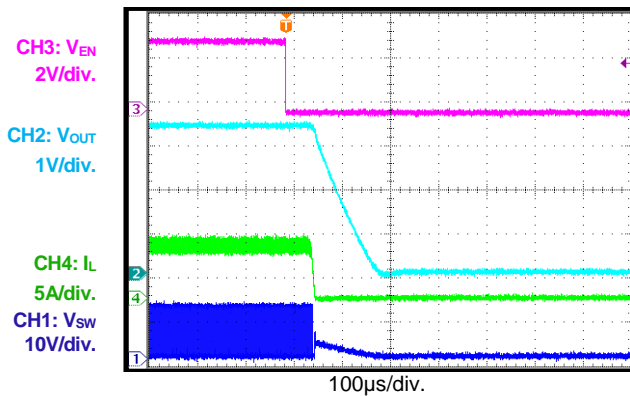

SCP Entry

I_{OUT} = 0A, AAM

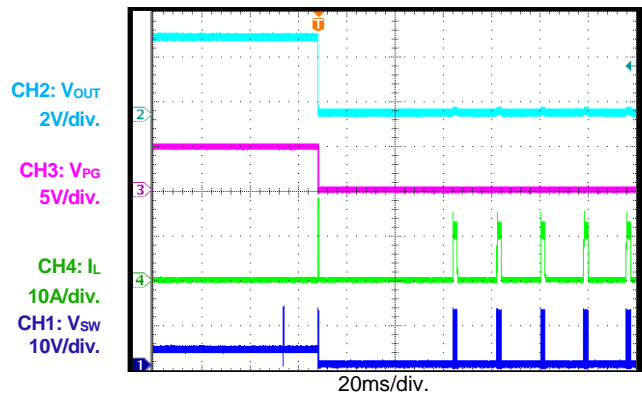

SCP Entry

I_{OUT} = 0A, FCCM

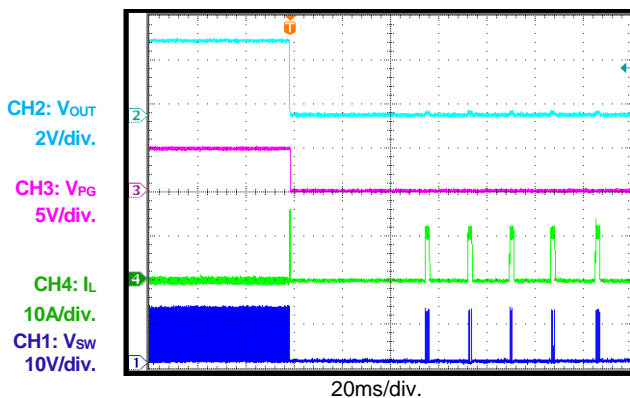

SCP Entry

I_{OUT} = 6A

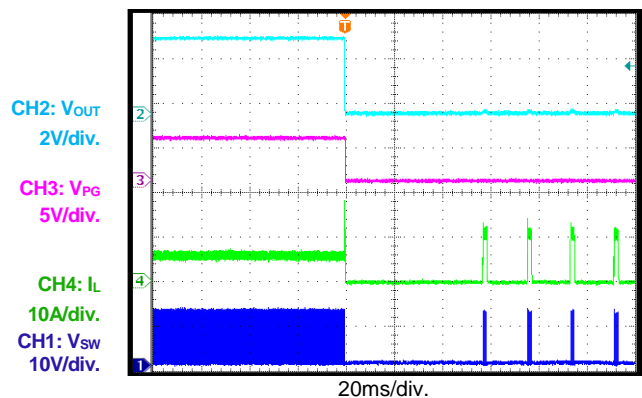

TYPICAL PERFORMANCE CHARACTERISTICS (continued)

V_{IN} = 12V, V_{OUT} = 3.3V, L = 4.7μH, f_{sw} = 470kHz, AAM, T_A = 25°C, unless otherwise noted.

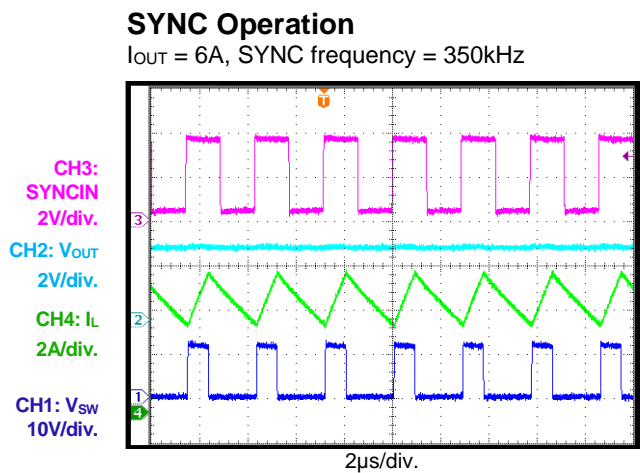
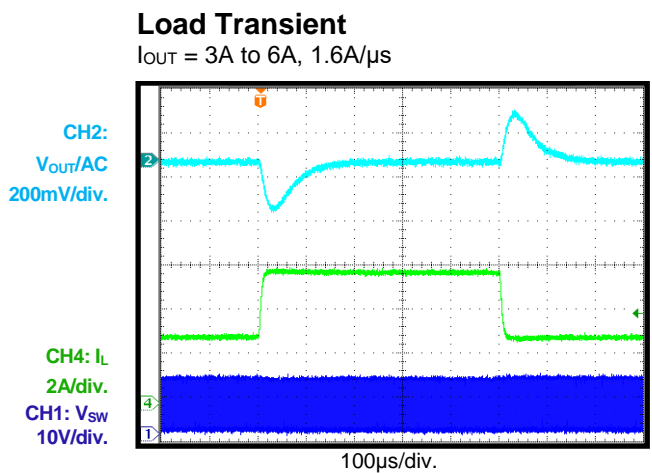
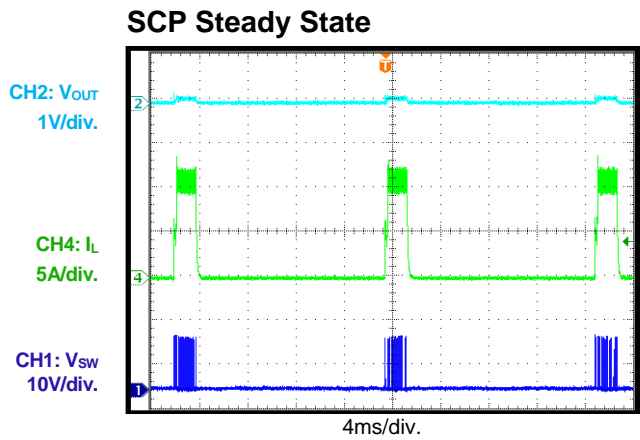
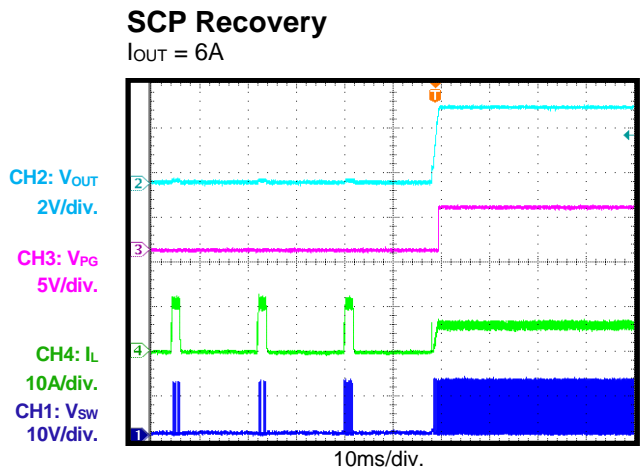
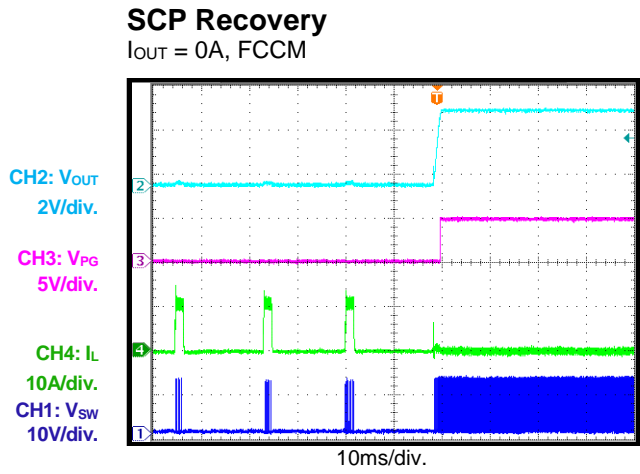
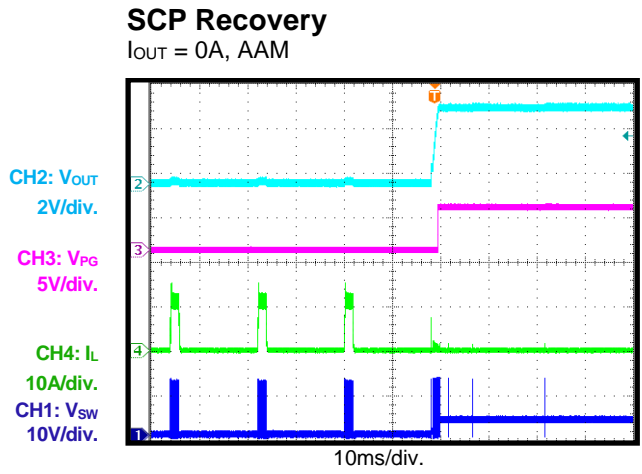

TYPICAL PERFORMANCE CHARACTERISTICS (continued)

V_{IN} = 12V, V_{OUT} = 3.3V, L = 4.7μH, f_{sw} = 470kHz, AAM, T_A = 25°C, unless otherwise noted.

SYNC Operation

I_{OUT} = 6A, SYNC frequency = 530kHz

CH3: SYNCIN
2V/div.
CH2: V_{OUT}
1V/div.
CH4: I_L
2A/div.
CH1: V_{sw}
5V/div.

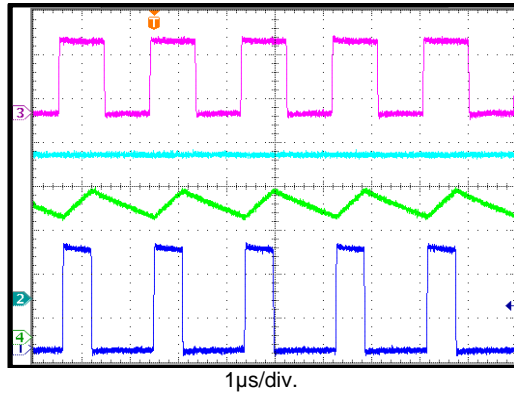

SYNCO Operation

I_{OUT} = 6A, SYNC frequency = 350kHz

CH3: SYNCO
2V/div.
CH2: V_{OUT}
2V/div.
CH4: I_L
2A/div.
CH1: V_{sw}
10V/div.

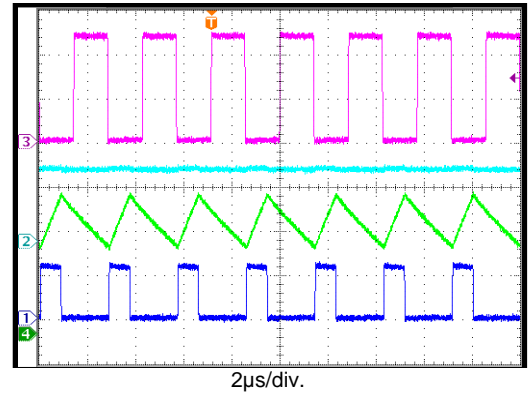

SYNCO Operation

I_{OUT} = 6A, SYNC frequency = 530kHz

CH3: SYNCO
2V/div.
CH2: V_{OUT}
1V/div.
CH4: I_L
2A/div.
CH1: V_{sw}
2V/div.

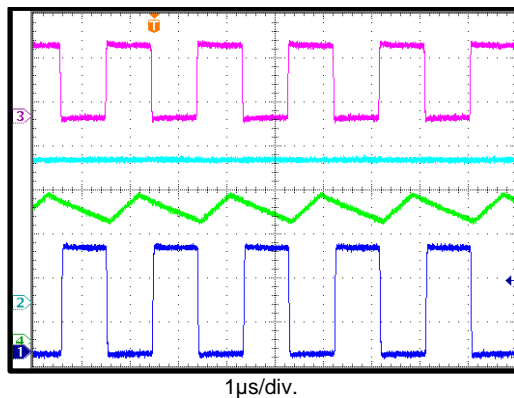

PG Start-Up through VIN

I_{OUT} = 0A

CH3: V_{IN}
5V/div.
CH2: V_{OUT}
2V/div.
CH4: V_{PG}
2V/div.
CH1: V_{sw}
10V/div.

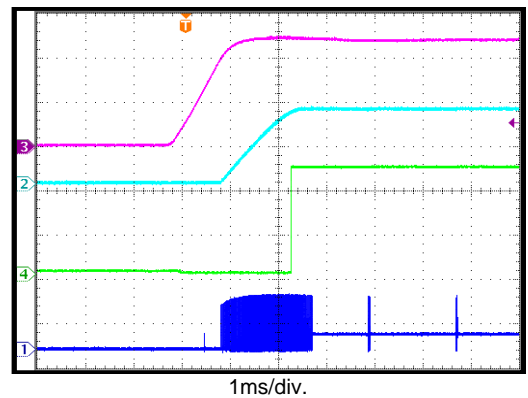

PG Start-Up through VIN

I_{OUT} = 6A

CH3: V_{IN}
5V/div.
CH2: V_{OUT}
2V/div.
CH4: V_{PG}
2V/div.
CH1: V_{sw}
5V/div.

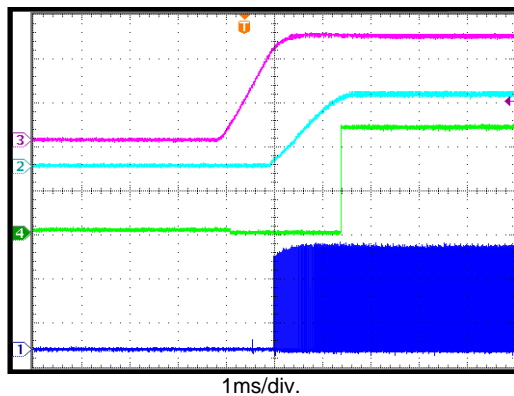

PG Shutdown through VIN

I_{OUT} = 0A

CH3: V_{IN}
5V/div.
CH2: V_{OUT}
2V/div.
CH4: V_{PG}
2V/div.
CH1: V_{sw}
5V/div.

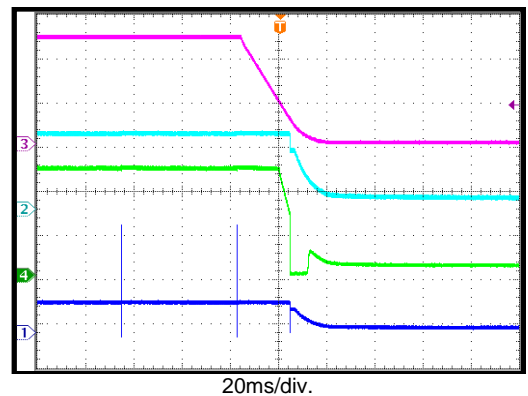

TYPICAL PERFORMANCE CHARACTERISTICS (continued)

V_{IN} = 12V, V_{OUT} = 3.3V, L = 4.7μH, f_{sw} = 470kHz, AAM, T_A = 25°C, unless otherwise noted.

PG Shutdown through VIN

I_{OUT} = 6A

CH3: V_{IN}
5V/div.
CH2: V_{OUT}
2V/div.
CH4: V_{PG}
2V/div.
CH1: V_{sw}
5V/div.

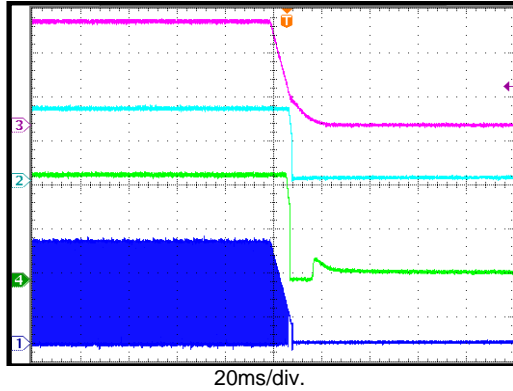

PG Start-Up through EN

I_{OUT} = 0A

CH3: V_{EN}
2V/div.
CH2: V_{OUT}
2V/div.
CH4: V_{PG}
2V/div.
CH1: V_{sw}
5V/div.

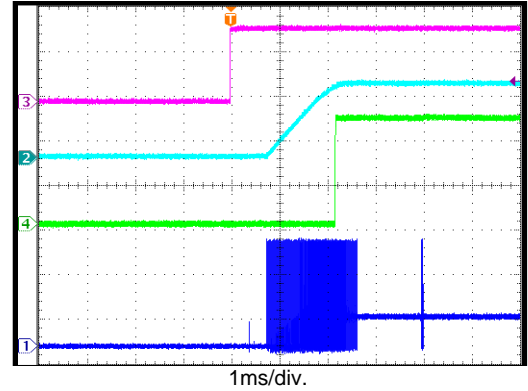

PG Start-Up through EN

I_{OUT} = 6A

CH3: V_{EN}
2V/div.
CH2: V_{OUT}
2V/div.
CH4: V_{PG}
2V/div.
CH1: V_{sw}
10V/div.

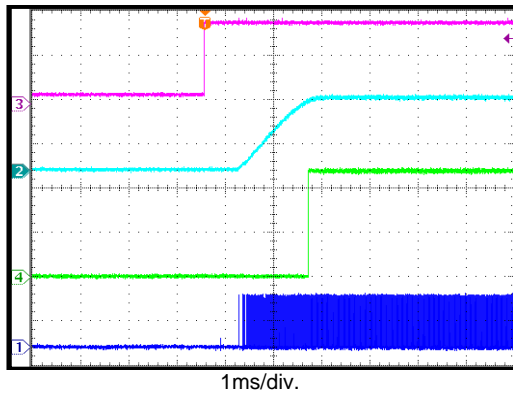

PG Shutdown through EN

I_{OUT} = 0A

CH3: V_{EN}
2V/div.
CH2: V_{OUT}
2V/div.
CH4: V_{PG}
2V/div.
CH1: V_{sw}
5V/div.

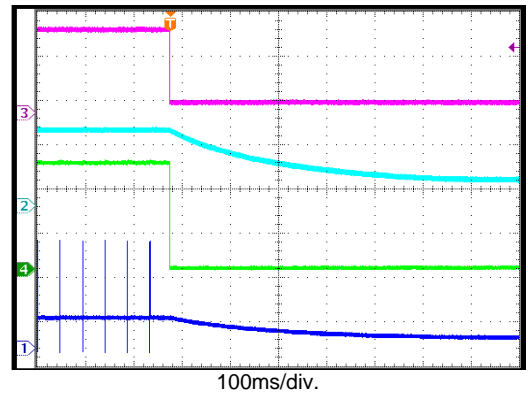

PG Shutdown through EN

I_{OUT} = 6A

CH3: V_{EN}
2V/div.
CH2: V_{OUT}
2V/div.
CH4: V_{PG}
2V/div.
CH1: V_{sw}
10V/div.

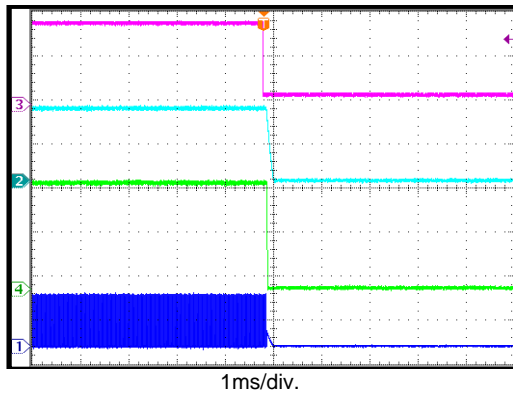

Low-Dropout Mode

V_{IN} = 3.3V, V_{OUT} set to 3.3V, I_{OUT} = 0A

CH3: V_{IN}
500mV/div.
CH2: V_{OUT}
500mV/div.
CH4: I_L
50mA/div.
CH1: V_{sw}
1V/div.

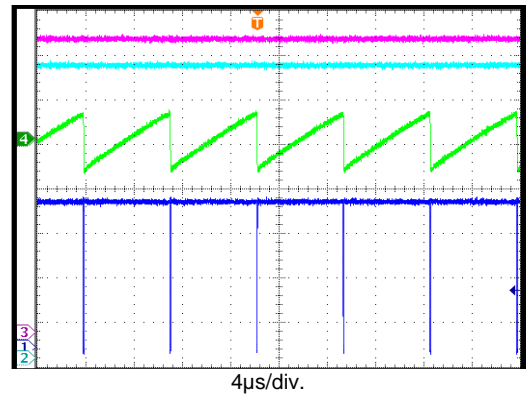

TYPICAL PERFORMANCE CHARACTERISTICS (continued)

V_{IN} = 12V, V_{OUT} = 3.3V, L = 4.7μH, f_{sw} = 470kHz, AAM, T_A = 25°C, unless otherwise noted.

Low-Dropout Mode

V_{IN} = 3.3V, V_{OUT} set to 3.3V, I_{OUT} = 6A

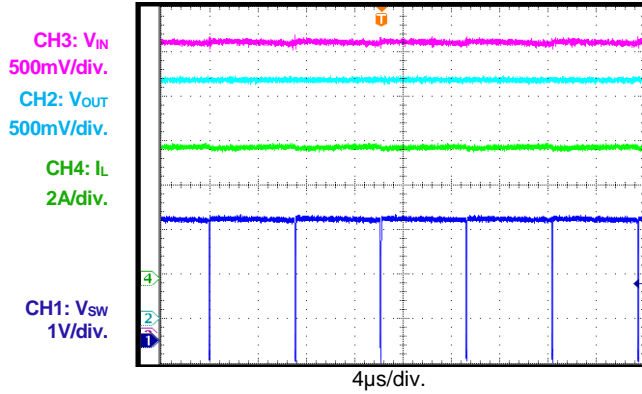

Load Dump

V_{IN} = 12V to 36V, I_{OUT} = 6A

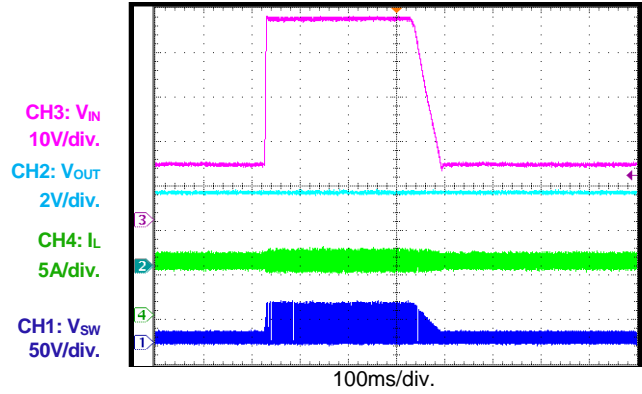

Cold Crank

V_{IN} = 12V to 3.3V to 5V, I_{OUT} = 6A

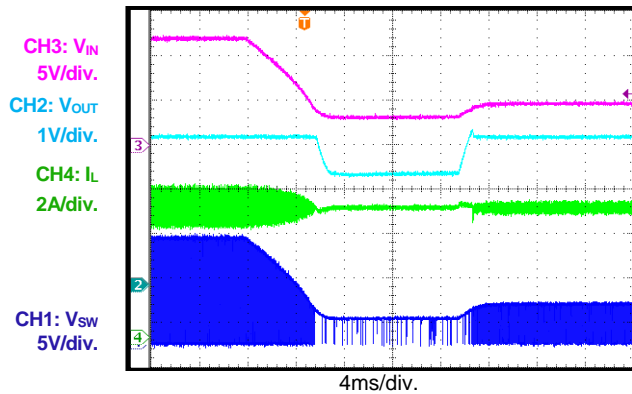

V_{IN} Ramp Up and Down

I_{OUT} = 0.1A

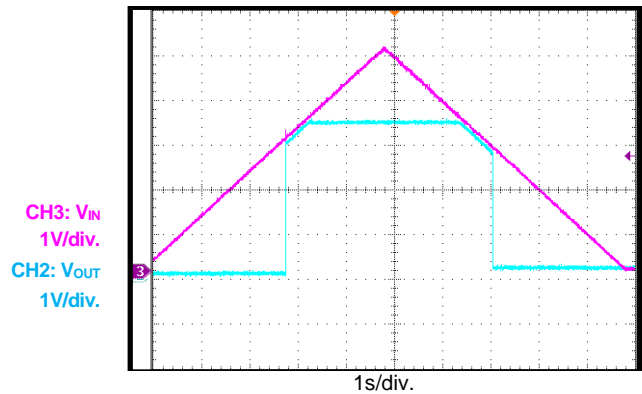

V_{IN} Ramp Down and Up

I_{OUT} = 1mA

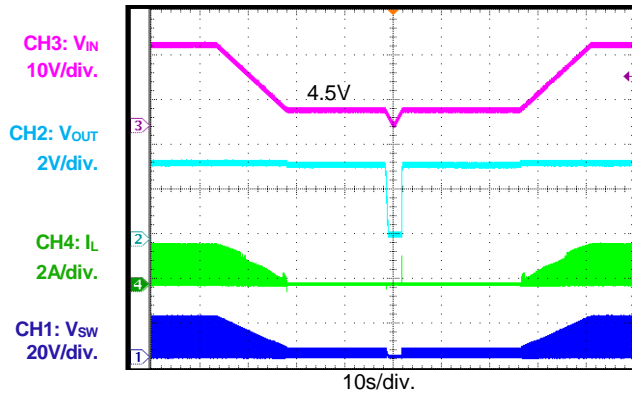

V_{IN} Ramp Down and Up

I_{OUT} = 6A

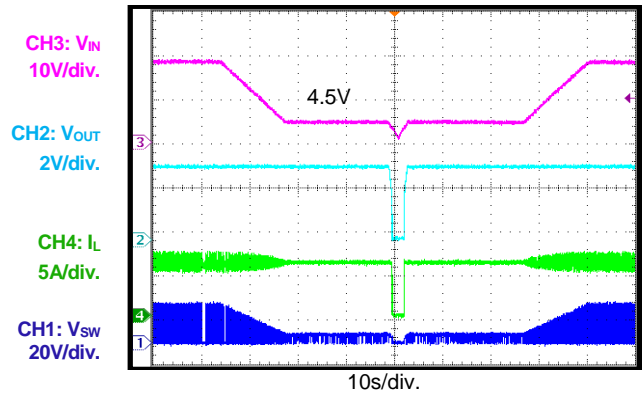

TYPICAL PERFORMANCE CHARACTERISTICS (continued)

V_{IN} = 12V, V_{OUT} = 3.3V, L = 4.7μH, f_{sw} = 470kHz, AAM, T_A = 25°C, unless otherwise noted.

Steady State

V_{IN} = 12V, V_{OUT} = 3.3V, I_{OUT} = 20A, 4-phase

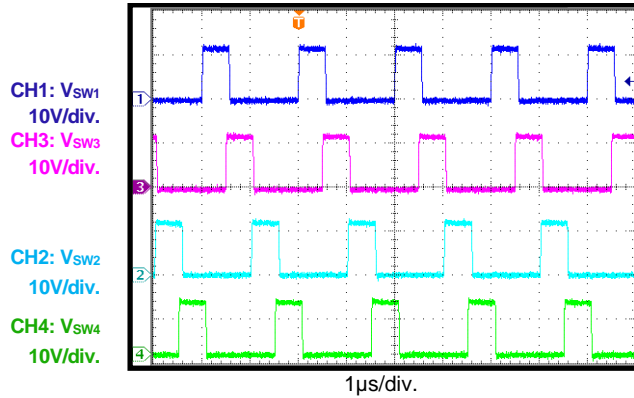

Steady State

V_{IN} = 12V, V_{OUT} = 3.3V, I_{OUT} = 20A, 4-phase

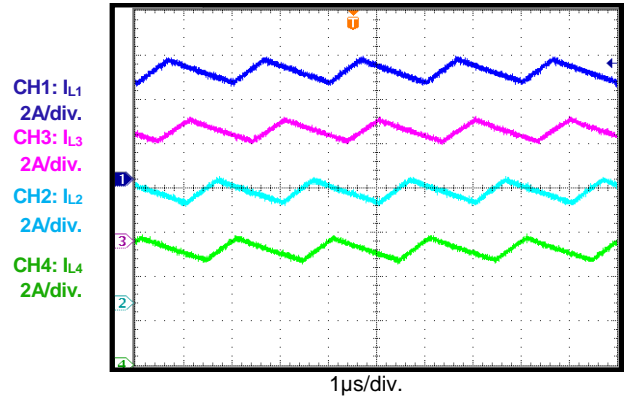

FUNCTION BLOCK DIAGRAM

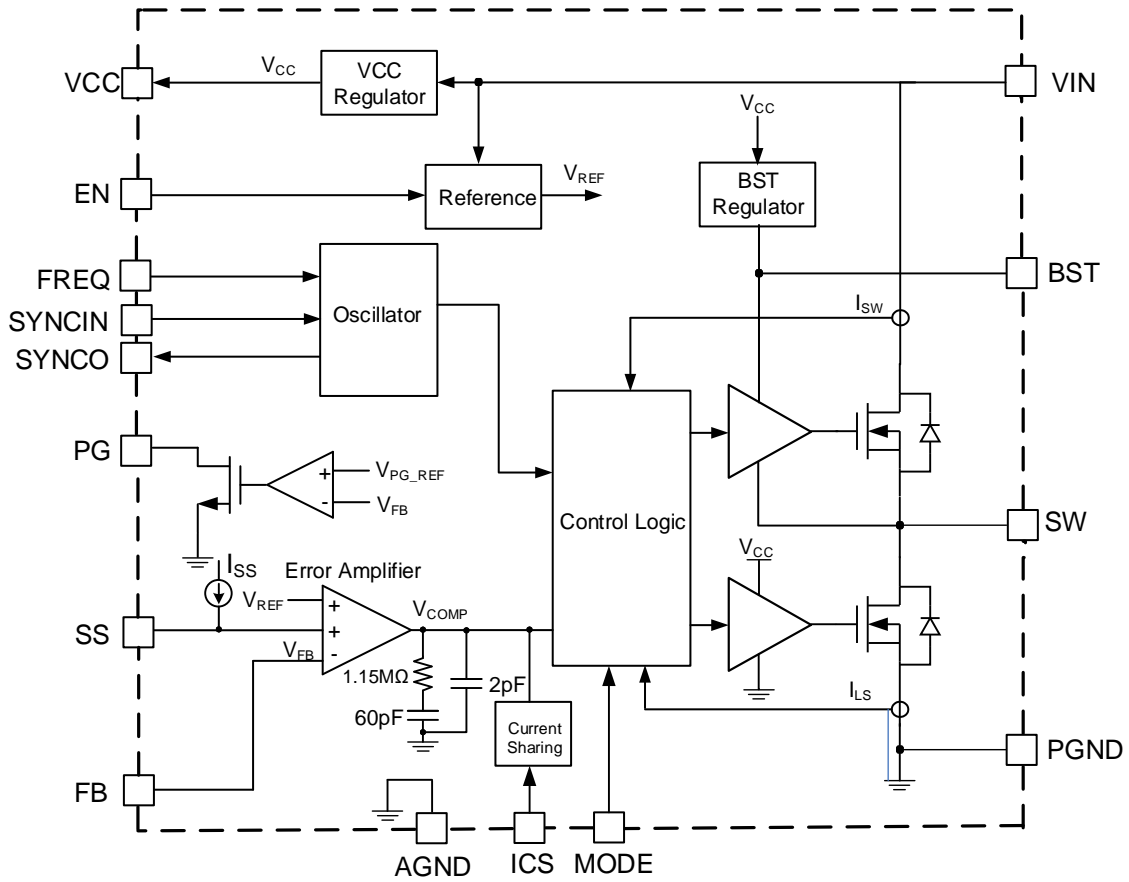

Figure 1: Functional Block Diagram

TIMING SEQUENCE DIAGRAM

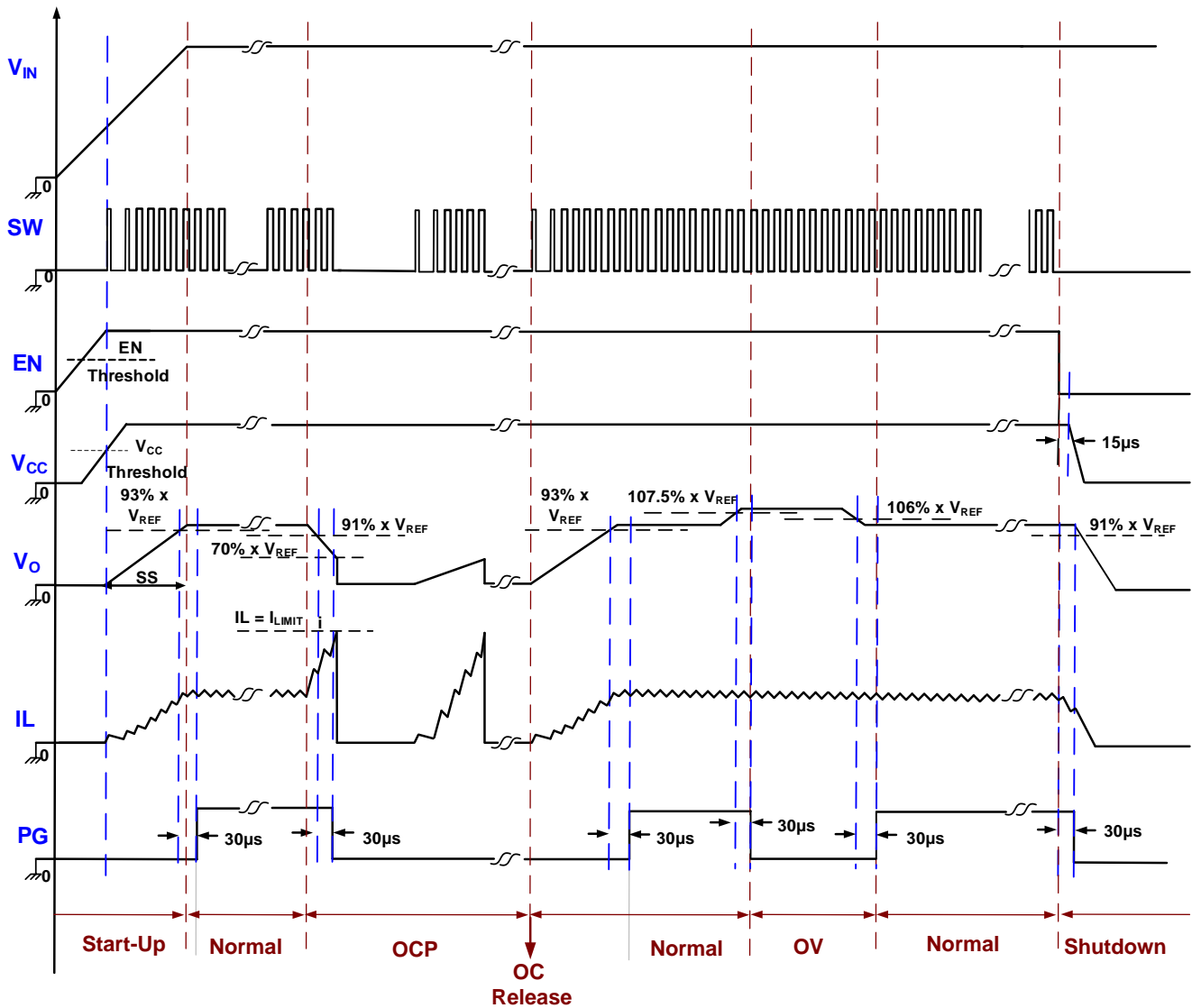

Figure 2: Timing Sequence Diagram

OPERATION

The MP4436/MP4436A is a synchronous, step-down switching regulator with integrated internal high-side and low-side power MOSFETs. It provides 6A of highly efficient output with current mode control.

The device features a wide input voltage range, configurable switching frequency, external soft start, and precision current limiting. Its low operational quiescent current makes it ideal for battery-powered applications.

PWM Control

At moderate to high output currents, the MP4436/MP4436A operates in fixed-frequency, peak current control mode to regulate the output voltage. A PWM cycle is initiated by the internal clock. At the rising edge of the clock, the high-side MOSFET (HS-FET) turns on and remains on until its current reaches the value set by the internal COMP voltage (V_{COMP}). Once the HS-FET is on, it remains on for at least 100ns.

When the high-side power switch is off, the low-side MOSFET (LS-FET) turns on immediately and remains on until the next cycle starts. Once the LS-FET is on, it remains on for at least 80ns before the next cycle starts.

If the current in the HS-FET does not reach the value set by COMP within one PWM period, the HS-FET remains on, saving a turn-off operation. The HS-FET is forced off if the on time lasts about 10 μ s, even if the current value is not reached.

Light-Load Operation

Under light-load conditions, the MP4436/MP4436A can work in two different operation modes based on the status of the MODE pin.

The MP4436/MP4436A works in forced continuous conduction mode (FCCM) when the MODE pin is pulled above 1.8V. The part works with fixed frequency from no load to full load in this mode. The advantage of FCCM is the controllable frequency and lower output ripple at light load.

The MP4436/MP4436A works in advanced asynchronous mode (AAM) when the MODE pin

is pulled below 0.4V. AAM optimizes efficiency under light-load and no-load conditions.

When AAM is enabled, the MP4436/MP4436A first enters asynchronous operation while the inductor current approaches 0A at light load. If the load is further decreased, or there is no load and V_{COMP} drops to the set value, then the MP4436/MP4436A enters AAM. In AAM, the internal clock is reset every time V_{COMP} crosses over the set value. The crossover time is used as the benchmark for the next clock. When the load increases and V_{COMP} exceeds the set value, the operation mode is DCM or CCM, which has a constant switching frequency (see Figure 3).

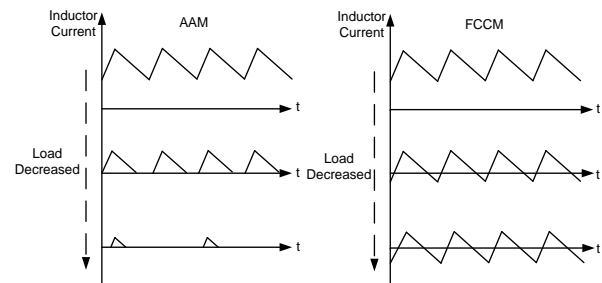

Figure 3: AAM and FCCM

Error Amplifier

The error amplifier compares the FB pin voltage (V_{FB}) with the internal reference (0.815V) and outputs a current proportional to the difference between the two values. This output current is then used to charge the compensation network to form V_{COMP} , which controls the power MOSFET current. During operation, the minimum V_{COMP} is clamped to 0.9V, and the maximum is clamped to 2.0V. COMP is internally pulled down to GND in shutdown mode.

Internal Regulator (VCC)

Most of the internal circuitry is powered by the internal 4.9V VCC regulator. This regulator takes V_{IN} as the input and operates in the full V_{IN} range. If V_{IN} exceeds 4.9V, V_{CC} is in full regulation. When V_{IN} is below this point, the output V_{CC} degrades.

Bootstrap Charging

The bootstrap capacitor is charged and regulated to about 5V by the dedicated internal bootstrap regulator. If the voltage between the BST and SW nodes is below its regulation, a

PMOS pass transistor connected from VCC to BST turns on to charge the bootstrap capacitor. External circuitry should provide sufficient headroom voltage to facilitate the charging.

If the HS-FET is on, BST is above VCC, and the bootstrap capacitor cannot be charged.

Under operation conditions with higher duty cycles, there is less time to charge the bootstrap, so the bootstrap capacitor may not charge sufficiently. If the external circuit does not have a sufficient voltage or enough time to charge the bootstrap capacitor, extra external circuitry can be used to ensure that the bootstrap voltage is in the normal operation range.

Low-Dropout Operation and BST Refresh

To improve dropout, the MP4436/MP4436A is designed to operate at close to 100% duty cycle as long as the BST-to-SW voltage exceeds 2.5V. When the voltage from BST to SW drops below 2.5V, the HS-FET turns off using an under-voltage lockout (UVLO) circuit, which allows the LS-FET to conduct and refresh the charge on the BST capacitor. In DCM mode or PSM mode, the LS-FET is forced on to refresh the BST voltage.

Since the supply current sourced from the BST capacitor is low, the HS-FET remains on for more switching cycles than are required to refresh the capacitor. Therefore, the effective duty cycle of the switching regulator is high.

The effective duty cycle during regulator dropout is mainly influenced by the voltage drops across the power MOSFET, inductor resistance, low-side diode, and PCB resistance.

Enable Control

EN is a digital control pin that turns the regulator on and off (see Figure 4). It offers two main features:

1. **Enabled by external logic H/L signal:** If EN is pulled below the falling voltage threshold (0.85V), the chip goes into the lowest shutdown current mode. Force the EN pin above the EN rising threshold voltage (1V) to turn the part on.
2. **Configurable V_{IN} under-voltage lockout (UVLO):** With a sufficient V_{IN}, the chip can be enabled and disabled by the EN pin. With the internal current source, this circuit can

generate a configurable V_{IN} UVLO threshold and hysteresis.

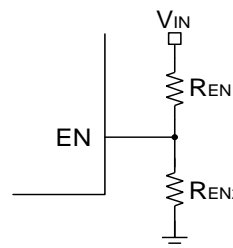

Figure 4: Enable Divider Circuit

Configurable Frequency and Frequency Foldback

The MP4436/MP4436A oscillating frequency is configured either by an external resistor (R_{FREQ}) from the FREQ pin to ground, or by a logic level SYNC signal.

For an expected switching frequency (f_{SW}), select the R_{FREQ} value following the f_{SW} vs. R_{FREQ} curve in the Typical Performance Characteristics section on page 14. Note that if f_{SW} is set to a high value, it will fold back at high a V_{IN} to avoid triggering the minimum on time and forcing the output out of regulation.

The f_{SW} vs. V_{IN} curve in the Typical Performance Characteristics section on page 14 shows an example when R_{FREQ} is 12kΩ. The corresponding f_{SW} is about 2.1MHz when V_{IN} = 12V, and drops below 1.5MHz when V_{IN} exceeds 18V. This means the switching frequency drops into the AM band (<1.8MHz), which should be avoided for car battery applications due to EMI compliance.

For car battery applications, the MP4436/MP4436A's recommended f_{SW} is between 350kHz and 530kHz. Higher frequencies may be supported for applications that do not have critical limits on the switching frequency or have relatively low, stable input voltages.

Frequency Spread Spectrum (MP4436A Only)

The MP4436A uses a 12kHz modulation frequency with a 128-step triangular profile to spread the internal oscillator frequency across a 20% (±10%) window. The steps are fixed and independent of the set oscillator frequency to optimize frequency spread spectrum (FSS) performance (see Figure 5).

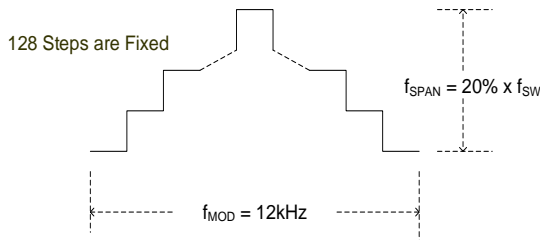

Figure 5: Spread Spectrum Scheme

Side bands are created by modulating the switching frequency with the triangle modulation waveform. The emission power of the fundamental switching frequency and its harmonics is distributed into smaller pieces, which significantly reduces peak EMI noise.

Soft Start

Soft start is implemented to prevent the converter output voltage from overshooting during start-up.

When the soft-start period starts, an internal current source begins charging the external soft-start capacitor. When the soft-start voltage (V_{SS}) is below the internal reference (V_{REF}), V_{SS} overrides V_{REF}, so the error amplifier uses V_{SS} as the reference. When V_{SS} exceeds V_{REF}, V_{REF} is used as the reference. C_{SS} can be calculated with Equation (1):

$$C_{SS}(nF) = \frac{t_{SS}(ms) \times I_{SS}(\mu A)}{V_{REF}(V)} = 6.25 \times t_{SS}(ms) \quad (1)$$

The SS pin can be used for tracking and sequencing.

Pre-Biased Start-Up

If V_{FB} > V_{SS} - 150mV at start-up (which means the output has a pre-biased voltage), neither the HS-FET nor LS-FET turn on until V_{SS} exceeds V_{FB}.

Thermal Shutdown

Thermal shutdown is implemented to prevent the chip from thermal runaway. If the silicon die temperature exceeds its upper threshold, it shuts down the power MOSFETs. If the temperature falls below its lower threshold, the chip is enabled again.

Current Comparator and Current Limit

The power MOSFET current is accurately sensed via a current-sense MOSFET. It is then fed to the high-speed current comparator for

current mode control. The current comparator uses this sensed current as one of its inputs.

When the HS-FET turns on, the comparator is blanked until the end of start-up to prevent the noise. Then the comparator compares the power switch current with V_{COMP}. If the sensed current exceeds V_{COMP}, the comparator outputs low to turn off the HS-FET. The maximum current of the internal power MOSFET is internally limited cycle by cycle.

Hiccup Protection

If the output is shorted to ground and the output voltage drops below 70% of its nominal output, the IC shuts down momentarily and begins discharging the soft-start capacitor. It restarts with a full soft start when the soft-start capacitor is fully discharged. This hiccup process repeats until the fault is removed.

Start-Up and Shutdown

If both VIN and EN exceed their respective thresholds, the chip starts. The reference block starts first, generating a stable reference voltage and current. Then the internal regulator is enabled; the regulator provides a stable supply for the remaining circuitries.

While the internal supply rail is up, an internal timer holds the power MOSFET off for about 50µs to blank the start-up glitches. When the soft-start block is enabled, it first holds its SS output low to ensure the remaining circuitries are ready, then slowly ramps up.

Three events shut down the chip: EN going low, VIN going low, and thermal shutdown. During shutdown, the signaling path is blocked first to avoid any fault triggering. V_{COMP} and the internal supply rail are then pulled down. The floating driver is not subject to this shutdown command, but its charging path is disabled.

Power Good (PG) Output

The MP4436/MP4436A has power good (PG) indication. The PG pin is the open drain of a MOSFET. Connect a pull-up resistor to the power source if the PG pin is used. PG goes high if the output voltage is within 93% to 106% of the nominal voltage, and goes low when the output voltage is above 107.5% or below 91% of the nominal voltage.

SYNCIN and SYNCO

The switching frequency can be synced to the rising edge of the clock signal applied at SYNCIN. The recommended SYNCIN frequency range is between 350kHz and 530kHz. Ensure that the off time for SYNCIN is shorter than the internal oscillator period, otherwise the internal clock may turn on the HS-FET before the rising edge of SYNCIN.

There is no other special limit on SYNCIN's pulse width, but there is always parasitic capacitance on the pad. If the pulse width is too short, a clear rising and falling edge may not be seen due to the parasitic capacitance. A pulse longer than 100ns is recommended in the application.

When applying SYNCIN in AAM, drive SYNCIN below its specified threshold (0.4V) or leave SYNCIN floating before the MP4436/MP4436A starts up and enters AAM. Then add the external SYNCIN clock. The SYNCO pin provides a default 180° phase-shifted clock to the internal oscillator when there is no SYNCIN signal. If an external clock signal is applied at SYNCIN, the SYNCO pin provides a default 180° phase-shifted clock to the SYNCIN signal (see Figure 6).

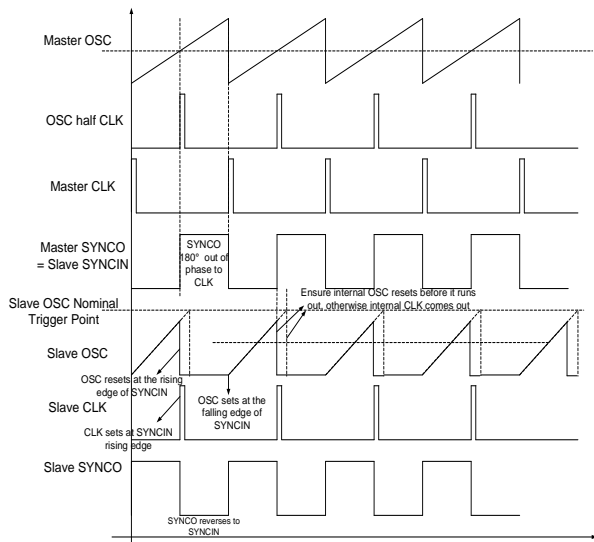

Figure 6: SYNCIN and SYNCO Scheme

Figure 7 shows a dual-phase, interleaved configuration. For multi-phase applications, the VOUT, FB, and ICS pins of parallel ICs must be connected together. The SYNCO of the master is connected to the SYNCIN pin of the slave for

phase-interleaved configurations (see Figure 8).

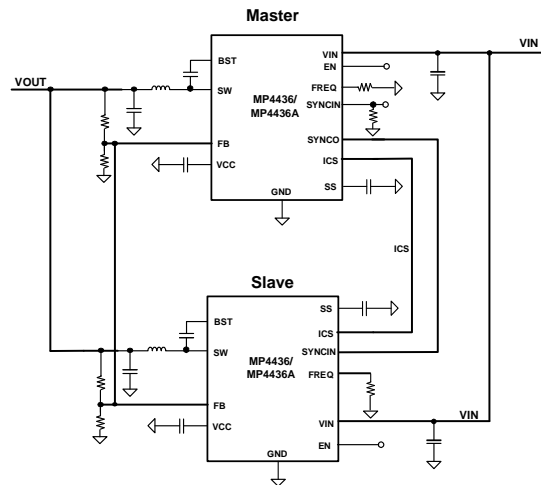

Figure 7: Dual-Phase Configuration

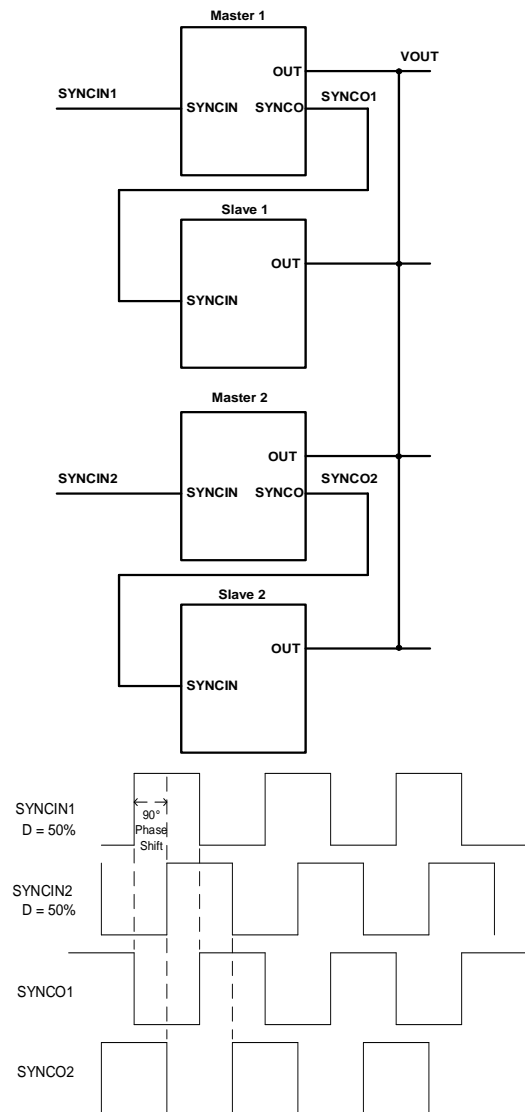

Figure 8: Four-Phase Configuration

APPLICATION INFORMATION

Setting the BST Capacitor

If using the MP4436/MP4436A in FCCM only, use a minimum 0.2µF BST capacitor. If using AAM, the external BST capacitor should be greater than 0.2µF. The BST capacitance can be calculated with Equation (2) or Equation (3):

$$C_{\text{BST}} (\mu\text{F}) \geq \frac{75 \times C_{\text{OUT}} (\mu\text{F}) \times 10^{-3}}{I_{\text{MIN}} (\mu\text{A})} \quad (2)$$

$$C_{\text{BST}} (\mu\text{F}) \geq \frac{80}{I_{\text{MIN}} (\mu\text{A}) \times L (\mu\text{H})} \quad (3)$$

If the calculated C_{BST} exceeds 6.8µF, contact an MPS FAE to verify the design.

Setting the VCC Capacitor

The VCC capacitance should be 10 times greater than the boost capacitance (typically at least 4.7µF). A VCC capacitance greater than 68µF is not recommended.

Setting the Output Voltage

The external resistor divider connected to FB sets the output voltage (see Figure 9).

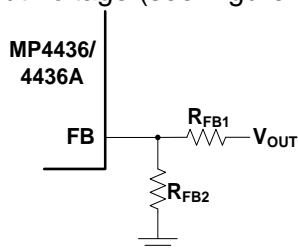

Figure 9: Feedback Network

Calculate R_{FB2} with Equation (4):

$$R_{\text{FB2}} = \frac{R_{\text{FB1}}}{\frac{V_{\text{OUT}}}{0.815\text{V}} - 1} \quad (4)$$

Table 1 lists the recommended feedback resistor values for common output voltages.

Table 1: Resistor Selection for Output Voltages

V _{OUT} (V)	R _{FB1} (kΩ)	R _{FB2} (kΩ)
3.3	100 (1%)	32.4 (1%)
5	100 (1%)	19.6 (1%)

Selecting the Input Capacitor

The step-down converter has a discontinuous input current, and requires a capacitor to supply AC current to the converter while maintaining the DC input voltage. For the best performance, use low-ESR capacitors. Ceramic capacitors with X5R or X7R dielectrics are highly recommended because of their low ESR and small temperature coefficients.

For most applications, use a 4.7µF to 10µF capacitor. It is strongly recommended to use another, lower-value capacitor (e.g. 0.1µF) with a small package size (0603) to absorb high-frequency switching noise. Place the smaller capacitor as close to V_{IN} and GND as possible.

Since C_{IN} absorbs the input switching current, it requires an adequate ripple current rating. The RMS current in the input capacitor can be estimated with Equation (5):

$$I_{\text{CIN}} = I_{\text{LOAD}} \times \sqrt{\frac{V_{\text{OUT}}}{V_{\text{IN}}} \times \left(1 - \frac{V_{\text{OUT}}}{V_{\text{IN}}}\right)} \quad (5)$$

The worst-case condition occurs at V_{IN} = 2V_{OUT}, calculated with Equation (6):

$$I_{\text{CIN}} = \frac{I_{\text{LOAD}}}{2} \quad (6)$$

For simplification, choose an input capacitor with an RMS current rating greater than half of the maximum load current.

The input capacitor can be electrolytic, tantalum, or ceramic. When using electrolytic or tantalum capacitors, add a small, high-quality ceramic capacitor (e.g. 0.1µF) as close to the IC as possible. When using ceramic capacitors, ensure that they have enough capacitance to provide a sufficient charge to prevent excessive voltage ripple at the input. The input voltage ripple caused by the capacitance can be estimated with Equation (7):

$$\Delta V_{\text{IN}} = \frac{I_{\text{LOAD}}}{f_{\text{SW}} \times C_{\text{IN}}} \times \frac{V_{\text{OUT}}}{V_{\text{IN}}} \times \left(1 - \frac{V_{\text{OUT}}}{V_{\text{IN}}}\right) \quad (7)$$

Selecting the Output Capacitor

The output capacitor maintains the DC output voltage. Use ceramic, tantalum, or low-ESR electrolytic capacitors. For the best results, use low-ESR capacitors to keep the output voltage ripple low. The output voltage ripple can be estimated with Equation (8):

$$\Delta V_{OUT} = \frac{V_{OUT}}{f_{SW} \times L} \times \left(1 - \frac{V_{OUT}}{V_{IN}}\right) \times \left(R_{ESR} + \frac{1}{8f_{SW} \times C_{OUT}}\right) \quad (8)$$

Where L is the inductor value, and R_{ESR} is the equivalent series resistance (ESR) value of the output capacitor.

For ceramic capacitors, the capacitance dominates the impedance at the switching frequency and causes the majority of the output voltage ripple. For simplification, the output voltage ripple can be estimated with Equation (9):

$$\Delta V_{OUT} = \frac{V_{OUT}}{8 \times f_{SW}^2 \times L \times C_{OUT}} \times \left(1 - \frac{V_{OUT}}{V_{IN}}\right) \quad (9)$$

For tantalum or electrolytic capacitors, the ESR dominates the impedance at the switching frequency. For simplification, the output ripple can be estimated with Equation (10):

$$\Delta V_{OUT} = \frac{V_{OUT}}{f_{SW} \times L} \times \left(1 - \frac{V_{OUT}}{V_{IN}}\right) \times R_{ESR} \quad (10)$$

The characteristics of the output capacitor also affect the stability of the regulation system. The MP4436/MP4436A can be optimized for a wide range of capacitance and ESR values.

Selecting the Inductor

A 1μH to 10μH inductor with a DC current rating at least 25% higher than the maximum load current is recommended for most applications. For higher efficiency, choose an inductor with a lower DC resistance.

A larger-value inductor results in less ripple current and a lower output ripple voltage, but also has a larger physical size, higher series resistance, and lower saturation current. A good rule to determine the inductor value is to allow the inductor ripple current to be approximately 30% of the maximum load current.

The inductance value can be calculated with Equation (11):

$$L = \frac{V_{OUT}}{f_{SW} \times \Delta I_L} \times \left(1 - \frac{V_{OUT}}{V_{IN}}\right) \quad (11)$$

Where ΔI_L is the peak-to-peak inductor ripple current.

Choose the inductor ripple current to be approximately 30% of the maximum load current. The maximum inductor peak current can be calculated with Equation (12):

$$I_{LP} = I_{LOAD} + \frac{V_{OUT}}{2f_{SW} \times L} \times \left(1 - \frac{V_{OUT}}{V_{IN}}\right) \quad (12)$$

VIN Under-Voltage Lockout (UVLO) Setting

The MP4436/MP4436A has an internal, fixed under-voltage lockout (UVLO) threshold. The rising threshold is 3V, and the falling threshold is about 2.65V. For applications that require a higher UVLO point, place an external resistor divider between VIN and EN to achieve a higher equivalent UVLO threshold (see Figure 10).

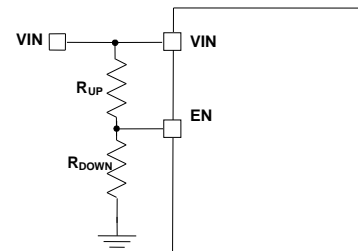

Figure 10: Adjustable UVLO Using EN Divider

The UVLO rising and falling thresholds can be calculated with Equation (13) and Equation (14), respectively:

$$INUV_{RISING} = \left(1 + \frac{R_{UP}}{R_{DOWN}}\right) \times V_{EN_RISING} \quad (13)$$

$$INUV_{FALLING} = \left(1 + \frac{R_{UP}}{R_{DOWN}}\right) \times V_{EN_FALLING} \quad (14)$$

Where V_{EN_RISING} is 1V, and V_{EN_FALLING} is 0.85V.

PCB Layout Guidelines ⁽⁹⁾

Efficient PCB layout, especially input capacitor placement, is critical for stable operation. A 4-layer layout is strongly recommended to improve thermal performance. For the best results, refer to Figure 11 and follow the guidelines below:

1. Place the symmetric input capacitors as close to VIN and GND as possible.
2. Use a large ground plane to connect directly to PGND.
3. Add vias near PGND if the bottom layer is a ground plane.
4. Ensure that the high-current paths at GND and VIN have short, direct, and wide traces.
5. Place the ceramic input capacitor, as well as the small package size (0603) input bypass capacitor, as close to VIN and PGND as possible to minimize high-frequency noise.
6. Keep the connection between the input capacitor and VIN as short and wide as possible.
7. Place the VCC capacitor as close to VCC and GND as possible.
8. Route SW and BST away from sensitive analog areas, such as FB.
9. Place the feedback resistors close to the chip to ensure the trace that connects to FB is as short as possible.
10. Use multiple vias to connect the power planes to the internal layers.

Note:

9) The recommended PCB layout is based on Figure 12.

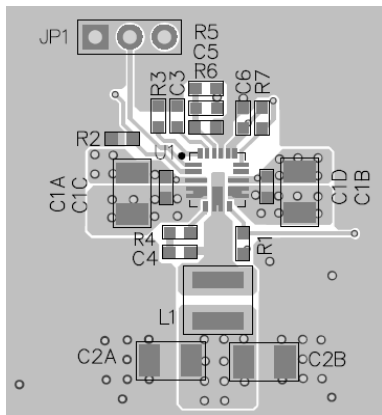

Top Layer

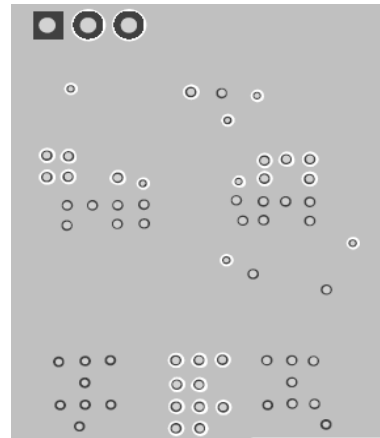

Inner Layer 1

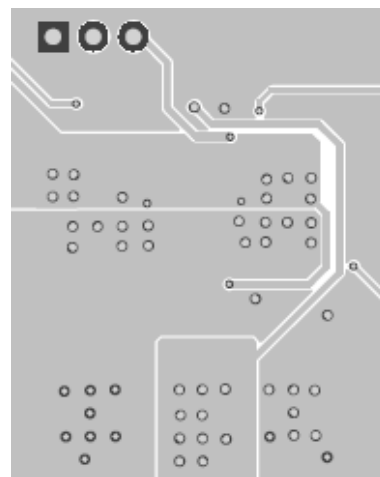

Inner Layer 2

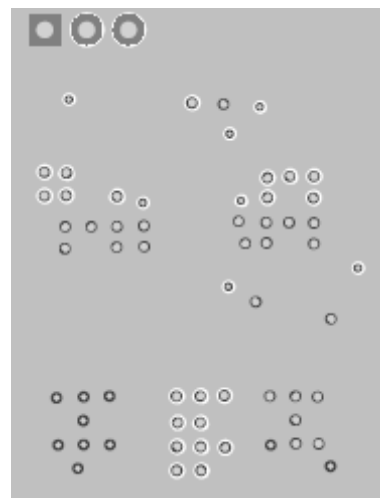

Bottom Layer

Figure 11: Recommended PCB Layout

TYPICAL APPLICATION

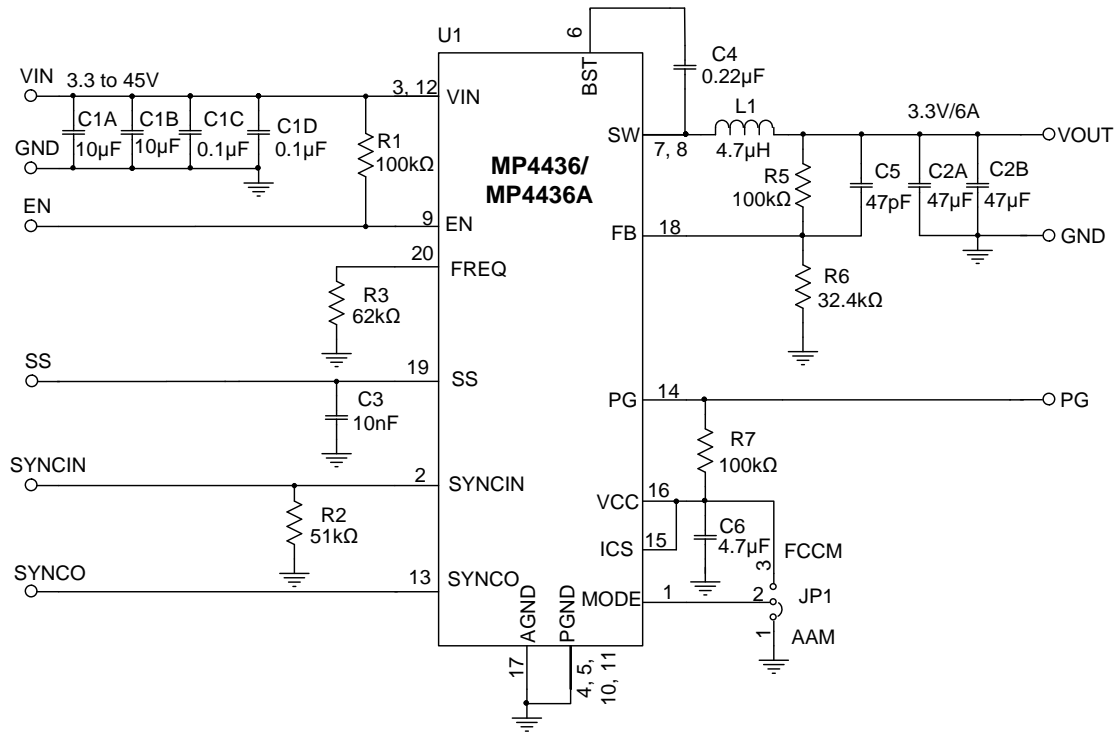

Figure 12: Single-Phase, V_{OUT} = 3.3V, f_{sw} = 470kHz

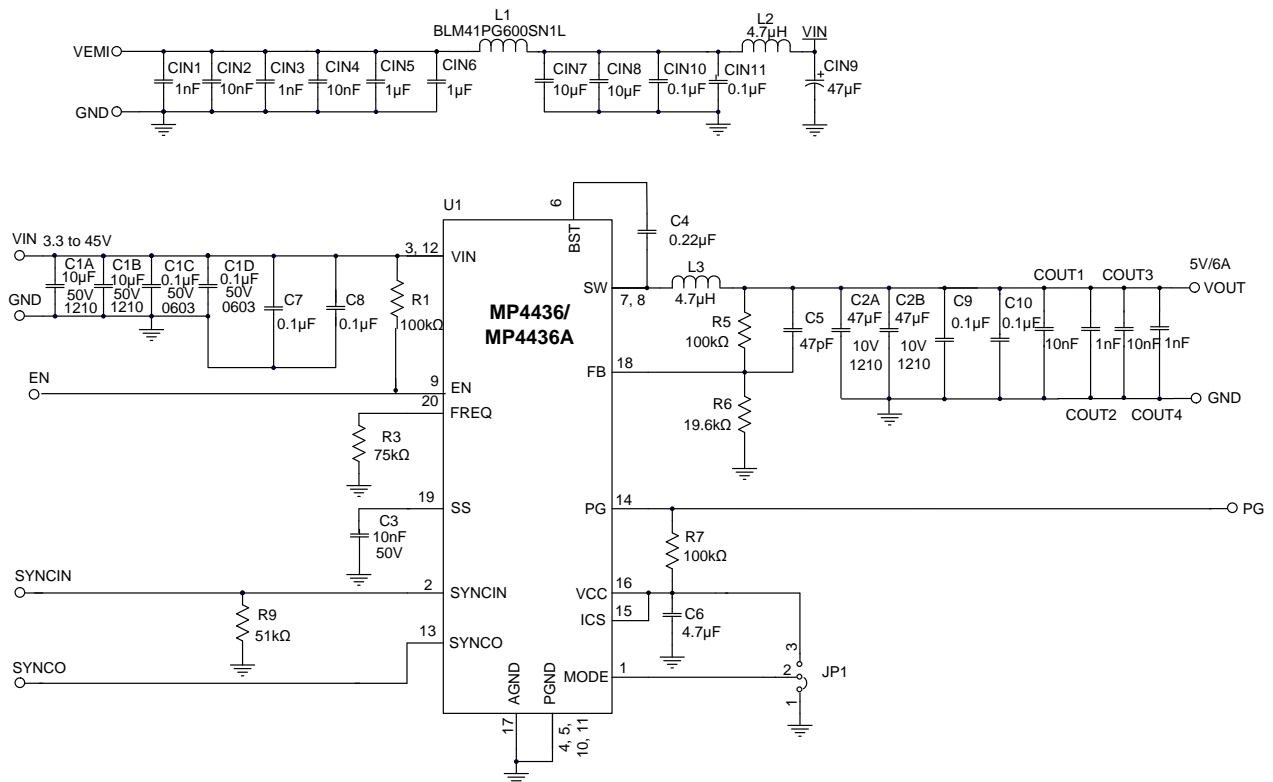

Figure 13: V_{OUT} = 5V, f_{sw} = 410kHz with EMI Filters

TYPICAL APPLICATION (continued)

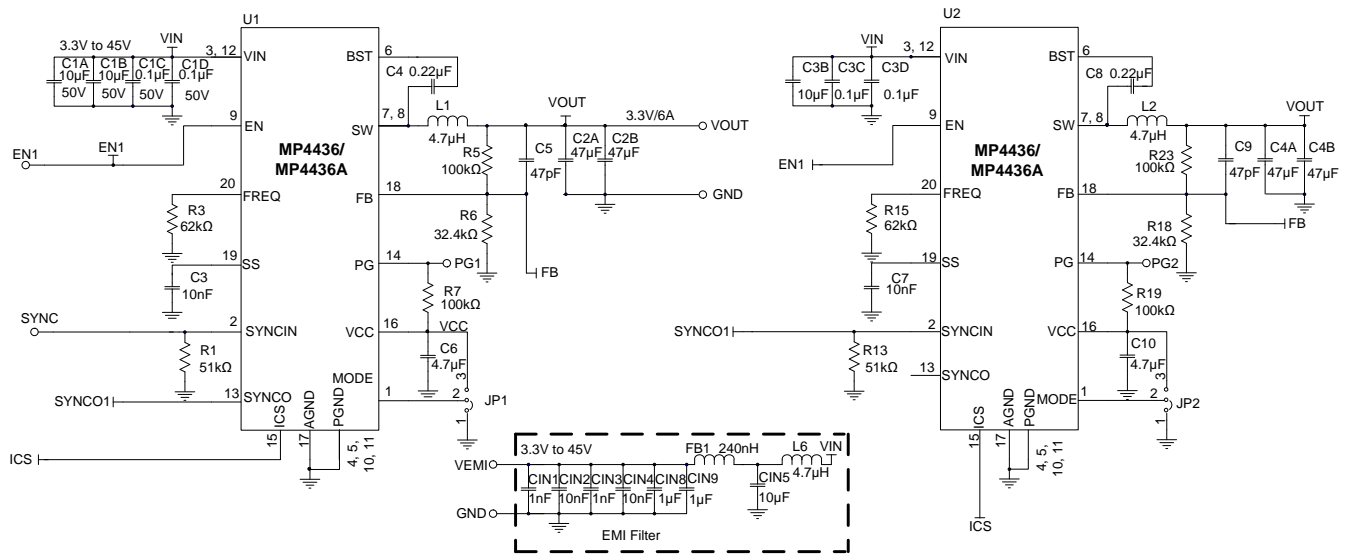

Figure 14: Dual-Phase, V_{OUT} = 3.3V, f_{sw} = 470kHz

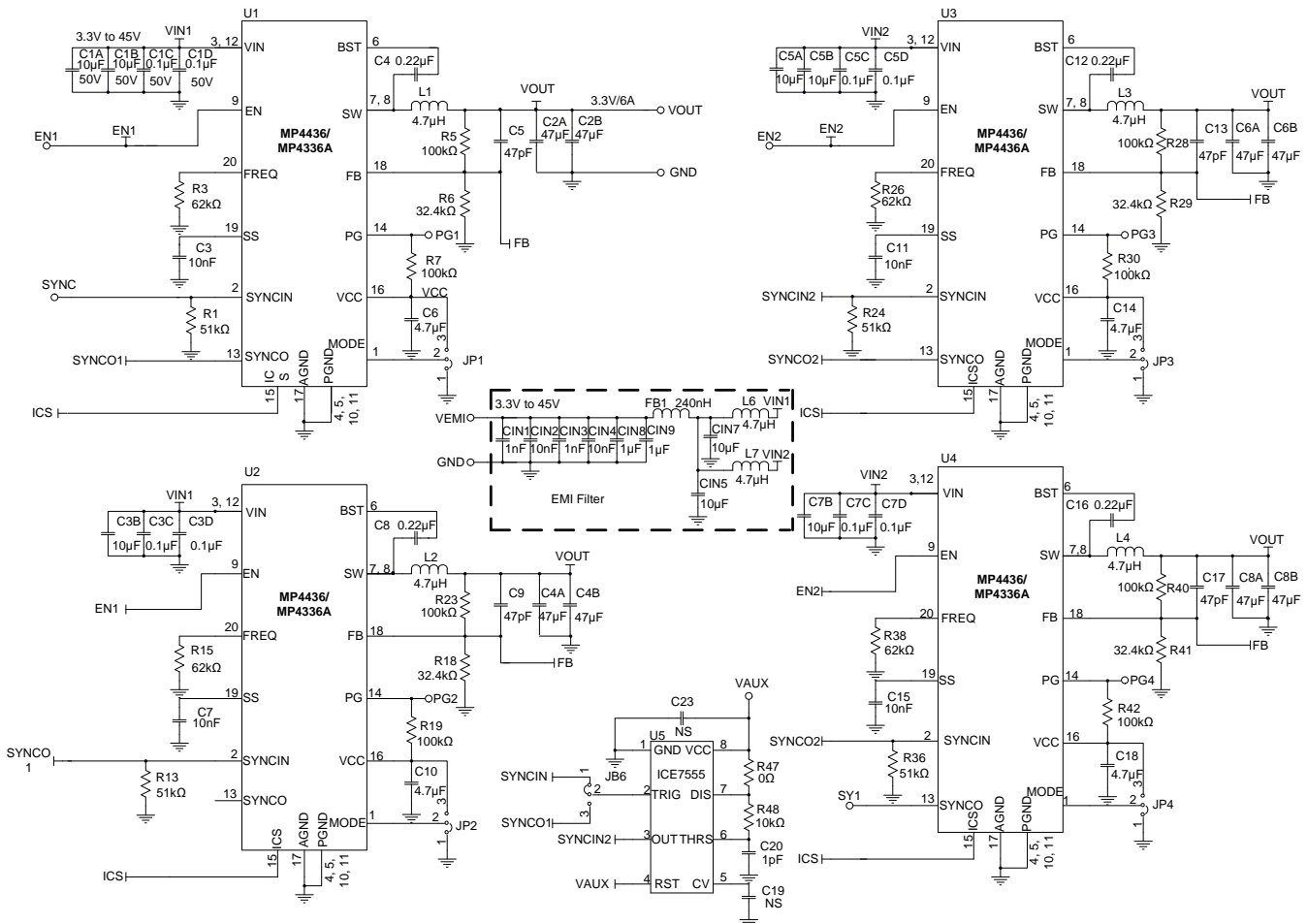
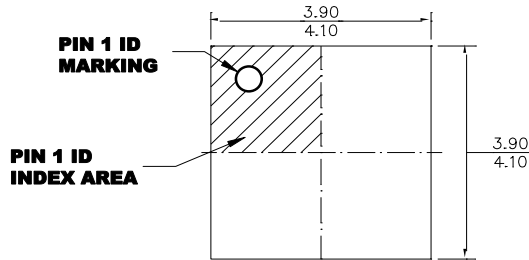

Figure 15: Four-Phase, V_{OUT} = 3.3V, f_{sw} = 470kHz

PACKAGE INFORMATION

QFN-20 (4mmx4mm)



TOP VIEW

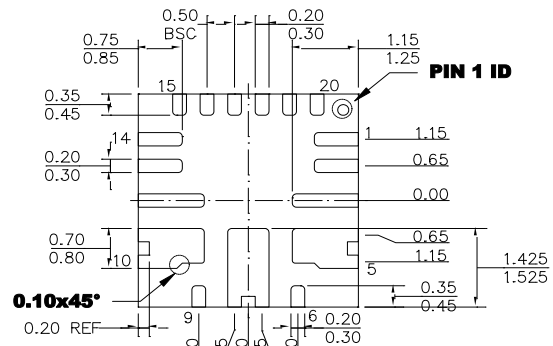

BOTTOM VIEW

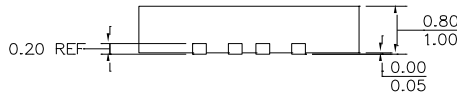

SIDE VIEW

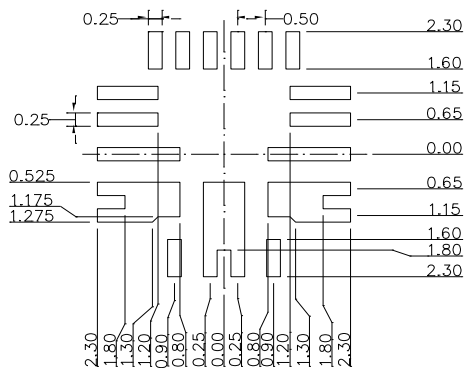

RECOMMENDED LAND PATTERN

NOTE:

- 1) ALL DIMENSIONS ARE IN MILLIMETERS.
- 2) LEAD COPLANARITY SHALL BE 0.80 MILLIMETERS MAX.
- 3) JEDEC REFERENCE IS MO-220.
- 4) DRAWING IS NOT TO SCALE.

CARRIER INFORMATION

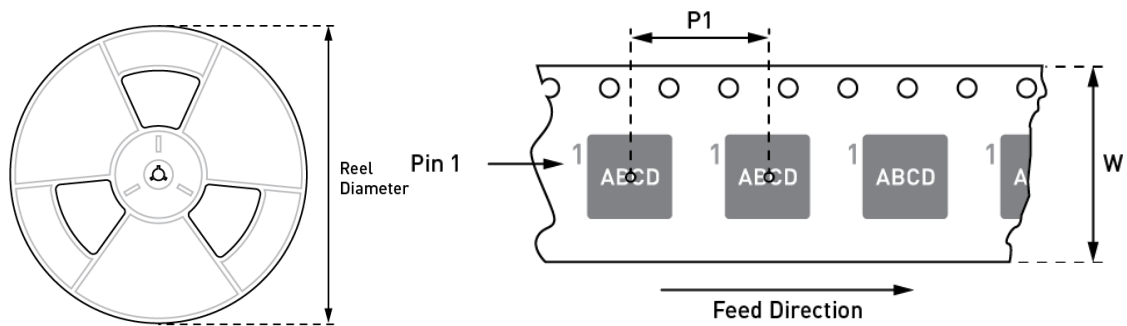

Part Number	Package Description	Quantity/ Reel	Quantity/ Tube	Reel Diameter	Carrier Tape Width	Carrier Tape Pitch
MP4436GR-Z	QFN-20 (4mmx4mm)	5000	N/A	13in	12mm	8mm
MP4436AGR-Z						

Revision History

Revision #	Revision Date	Description	Pages Updated
1.0	8/24/2020	Initial Release	-

Notice: The information in this document is subject to change without notice. Please contact MPS for current specifications. Users should warrant and guarantee that third-party Intellectual Property rights are not infringed upon when integrating MPS products into any application. MPS will not assume any legal responsibility for any said applications.

X-ON Electronics

Largest Supplier of Electrical and Electronic Components

Click to view similar products for [Switching Voltage Regulators](#) category:

Click to view products by [Monolithic Power Systems](#) manufacturer:

Other Similar products are found below :

[FAN53610AUC33X](#) [FAN53611AUC123X](#) [EN6310QA](#) [160215](#) [R3](#) [KE177614](#) [FAN53611AUC12X](#) [MAX809TTR](#) [NCV891234MW50R2G](#)
[AST1S31PUR](#) [NCP81203PMNTXG](#) [NCP81208MNTXG](#) [PCA9412AUKZ](#) [NCP81109GMNTXG](#) [NCP3235MNTXG](#) [NCP81109JMNTXG](#)
[NCP81241MNTXG](#) [NTE7223](#) [NTE7222](#) [NTE7224](#) [L6986FTR](#) [MPQ4481GU-AEC1-P](#) [MP8756GD-P](#) [MPQ2171GJ-P](#) [MPQ2171GJ-AEC1-P](#)
[N JW4153U2-A-TE2](#) [MP2171GJ-P](#) [MP28160GC-Z](#) [MPM3509GQVE-AEC1-P](#) [XDPE132G5CG000XUMA1](#) [LM60440AQRPKRQ1](#)
[MP5461GC-P](#) [IW673-20](#) [MPQ4409GQBE-AEC1-P](#) [S-19903DA-A8T1U7](#) [S-19903CA-A6T8U7](#) [S-19903CA-S8T1U7](#) [S-19902BA-A6T8U7](#)
[S-19902CA-A6T8U7](#) [S-19902AA-A6T8U7](#) [S-19903AA-A6T8U7](#) [S-19902AA-S8T1U7](#) [S-19902BA-A8T1U7](#) [AU8310](#)
[LMR23615QDRRRQ1](#) [LMR33630APAQRN XRQ1](#) [LMR33630APCQRN XRQ1](#) [LMR36503R5RPER](#) [LMR36503RFRPER](#)
[LMR36503RS3QRPERQ1](#)