

DESCRIPTION

The MP4689 is a high voltage input step-down switching regulator to deliver a constant current of up to 1A to high power LEDs. It integrates a high-side high voltage power MOSFET with a current limit of 2.9A (typical value). The wide 4.5V to 100V input range accommodates a variety of step-down applications, making it ideal for automotive, industrial and general lighting applications. Hysteresis current mode control is applied for very fast response, which makes the 20kHz dimming frequency possible. MPS's proprietary feedback control scheme minimizes the number of external components while delivering a LED current with typical $\pm 3\%$ accuracy.

The switching frequency is up to 1MHz, thus allowing for small component size. The thermal shut down and short circuit protection provide reliable, fault tolerant operations. A 170 μ A quiescent current allows its use in battery-powered applications.

The MP4689 is available in SOIC8 with exposed pad package.

FEATURES

- Wide 4.5V to 100V Operating Input Range
- No Output Capacitor Required
- $\pm 3\%$ LED Current Accuracy
- Hysteretic Control: No Compensation
- Up to 1MHz Switching Frequency
- Up to 20kHz Dimming Frequency
- Dedicated PWM Dimming Control Input
- Short Circuit Protection with Integrated High Side MOSFET
- Thermal Shut Down
- 200mV Reference Voltage for High Efficiency
- Up to 95% Efficiency
- 170 μ A Quiescent Current
- Available in SOIC-8 with Exposed Pad Package

APPLICATIONS

- High Power LED Driver
- Automotive, Industry and General Lighting
- Constant Current Source

All MPS parts are lead-free and adhere to the RoHS directive. For MPS green status, please visit MPS website under Quality Assurance.

"MPS" and "The Future of Analog IC Technology" are Registered Trademarks of Monolithic Power Systems, Inc.

TYPICAL APPLICATION

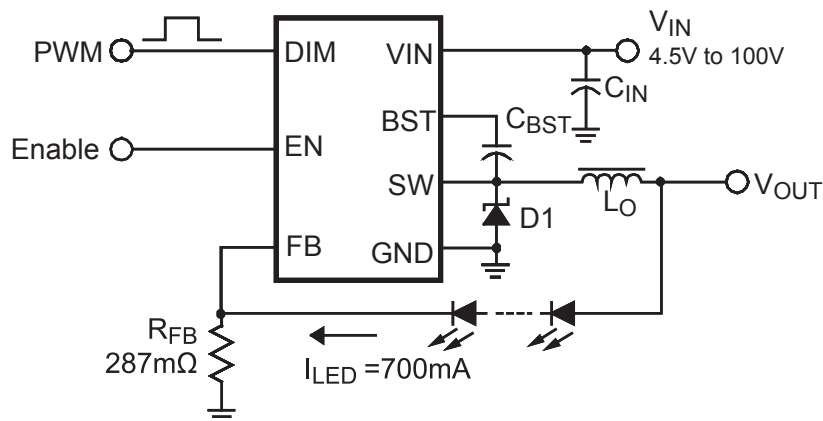

ORDERING INFORMATION

Part Number*	Package	Top Marking
MP4689DN	SOIC-8 EP	MP4689

* For Tape & Reel, add suffix -Z (e.g. MP4689DN-Z);
For RoHS compliant packaging, add suffix -LF (e.g. MP4689DN-LF-Z)

PACKAGE REFERENCE

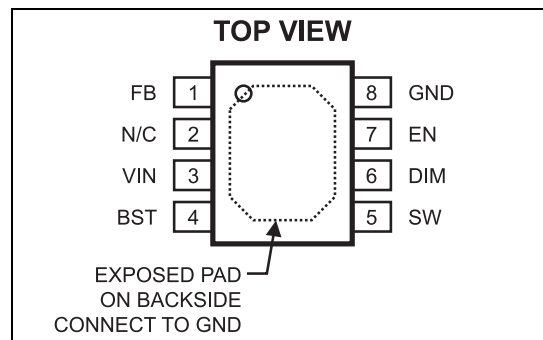

ABSOLUTE MAXIMUM RATINGS ⁽¹⁾

Supply Voltage (V_{IN})	-0.3V to +100V
Switch Voltage (V_{SW})	-0.5V to $V_{IN} + 0.5V$
BST to SW	-0.3V to +6V
All Other Pins	-0.3V to +6V
Junction Temperature	150°C
Continuous Power Dissipation ($T_A = +25^\circ C$) ⁽²⁾	2.5W
Lead Temperature	260°C
Storage Temperature	-65°C to +150°C

Recommended Operating Conditions ⁽³⁾

Supply Voltage V_{IN}	4.5V to 95V
EN and DIM Voltages	0V to 5V
Operating Junction Temp. (T_J)	-40°C to +125°C

Thermal Resistance ⁽⁴⁾	θ_{JA}	θ_{JC}
SOIC-8 EP	50	10... °C/W

Notes:

- Exceeding these ratings may damage the device.
- The maximum allowable power dissipation is a function of the maximum junction temperature $T_J(MAX)$, the junction-to-ambient thermal resistance θ_{JA} , and the ambient temperature T_A . The maximum allowable continuous power dissipation at any ambient temperature is calculated by $P_D(MAX) = (T_J(MAX) - T_A) / \theta_{JA}$. Exceeding the maximum allowable power dissipation will cause excessive die temperature, and the regulator will go into thermal shutdown. Internal thermal shutdown circuitry protects the device from permanent damage.
- The device is not guaranteed to function outside of its operating conditions.
- Measured on JESD51-7 4-layer board.

ELECTRICAL CHARACTERISTICS

$V_{IN} = 60V$, $T_A = +25^{\circ}C$, unless otherwise noted.

Specifications over temperature are guaranteed by design and characterization.

Parameter	Symbol	Condition	Min	Typ	Max	Units
VIN UVLO Threshold			3.6	4.0	4.35	V
VIN UVLO Hysteresis				0.4		V
Shutdown Supply Current		$V_{EN} = 0V$		2	5	μA
Quiescent Supply Current		No load, $V_{FB} = 250mV$		170	240	μA
Upper Switch On Resistance ⁽⁵⁾	$R_{DS(ON)}$	$V_{BST} - V_{SW} = 5V$		500		$m\Omega$
Upper Switch Leakage Current	I_{SWLK}	$V_{EN} = 0V$, $V_{SW} = 0V$		0.01	1	μA
Current Limit	I_{PK}	$V_{FB} = 0.15V$	2.1	2.9		A
EN Up Threshold	V_{ENH}		1.4	1.55	1.7	V
EN Threshold Hysteresis	V_{ENHY}			320		mV
EN Input Current	I_{ENI}	$V_{EN} = 5V$		0.01	1	μA
EN Sinking Current	I_{ENS}	$V_{EN} = 2V$		2	3	μA
DIM Up Threshold	V_{DIMH}		0.8	1.15	1.5	V
DIM Threshold Hysteresis	V_{DIMHY}			300		mV
DIM Input Current	I_{DIM}	$V_{DIM} = 5V$ or $0V$	-1		1	μA
DIM On Propagation Delay	T_{DIMDH}	$V_{FB} = 0V$, V_{DIM} Rising edge to V_{SW} Rising Edge		50		ns
DIM Off Propagation Delay	T_{DIMDL}	$V_{FB} = 0V$, V_{DIM} Falling edge to V_{SW} Falling Edge		50		ns
Feedback Voltage Threshold High ⁽⁵⁾	V_{FBH}	$4.5V < V_{IN} < 95V$, V_{FB} rising from $0V$ until $V_{SW} < 30V$	209	215	221	mV
Feedback Voltage Threshold Low ⁽⁵⁾	V_{FBL}	$4.5V < V_{IN} < 95V$, V_{FB} falling from $0.25V$ until $V_{SW} > 30V$	179	185	191	mV
FB Pin Input Current	I_{FB}	$V_{FB} = 5V$ or $0V$	-300		300	nA
FB Propagation Delay to Output High	T_{FBDH}	Falling edge of V_{FB} from $0.25V$ to $0V$ to V_{SW} rising edge		100		ns
FB Propagation Delay to Output High	T_{FBDL}	Rising edge of V_{FB} from $0V$ to $0.25V$ to V_{SW} falling edge		100		ns
Thermal Shutdown		Hysteresis = $20^{\circ}C$		150		$^{\circ}C$

Note:

5) Guaranteed by design.

PIN FUNCTIONS

SOIC8E Pin #	Name	Description
1	FB	Feedback. This is the input to hysteretic comparators. An external current sensing resistor is connected in series with the LEDs to GND. The feedback voltage is connected to this pin and is regulated at +200mV with 15% current ripple.
2	N/C	Not connected
3	VIN	Input Supply. This supplies power to all the internal control circuitry, both BS regulators and the high-side switch. A decoupling capacitor to ground must be placed close to this pin to minimize switching spikes.
4	BST	Bootstrap. This is the positive power supply for the internal floating high-side MOSFET driver. Connect a bypass capacitor between this pin and SW pin.
5	SW	Switch Node. This is the output from the high-side switch. A low V_F Schottky rectifier to ground is required. The rectifier must be close to the SW pins to reduce switching spikes.
6	DIM	PWM Dimming Input. Pulling this pin below the specified threshold for dimming off. Pulling it up above the specified threshold for dimming on. If there is no need for dimming function, connect DIM and EN pins together.
7	EN	Enable Input. Pulling this pin below the specified threshold shuts the chip down. Pulling it up above the specified threshold or leaving it floating enables the chip.
8	GND, Exposed pad	Ground. It should be connected as close as possible to the output capacitor avoiding the high current switch paths. Connect exposed pad to GND plane for optimal thermal performance.

BLOCK DIAGRAM

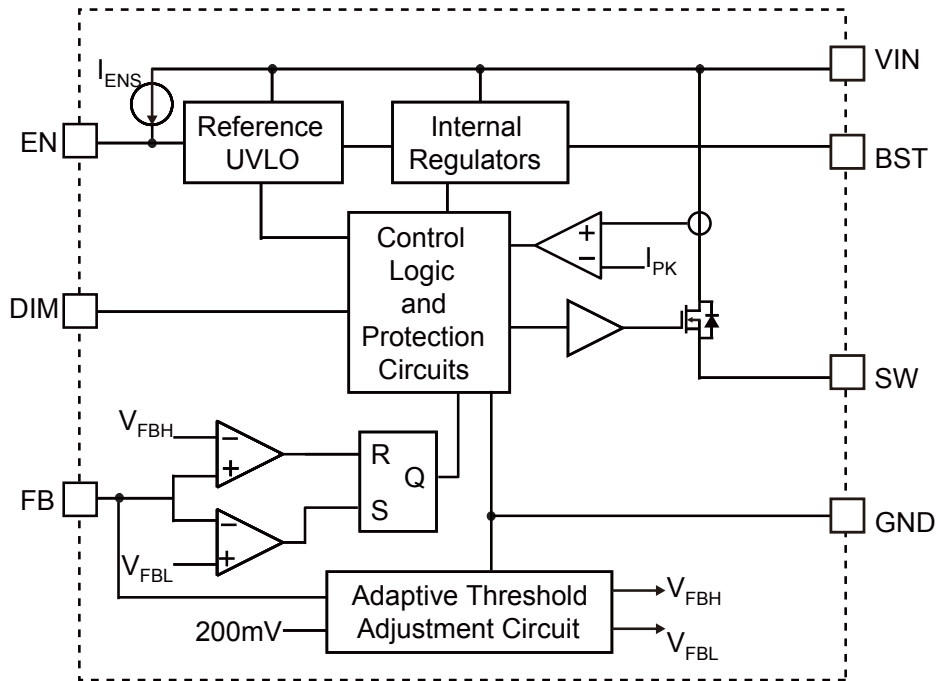
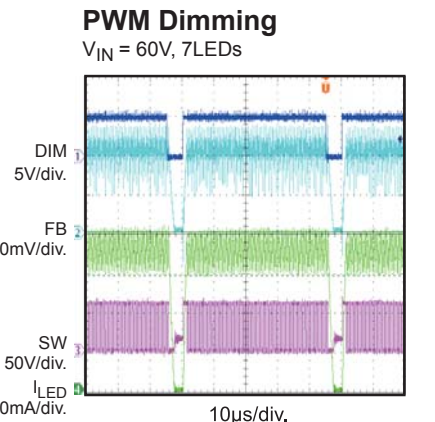
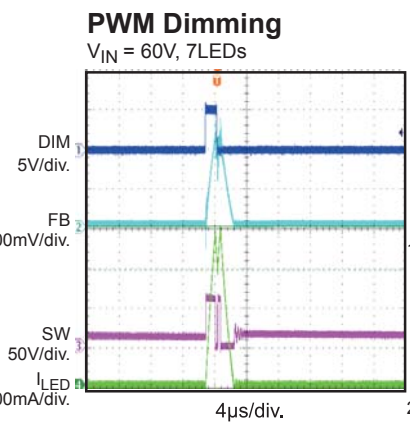
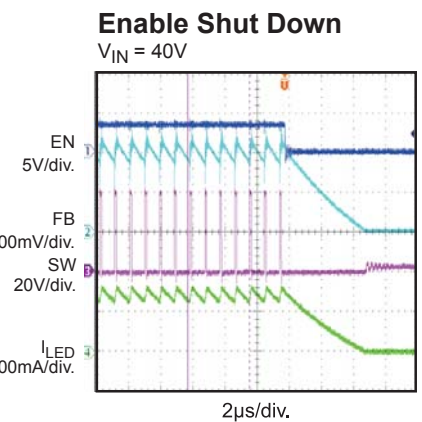
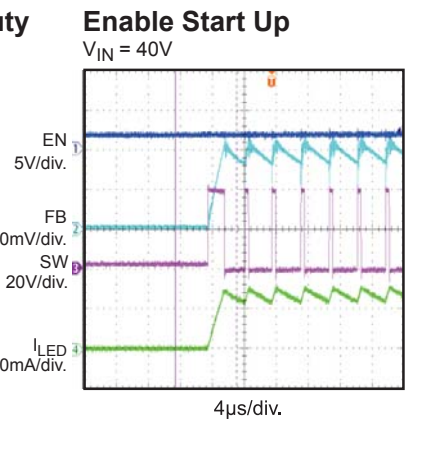
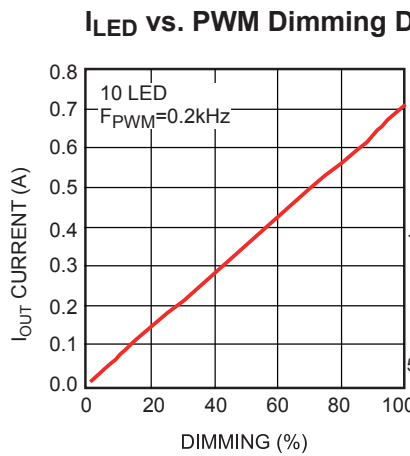
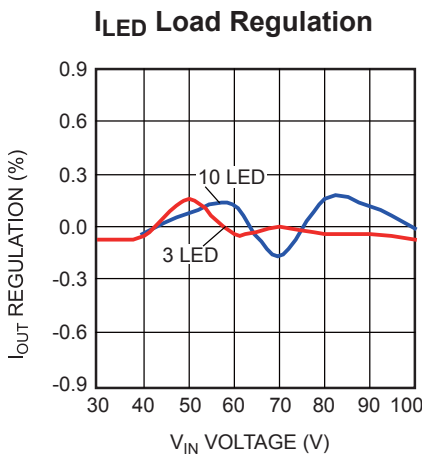
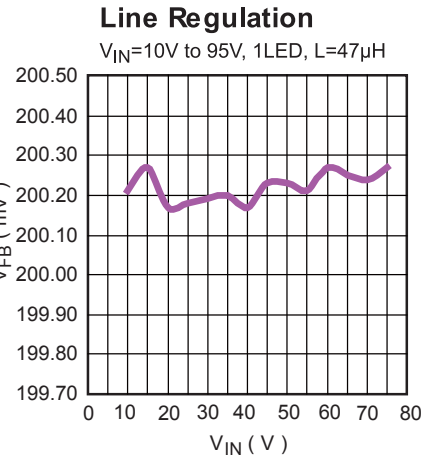
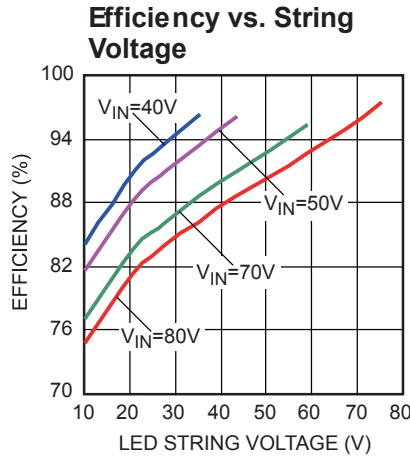
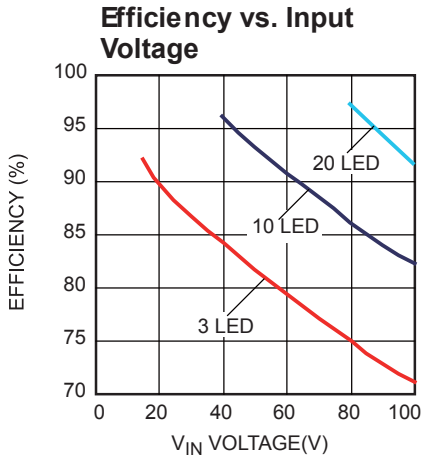

Figure 1—Function Block Diagram

TYPICAL PERFORMANCE CHARACTERISTICS

L=47μH, 1 LED Load, T_A=25 °C, unless otherwise noted.



OPERATION

Hysteresis Current Control with Adaptive Threshold Adjustment

MP4689 operates in a hysteresis current control mode to regulate the LED current accurately. FB pin is the sensed voltage of LED current across the sensing resistor. The power MOSFET is turned on and remains on until FB pin rises to 215mV. The power MOSFET is turned off and remains off until FB pin falls to 185mV. The two thresholds of 215mV and 185mV are adaptive adjusted to compensate all the circuit delays so that the LED current is regulated very accurately with 200mV average value at FB pin.

Enable Control

The MP4689 has a dedicated enable control pin (EN) with the positive logic. Its falling threshold is a precision 1.2V, and its rising threshold is 1.5V (300mV higher).

When floating, EN is pulled up to about 3.0V by an internal 1 μ A current source so it is enabled. To pull it down, over 1 μ A current capability is needed.

Floating Driver and Bootstrap Charging

The floating power MOSFET driver is powered by an external bootstrap capacitor. This floating driver has its own UVLO protection. This UVLO's rising threshold is 2.2V with a threshold of 150mV.

The bootstrap capacitor is charged and regulated to about 5V by the dedicated internal bootstrap regulator.

In case the internal circuit does not have sufficient voltage and the bootstrap capacitor is not well charged, extra external circuitry can be used to ensure the bootstrap voltage is in the normal operational region. Refer to *External Bootstrap Diode* in Application section.

Under-Voltage Lockout (UVLO)

Under-voltage lockout (UVLO) is implemented to protect the chip from operating at insufficient supply voltage. The UVLO rising threshold is about 4.0V while its falling threshold is a consistent 3.65V.

Thermal Shutdown

Thermal shutdown is implemented to prevent the chip from operating at exceedingly high temperatures. When the silicon die temperature is higher than its upper threshold, it shuts down the whole chip. When the temperature is lower than its lower threshold, the chip is enabled again.

LED Short Protection

The LED current is well regulated with FB pin voltage at 200mV. As long as the LED sensing resistor is not failed, the output current is within limitation. If the LED sensing resistor is failed or the output is shorted to GND directly, the FB pin voltage is low even the power MOSFET is turned on. The power MOSFET will be shut off if such failure time is longer than 10 μ s. MP4689 will retry the operation after about 300 μ s delay.

The power MOSFET current is also accurately sensed via a current sense MOSFET. If the current is over 2.9A, the IC is shut down. This offers extra protection under output short conditions.

APPLICATION INFORMATION

COMPONENT SELECTION

Setting the LED Current

The LED current I_{LED} is set using a sensing resistor R_{FB} , which is in series with the LEDs and connected to GND. The voltage on the sensing resistor R_{FB} is connected to FB pin.

$$I_{LED} = \frac{V_{FB}}{R_{FB}}$$

For example, for a 700mA LED current, R_{FB} is 287mΩ.

Inductor Selection and Frequency Setting

The inductor L_O is required to supply a constant current to the LED. The inductor value is related to the switching frequency f_s setting:

$$f_s = \frac{V_{OUT} \cdot (V_{IN} - V_{OUT})}{V_{IN} \cdot (8 \cdot 10^{-8} \cdot V_{IN} + L \cdot 15\% \cdot I_{LED})}$$

Where, V_{IN} is the input voltage, V_{OUT} is the output voltage to drive the LEDs. A larger value inductor will result in smaller switching frequency.

The peak inductor current is about:

$$I_{LP} = I_{LED} \cdot \left(\frac{4 \cdot 10^{-8} \cdot V_{IN}}{L \cdot I_{LED}} + 1.075 \right)$$

Choose an inductor that will not saturate under the maximum inductor peak current and the switching frequency under 2MHz.

Output Rectifier Diode

The output rectifier diode supplies the current to the inductor when the high-side switch is off. To reduce losses due to the diode forward voltage and recovery times, use a Schottky diode.

The RMS current through the diode is about:

$$I_D = I_{LED} \cdot \sqrt{1 - \frac{V_{OUT}}{V_{IN}}}$$

Choose a diode whose maximum reverse voltage rating is greater than the maximum input voltage, and whose current rating is greater than the maximum diode current.

Input Capacitor C_{IN}

The input current to the step-down converter is discontinuous, therefore a capacitor is required to supply the AC current to the step-down converter while maintaining the DC input voltage. Use low ESR capacitors for the best performance especially under high switching frequency applications.

The RMS current through the input capacitor is about:

$$I_D = I_{LED} \cdot \sqrt{\frac{V_{OUT}}{V_{IN}}}$$

With low ESR capacitors, the input voltage ripple can be estimated by:

$$\Delta V_{IN} = \frac{I_{LED}}{f_s \times C_{IN}} \times \frac{V_{OUT}}{V_{IN}} \times \left(1 - \frac{V_{OUT}}{V_{IN}} \right)$$

Choose the input capacitor with enough RMS current rating and enough capacitance for small input voltage ripple.

When electrolytic or tantalum capacitors are applied, a small, high quality ceramic capacitor, i.e. 0.1μF, should be placed as close to the IC as possible.

Output Capacitor C_{OUT}

The output capacitor (C_{OUT}) is not necessary for MP4689. The LED current ripple (peak-to-peak value) is about 15% of the LED DC current. Output capacitor can be used to further reduce the LED current ripple. Low ESR capacitors are preferred to keep the output voltage ripple low so that the AC ripple current through the LEDs is small. The output voltage ripple can be estimated by:

$$\Delta V_{OUT} = \frac{V_{OUT}}{f_s \times L_O} \times \left(1 - \frac{V_{OUT}}{V_{IN}} \right) \times \left(R_{ESR} + \frac{1}{8 \times f_s \times C_{OUT}} \right)$$

Where R_{ESR} is the equivalent series resistance (ESR) value of the output capacitor.

External Bootstrap Diode

An external bootstrap diode may enhance the efficiency of the LED driver. In below cases, an external BST diode is recommended from the 5V to BST pin:

- There is a 5V rail available in the system;
- VIN is no greater than 5V;
- VOUT is between 3.3V and 5V;

This diode is also recommended for high duty cycle operation (when $V_{OUT}/V_{IN} > 65\%$) and very high frequency (over 1.5MHz) applications.

The bootstrap diode can be a low cost one such as IN4148 or BAT54.

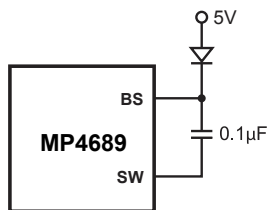

Figure 2—External Bootstrap Diode

Layout Consideration

It is essential to place the input decoupling capacitor, catch diode and the MP4689 (VIN pin, SW pin and PGND) as close as possible, with traces that are very short and fairly wide. This can help to greatly reduce the voltage spike on SW node, and lower the EMI noise level as well.

Try to run the feedback trace as far from the inductor and noisy power traces as possible. It is often a good idea to run the feedback trace on the side of the PCB opposite of the inductor with a ground plane separating the two.

To help to improve the thermal conduction, a grid of thermal vias can be created right under the exposed pad. It is recommended that they be small (15mil barrel diameter) so that the hole is essentially filled up during the plating process, thus aiding conduction to the other side. Too large a hole can cause 'solder wicking' problems during the reflow soldering process. The pitch (distance between the centers) of several such thermal vias in an area is typically 40mil.

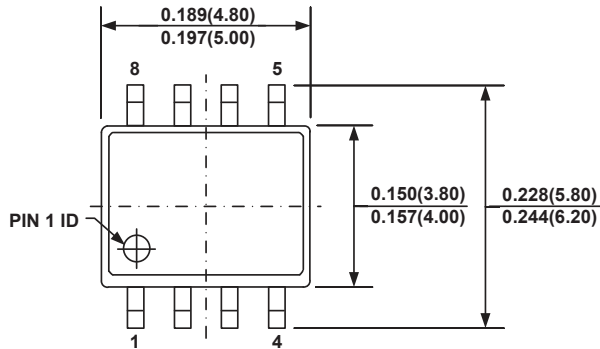
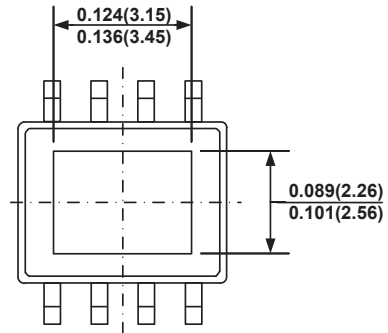
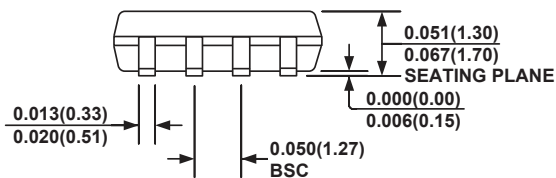
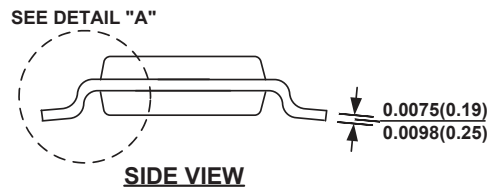
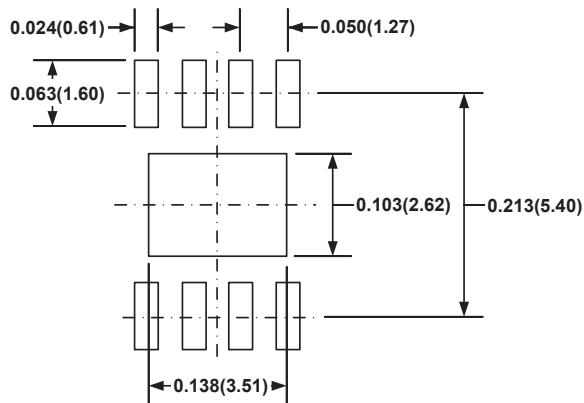
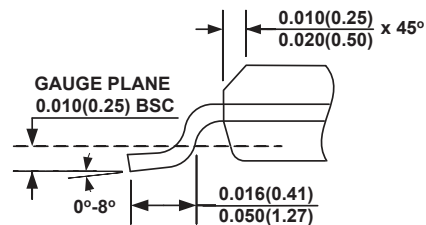
PACKAGE INFORMATION
SOIC-8 EP

TOP VIEW

BOTTOM VIEW

FRONT VIEW

SIDE VIEW

RECOMMENDED LAND PATTERN

DETAIL "A"
NOTE:

- 1) CONTROL DIMENSION IS IN INCHES. DIMENSION IN BRACKET IS IN MILLIMETERS.
- 2) PACKAGE LENGTH DOES NOT INCLUDE MOLD FLASH, PROTRUSIONS OR GATE BURRS.
- 3) PACKAGE WIDTH DOES NOT INCLUDE INTERLEAD FLASH OR PROTRUSIONS.
- 4) LEAD COPLANARITY (BOTTOM OF LEADS AFTER FORMING) SHALL BE 0.004" INCHES MAX.
- 5) DRAWING CONFORMS TO JEDEC MS-012, VARIATION BA.
- 6) DRAWING IS NOT TO SCALE.

NOTICE: The information in this document is subject to change without notice. Users should warrant and guarantee that third party Intellectual Property rights are not infringed upon when integrating MPS products into any application. MPS will not assume any legal responsibility for any said applications.

X-ON Electronics

Largest Supplier of Electrical and Electronic Components

Click to view similar products for [LED Lighting Drivers](#) category:

Click to view products by [Monolithic Power Systems](#) manufacturer:

Other Similar products are found below :

[LV5235V-MPB-H](#) [MB39C602PNF-G-JNEFE1](#) [MIC2871YMK-T5](#) [AL1676-10BS7-13](#) [AL1676-20AS7-13](#) [AP5726WUG-7](#) [ICL8201](#)
[IS31BL3228B-UTLS2-TR](#) [IS31BL3506B-TTLS2-TR](#) [AL3157F-7](#) [AP5725FDCG-7](#) [AP5726FDCG-7](#) [LV52204MTTBG](#) [AP5725WUG-7](#)
[STP4CMPQTR](#) [NCL30086BDR2G](#) [CAT4004BHU2-GT3](#) [LV52207AXA-VH](#) [AP1694AS-13](#) [TLE4242EJ](#) [AS3688](#) [IS31LT3172-GRLS4-TR](#)
[TLD2311EL](#) [KTD2694EDQ-TR](#) [KTZ8864EJAA-TR](#) [IS32LT3174-GRLA3-TR](#) [ZXLD1374QESTTC](#) [MP2488DN-LF-Z](#) [NLM0010XTSA1](#)
[AL1676-20BS7-13](#) [ZXLD1370QESTTC](#) [MPQ7220GF-AEC1-P](#) [MPQ7220GR-AEC1-P](#) [MPQ4425BGJ-AEC1-P](#) [MPQ7220GF-AEC1-Z](#)
[MPQ7220GR-AEC1-Z](#) [MPQ4425BGJ-AEC1-Z](#) [NCL30486A2DR2G](#) [IS31FL3737B-QFLS4-TR](#) [IS31FL3239-QFLS4-TR](#) [KTD2058EUAC-](#)
[TR](#) [KTD2037EWE-TR](#) [DIO5662ST6](#) [IS31BL3508A-TTLS2-TR](#) [MAX20052CATC/V+](#) [MAX25606AUP/V+](#) [BD6586MUV-E2](#)
[BD9206EFV-E2](#) [BD9416FS-E2](#) [LYT4227E](#)