

### DESCRIPTION

The MP5087 is a load switch to provide 7A load protection covering 0.5V to 5.5V voltage range. With the small  $R_{DS(ON)}$  in tiny package, MP5087 provides very high efficient and space saving solution in notebook and tablet or other portable devices application.

The MP5087 equipped with the very accurate current monitor function. The gain of the current monitor can be scaled to different applications. With the soft start function, the MP5087 can avoid inrush current during circuit start up. MP5087 also provides different functions, like programmable soft start time, output discharge function, OCP and thermal shutdown features.

Tiny QFN-12 (2mmx2mm) of MP5087 is available in space saving package.

### FEATURES

- Large  $V_{IN}$  Range from 0.5V to 5.5V
- $<1\mu A$  Shutdown Current
- Integrated 10m $\Omega$  Low  $R_{DS(ON)}$  FETs
- Typical 7A Load Current Range
- Output Current Monitoring Accurate High to 3%
- Push Pull PG Indicator
- Adjustable Start Up Slew Rate
- Output Discharge Function
- $<200ns$  Short-Circuitry Response Protection
- Thermal Protection
- Small QFN-12 (2mmx2mm) Package for Space Saving
- Safety approvals
  - UL2361, file no. 20150402-E322138

### APPLICATIONS

- Notebook and Tablet Computers
- Portable Devices
- Solid State Drivers
- Handheld Devices

All MPS parts are lead-free and adhere to the RoHS directive. For MPS green status, please visit MPS website under Quality Assurance.

"MPS" and "The Future of Analog IC Technology" are Registered Trademarks of Monolithic Power Systems, Inc.

### TYPICAL APPLICATION

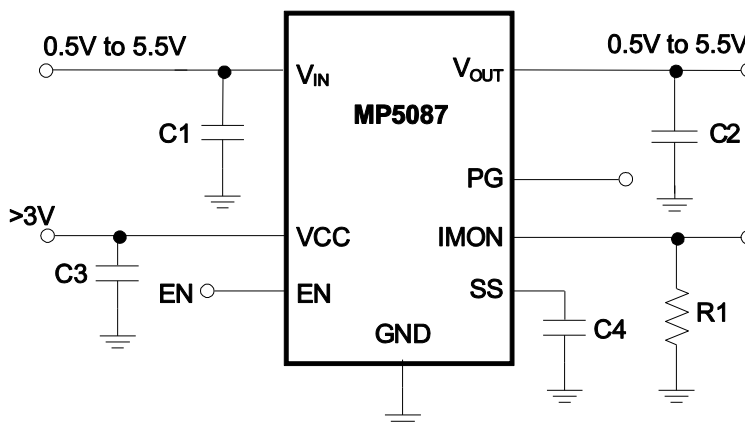

### ORDERING INFORMATION

| Part Number* | Package          | Top Marking |
|--------------|------------------|-------------|
| MP5087GG     | QFN-12 (2mmx2mm) | See Blow    |

\* For Tape & Reel, add suffix -Z (e.g. MP5087GG-Z);

### TOP MARKING

───  
**BDY**  
**LLL**

BD: product code of MP5087GG;  
 Y: year code;  
 LLL: lot number;

### PACKAGE REFERENCE

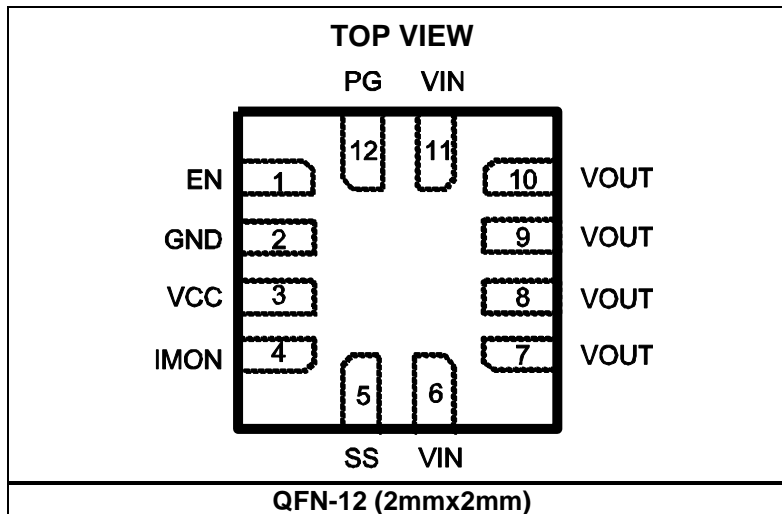

**ABSOLUTE MAXIMUM RATINGS** <sup>(1)</sup>

|   |                                 |
|---|---------------------------------|
| V <sub>IN</sub> .....                       | -0.3V to +6.5V                  |
| V <sub>CC</sub> .....                       | -0.3V to +6.5V                  |
| V <sub>OUT</sub> .....                      | -0.3V to +6.5V                  |
| EN, SS, IMON .....                          | -0.3V to V <sub>CC</sub> +0.3 V |
| Junction Temperature.....                   | 150°C                           |
| Lead Temperature .....                      | 260°C                           |
| Continuous Power Dissipation <sup>(2)</sup> |                                 |
| QFN-12 (2mmx2mm).....                       | 1.6W                            |

**Recommended Operating Conditions** <sup>(3)</sup>

|                                       |                 |
|---------------------------------------|-----------------|
| Supply Voltage V <sub>IN</sub> .....  | 0.5V to 5.5V    |
| Supply Voltage V <sub>CC</sub> .....  | 3V to 5.5V      |
| Output Voltage V <sub>OUT</sub> ..... | 0.5V to 5.5V    |
| Operating Junction Temp.....          | -40°C to +125°C |

|  |                       |                       |      |
|--|-----------------------|-----------------------|------|
| <b>Thermal Resistance</b> <sup>(4)</sup> | <b>θ<sub>JA</sub></b> | <b>θ<sub>JC</sub></b> |      |
| QFN-12 (2mmx2mm) .....                   | 80                    | 16                    | °C/W |

**Notes:**

- 1) Exceeding these ratings may damage the device.
- 2) The maximum allowable power dissipation is a function of the maximum junction temperature T<sub>J</sub> (MAX), the junction-to-ambient thermal resistance θ<sub>JA</sub>, and the ambient temperature T<sub>A</sub>. The maximum allowable continuous power dissipation at any ambient temperature is calculated by P<sub>D</sub> (MAX) = (T<sub>J</sub> (MAX)-T<sub>A</sub>)/θ<sub>JA</sub>. Exceeding the maximum allowable power dissipation will cause excessive die temperature, and the regulator will go into thermal shutdown. Internal thermal shutdown circuitry protects the device from permanent damage.
- 3) The device is not guaranteed to function outside of its operating conditions.
- 4) Measured on JESD51-7, 4-layer PCB.

## ELECTRICAL CHARACTERISTICS

$V_{IN} = 3.6V$ ,  $V_{CC} = 3.6V$ ,  $T_A = 25^\circ C$ , unless otherwise noted.

| Parameters   | Symbol          | Condition  | Min   | Typ   | Max   | Units      |
|--|-----------------|--|-------|-------|-------|------------|
| <b>Input and Supply Voltage Range</b>              |                 |  |       |       |       |            |
| Input Voltage                                      | $V_{IN}$        |  | 0.5   |       | 5.5   | V          |
| Supply Voltage                                     | $V_{CC}$        |  | 3     |       | 5.5   | V          |
| <b>Supply Current</b>                              |                 |  |       |       |       |            |
| Off State Leakage Current                          | $I_{OFF}$       | $V_{IN}=5V$ , $EN=0$                                       |       |       | 1     | $\mu A$    |
| $V_{CC}$ Standby Current                           | $I_{STBY}$      | $V_{CC}=5V$ , $EN=0$                                       |       | 0.1   | 1     | $\mu A$    |
|  |                 | $V_{CC}=5V$ , Enable, No load                              |       | 220   | 300   |            |
| <b>Power FET</b>                                   |                 |  |       |       |       |            |
| ON Resistance                                      | $R_{DSON}$      | $V_{CC}=5.0V$  |       | 10    |       | m $\Omega$ |
|  |                 | $V_{CC}=3.3V$  |       | 12    |       |            |
| <b>Thermal Shutdown and Recovery<sup>(5)</sup></b> |                 |  |       |       |       |            |
| Shutdown Temperature                               | $T_{STD}$       |  |       | 155   |       | $^\circ C$ |
| Hysteresis   | $T_{HYS}$       |  |       | 30    |       | $^\circ C$ |
| <b>Under Voltage Protection</b>                    |                 |  |       |       |       |            |
| $V_{CC}$ Under Voltage Lockout Threshold           | $V_{CC\_UVLO}$  | UVLO Rising Threshold                                      |       | 2.6   | 2.8   | V          |
| UVLO Hysteresis                                    | $V_{UVLO\_HYS}$ |  |       | 200   |       | mV         |
| <b>Soft Start</b>                                  |                 |  |       |       |       |            |
| SS pull-up current                                 | $I_{SS}$        | Fixed slew rate  |       | 9     |       | $\mu A$    |
| <b>Enable</b>                                      |                 |  |       |       |       |            |
| EN Rising Threshold                                | $V_{ENH}$       |  | 1.3   | 1.5   | 1.7   | V          |
| EN Hysteresis                                      | $V_{EN\_HYS}$   |  |       | 400   |       | mV         |
| <b>IMON</b>  |                 |  |       |       |       |            |
| Current limit                                      | $I_{OUT}$       | $R_{IMON}=50k\Omega$ , ramp lout record peak current limit | 1.54  | 1.64  | 1.74  | A          |
| Current Monitor Accuracy                           | $V_{IN}=3.6V$   | $I_{OUT}=3.75A$  | 44.35 | 45.73 | 47.11 | $\mu A$    |
|  |                 | $I_{OUT}=3A$   | 35.49 | 36.59 | 37.69 |            |
|  |                 | $I_{OUT}=1.5A^{(6)}$                                       | 17.39 | 18.3  | 19.22 |            |
|  | $V_{IN}=1.2V$   | $I_{OUT}=3.75A$  | 44.3  | 46.65 | 49    |            |
|  |                 | $I_{OUT}=3A$   | 35.43 | 37.3  | 39.2  |            |
|  |                 | $I_{OUT}=1.5A^{(6)}$                                       | 17.54 | 18.66 | 19.78 |            |
| <b>Discharge Resistance</b>                        |                 |  |       |       |       |            |
| Discharge Resistance                               | $R_{DIS}$       |  |       | 200   |       | $\Omega$   |
| <b>PG</b>  |                 |  |       |       |       |            |
| Power Good Rising Threshold                        | $V_{PG\_R}$     | Voltage gap between $V_{OUT}$ and $V_{IN}$                 | 110   | 150   | 250   | mV         |
| Power Good Hysteresis                              | $V_{PG\_H}$     |  |       | 50    |       | mV         |
| Power Good Delay                                   | $T_{PG\_D}$     |  |       | 90    |       | $\mu s$    |
| Power Good High                                    | $V_{PG\_H}$     | $V_{CC}=3.3V$  | 3.2   |       |       | V          |
| Power Good Low                                     | $V_{PG\_L}$     | Sink 1mA   |       |       | 0.2   | V          |

**Notes:**

5) Guarantee by design.

6) If load current is smaller than 1.5A, the IMON accuracy will be affected by some internal offset.

## PIN FUNCTIONS

| QFN-12<br>(2mmx2mm)<br>Pin # | Name | Description  |
|------------------------------|------|--|
| 1                            | EN   | Enable Input. Pulling this pin below the specified threshold shuts the chip down.  |
| 2                            | GND  | Ground.  |
| 3                            | VCC  | Supply Voltage to the Control Circuitry.   |
| 4                            | IMON | Output Current Monitor. Provides a voltage proportional to the current flowing through the power device. Place a resistor to ground to set the gain. |
| 5                            | SS   | Soft Start Pin. An external capacitor connected to this pin sets the slew rate of the output voltage soft start period.                              |
| 6, 11                        | VIN  | Input Power Supply.  |
| 7, 8, 9, 10                  | VOUT | Output to the Load.  |
| 12                           | PG   | Power Good Pin. Push-Pull output.  |

## TYPICAL PERFORMANCE CHARACTERISTICS

V<sub>IN</sub> = 3.6V, V<sub>CC</sub> = 3.6V, T<sub>A</sub> = 25°C, R<sub>IMON</sub> = 10.5kΩ, unless otherwise noted.

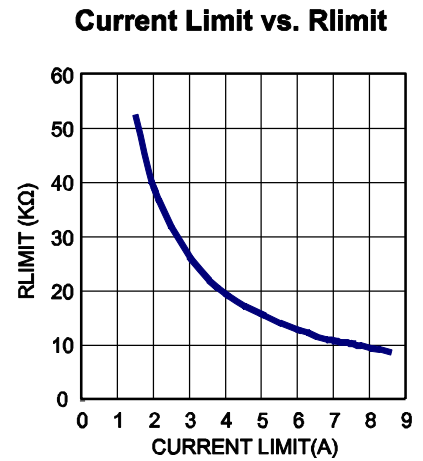
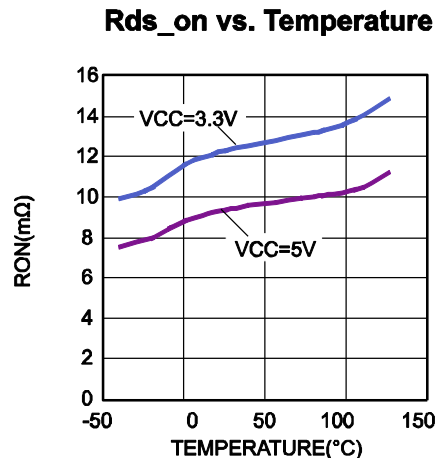
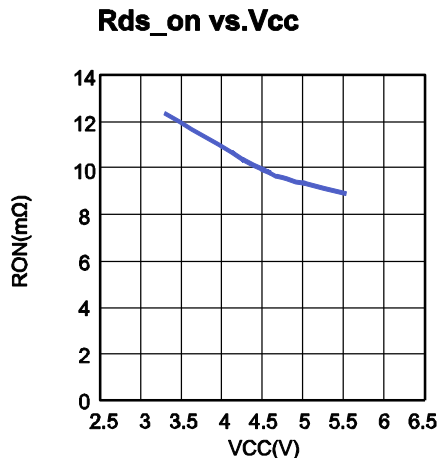
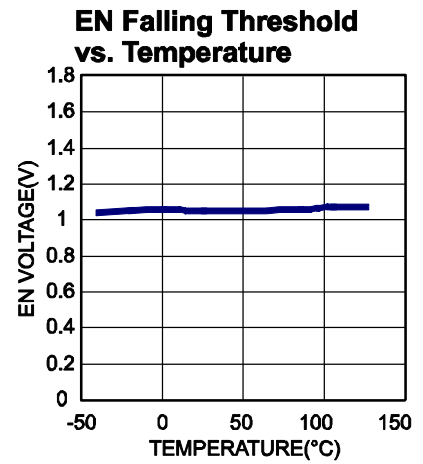
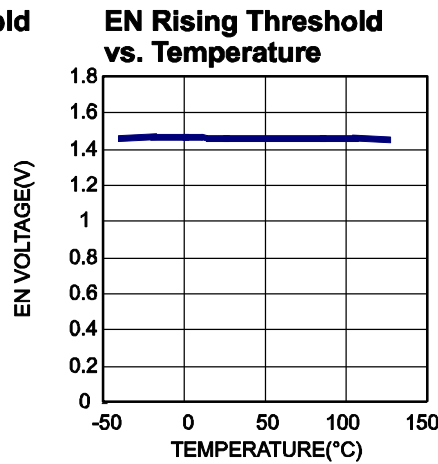
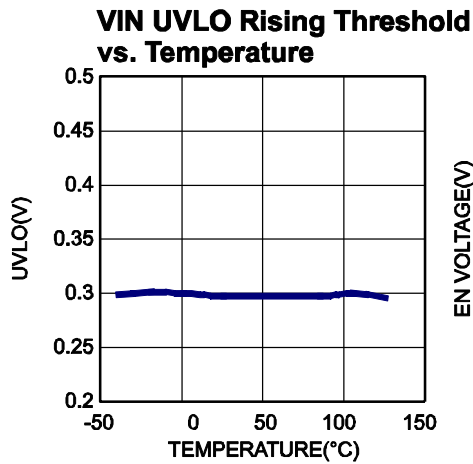
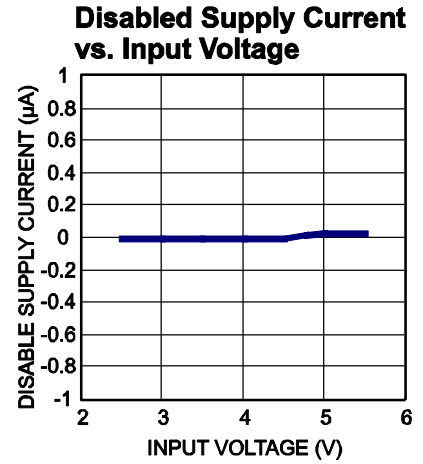
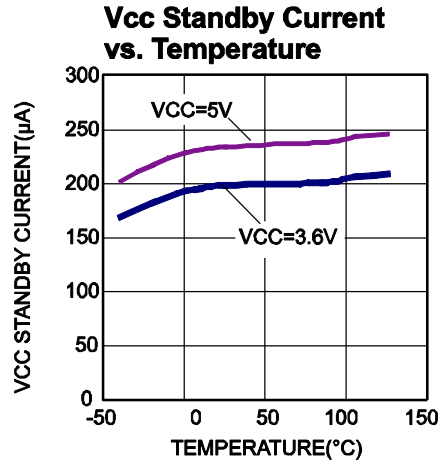
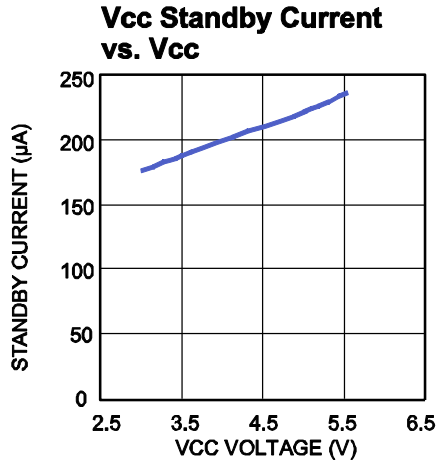

**TYPICAL PERFORMANCE CHARACTERISTICS (continued)**
 $V_{IN} = 3.6V$ ,  $V_{CC} = 3.6V$ ,  $T_A = 25^\circ C$ ,  $R_{IMON} = 10.5k\Omega$ , unless otherwise noted.

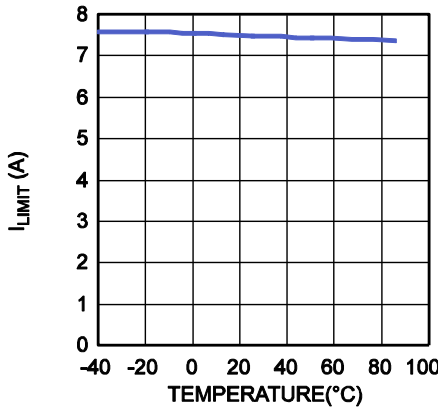
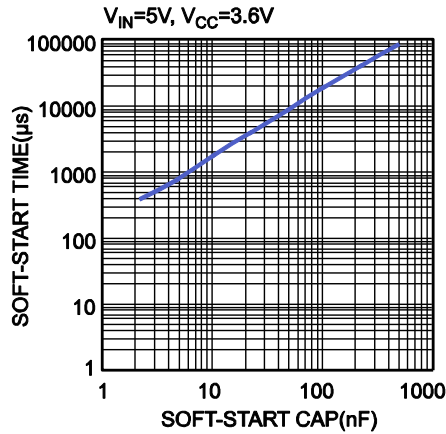
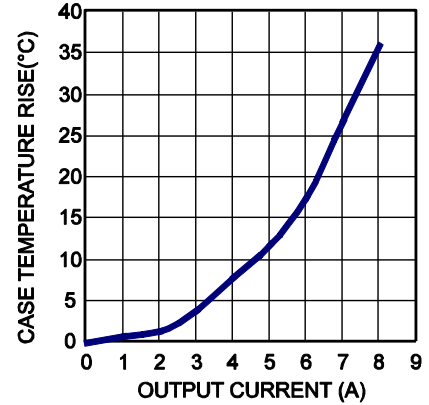
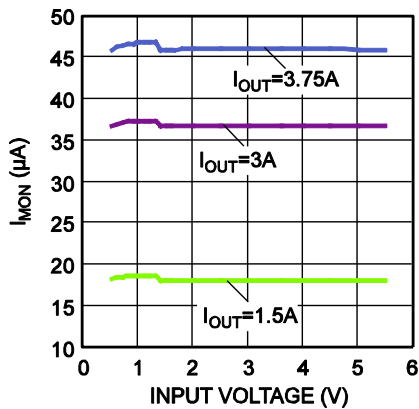
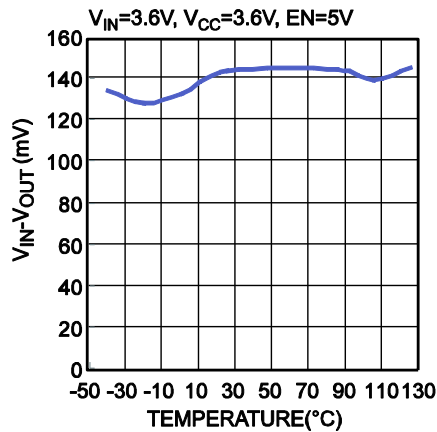
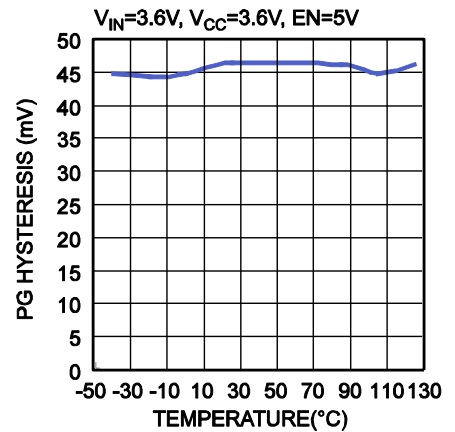
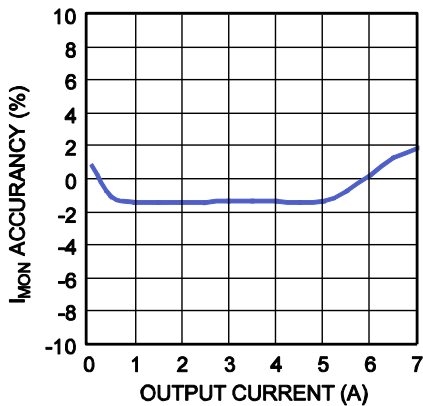
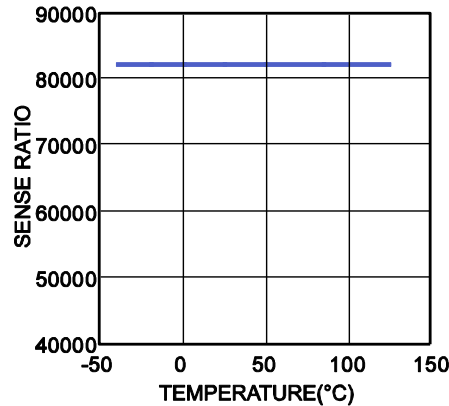
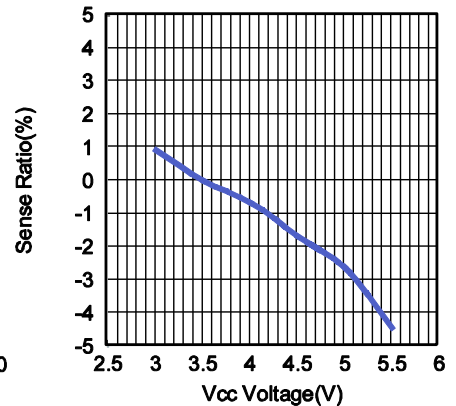
 **$I_{LIMIT}$  vs. Temperature**

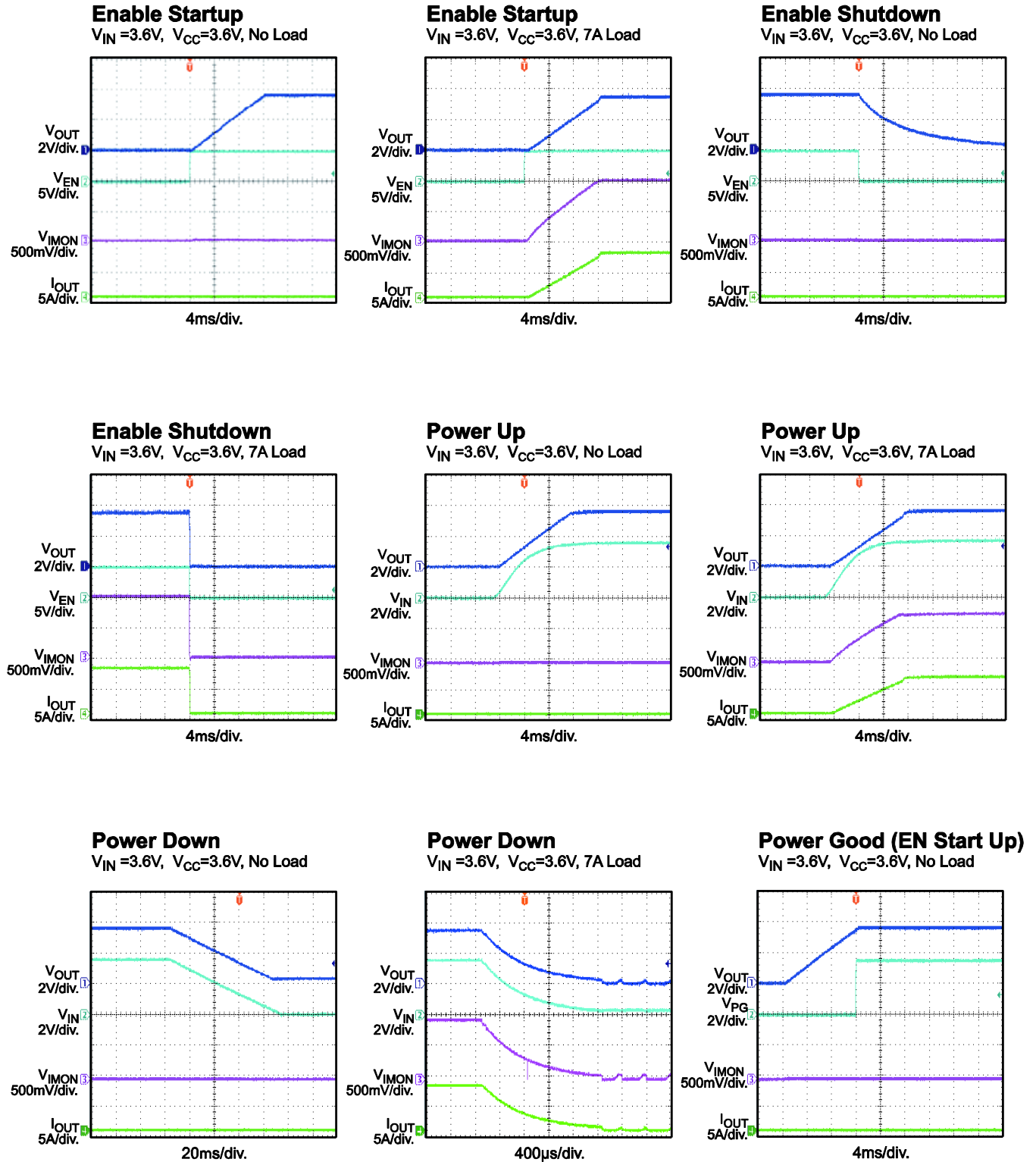
**Soft-Start vs. Cap**

**Case Temperature Rise vs. Output Current**

 **$I_{MON}$  vs.  $V_{IN}$** 

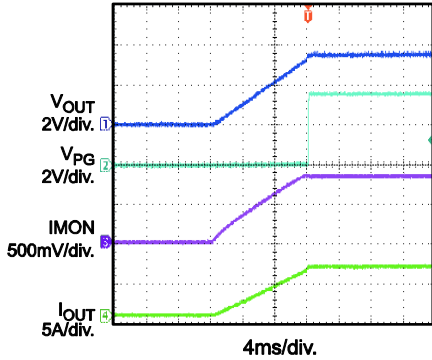
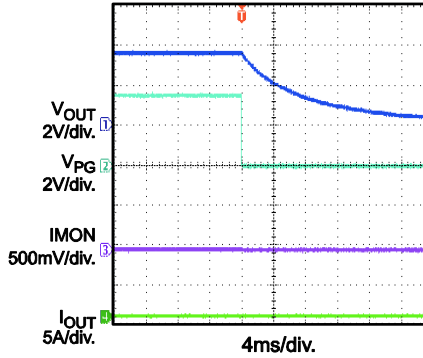
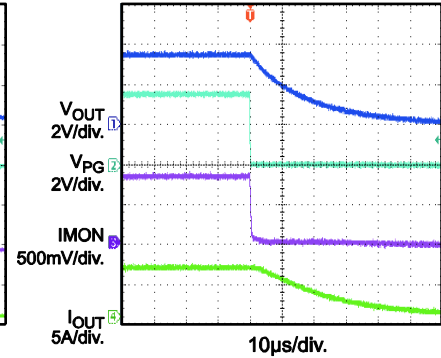
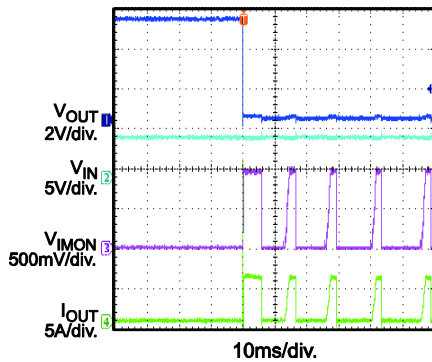
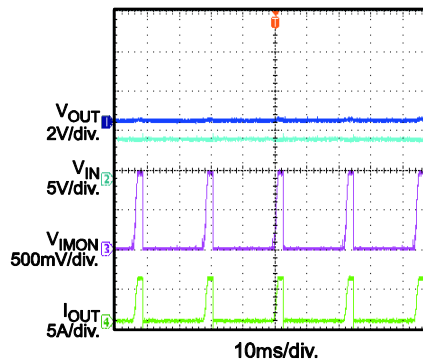
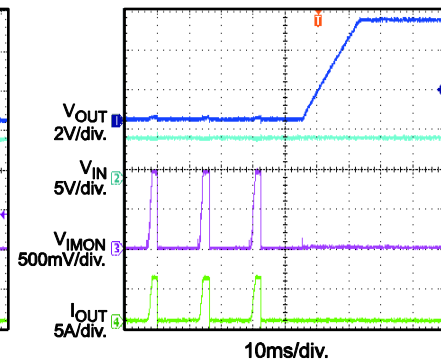
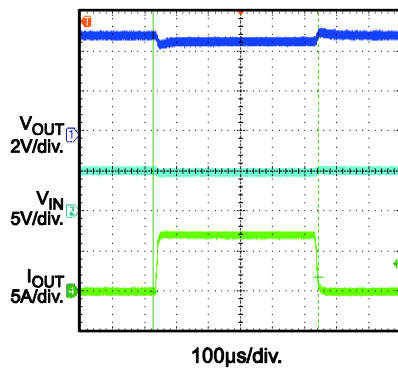
**PG Rising Threshold vs. Temperature**

**PG Hysteresis vs. Temperature**

 **$I_{MON}$  Accuracy vs.  $I_{OUT}$** 
 $V_{IN}=5V$ ,  $V_{CC}=5V$ ,  $EN=5V$ 

**Sense Ratio vs. Temperature**

**Sense Ratio Error vs.  $V_{CC}$** 
 $V_{IN}=3.6V$ ,  $I_{OUT}=3.5V$ 

**TYPICAL PERFORMANCE CHARACTERISTICS (continued)**
 $V_{IN} = 3.6V$ ,  $V_{CC} = 3.6V$ ,  $T_A = 25^\circ C$ ,  $R_{IMON} = 10.5k\Omega$ , unless otherwise noted.



**TYPICAL PERFORMANCE CHARACTERISTICS (continued)**
 $V_{IN} = 3.6V, V_{CC} = 3.6V, T_A = 25^\circ C, R_{IMON} = 10.5k\Omega$ , unless otherwise noted.

**Power Good (EN Start Up)**  
 $V_{IN} = 3.6V, V_{CC} = 3.6V, 7A$  Load

**Power Good (EN Shutdown)**  
 $V_{IN} = 3.6V, V_{CC} = 3.6V$ , No Load

**Power Good (EN Shutdown)**  
 $V_{IN} = 3.6V, V_{CC} = 3.6V, 7A$  Load

**SCP Enter**  
 $V_{IN} = 5V, V_{CC} = 3.3V$ 

**SCP Steady State**  
 $V_{IN} = 5V, V_{CC} = 3.3V$ 

**SCP Recover**  
 $V_{IN} = 5V, V_{CC} = 3.3V$ 

**Load Transient Response**  
 $V_{IN} = 5V, V_{CC} = 3.3V, I_{OUT} = 0A \rightarrow 7A$ 

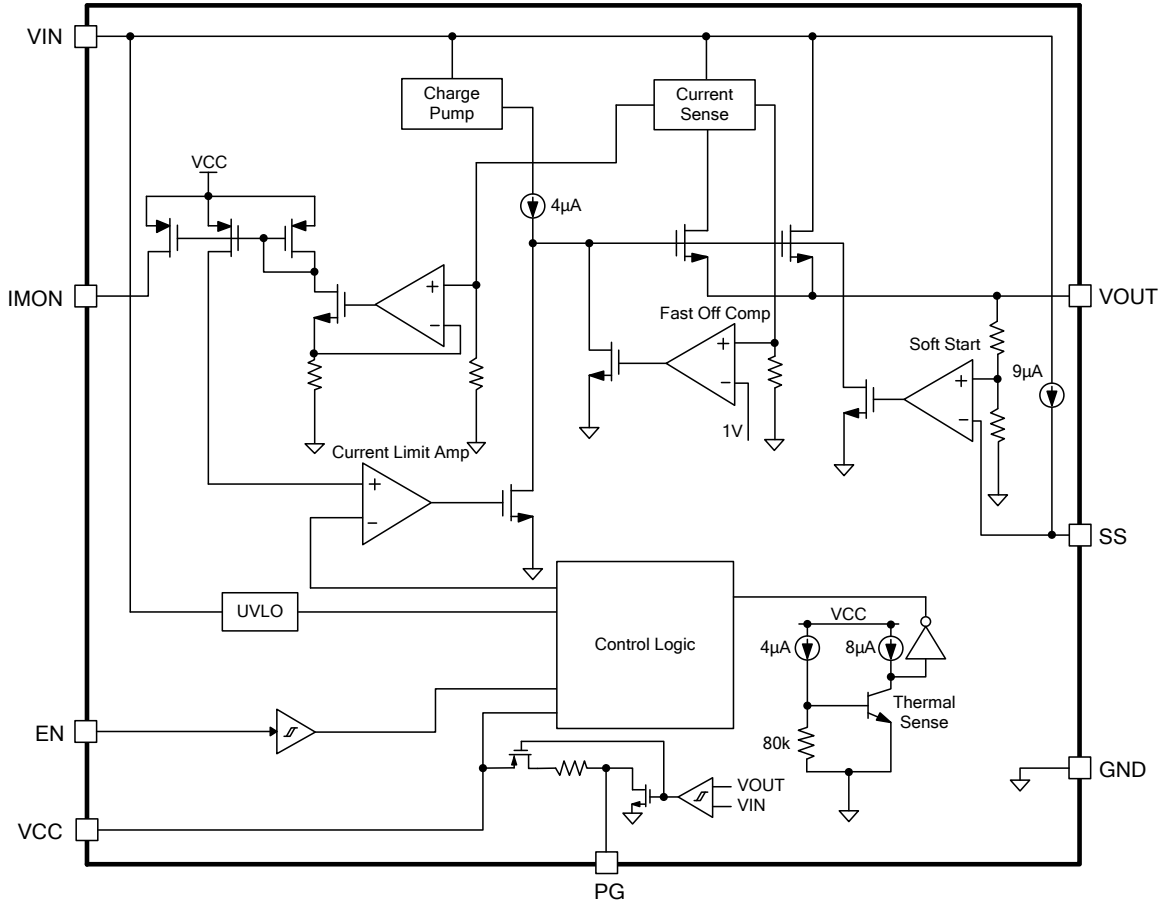

Figure 1: Functional Block Diagram

## OPERATION

The MP5087 is designed to limit the in-rush current to the load when a circuit card is inserted into a live backplane power source, thereby limiting the backplane's voltage drop and the slew rate of the voltage to the load. It provides an integrated solution to monitor the input voltage, output voltage and output current to eliminate the need for an external current power MOSFET, and current sense device.

### Enable

When input voltage is greater than the under-voltage lockout threshold (UVLO), typically 0.5V, MP5087 can be enabled by pulling EN pin to higher than 1.5V. Pulling down to ground will disable MP5087.

### Current Limit

The MP5087 provides a constant current limit that can be programmed by an external resistor. Once the device reaches its current limit threshold, the internal circuit regulates the gate voltage to hold the current in the power FET constant. The typical response time is about 20 $\mu$ s and the output current may have a small overshoot during this time period.

The pre-set current limit value can be calculated by below equation:

$$I_{Limit} = (1 \div R_{IMON}) \times S \quad (1)$$

S is the current sense ratio of MP5087, and this value is typically 82000 in  $V_{IN}=3.6V$ . The S is almost a constant value when  $V_{in}$  is changing from 1.2V to 5.5V, and when  $V_{in}$  is smaller than 1.2V, a step change will come to S value, the value will change from 82000 to about 80000. Meanwhile, when  $V_{cc}$  is changing, there is also a little shift on S value, for more information, please refer the curves in typical performance characteristics.

If the current limit block starts to regulate the output current, the power loss on power MOSFET will cause the IC temperature rise. If the junction temperature rose to high enough, it will trigger thermal shutdown. After thermal shutdown happened, it will disable the output until the over temperature fault remove. The over temperature threshold is 155°C and hysteresis is 30°C.

### Power-Good Function

The PG pin is the push pull of a MOSFET that can be pulled high to  $V_{CC}$ . The MOSFET turns on with the application of an input voltage so that the PG pin is pulled to GND. After the voltage gap between  $V_{IN}$  and  $V_{OUT}$  is smaller than 150mV, the PG pin is pulled high after a 90 $\mu$ s delay. When the voltage gap is higher than 200mV, the PG pin will be pulled low. The PG pin has a nominal pull down resistance of 200 $\Omega$  and a pull-up resistance of 250K $\Omega$ . The maximum sink current when the pin is pulled to GND through the internal pull-down resistor should be <10mA

### Short-Circuit Protection

If the load current increases rapidly due to a short circuit, the current may exceed the current limit threshold by a lot before the control loop can respond. If the current reaches an internal secondary current limit level (about 13A), a fast turn-off circuit activates to turn off the power FET. This limits the peak current through the switch to limit the input voltage drop. The total short circuit response time is about 200ns. If fast off works, it will keep off the power FET for 80 $\mu$ s. After that time period, it will re-turn on power FET, if the part is still in short-circuit condition. MP5087 will reduce the current limit to 2/3 of pre-set value, and hold it until the part is so hot and thermal shutdown. After the short-circuit condition removed, the current limit will recover to the pre-set value automatically.

### Output Discharge

MP5087 has output discharge function. This function can discharge the  $V_{OUT}$  by internal pull down resistance when IC disabled and the load is very light.

### Soft-Start

A capacitor connected to the SS pin determines the soft-start time. There is an internal 9 $\mu$ A constant current source charge SS cap and ramps up the voltage on the SS pin. The output voltage rises at 3 times the slew rate to the SS voltage.

The soft-start time can be calculated by below equation:

$$T_{SS}(\text{ms}) = \frac{1}{3} \times \frac{V_{OUT}(\text{V}) \cdot C_{SS}(\text{nF})}{I_{SS}(\text{uA})} \quad (2)$$

$T_{SS}$  is the soft-start time,  $I_{SS}$  is internal  $9\mu\text{A}$  constant current,  $C_{SS}$  is external soft-start cap. The suggestion minimum SS cap should be bigger than  $4.7\text{nF}$ . If the SS pin is floated or SS cap is too small, the  $V_{OUT}$  rising time will be just limited by power MOS charge time.

## APPLICATION INFORMATION

### IMON Resistor Selection

The current limit value can be set by IMON resistor. The current limit can be gotten by equation (1).

The current limit threshold is suggested to 10% ~ 20% higher than maximum load current. For example, if the system's full load is 7A, set the current limit to 7.7A.

### IMON Capacitor Selection

The internal advanced auto-zero comparator bring a high accuracy of current monitor. The auto-zero will also cause some little jitter on IMON pin. To get a more stable IMON, a small ceramic capacitor can be mounted between IMON and ground. Suggested place an IMON capacitor less than 1nF.

### Soft Start Capacitor Selection

There is an internal 9 $\mu$ A constant current source charge SS cap and ramps up the voltage on the SS pin. The output voltage rises follow the slew rate of SS voltage.

If the inrush on output current reached the current limit during start up (like with large output cap or very large load), MP5087 will limit the output current and the same time, SS time will be increased (Fig 2 and Fig 3).

### Component Selection

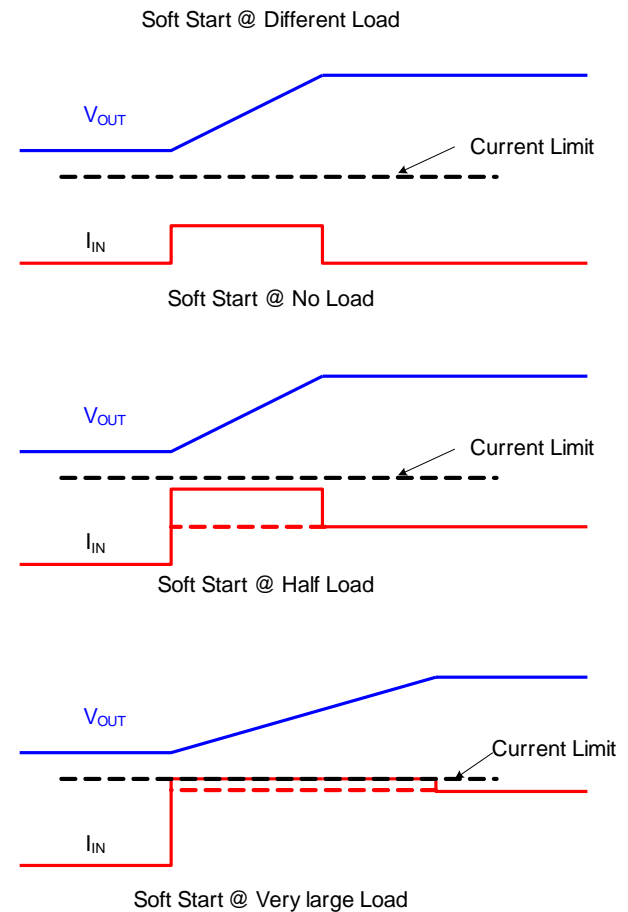

**Figure 2: Soft Start Periods at different load**

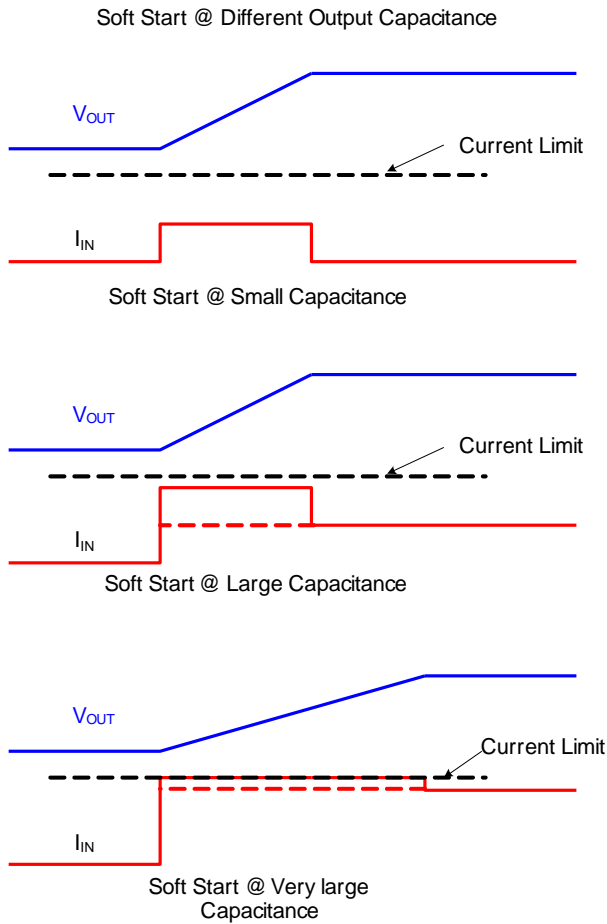

**Figure 3: Soft Start Periods at different output capacitance**

**Design Example**

Some design example and are provided below. See Table 1 and Figure 4.

**Table 1**

| V <sub>IN</sub> (V) | Max Load Range (A) | R <sub>limit</sub> (kΩ) | SS cap (nF) | SS time (ms) |
|---------------------|--------------------|-------------------------|-------------|--------------|
| 5                   | 3                  | 26.1                    | 22          | 4            |
| 5                   | 5                  | 15.8                    | 47          | 9            |
| 5                   | 7.5                | 10.5                    | 100         | 20           |

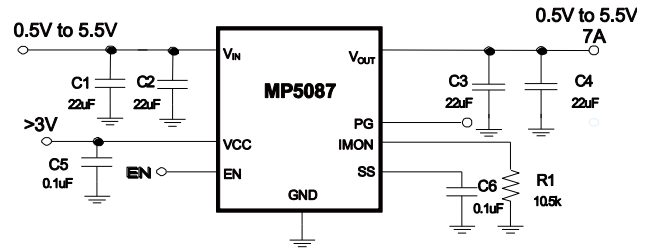

**Figure 4: Typical Application Schematic**

**Layout Guide**

PCB layout is very important to achieve stable operation. Please follow these guidelines and take below figure for reference. Place R<sub>IMON</sub> close to IMON pin, input cap close to V<sub>CC</sub> pin. Put enough vias around IC to achieve better thermal performance.

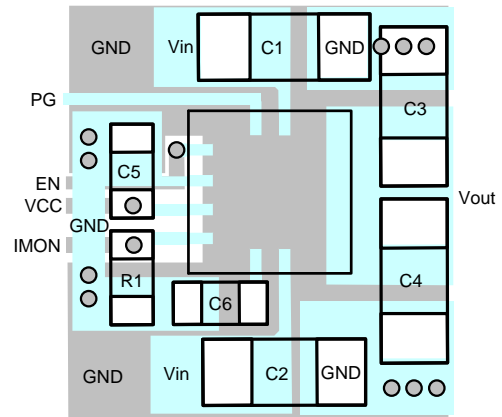

**Figure 5: Recommended Layout**

## PACKAGE INFORMATION

### QFN-12 (2mmx2mm)

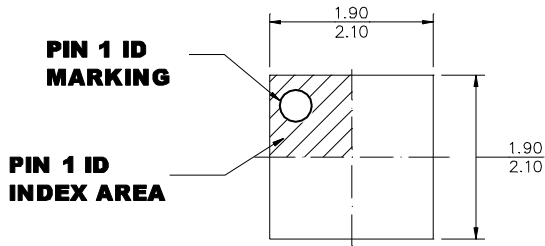

**TOP VIEW**

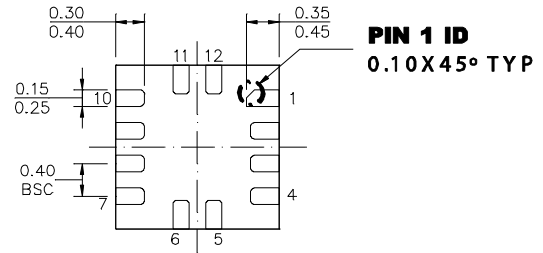

**BOTTOM VIEW**

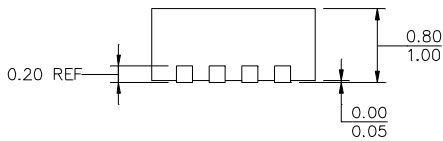

**SIDE VIEW**

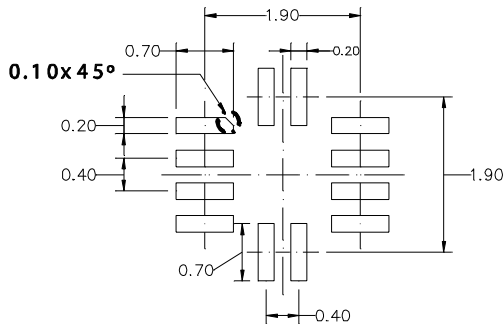

**RECOMMENDED LAND PATTERN**

### **NOTE:**

- 1) ALL DIMENSIONS ARE IN MILLIMETERS
- 2) EXPOSED PADDLE SIZE DOES NOT INCLUDE MOLD FLASH
- 3) LEAD COPLANARITY SHALL BE 0.10 MILLIMETERS MAX
- 4) JEDEC REFERENCE IS MQ220.
- 5) DRAWING IS NOT TO SCALE

**NOTICE:** The information in this document is subject to change without notice. Please contact MPS for current specifications. Users should warrant and guarantee that third party Intellectual Property rights are not infringed upon when integrating MPS products into any application. MPS will not assume any legal responsibility for any said applications.

## X-ON Electronics

Largest Supplier of Electrical and Electronic Components

*Click to view similar products for* [Power Switch ICs - Power Distribution](#) *category:*

*Click to view products by* [Monolithic Power Systems](#) *manufacturer:*

Other Similar products are found below :

[TCK111G,LF\(S\)](#) [FPF1018](#) [DS1222](#) [TCK2065G,LF](#) [SZNCP3712ASNT3G](#) [MIC2033-05BYMT-T5](#) [MIC2033-12AYMT-T5](#) [MIC2033-05BYM6-T5](#) [SLG5NT1437VTR](#) [SZNCP3712ASNT1G](#) [DML1008LDS-7](#) [KTS1670EDA-TR](#) [KTS1640QGDV-TR](#) [KTS1641QGDV-TR](#) [NCV459MNWTBG](#) [FPF2260ATMX](#) [U6513A](#) [MIC2012YM-TR](#) [MC33882PEP](#) [TPS2104DBVR](#) [MIC2098-1YMT-TR](#) [MIC94062YMT TR](#) [MP6231DN-LF](#) [MIC2015-1.2YM6 TR](#) [MIC2075-2YM](#) [MIC94068YML-TR](#) [SIP32461DB-T2-GE1](#) [NCP335FCT2G](#) [TCK105G,LF\(S\)](#) [AP2411S-13](#) [AP2151DSG-13](#) [AP2172MPG-13](#) [MIC94094YC6-TR](#) [MIC94093YC6-TR](#) [MIC94064YC6-TR](#) [MIC94061YMT-TR](#) [MIC2505-1YM](#) [MIC94305YMT-TR](#) [MIC94085YFT-TR](#) [MIC94081YFT-TR](#) [MIC94042YFL-TR](#) [MIC94041YFL-TR](#) [MIC2005-1.2YM6-TR](#) [TPS2032QDRQ1](#) [NCP333FCT2G](#) [BTS3050TFATMA1](#) [NCP331SNT1G](#) [TPS2092DR](#) [TPS2063DR](#) [VNV35N07-E](#)