

DESCRIPTION

The MPM3620 is a synchronous rectified, step-down module converter with built-in power MOSFETs, inductor, and two capacitors. It offers a compact solution that requires only 5 external components to achieve a 2A continuous output current with excellent load and line regulation over a wide input-supply range. Also, it provides fast load transient response. An external AAM pin provides selectable power-save mode and forced PWM mode.

Full protection features include over-current protection(OCP) and thermal shut down(TSD).

MPM3620 eliminates design and manufacturing risks while dramatically improving time-to-market.

The MPM3620 is available in a space-saving QFN-20 (3mmx5mmx1.6mm) package.

FEATURES

- 4.5V-to-24V Operating Input Range
- 2A Continuous Load Current
- 200 μ A Low Quiescent Current
- 90m Ω /40m Ω Low $R_{DS(ON)}$ Internal Power MOSFETs
- Integrated Inductor
- Integrated V_{CC} and Bootstrap Capacitors
- External AAM for Power-Save Mode Programming
- Over-Current Protection and Hiccup
- Thermal Shutdown
- Output Adjustable from 0.8V
- Available in QFN-20 (3mmx5mmx1.6mm) Package
- Total solution size 6.7mmx6.3mm

APPLICATIONS

- Industrial Controls
- Medical and Imaging Equipment
- Telecom and Networking Applications
- LDO Replacement
- Space and Resource-limited Applications

All MPS parts are lead-free, halogen free, and adhere to the RoHS directive. For MPS green status, please visit MPS website under Quality Assurance.

"MPS" and "The Future of Analog IC Technology" are Registered Trademarks of Monolithic Power Systems, Inc.

TYPICAL APPLICATION

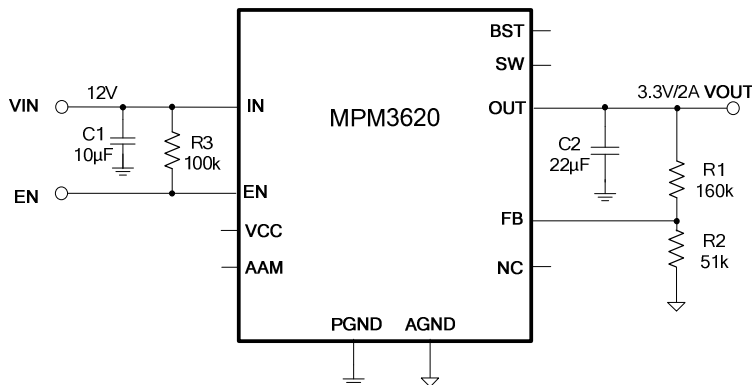

Efficiency vs. Load Current

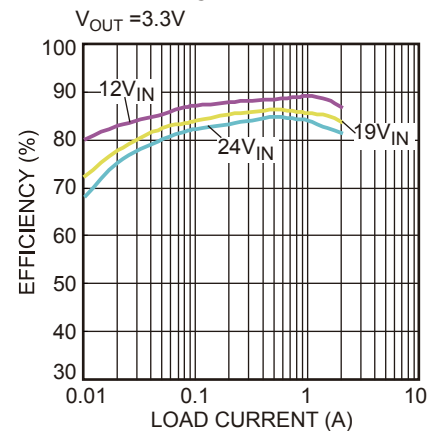

ORDERING INFORMATION

| Part Number* | Package | Top Marking |
|--------------|---------------------------|-------------|
| MPM3620GQV | QFN-20 (3mmx5mmx1.6mm) | See Below |

* For Tape & Reel, add suffix -Z (e.g. MPM3620GQV-Z);

TOP MARKING

MPYW
3620
LLL
M

MP: MPS prefix;
 Y: year code;
 W: week code;
 3620 first four digits of the part number;
 LLL: lot number;
 M: module

PACKAGE REFERENCE

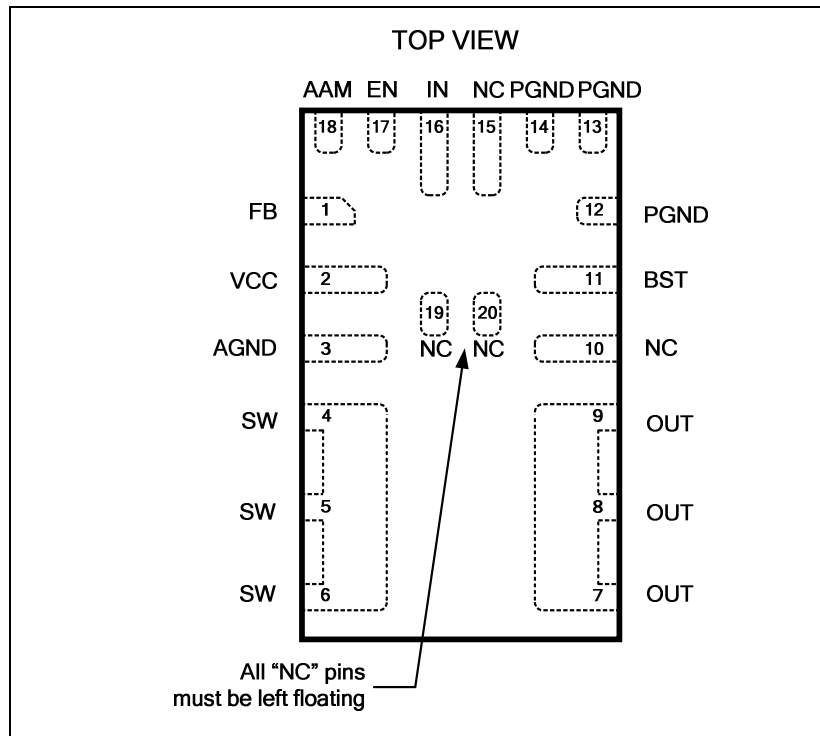

ABSOLUTE MAXIMUM RATINGS ⁽¹⁾

| | |
|--|--|
| V_{IN} | -0.3V to 28V |
| V_{OUT} | -0.3V to 28V |
| V_{SW} | -0.3V (-5V for <10ns) to 28V (30V for <10ns) |
| V_{BST} | $V_{SW}+6V$ |
| All Other Pins..... | -0.3V to 6V ⁽²⁾ |
| Continuous Power Dissipation ($T_A = +25^{\circ}C$) ⁽³⁾ | 2.7W |
| Junction Temperature..... | 150°C |
| Lead Temperature | 260°C |
| Storage Temperature..... | -65°C to 150°C |

Recommended Operating Conditions ⁽⁴⁾

| | |
|-------------------------------------|---|
| Supply Voltage V_{IN} | 4.5V to 24V |
| Output Voltage V_{OUT} | 0.8V to $V_{IN} * D_{MAX}$ ⁽⁵⁾ |
| Operating Junction Temp. (T_J). | -40°C to +125°C |

| | | |
|--|---------------|---------------|
| Thermal Resistance ⁽⁶⁾ | θ_{JA} | θ_{JC} |
| QFN-20 (3mmx5mmx1.6mm)... | 46 | 10 ... °C/W |

Notes:

- 1) Exceeding these ratings may damage the device.
- 2) For additional details on EN pin's ABS MAX rating, please refer to the "Enable Control" section on page 14.
- 3) The maximum power dissipation is a function of the maximum junction temperature T_J (MAX), the junction-to-ambient thermal resistance θ_{JA} , and the ambient temperature T_A . The maximum continuous power dissipation at any ambient temperature is calculated by P_D (MAX) = $(T_J$ (MAX)- T_A)/ θ_{JA} . Exceeding the maximum allowable power dissipation will produce an excessive die temperature, causing the converter to go into thermal shutdown. Internal thermal shutdown circuitry protects the device from permanent damage.
- 4) The device is not guaranteed to function outside of its operating conditions.
- 5) In practical design, the minimum V_{OUT} is limited by the minimum on-time. To allow a margin, a 50ns on-time is recommended for calculating. To set the output voltage above 5.5V, please refer to the application information on page 17.
- 6) Measured on JESD51-7, 4-layer PCB.

ELECTRICAL CHARACTERISTICS

$V_{IN}=12V$, $T_J=-40^{\circ}C$ to $+125^{\circ}C$ ⁽⁷⁾, typical value is tested at $T_J=+25^{\circ}C$, unless otherwise noted.

| Parameter | Symbol | Condition | Min | Typ | Max | Units |
|--|-------------------|---|------|------|------|-------------|
| Supply Current (Shutdown) | I_{IN} | $V_{EN} = 0V, T_J=25^{\circ}C$ | | | 1 | μA |
| Supply Current (Quiescent) | I_q | $V_{FB} = 1V, V_{AAM}=0.5V$ | | 0.2 | | mA |
| | | $V_{FB} = 1V, V_{AAM}=5V$ | | 0.7 | | |
| HS Switch-On Resistance | HS_{RDS-ON} | $V_{BST-SW}=5V$ | | 90 | | m Ω |
| LS Switch-On Resistance | LS_{RDS-ON} | $V_{CC} = 5V$ | | 40 | | m Ω |
| Integrated Inductor Inductance ⁽⁸⁾ | L | | | 1 | | μH |
| Inductor DC Resistance | L_{DCR} | $T_J=+25^{\circ}C$ | 25 | 45 | 65 | m Ω |
| Switch Leakage | SW_{LKG} | $V_{EN} = 0V, V_{SW} = 12V$ | | | 1 | μA |
| Current Limit ⁽⁸⁾ | I_{LIMIT} | Under 40% Duty Cycle | 3.8 | 4.8 | | A |
| Oscillator Frequency | f_{SW} | $V_{FB}=0.75V, T_J=+25^{\circ}C$ | 1600 | 2000 | 2400 | kHz |
| | | $V_{FB}=0.75V, T_J=-40^{\circ}C$ to $+125^{\circ}C$ | 1500 | 2000 | 2500 | |
| Fold-Back Frequency | f_{FB} | $V_{FB}<400mV$ | | 0.3 | | f_{SW} |
| Maximum Duty Cycle | D_{MAX} | $V_{FB}=700mV$ | 77 | | | % |
| Minimum On Time ⁽⁸⁾ | T_{ON_MIN} | | | 35 | | ns |
| Feedback Voltage | V_{FB} | $T_J=+25^{\circ}C$ | 786 | 798 | 810 | mV |
| | | $T_J=-40^{\circ}C$ to $+125^{\circ}C$ | 782 | 798 | 814 | |
| Feedback Current | I_{FB} | $V_{FB}=820mV$ | | 10 | 50 | nA |
| AAM Source Current | I_{AAM} | $T_J=+25^{\circ}C$ | 5.6 | 6.2 | 6.8 | μA |
| | | $T_J=-40^{\circ}C$ to $+125^{\circ}C$ | 4.3 | 6.2 | 7.9 | |
| EN Rising Threshold | V_{EN_RISING} | | 1.15 | 1.4 | 1.65 | V |
| EN Falling Threshold | $V_{EN_FALLING}$ | | 1.05 | 1.25 | 1.45 | V |
| EN Input Current | I_{EN} | $V_{EN}=2V$ | | 2 | | μA |
| VIN Under-Voltage Lockout Threshold—Rising | $INUV_{Vth}$ | | 3.65 | 3.9 | 4.15 | V |
| VIN Under-Voltage Lockout Threshold—Hysteresis | $INUV_{HYS}$ | | | 650 | | mV |
| VCC Regulator | V_{CC} | | | 5 | | V |
| VCC Load Regulation | | $I_{CC}=5mA$ | | 1.5 | | % |
| Soft-Start Time | t_{SS} | V_{OUT} from 10% to 90% | | 1.5 | | ms |
| Thermal Shutdown ⁽⁸⁾ | | | | 150 | | $^{\circ}C$ |
| Thermal Hysteresis ⁽⁸⁾ | | | | 20 | | $^{\circ}C$ |

Notes:

- 7) Not tested in production; guaranteed by over-temperature correlation.
8) Guaranteed by characterization test.

TYPICAL CHARACTERISTICS

$V_{IN} = 12V$, $V_{OUT} = 3.3V$, $T_A = 25^\circ C$, unless otherwise noted.

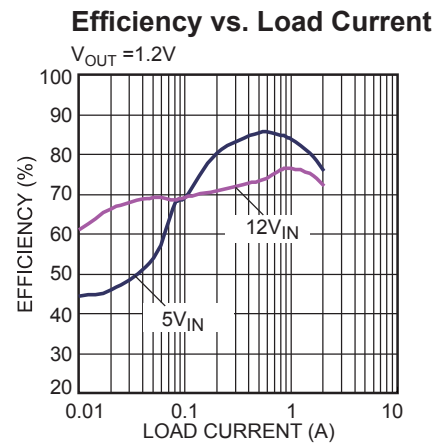
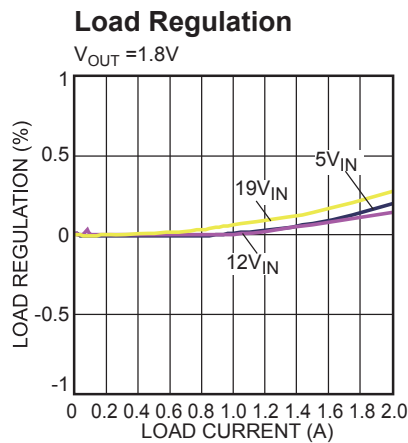
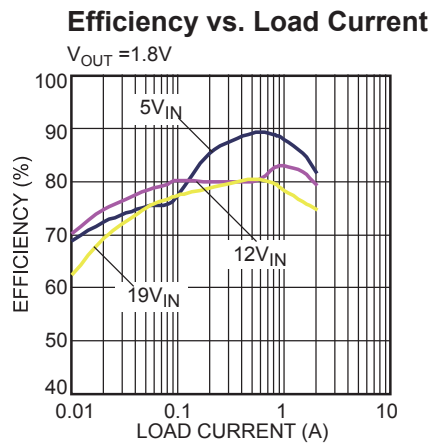
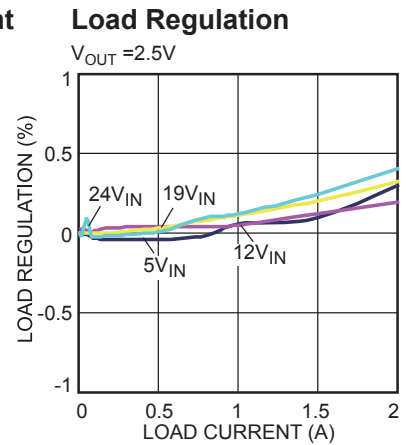
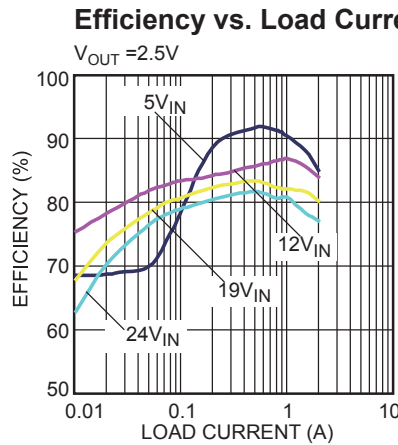
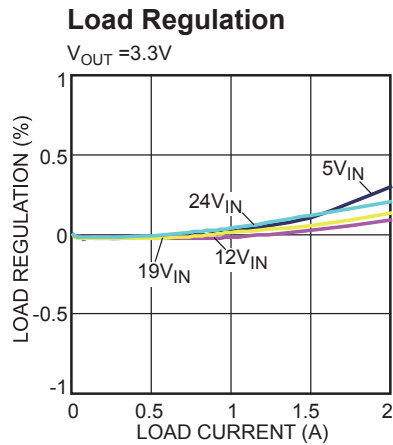
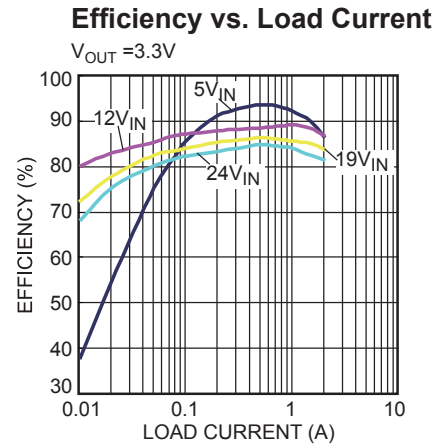
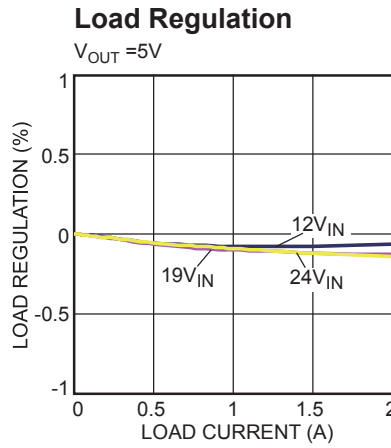
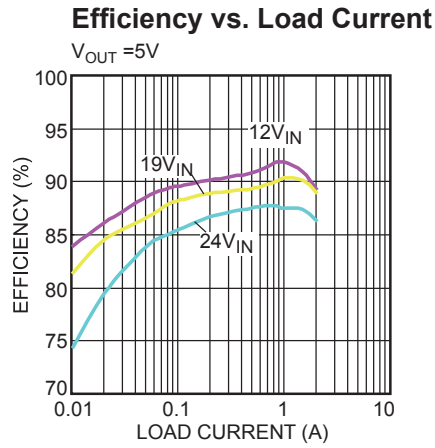

TYPICAL CHARACTERISTICS (continued)
 $V_{IN} = 12V$, $V_{OUT} = 3.3V$, $T_A = 25^\circ C$, unless otherwise noted.

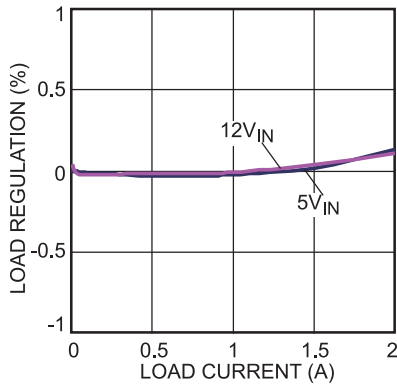
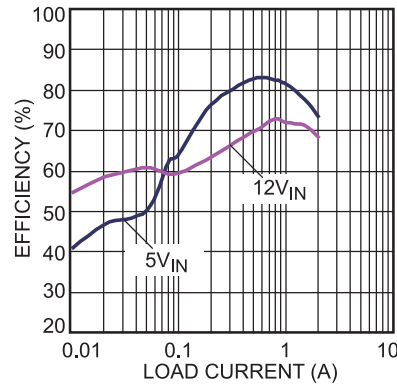
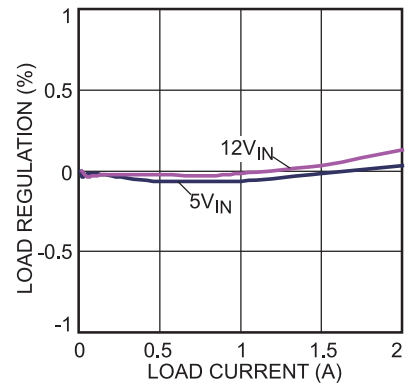
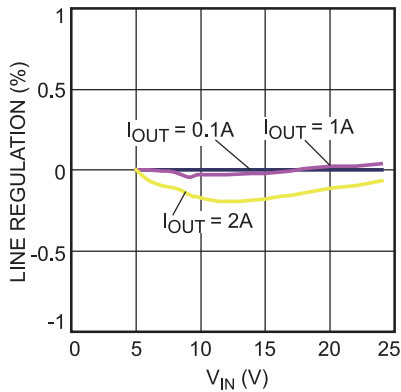
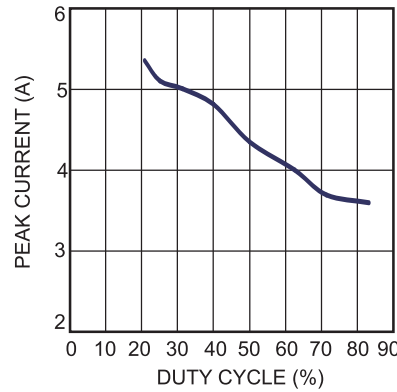
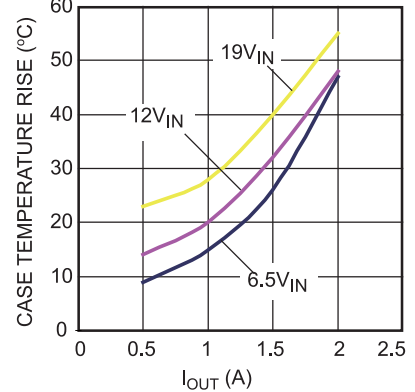
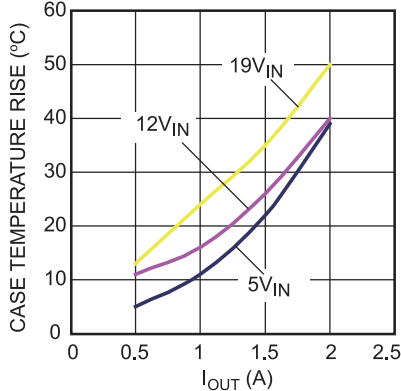
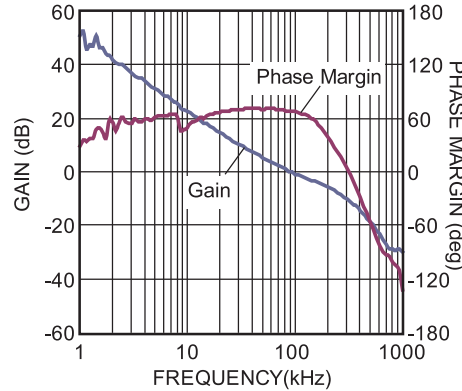
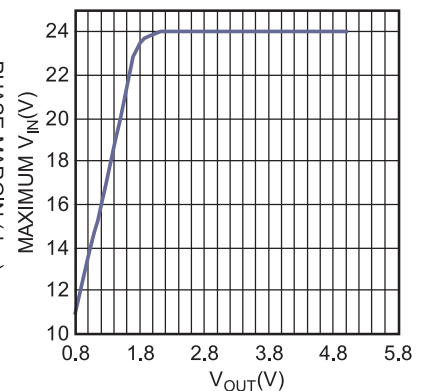
Load Regulation
 $V_{OUT} = 1.2V$

Efficiency vs. Load Current
 $V_{OUT} = 1V$

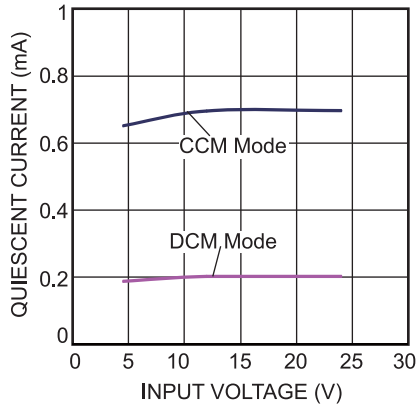
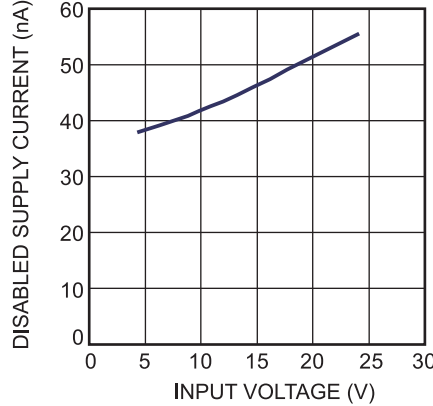
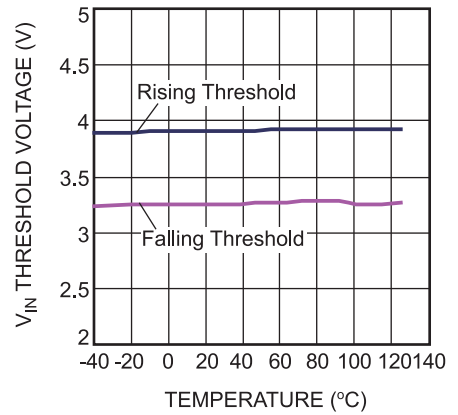
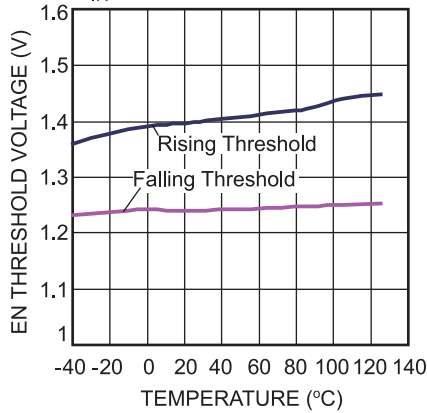
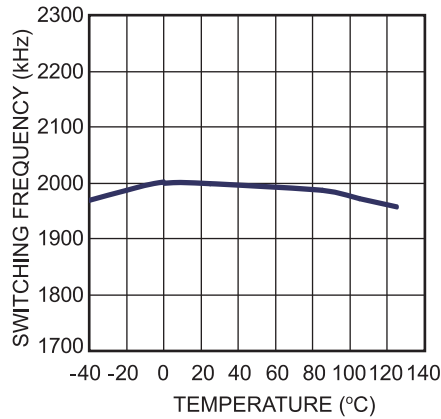
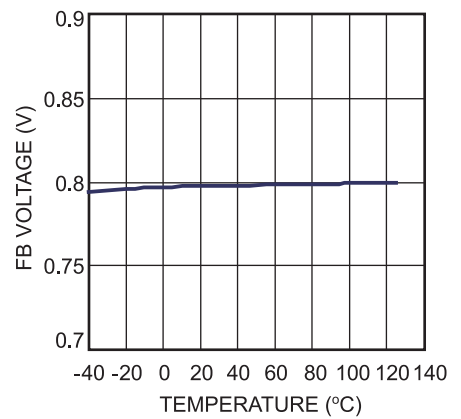
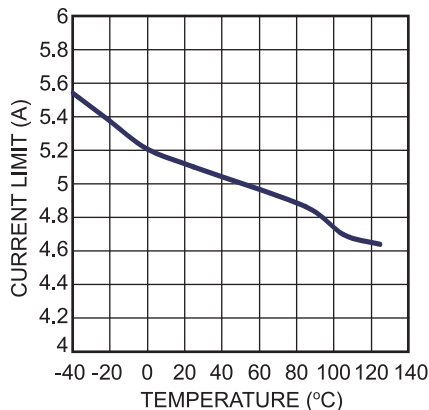
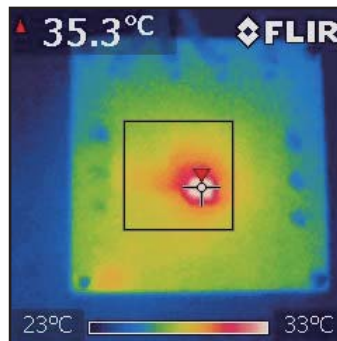
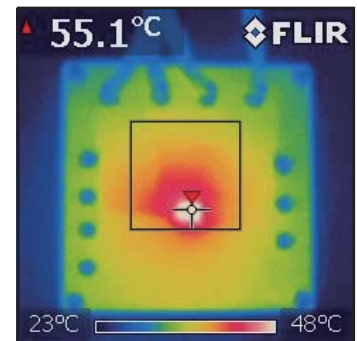
Load Regulation
 $V_{OUT} = 1V$

Line Regulation
 $V_{OUT} = 3.3V$

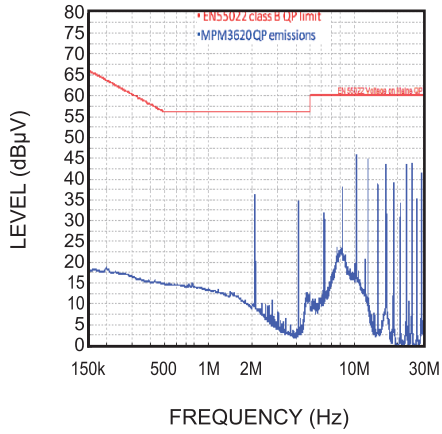
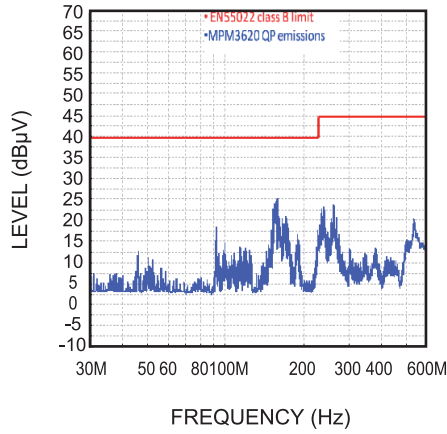
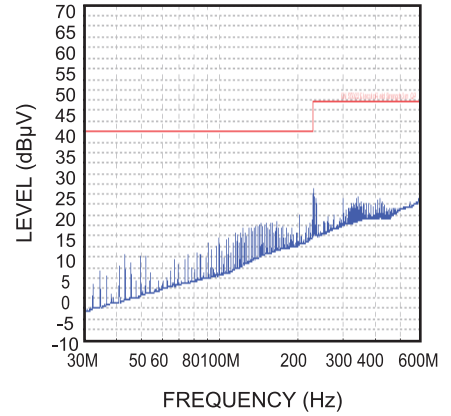
Inductor Peak-Current Limit vs. Duty Cycle

Case Temperature Rise vs. IOUT
 $V_{OUT} = 5V$

Case Temperature Rise vs. IOUT
 $V_{OUT} = 3.3V$

Bode Plot
 $I_{OUT} = 2A$

Maximum VIN vs. VOUT

TYPICAL CHARACTERISTICS (continued)
 $V_{IN} = 12V$, $V_{OUT} = 3.3V$, $T_A = 25^\circ C$, unless otherwise noted.

Quiescent Current vs. Input Voltage
 $V_{IN}=4.5V$ to $24V$, $V_{FB}=0.9V$

Disabled Supply Current vs. Input Voltage
 $V_{IN}=4.5V$ to $24V$, $EN=0V$

 V_{IN} Threshold vs. Temperature
 $EN=5V$

EN Threshold vs. Temperature
 $V_{IN}=12V$

Switching Frequency vs. Temperature

FB Voltage vs. Temperature

Inductor Peak-Current Limit vs. Temperature
 Duty Cycle=25%

Thermal Test
 $V_{OUT}=1.5V$, $I_{OUT}=1A$,
 Test on EVM3620-Q-00B, $T_A=25^\circ C$,
 No Air Flow

Thermal Test
 $V_{OUT}=1.5V$, $I_{OUT}=2A$,
 Test on EVM3620-Q-00B, $T_A=25^\circ C$,
 No Air Flow

TYPICAL CHARACTERISTICS (continued)
 $V_{IN} = 12V, V_{OUT} = 3.3V, T_A = 25^{\circ}C$, unless otherwise noted.

Conduction-EMI
 $I_{OUT} = 2A$
 $C_{IN} = 64\mu F + 10nF/0402$

Radiated-EMI
 $I_{OUT} = 2A$
 $C_{IN} = 64\mu F + 10nF/0402$

Radiated-EMI with RC Snubber
 $R_S = 5.6\Omega, C_S = 330pF$
 $I_{OUT} = 0.2A, V_{AAM} = 5V$

TYPICAL PERFORMANCE CHARACTERISTICS

Performance waveforms are captured from the evaluation board discussed in the Design Example section. $V_{IN} = 12V$, $V_{OUT} = 3.3V$, $C_{OUT} = 22\mu F$, $T_A = 25^\circ C$, unless otherwise noted.

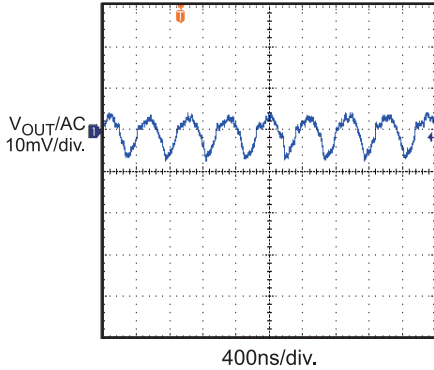
Output Ripple

Bandwidth=20MHz,
 $I_{OUT} = 2A$



Output Ripple

Bandwidth=150MHz,
 $I_{OUT} = 2A$

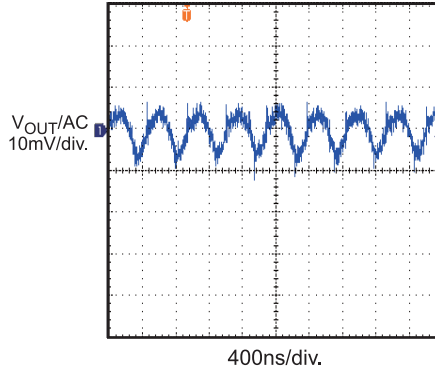

Input/Output Ripple

$I_{OUT} = 2A$

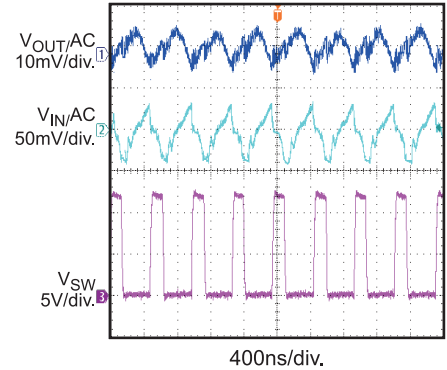

Input/Output Ripple

$I_{OUT} = 0A$

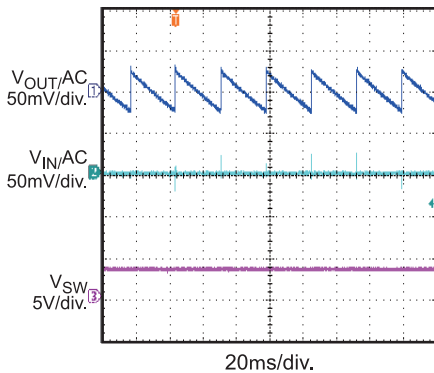

Start-Up through Input Voltage

$I_{OUT} = 0A$

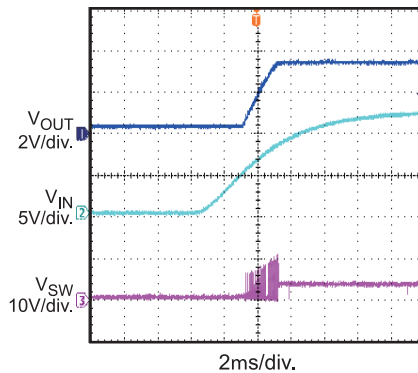

Start-Up through Input Voltage

$I_{OUT} = 2A$

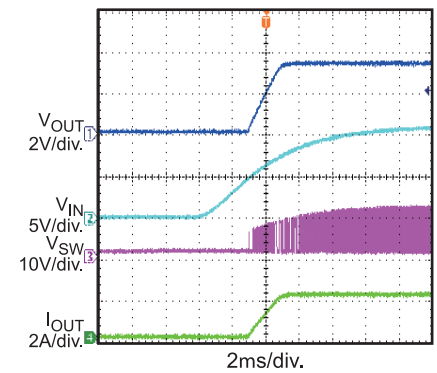

Shutdown through Input Voltage

$I_{OUT} = 0A$

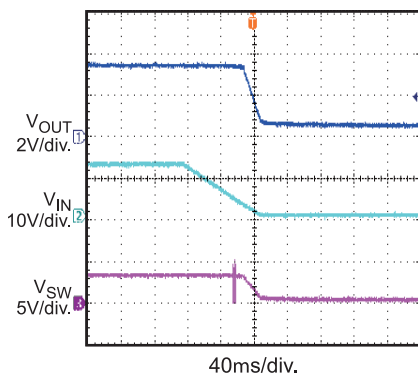

Shutdown through Input Voltage

$I_{OUT} = 2A$

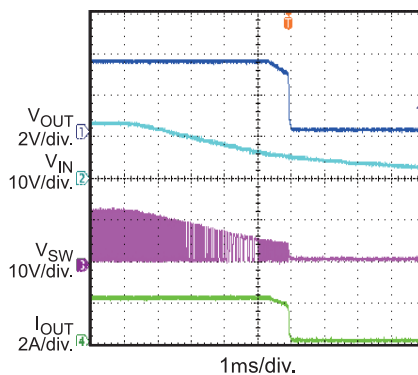

Start-Up through Enable

$I_{OUT} = 0A$

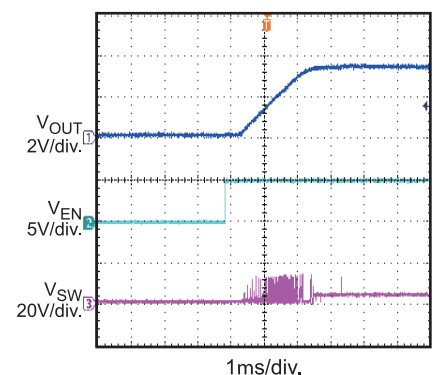

TYPICAL PERFORMANCE CHARACTERISTICS (continued)

Performance waveforms are captured from the evaluation board discussed in the Design Example section. $V_{IN} = 12V$, $V_{OUT} = 3.3V$, $C_{OUT} = 22\mu F$, $T_A = 25^\circ C$, unless otherwise noted.

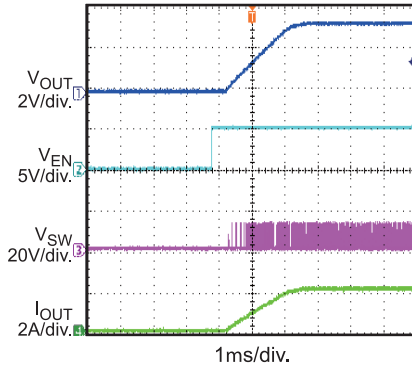
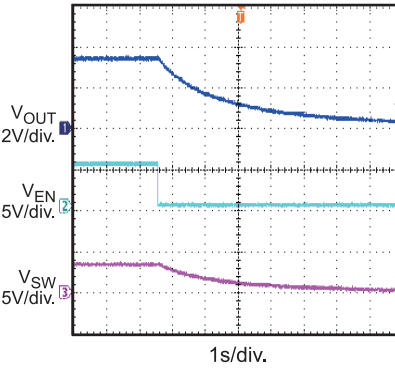
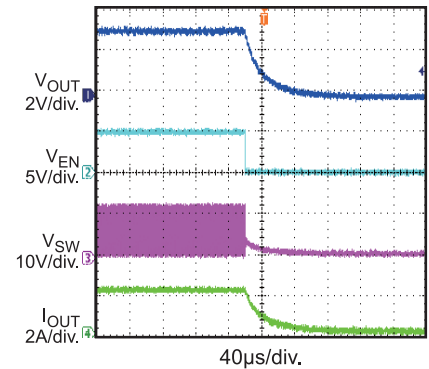
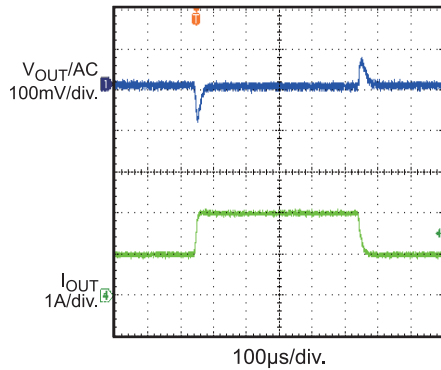
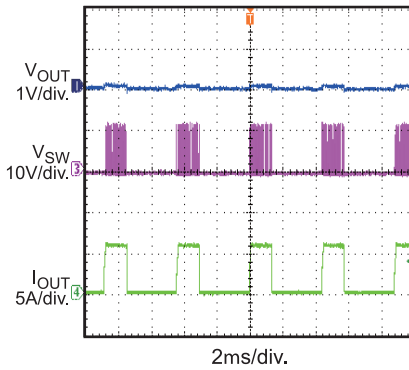
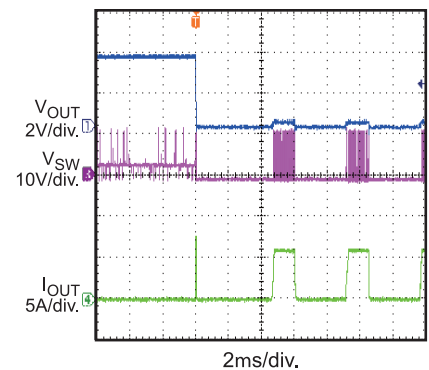
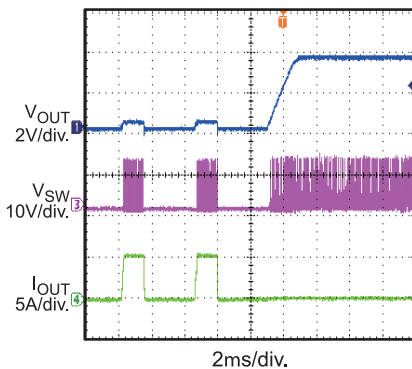
Start-Up through Enable
 $I_{OUT} = 2A$

Shutdown through Enable
 $I_{OUT} = 0A$

Shutdown through Enable
 $I_{OUT} = 2A$

Load Transient Response
 I_{OUT} transient from 1A to 2A

Short-Circuit Steady State

Short-Circuit Entry
 $I_{OUT} = 0A$

Short-Circuit Recovery
 $I_{OUT} = 0A$

PIN FUNCTIONS

| Package Pin # | Name | Description |
|----------------|------|---|
| 1 | FB | Feedback. Connect FB to the tap of an external resistor divider from the output to AGND to set the output voltage. To prevent current-limit runaway during a short-circuit fault, the frequency foldback comparator lowers the oscillator frequency when the FB voltage is below 400mV. Place the resistor divider as close as possible to FB. Avoid placing vias on the FB traces. |
| 2 | VCC | Internal 5V LDO Output. The module integrates a LDO output capacitor, so there is no need to add an external capacitor. |
| 3 | AGND | Analog Ground. Reference ground of logic circuit. AGND is connected internally to PGND, so there is no need to add any external connections to PGND. |
| 4, 5, 6 | SW | Switch Output. A large copper plane is recommended on pins 4, 5, and 6 to improve thermal performance. |
| 7, 8, 9 | OUT | Power Output. Connect load to OUT. An output capacitor is needed. |
| 10, 15, 19, 20 | NC | No Connection. DO NOT CONNECT. NC must be left floating. |
| 11 | BST | Bootstrap. A bootstrap capacitor is integrated internally, so an external connection is not needed. |
| 12, 13, 14 | PGND | Power Ground. Reference ground of the power device. PCB layout requires extra care (please see recommended “PCB Layout Guidelines” on page 19). For best results, connect to PGND with copper and vias. |
| 16 | IN | Supply Voltage. IN supplies power for the internal MOSFET and regulator. The MPM3620 operates from a +4.5V to +24V input rail. It requires a low ESR and low-inductance capacitor to decouple the input rail. Place the input capacitor very close to IN and connect it with wide PCB traces and multiple vias. |
| 17 | EN | Enable. EN=high to enable the module. Leave EN floating or connect it to GND to disable the module. |
| 18 | AAM | Advanced Asynchronous Modulation. AAM sources a 6.2 μ A current from an internal 5V supply. Float AAM or drive AAM high (>2.5V) to force the MPM3620 to operate in continuous conduction mode (CCM). If AAM mode is required under light load, connect a resistor to ground to program AAM voltage in the range of 0V to 1V. |

FUNCTIONAL BLOCK DIAGRAM

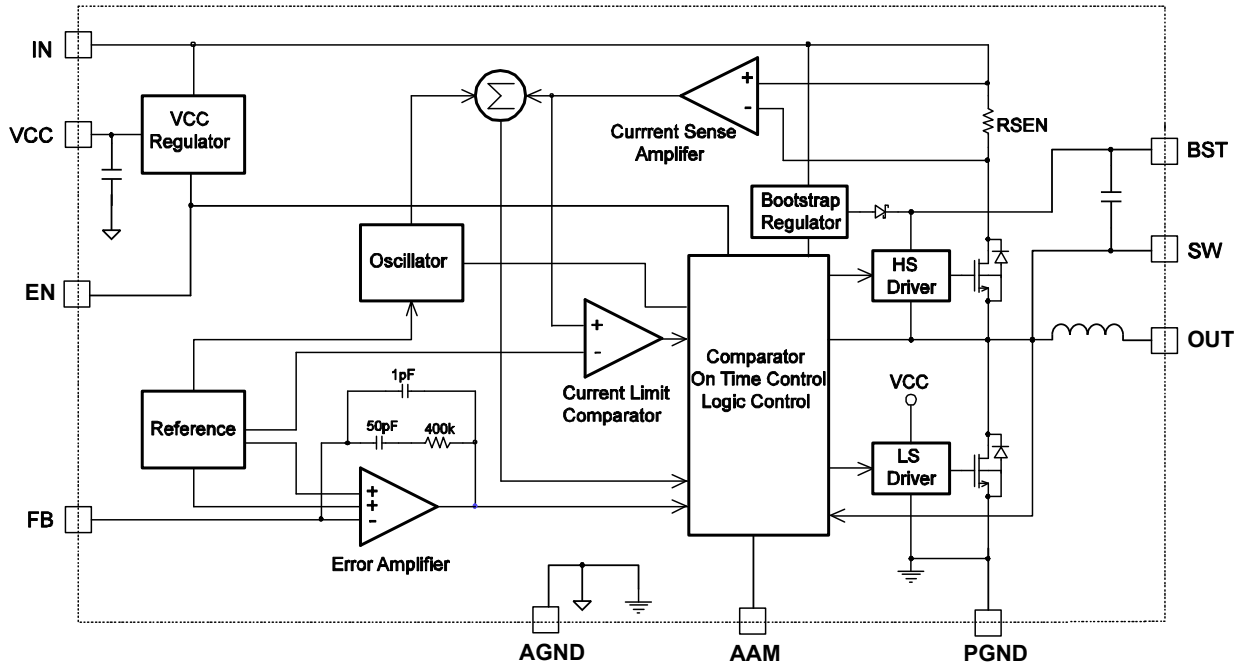

Figure 1: Functional Block Diagram

OPERATION

The MPM3620 is a high-frequency, synchronous, rectified, step-down, switch-mode converter with built-in power MOSFETs, inductor, and two capacitors. It offers a compact solution that achieves a 2A continuous output current with excellent load and line regulation over a 4.5V to 24V input-supply range.

The MPM3620 has three working modes: advanced asynchronous modulation (AAM), similar to PFM mode, discontinuous conduction mode (DCM), and continuous conduction mode (CCM). The load current increases as the device transitions from AAM mode to DCM to CCM. If AAM is floated or pulled high (>2.5V), the MPM3620 operates in CCM.

AAM Control Operation

In a light-load condition, MPM3620 operates in AAM mode (see Figure 2). Connect a resistor from AAM to GND to set V_{AAM} . V_{COMP} is the error-amplifier output, which represents the peak inductor current information. When V_{COMP} is lower than V_{AAM} , the internal clock is blocked. This causes the MPM3620 to skip pulses, achieving the light-load power save. Refer to AN032 for additional details.

The internal clock re-sets every time V_{COMP} exceeds V_{AAM} . Simultaneously, the high-side MOSFET (HS-FET) turns on and remains on until $V_{ILsense}$ reaches the value set by V_{COMP} .

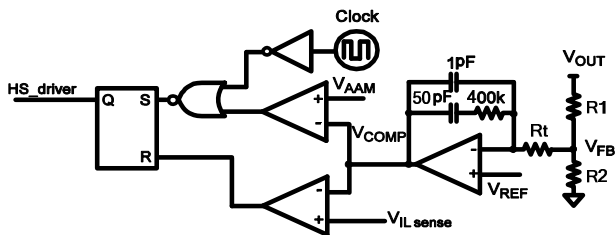

Figure 2. Simplified AAM Control Logic

DCM Control Operation

The V_{COMP} ramps up as the output current increases. When its minimum value exceeds V_{AAM} , the device enters DCM. In this mode the internal 2MHz clock initiates the PWM cycle, the HS-FET turns on and remains on until $V_{ILsense}$ reaches the value set by V_{COMP} (after a period of dead time), and then the low-side MOSFET (LS-FET) turns on and remains on until the inductor-current value decreases to

zero. The device repeats the same operation in every clock cycle to regulate the output voltage (see Figure 3).

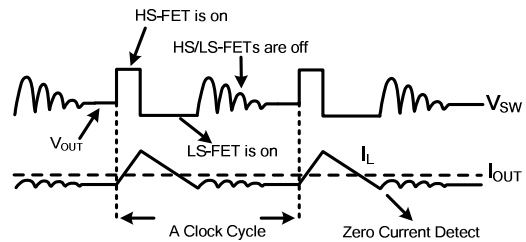

Figure 3. DCM Control Operation

CCM Control Operation

The device enters CCM from DCM once the inductor current no longer drops to zero in a clock cycle. In CCM, the internal 2MHz clock initiates the PWM cycle, the HS-FET turns on and remains on until $V_{ILsense}$ reaches the value set by V_{COMP} (after a period of dead time), and then the LS-FET turns on and remains on until the next clock cycle starts. The device repeats the same operation in every clock cycle to regulate the output voltage.

If $V_{ILsense}$ does not reach the value set by V_{COMP} within 77% of one PWM period, the HS-FET will be forced off.

Internal V_{CC} Regulator

A 5V internal regulator powers most of the internal circuitries. This regulator takes V_{IN} and operates in the full V_{IN} range. When V_{IN} exceeds 5V, the output of the regulator is in full regulation. If V_{IN} is less than 5V, the output decreases. The device integrates an internal decoupling capacitor, so adding an external VCC output capacitor is unnecessary.

Error Amplifier (EA)

The error amplifier compares the FB voltage to the internal 0.798V reference (V_{REF}) and outputs a current proportional to the difference between the two. This output current then charges or discharges the internal compensation network to form the COMP voltage; the COMP voltage controls the power MOSFET current. The optimized, internal compensation network minimizes the external component count and simplifies control loop design.

Under-Voltage Lockout (UVLO)

Under-voltage lockout (UVLO) protects the chip from operating at an insufficient input-supply voltage. The MPM3620 UVLO comparator monitors the output voltage of the internal regulator (VCC). The UVLO rising threshold is about 3.9V while its falling threshold is 3.25V.

Enable Control (EN)

EN turns the converter on and off. Drive EN high to turn on the converter; drive EN low to turn off the converter. An internal 1M Ω resistor from EN to GND allows EN to be floated to shut down the chip.

EN is clamped internally using a 6.5V series-Zener-diode (see Figure 4).

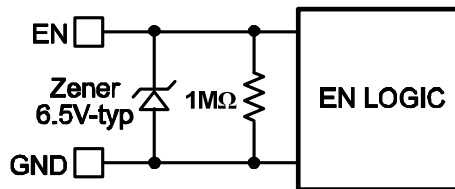

Figure 4. 6.5V Zener Diode Connection

Connecting EN to a voltage source directly without a pull-up resistor requires limiting the amplitude of the voltage source to $\leq 6V$ to prevent damage to the Zener diode.

Connecting the EN input through a pull-up resistor to the voltage on the V_{IN} pin limits the EN input current to less than 100 μA .

For example, with 12V connected to V_{in} , $R_{PULLUP} \geq (12V - 6.5V) \div 100\mu A = 55k\Omega$.

Internal Soft-Start (SS)

Soft-start prevents the converter output voltage from overshooting during start-up. When the chip starts up, the internal circuitry generates a soft-start voltage (SS) that ramps up from 0V to 5V. When SS is lower than V_{REF} (0.798V), the error amplifier uses SS as the reference. When SS is higher than V_{REF} , the error amplifier uses V_{REF} as the reference. The SS time is set internally to 1.5ms (V_{OUT} from 10% to 90%).

Pre-Bias Start-Up

The MPM3620 is designed for a monotonic start-up into a pre-biased output voltage. If the output is pre-biased to a certain voltage during start-up, the voltage on the soft-start capacitor

is charged. When the soft-start capacitor's voltage exceeds the sensed output voltage at FB, the device turns on the HS-FET and the LS-FET sequentially. Output voltage ramps up following the soft-start slew rate.

Over-Current Protection (OCP) and Hiccup

The MPM3620 has a cycle-by-cycle over-current limiting control. When the inductor current-peak value exceeds the internal peak current-limit threshold, the HS-FET turns off and the LS-FET turns on, remaining on until the inductor current falls below the internal valley current-limit threshold. The valley current-limit circuit is employed to decrease the operation frequency (after the peak current-limit threshold is triggered). Meanwhile, the output voltage drops until V_{FB} is below the under-voltage (UV) threshold (50% below the reference, typically). Once UV is triggered, the MPM3620 enters hiccup mode to re-start the part periodically. This protection mode is useful when the output is dead-short-circuited to ground and greatly reduces the average short-circuit current to alleviate thermal issues and protect the converter. The MPM3620 exits hiccup mode once the over-current condition is removed.

Thermal Shutdown (TSD)

To prevent thermal damage, MPM3620 stops switching when the die temperature exceeds 150°C. As soon as the temperature drops below its lower threshold (130°C, typically), the power supply resumes operation.

Floating Driver and Bootstrap Charging

An internal bootstrap capacitor powers the floating power MOSFET driver. This floating driver has its own UVLO protection. The UVLO's rising threshold is 2.2V with a hysteresis of 150mV. The bootstrap capacitor voltage is regulated internally by V_{IN} through D1, M1, C4, L1, and C2 (see Figure 5). If $(V_{BST} - V_{SW})$ exceeds 5V, U1 regulates M1 to maintain a 5V voltage across C4.

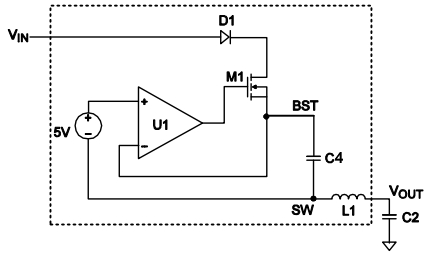

Figure 5. Internal Bootstrap Charging Circuit

Start-Up and Shutdown

If both V_{IN} and V_{EN} exceed their respective thresholds, the chip starts up. The reference block starts first, generating stable reference voltage, and then the internal regulator is enabled. The regulator provides a stable supply for the remaining circuitries.

Three events shut down the chip: V_{IN} low, V_{EN} low, and thermal shutdown. During the shutdown procedure, the signaling path is blocked first to avoid any fault triggering. The COMP voltage and the internal supply rail are then pulled down. The floating driver is not subject to this shutdown command.

Additional RC Snubber Circuit

An additional RC snubber circuit can be chosen to clamp the voltage spike and damp the ringing voltage for better EMI performance.

The power dissipation of the RC snubber circuit is estimated by the formula below:

$$P_{Loss} = f_s \times C_s \times V_{IN}^2$$

Where f_s is the switching frequency, C_s is the snubber capacitor, and V_{IN} is the input voltage.

For improved efficiency, the value of C_s should not be set too high. Generally, a 5.6Ω R_s and a 330pF C_s are recommended to generate the RC snubber circuit (see Figure 6).

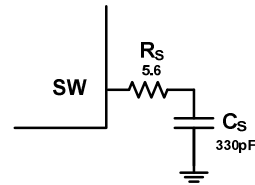

Figure 6. Additional RC Snubber Circuit

APPLICATION INFORMATION

Setting the Output Voltage

The external resistor divider sets the output voltage (see “Typical Application” on page 1). Choose R1 (refer to Table 1); R2 is then given by:

$$R2 = \frac{R1}{\frac{V_{OUT}}{0.798V} - 1}$$

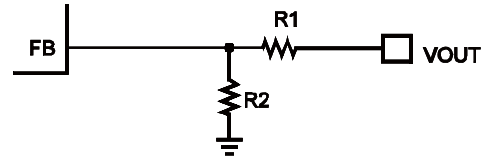

Figure 7. Feedback Network

See Table 1 and Figure 7 for the feedback network and a list of recommended feedback network parameters for common output voltages.

Table 1. Recommended Parameters for Common Output Voltages

| | | | Small Solution Size(C _{IN} =10μF, C _{OUT} =22μF/0805/16V) | | | | | Low V _{OUT} Ripple(C _{IN} =10μF, C _{OUT} =2X22μF/0805/16V) | | | | |
|---------------------|----------------------|-----------------------|---|---------|---|--|-------------------------------------|---|---------|---|--|-------------------------------------|
| V _{IN} (V) | V _{OUT} (V) | R _{AAM} (kΩ) | R1 (kΩ) | R2 (kΩ) | V _{OUT} PFM Ripple (mV) ⁽⁹⁾ | V _{OUT} PWM Ripple (mV) ⁽¹⁰⁾ | Load Transient (mV) ⁽¹¹⁾ | R1 (kΩ) | R2 (kΩ) | V _{OUT} PFM Ripple (mV) ⁽⁹⁾ | V _{OUT} PWM Ripple (mV) ⁽¹⁰⁾ | Load Transient (mV) ⁽¹¹⁾ |
| 24 | 5 | 33.2 | 160 | 30.1 | 106 | 19.2 | 168 | 75 | 14.3 | 35 | 10.4 | 96 |
| | 3.3 | 16.5 | 160 | 51 | 79 | 13.6 | 137 | 82 | 26.1 | 33 | 7.6 | 75 |
| | 2.5 | 10 | 180 | 84.5 | 76 | 10.8 | 116 | 102 | 47.5 | 37 | 5.8 | 70 |
| 21 | 5 | 38.3 | 160 | 30.1 | 97 | 17.6 | 172 | 75 | 14.3 | 32 | 9.4 | 98 |
| | 3.3 | 22.1 | 160 | 51 | 84 | 12.4 | 146 | 82 | 26.1 | 34 | 7 | 79 |
| | 2.5 | 16.2 | 180 | 84.5 | 81 | 10 | 120 | 102 | 47.5 | 36 | 5.2 | 78 |
| 19 | 5 | 43.2 | 160 | 30.1 | 87 | 16.4 | 170 | 75 | 14.3 | 31 | 8.8 | 96 |
| | 3.3 | 29.4 | 160 | 51 | 84 | 11.4 | 141 | 82 | 26.1 | 45 | 6.6 | 83 |
| | 2.5 | 19.6 | 160 | 75 | 76 | 9.8 | 113 | 102 | 47.5 | 38 | 5 | 80 |
| 16 | 5 | 51.3 | 160 | 30.1 | 82 | 15.6 | 176 | 75 | 14.3 | 29 | 7.8 | 96 |
| | 3.3 | 37.4 | 160 | 51 | 91 | 10.6 | 146 | 82 | 26.1 | 42 | 6 | 83 |
| | 2.5 | 26.1 | 160 | 75 | 70 | 9.6 | 116 | 102 | 47.5 | 41 | 4.8 | 82 |
| | 1.8 ⁽¹²⁾ | 17.4 | 180 | 143 | 68 | 8.6 | 108 | 102 | 82 | 31 | 4 | 70 |
| 14 | 5 | 57.6 | 160 | 30.1 | 70 | 14.8 | 172 | 75 | 14.3 | 27 | 7.4 | 95 |
| | 3.3 | 45.3 | 160 | 51 | 89 | 10.2 | 149 | 82 | 26.1 | 41 | 5.6 | 81 |
| | 2.5 | 34 | 160 | 75 | 74 | 9.4 | 120 | 102 | 47.5 | 44 | 4.6 | 88 |
| | 1.8 ⁽¹²⁾ | 26.1 | 180 | 143 | 73 | 8.4 | 114 | 102 | 82 | 37 | 4.2 | 75 |
| | 1.5 ⁽¹²⁾ | 20.5 | 180 | 205 | 62 | 7.2 | 103 | 120 | 137 | 36 | 3.6 | 72 |
| 12 | 5 | 63.4 | 160 | 30.1 | 70 | 13.8 | 174 | 75 | 14.3 | 25 | 6.4 | 91 |
| | 3.3 | 56 | 160 | 51 | 82 | 9.4 | 152 | 82 | 26.1 | 37 | 5.2 | 82 |
| | 2.5 | 42.2 | 160 | 75 | 66 | 9 | 125 | 82 | 38.3 | 35 | 4.4 | 76 |
| | 1.8 | 32.4 | 160 | 127 | 64 | 7.8 | 112 | 102 | 82 | 36 | 4 | 75 |
| | 1.5 ⁽¹²⁾ | 25.5 | 160 | 180 | 60 | 6.6 | 104 | 102 | 115 | 33 | 3.4 | 72 |
| | 1.2 ⁽¹²⁾ | 21 | 300 | 604 | 81 | 6.2 | 155 | 143 | 280 | 38 | 3 | 88 |

Table 1. Recommended Parameters For Common Output Voltages(continued)

| | | | Small Solution Size($C_{IN}=10\mu F$, $C_{OUT}=22\mu F/0805/16V$) | | | | | Low V_{OUT} Ripple($C_{IN}=10\mu F$, $C_{OUT}=2X22\mu F/0805/16V$) | | | | |
|-----------------|---------------------|----------------------------|---|---------------------|---|--|---|--|---------------------|---|--|---|
| V_{IN} (V) | V_{OUT} (V) | R_{AAM} (k Ω) | R1 (k Ω) | R2 (k Ω) | V_{OUT} PFM Ripple (mV) ⁽⁹⁾ | V_{OUT} PWM Ripple (mV) ⁽¹⁰⁾ | Load Transient (mV) ⁽¹¹⁾ | R1 (k Ω) | R2 (k Ω) | V_{OUT} PFM Ripple (mV) ⁽⁹⁾ | V_{OUT} PWM Ripple (mV) ⁽¹⁰⁾ | Load Transient (mV) ⁽¹¹⁾ |
| 10 | 5 | 76.8 | 160 | 30.1 | 73 | 13.2 | 172 | 75 | 14.3 | 44 | 6.2 | 96 |
| | 3.3 | 63.4 | 143 | 45.3 | 78 | 8.4 | 136 | 82 | 26.1 | 35 | 4.8 | 87 |
| | 2.5 | 51 | 143 | 66.5 | 55 | 8.2 | 118 | 82 | 38.3 | 28 | 4 | 78 |
| | 1.8 | 38.3 | 143 | 113 | 54 | 7.2 | 106 | 102 | 82 | 32 | 3.6 | 81 |
| | 1.5 ⁽¹²⁾ | 33 | 160 | 180 | 57 | 6 | 111 | 102 | 115 | 31 | 3.2 | 76 |
| | 1.2 ⁽¹²⁾ | 26.7 | 221 | 442 | 78 | 5.4 | 140 | 102 | 200 | 31 | 2.8 | 74 |
| | 1 ⁽¹²⁾ | 21 | 221 | 887 | 61 | 4.8 | 134 | 160 | 649 | 39 | 2.6 | 106 |
| 8 | 5 | 88.7 | 160 | 30.1 | 82 | 9.2 | 166 | 75 | 14.3 | 38 | 5 | 93 |
| | 3.3 | 73.2 | 143 | 45.3 | 74 | 7.6 | 143 | 82 | 26.1 | 31 | 3.8 | 91 |
| | 2.5 | 59 | 143 | 66.5 | 56 | 7 | 124 | 82 | 38.3 | 28 | 3.4 | 77 |
| | 1.8 | 48.7 | 143 | 113 | 47 | 6.4 | 114 | 82 | 64.9 | 27 | 3 | 72 |
| | 1.5 ⁽¹²⁾ | 40.2 | 160 | 180 | 52 | 5.4 | 120 | 102 | 115 | 28 | 2.8 | 84 |
| | 1.2 ⁽¹²⁾ | 33.2 | 143 | 280 | 49 | 5 | 105 | 102 | 200 | 28 | 2.6 | 78 |
| | 1 ⁽¹²⁾ | 28.7 | 143 | 562 | 63 | 4.6 | 97 | 102 | 402 | 29 | 2.2 | 75 |
| 5 | 3.3 | 88.7 | 143 | 45.3 | 42 | 6 | 137 | 62 | 19.6 | 17 | 3.4 | 74 |
| | 2.5 | 78.7 | 143 | 66.5 | 49 | 5.8 | 140 | 75 | 34.8 | 22 | 3.2 | 76 |
| | 1.8 | 66.5 | 143 | 113 | 44 | 5.2 | 124 | 75 | 59 | 23 | 2.8 | 71 |
| | 1.5 ⁽¹²⁾ | 57.8 | 143 | 162 | 46 | 5 | 118 | 82 | 93.1 | 26 | 2.4 | 76 |
| | 1.2 ⁽¹²⁾ | 47.5 | 143 | 280 | 44 | 4.6 | 116 | 82 | 162 | 26 | 2.2 | 73 |
| | 1 ⁽¹²⁾ | 42.2 | 143 | 562 | 50 | 4.4 | 109 | 102 | 402 | 29 | 2 | 83 |

Notes:

- 9) V_{OUT} PFM ripple is tested when $I_o=0A$, for those specs noted (12), the ripple is tested when $I_o=1mA$.
- 10) V_{OUT} PWM ripple is tested when $I_o=2A$.
- 11) Load transient from 1A to 2A, slew rate = 0.8A/ μs .
- 12) In these specs, BST operation current will charge the output voltage higher than the setting value when there is completely no load, due to a large divider resistor value. A 10 μA load current can pull the output voltage to a normal regulation level.

Normally, it is recommended to set output voltage from 0.8V to 5.5V. However, it can be set larger than 5.5V. In this case, the output-voltage ripple is larger due to a larger inductor-ripple current. An additional output capacitor is needed to reduce the output-ripple voltage.

If output voltage is high, heat dissipation becomes more important. Please refer to the “PCB Layout Guidelines” section on page 19 to achieve better thermal performance.

For thermal consideration, the relationship curve between output voltage and maximum output

current is shown in Figure 8:

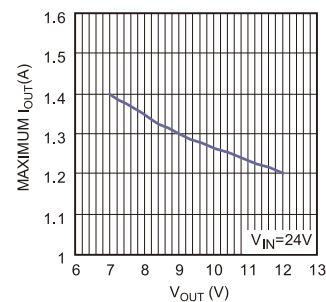
Figure 8: Maximum Output Current vs. Output Voltage

Selecting the Input Capacitor

The input current to the step-down converter is discontinuous, and therefore requires a capacitor to supply the AC current while maintaining the DC input voltage. Use low ESR capacitors for improved performance. Use ceramic capacitors with X5R or X7R dielectrics for optimum results because of their low ESR and small temperature coefficients. For most applications, use a 10µF capacitor.

Since C1 absorbs the input-switching current, it requires an adequate ripple-current rating. The RMS current in the input capacitor is estimated by:

$$I_{C1} = I_{LOAD} \times \sqrt{\frac{V_{OUT}}{V_{IN}} \times \left(1 - \frac{V_{OUT}}{V_{IN}}\right)}$$

The worst case condition occurs at $V_{IN} = 2V_{OUT}$, where:

$$I_{C1} = \frac{I_{LOAD}}{2}$$

For simplification, choose an input capacitor with an RMS current rating greater than half of the maximum load current.

The input capacitor can be electrolytic, tantalum, or ceramic. When using electrolytic or tantalum capacitors, add a small, high-quality ceramic capacitor (e.g. 0.1µF) placed as close to the IC as possible. When using ceramic capacitors, make sure they have enough capacitance to provide sufficient charge in order to prevent excessive voltage ripple at input. The input-voltage ripple caused by capacitance can be estimated as:

$$\Delta V_{IN} = \frac{I_{LOAD}}{f_s \times C1} \times \frac{V_{OUT}}{V_{IN}} \times \left(1 - \frac{V_{OUT}}{V_{IN}}\right)$$

Setting the AAM Voltage

The AAM voltage is used to set the transition point from AAM to CCM. AAM voltage should be chosen to provide the best combination of efficiency, stability, ripple, and transient. Drive AAM high (>2.5V) to force the MPM3620 always operate in CCM.

If the AAM voltage is set lower than the recommended value, then stability and ripple improve, however, efficiency during AAM mode

and transient degrades. Likewise, if the AAM voltage is set higher than the recommended

value, then the efficiency during AAM and transient improves, with stability and ripple degrading. Therefore calculate the optimal balance point of AAM voltage for good efficiency, stability, ripple, and transient.

Adjust the AAM threshold by connecting a resistor from AAM to ground (see Figure 9). An internal 6.2µA current source charges the external resistor.

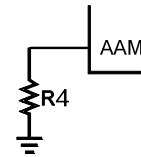

Figure 9. AAM Network

Generally, R4 is then given by:

$$V_{AAM} = R4 \times 6.2\mu A$$

Refer to Figure 10 when setting the AAM resistor.

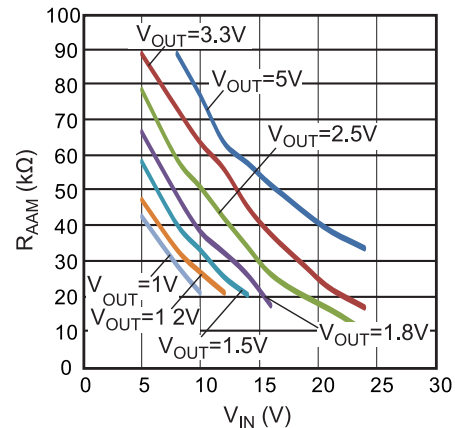

Figure 10. Recommended AAM Resistor Selection

Selecting the Output Capacitor

The output capacitor (C2) maintains the DC output voltage. Use ceramic, tantalum, or low ESR electrolytic capacitors. For best results, use low ESR capacitors to keep the output-voltage ripple low. The output-voltage ripple is estimated as:

$$\Delta V_{OUT} = \frac{V_{OUT}}{f_s \times L_1} \times \left(1 - \frac{V_{OUT}}{V_{IN}}\right) \times \left(R_{ESR} + \frac{1}{8 \times f_s \times C2}\right)$$

Where L_1 is the inductor value, R_{ESR} is the equivalent series resistance (ESR) value of the output capacitor, and $L_1=1\mu\text{H}$.

For ceramic capacitors, the capacitance dominates the impedance at the switching frequency; the capacitance causes the majority of the output-voltage ripple. For simplification, the output-voltage ripple can be estimated as:

$$\Delta V_{OUT} = \frac{V_{OUT}}{8 \times f_s^2 \times L_1 \times C_2} \times \left(1 - \frac{V_{OUT}}{V_{IN}} \right)$$

For tantalum or electrolytic capacitors, the ESR dominates the impedance at the switching frequency. For simplification, the output ripple can be approximated as:

$$\Delta V_{OUT} = \frac{V_{OUT}}{f_s \times L_1} \times \left(1 - \frac{V_{OUT}}{V_{IN}} \right) \times R_{ESR}$$

The characteristics of the output capacitor affect the stability of the regulation system. The MPM3620 internal compensation is optimized for a wide range of capacitance and ESR values.

PCB Layout Guidelines ⁽¹³⁾

Efficient PCB layout is critical to achieve stable operation, particularly for input capacitor placement. For best results, refer to Figure 11 and follow the guidelines below:

1. Use large ground plane to connect directly to PGND. If the bottom layer is ground plane, add vias near PGND.
2. The high-current paths (PGND, IN, and OUT) should have short, direct, and wide traces. Place the ceramic input capacitor close to IN and PGND. Keep the input capacitor and IN connection as short and wide as possible.
3. Place the external feedback resistors next to FB.
4. Keep the feedback network away from the switching node.

Notes:

13) The recommended layout is based on the "Typical Application Circuits" on pages 21-23.

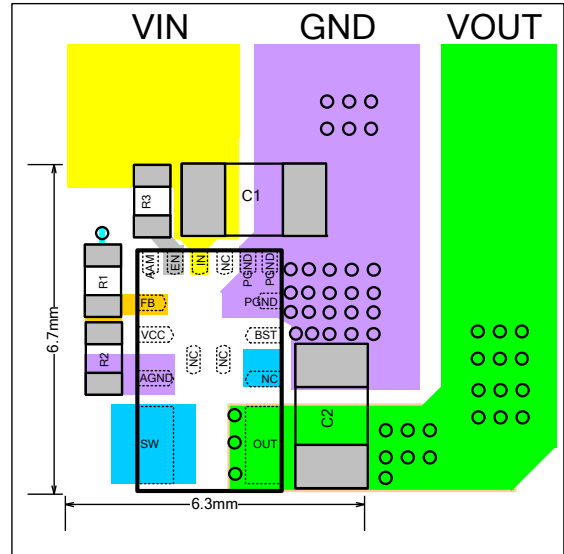

Top Layer

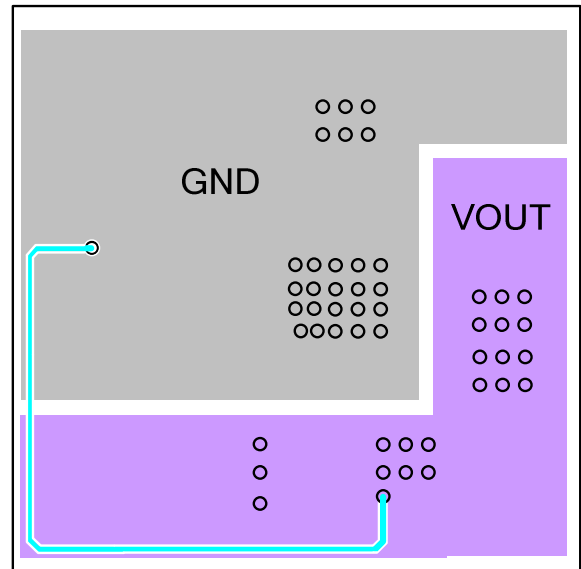

Bottom Layer

Figure 11. Recommended PCB Layout

Design Example

Table 2 below is a design example following the application guidelines for the specifications:

Table 2. Design Example

| | |
|-----------|------|
| V_{IN} | 12V |
| V_{OUT} | 3.3V |
| I_o | 2A |

The detailed application schematic is shown in Figure 13. The typical performance and circuit waveforms have been shown in the “Typical Performance Characteristics” section. For more device applications, please refer to the related evaluation board datasheets.

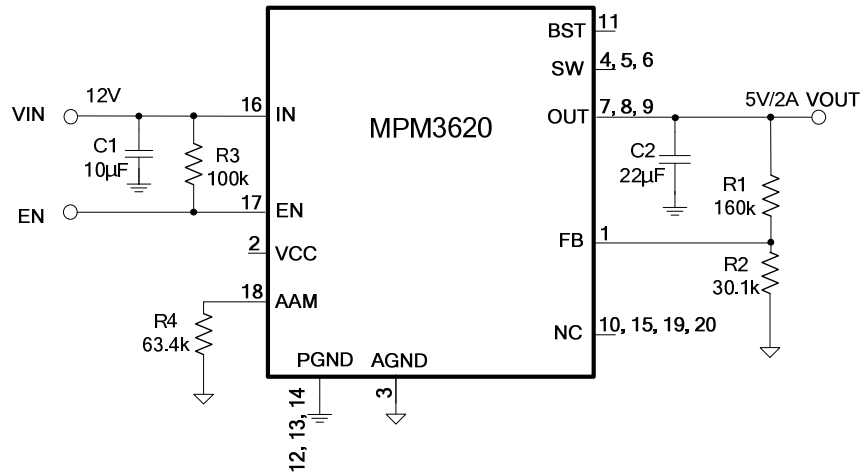
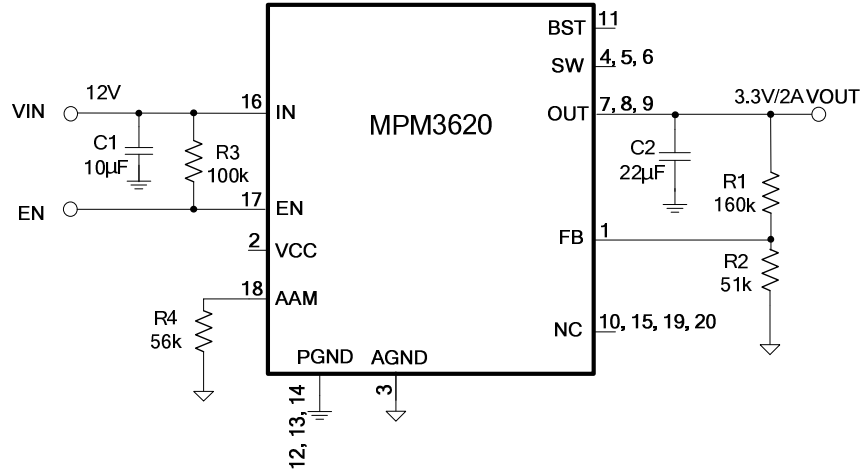
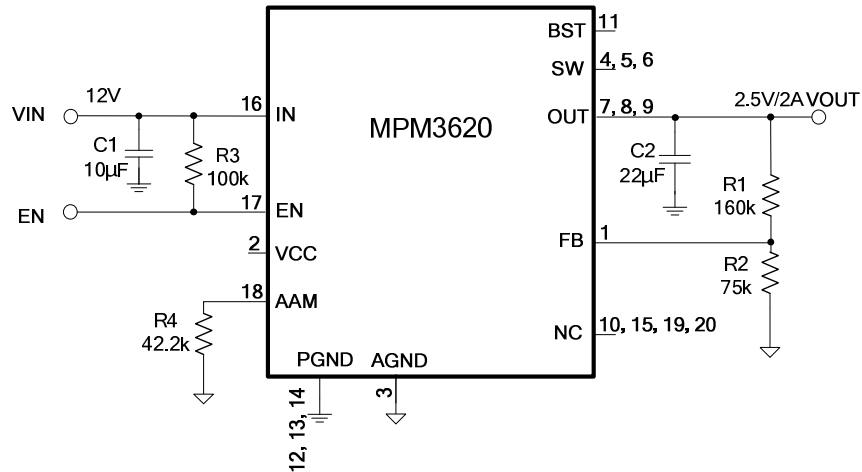
TYPICAL APPLICATION CIRCUITS (14)(15)

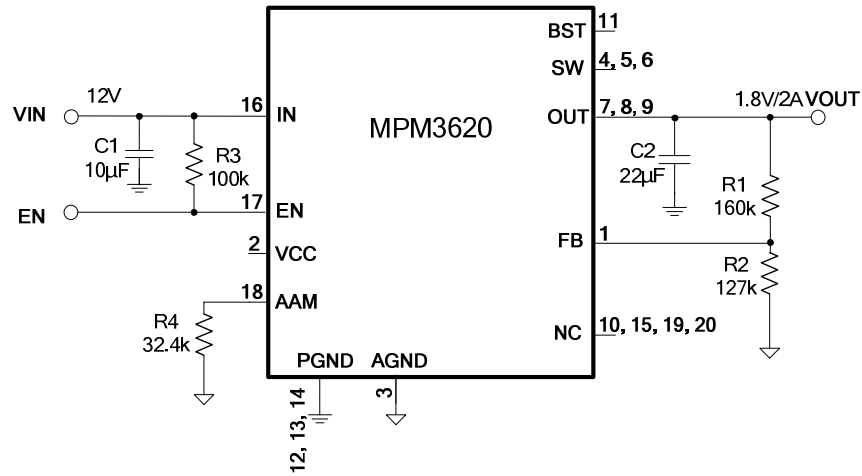
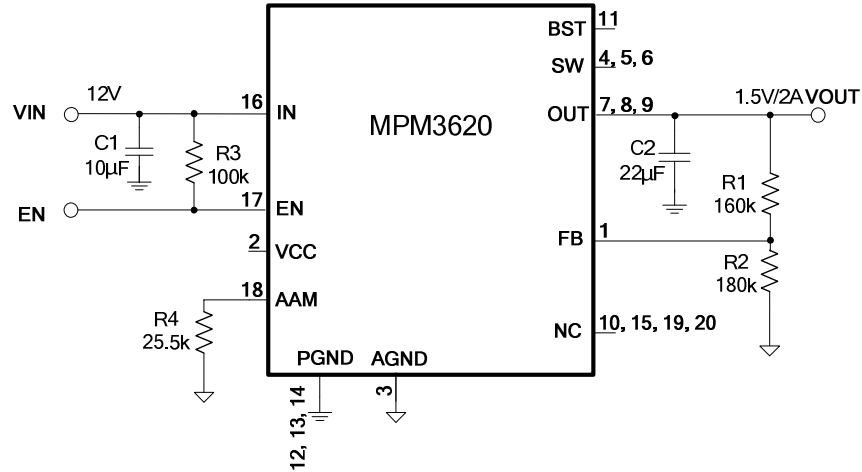
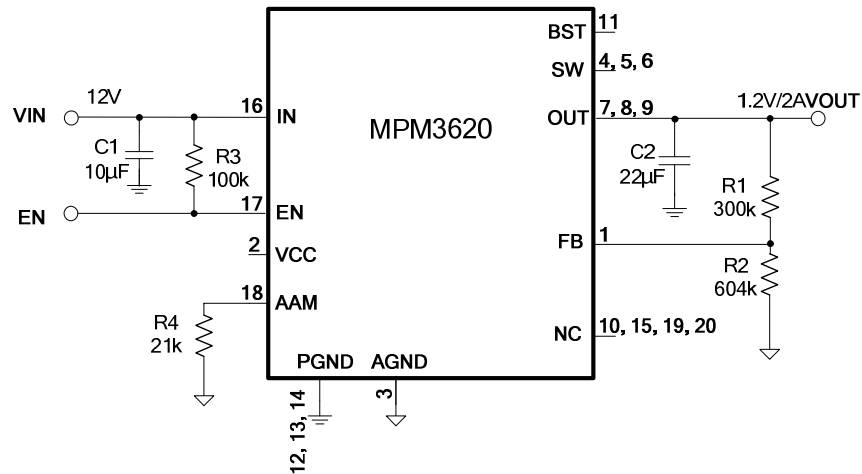
Figure 12. $V_{OUT}=5V$, $I_{OUT}=2A$

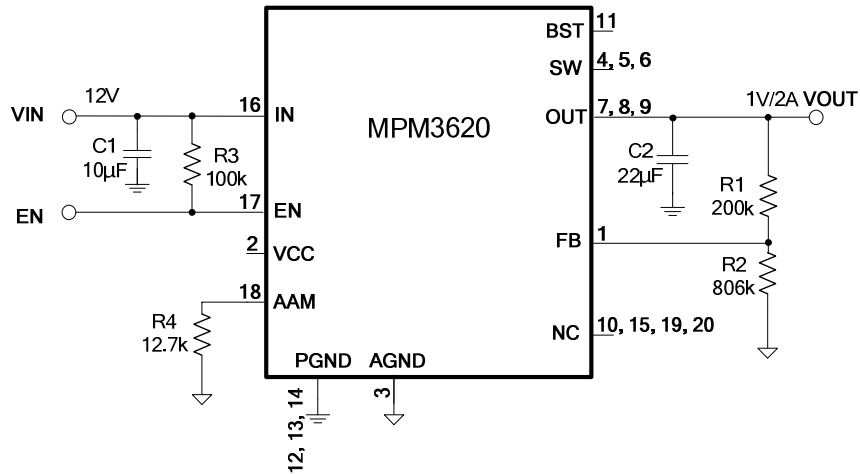
Figure 13. $V_{OUT}=3.3V$, $I_{OUT}=2A$

Figure 14. $V_{OUT}=2.5V$, $I_{OUT}=2A$

TYPICAL APPLICATION CIRCUITS (continued)

Figure 15. $V_{OUT}=1.8V$, $I_{OUT}=2A$

Figure 16. $V_{OUT}=1.5V$, $I_{OUT}=2A$

Figure 17. $V_{OUT}=1.2V$, $I_{OUT}=2A$

TYPICAL APPLICATION CIRCUITS (Continued)

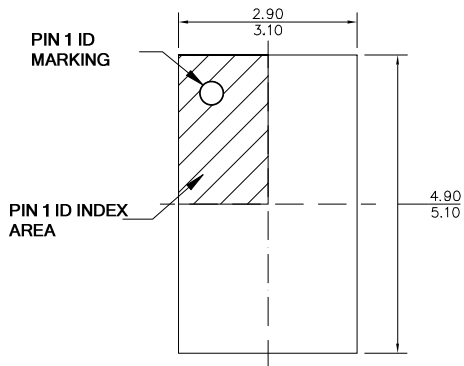
Figure 18. $V_{OUT}=1V$, $I_{OUT}=2A$
Notes:

- 14) In $12V_{IN}$ to $1V_{OUT}$ application conditions, the HS-FET's on-time is close to the minimum on-time; although the SW may have a little jitter, the output-voltage ripple is smaller than 15mV in PWM mode.
- 15) In $12V_{IN}$ to $1.5/1.2/1 V_{OUT}$ application conditions, the BST operation current will charge the output voltage higher than the setting value when there is completely no load, due to a large divider resistor value. A $10\mu A$ load current can pull the output voltage to a normal regulation level.

PACKAGE INFORMATION

QFN-20 (3mmx5mmx1.6mm)



TOP VIEW

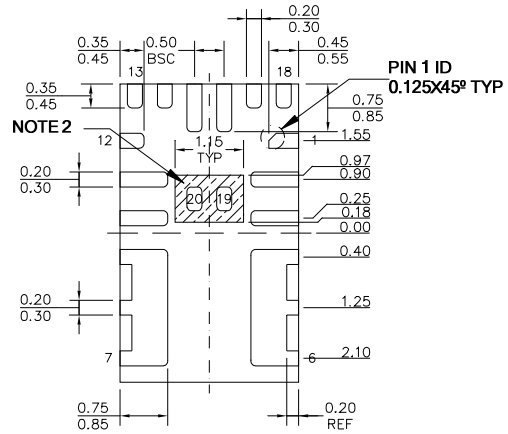

BOTTOM VIEW

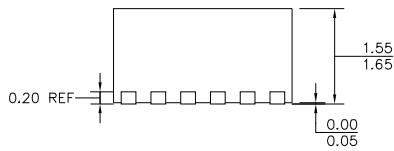

SIDE VIEW

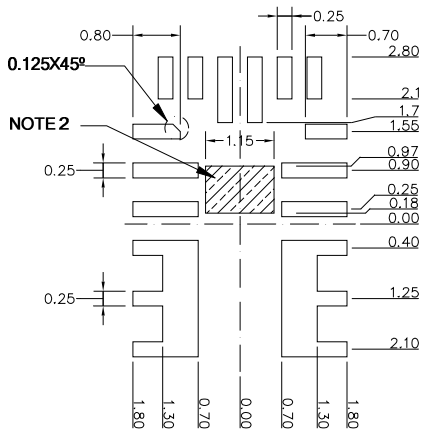

RECOMMENDED LAND PATTERN

NOTE:

- 1) ALL DIMENSIONS ARE IN MILLIMETERS.
- 2) SHADED AREA IS THE KEEP-OUT ZONE. ANY PCB METAL TRACE AND VIA ARE NOT ALLOWED TO CONNECT TO THIS AREA ELECTRICALLY OR MECHANICALLY.
- 3) LEAD COPLANARITY SHALL BE 0.10 MILLIMETERS MAX.
- 4) JEDEC REFERENCE IS MO-220.
- 5) DRAWING IS NOT TO SCALE.

NOTICE: The information in this document is subject to change without notice. Users should warrant and guarantee that third party Intellectual Property rights are not infringed upon when integrating MPS products into any application. MPS will not assume any legal responsibility for any said applications.

X-ON Electronics

Largest Supplier of Electrical and Electronic Components

Click to view similar products for [Switching Voltage Regulators](#) category:

Click to view products by [Monolithic Power Systems](#) manufacturer:

Other Similar products are found below :

[FAN53610AUC33X](#) [FAN53611AUC123X](#) [FAN48610BUC33X](#) [FAN48610BUC45X](#) [FAN48617UC50X](#) [R3](#) [430464BB](#) [KE177614](#)
[MAX809TTR](#) [NCV891234MW50R2G](#) [NCP81103MNTXG](#) [NCP81203PMNTXG](#) [NCP81208MNTXG](#) [NCP81109GMNTXG](#)
[SCY1751FCCT1G](#) [NCP81109JMNTXG](#) [AP3409ADNTR-G1](#) [NCP81241MNTXG](#) [LTM8064IY](#) [LT8315EFE#TRPBF](#) [NCV1077CSTBT3G](#)
[XCL207A123CR-G](#) [MPM54304GMN-0002](#) [MPM54304GMN-0003](#) [XDPE132G5CG000XUMA1](#) [MP8757GL-P](#) [MIC23356YFT-TR](#)
[LD8116CGL](#) [HG2269M/TR](#) [OB2269](#) [XD3526](#) [U6215A](#) [U6215B](#) [U6620S](#) [LTC3803ES6#TR](#) [LTC3803ES6#TRM](#) [LTC3412IFE](#) [LT1425IS](#)
[MAX25203BATJA/VY+](#) [MAX77874CEWM+](#) [XC9236D08CER-G](#) [ISL95338IRTZ](#) [MP3416GJ-P](#) [BD9S201NUX-CE2](#) [MP5461GC-Z](#)
[MPQ4415AGQB-Z](#) [MPQ4590GS-Z](#) [MCP1603-330IMC](#) [MCP1642B-18IMC](#) [MCP1642D-ADJIMC](#)