

DESCRIPTION

The MPQ8612 is fully integrated high frequency synchronous rectified step-down switch mode converter. It offers very compact solutions to achieve 12A output current from a 3V to 6V input with excellent load and line regulation.

Constant-On-Time (COT) control mode provides fast transient response and eases loop stabilization. The MPQ8612 can operate with a low-cost electrolytic capacitor and can support ceramic output capacitor with external slope compensation.

Operating frequency is programmed by an external resistor and is compensated for variations in V_{IN} .

Under voltage lockout is internally set at 2.8 V, but can be increased by programming the threshold with a resistor network on the enable pin. The output voltage startup ramp is controlled by the soft start pin. A power good signal indicates the output is within its nominal voltage range.

Full fault protection including OCP, SCP, OVP UVP and OTP is provided by internal comparators.

The MPQ8612 requires a minimum number of readily available standard external components and are available in QFN3X4 packages.

FEATURES

- 1.5V to 6V Wide Input Range
- 3V to 6V VCC Operating Supply
- 12A Output Current
- Low $R_{DS(ON)}$ Internal Power MOSFETs
- Proprietary Switching Loss Reduction Technique
- Adaptive COT for Ultrafast Transient Response
- 1% Reference Voltage Over -20°C to $+85^{\circ}\text{C}$ Junction Temperature Range
- Programmable Soft Start Time
- Pre-Bias Start up
- Programmable Switching Frequency from 300kHz to 1MHz.
- Minimum On Time $T_{ON_MIN}=60\text{ns}$
Minimum Off Time $T_{OFF_MIN}=75\text{ns}$
- Non-latch OCP, non-latch OVP Protection and Thermal Shutdown
- Output Adjustable from 0.608V to 4.5V

APPLICATIONS

- Telecom System Base Stations
- Networking Systems
- Server
- Personal Video Recorders
- Flat Panel Television and Monitors
- Distributed Power Systems

All MPS parts are lead-free and adhere to the RoHS directive. For MPS green status, please visit MPS website under Products, Quality Assurance page. "MPS" and "The Future of Analog IC Technology" are registered trademarks of Monolithic Power Systems, Inc.

TYPICAL APPLICATION

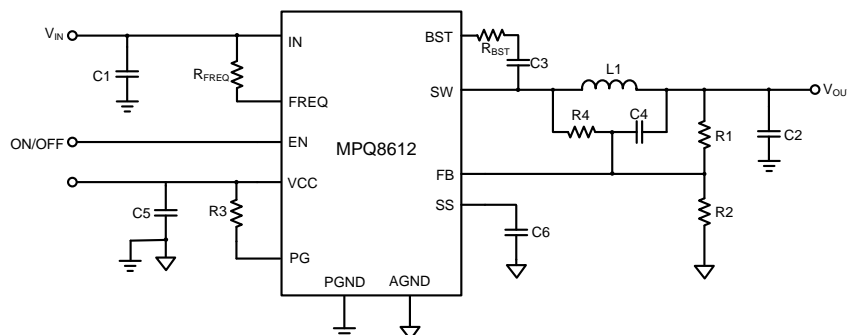

ORDERING INFORMATION

Part Number*	Package	Top Marking
MPQ8612GL-12	QFN (3x4mm)	MP8612 12

* For Tape & Reel, add suffix -Z (e.g. MPQ8612GL-Z);

PACKAGE REFERENCE

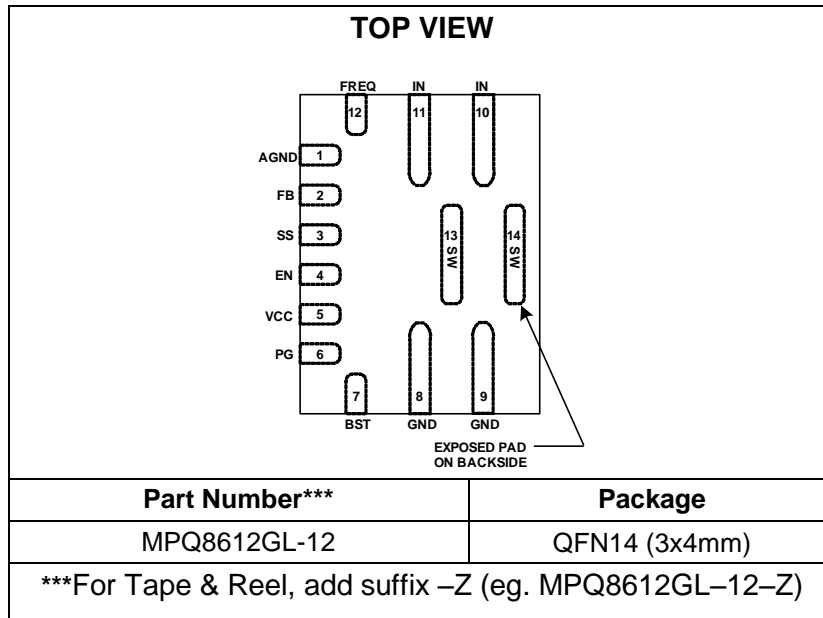

ABSOLUTE MAXIMUM RATINGS ⁽¹⁾

Supply Voltage V_{IN}	6.5V
V_{SW}	-0.3V to $V_{IN} + 0.3V$
V_{SW} (30ns)	-3V to $V_{IN} + 3V$
$V_{IN} - V_{SW}$	-0.3V to $V_{IN} + 0.3V$
$V_{IN} - V_{SW}$ (30ns)	-3V to $V_{IN} + 3V$
V_{BST}	$V_{SW} + 6V$
All Other Pins.....	-0.3V to +6V
Continuous Power Dissipation ($T_A=+25^\circ$) ⁽²⁾	
QFN(3x4mm).....	2.6W
Junction Temperature	150°C
Lead Temperature	260°C
Storage Temperature.....	-65°C to +150°C

Recommended Operating Conditions ⁽³⁾

Input Supply Voltage V_{IN}	1.5V to 6V
VCC Supply Voltage V_{CC}	3V to 6V
Output Voltage V_{OUT}	0.608V to 4.5V
Operating Junction Temp. (T_J).	-40°C to +125°C

Thermal Resistance ⁽⁴⁾	θ_{JA}	θ_{JC}
QFN (3x4mm)	48	10... °C/W

Notes:

- 1) Exceeding these ratings may damage the device.
- 2) The maximum allowable power dissipation is a function of the maximum junction temperature $T_J(MAX)$, the junction-to-ambient thermal resistance θ_{JA} , and the ambient temperature T_A . The maximum allowable continuous power dissipation at any ambient temperature is calculated by $P_D(MAX)=(T_J(MAX)-T_A)/\theta_{JA}$. Exceeding the maximum allowable power dissipation will cause excessive die temperature, and the regulator will go into thermal shutdown. Internal thermal shutdown circuitry protects the device from permanent damage.
- 3) The device is not guaranteed to function outside of its operating conditions.
- 4) Measured on JESD51-7, 4-layer PCB.

ELECTRICAL CHARACTERISTICS
 $V_{IN} = 5V$, $T_J = -40$ to $+125^{\circ}C$, unless otherwise noted.

Parameters	Symbol	Condition	Min	Typ	Max	Units
Supply Current						
Supply Current (Shutdown)	I_{IN}	$V_{EN} = 0V$		0.001	2	μA
Supply Current (Quiescent)	I_{IN}	$V_{EN} = 2V$, $V_{FB} = 1V$, MPQ8612-12	850	1100	1300	μA
MOSFET						
High-side Switch On Resistance	HS_{RDS-ON}	MPQ8612-12, $T_J = 25^{\circ}C$		10	18	$m\Omega$
Low-side Switch On Resistance	LS_{RDS-ON}	MPQ8612-12, $T_J = 25^{\circ}C$		7.8	10	$m\Omega$
Switch Leakage	SW_{LKG}	$V_{EN} = 0V$, $V_{SW} = 0V$ or $5V$, $T_J = 25^{\circ}C$		0.001	5	μA
Current Limit						
High-side Current Limit	I_{LIMIT}	MPQ8612-12	17	21	26	A
Timer						
One-Shot On Time	t_{ON}	$R_{FREQ} = 82k\Omega$, $V_{OUT} = 1.2V$, MPQ8612-12		170		ns
Minimum Off Time	t_{OFF}	MPQ8612-12	30	75	150	ns
Fold back Timer ⁽⁵⁾	$t_{FOLDBACK}$	OCP Happens		2.5		μs
Over-voltage and Under-voltage Protection						
OVP Threshold	V_{OVP1}		110	120	130	$\%V_{REF}$
OVP Delay ⁽⁵⁾	t_{OVP}			1		μs
UVP Threshold ⁽⁵⁾	V_{UVP}			50		$\%V_{REF}$

ELECTRICAL CHARACTERISTICS *(continued)*
 $V_{IN} = 5V$, $T_J = -40$ to $+125^{\circ}C$, unless otherwise noted.

Parameters	Symbol	Condition	Min	Typ	Max	Units
Reference And Soft Start						
Reference Voltage	V_{REF}	$T_J = -20^{\circ}C$ to $+85^{\circ}C$, MPQ8612-12	602	608	614	mV
		$T_J = -40^{\circ}C$ to $+125^{\circ}C$, MPQ8612-12	599	608	617	
Feedback Current	I_{FB}	$V_{FB} = 608mV$		0.001	50	nA
Soft Start Charging Current	I_{SS}	$V_{SS}=0V$	5.5	7.5	9	μA
Enable And UVLO						
Enable Rising Threshold	EN_{Vth-Hi}		1.4		1.8	V
Enable Hysteresis	EN_{Vth-Hy}			890		mV
Enable Input Current	I_{EN}	$V_{EN} = 2V$	1	1.5	2	μA
		$V_{EN} = 0V$		0.001		
VCC UVLO						
VCC Under Voltage Lockout Threshold Rising	VCC_{Vth}		2.3	2.8	2.95	V
VCC Under Voltage Lockout Threshold Hysteresis	VCC_{HYS}			300		mV
Power Good						
Power Good Rising Threshold	PG_{Vth-Hi}		84	90	96	$\%V_{REF}$
Power Good Falling Threshold	PG_{Vth-L0}		63	70	73	$\%V_{REF}$
Power Good Deglitch Timer	PG_{Td}	$T_{SS}=1ms$,		1.6	2.2	ms
Power Good Sink Current Capability	V_{PG}	Sink 4mA			0.4	V
Power Good Leakage Current	I_{PG_LEAK}	$V_{PG} = 3.3V$			50	nA
Thermal Protection						
Thermal Shutdown	T_{SD}	Note 5	150	160		$^{\circ}C$
Thermal Shutdown Hysteresis				25		$^{\circ}C$

Note:

5) Guaranteed by design.

TYPICAL CHARACTERISTICS

Performance waveforms are tested on the evaluation board of the Design Example section. $V_{IN}=5V$, $V_{CC}=5V$, $V_{OUT}=1.2V$, $L=1.0\mu H$, $T_A=+25^\circ C$, unless otherwise noted.

Supply Current (Shutdown) vs. Temperature

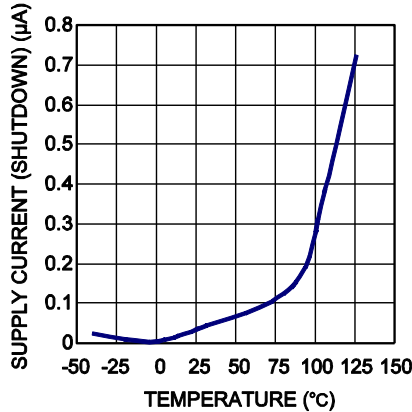

Supply Current (Quiescent) vs. Temperature

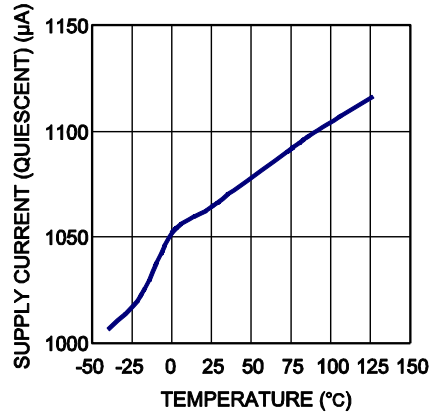

HS-FET R_{DS-ON} vs. Temperature

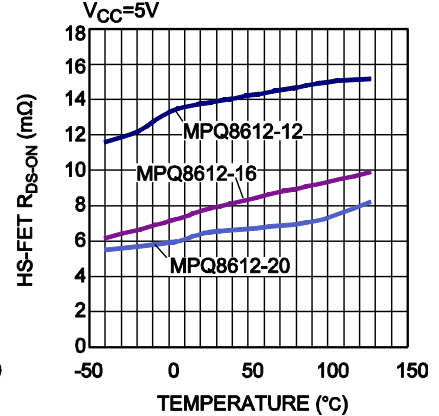

LS-FET R_{DS-ON} vs. Temperature

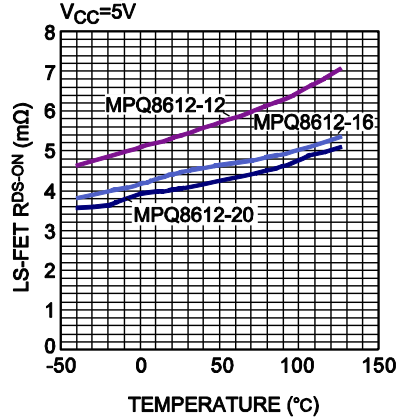

HS-FET Current Limit vs. Temperature

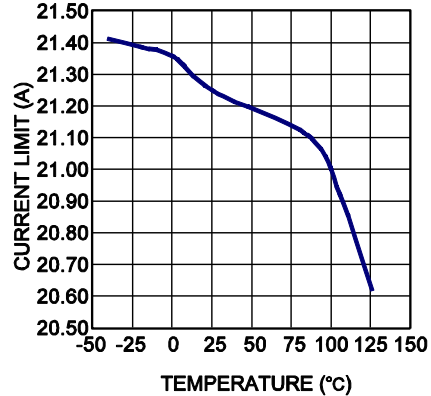

HS-FET Current Limit vs. Temperature

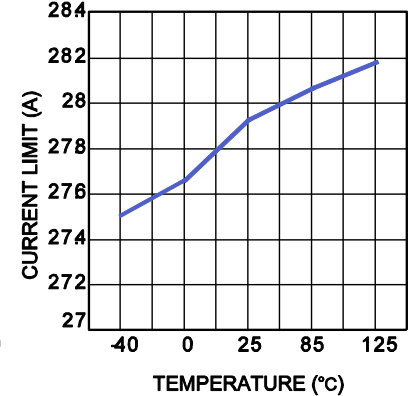

HS-FET Current Limit vs. Temperature

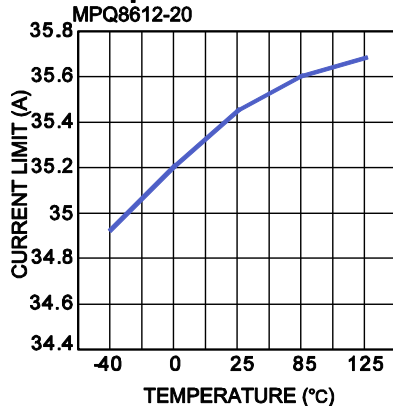

One-Shot-Time vs. Temperature

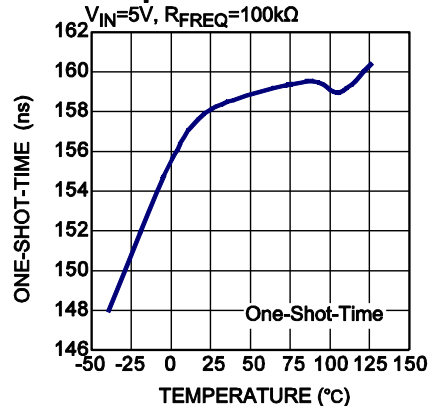

Switching Frequency vs. Temperature

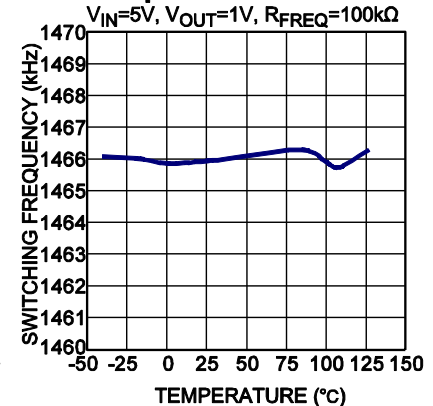

TYPICAL CHARACTERISTICS *(continued)*

Performance waveforms are tested on the evaluation board of the Design Example section.
 $V_{IN}=5V$, $V_{CC}=5V$, $V_{OUT}=1.2V$, $L=1.0\mu H$, $T_A=+25^\circ C$, unless otherwise noted.

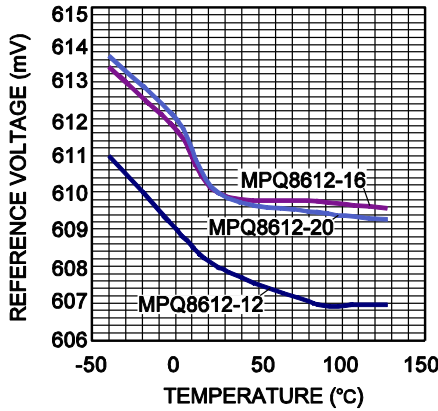
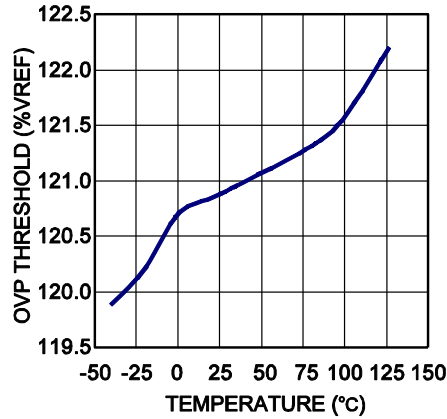
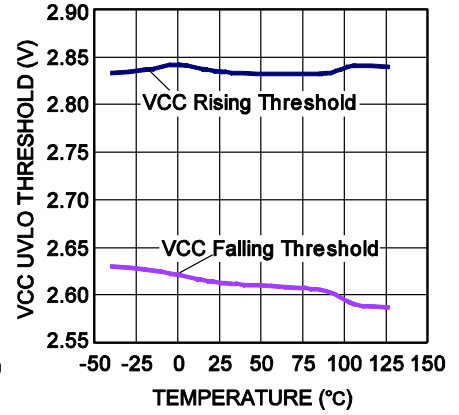
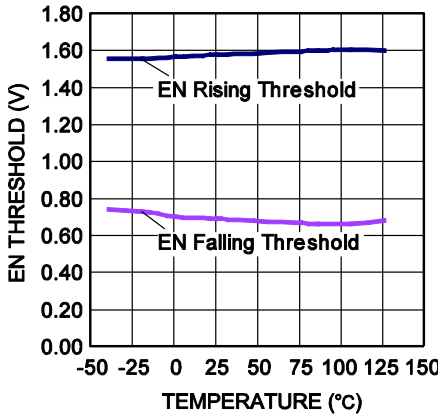
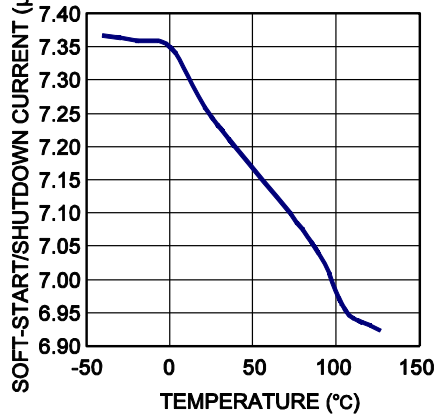
Reference Voltage vs. Temperature

OVP Threshold vs. Temperature

VCC UVLO Threshold vs. Temperature

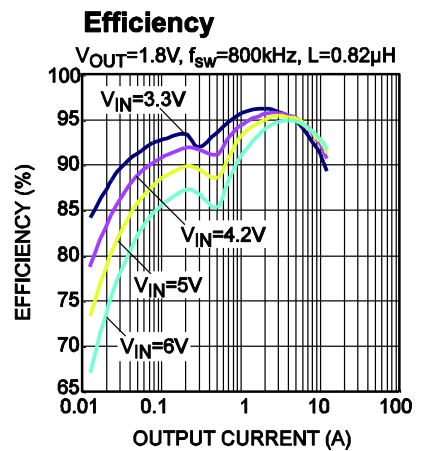
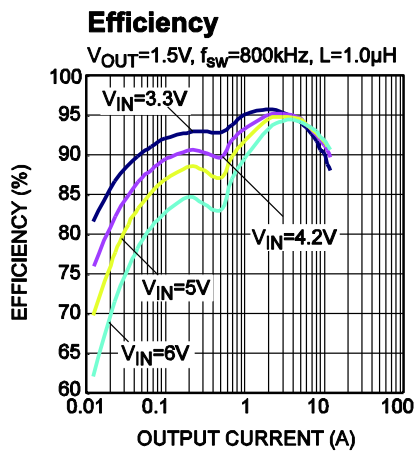
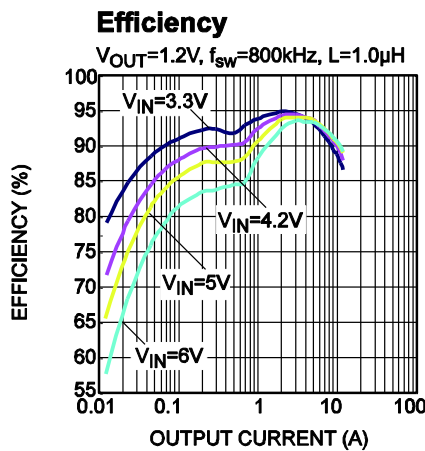
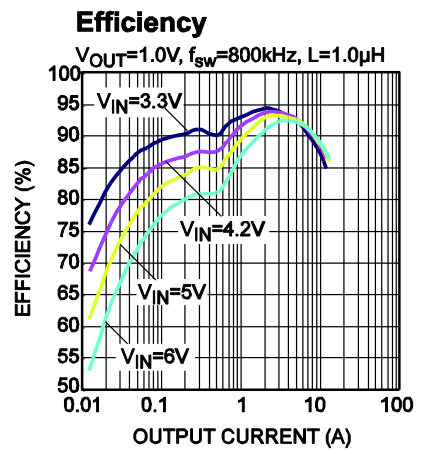
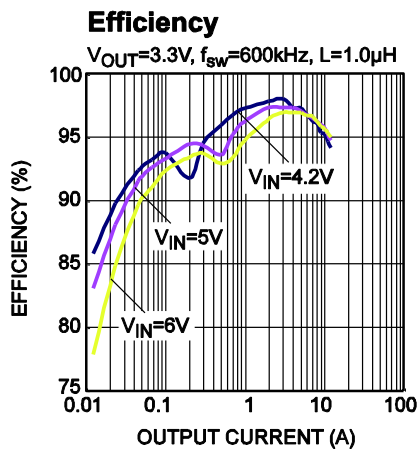
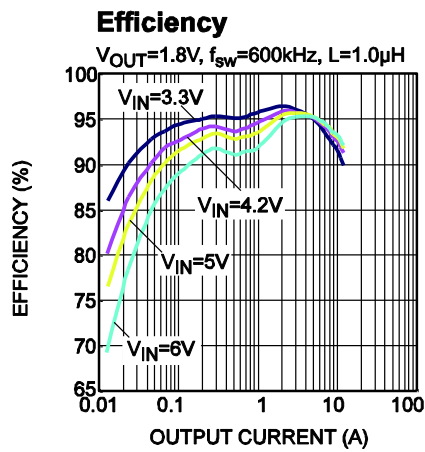
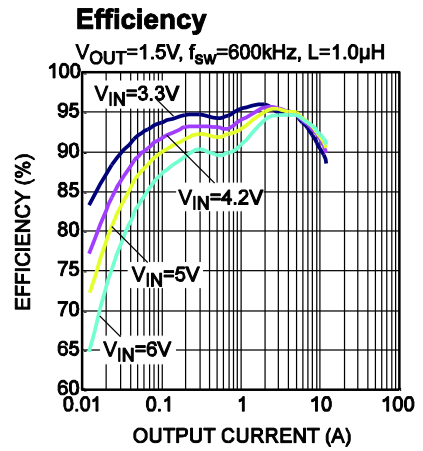
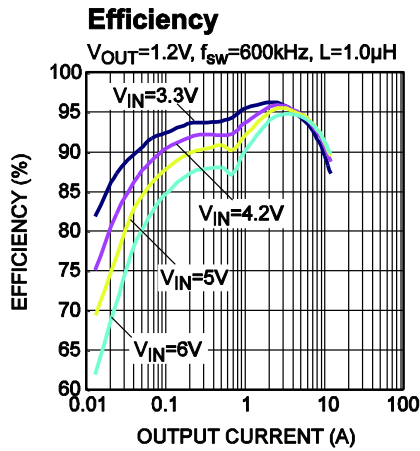
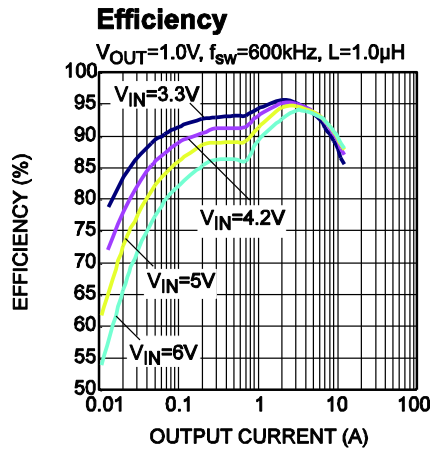
EN Threshold vs. Temperature

Soft-Start/Shutdown Current vs. Temperature

TYPICAL PERFORMANCE CHARACTERISTICS *(continued)*

Performance waveforms are tested on the evaluation board of the Design Example section. MPQ8612-12, $V_{IN}=5V$, $V_{CC}=5V$, $V_{OUT}=1.2V$, $L=1.0\mu H$, $T_A=+25^\circ C$, unless otherwise noted.



TYPICAL PERFORMANCE CHARACTERISTICS *(continued)*

Performance waveforms are tested on the evaluation board of the Design Example section. MPQ8612-12, $V_{IN}=5V$, $V_{CC}=5V$, $V_{OUT}=1.2V$, $L=1.0\mu H$, $T_A=+25^\circ C$, unless otherwise noted.

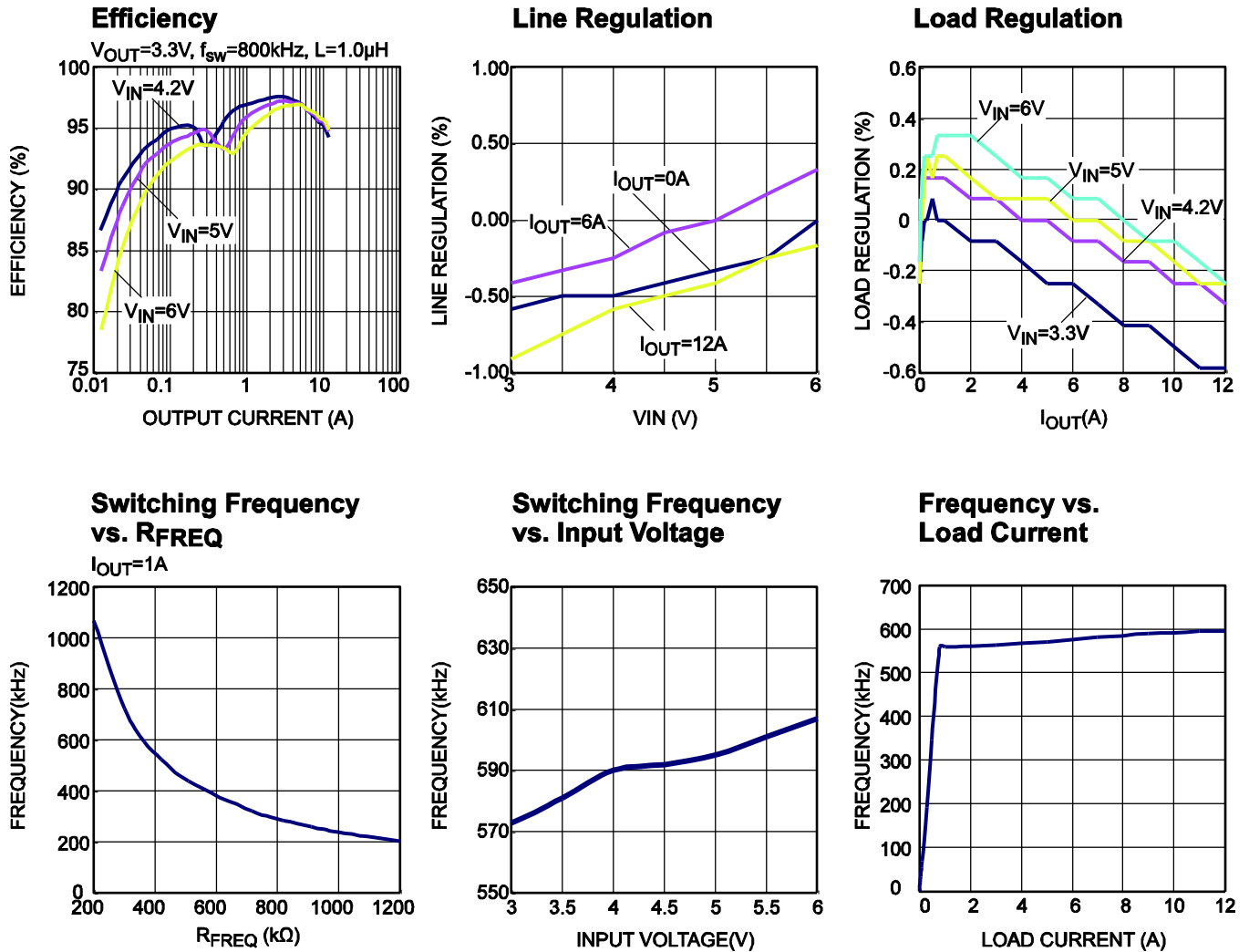

TYPICAL PERFORMANCE CHARACTERISTICS *(continued)*

Performance waveforms are tested on the evaluation board of the Design Example section. MPQ8612GL-12, $V_{IN}=5V$, $V_{CC}=5V$, $V_{OUT}=1.2V$, $L=1.0\mu H$, $T_A=+25^\circ C$, unless otherwise noted.

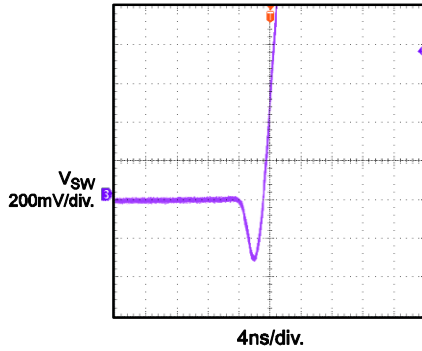
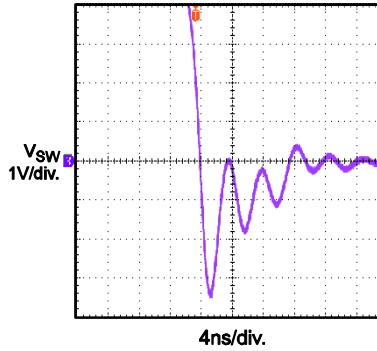
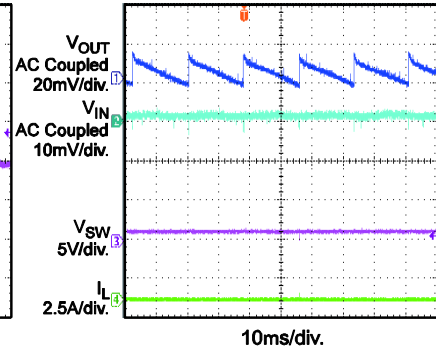
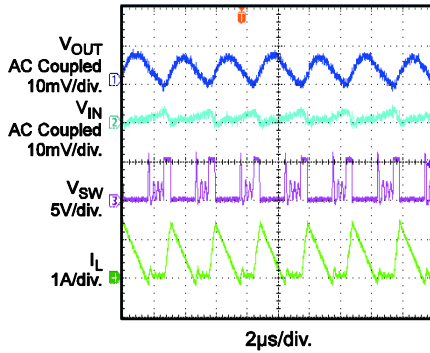
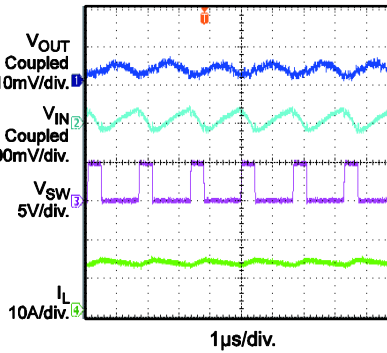
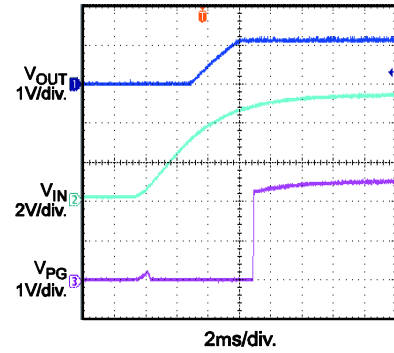
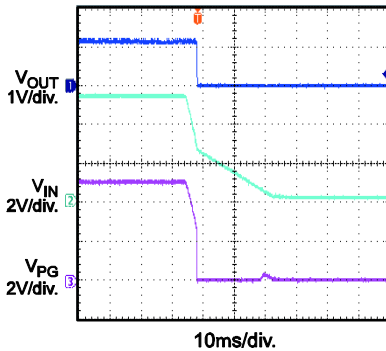
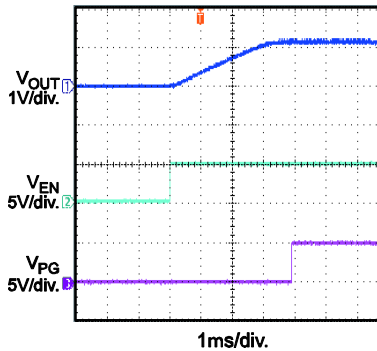
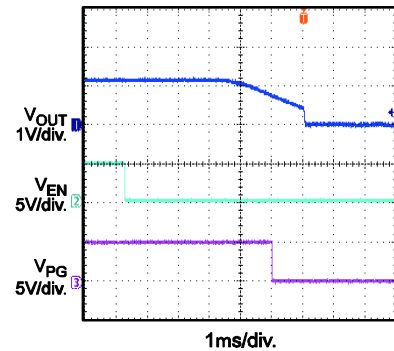
Dead Time (on)
 $I_{OUT}=12A$

Dead Time Off
 $I_{OUT}=12A$

Input/Output Voltage Ripp
 $I_{OUT}=0A$

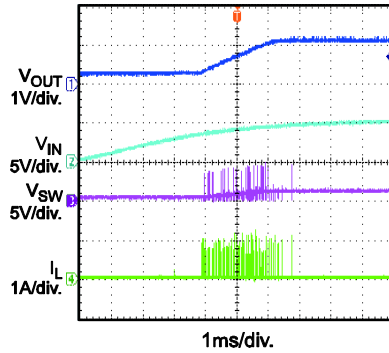
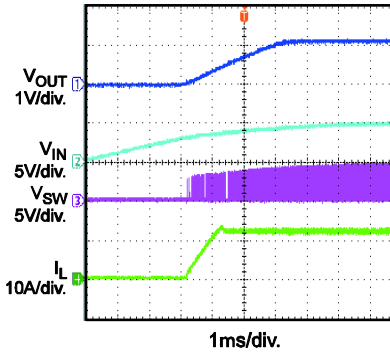
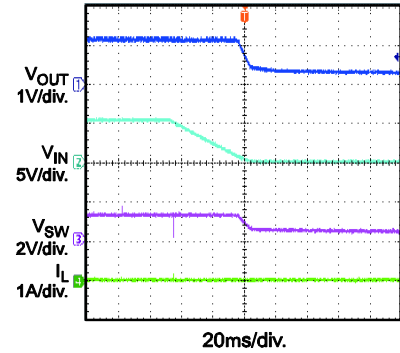
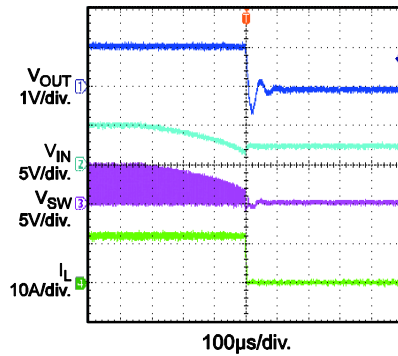
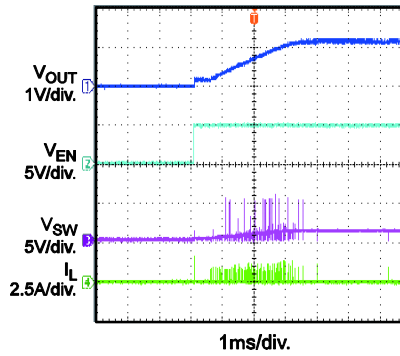
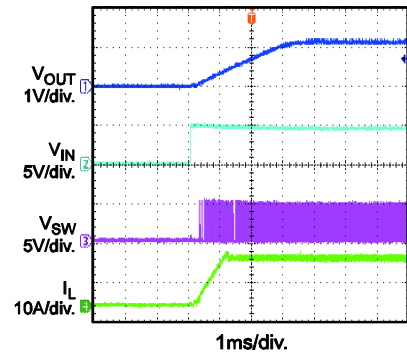
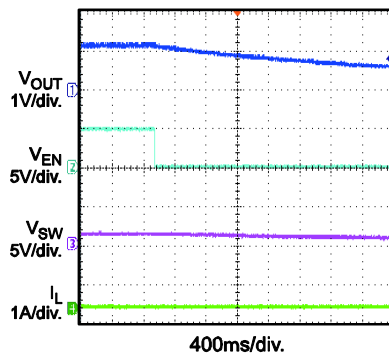
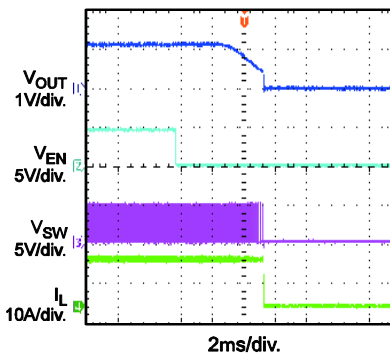
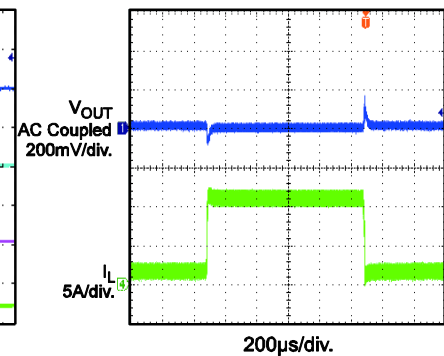
Input/Output Voltage Ripple
 $I_{OUT}=0.4A$

Input/Output Voltage Ripple
 $I_{OUT}=12A$

Power Good Through Vin Start-Up
 $I_{OUT}=12A$

Power Good Through Vin Shutdown
 $I_{OUT}=12A$

Power Good Through EN Start-Up
 $I_{OUT}=12A$

Power Good Through EN Shutdown
 $I_{OUT}=12A$

TYPICAL PERFORMANCE CHARACTERISTICS *(continued)*

Performance waveforms are tested on the evaluation board of the Design Example section. MPQ8612GL-12, $V_{IN}=5V$, $V_{CC}=5V$, $V_{OUT}=1.2V$, $L=1.0\mu H$, $T_A=+25^\circ C$, unless otherwise noted.

Start-Up Through Vin
 $I_{OUT} = 0A$

Start-Up Through Vin
 $I_{OUT} = 12A$

Shutdown Through Vin
 $I_{OUT} = 0A$

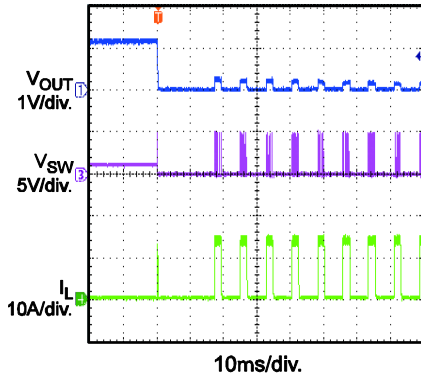
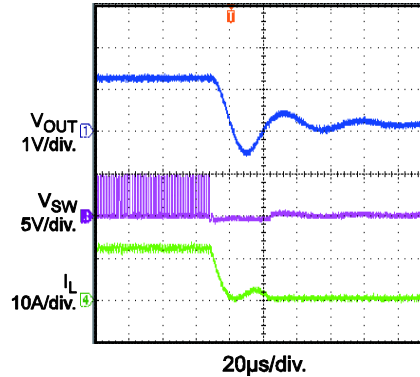
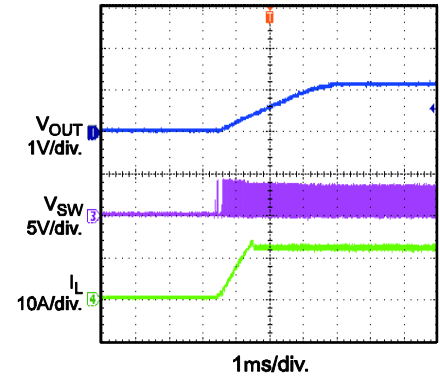
Shutdown Through Vin
 $I_{OUT} = 12A$

Start-Up Through EN
 $I_{OUT} = 0A$

Start-Up Through EN
 $I_{OUT} = 12A$

Shutdown Through EN
 $I_{OUT} = 0A$

Shutdown Through EN
 $I_{OUT} = 12A$

Transient
 $I_{OUT} = 1.2A-10.8A@2.5A/\mu s$
 $f_{SW} = 600kHz$, $C_{OUT} = 4x22\mu F$

TYPICAL PERFORMANCE CHARACTERISTICS *(continued)*

Performance waveforms are tested on the evaluation board of the Design Example section. MPQ8612GL-12, $V_{IN}=5V$, $V_{CC}=5V$, $V_{OUT}=1.2V$, $L=1.0\mu H$, $T_A=+25^\circ C$, unless otherwise noted.

Short Circuit Protection

Thermal Shutdown
 $I_{OUT} = 12A$

Thermal Recovery
 $I_{OUT} = 12A$

PIN FUNCTIONS

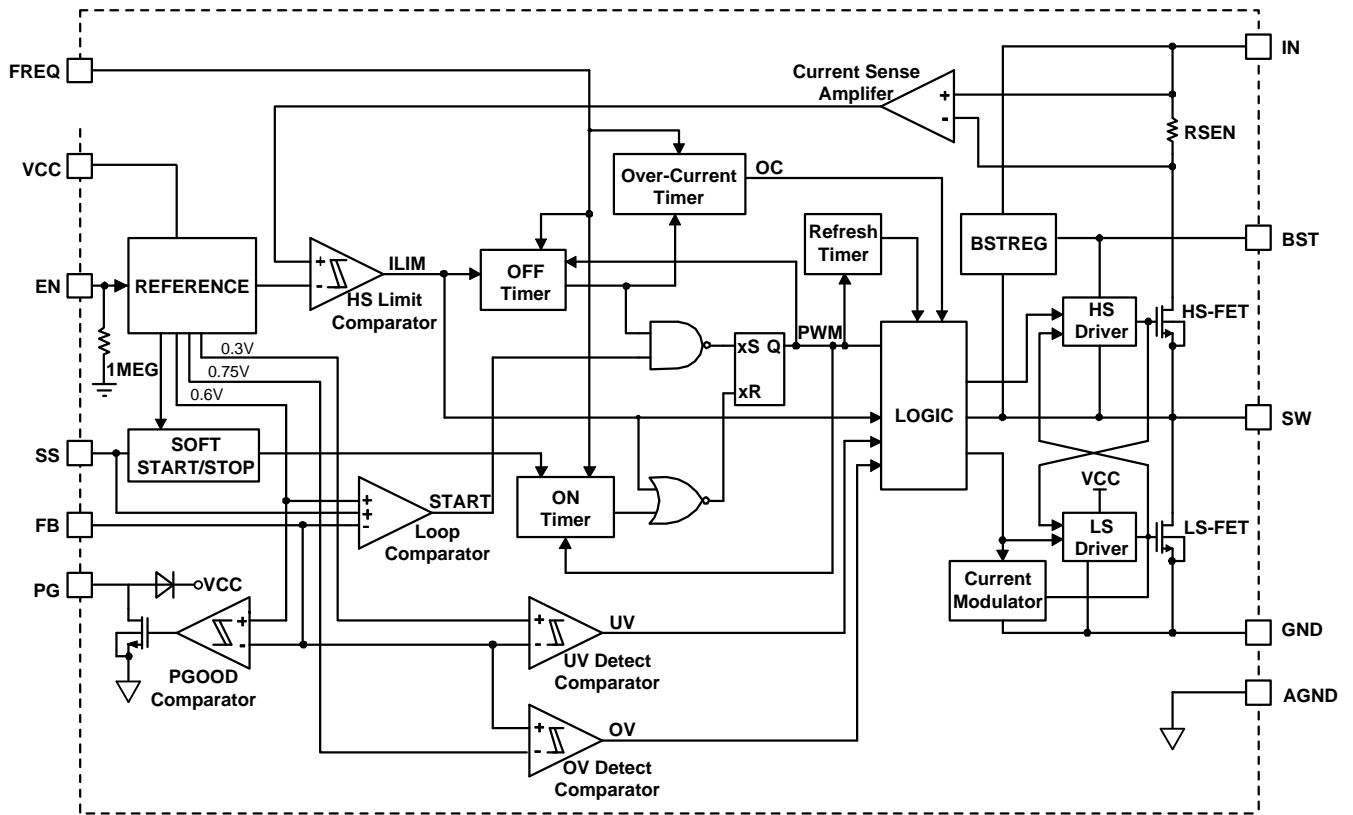
MPQ8612GL-12

PIN #	Name	Description
1	AGND	Analog ground.
2	FB	Feedback. An external resistor divider from the output to GND, tapped to the FB pin, sets the output voltage. It is recommended to place the resistor divider as close to FB pin as possible. Vias should be avoided on the FB traces.
3	SS	Soft Start. Connect on external capacitor to program the soft start time for the switch mode regulator.
4	EN	Enable pin. Pull this pin higher than 1.25V to enable the chip. For automatic start-up, connect EN pin to VIN with 100KΩ resistor. Can be used to set the on/off threshold (adjust UVLO) with two additional resistors.
5	VCC	External bias supply voltage for driver and control circuits. For 1.5V to 3V input application, provide VCC with separate 3.3V/5V bias supply. For 3V to 6V input application, provide VCC with separate 3.3V/5V bias or tie VCC to VIN with 10ohm resistor. Decouple with a minimum 4.7μF ceramic capacitor as close to the pin as possible. X7R or X5R grade dielectric ceramic capacitors are recommended for their stable temperature characteristics.
6	PG	Power good output, and it is high if the output voltage is higher than 90% of the nominal voltage. There is a delay from FB ≥ 90% to PGOOD goes high.
7	BST	Bootstrap. A capacitor connected between SW and BS pins is required to form a floating supply across the high-side switch driver.
8-9	GND	System Ground. This pin is the reference ground of the regulated output voltage. For this reason care must be taken in PCB layout.
10-11	IN	Supply Voltage. The IN pin supplies power for internal MOSFET and regulator. The MPQ8612 operate from a +3V to +6V input rail. An input capacitor is needed to decouple the input rail. Use wide PCB traces and multiple vias to make the connection.
12	FREQ	Frequency set during CCM operation. A resistor connected between FREQ and IN is required to set the switching frequency. The ON time is determined by the input voltage and the resistor connected to the FREQ pin. IN connect through a resistor is used for line feed-forward and makes the frequency basically constant during input voltage's variation. Recommend a 10pF decoupling capacitor from FREQ to GND.
13-14	SW	Switch Output. Connect this pin to the inductor and bootstrap capacitor. This pin is driven up to the VIN voltage by the high-side switch during the on-time of the PWM duty cycle. The inductor current drives the SW pin negative during the off-time. The on-resistance of the low-side switch and the internal Schottky diode fixes the negative voltage. Use wide PCB traces to make the connection.

BLOCK DIAGRAM

Figure 1—Functional Block Diagram

OPERATION

PWM Operation

The MPQ8612 is fully integrated synchronous rectified step-down switch mode converter. Constant-on-time (COT) control is employed to provide fast transient response and easy loop stabilization. At the beginning of each cycle, the high-side MOSFET (HS-FET) is turned ON when the feedback voltage (V_{FB}) is below the reference voltage (V_{REF}), which indicates insufficient output voltage. The ON period is determined by the input voltage and the frequency-set resistor as follows:

$$t_{ON}(ns) = \frac{4.8 \times R_{FREQ}(k\Omega)}{V_{IN}(V) - 0.49} \quad (1)$$

After the ON period elapses, the HS-FET is turned off, or becomes OFF state. It is turned ON again when V_{FB} drops below V_{REF} . By repeating operation this way, the converter regulates the output voltage. The integrated low-side MOSFET (LS-FET) is turned on when the HS-FET is in its OFF state to minimize the conduction loss. There will be a dead short between input and GND if both HS-FET and LS-FET are turned on at the same time. It's called shoot-through. In order to avoid shoot-through, a dead-time (DT) is internally generated between HS-FET off and LS-FET on, or LS-FET off and HS-FET on.

Heavy-Load Operation

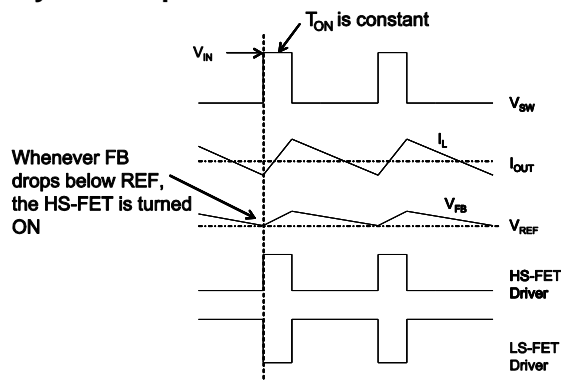

Figure 2—Heavy Load Operation

When the output current is high and the inductor current is always above zero amps, it is called continuous-conduction-mode (CCM). The CCM mode operation is shown in Figure 2. When V_{FB} is

below V_{REF} , HS-MOSFET is turned on for a fixed interval which is determined by one-shot on-timer as equation 1 shown. When the HS-MOSFET is turned off, the LS-MOSFET is turned on until next period.

In CCM mode operation, the switching frequency is fairly constant and it is called PWM mode.

Light-Load Operation

With the load decreasing, the inductor current decreases too. When the inductor current touches zero, the operation is transitioned from continuous-conduction-mode (CCM) to discontinuous-conduction-mode (DCM).

The light load operation is shown in Figure 3. When V_{FB} is below V_{REF} , HS-MOSFET is turned on for a fixed interval which is determined by one-shot on-timer as equation 1 shown. When the HS-MOSFET is turned off, the LS-MOSFET is turned on until the inductor current reaches zero. In DCM operation, the V_{FB} does not reach V_{REF} when the inductor current is approaching zero. The driver of LS-FET turns into tri-state (high Z) whenever the inductor current reaches zero. A current modulator takes over the control of LS-FET and limits the inductor current to less than $-1mA$. Hence, the output capacitors discharge slowly to GND through LS-FET. As a result, the efficiency at light load condition is greatly improved. At light load condition, the HS-FET is not turned ON as frequently as at heavy load condition. This is called skip mode.

At light load or no load condition, the output drops very slowly and the MPQ8612 reduce the switching frequency naturally and then high efficiency is achieved at light load.

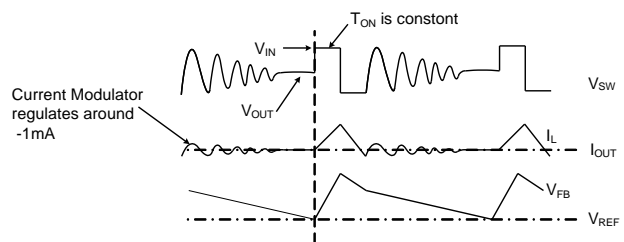

Figure 3—Light Load Operation

As the output current increases from the light load condition, the time period within which the current modulator regulates becomes shorter. The HS-FET is turned ON more frequently. Hence, the switching frequency increases correspondingly. The output current reaches the critical level when the current modulator time is zero. The critical level of the output current is determined as follows:

$$I_{OUT} = \frac{(V_{IN} - V_{OUT}) \times V_{OUT}}{2 \times L \times f_{SW} \times V_{IN}} \quad (2)$$

It turns into PWM mode once the output current exceeds the critical level. After that, the switching frequency stays fairly constant over the output current range.

Switching Frequency

The selection of switching frequency is a tradeoff between efficiency and component size. Low frequency operation increases efficiency by reducing MOSFET switching losses, but requires larger inductance and capacitance to maintain low output voltage ripple.

For MPQ8612, the on time can be set using FREQ pin, then the frequency is set in steady state operation at CCM mode.

Adaptive constant-on-time (COT) control is used in MPQ8612 and there is no dedicated oscillator in the IC. Connect FREQ pin to IN pin through resistor R_{FREQ} and the input voltage is feed-forwarded to the one-shot on-time timer through the resistor R_{FREQ} . When in steady state operation at CCM, the duty ratio is kept as V_{OUT}/V_{IN} . Hence the switching frequency is fairly constant over the input voltage range. The switching frequency can be set as follows:

$$f_{SW} \text{ (kHz)} = \frac{10^6}{\frac{4.8 \times R_{FREQ} \text{ (k}\Omega) \times V_{IN} \text{ (V)}}{V_{IN} \text{ (V)} - 0.49} + t_{DELAY} \text{ (ns)}} \quad (3)$$

Where T_{DELAY} is the comparator delay. It's about 40ns.

Generally, the MPQ8612 is set for 300kHz to 1MHz application. It is optimized to operate at high switching frequency with high efficiency. High switching frequency makes it possible to utilize small sized LC filter components to save system PCB space.

Jitter and FB Ramp Slope

Figure 4 and Figure 5 show jitter occurring in both PWM mode and skip mode. When there is noise in the V_{FB} downward slope, the ON time of HS-FET deviates from its intended location and produces jitter. It is necessary to understand that there is a relationship between a system's stability and the steepness of the V_{FB} ripple's downward slope. The slope steepness of the V_{FB} ripple dominates in noise immunity. The magnitude of the V_{FB} ripple doesn't affect the noise immunity directly.

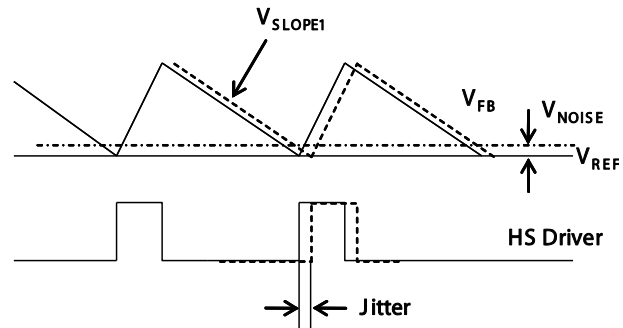

Figure 4—Jitter in PWM Mode

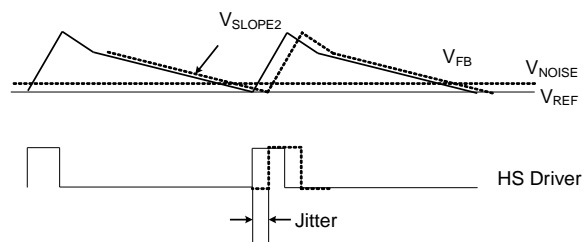

Figure 5—Jitter in Skip Mode

Ramp with Large ESR Capacitor

In the case of POSCAP or other types of capacitor with larger ESR is applied as output capacitor, the ESR ripple dominates the output ripple, and the slope on the FB is quite ESR related. Figure 6 shows an equivalent circuit in PWM mode with the HS-FET off and without an external ramp circuit. Turn to application information section for design steps with large ESR capacitors.

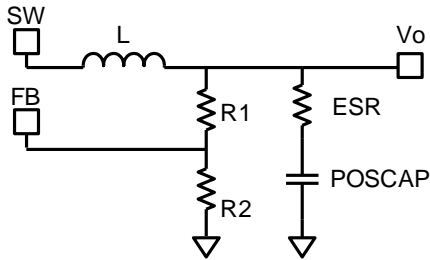

Figure 6—Simplified Circuit in PWM Mode without External Ramp Compensation

To realize the stability when no external ramp is applied, usually the ESR value should be chosen as follow:

$$R_{ESR} \geq \frac{t_{SW} + t_{ON}}{0.7 \times \pi \times \frac{2}{C_{OUT}}} \quad (4)$$

T_{SW} is the switching period.

Ramp with Small ESR Capacitor

When the output capacitors are ceramic ones, the ESR ripple is not high enough to stabilize the system, and external ramp compensation is needed. Skip to application information section for design steps with small ESR caps.

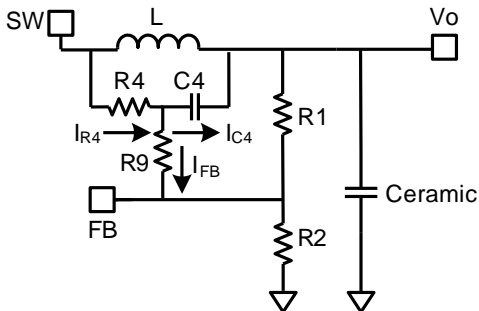

Figure 7—Simplified Circuit in PWM Mode with External Ramp Compensation

In PWM mode, an equivalent circuit with HS-FET off and the use of an external ramp compensation circuit (R_4 , C_4) is simplified in Figure 7. The external ramp is derived from the inductor ripple current. If one chooses C_4 , R_9 , R_1 and R_2 to meet the following condition:

$$\frac{1}{2\pi \times f_{SW} \times C_4} < \frac{1}{20} \times \left(\frac{R_1 \times R_2}{R_1 + R_2} + R_9 \right) \quad (5)$$

Where:

$$I_{R4} = I_{C4} + I_{FB} \approx I_{C4} \quad (6)$$

And the ramp on the V_{FB} can then be estimated as:

$$V_{RAMP} = \frac{V_{IN} - V_O}{R_4 \times C_4} \times t_{ON} \times \left(\frac{R_1 // R_2}{R_1 // R_2 + R_9} \right) \quad (7)$$

The downward slope of the V_{FB} ripple then follows:

$$V_{SLOPE1} = \frac{V_{RAMP}}{t_{off}} = \frac{-V_{OUT}}{R_4 \times C_4} \quad (8)$$

As can be seen from equation 8, if there is instability in PWM mode, we can reduce either R_4 or C_4 . If C_4 can not be reduced further due to limitation from equation 5, then we can only reduce R_4 . For a stable PWM operation, the V_{SLOPE1} should be design follow equation 9.

$$-V_{SLOPE1} \geq \frac{t_{SW} + t_{ON} - R_{ESR} \times C_{OUT}}{0.7 \times \pi \times 2} \times V_{OUT} + \frac{0.7 \times I_o \times 10^{-3}}{t_{sw} - t_{on}} \quad (9)$$

Where I_o is the load current.

In skip mode, the downward slope of the V_{FB} ripple is almost same whether the external ramp is used or not. Fig.8 shows the simplified circuit of the skip mode when both the HS-FET and LS-FET are off.

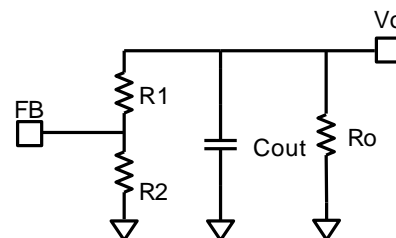

Figure 8—Simplified Circuit in skip Mode

The downward slope of the V_{FB} ripple in skip mode can be determined as follows:

$$V_{SLOPE2} = \frac{-V_{REF}}{[(R_1 + R_2) // R_o] \times C_{OUT}} \quad (10)$$

Where R_o is the equivalent load resistor.

As described in Fig.5, V_{SLOPE2} in the skip mode is lower than that is in the PWM mode, so it is reasonable that the jitter in the skip mode is

larger. If one wants a system with less jitter during ultra light load condition, the values of the V_{FB} resistors should not be too big, however, that will decrease the light load efficiency.

Soft Start/Stop

The MPQ8612 employs soft start/stop (SS) mechanism to ensure smooth output during power up and power down.

When the EN pin becomes high, an internal current source ($8\mu\text{A}$) charges up the SS capacitor C6. The SS capacitor voltage takes over the REF voltage to the PWM comparator. The output voltage smoothly ramps up with the SS voltage. Once the SS voltage reaches the same level as the REF voltage, it keeps ramping up while V_{REF} takes over the PWM comparator. At this point, the soft start finishes and it enters into steady state operation.

When the EN pin is pulled to low, the SS CAP voltage is discharged through an $8\mu\text{A}$ internal current source. Once the SS voltage reaches REF voltage, it takes over the PWM comparator. The output voltage will decrease smoothly with SS voltage until zero level. The SS capacitor value can be determined as follows:

$$C_{SS}(\text{nF}) = \frac{t_{SS}(\text{ms}) \times I_{SS}(\mu\text{A})}{V_{REF}} \quad (11)$$

If the output capacitors have large capacitance value, it's not recommended to set the SS time too small. Otherwise, it's easy to hit the current limit during SS. A minimum value of 4.7nF should be used if the output capacitance value is larger than $330\mu\text{F}$.

Pre-Bias Startup

If the output is pre-biased to a certain voltage during startup, the MPQ8612 will disable the switching of both high-side and low-side switches until the voltage on the internal soft-start capacitor exceeds the sensed output voltage at the FB pin.

Power Good (PG)

The MPQ8612 has power-good (PG) output. It can be connected to V_{CC} or other voltage source through a resistor (e.g. 100k). When the MPQ8612 is powered on and FB voltage reaches

above 90% of REF voltage, the PG pin is pulled high.

When the FB voltage drops to 70% of REF voltage or the part is not powered on, the PG pin will be pulled low.

Over-Current Protection (OCP)

The MPQ8612 enters over-current protection mode when the inductor current hits the current limit, and tries to recover from over-current fault with hiccup mode. That means in over-current protection, the chip will disable output power stage, discharge soft-start capacitor and then automatically try to soft-start again. If the over-current condition still holds after soft-start ends, the chip repeats this operation cycle till over-current disappears and output rises back to regulation level. The MPQ8612 also operates in hiccup mode when short circuit happens.

Over/Under –Voltage Protection (OVP/UVP)

The MPQ8612 has non-latching over voltage protection. It monitors the output voltage through a resistor divider feedback (FB) voltage to detect over-voltage on the output. When the FB voltage is higher than 120% of the REF voltage (0.608V), the LS-FET will be turned on while the HS-FET will be off. The LS-FET keeps on until it hits the negative current limit and turns off for 100ns . If over voltage condition still holds, the chip repeats this operation cycle till the FB voltage drops below 110% of the REF voltage.

When the FB voltage is below 50% of the REF voltage (0.608V), it is recognized as under-voltage (UV). Usually, UVP accompanies a hit in current limit and results in OCP.

Configuring the EN Control

The EN pin provides electrical on/off control of the device. Set EN high to turn on the regulator and low to turn it off. Do not float this pin.

For automatic start-up, the EN pin can be pulled up to input voltage through a resistive voltage divider. Choose the values of the pull-up resistor (R_{UP} from VIN pin to EN pin) and the pull-down resistor (R_{DOWN} from EN pin to GND) to determine the automatic start-up voltage:

$$V_{IN-START} = 1.4 \times \frac{R_{UP} + R_{DOWN}}{R_{DOWN}} \quad (12)$$

For example, for $R_{UP} = 100k\Omega$ and $R_{DOWN} = 51k\Omega$, the $V_{IN-START}$ is set at 4.15V.

To avoid noise, a 10nF ceramic capacitor from EN to GND is recommended.

There is an internal zener diode on the EN pin, which clamps the EN pin voltage to prevent it from running away. The maximum pull up current assuming a worst case 6V internal zener clamp should be less than 1mA. Therefore, when EN is driven by an external logic signal, the EN voltage should be lower than 6V; when EN is connected with VIN through a pull-up resistor or a resistive voltage divider, the resistance selection should ensure the maximum pull up current less than 1mA.

If using a resistive voltage divider and VIN higher than 6V, the allowed minimum pull-up resistor R_{UP} should meet the following equation:

$$\frac{V_{IN}(V) - 6}{R_{UP}(k\Omega)} - \frac{6}{R_{DOWN}(k\Omega)} < 1(mA) \quad (13)$$

As a result, when just the pull-up resistor R_{UP} is applied, the $V_{IN-START}$ is determined by input UVLO. The value of R_{UP} can be get as:

$$R_{UP}(k\Omega) > \frac{V_{IN}(V) - 6}{1(mA)} \quad (14)$$

A typical pull-up resistor is 100k Ω .

UVLO protection

The MPQ8612 has under-voltage lock-out protection (UVLO). When the VCC voltage is higher than the UVLO rising threshold voltage, the MPQ8612 will be powered up. It shuts off when the VCC voltage is lower than the UVLO

falling threshold voltage. This is non-latch protection.

The MPQ8612 is disabled when the VCC voltage falls below its UVLO falling threshold (2.45V). If an application requires a higher under-voltage lockout (UVLO), use the EN pin as shown in Figure 9 to adjust the input voltage UVLO by using two external resistors. It is recommended to use the enable resistors to set the UVLO falling threshold (V_{STOP}) above 2.8 V. The rising threshold (V_{START}) should be set to provide enough hysteresis to allow for any input supply variations.

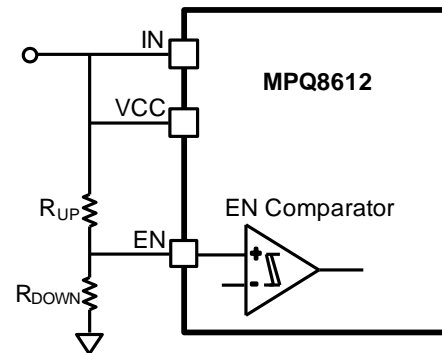

Figure 9—Adjustable UVLO

Thermal Shutdown

Thermal shutdown is employed in the MPQ8612. The junction temperature of the IC is internally monitored. If the junction temperature exceeds the threshold value (minimum 150°C), the converter shuts off. This is a non-latch protection. There is about 25°C hysteresis. Once the junction temperature drops to about 125°C, it initiates a soft startup.

APPLICATION INFORMATION

Setting the Output Voltage-Large ESR Caps

For applications that electrolytic capacitor or POS capacitor with a controlled output of ESR is set as output capacitors. The output voltage is set by feedback resistors R1 and R2. As figure 10 shows.

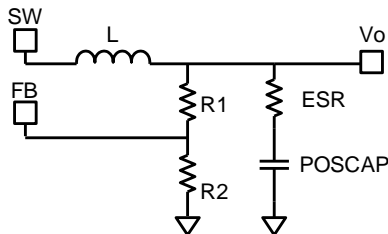

Figure 10—Simplified Circuit of POS Capacitor

First, choose a value for R2. R2 should be chosen reasonably, a small R2 will lead to considerable quiescent current loss while too large R2 makes the FB noise sensitive. It is recommended to choose a value within 5kΩ-100kΩ for R2, using a comparatively larger R2 when V_{OUT} is low, and a smaller R2 when V_{OUT} is high. Then R1 is determined as follow with the output ripple considered:

$$R_1 = \frac{V_{OUT} - \frac{1}{2} \times \Delta V_{OUT} - V_{REF}}{V_{REF}} \times R_2 \quad (15)$$

ΔV_{OUT} is the output ripple determined by equation 21.

Setting the Output Voltage-Small ESR Caps

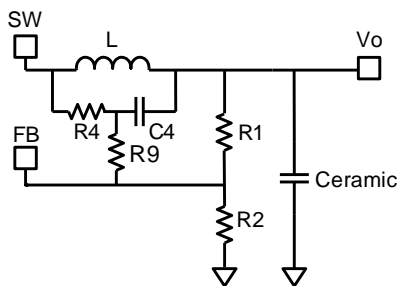

Figure 11—Simplified Circuit of Ceramic Capacitor

When low ESR ceramic capacitor is used in the output, an external voltage ramp should be added to FB through resistor R4 and capacitor C4. The output voltage is influenced by ramp voltage V_{RAMP} besides resistor divider as shown

in Figure 11. The V_{RAMP} can be calculated as shown in equation 7. R2 should be chosen reasonably, a small R2 will lead to considerable quiescent current loss while too large R2 makes the FB noise sensitive. It is recommended to choose a value within 5kΩ-100kΩ for R2, using a comparatively larger R2 when V_{OUT} is low, and a smaller R2 when V_{OUT} is high. And the value of R1 then is determined as follow:

$$R_1 = \frac{R_2}{\frac{V_{FB(AVG)}}{V_{OUT} - V_{FB(AVG)}} - \frac{R_2}{R_4 + R_9}} \quad (16)$$

The $V_{FB(AVG)}$ is the average value on the FB. $V_{FB(AVG)}$ varies with the V_{in} , V_o , and load condition, etc.. Its value on the skip mode would be lower than that of the PWM mode, which means the load regulation is strictly related to the $V_{FB(AVG)}$. Also the line regulation is related to the $V_{FB(AVG)}$, if one wants to get a better load or line regulation, a lower V_{RAMP} is suggested once it meets equation 9.

For PWM operation, $V_{FB(AVG)}$ value can be deduced from equation 17.

$$V_{FB(AVG)} = V_{REF} + \frac{1}{2} \times V_{RAMP} \times \frac{R_1 // R_2}{R_1 // R_2 + R_9} \quad (17)$$

Usually, R9 is set to 0Ω, and it can also be set following equation 18 for a better noise immunity. It should be set to be 5 times smaller than $R_1 // R_2$ to minimize its influence on V_{ramp} .

$$R_9 \leq \frac{1}{10} \times \frac{R_1 \times R_2}{R_1 + R_2} \quad (18)$$

Using equation 16 and 17 to calculate the output voltage can be complicated. To simplify the calculation of R1 in equation 16, a DC-blocking capacitor Cdc can be added to filter the DC influence from R4 and R9. Figure 12 shows a simplified circuit with external ramp compensation and a DC-blocking capacitor. With this capacitor, R1 can easily be obtained by using equation 19 for PWM mode operation.

$$R_1 = \frac{V_{OUT} - V_{REF} - \frac{1}{2} \times V_{RAMP}}{V_{REF} + \frac{1}{2} \times V_{RAMP}} \times R_2 \quad (19)$$

Cdc is suggested to be at least 10 times larger than C4 for better DC blocking performance, and

should be not larger than 0.47uF considering start up performance. In case one wants to use larger Cdc for a better FB noise immunity, combined with reduced R1 and R2 to limit the Cdc in a reasonable value without affecting the system start up. Be noted that even when the Cdc is applied, the load and line regulation are still Vramp related.

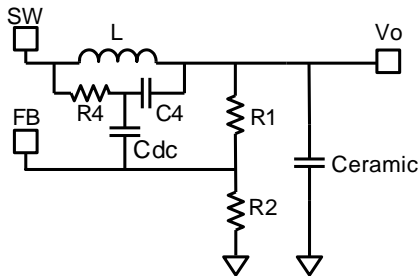

Figure 12—Simplified Circuit of Ceramic Capacitor with DC blocking capacitor

Input Capacitor

The input current to the step-down converter is discontinuous. Therefore, a capacitor is required to supply the AC current to the step-down converter while maintaining the DC input voltage. Ceramic capacitors are recommended for best performance. In the layout, it's recommended to put the input capacitors as close to the IN pin as possible.

The capacitance varies significantly over temperature. Capacitors with X5R and X7R ceramic dielectrics are recommended because they are fairly stable over temperature.

The capacitors must also have a ripple current rating greater than the maximum input ripple current of the converter. The input ripple current can be estimated as follows:

$$I_{CIN} = I_{OUT} \times \sqrt{\frac{V_{OUT}}{V_{IN}} \times \left(1 - \frac{V_{OUT}}{V_{IN}}\right)} \quad (20)$$

The worst-case condition occurs at $V_{IN} = 2V_{OUT}$, where:

$$I_{CIN} = \frac{I_{OUT}}{2} \quad (21)$$

For simplification, choose the input capacitor whose RMS current rating is greater than half of the maximum load current.

The input capacitance value determines the input voltage ripple of the converter. If there is input voltage ripple requirement in the system design, choose the input capacitor that meets the specification

The input voltage ripple can be estimated as follows:

$$\Delta V_{IN} = \frac{I_{OUT}}{f_{SW} \times C_{IN}} \times \frac{V_{OUT}}{V_{IN}} \times \left(1 - \frac{V_{OUT}}{V_{IN}}\right) \quad (22)$$

The worst-case condition occurs at $V_{IN} = 2V_{OUT}$, where:

$$\Delta V_{IN} = \frac{1}{4} \times \frac{I_{OUT}}{f_{SW} \times C_{IN}} \quad (23)$$

Output Capacitor

The output capacitor is required to maintain the DC output voltage. Ceramic or POSCAP capacitors are recommended. The output voltage ripple can be estimated as:

$$\Delta V_{OUT} = \frac{V_{OUT}}{f_{SW} \times L} \times \left(1 - \frac{V_{OUT}}{V_{IN}}\right) \times \left(R_{ESR} + \frac{1}{8 \times f_{SW} \times C_{OUT}}\right) \quad (24)$$

In the case of ceramic capacitors, the impedance at the switching frequency is dominated by the capacitance. The output voltage ripple is mainly caused by the capacitance. For simplification, the output voltage ripple can be estimated as:

$$\Delta V_{OUT} = \frac{V_{OUT}}{8 \times f_{SW}^2 \times L \times C_{OUT}} \times \left(1 - \frac{V_{OUT}}{V_{IN}}\right) \quad (25)$$

The output voltage ripple caused by ESR is very small. Therefore, an external ramp is needed to stabilize the system. The external ramp can be generated through resistor R4 and capacitor C4 following equation 5, 8 and 9.

In the case of POSCAP capacitors, the ESR dominates the impedance at the switching frequency. The ramp voltage generated from the ESR is high enough to stabilize the system. Therefore, an external ramp is not needed. A minimum ESR value around 12mΩ is required to ensure stable operation of the converter. For simplification, the output ripple can be approximated as:

$$\Delta V_{OUT} = \frac{V_{OUT}}{f_{SW} \times L} \times \left(1 - \frac{V_{OUT}}{V_{IN}}\right) \times R_{ESR} \quad (26)$$

Inductor

The inductor is required to supply constant current to the output load while being driven by the switching input voltage. A larger value

inductor will result in less ripple current and lower output ripple voltage. However, a larger value inductor will have a larger physical size, higher series resistance, and/or lower saturation current. A good rule for determining the inductor value is to allow the peak-to-peak ripple current in the inductor to be approximately 10~30% of the maximum output current. Also, make sure that the peak inductor current is below the current limit of the device. The inductance value can be calculated as:

$$L = \frac{V_{OUT}}{f_{SW} \times \Delta I_L} \times \left(1 - \frac{V_{OUT}}{V_{IN}}\right) \quad (27)$$

Where ΔI_L is the peak-to-peak inductor ripple current.

Choose an inductor that will not saturate under the maximum inductor peak current. The peak inductor current can be calculated as:

$$I_{LP} = I_{OUT} + \frac{V_{OUT}}{2 \times f_{SW} \times L} \times \left(1 - \frac{V_{OUT}}{V_{IN}}\right) \quad (28)$$

The inductors listed in Table 1 are highly recommended for the high efficiency they can provide.

Table 1—Inductor Selection Guide

Part Number	Manufacturer	Inductance (μH)	DCR (mΩ)	Current Rating (A)	Dimensions L x W x H (mm ³)	Switching Frequency (kHz)
FDU1250C-R50M	TOKO	0.50	1.3	46.3	13.3 x 12.1 x 5	1000
FDU1250C-R56M	TOKO	0.56	1.6	42.6	13.3 x 12.1 x 5	800-1000
FDU1250C-R75M	TOKO	0.75	1.7	32.7	13.3 x 12.1 x 5	600-800
FDU1250C-1R0M	TOKO	1.0	2.2	31.3	13.3 x 12.1 x 5	600

Typical Design Parameter Tables

The following tables include recommended component values for typical output voltages (1.0V, 1.2V, 1.8V, 3.3V) and switching frequencies (600kHz, 800kHz, and 1MHz). Refer to Tables 2-4 for design cases without external ramp compensation and Tables 5-7 for design cases with external ramp compensation. External ramp is not needed when high-ESR capacitors, such as electrolytic or POSCAPs are used. External ramp is needed when low-ESR capacitors, such as ceramic capacitors are used. For cases not listed in this datasheet, a calculator in excel spreadsheet can also be requested through a local sales representative to assist with the calculation.

Table 2—C_{OUT}-Poscap, 600kHz, 5V_{IN}

V _{OUT} (V)	L (μH)	R1 (kΩ)	R2 (kΩ)	R7 (kΩ)
1.0	1.0	19.8	30	300
1.2	1.0	29.4	30	365
1.5	1.0	29.4	20	453
1.8	1.0	39.2	20	549
3.3	1.0	44.2	10	1000

Table 3—C_{OUT}-Poscap, 800kHz, 5V_{IN}

V _{OUT} (V)	L (μH)	R1 (kΩ)	R2 (kΩ)	R7 (kΩ)
1.0	0.75	20	30	210
1.2	0.75	20	20	270
1.5	0.75	30	20	330
1.8	0.75	39	20	499
3.3	0.75	44.2	10	750

Table 5—C_{OUT}-Ceramic, 600kHz, 5V_{IN}

V _{OUT} (V)	L (μH)	R1 (kΩ)	R2 (kΩ)	R4 (kΩ)	C4 (pF)	R7 (kΩ)
1.0	1.0	21	30	240	470	309
1.2	1.0	33	30	220	470	365
1.5	1.0	51	30	330	390	464
1.8	1.0	45	20	270	470	549
3.3	1.0	62	10	160	680	953

Table 6—C_{OUT}-Ceramic, 800kHz, 5V_{IN}

V _{OUT} (V)	L (μH)	R1 (kΩ)	R2 (kΩ)	R4 (kΩ)	C4 (pF)	R7 (kΩ)
1.0	0.75	21	30	200	470	226
1.2	0.75	34	30	200	470	270
1.5	0.75	34	20	220	470	324
1.8	0.75	47.5	20	225	470	402
3.3	0.75	57.6	10	200	560	750

TYPICAL APPLICATION

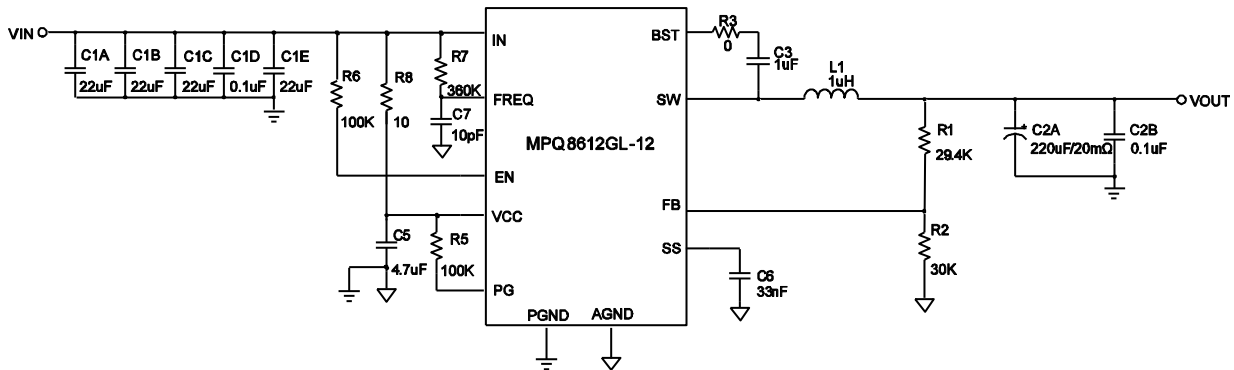

Figure 13 — Typical Application Circuit with No External Ramp
 MPQ8612GL- 12, $V_{IN}=5V$, $V_{OUT}=1.2V$, $I_{OUT}= 12A$, $f_{SW}=600kHz$

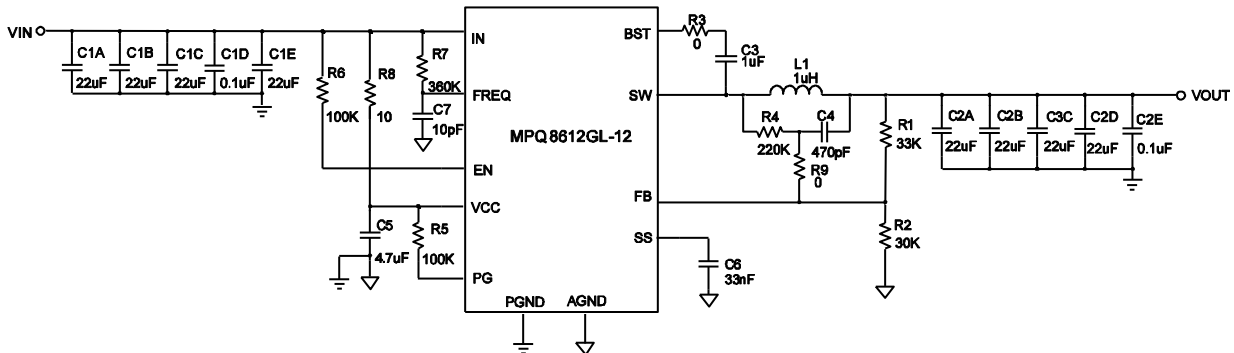

Figure 14 — Typical Application Circuit with Low ESR Ceramic Capacitor
 MPQ8612GL- 12, $V_{IN}=5V$, $V_{OUT}=1.2V$, $I_{OUT}= 12A$, $f_{SW}=600kHz$

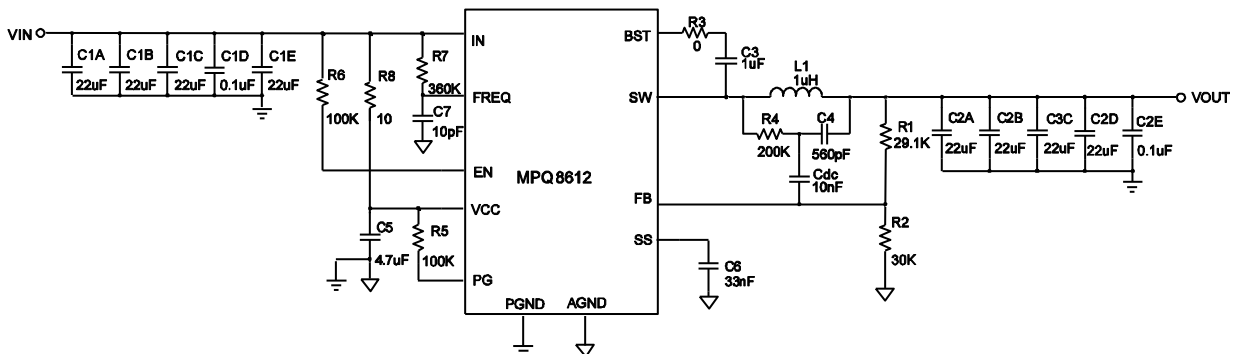

Figure 15 — Typical Application Circuit with Low ESR Ceramic Capacitor
 and DC-Blocking Capacitor.
 MPQ8612GL- 12, $V_{IN}=5V$, $V_{OUT}=1.2V$, $I_{OUT}= 12A$, $f_{SW}=600kHz$

LAYOUT RECOMMENDATION

- Four-layer layout is strongly recommended to achieve better thermal performance.
- Place at least 9 vias (10/20mil hole/diameter size) right beneath the IC to get best decoupling effect.
- Place 10 or more vias (10/25mil hole/diameter size) each for input and GND copper next to the VIN and PGND pin to improve the thermal performance.
- A 22uF (1206/1210) input cap C1B is required on bottom layer, right beneath the VIN/PGND vias to get best input decoupling effect.
- If VIN/PGND vias is not allowed beneath the IC,** a 22uF input cap with 1206/1210 package (C1C) is required on the Top layer as Figure17, connecting to VIN and PGND copper directly, within 2mm of the IC edge.
- A solid PGND layer is required to place on the first inner layer, right below the IC layer.
- The high current paths (GND, IN, and SW) should be placed very close to the device with short, direct and wide traces.
- VCC decoupling capacitor (C5) should be as close to the VCC pin as possible, connect its GND net to PGND copper.
- Connect all AGND signals together to AGND pin at first, then Kelvin connect AGND to PGND near the VCC decoupling capacitor (C5) GND pad on Top layer. Keep AGND trace 20mil or wider.
- The external feedback resistors should be placed next to the FB pin. Make sure that there is no via on the FB trace and away from the switching node SW.
- Keep the BST voltage path (BST, C3, Rbst and SW) as short as possible.
- Keep the Vout sense trace away from noise signal, such as SW, VIN, etc. Put the Vout sense point to a stable, quiet output point close to Vout cap.

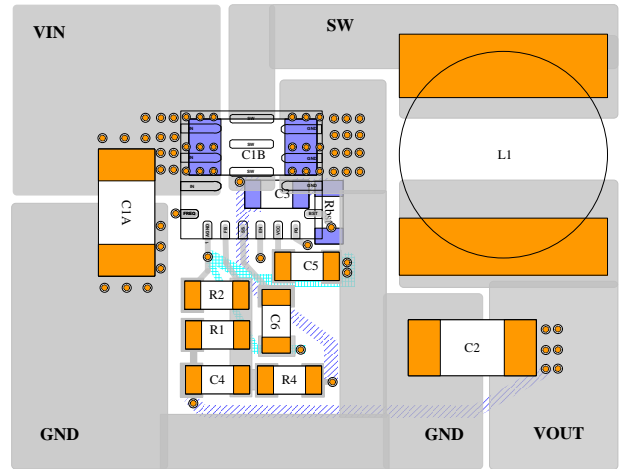
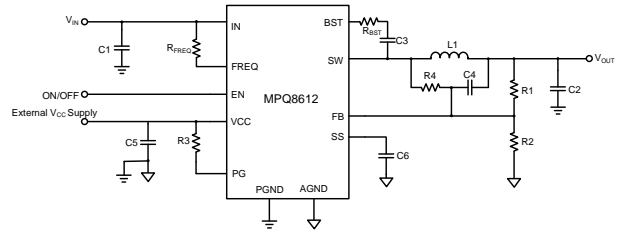

Figure 16—PCB LAYOUT

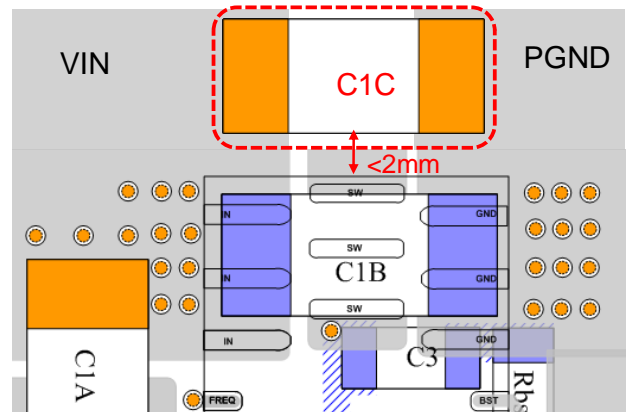
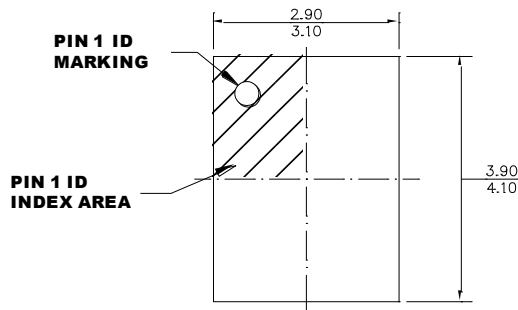
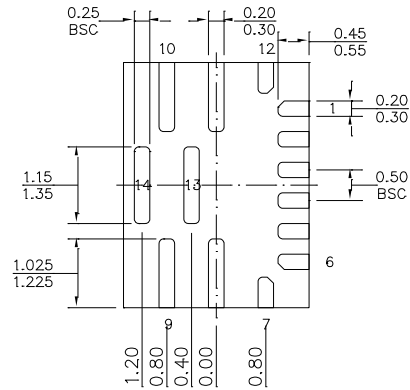
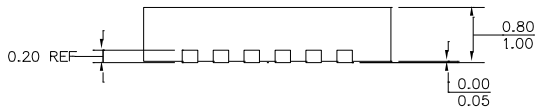
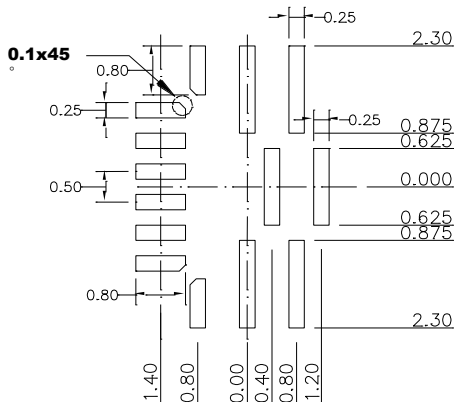

Figure 17—VIN Decouple Capacitor

PACKAGE INFORMATION
QFN (3mmx4mm)

TOP VIEW

BOTTOM VIEW

SIDE VIEW

RECOMMENDED LAND PATTERN
NOTE:

- 1) ALL DIMENSIONS ARE IN MILLIMETERS.
- 2) EXPOSED PADDLE SIZE DOES NOT INCLUDE MOLD FLASH
- 3) LEAD COPLANARITY SHALL BE 0.10 MILLIMETERS MAX.
- 4) JEDEC REFERENCE IS MO-220.
- 5) DRAWING IS NOT TO SCALE.

Revision History

Revision #	Revision date	Description	Pages Updated
R1.31	8/27/2020	Remove all information about MPQ8612GR-16 and MPQ8612GR-20	ALL PAGES

NOTICE: The information in this document is subject to change without notice. Please contact MPS for current specifications. Users should warrant and guarantee that third party Intellectual Property rights are not infringed upon when integrating MPS products into any application. MPS will not assume any legal responsibility for any said applications.

X-ON Electronics

Largest Supplier of Electrical and Electronic Components

Click to view similar products for [Switching Voltage Regulators](#) category:

Click to view products by [Monolithic Power Systems](#) manufacturer:

Other Similar products are found below :

[FAN53610AUC33X](#) [FAN53611AUC123X](#) [FAN48610BUC33X](#) [FAN48610BUC45X](#) [FAN48617UC50X](#) [R3](#) [430464BB](#) [KE177614](#)
[MAX809TTR](#) [NCV891234MW50R2G](#) [NCP81103MNTXG](#) [NCP81203PMNTXG](#) [NCP81208MNTXG](#) [NCP81109GMNTXG](#)
[SCY1751FCCT1G](#) [NCP81109JMNTXG](#) [AP3409ADNTR-G1](#) [NCP81241MNTXG](#) [LTM8064IY](#) [LT8315EFE#TRPBF](#) [NCV1077CSTBT3G](#)
[XCL207A123CR-G](#) [MPM54304GMN-0002](#) [MPM54304GMN-0003](#) [XDPE132G5CG000XUMA1](#) [MP8757GL-P](#) [MIC23356YFT-TR](#)
[LD8116CGL](#) [HG2269M/TR](#) [OB2269](#) [XD3526](#) [U6215A](#) [U6215B](#) [U6620S](#) [LTC3803ES6#TR](#) [LTC3803ES6#TRM](#) [LTC3412IFE](#) [LT1425IS](#)
[MAX25203BATJA/VY+](#) [MAX77874CEWM+](#) [XC9236D08CER-G](#) [ISL95338IRTZ](#) [MP3416GJ-P](#) [BD9S201NUX-CE2](#) [MP5461GC-Z](#)
[MPQ4415AGQB-Z](#) [MPQ4590GS-Z](#) [MCP1603-330IMC](#) [MCP1642B-18IMC](#) [MCP1642D-ADJIMC](#)