

15W isolated DC-DC converter in DIP package
Ultra-wide input and regulated dual output

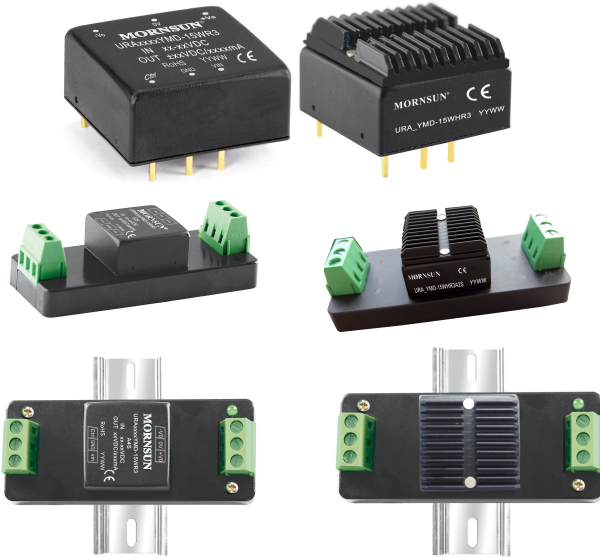

Patent Protection

CE Report
EN62368-1

UK CA Report
BS EN62368-1

RoHS

FEATURES

- Ultra-wide 4:1 input voltage range
- High efficiency up to 90%
- No-load power consumption as low as 0.24W
- I/O Isolation test voltage 1.5k VDC
- Input under-voltage protection, output short-circuit, over-current, over-voltage protection
- Operating ambient temperature range: -40°C to +105°C
- Meets CISPR32/EN55032 CLASS A without extra components
- Input reverse polarity protection available with Chassis (A2S) or 35mm DIN-Rail mounting (A4S) version
- Industry standard pin-out
- Meets EN50155 railway standard

URA_YMD-15WR3 series of isolated 15W DC-DC converter products have an ultra-wide 4:1 input voltage and feature efficiencies of up to 90%. Input to output isolation is tested with 1500VDC and the converters safely operate in an ambient temperature of -40°C to +105°C, input under-voltage protection, output short-circuit, over-current, over-voltage protection. They meet CLASS A of CISPR32/EN55032 EMI standards without extra components, optional packages are offered for chassis or DIN-rail mounting (A2S, A4S), adding additional input reverse polarity protection and they are widely used in applications such as industrial control, electric power, instruments, communication and railway fields.

Selection Guide

Certification	Part No. ①	Input Voltage (VDC)		Output		Full Load Efficiency ④ (%) Min./Typ.	Capacitive Load ⑤ (μF)Max.
		Nominal ② (Range)	Max. ③	Voltage(VDC)	Current (mA) Max./Min.		
EN/BS EN	URA2405YMD-15WR3	24 (9-36)	40	±5	±1500/0	85/87	1500
	URA2412YMD-15WR3			±12	±625/0	88/90	470
	URA2415YMD-15WR3			±15	±500/0	88/90	330
	URA2424YMD-15WR3			±24	±312/0	86/88	200
	URA4805YMD-15WR3	48 (18-75)	80	±5	±1500/0	84/86	1500
	URA4812YMD-15WR3			±12	±625/0	87/89	470
	URA4815YMD-15WR3			±15	±500/0	87/89	330
	URA4824YMD-15WR3			±24	±312/0	88/90	200

Notes:

- ① Use "H" suffix for heat sink mounting, "A2S" suffix for chassis mounting and "A4S" suffix for Din-Rail mounting. We recommend to choose modules with a heat sink for enhanced heat dissipation and applications with extreme temperature requirements;
- ② Minimum input voltage and start-up voltage are increased by 1VDC for all models with A2S (wiring) and A4S (rail) suffixes because of the input reverse polarity function;
- ③ Exceeding the maximum input voltage may cause permanent damage;
- ④ Efficiency is measured at nominal input voltage and rated output load; efficiencies for A2S and A4S Model's is decreased by 2% due to the input reverse polarity protection circuit;
- ⑤ The specified maximum capacitive load value for positive and negative output is identical.

Input Specifications

Item	Operating Conditions	Min.	Typ.	Max.	Unit
Input Current (full load / no-load)	24VDC nominal input series, nominal input voltage	--	719/10	-/20	mA
	48VDC nominal input series, nominal input voltage	--	364/5	-/11	
Reflected Ripple Current		--	30	--	

Surge Voltage (1sec. max.)	24VDC nominal input series	-0.7	--	50	VDC
	48VDC nominal input series	-0.7	--	100	
Start-up Voltage	24VDC nominal input series	--	--	9	
	48VDC nominal input series	--	--	18	
Input Under-voltage Protection	24VDC nominal input series	5.5	6.5	--	
	48VDC nominal input series	12	15.5	--	
Start-up Time	Nominal input voltage & constant resistance load	--	10	--	ms
Input Filter		Pi filter			
Hot Plug		Unavailable			
Ctrl *	Module on	Ctrl pin open or pulled high (3.5-12VDC)			
	Module off	Ctrl pin pulled low to GND (0-1.2VDC)			
	Input current when off	--	2	7	mA

Note: *The Ctrl pin voltage is referenced to input GND.

Output Specifications

Item	Operating Conditions	Min.	Typ.	Max.	Unit	
Voltage Accuracy ^①	5%-100% load	--	±1	±3	%	
Linear Regulation	Input voltage variation from low to high at full load	Vo1	±0.2	±0.5		
		Vo2	±0.4	±1		
Load Regulation ^②	5%-100% load	--	±0.5	±1		
Cross Regulation	Dual output, Vo1 load at 50%, Vo2 load at range of 10%-100%	--	--	±5		
Transient Recovery Time			300	500	μs	
Transient Response Deviation	25% load step change, nominal input voltage	All products	--	±3	±8	%
		5VDC output	--	±3	±5	
		Others	--	±3	±5	
Temperature Coefficient	Full load	--	--	±0.03	%/°C	
Ripple & Noise ^③	20MHz bandwidth, 5%-100% load	--	100	200	mV p-p	
Over-voltage Protection	Input voltage range	110	--	160	%Vo	
Over-current Protection		110	200	270	%Io	
Short-circuit Protection		Continuous, self-recovery				

Note: ① Output voltage accuracy for 0%-5% load is ±4% max;
 ② Load regulation for 0%-100% load is ±5%;
 ③ Under 0% -5% load conditions, ripple & noise does not exceed 5%Vo. The "parallel cable" method is used for ripple and noise test, please refer to DC-DC Converter Application Notes for specific information.

General Specifications

Item	Operating Conditions	Min.	Typ.	Max.	Unit
Isolation	Input-output Electric Strength Test for 1 minute with a leakage current of 1mA max	1500	--	--	VDC
	Input/output-case Electric Strength Test for 1 minute with a leakage current of 1mA max.	1000	--	--	
Insulation Resistance	Input-output resistance at 500VDC	1000	--	--	MΩ
Isolation Capacitance	Input-output capacitance at 100kHz/0.1V	--	2000	--	pF
Operating Temperature	See Fig. 1	-40	--	+105	°C
Storage Temperature		-55	--	+125	
Storage Humidity	Non-condensing	5	--	95	%RH
Pin Soldering Resistance Temperature	Soldering spot is 1.5mm away from case for 10 seconds	--	--	+300	°C
Vibration		IEC/EN61373 - Category 1, Grade B			
Switching Frequency *	PWM mode	--	270	--	kHz
MTBF	MIL-HDBK-217F@25°C	1000	--	--	k hours

Note: *Switching frequency is measured at full load. The module reduces the switching frequency for light load (below 50%) efficiency improvement.

Mechanical Specifications

Case Material	Aluminum alloy		
Dimensions	Horizontal package (without heat sink)		25.40 x 25.40 x 11.70 mm
	Horizontal package (with heat sink)		25.40 x 25.40 x 16.20 mm
	A2S chassis mounting (without heat sink)		76.00 x 31.50 x 21.20 mm
	A2S chassis mounting (with heat sink)		76.00 x 31.50 x 25.20 mm
	A4S DIN-Rail mounting (without heat sink)		76.00 x 31.50 x 25.80 mm
	A4S DIN-Rail mounting (with heat sink)		76.00 x 31.50 x 29.80 mm
Weight	without heat sink	Horizontal package/A2S chassis mounting/A4S DIN-Rail mounting	15.0g/35.0g/58.0g (Typ.)
	with heat sink	Horizontal package/A2S chassis mounting/A4S DIN-Rail mounting	19.0g/39.0g/62.0g(Typ.)
Cooling Methods	Free air convection		

Electromagnetic Compatibility (EMC)

Emissions	CE	CISPR32/EN55032	CLASS A (without extra components)/ CLASS B (see Fig.3-② for recommended circuit)	
	RE	CISPR32/EN55032	CLASS A (without extra components)/ CLASS B (see Fig.3-② for recommended circuit)	
Immunity	ESD	IEC/EN61000-4-2	Contact ±4kV	perf. Criteria B
	RS	IEC/EN61000-4-3	10V/m	perf. Criteria A
	EFT	IEC/EN61000-4-4	±2kV (see Fig.3-① for recommended circuit)	perf. Criteria B
	Surge	IEC/EN61000-4-5	line to line ±2kV (see Fig.3-① for recommended circuit)	perf. Criteria B
	CS	IEC/EN61000-4-6	3 Vr.m.s	perf. Criteria A

Electromagnetic Compatibility (EMC) (EN50155)

Emissions	CE	EN50121-3-2	150kHz-500kHz	99dBuV (see Fig.3-② for recommended circuit)
		EN55016-2-1	500kHz-30MHz	93dBuV (see Fig.3-② for recommended circuit)
	RE	EN50121-3-2	30MHz-230MHz	40dBuV/m at 10m (see Fig.3-② for recommended circuit)
		EN55016-2-1	230MHz-1GHz	47dBuV/m at 10m (see Fig.3-② for recommended circuit)
Immunity	ESD	EN50121-3-2	Contact ±6kV/Air ±8kV	
	RS	EN50121-3-2	20V/m	
	EFT	EN50121-3-2	±2kV 5/50ns	5kHz (see Fig.3-① for recommended circuit)
	Surge	EN50121-3-2	line to line ±1kV (42Ω, 0.5μF) (see Fig.3-① for recommended circuit)	
	CS	EN50121-3-2	0.15MHz-80MHz	10V r.m.s

Typical Characteristic Curves

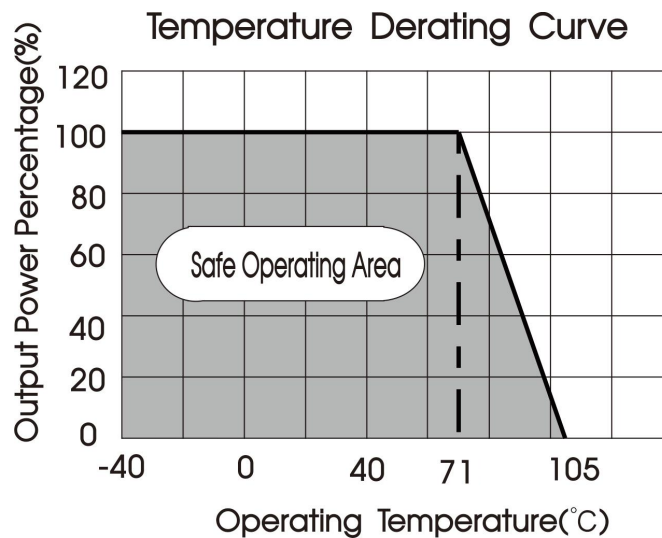
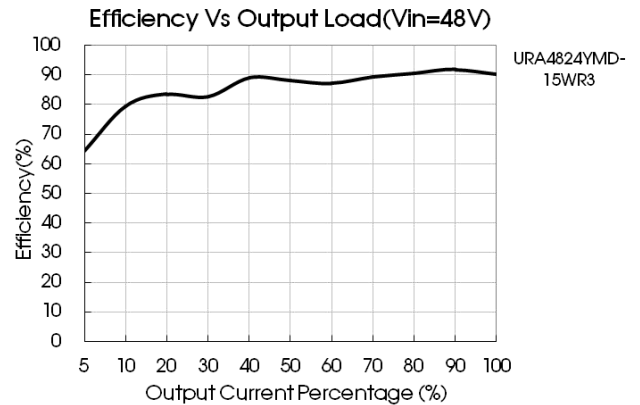
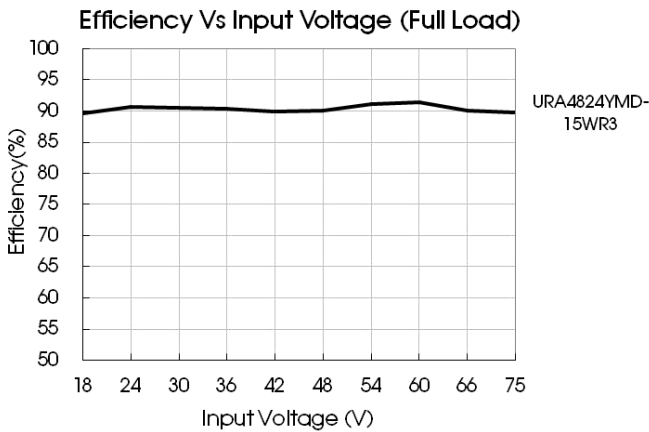
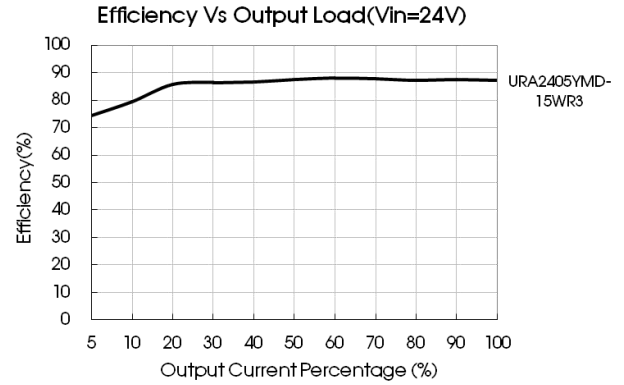
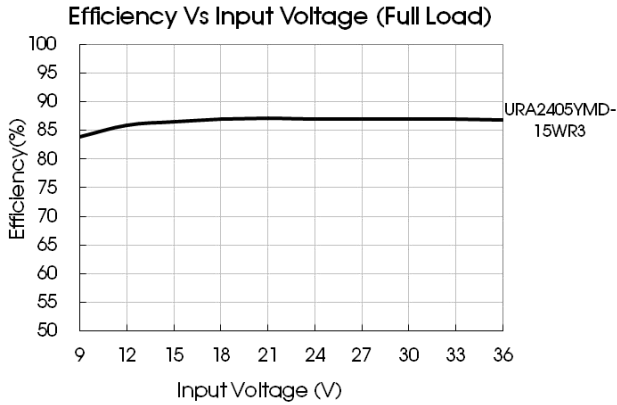

Fig. 1



Design Reference

1. Typical application

All the DC-DC converters of this series are tested before delivery using the recommended circuit shown in Fig. 2.

Input and/or output ripple can be further reduced by appropriately increasing the input & output capacitor values C_{in} and C_{out} and/or by selecting capacitors with a low ESR (equivalent series resistance). Also make sure that the capacitance is not exceeding the max. capacitive load value of the product.

Dual Output:



Fig. 2

Vin	24V	48V
Cin	100 μ F/50V	10 μ F -47 μ F/100V
Cout	10 μ F/100V	

2. EMC compliance circuit

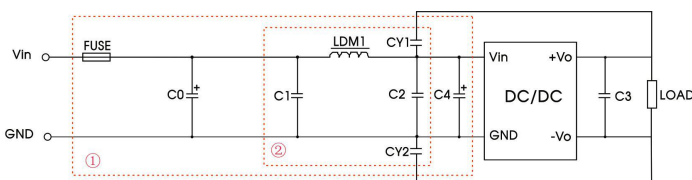

Fig. 3

Notes: For EMC tests we use Part ① in Fig. 3 for immunity and part ② for emissions test. Selecting based on needs.

Parameter description:

Model	Vin: 24VDC	Vin: 48VDC
FUSE	T/2.5A/250VAC	T/1.6A/250VAC
C0, C4	330 μ F/50V	330 μ F/100V
C1, C2	4.7 μ F/50V	4.7 μ F/100V
C3	Refer to the Cout in Fig.2	
LDM1	4.7 μ H	
CY1, CY2	1nF/2kV	

3. The products do not support parallel connection of their output

4. For additional information please refer to DC-DC converter application notes on www.mornsun-power.com

URA_YMD-15WR3 Dimensions

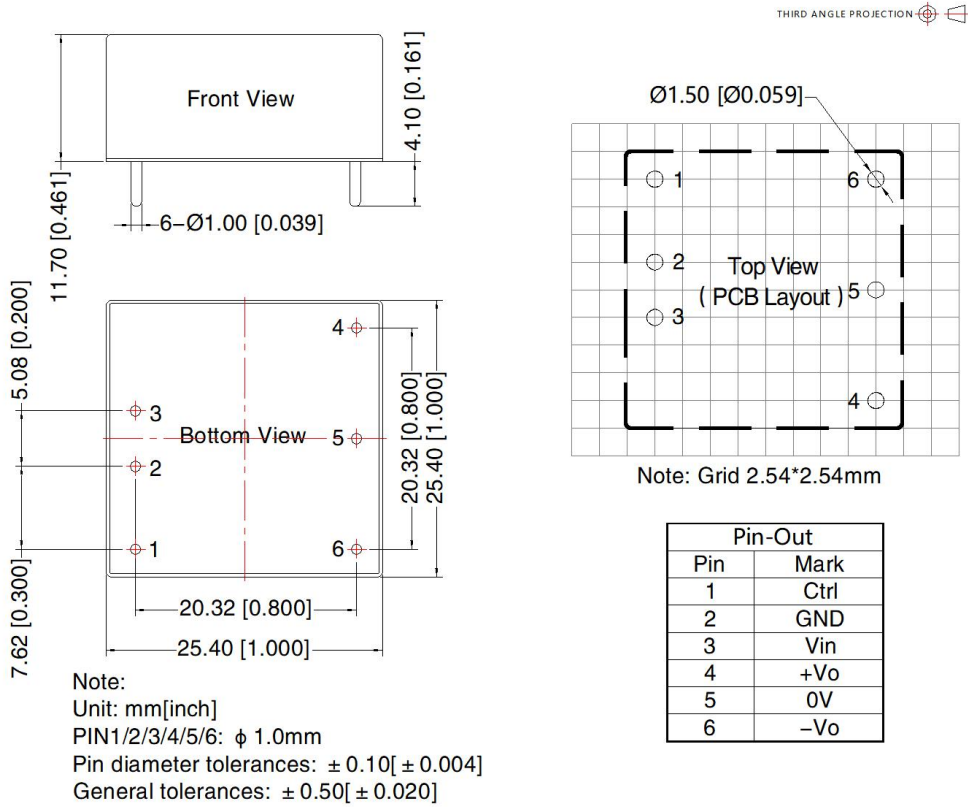

URA_YMD-15WHR3 Dimensions

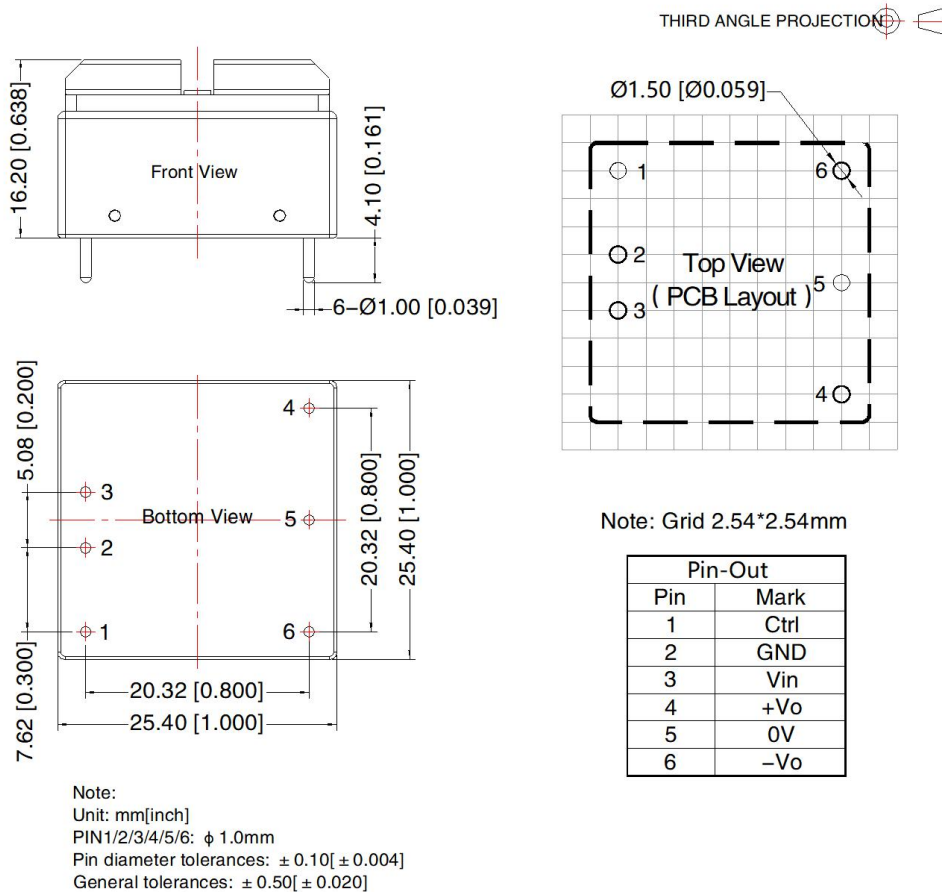

URA_YMD-15WR3A2S Dimensions

THIRD ANGLE PROJECTION 

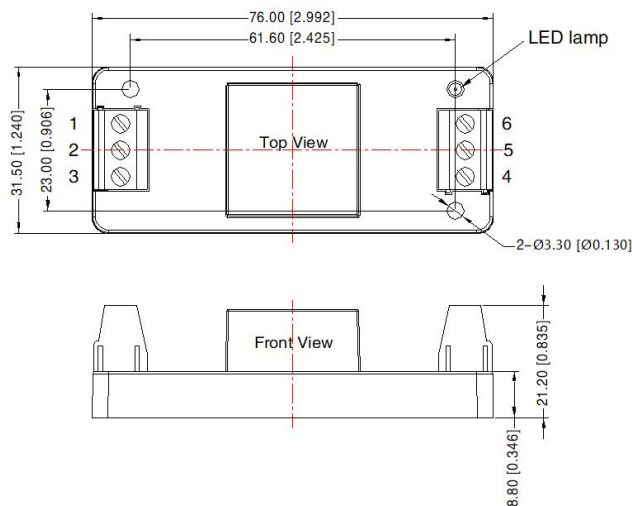

Pin-Out						
Pin	1	2	3	4	5	6
Mark	Ctrl	GND	Vin	+Vo	0V	-0V

Note:
Unit: mm[inch]
Wire range: 24-12 AWG
Tightening torque: Max 0.4 N · m
General tolerances: ± 1.00[± 0.039]

URA_YMD-15WHR3A2S Dimensions

THIRD ANGLE PROJECTION 

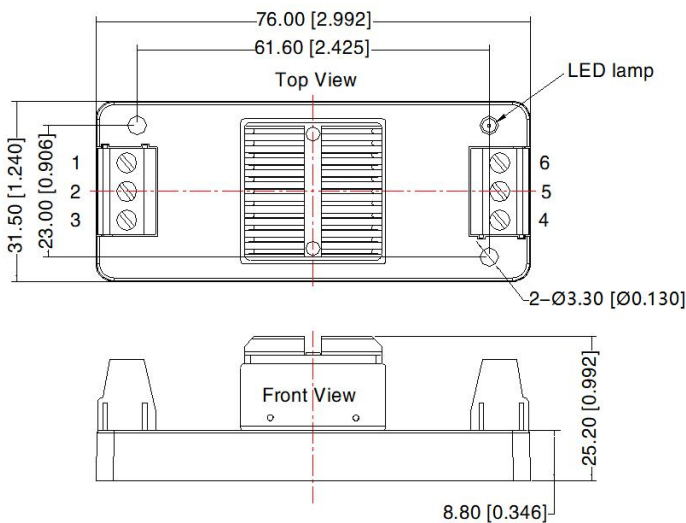

Pin-Out						
Pin	1	2	3	4	5	6
Mark	Ctrl	GND	Vin	+Vo	0V	-Vo

Note:
Unit: mm[inch]
Wire range: 24-12 AWG
Tightening torque: Max 0.4 N · m
General tolerances: ± 1.00[± 0.039]

URA_YMD-15WR3A4S Dimensions

THIRD ANGLE PROJECTION 

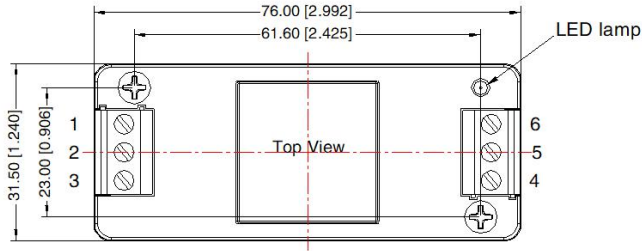

Pin-Out						
Pin	1	2	3	4	5	6
Mark	Ctrl	GND	Vin	+Vo	0V	-0V

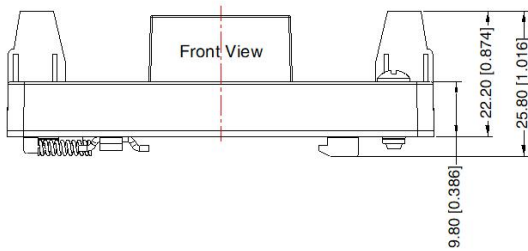

Note:
Unit: mm[inch]
Mounting rail: TS35
Wire range: 24-12 AWG
Tightening torque: Max 0.4 N · m
General tolerances: $\pm 1.00[\pm 0.039]$

URA_YMD-15WHR3A4S Dimensions

THIRD ANGLE PROJECTION 

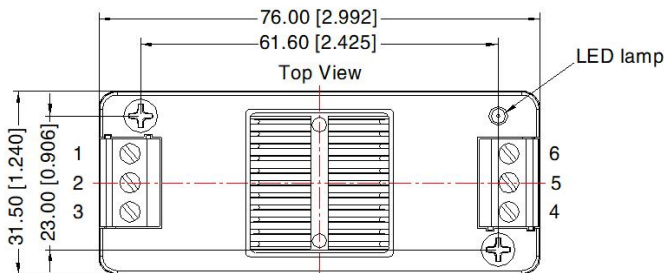

Pin-Out						
Pin	1	2	3	4	5	6
Mark	Ctrl	GND	Vin	+Vo	0V	-Vo

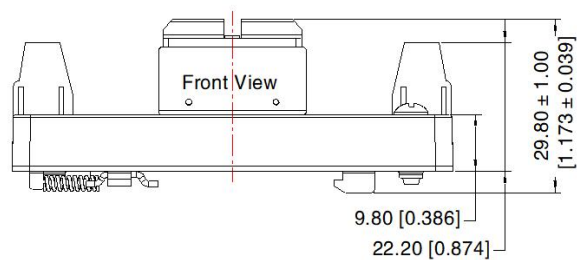

Note:
Unit: mm[inch]
Mounting rail: TS35
Wire range: 24-12 AWG
Tightening torque: Max 0.4 N · m
General tolerances: $\pm 1.00[\pm 0.039]$

Note:

1. For additional information on Product Packaging please refer to www.mornsun-power.com. The Packaging bag number of Horizontal package: 58210003(without heat sink), 58200048(with heat sink), A2S/ A4S package number: 58220022;
2. If the product is not operated within the required load range, the product performance cannot be guaranteed to comply with all parameters in the datasheet;
3. The maximum capacitive load offered were tested at nominal input voltage and full load;
4. Unless otherwise specified, parameters in this datasheet were measured under the conditions of $T_a=25^{\circ}\text{C}$, humidity<75%RH with nominal input voltage and rated output load;
5. All index testing methods in this datasheet are based on company corporate standards;
6. We can provide product customization service, please contact our technicians directly for specific information;
7. Products are related to laws and regulations: see "Features" and "EMC";
8. Our products shall be classified according to ISO14001 and related environmental laws and regulations, and shall be handled by qualified units.

Mornsun Guangzhou Science & Technology Co., Ltd.

Address: No. 5, Kehui St. 1, Kehui Development Center, Science Ave., Guangzhou Science City, Huangpu District, Guangzhou, P. R. China
Tel: 86-20-38601850 Fax: 86-20-38601272 E-mail: info@mornsun.cn www.mornsun-power.com

X-ON Electronics

Largest Supplier of Electrical and Electronic Components

Click to view similar products for [Power Management Modules](#) category:

Click to view products by [MORNSUN](#) manufacturer:

Other Similar products are found below :

[IA0505KS-2W](#) [IA1205KS-2W](#) [RKF60-48S12](#) [RMF100-12S24](#) [RMF100-48S12W](#) [RMF100-48S24W](#) [RMF150-24S12](#) [RMF150-24S24](#)
[RMF150-48S12](#) [RLM150-110S48](#) [RD5-12S24W](#) [RD5-110S05W](#) [RD5-110S12W](#) [RKD50-24S24](#) [RM150-110S24W](#) [MAS15-24-W](#)
[RKAS50-5-N](#) [RKAS100-12-N](#) [RKAS100-24-N](#) [KAS75-12-W](#) [KAS75-24-W](#) [RAS25-5-W](#) [RAS25-12-W](#) [RAS25-24-W](#) [TAS5-15-WEDT](#)
[ZY2424FLS-1W](#) [ZY0505AS-1W](#) [A1209S-2W](#) [A2409S-2W](#) [G2412S-1W](#) [E0509S-1W](#) [G0505S-1W](#) [E0509S-2W](#) [G2415S-2W](#) [G2412S-2W](#)
[E1212S-2W](#) [A0512S-1W](#) [A1212S-2W](#) [URB4824S-6WR3](#) [G2405S-1W](#) [E0505S-2W](#) [URB4805S-6WR3](#) [E2415S-2W](#) [TDK6-24S24W](#) [GH10-](#)
[V2S15](#) [GH60-V2S24-L](#) [GH25-V2S24-L](#) [GH75-V2S24](#) [GH05-V2S12-S](#) [GH10-V2S15-S](#)