

■ PRODUCT CHARACTERISTICS

VR(@IC=0.5mA)	150V
VF(@IF=5A)	0.85V
IR(@VR=150V)	20uA
ID	10A

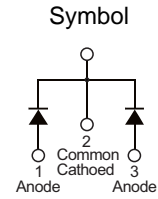

■ MECHANICAL CHARACTERISTICS

- \* Case: epoxy,molded
- \* Finish:all external surfaces corrosion resistant and terminal
- \* Leads are readily solderable
- \* Leads temperature for soldering purposes:  
260°C Max for 10 seconds

■ FEATURES

- \* Guard ring for stress protection
- \* Low forward voltage
- \* Low power loss/high efficiency
- \* High surge capacity
- \* Low stored charge majority carrier conduction
- \* Pb free package are available

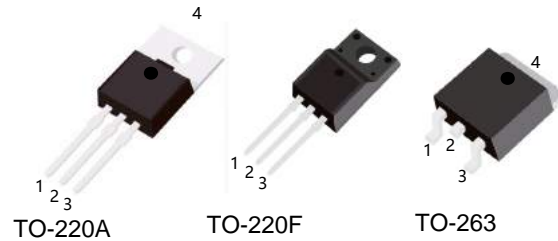

■ ORDER INFORMATION

Order codes		Package	Packing
Halogen-free	Halogen		
N/A	MBR10150A	TO-220	50pieces/Tube
N/A	MBR10150F	TO-220F	50pieces/Tube
N/A	MBR10150E	TO-263	800pieces/Reel

■ MAXIMUM RATINGS (Each diode leg)

Parameter	Symbol	Value	Unit
Peak repetitive reverse voltage	$V_{RRM}$	150	V
Average rectified output current	Total	10	A
	Per leg	5	A
Non-repetitive peak forward surge current 8.3ms single half sine-wave superimposed on reate load	$I_{FSM}$	150	A
Operating and storage temperature range	$T_J, T_{STG}$	-55 to + 175	°C

■ ELECTRICAL CHARACTERISTICS

Parameter	Symbol	Conditions	Min	Typ	Max	Unit
Peak repetitive reverse voltage	$B_V$	$I_C=0.5mA, T_J=25^\circ C$	150	-	-	V
Forward voltage drop	$V_F$	$I_F=5A, T_J=25^\circ C$	-	0.85	0.88	V
Leakage current	$I_R$	$V_R=150V, T_J=25^\circ C$	-	-	0.02	mA
		$V_R=150V, T_J=125^\circ C$	-	-	6	

■ TYPICAL CHARACTERISTICS

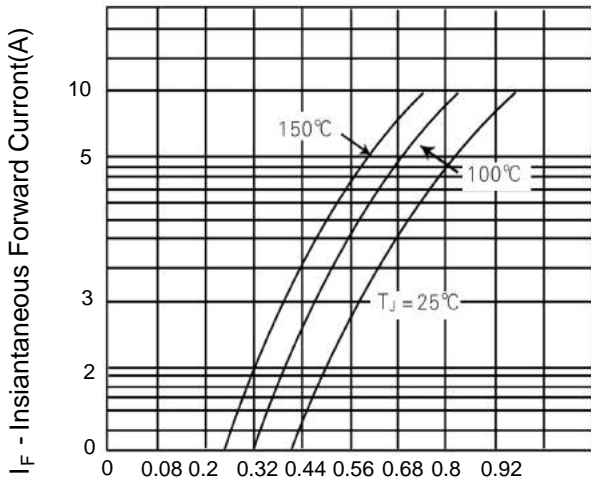

Figure 1 typical forward voltage per diode

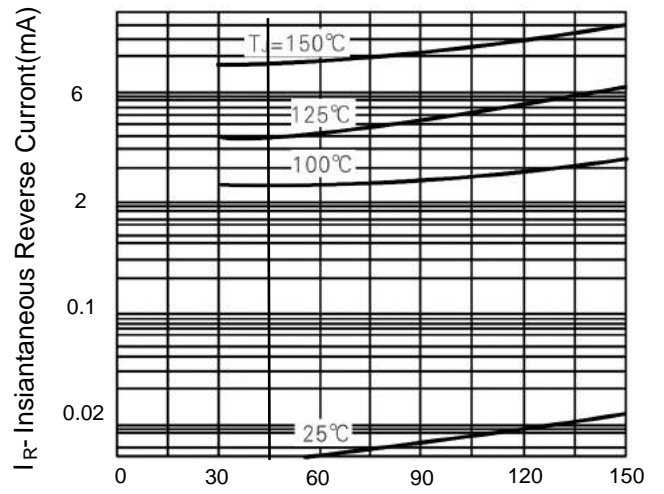

Figure 1 typical reverse current per diode

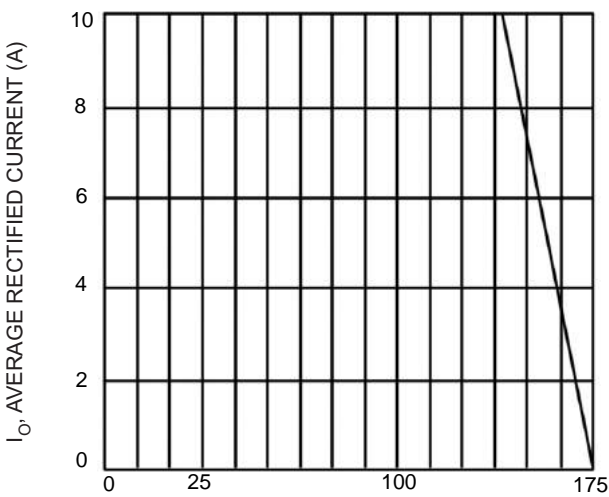

Figure 3 forward current derating curve

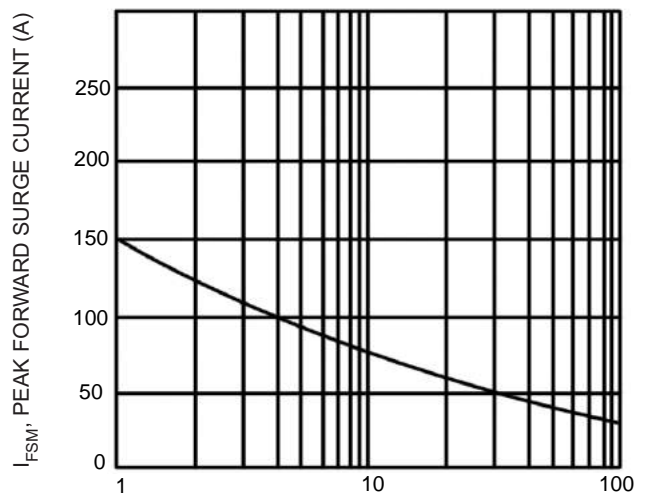
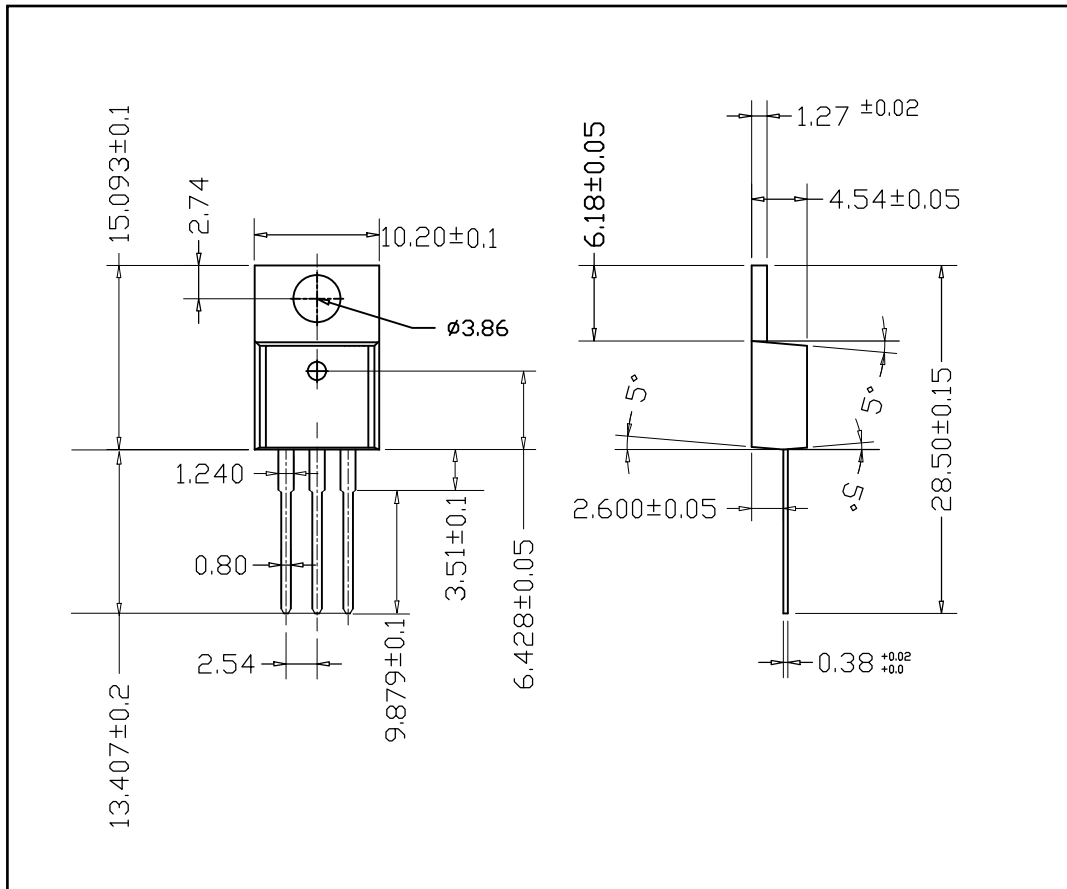

Figure 4 Max non repetitive surge current



■ TO-220 PACKAGE OUTLINE DIMENSIONS



■ TO-263 PACKAGE OUTLINE DIMENSIONS

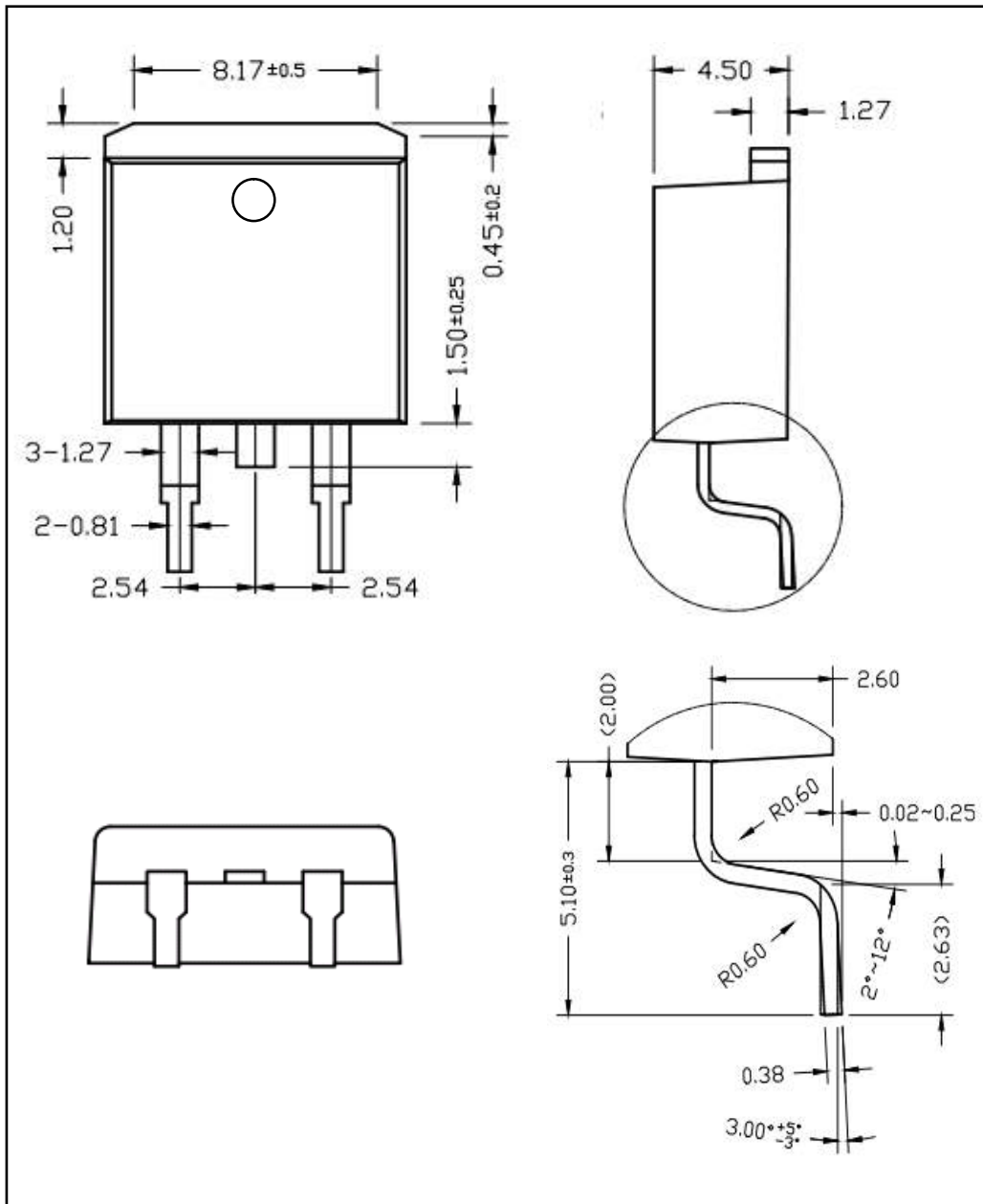

## X-ON Electronics

Largest Supplier of Electrical and Electronic Components

*Click to view similar products for [Schottky Diodes & Rectifiers](#) category:*

*Click to view products by [MOT](#) manufacturer:*

Other Similar products are found below :

[MA4E2039](#) [MMBD301M3T5G](#) [RB160M-50TR](#) [D83C](#) [BAS16E6433HTMA1](#) [BAS 3010S-02LRH E6327](#) [BAT 54-02LRH E6327](#)  
[NRVBAF360T3G](#) [NSR05F40QNXT5G](#) [NTE555](#) [JANS1N6640](#) [SS3003CH-TL-E](#) [GA01SHT18](#) [CRS10I30A\(TE85L,QM](#) [MBRA140TRPBF](#)  
[MBRB30H30CT-1G](#) [BAT 15-04R E6152](#) [JANTX1N5712-1](#) [DMJ3940-000](#) [SB007-03C-TB-E](#) [NRVBB20100CTT4G](#) [NRVBM120LT1G](#)  
[NTSB30U100CT-1G](#) [CRG04\(T5L,TEMQ\)](#) [ACDBA1100LR-HF](#) [ACDBA1200-HF](#) [ACDBA240-HF](#) [ACDBA3100-HF](#) [CDBQC0530L-HF](#)  
[ACDBA260LR-HF](#) [ACDBA1100-HF](#) [10BQ015-M3/5BT](#) [NRVBM120ET1G](#) [VSSB410S-M3/5BT](#) [1N5819T-G](#) [PDS1040Q-13](#) [B160BQ-13-F](#)  
[SDM05U20CSP-7](#) [BAS 70-07 E6433](#) [B140S1F-7](#) [HSM560Je3/TR13](#) [DDB2265-000](#) [ZHCS506QTA](#) [HSM190Je3/TR13](#) [B330AF-13](#)  
[ACDBUC0230-HF](#) [SDM1U100S1F-7](#) [MBR10200CTF-G1](#) [CDLL5712](#) [DMF2822-000](#)