

■ PRODUCT CHARACTERISTICS

VDSS	500V
$R_{DS(on)max}(@V_{GS}=10V)$	0.2Ω
ID	28A

■ APPLICATIONS

- \* High efficiency switch mode power supplies
- \* Electronic lamp ballasts based on half bridge
- \* LED power supplies

■ FEATURES

- \*  $R_{DS(ON)} \leq 0.2\Omega @ V_{GS}=10V$
- \* High Switching Speed
- \* Improved dv/dt capability

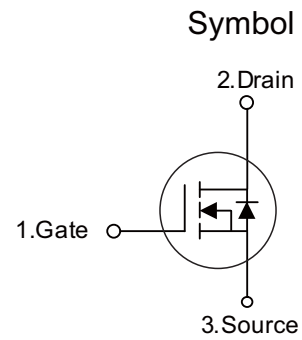

TO-220F

■ ORDER INFORMATION

Order codes		Package	Packing
Halogen-Free	Halogen		
N/A	MOT28N50HF	TO-220F	50 pieces/Tube

■ ABSOLUTE MAXIMUM RATINGS ( $T_C = 25^\circ\text{C}$ , unless otherwise specified)

Parameter	Symbol	Ratings	Units
Drain-source voltage	$V_{DSS}$	500	V
Gate-source voltage	$V_{GSS}$	±30	V
Drain current continuous	$I_D$	28	A
Drain current pulsed (note1)	$I_{DP}$	112	A
Avalanche energy	Repetitive	$E_{AR}$	43
	Single pulse	$E_{AS}$	1960
Peak diode recovery dv/dt (note 3)	dv/dt	4.5	V/ns
Total power dissipation	$T_C=25^\circ\text{C}$	$P_D$	479
	derate above $25^\circ\text{C}$		3.83
Junction temperature	$T_J$	+150	$^\circ\text{C}$
Storage temperature	$T_{STG}$	-55~+150	$^\circ\text{C}$

■ THERMAL DATA

PARAMETER	SYMBOL	RATINGS	UNIT
Junction to Ambient	$\theta_{JA}$	62.5	$^\circ\text{C}/\text{W}$
Junction to Case	$\theta_{JC}$	0.625	$^\circ\text{C}/\text{W}$

■ ELECTRICAL CHARACTERISTICS ( $T_J = 25^\circ\text{C}$ , unless otherwise specified)

Parameter	Symbol	Conditions	Min	Typ	Max	Units
Off characteristics						
Drain-source breakdown voltage	$BV_{DSS}$	$V_{GS}=0V, I_D=250\mu A$	500	-	-	V
Zero gate voltage drain current	$I_{DSS}$	$V_{DS}=500V, V_{GS}=0V$	-	-	1	$\mu A$
		$V_{DS}=400V, T_C=125^\circ C$	-	-	10	$\mu A$
Gate-body leakage current	$I_{GSS}$	$V_{GS}=30V, V_{DS}=0V$	-	-	100	nA
		$V_{GS}=-30V, V_{DS}=0V$	-	-	-100	nA
On characteristics						
Gate threshold voltage	$V_{GS(th)}$	$V_{DS}=V_{GS}, I_D=250\mu A$	2.0	-	4.0	V
Static drain-source on-resistance	$R_{DS(on)}$	$V_{DS}=10V, I_D=14A$	-	0.16	0.2	$\Omega$
Forward transconductance	$g_{FS}$	$V_{DS}=40V, I_D=14A$ (note4)	-	26	-	S
Dynamic characteristics						
Input capacitance	$C_{iss}$	$V_{DS}=25V, V_{GS}=0V,$ $f=1MHz$	-	4085	-	pF
Output capacitance	$C_{oss}$		-	474	-	pF
Reverse transfer capacitance	$C_{rss}$		-	60	-	pF
Switching characteristics						
Turn-on delay time	$t_{d(on)}$	$V_{DD}=250V, I_D=28A,$ $R_G=25\Omega$ (note4,5)	-	45	-	ns
Rise time	$t_r$		-	87	-	ns
Turn-off delay time	$t_{d(off)}$		-	355	-	ns
Fall time	$t_f$		-	130	-	ns
Total gate charge	$Q_g$	$V_{DS}=400V, I_D=28A,$ $V_{GS}=10V$ (note4,5)	-	102	-	nC
Gate-source charge	$Q_{gs}$		-	43	-	nC
Gate-drain charge	$Q_{gd}$		-	20	-	nC
Drain-source diode characteristics						
Drain-source diode forward voltage	$V_{SD}$	$V_{GS}=0V, I_D=28A$	-	-	1.4	V
Continuous drain-source current	$I_{SD}$		-	-	28	A
Pulsed drain-source current	$I_{SM}$		-	-	112	A
Reverse recovery time	$t_{rr}$	$I_{SD}=28A$ $di_{SD}/dt=100A/\mu s$ (note4)	-	656	-	ns
Reverse recovery charge	$Q_{rr}$		-	11.5	-	$\mu C$

Note:1 Repetitive rating: pulse width limited by maximum junction temperature

2.  $L=5mH, I_{AS}=28A, V_{DD}=50V, R_G=25\Omega$ , starting  $T_J=25^\circ C$
3.  $I_{SD}\leq 28A, di/dt\leq 100A/\mu s, V_{DD}\leq BV_{DSS}$ , starting  $T_J=25^\circ C$
4. Pulse test: pulse width  $\leq 300\mu s$ , duty cycle  $\leq 2\%$
5. Essentially independent of operating temperature

■ ELECTRICAL CHARACTERISTICS DIAGRAMS

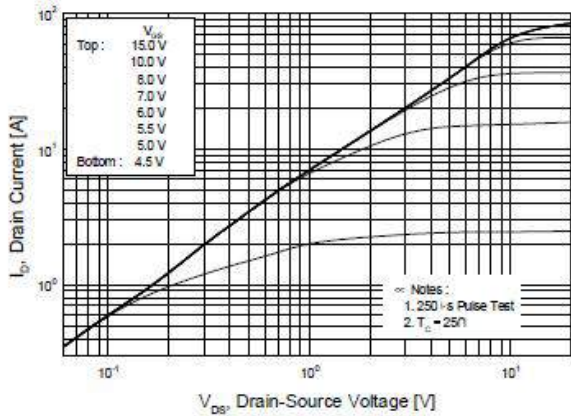

Figure 1. On-Region Characteristics

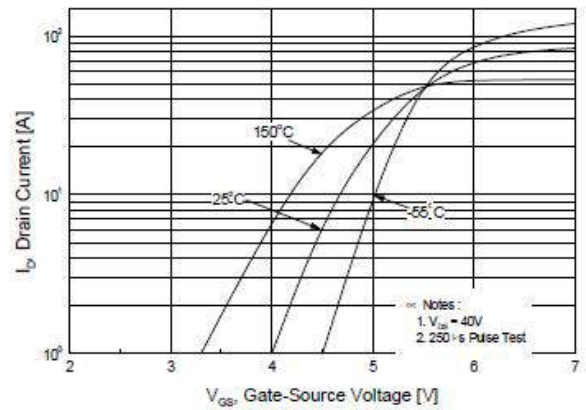

Figure 2. Transfer Characteristics

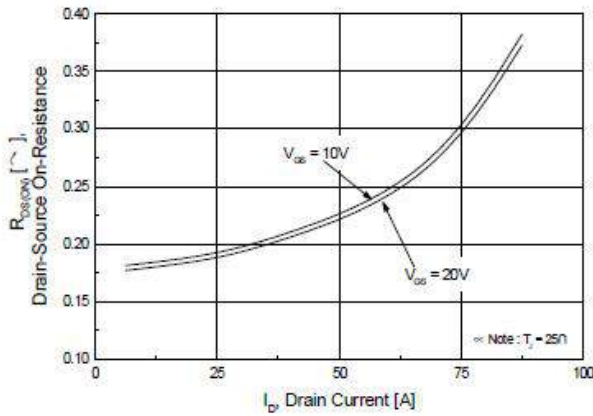

Figure 3. On-Resistance Variation vs Drain Current and Gate Voltage

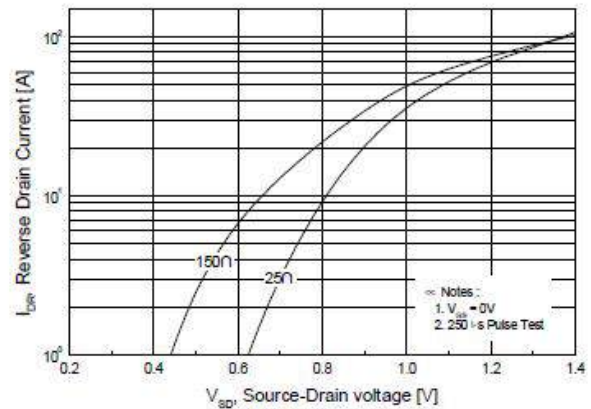

Figure 4. Body Diode Forward Voltage Variation with Source Current and Temperature

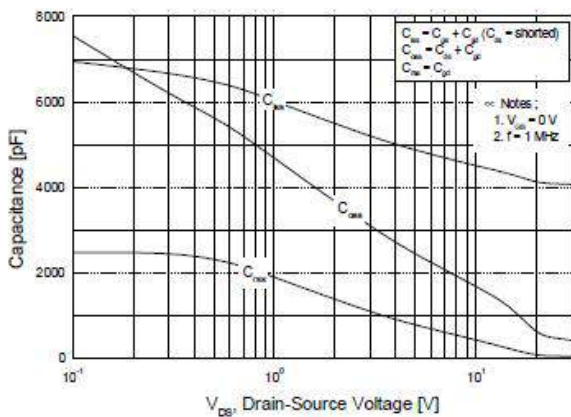

Figure 5. Capacitance Characteristics

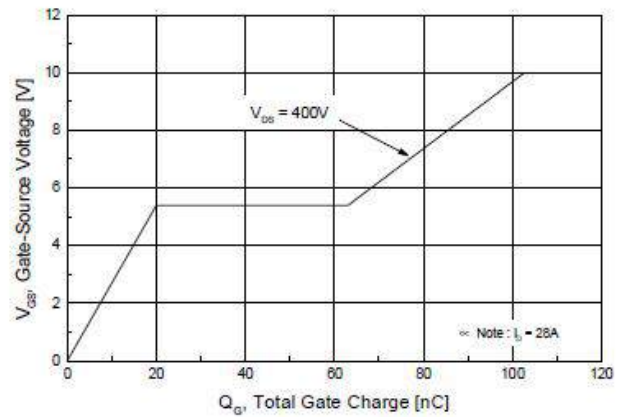

Figure 6. Gate Charge Characteristics

■ ELECTRICAL CHARACTERISTICS DIAGRAMS(Cont.)

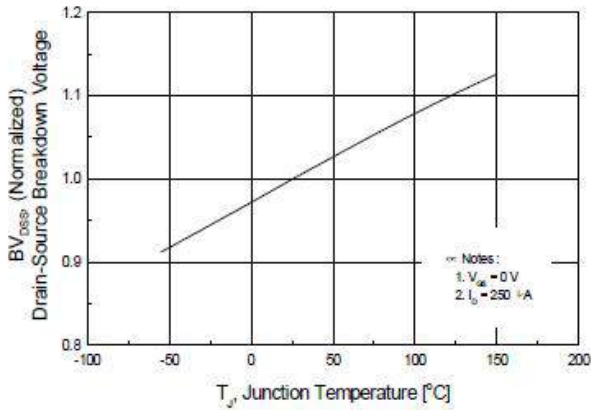

Figure 7. Breakdown Voltage Variation vs Temperature

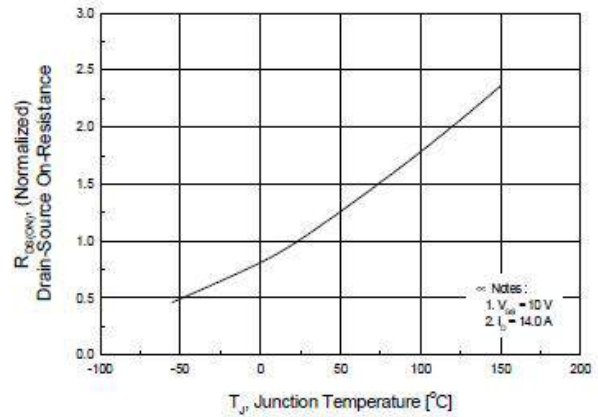

Figure 8. On-Resistance Variation vs Temperature

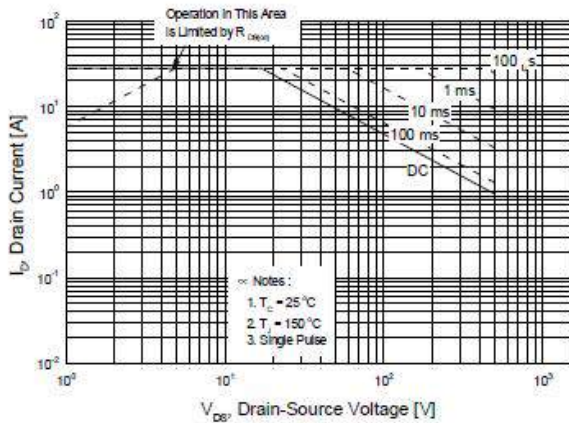

Figure 9. Maximum Safe Operating Area

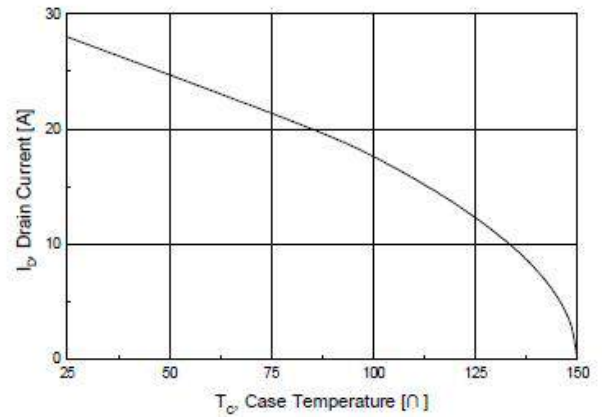

Figure 10. Maximum Drain Current vs Case Temperature

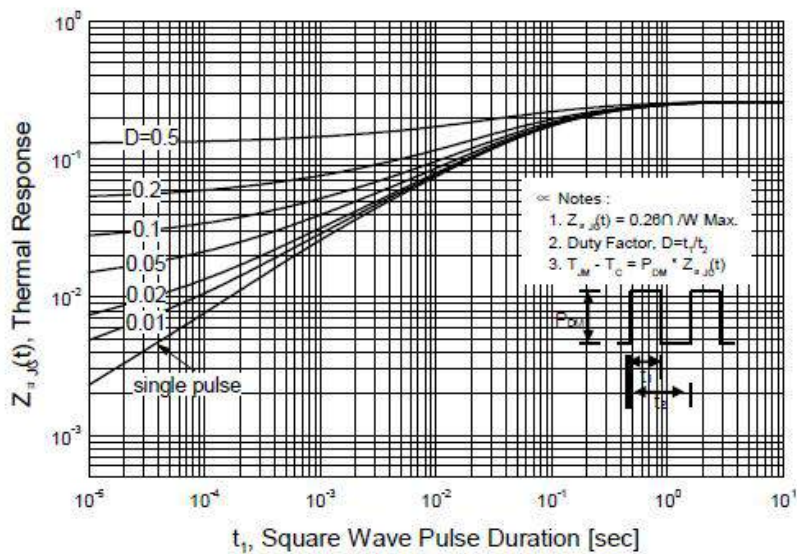
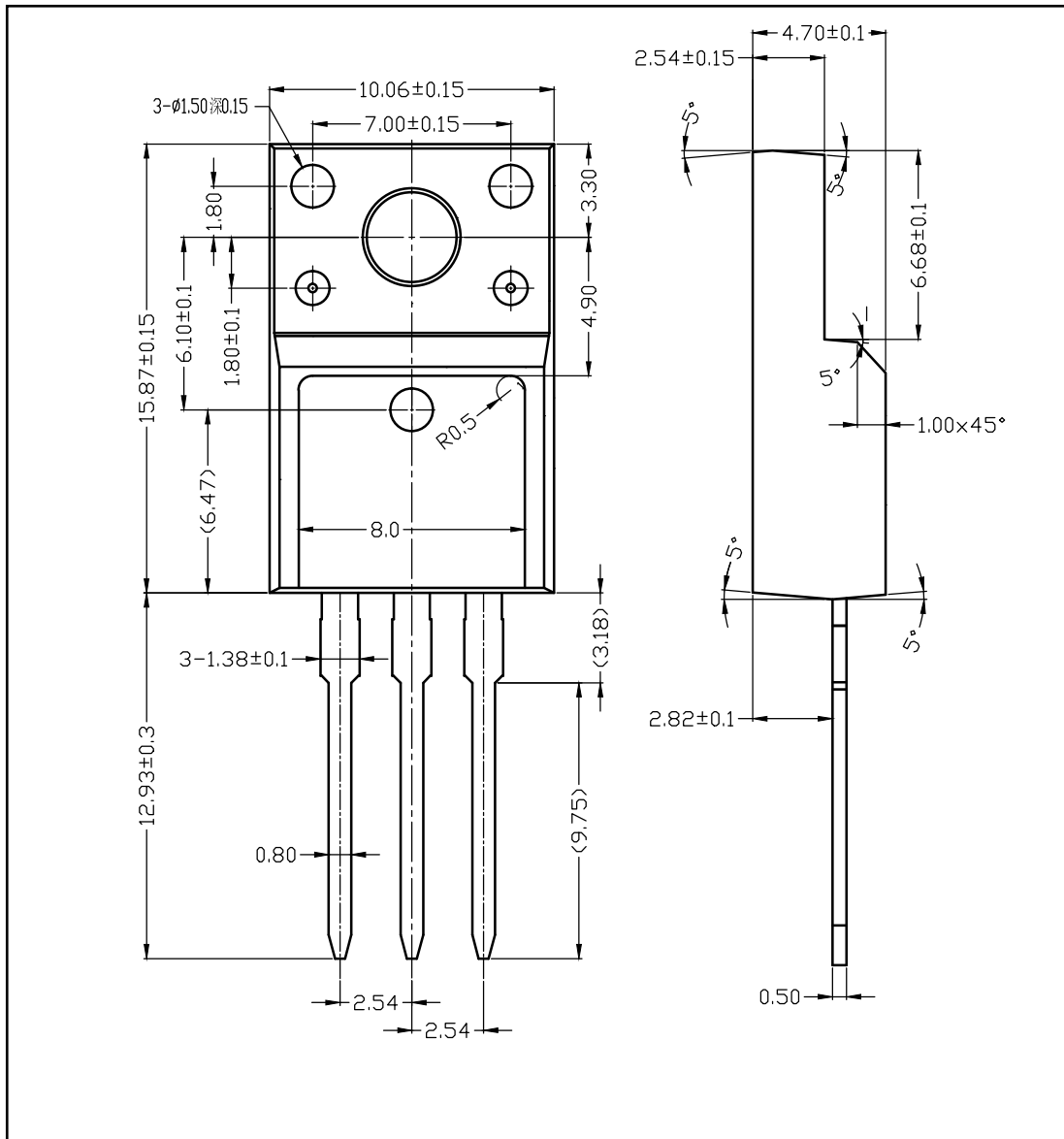

Figure 11. Transient Thermal Response Curve

■ TO-220F-3L PACKAGE OUTLINE DIMENSIONS



## X-ON Electronics

Largest Supplier of Electrical and Electronic Components

*Click to view similar products for [MOSFET](#) category:*

*Click to view products by [MOT](#) manufacturer:*

Other Similar products are found below :

[IRFD120](#) [JANTX2N5237](#) [BUK455-60A/B](#) [MIC4420CM-TR](#) [VN1206L](#) [NDP4060](#) [SI4482DY](#) [IPS70R2K0CEAKMA1](#) [SQD23N06-31L-GE3](#)  
[TK16J60W,S1VQ\(O](#) [2SK2614\(TE16L1,Q\)](#) [DMN1017UCP3-7](#) [DMN1053UCP4-7](#) [SQJ469EP-T1-GE3](#) [NTE2384](#) [DMC2700UDMQ-7](#)  
[DMN2080UCB4-7](#) [DMN61D9UWQ-13](#) [US6M2GTR](#) [DMN31D5UDJ-7](#) [DMP22D4UFO-7B](#) [DMN1006UCA6-7](#) [DMN16M9UCA6-7](#)  
[STF5N65M6](#) [IRF40H233XTMA1](#) [STU5N65M6](#) [DMN6022SSD-13](#) [DMN13M9UCA6-7](#) [DMTH10H4M6SPS-13](#) [DMN2990UFB-7B](#)  
[IPB80P04P405ATMA2](#) [2N7002W-G](#) [MCAC30N06Y-TP](#) [MCQ7328-TP](#) [BXP7N65D](#) [BXP4N65F](#) [AOL1454G](#) [WMJ80N60C4](#) [BXP2N20L](#)  
[BXP2N65D](#) [BXT1150N10J](#) [BXT1700P06M](#) [TSM60NB380CP](#) [ROG](#) [RQ7L055BGTCR](#) [DMNH15H110SK3-13](#) [SLF10N65ABV2](#)  
[BSO203SP](#) [BSO211P](#) [IPA60R230P6](#) [IPA60R460CE](#)