

■ PRODUCT CHARACTERISTICS

V _{DSS}	30V
R _{DS(on)} Typ@V _{GS} =10V	4.5mΩ
R _{DS(on)} Typ@V _{GS} =4.5V	8mΩ
I _D	65A

■ APPLICATIONS

- DC/DC converter
- Ideal for high-frequency swihcing and synchronous rectification

■ FEATURES

- Excellent R_{DS(on)} and low gate charge
- Lead free product is acquired

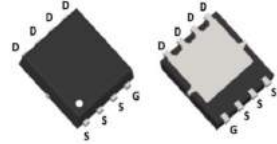
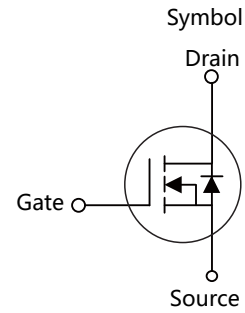

■ ORDER INFORMATION

Order codes		Package	Packing
Halogen-free	Halogen		
N/A	MOT3150G	PDFN5X6	5000pieces/Reel

■ ABSOLUTE MAXIMUM RATINGS(T_c = 25°C unless otherwise noted)

Parameter	Symbol	Value	Unit
Drain -source voltage	V _{DSS}	30	V
Gate -source voltage	V _{GSS}	±20	V
Continuous drain Current	I _D	T _C = 25°C	65
		T _C = 100°C	45
Pulsed drain Current	I _{DM}	200	A
Single pulsed avalanche energy	E _{AS}	150	mJ
Power dissipation	P _D	65	W
Operating and storage temperature range	T _J , T _{STG}	55 to +150	°C

■ THERMAL CHARACTERISTICS

Parameter	Symbol	Value	Unit
Thermal Resistance- Junction to Case	R _{θJC}	1.92	°C/W

■ ELECTRICAL CHARACTERISTICS (Tc=25°C, unless otherwise specified)

Parameter	Symbol	Conditions	Min	Typ	Max	Unit
Off characteristics						
Drain-source breakdown voltage	BV_{DSS}	$V_{GS} = 0V, I_{DS} = 250\mu A$	30	-	-	V
Zero gate voltage drain current	I_{DSS}	$V_{DS} = 30V, V_{GS} = 0V$	-	-	1	μA
Gate to body leakage current	I_{GSS}	$V_{GS} = \pm 20V, V_{DS} = 0V$	-	-	± 100	nA
On characteristics						
Gate threshold voltage	$V_{GS(th)}$	$V_{DS} = V_{GS}, I_D = 250\mu A$	1	-	2.5	V
Stantic drain-source on-state resistance	$R_{DS(ON)}$	$V_{GS} = 10V, I_D = 20A$	-	4.5	5	m Ω
		$V_{GS} = 4.5V, I_D = 20A$	-	8	9	m Ω
Forward transconductance	g_{FS}	$V_{DS} = 5V, I_D = 20A$	5	-	-	S
Dynamic characteristics						
Input capacitance	C_{iss}	$V_{GS} = 0V, V_{DS} = 15V,$ Frequency = 1MHz	-	1400	-	pF
Output capacitance	C_{oss}		-	205	-	pF
Reverse transfer capacitance	C_{rss}		-	177	-	pF
Total gate charge	Q_g	$V_{DS} = 15V, V_{GS} = 10V,$ $I_D = 20A,$	-	40	-	nC
Gate-source charge	Q_{gs}		-	21	-	nC
Gate-drain charge	Q_{gd}		-	7	-	nC
Switching characteristics						
Turn-on delay Time	$t_{d(on)}$	$V_{DD} = 15V, V_{GS} = 10V,$ $R_G = 6\Omega, I_D = 20A$	-	9	-	nS
Turn-on rise Time	t_r		-	8	-	nS
Turn-off delay Time	$t_{d(off)}$		-	28	-	nS
Turn-off fall Time	t_f		-	5	-	nS
Drain-source diode characteristics						
Diode forward current	I_S		-	-	65	A
Drain forward voltage	V_{SD}	$V_{GS} = 0V, I_D = 20A$	-	-	1.2	V
Body diode reverse recovery time	t_{rr}	$I_F = 20A, di/dt = 100A/\mu s$	-	27	-	nS
Body diode reverse recovery charge	Q_{rr}	$I_F = 20A, di/dt = 100A/\mu s$	-	20	-	nS

■ TYPICAL CHARACTERISTICS

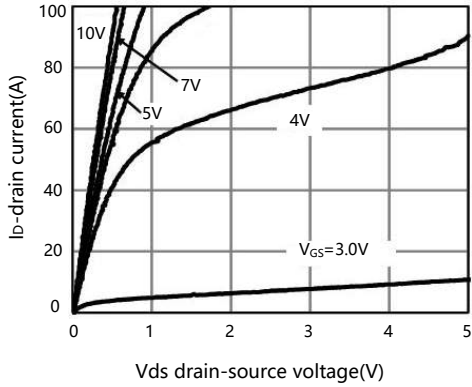

Figure 1 output characteristics

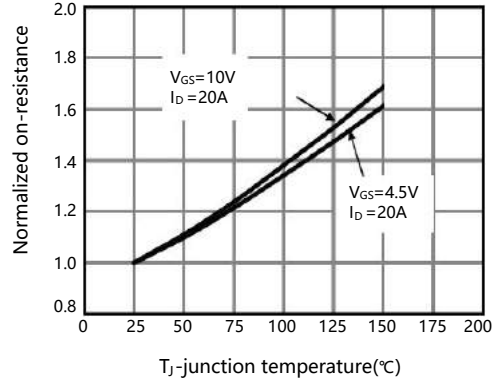

Figure 2 $R_{DS(on)}$ -junction temperature

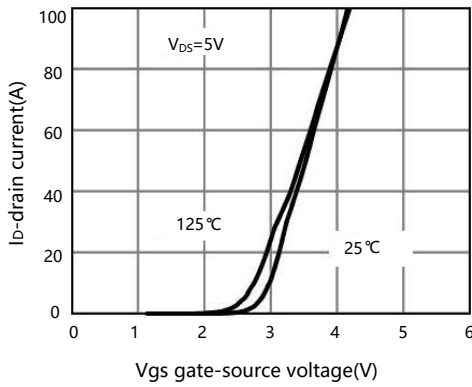

Figure 3 transfer characteristics

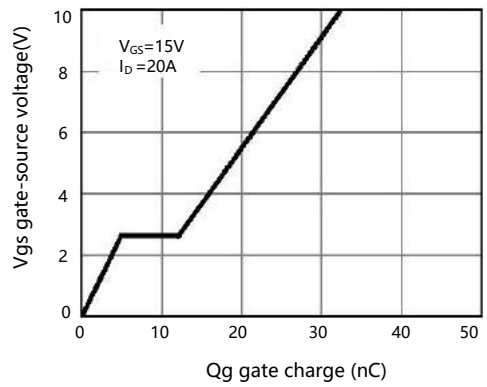

Figure 4 gate charge

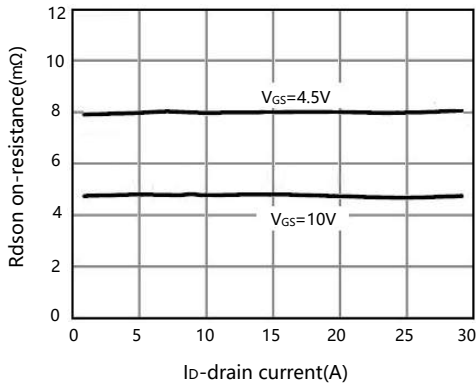

Figure 5 $r_{DS(on)}$ -drain current

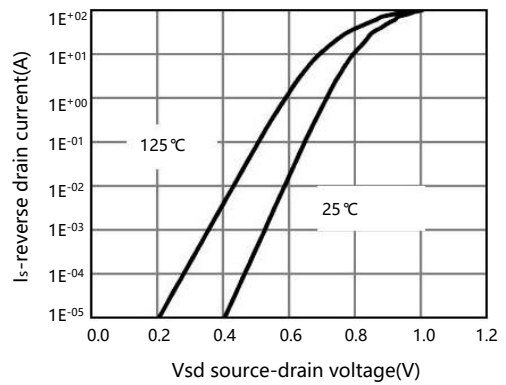

Figure 6 source-drain diode forward

■ TYPICAL CHARACTERISTICS(Cont.)

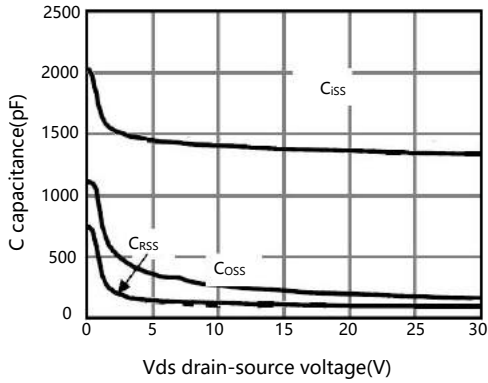

Figure 7 capacitance vs Vds

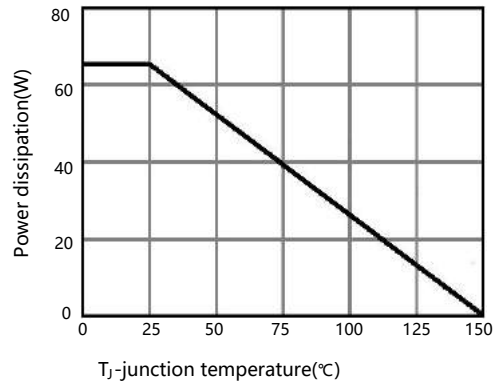

Figure 8 power de-rating

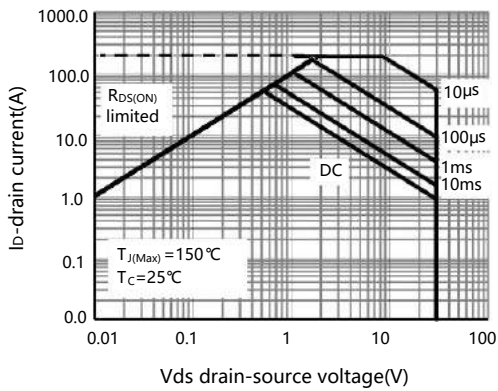

Figure 9 safe operation area

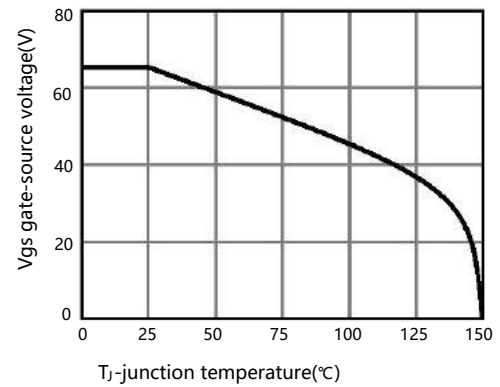

Figure 10 id current-junction temperature

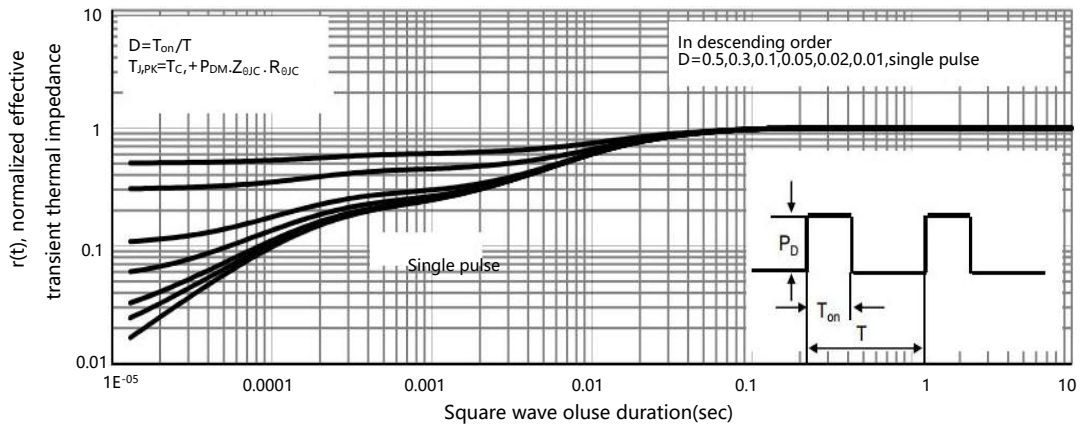
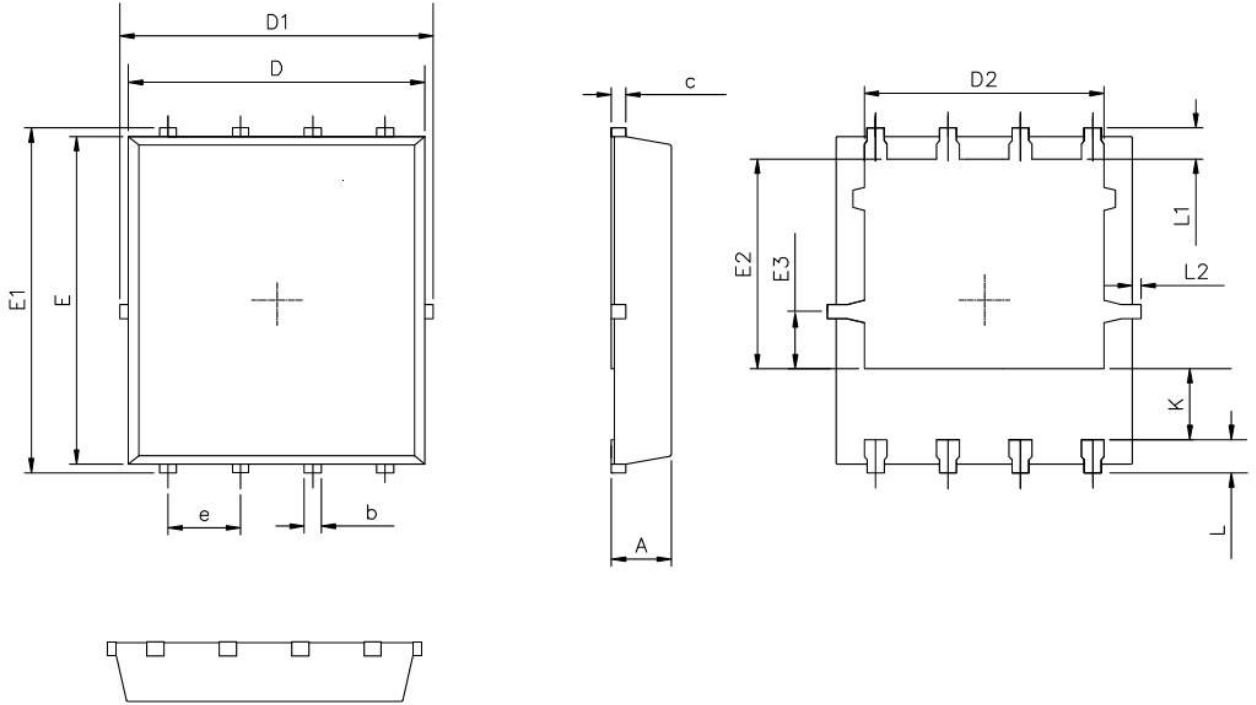
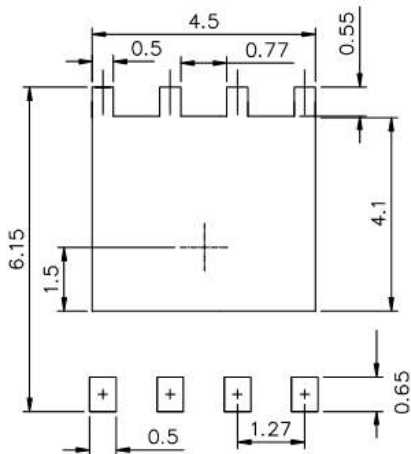

Figure 11 Normalized maximum transient thermal impedance

■ PDFN5X6-8L Package mechanical data



RECOMMENDED LAND PATTERN



UNIT:mm

	MIN	NOM	MAX
A	0.90	1.00	1.10
b	0.25	0.35	0.50
c	0.10	0.20	0.30
D	4.80	5.00	5.30
D1	4.90	5.10	5.50
D2	3.92	4.02	4.20
E	5.65	5.75	5.85
E1	5.90	6.05	6.20
E2	3.325	3.525	3.775
E3	0.80	0.90	1.00
e		1.27	
L	0.40	0.55	0.70
L1		0.65	
L2	0.00		0.15
K	1.00	1.30	1.50

X-ON Electronics

Largest Supplier of Electrical and Electronic Components

Click to view similar products for [MOSFET](#) category:

Click to view products by [MOT](#) manufacturer:

Other Similar products are found below :

[IRFD120](#) [JANTX2N5237](#) [BUK455-60A/B](#) [MIC4420CM-TR](#) [VN1206L](#) [NDP4060](#) [SI4482DY](#) [IPS70R2K0CEAKMA1](#) [SQD23N06-31L-GE3](#)
[TK16J60W,S1VQ\(O](#) [2SK2614\(TE16L1,Q\)](#) [DMN1017UCP3-7](#) [DMN1053UCP4-7](#) [SQJ469EP-T1-GE3](#) [NTE2384](#) [DMC2700UDMQ-7](#)
[DMN2080UCB4-7](#) [DMN61D9UWQ-13](#) [US6M2GTR](#) [DMN31D5UDJ-7](#) [DMP22D4UFO-7B](#) [DMN1006UCA6-7](#) [DMN16M9UCA6-7](#)
[STF5N65M6](#) [IRF40H233XTMA1](#) [STU5N65M6](#) [DMN6022SSD-13](#) [DMN13M9UCA6-7](#) [DMTH10H4M6SPS-13](#) [DMN2990UFB-7B](#)
[IPB80P04P405ATMA2](#) [2N7002W-G](#) [MCAC30N06Y-TP](#) [MCQ7328-TP](#) [BXP7N65D](#) [BXP4N65F](#) [AOL1454G](#) [WMJ80N60C4](#) [BXP2N20L](#)
[BXP2N65D](#) [BXT1150N10J](#) [BXT1700P06M](#) [TSM60NB380CP](#) [ROG](#) [RQ7L055BGTCR](#) [DMNH15H110SK3-13](#) [SLF10N65ABV2](#)
[BSO203SP](#) [BSO211P](#) [IPA60R230P6](#) [IPA60R460CE](#)