



Reference Manual

3G-SDI FMC Card

Revision

B

2017/10/23

© 2017 Macnica, Inc.

Disclaimer

The information in this document (hereinafter called “Information”) is subject to change without notice.

Macnica Inc. (Developer) makes no warranty of any kind regarding this document, or of any liability arising out of the application or use of information in this document, and assumes no responsibility for any errors that may appear in this document.

This document is distributed without any charge and reselling or copying without written authorization by Developer is restricted.

IN NO EVENT WILL DEVELOPER BE LIABLE FOR ANY CONSEQUENTIAL, INDIRECT, EXEMPLARY, SPECIAL, OR INCIDENTAL DAMAGES, INCLUDING ANY LOST DATA AND LOST PROFITS, ARISING FROM OR RELATING TO YOUR USE OF THE INFORMATION, EVEN IF YOU HAVE BEEN ADVISED OF THE POSSIBILITY OF SUCH DAMAGES. THE TOTAL CUMULATIVE LIABILITY OF DEVELOPER IN CONNECTION WITH YOUR USE OF THE INFORMATION IN THIS DOCUMENT, WHETHER IN CONTRACT OR TORT OR OTHERWISE, WILL IN NO EVENT EXCEED THE AMOUNT OF FEES PAID BY YOU TO DEVELOPER HEREUNDER FOR USE OF THE INFORMATION. YOU ACKNOWLEDGE THAT THE FEES, IF ANY, REFLECT THE ALLOCATION OF RISK SET FORTH IN THIS AGREEMENT AND THAT DEVELOPER WOULD NOT MAKE AVAILABLE THE INFORMATION TO YOU WITHOUT THESE LIMITATIONS OF LIABILITY.

The Information is not intended for use in the development of on-line control equipment in hazardous environments requiring failsafe controls, such as in the operation of nuclear facilities, aircraft navigation or communications systems, air traffic control, life support, or weapons systems (“High-Risk Applications”). Developer specifically disclaims any express or implied warranties of fitness for such High-Risk Applications. You represent that use of the Information in such High-Risk Applications is fully at your risk.

Contents

1. Read This First	4
1.1 Important Information	4
1.2 Developer Information	5
1.3 Inquiries	5
2. For Ensuring Safe Use	6
2.1 Legend	6
2.2 Cautions	6
3. Unpacking	9
4. Functions and Features of the Card	10
4.1 Main Features	10
4.2 Product Specifications	10
4.3 Block Diagram	11
4.4 Card Layout	12
5. Components on the Card	14
5.1 Connector Pin Assignments	14
5.2 Video Sync Separator	16
5.3 Video Clock Generator	16
6. Handling Precautions	17
6.1 Insertion into / Removal from FMC	17
6.2 Using the Mounted IC	17
6.3 Mode Selection of Unused Pins	17
7. Document Revision History	19

1. Read This First

1.1 Important Information

READ FIRST:

- Before using this card, be sure to read this Reference Manual.
- Keep this Reference Manual so you can refer to it when necessary.
- You should sufficiently understand the card's configuration before you use it.

Card Application:

- This card is an FPGA Mezzanine Connector (hereafter FMC) daughter card that can be connected to and used with any FMC that complies with FMC ALTERA LPC+ standard. Combining with an FPGA evaluation board (hereafter Evaluation board), this card supports the development and verification of software and hardware for 3G-SDI I/O interfaces. Use this card correctly in line with the application.

People Who Are Expected to Use This Card:

- Only people who carefully read and understood this manual and the Getting Started manual should use this card. You need a fundamental understanding of FPGA, logic circuits, electronic circuits, and micro-computers to use this card.

Precautions When Using This Card:

- This card is a development support card used for the purpose of your hardware and software development and evaluation. This card cannot be used in your mass production products. Furthermore, when you want to use the card's sample designs for your products, please be sure to confirm if it withstands practical use at your own risk by doing necessary and sufficient tests and evaluations.
- Macnica Incorporated (hereafter Macnica Inc.) has no liability for any results arising from the use of the card.
- Macnica Inc. will attempt to provide either free or paid support to handle repair of faults or workarounds for faults with the card. This does not mean, however, that Macnica Inc. guarantees to provide a workaround or fix under all circumstances.
- Macnica Inc. cannot anticipate every possible circumstance that might involve a potential hazard. The warnings and precautions in this Reference Manual and on the card are therefore not all-inclusive. You are responsible for using the card correctly and safely.
- Even if there are faults with devices that are mounted on the card, Macnica Inc. will not replace it with a fault-fixed device.
- Each interface is not guaranteed to connect with all products.
- The card will not be replaced if you damaged or modified the card.
- The card uses lead-free parts.
- The rights to the trademarks and registered trademarks of the vendors noted in this manual belong to their respective vendors.

Improvement Policy:

- Macnica Inc. pursues a policy of continuous improvement in design, performance, and safety of the product.
Macnica Inc. reserves the right to change, wholly or partially, specifications, designs, this Reference Manual, and other documentation at any time, without prior notice to customers.

Warranty:

- Macnica Inc. offers to exchange this card free of charge only in case of initial malfunction noticed by you within 30 days from the delivery.
Macnica Inc. cannot exchange cards in cases where the malfunction is caused by the following reasons:
 - (1) Misuse, abuse of the card or use under abnormal conditions
 - (2) Remodeling or repair
 - (3) A fire, earthquake, fall or other accidents

Figures:

- Some figures in this manual may differ from your purchased card.

1.2 Developer Information

The Developer of this card is:

Macnica Inc.

1-6-3 Shin-Yokohama, Kouhoku-ku, Yokohama, 222-8561 JAPAN

1.3 Inquiries

In case you have any inquiries about the use of this card, please contact sales office you purchased or make inquiries through the contact form on the following web site.

Inquiries page:

<http://www.m-pression.com/contact/inquiry>

Inquiries to:

Macnica Inc.

Sales and Planning Advanced Technology



1-5-5 Shin-Yokohama, Kouhoku-ku, Yokohama, 222-8563 JAPAN

TEL: +81-45-470-9838



2. For Ensuring Safe Use



Be sure to follow the instructions given in this Manual which are intended to prevent harm to the user and others as well as material damage.

2.1 Legend

 Danger	Indicates an imminent hazardous situation which if not avoided will result in death or serious injury.
 Warning	Indicates a potentially hazardous situation which if not avoided could result in death or serious injury.
 Caution	Indicates a potentially hazardous situation which if not avoided may result in minor or moderate injury or in property damage.

2.2 Cautions

 Danger	<p>If an AC adapter is needed, be sure to use the AC adapter provided in the package or one that meets the specifications described in this manual. Using an AC adapter not meeting the specifications described in this manual may cause the card to emit heat, explode, or ignite.</p>
 Warning	<p>Do not apply strong impacts or blows to the card. Doing so may cause the card to emit heat, explode, or ignite, or the equipment in the card to fail or malfunction. This may also cause fire.</p>
	<p>Do not put this card or the AC adapter in cooking appliances such as microwave ovens, or high-pressure containers. Doing so might cause this card or AC adapter to emit heat, explode, ignite, or emit smoke, or its parts to break or warp.</p>
	<p>Do not cover or wrap this card that is in use with cloth or other materials that are likely to allow heat to build up inside the wrapping. This will cause heat to build up inside the wrapping which may cause this card to ignite or malfunction.</p>
	<p>When disposing of this card, do not dispose of it along with general household waste. Throwing this card into fire may cause it to explode. Dispose of this card following the laws, regulations, and ordinances governing waste disposal.</p>
	<p>Do not pull the power supply cable with excessive force or place heavy items on it. Do not damage, break, bundle, or tamper with the power supply cable. Damaged parts of the power supply cable might cause a short circuit resulting in fire or accidents involving electrical shock.</p>
	<p>Do not plug or unplug the power plug with wet or moist hands. This might cause injuries or equipment malfunctions or failures due to electrical shock.</p>

 <p>Warning (Continued from previous page)</p>	<p>Plug the power plug securely into the outlet. If the power plug is not securely plugged into the outlet, it may cause accidents involving electrical shock or fire due to heat emitted.</p> <p>Do not connect many electrical cords to a single socket or connect an AC adapter to an outlet that is not rated for the specified voltage. Doing so may cause the equipment to malfunction or fail, or lead to accidents involving electrical shock or fire due to heat emitted.</p> <p>Periodically remove any dust accumulated on the power plug and around the outlet (socket). Do not use a power plug with dust accumulated on it because doing so will lead to insulation failure due to moisture which may lead to fire. Remove any dust on the power plug and around the outlet with a dry cloth.</p> <p>Do not place any containers, such as cups or vases, filled with water or other liquids on the card. If the card is exposed to water or other liquids, it will cause a malfunction or electric shock. If you spilled water or other liquid on this card, immediately stop using the card, turn off the power, and unplug the power plug. If you have any requests for repairs or technical consultation, please contact the sales office you purchased or Mpression inquiry URL.</p> <p>Keep the card and accessories out of the reach of children. Failure to do so may lead to injuries.</p>
 <p>Caution</p>	<p>Do not place the card on unstable places such as shaky stands or tilted locations. Doing so may cause injuries or cause this card to malfunction if the card should fall.</p> <p>Do not attempt to use or leave the card in places subject to strong direct sunlight or other places subject to high temperatures such as in cars in hot weather. Doing so might cause the card to emit heat, break, ignite, run out of control, warp, or malfunction. Also, some parts of the equipment might emit heat, causing burn injuries.</p> <p>Do not use the card in places subject to extremely high or low temperatures or severe temperature changes. Doing so may cause the card to fail or to malfunction. Always be sure to use the card within a temperature range of 5°C to 35°C and a humidity range of 0% to 85%.</p> <p>Unplug the power supply when doing maintenance on equipment in which the card is embedded. Failure to do so may lead to accidents involving electrical shock.</p> <p>Do not place the card in locations where excessive force might be applied to it. Doing so may cause the printed circuit board to warp, leading to breakage of the printed circuit board, missing parts or malfunctioning parts.</p>

 <p>Caution (Continued from previous page)</p>	<p>When using the card together with expansion boards or other peripheral equipment, be sure to carefully read each of their manuals and to use them correctly.</p> <p>Developer does not guarantee the operation of specific expansion boards or peripheral devices when used in conjunction with this card unless they are specifically mentioned in this Manual or their successful operation with this card has been confirmed in separate documents.</p>
	<p>Turn off the power switch when moving or connecting the card.</p> <p>Failure to do so may cause this card to fail or lead to accidents involving electrical shock.</p>
	<p>Do not clean this card by using a rag containing chemicals such as benzine or thinner.</p> <p>Doing so could degrade the card. When using a chemically treated cloth, comply with its directions and warnings.</p>
	<p>Do not immediately turn on the power if you find that moisture has condensed onto this card after removing it from the box.</p> <p>Condensation may form if the card is cold when moved from the box into a warm room.</p> <p>Turning on the power while there is moisture on the card may cause it to malfunction or shorten the service life of the parts.</p> <p>Allow the card to reach room temperature when you first take it out of the box. If condensation or moisture has occurred on this card, first wait for the moisture to fully evaporate before installing or connecting the card to other equipment.</p>
	<p>Operation of the card cannot be guaranteed if it has been disassembled, dismantled, altered, modified, or rebuilt.</p>

3. Unpacking

During unpacking, check to make sure that all required items are included, and that nothing is damaged.

If something is missing or visibly damaged, contact your sales agent within 30 days after receiving your purchase.

3G-SDI FMC Card: 1	
37-mm spacer: 4	
10-mm spacer: 2	
Pan-head screw: 6	
Packing list/precautions(Japanese): 1	
Packing list/precautions(English): 1	
Circuit diagram	To download these files, go to the URL noted on the “Packing List and Precautions”.
Reference Manual	
Getting Started	
Reference Design	

4. Functions and Features of the Card

4.1 Main Features

This card is an FPGA Mezzanine Connector (FMC) daughter card that complies with FMC ALTERA LPC+ standard. It is the card to expand functionality of FPGA evaluation board so that you can evaluate the 3G-SDI, HD-SDI, and SD-SDI interfaces by inserting this card into any one of various types of FPGA evaluation boards and combining their functionalities.

The evaluation board which has been verified to connect with this card so far is the Altera Arria® 10 GX FPGA development kit.

Refer to the following links for more detailed information and related details.

- Information for the Arria® 10 device family
[Documentation: Arria® 10 Devices](#)
- Materials related to the Arria® 10 GX FPGA Development Kit
[Arria® 10 GX FPGA Development Kit](#)

4.2 Product Specifications

The product specifications for this card are shown below.

Product Specifications	3G-SDI FMC CARD
External Dimensions	69 mm x 160 mm
Printed circuit board	6-layer FR4
FMC	Samtec ASP-134488-01
Power Supply	3.3 V/VADJ (1.8 V)/12 V from FMC
Video sync separator	Texas Instruments LMH1981
Video clock generator	Texas Instruments LMH1983
Interface	Active BNC TX x 6 Active BNC RX x 6 Component input BNC x 1 Clock output SMA x 1 pair

4.3 Block Diagram

Figure 4-1 shows the block diagram of this card.

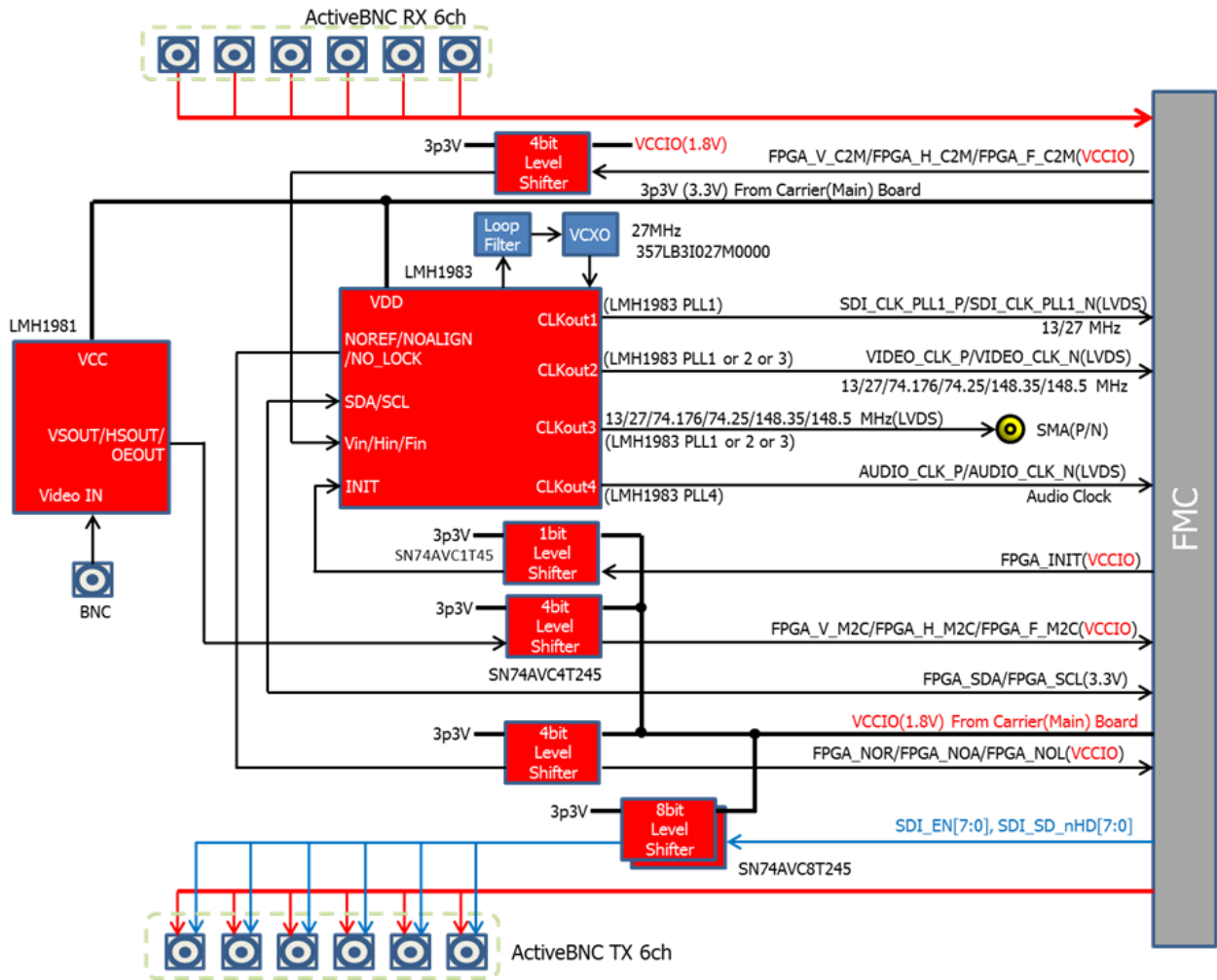

Figure 4-1 3G-SDI FMC Card Block Diagram

4.4 Card Layout

Figure 4-2 and Figure 4-3 show the layout of the card.

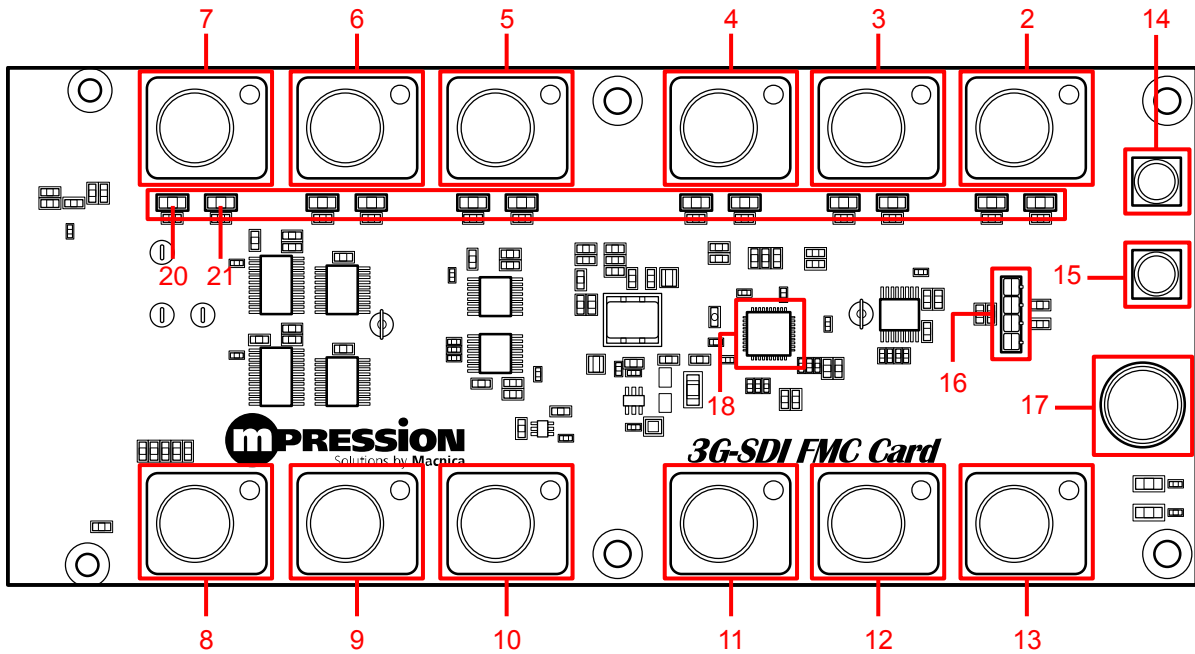

Figure 4-2 3G-SDI FMC Card Layout (Front)

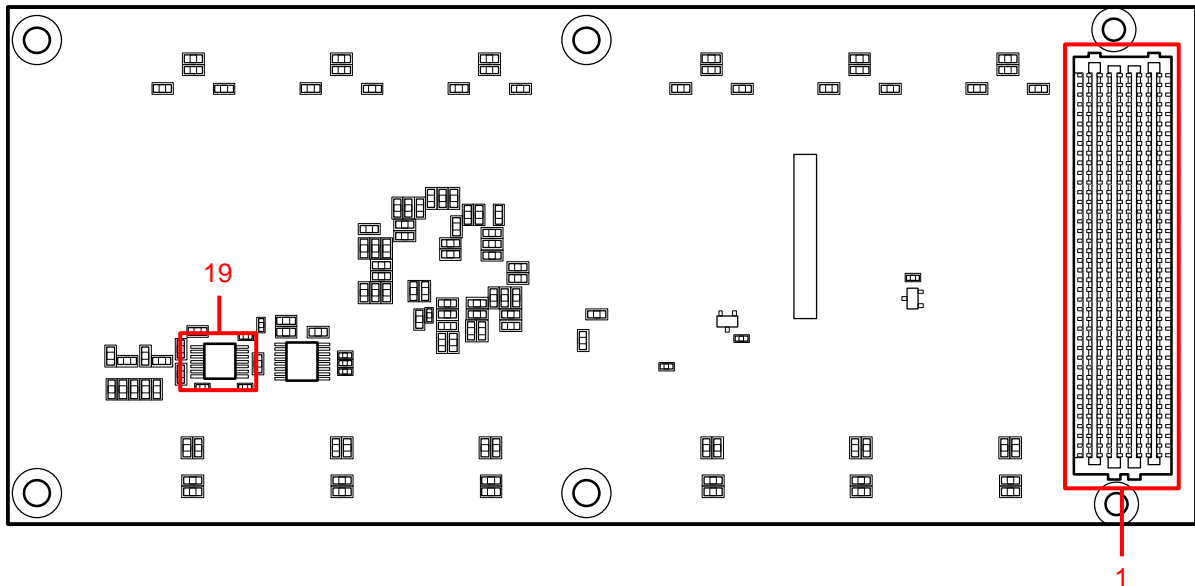

Figure 4-3 3G-SDI FMC Card Layout (Back)

	Reference	Functions	Details
1	CN1 (Back)	FMC	ALTERA FPGA Development Board Interface (FMC ALTERA LPC+)
2	CN2	SDI TX ch0	Active BNC BCA-TS
3	CN3	SDI TX ch1	Active BNC BCA-TS
4	CN4	SDI TX ch2	Active BNC BCA-TS
5	CN5	SDI TX ch3	Active BNC BCA-TS
6	CN6	SDI TX ch4	Active BNC BCA-TS
7	CN7	SDI TX ch5	Active BNC BCA-TS
8	CN8	SDI RX ch0	Active BNC BCA-RS
9	CN9	SDI RX ch1	Active BNC BCA-RS
10	CN10	SDI RX ch2	Active BNC BCA-RS
11	CN11	SDI RX ch3	Active BNC BCA-RS
12	CN12	SDI RX ch4	Active BNC BCA-RS
13	CN13	SDI RX ch5	Active BNC BCA-RS
14	CN14	SMA (P)	LMH1983 CLKout3+
15	CN15	SMA (N)	LMH1983 CLKout3-
16	CN16	Connectors for I2C	I2C connectors for LMH1983 settings
17	CN17	BNC	LMH1981 VIN input BNC (component signal)
18	U8	Video clock generator	3G/HD/SD video clock generator with audio clock
19	U12	Video sync separator	Multi-format video sync separator
20	D3-D8	LED TX SD/HD settings display	LED lit: 3G/HD, LED not lit: SD
21	D9-D14	LED TX enabled display	LED lit: TX Active BNC is enabled

5. Components on the Card

5.1 Connector Pin Assignments

CN1 (FMC) 1/2

FMC Pin#	Signal Name	Function	Arria® 10 GX FPGA Development Kit FPGA Pin#	
			FMCA	FMCB
B20	VIDEO_CLK_P	LMH1983 CLKout2+	AJ8	U8
B21	VIDEO_CLK_N	LMH1983 CLKout2-	AJ7	U7
C10	FPGA_H_M2C	LMH1981 HSOUT	BB17	C10
C14	FPGA_V_M2C	LMH1981 VSOUT	AR15	A18
C18	FPGA_F_M2C	LMH1981 OEOUT	AW18	B16
C30	FPGA_SCL	I2C SCL (For LMH1983)	AU10	J17
C31	FPGA_SDA	I2C SDA (For LMH1983)	AV10	J16
D11	FPGA_INIT	LMH1983 INIT	AV11	J19
D20	FPGA_H_C2M	LMH1983 Hin	AV19	F13
D23	FPGA_V_C2M	LMH1983 Vin	AU18	H13
D26	FPGA_F_C2M	LMH1983 Fin	AT19	M15
D30	JTAG_TDI	JTAG TDI(Connected to TDO)	-	-
D31	JTAG_TDO	JTAG TDO(Connected to TDI)	-	-
G2	SDI_CLK_PLL1_P	LMH1983 CLKout1+	BA12	F17
G3	SDI_CLK_PLL1_N	LMH1983 CLKout1-	BA13	G17
G9	Fout0	LMH1983 Fout0	AR20	D17
G12	Fout1	LMH1983 Fout1	AP18	A13
G15	Fout2	LMH1983 Fout2	AR16	D12
G18	Fout3	LMH1983 Fout3	AT13	E12
G21	NO_REF	LMH1983 NOREF	AU18	H20
G24	NO_ALIGN	LMH1983 NOALIGN	AW12	H19
G27	NO_LOCK	LMH1983 NO_LOCK	AY15	M12
H4	AUDIO_CLK_P	LMH1983 CLKout4+	AY20	J12
H5	AUDIO_CLK_N	LMH1983 CLKout4-	AY19	K12
H7	SDI_EN0	Active BNC TX ch0 Enable(H active)	AR22	A17
H8	SDI_EN1	Active BNC TX ch1 Enable(H active)	AT22	B17
H10	SDI_EN2	Active BNC TX ch2 Enable(H active)	AN20	K20
H11	SDI_EN3	Active BNC TX ch3 Enable(H active)	AP19	L15
H13	SDI_EN4	Active BNC TX ch4 Enable(H active)	AT17	D13
H14	SDI_EN5	Active BNC TX ch5 Enable(H active)	AU17	C13
H19	SDI_SD_nHD0	Active BNC TX ch0 SD/HD(3G) select signal H: SD / L: HD,3G	AR9	G10
H20	SDI_SD_nHD1	Active BNC TX ch1 SD/HD(3G) select signal H: SD / L: HD,3G	AT9	F10
H22	SDI_SD_nHD2	Active BNC TX ch2 SD/HD(3G) select signal H: SD / L: HD,3G	AU11	H11
H23	SDI_SD_nHD3	Active BNC TX ch3 SD/HD(3G) select signal H: SD / L: HD,3G	AU12	H10
H25	SDI_SD_nHD4	Active BNC TX ch4 SD/HD(3G) select signal H: SD / L: HD,3G	AY10	K16
H26	SDI_SD_nHD5	Active BNC TX ch5 SD/HD(3G) select signal H: SD / L: HD,3G	AY11	K17
K4	SDI_RX0_P	FMCA_DP_M2C_P10(ALTERA LPC+)	AJ3	L3
K5	SDI_RX0_N	FMCA_DP_M2C_N10(ALTERA LPC+)	AJ4	L4
K7	SDI_RX1_P	FMCA_DP_M2C_P11(ALTERA LPC+)	AH5	K5
K8	SDI_RX1_N	FMCA_DP_M2C_N11(ALTERA LPC+)	AH6	K6
K10	SDI_RX2_P	FMCA_DP_M2C_P12(ALTERA LPC+)	AG3	H5
K11	SDI_RX2_N	FMCA_DP_M2C_N12(ALTERA LPC+)	AG4	H6
K13	SDI_RX3_P	FMCA_DP_M2C_P13(ALTERA LPC+)	AF5	G7
K14	SDI_RX3_N	FMCA_DP_M2C_N13(ALTERA LPC+)	AF6	G8
K16	SDI_RX4_P	FMCA_DP_M2C_P14(ALTERA LPC+)	AE3	F5
K17	SDI_RX4_N	FMCA_DP_M2C_N14(ALTERA LPC+)	AE4	F6
K19	SDI_RX5_P	FMCA_DP_M2C_P15(ALTERA LPC+)	AD5	E7
K20	SDI_RX5_N	FMCA_DP_M2C_N15(ALTERA LPC+)	AD6	E8
K22	SDI_TX0_P	FMCA_DP_C2M_P10(ALTERA LPC+)	AT1	F1

CN1 (FMC) 2/2

FMC Pin#	Signal Name	Function	Arria® 10 GX FPGA Development Kit FPGA Pin#	
			FMCA	FMCB
K23	SDI_TX0_N	FMCA_DP_C2M_N10(ALTERA LPC+)	AT2	F2
K25	SDI_TX1_P	FMCA_DP_C2M_P11(ALTERA LPC+)	AR3	E3
K26	SDI_TX1_N	FMCA_DP_C2M_N11(ALTERA LPC+)	AR	E4
K28	SDI_TX2_P	FMCA_DP_C2M_P12(ALTERA LPC+)	AP1	D1
K29	SDI_TX2_N	FMCA_DP_C2M_N12(ALTERA LPC+)	AP2	D2
K31	SDI_TX3_P	FMCA_DP_C2M_P13(ALTERA LPC+)	AM1	C3
K32	SDI_TX3_N	FMCA_DP_C2M_N13(ALTERA LPC+)	AM2	C4
K34	SDI_TX4_P	FMCA_DP_C2M_P14(ALTERA LPC+)	AK1	B1
K35	SDI_TX4_N	FMCA_DP_C2M_N14(ALTERA LPC+)	AK2	B2
K37	SDI_TX5_P	FMCA_DP_C2M_P15(ALTERA LPC+)	AH1	A3
K38	SDI_TX5_N	FMCA_DP_C2M_N15(ALTERA LPC+)	AH2	A4

CN1 FMC pin assignment

	K	J	H	G	F	E	D	C	B	A
1	NC	GND	NC	GND	NC	GND	NC	GND	NC	GND
2	GND	NC	GND	SDI_CLK_PLL1_P	GND	NC	GND	NC	GND	NC
3	GND	NC	GND	SDI_CLK_PLL1_N	GND	NC	GND	NC	GND	NC
4	SDI_RX0_P	GND	AUDIO_CLK_P	GND	NC	GND	NC	GND	NC	GND
5	SDI_RX0_N	GND	AUDIO_CLK_N	GND	NC	GND	NC	GND	NC	GND
6	GND	NC	GND	NC	GND	NC	GND	NC	GND	NC
7	SDI_RX1_P	NC	SDI_EN0	NC	NC	NC	GND	NC	GND	NC
8	SDI_RX1_N	GND	SDI_EN1	GND	NC	GND	NC	GND	NC	GND
9	GND	NC	GND	Fout0	GND	NC	NC	GND	NC	GND
10	SDI_RX2_P	NC	SDI_EN2	NC	NC	NC	GND	FPGA_H_M2C	GND	NC
11	SDI_RX2_N	GND	SDI_EN3	GND	NC	GND	FPGA_INIT	NC	GND	NC
12	GND	NC	GND	Fout1	GND	NC	NC	GND	NC	GND
13	SDI_RX3_P	NC	SDI_EN4	NC	NC	NC	GND	GND	NC	GND
14	SDI_RX3_N	GND	SDI_EN5	GND	NC	GND	NC	FPGA_V_M2C	GND	NC
15	GND	NC	GND	Fout2	GND	NC	NC	NC	GND	NC
16	SDI_RX4_P	NC	NC	NC	NC	NC	GND	GND	NC	GND
17	SDI_RX4_N	GND	NC	GND	NC	GND	NC	GND	NC	GND
18	GND	NC	GND	Fout3	GND	NC	NC	FPGA_F_M2C	GND	NC
19	SDI_RX5_P	NC	SDI_SD_nHD0	NC	NC	NC	GND	NC	GND	NC
20	SDI_RX5_N	GND	SDI_SD_nHD1	GND	NC	GND	FPGA_H_C2M	GND	VIDEO_CLK_P	GND
21	GND	NC	GND	NO_REF	GND	NC	NC	GND	VIDEO_CLK_N	GND
22	SDI_TX0_P	NC	SDI_SD_nHD2	NC	NC	NC	GND	NC	GND	NC
23	SDI_TX0_N	GND	SDI_SD_nHD3	GND	NC	GND	FPGA_V_C2M	NC	GND	NC
24	GND	NC	GND	NO_ALIGN	GND	NC	NC	GND	NC	GND
25	SDI_TX1_P	NC	SDI_SD_nHD4	NC	NC	NC	GND	GND	NC	GND
26	SDI_TX1_N	GND	SDI_SD_nHD5	GND	NC	GND	FPGA_F_C2M	NC	GND	NC
27	GND	NC	GND	NO_LOCK	GND	NC	NC	NC	GND	NC
28	SDI_TX2_P	NC	NC	NC	NC	NC	GND	GND	NC	GND
29	SDI_TX2_N	GND	NC	GND	NC	GND	NC	GND	NC	GND
30	GND	NC	GND	NC	GND	NC	JTAG_TDI	FPGA_SCL	GND	NC
31	SDI_TX3_P	NC	NC	NC	NC	NC	JTAG_TDO	FPGA_SDA	GND	NC
32	SDI_TX3_N	GND	NC	GND	NC	GND	3P3V	GND	NC	GND
33	GND	NC	GND	NC	GND	NC	NC	GND	NC	GND
34	SDI_TX4_P	NC	NC	NC	NC	NC	NC	NC	GND	NC
35	SDI_TX4_N	GND	NC	GND	NC	GND	NC	12P0V	GND	NC
36	GND	NC	GND	LV_SHFT_OE	GND	NC	3P3V	GND	NC	GND
37	SDI_TX5_P	NC	NC	NC	NC	NC	GND	12P0V	NC	GND
38	SDI_TX5_N	GND	NC	GND	NC	GND	3P3V	GND	GND	NC
39	GND	NC	GND	VCCIO	GND	VCCIO	GND	3P3V	GND	NC
40	NC	GND	VCCIO	GND	VCCIO	GND	3P3V	GND	NC	GND

CN16 (I2C)

Pin#	Signal Name
1	VCC
2	SDA
3	SCL
4	GND

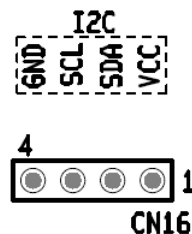

5.2 Video Sync Separator

The video sync separator separates and outputs a horizontal sync signal and a vertical sync signal, as well as an odd/ even field signal from the component signal input from CN17 (BNC connector). These signals can be input to the FPGA through the FMC.

For details of the functions, check the product data sheet in “6.2 Using the Mounted IC”.

5.3 Video Clock Generator

The video clock generator generates the clocks for audio and video functions from four PLLs. The factory default frequencies of the clock output are shown below.

Clock output	Frequency	Output terminal
CLKout1	27 MHz	FMC CN1 G2(p) / G3(n)
CLKout2	148.5 MHz	FMC CN1 B20(p) / B21(n)
CLKout3	148.35 MHz	SMA CN14(p) / CN15(n)
CLKout4	24.576 MHz	FMC CN1 H4(p) / H5(n)

The output frequency range of each PLL is shown in the following table. For details of the functions and the combinations of each CLKout 1 to 4, check the product data sheet in “6.2 Using the Mounted IC”.

PLL	Output frequency
PLL1	27.0 MHz or 13.5 MHz
PLL2	148.5 MHz or 74.25 MHz
PLL3	148.35 MHz or 74.1765 MHz
PLL4	98.304 MHz/2 ^X (X = 0 to 15)

The settings of video clock generator can be changed via I2C from FMC or CN16.

6. Handling Precautions

6.1 Insertion into / Removal from FMC

Always turn off the power to the evaluation board when inserting the card into or removing it from the FMC connector on the evaluation board.

Note that inserting or removing the card while the power is on may result in damage to or destruction of the device.

You need to arrange sufficient anti-static prevention measures because the act of contacting the card with a person or any object carrying a static charge may also result in damage to or destruction of the device.

6.2 Using the Mounted IC

Refer to the following data sheet to use the IC that is mounted on the card. It should not be used in nonstandard ways.

IC	Model	Link
Video sync separator	LMH1981MTX/NOPB	http://www.ti.com/product/LMH1981
Video clock generator	LMH1983SQE/NOPB	http://www.ti.com/product/LMH1983

6.3 Mode Selection of Unused Pins

We recommend that pins of FPGA that are not used (unused pins) in the design or hardware to be set in tri-state mode to prevent malfunction. The following shows how to set the unused pins using Quartus Prime development software.

- 1) Select the [Assignments] menu > [Device].

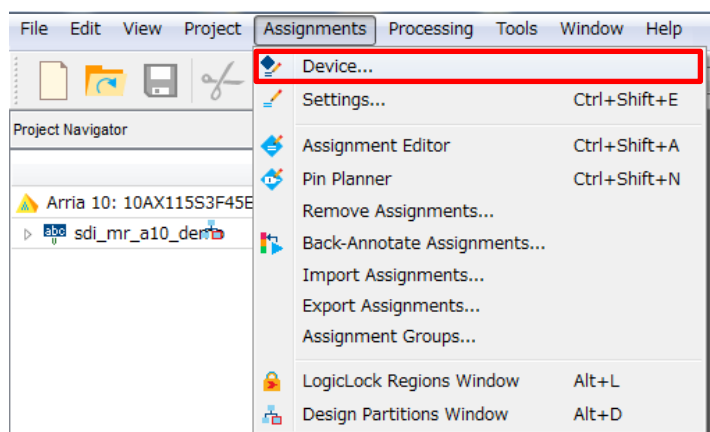

- 2) Click the [Device and Pin Options] button.

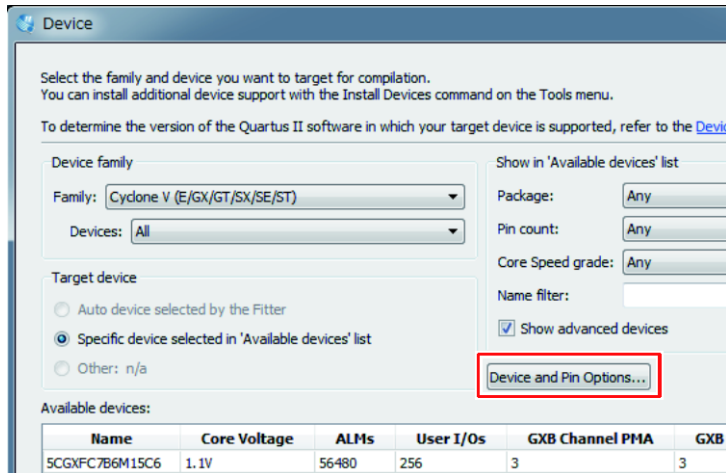

The [Device and Pin Options] window opens.

- 3) Select [Unused Pins].

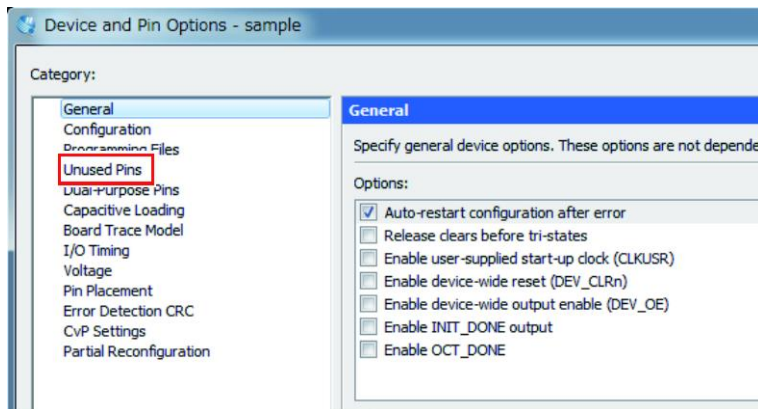

- 4) For the [Reserve all unused pins] item, select [As input tri-stated].

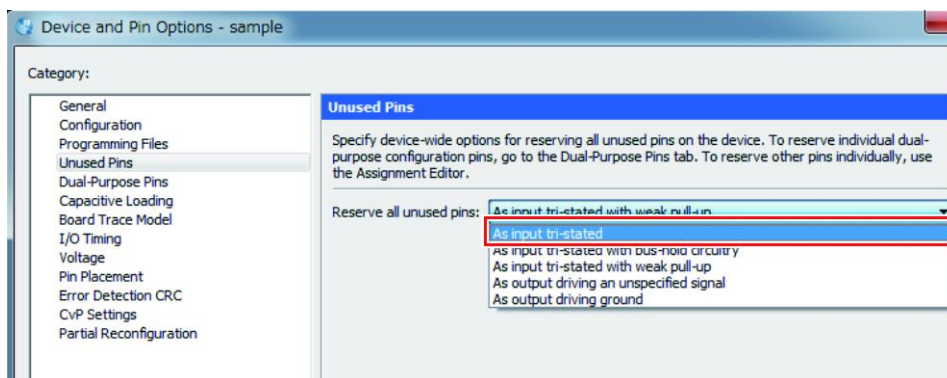

- 5) Click the [OK] button.
- 6) Click the [OK] button to close the [Device] window.

7. Document Revision History

Date	Revision	Changes
January 27, 2017	A	<ul style="list-style-type: none">• First Edition
October 23, 2017	B	<ul style="list-style-type: none">• Change URL

X-ON Electronics

Largest Supplier of Electrical and Electronic Components

Click to view similar products for [Programmable Logic IC Development Tools](#) category:

Click to view products by [Mpression](#) manufacturer:

Other Similar products are found below :

[DK-DEV-5SGXEA7N](#) [SLG4DVKADV](#) [88980182](#) [DEV-17526](#) [DEV-17514](#) [LCMXO3L-SMA-EVN](#) [471-014](#) [80-001005](#) [iCE40UP5K-MDP-EVN](#) [ALTHYDRAC5GX](#) [ALTNITROC5GX](#) [471-015](#) [Hinj](#) [SnoMakrR10](#) [DK-DEV-1SDX-P-A](#) [DK-DEV-1SDX-P-0ES](#) [DK-DEV-1SMC-H-A](#) [DK-DEV-1SMX-H-0ES](#) [DK-DEV-1SMX-H-A](#) [DK-DEV-4CGX150N](#) [DK-DEV-5CGTD9N](#) [DK-DEV-5CSXC6N](#) [DK-DEV-5M570ZN](#) [DK-MAXII-1270N](#) [DK-SI-1SGX-H-A](#) [DK-SI-1STX-E-0ES](#) [DK-SI-1STX-E-A](#) [DK-SI-5SGXEA7N](#) [ATF15XX-DK3-U](#) [SLG46824V-DIP](#) [SLG46826V-DIP](#) [240-114-1](#) [6003-410-017](#) [ICE40UP5K-B-EVN](#) [DK-SOC-1SSX-L-D](#) [ICE5LP4K-WDEV-EVN](#) [L-ASC-BRIDGE-EVN](#) [LC4256ZE-B-EVN](#) [LCMXO2-7000HE-B-EVN](#) [LCMXO3D-9400HC-B-EVN](#) [LCMXO3L-6900C-S-EVN](#) [LF-81AGG-EVN](#) [LFE3-MEZZ-EVN](#) [LIF-MD6000-ML-EVN](#) [LPTM-ASC-B-EVN](#) [M2S-HELLO-FPGA-KIT](#) [VIDEO-DC-USXGMII](#) [12GSDIFMCCD](#) [SFP+X4FMCCD](#) [NAE-CW305-04-7A100-0.10-X](#)