



Reference Manual

LT8315, 24V Output Isolated AC/DC Board

Revision 1.0

2020/03/19

© 2020 Macnica, Inc.

Disclaimer

The information in this document (hereinafter called “Information”) is subject to change without notice.

Macnica Inc. (Developer) makes no warranty of any kind regarding this document, or of any liability arising out of the application or use of information in this document, and assumes no responsibility for any errors that may appear in this document.

This document is distributed without any charge and reselling or copying without written authorization by Developer is restricted.

IN NO EVENT WILL DEVELOPER BE LIABLE FOR ANY CONSEQUENTIAL, INDIRECT, EXEMPLARY, SPECIAL, OR INCIDENTAL DAMAGES, INCLUDING ANY LOST DATA AND LOST PROFITS, ARISING FROM OR RELATING TO YOUR USE OF THE INFORMATION, EVEN IF YOU HAVE BEEN ADVISED OF THE POSSIBILITY OF SUCH DAMAGES. THE TOTAL CUMULATIVE LIABILITY OF DEVELOPER IN CONNECTION WITH YOUR USE OF THE INFORMATION IN THIS DOCUMENT, WHETHER IN CONTRACT OR TORT OR OTHERWISE, WILL IN NO EVENT EXCEED THE AMOUNT OF FEES PAID BY YOU TO DEVELOPER HEREUNDER FOR USE OF THE INFORMATION. YOU ACKNOWLEDGE THAT THE FEES, IF ANY, REFLECT THE ALLOCATION OF RISK SET FORTH IN THIS AGREEMENT AND THAT DEVELOPER WOULD NOT MAKE AVAILABLE THE INFORMATION TO YOU WITHOUT THESE LIMITATIONS OF LIABILITY.

The Information is not intended for use in the development of on-line control equipment in hazardous environments requiring failsafe controls, such as in the operation of nuclear facilities, aircraft navigation or communications systems, air traffic control, life support, or weapons systems (“High-Risk Applications”). Developer specifically disclaims any express or implied warranties of fitness for such High-Risk Applications. You represent that use of the Information in such High-Risk Applications is fully at your risk.

Contents

1. Read This First	4
1.1. Important Information	4
1.2. Developer Information	5
1.3. Inquires	5
2. For Ensuring Safe Use	6
2.1. Legend	6
2.2. Cautions	6
3. Unboxing	8
4. Functions and Features of the Product	9
4.1. Features	9
4.2. Key Components	10
5. Board Diagram and Board Photo	11
6. Circuit Diagram of Board	12
7. Measuring Circuit	13
8. Measured Items	14
8.1. Electric Characteristics	14
8.2. Performance Evaluation	15
8.2.1. Efficiency	15
8.2.2. Regulation Curves	16
8.2.3. Load Transient Response	17
8.2.4. Switch Node Voltage Waveform	18
9. Document Revision History	19

1. Read This First

1.1. Important Information

READ FIRST:

- **READ** this Reference Manual before using this product.
- **Keep** this Reference Manual so you can refer to it when needed.
- **Do not attempt** to use this product until you fully understand its mechanisms.

Purpose of the Product:

- This product is a reference board on which is mounted an isolated flyback converter IC LT8315 from Analog Devices.
Be sure to use this product correctly for this purpose.

For Users of This Product:

- This product should be used only by individuals who have carefully read and understand these materials. Use of this product requires a basic knowledge of electronic circuits and power supply circuits.

Precautions to be taken when using This Product:

- This product is a device to support development that is intended to be used for the development of power supplies and their evaluation stages. **You cannot install the board in your product** and cannot use the board for mass-production of your power supply. When mass-producing a power supply you have finished developing, be sure to decide at your own responsibility whether it can be put to practical use by performing integration test, evaluation, or some other experiment.
- In no event shall Macnica Inc. be liable for any consequence arising from the use of this product.
- Macnica Inc. shall make effort to provide a workaround or fix for failures of this product, with or without charge. This does not mean, however, that Macnica Inc. guarantees to provide a workaround or fix under all circumstances.
- Macnica Inc. cannot anticipate every possible circumstance that might involve a potential hazard. The warnings in this reference manual and on the product are therefore not all-inclusive. Use this product correctly and safely at your own responsibility.
- Even if a device installed on this product has a failure, it cannot be replaced.
- Remodeling or damages caused by the customer is not guaranteed.
- This product is a lead-free mounting product.
- Generally, the brand names carried in this manual each constitute a maker's trademark or registered trademark.

Improvement Policy:

- Macnica Inc. pursues a policy of continuous improvement in design, performance, and safety of the product. Macnica Inc. reserves the right to change, wholly or partially, specifications, design, reference manual, and other documentation at any time without notice.

Warranty:

- Macnica Inc. offers exchange of this product free of charge only in a set range of cases of initial trouble for this product, and within 30 days from when the customer received delivery of the Board. Macnica Inc. cannot exchange products in cases where breakdown is caused for the following reasons:
 - (1) Misuse, abuse of the product or use under abnormal conditions
 - (2) Remodeling or repair
 - (3) A fire, earthquake, fall or other accidents

Figures:

- Some figures in this reference manual may differ from your system as purchased.

1.2. Developer Information

The Developer of this product is:

Macnica, Inc. Altima Company

Attend on Tower 2F, 2-8-12 Shin-Yokohama, Kouhoku-ku, Yokohama, 222-0033 JAPAN

<https://www.macnica.co.jp/en/company/>

1.3. Inquires

In case you have any inquiries about the use this product, please contact your local Macnica company or make inquiries through the contact form in the following web site:

<http://www.m-pression.com/contact>



Macnica companies:

- | | | |
|------------------|------------------------------|---|
| ● China & HK: | Macnica Cytech Ltd. | https://www.cytech.com/ |
| ● ASEAN & India: | Macnica Cytech Pte Ltd. | https://www.cytechglobal.com/ |
| ● Taiwan: | Answer Technology Co., Ltd. | http://www.anstek.com.tw/index_e.aspx |
| ● North America: | Macnica Americas | https://www.macnica.com/americas/ |
| ● Brazil: | Macnica DHW | https://www.macnicadhw.com.br/ |
| ● Japan: | Macnica, Inc. Altima Company | https://www.macnica.co.jp/business/semiconductor/support/contact/ |

2. For Ensuring Safe Use



Be sure to follow the precautions given here, which are intended to prevent harm to the user and others, as well as material damage.

2.1. Legend

	Warning	Indicates a potentially hazardous situation which if not avoided could result in death or serious injury.
	Caution	Indicates a potentially hazardous situation which if not avoided may result in minor or moderate injury or in property damage.

- **Notes and important information** are used to inform users about exceptional conditions, cautions for operational procedures, and in explanations.

2.2. Cautions

	Warning	Do not apply strong impacts or blows to the kit. Doing so may cause the kit to emit heat, explode, or ignite, or the equipment in the kit to fail or malfunction. This may also cause fire.
		Do not put the main unit in cooking appliances, such as microwave ovens, or high-pressure containers. Doing so might cause the main unit to emit heat, explode, ignite, or emit smoke, or its parts to break or warp.
		Do not wrap the main unit that is in use with cloth or other materials that are likely to allow heat to build up inside the wrapping. This will cause heat to build up inside the wrapping which may cause the main unit to ignite or malfunction.
		When disposing of the main unit, do not dispose of it along with general household waste. Throwing the main unit into fire may cause it to explode. Dispose of the main unit following the laws, regulations, and ordinances governing waste disposal.
		Do not place any containers such as cups or vases filled with water or other liquid on this Board. If this Board is exposed to water or other liquids it may cause the Board to malfunction or lead to accidents involving electrical shock. If you spill water or other liquid on this Board, immediately stop using the Board, and turn off the power. If you have any requests for repairs or technical consultation, please contact the local Macnica company or Mpression inquiry URL.
		Keep this board and accessories out of reach of children. Failure to do so may lead to injuries.
	Caution	Do not place the kit on unstable places such as shaky stands or tilted locations. Doing so may cause injuries or cause this Board to malfunction if the Board should fall.
		Do not attempt to use or leave the kit in places subject to strong direct sunlight or other places subject to high temperatures such as in cars in hot weather. Doing so might cause the kit to emit heat, break, ignite, run out of control, warp, or malfunction. Also, some parts of the equipment might emit heat causing burn injuries.

 <p>Caution (Continued from previous page)</p>	<p>Do not place this board in locations where excessive force may be applied to it. Doing so may cause the PC board to warp, leading to breakage of the PC board, missing parts or malfunctioning parts.</p>
	<p>Do not clean this Board by using a rag containing chemicals such as benzine or thinner. Failure to do so will likely to cause this Board to deteriorate. When using a chemical cloth be sure to comply with any directions or warnings.</p>
	<p>Do not immediately turn on the power if you find that water or moisture had condensed onto the main unit after removing the board from the package. Condensation might occur on this Board when taking it out of the box, if the board is cool yet the room temperature is warm. Do not apply power to the Board while water or moisture has condensed on it because the moisture may cause the Board to break or may shorten the service life of the parts. When you first take this Board out of the box be sure to leave it at room temperature for a while before using it. If condensation or moisture has occurred on this Board, first wait for the moisture to fully evaporate before <u>installing or connecting the Board to other devices.</u></p>
	<p>Do not disassemble, dismantle, modify, alter, or recycle parts unless they are clearly described as customizable in this Manual. Although this board is a customizable product, overall product operation cannot be guaranteed if parts needed for basic operations, which are not specified in this Manual as customizable, are modified in any way. Please contact the local Macnica company or Mpression inquiry URL beforehand if you wish to customize or modify any parts that are not described in this Manual as customizable.</p>

3. Unboxing

When unpacking the product, make sure that everything is included and that nothing is damaged. If something is missing, or if you discover physical damage, contact your sales representative within 30 days after the product was delivered to you.

ALT8315ACDC24	1
Guide for Developers	1
Circuit diagram of the product and table of parts	Download these files from the website at the following URL, which is also noted in “Guide for Developers”. https://www.m-pression.com/solutions/boards/analog-power-evaluation/24v-output-isolated-acdc-board-lt8315
PCB layout, etc.	
Reference Manual	

4. Functions and Features of the Product

4.1. Features

This board is a reference board for 24-V output isolated AC/DC power supply.

An isolated flyback converter controller IC (ANALOG DEVICES model: LT8315EFE#PBF), a transformer (Würth Electronics model: 7508110419), inductor, diode, resistor, capacitor, and other parts are mounted on the board, which can be operated by applying input voltage.

4.2. Key Components

The board's product specifications are shown below.

Key components	ALT8315ACDC24
Input voltage	90 VAC rms to 265 VAC rms
Output voltage	DC24V
Output current	140 mA (when input voltage is 90 VAC rms, 200 VAC rms)
External Dimensions	W: 80 mm x H: 45 mm
Layer configuration	2 layers
Board thickness	1.6 mm
Material	FR-4
Major parts	Model (manufacturer)
Power supply controller IC	LT8315EFE#PBF (ANALOG DEVICES)
Transformer	7508110419 (Würth Electronics)
Inductor	744731331 (Würth Electronics)
Inductor	74438324100 (Würth Electronics)

5. Board Diagram and Board Photo

A diagram and photo of the board are shown below.

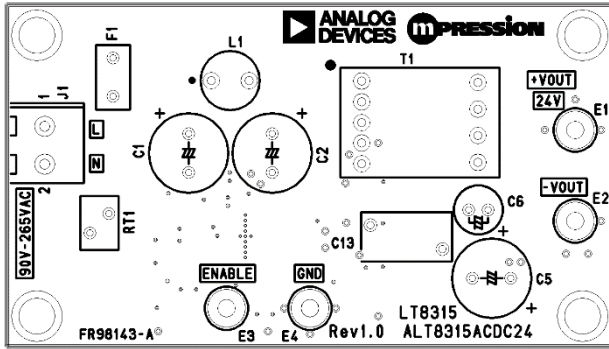

Figure 5-1 Diagram of Components on Board (Front)

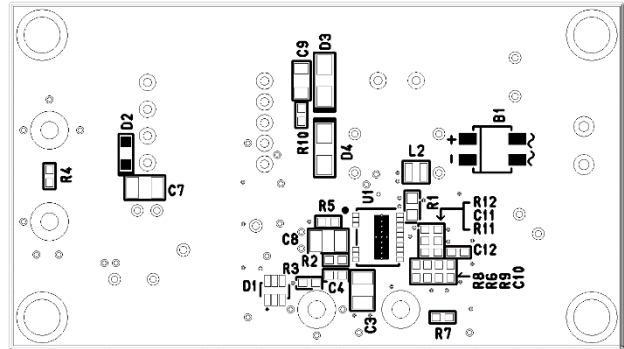

Figure 5-2 Diagram of Soldering on Board (Back)



Figure 5-3 Photo of Board (Front)

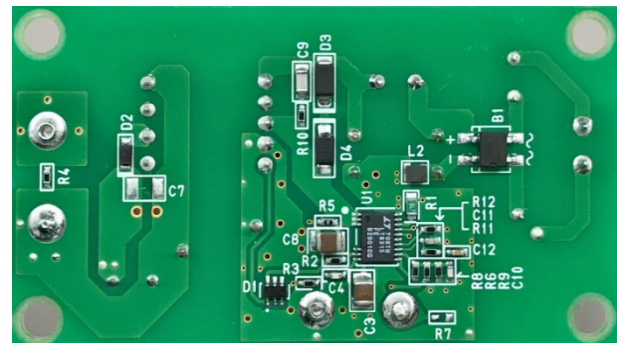

Figure 5-4 Photo of Board (Back)

6. Circuit Diagram of Board

A circuit diagram of the board is shown below.

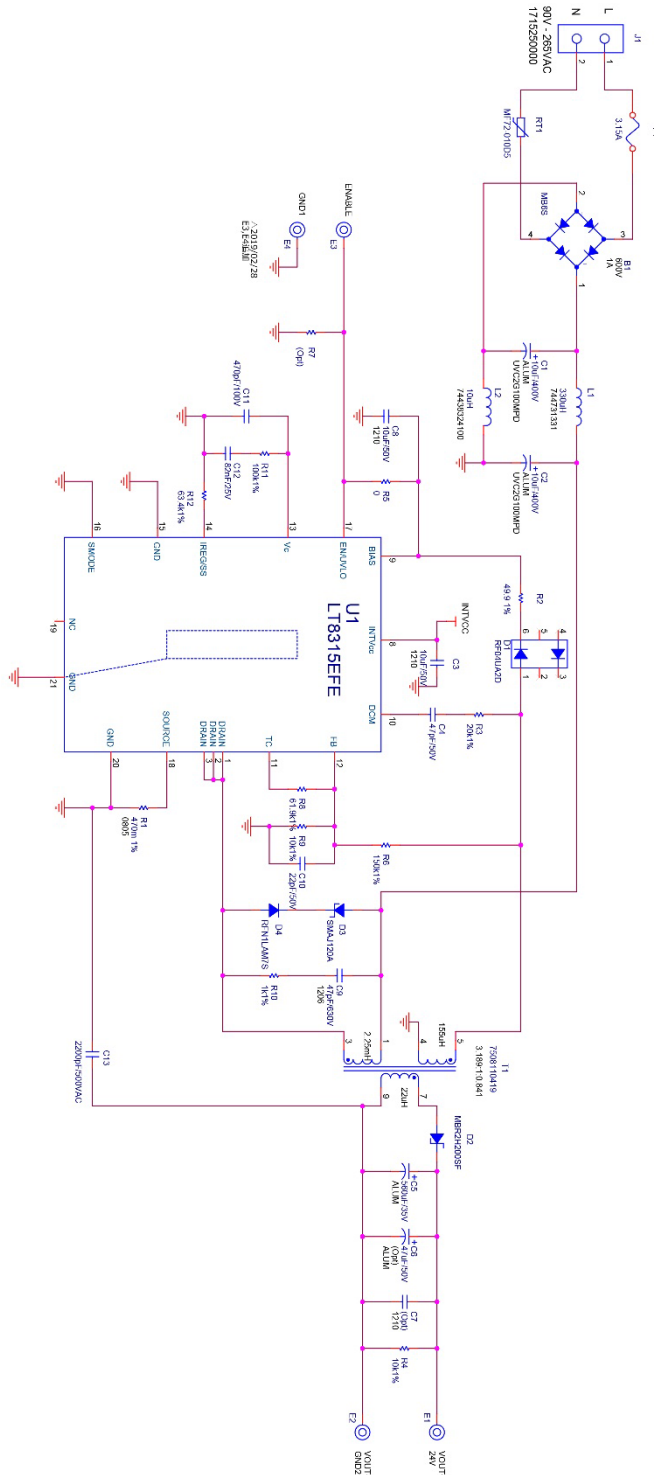

Figure 6-1 Circuit Diagram of ALT8315ACDC24 Rev 1.0 Board

7. Measuring Circuit

A measuring circuit is shown below.

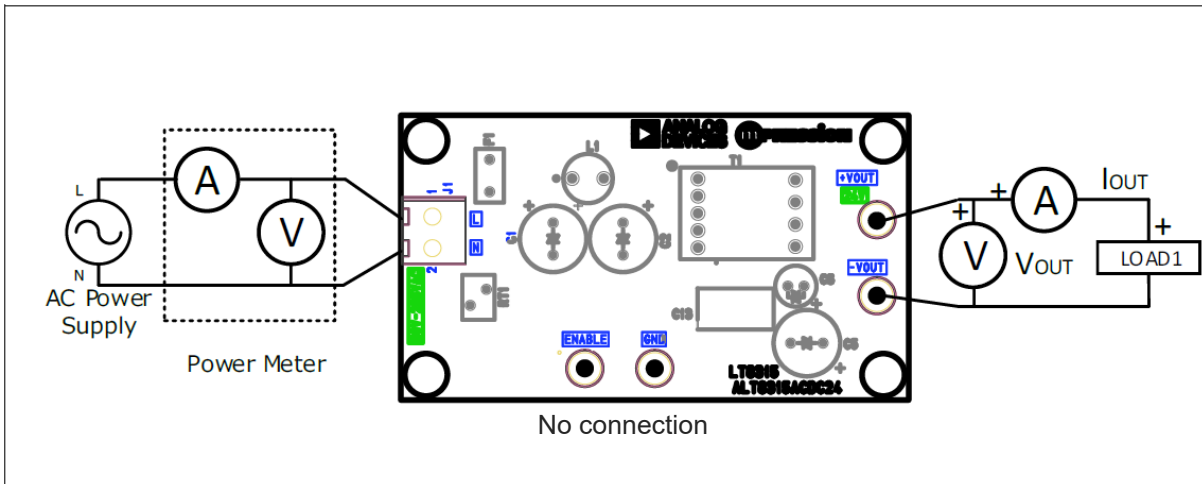

Figure 7-1 Measuring Circuit

8. Measured Items

The results of electric characteristics and performance evaluation are shown here.

8.1. Electric Characteristics

Table 8.1-1 Product Specifications Specifications are at TA = 25°C

PARAMETER	CONDITIONS	MIN	TYP	MAX	UNITS
Input Voltage Range		90		265	Vrms
VOUT			24		V
Maximum Load Current IOU _T	VIN = 90 Vrms	140			mA
	VIN = 200 Vrms	140			mA
Efficiency	VIN = 100 Vrms IOU _T = 140 mA		82.8		%
	VIN = 200 Vrms IOU _T = 140 mA		76.0		%

8.2. Performance Evaluation

8.2.1. Efficiency

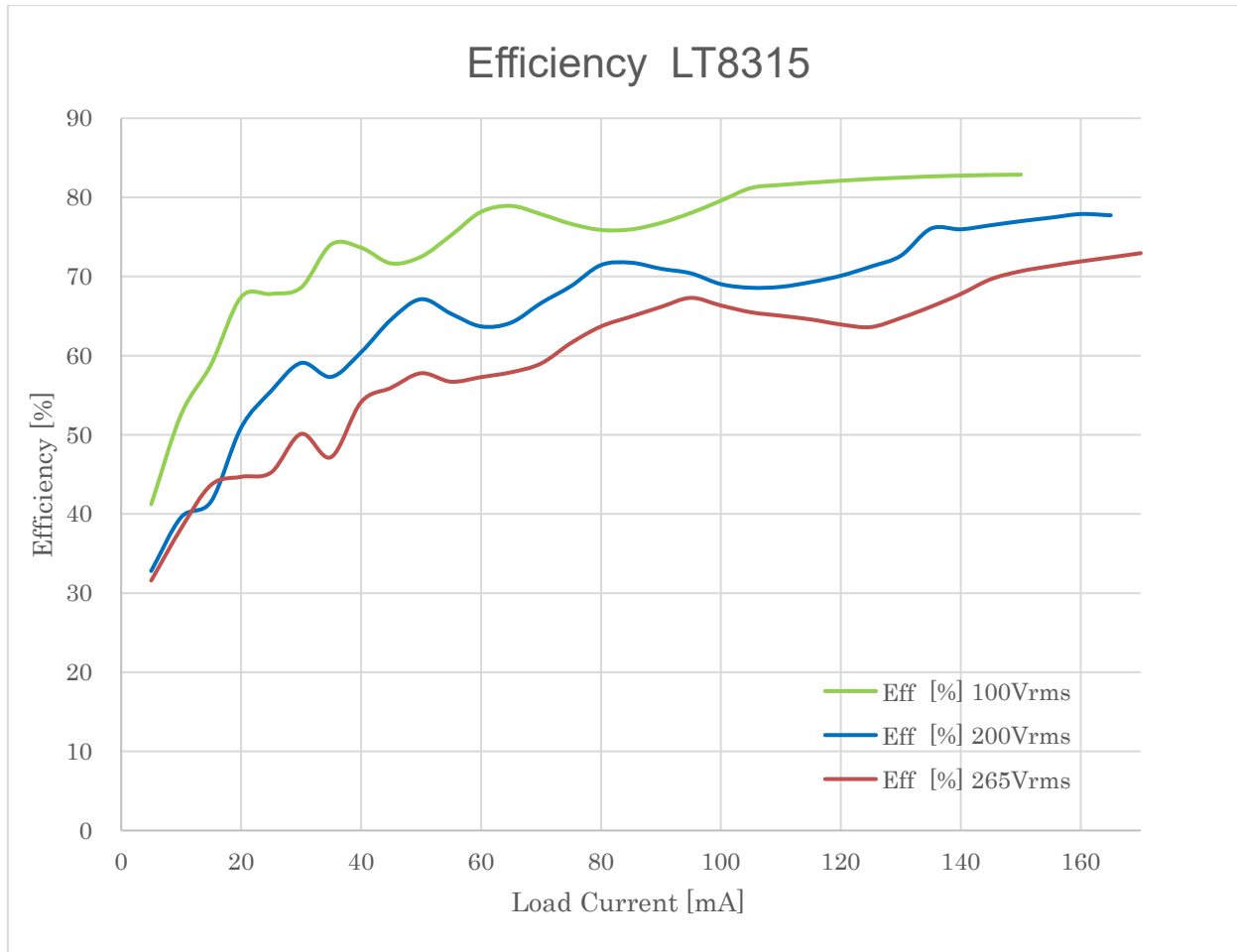

Figure 8.2.1-1 Efficiency

8.2.2.Regulation Curves

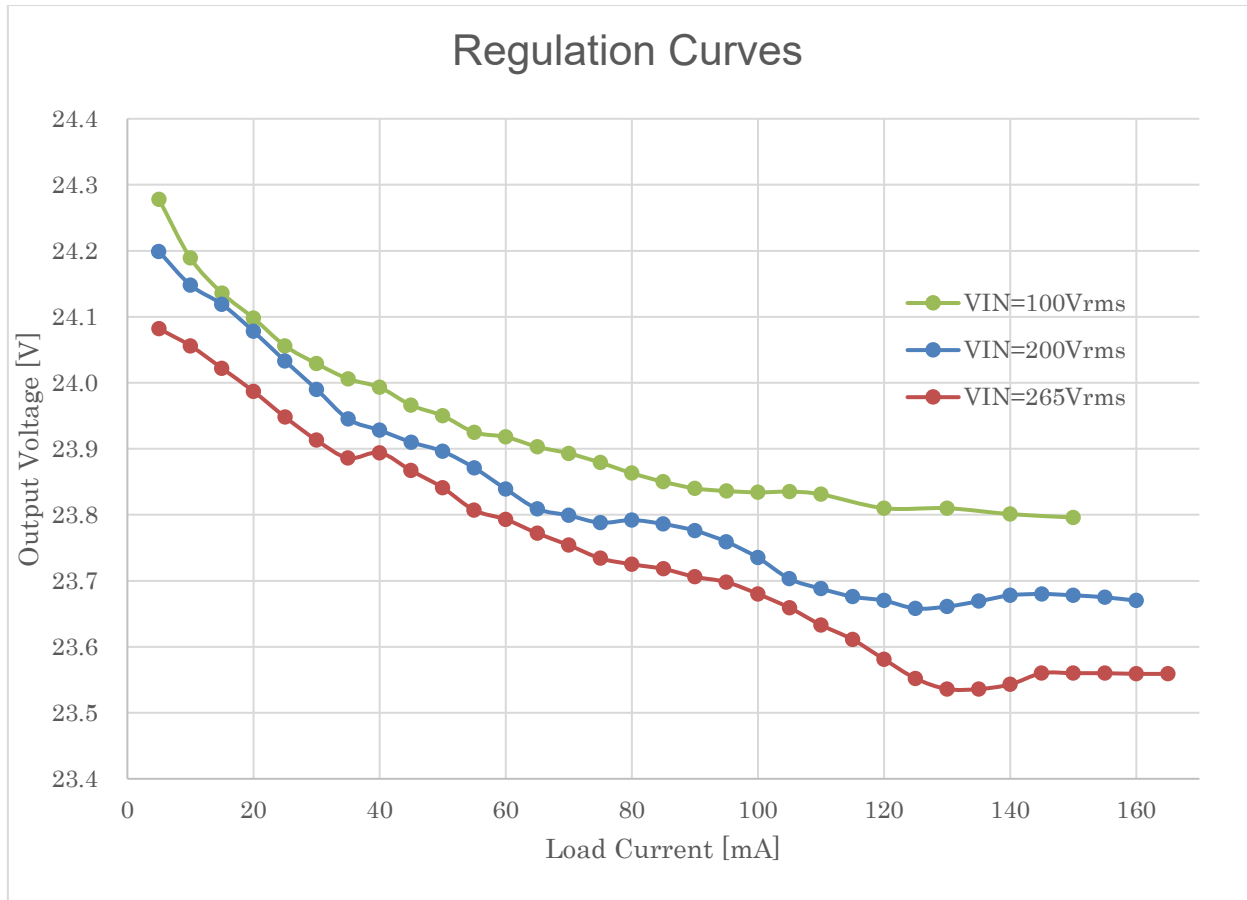

Figure 8.2.2-1 Regulation Curves

8.2.3. Load Transient Response

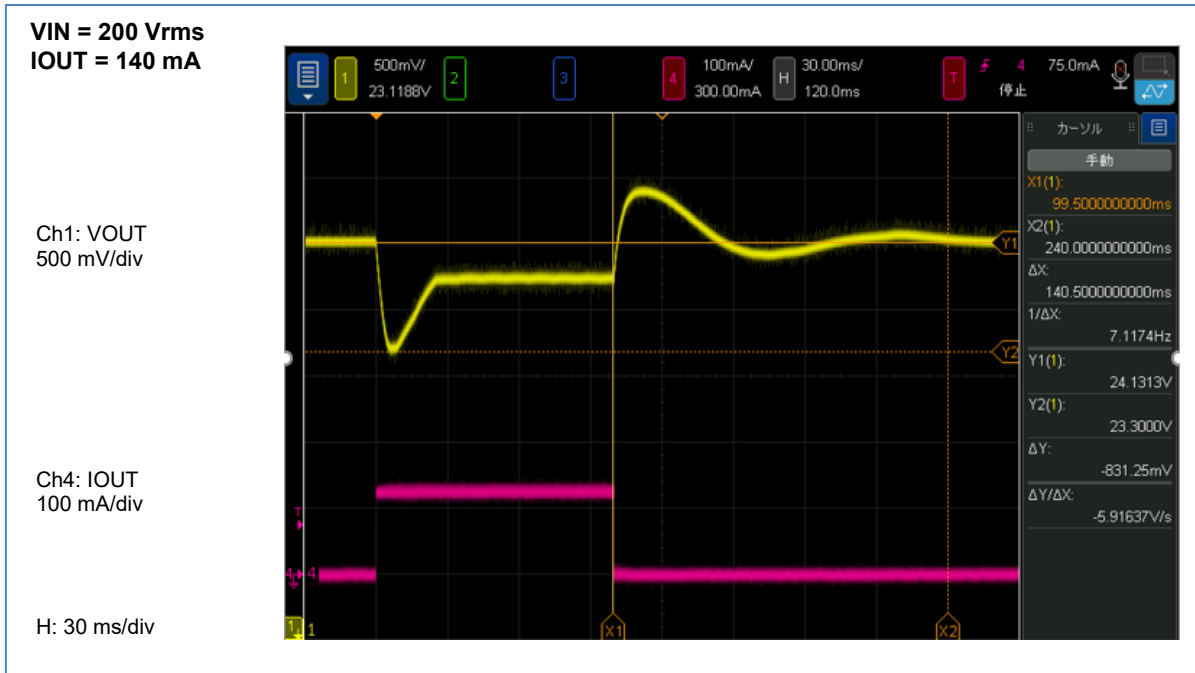

Figure 8.2.3-1 Load Transient Response

8.2.4. Switch Node Voltage Waveform

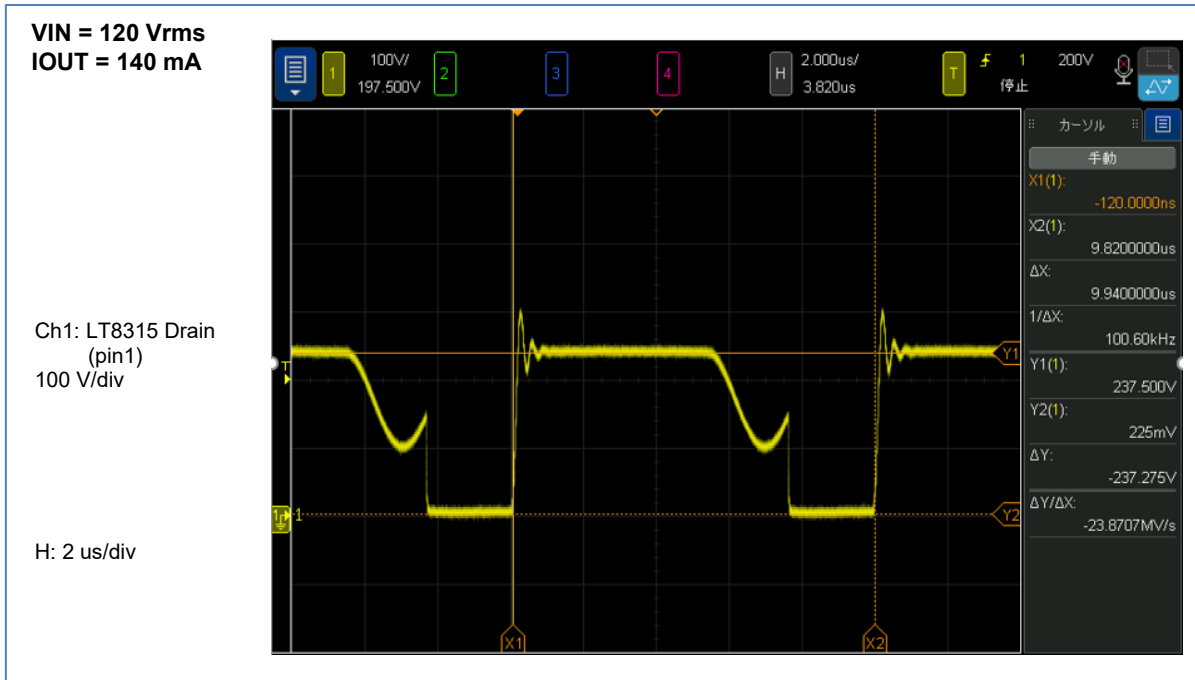

Figure 8.2.4-1 Switch Node VIN = 120 Vrms

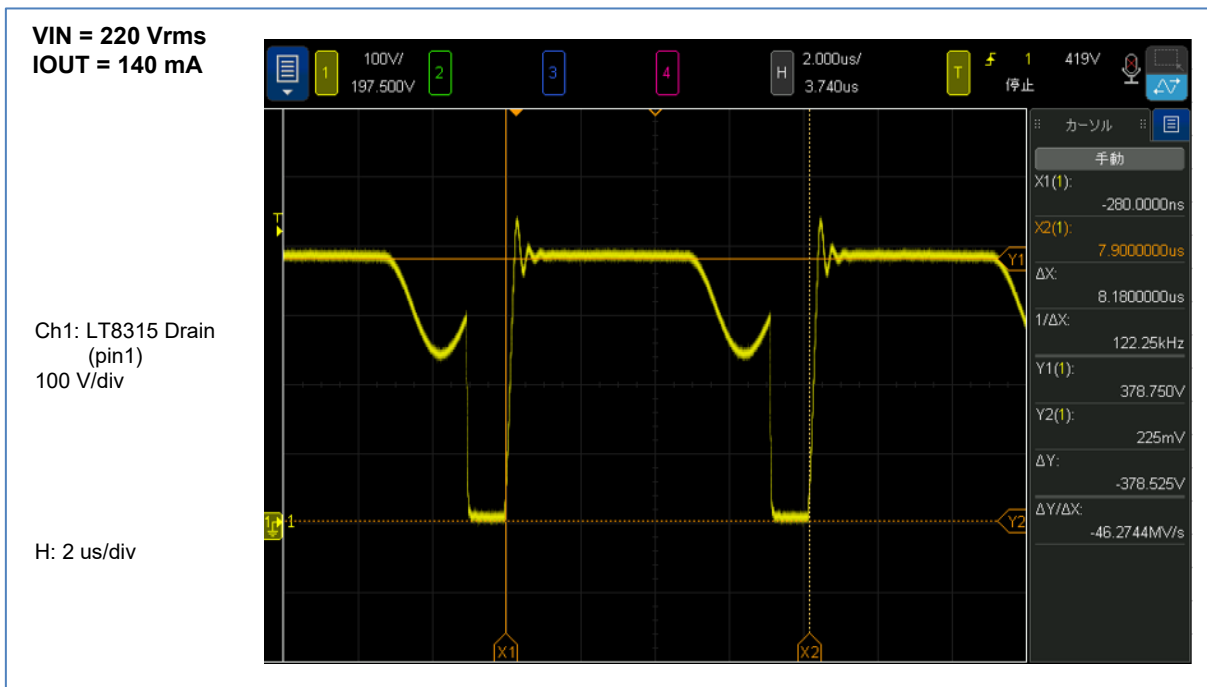

Figure 8.2.4-2 Switch Node VIN = 220 Vrms

9. Document Revision History

Date	Revision	Changes
March 19, 2020	1.0	First edition

X-ON Electronics

Largest Supplier of Electrical and Electronic Components

Click to view similar products for [Power Management IC Development Tools](#) category:

Click to view products by [Mpression](#) manufacturer:

Other Similar products are found below :

[EVAL-ADM1168LQEBZ](#) [EVB-EP5348UI](#) [MIC23451-AAAYFL EV](#) [MIC5281YMME EV](#) [DA9063-EVAL](#) [ADP122-3.3-EVALZ](#) [ADP130-0.8-EVALZ](#) [ADP130-1.2-EVALZ](#) [ADP130-1.5-EVALZ](#) [ADP130-1.8-EVALZ](#) [ADP1714-3.3-EVALZ](#) [ADP1716-2.5-EVALZ](#) [ADP1740-1.5-EVALZ](#) [ADP1752-1.5-EVALZ](#) [ADP1828LC-EVALZ](#) [ADP1870-0.3-EVALZ](#) [ADP1871-0.6-EVALZ](#) [ADP1873-0.6-EVALZ](#) [ADP1874-0.3-EVALZ](#) [ADP1882-1.0-EVALZ](#) [ADP199CB-EVALZ](#) [ADP2102-1.25-EVALZ](#) [ADP2102-1.875EVALZ](#) [ADP2102-1.8-EVALZ](#) [ADP2102-2-EVALZ](#) [ADP2102-3-EVALZ](#) [ADP2102-4-EVALZ](#) [ADP2106-1.8-EVALZ](#) [ADP2147CB-110EVALZ](#) [AS3606-DB](#) [BQ24010EVM](#) [BQ24075TEVM](#) [BQ24155EVM](#) [BQ24157EVM-697](#) [BQ24160EVM-742](#) [BQ24296MEVM-655](#) [BQ25010EVM](#) [BQ3055EVM](#) [NCV891330PD50GEVB](#) [ISLUSBI2CKIT1Z](#) [LM2744EVAL](#) [LM2854EVAL](#) [LM3658SD-AEV/NOPB](#) [LM3658SDEV/NOPB](#) [LM3691TL-1.8EV/NOPB](#) [LM4510SDEV/NOPB](#) [LM5033SD-EVAL](#) [LP38512TS-1.8EV](#) [EVAL-ADM1186-1MBZ](#) [EVAL-ADM1186-2MBZ](#)