

**N-Channel 30V (D-S) MOSFET**

**GENERAL DESCRIPTION**

The ME95N03T is the N-Channel logic enhancement mode power field effect transistors are produced using high cell density, DMOS trench technology. This high density process is especially tailored to minimize on-state resistance.

**FEATURES**

- $R_{DS(ON)} \leq 6m\Omega @ V_{GS}=10V$
- $R_{DS(ON)} \leq 9m\Omega @ V_{GS}=4.5V$
- Super high density cell design for extremely low  $R_{DS(ON)}$
- Exceptional on-resistance and maximum DC current capability

**APPLICATIONS**

- Power Management in Note book
- DC/DC Converter
- Load Switch
- LCD Display inverter

**PIN CONFIGURATION**

(TO-220)

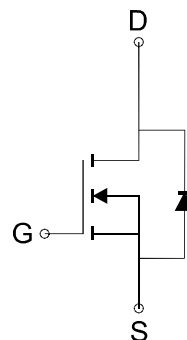
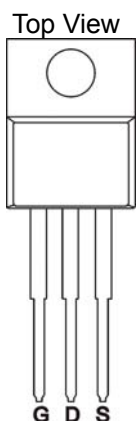

N-Channel MOSFET

Ordering Information: ME95N03T (Pb-free)

ME95N03T-G (Green product-Halogen free)

**Absolute Maximum Ratings (Tc=25°C Unless Otherwise Noted)**

Parameter	Symbol	Rating	Unit
Drain-Source Voltage	$V_{DSS}$	30	V
Gate-Source Voltage	$V_{GSS}$	$\pm 20$	V
Continuous Drain Current*	$I_D$	$T_c=25^\circ C$	88
		$T_c=70^\circ C$	74
Pulsed Drain Current	$I_{DM}$	352	A
Maximum Power Dissipation	$P_D$	$T_c=25^\circ C$	75
		$T_c=70^\circ C$	53
Operating Junction Temperature	$T_J$	-55 to 175	°C
Thermal Resistance-Junction to Case**	$R_{\theta JC}$	2	°C/W

\* Calculated continuous current based on maximum allowable junction temperature. Package limitation current is 80A.

\*\* The device mounted on 1in<sup>2</sup> FR4 board with 2 oz copper.



## N-Channel 30V (D-S) MOSFET

Electrical Characteristics (T<sub>A</sub>=25°C Unless Otherwise Specified)

Symbol	Parameter	Limit	Min	Typ	Max	Unit
<b>STATIC</b>						
BV <sub>DSS</sub>	Drain-Source Breakdown Voltage	V <sub>GS</sub> =0V, I <sub>D</sub> =250 μA	30			V
V <sub>GS(th)</sub>	Gate Threshold Voltage	V <sub>DS</sub> =V <sub>GS</sub> , I <sub>D</sub> =250 μA	1		3	V
I <sub>GSS</sub>	Gate-Body Leakage	V <sub>DS</sub> =0V, V <sub>GS</sub> =±20V			±100	nA
I <sub>DSS</sub>	Zero Gate Voltage Drain Current	V <sub>DS</sub> =30, V <sub>GS</sub> =0V			1	μA
R <sub>DS(ON)</sub>	Drain-Source On-Resistance*	V <sub>GS</sub> =10V, I <sub>D</sub> =50A		5	6	mΩ
		V <sub>GS</sub> =4.5V, I <sub>D</sub> =35A		7	9	
V <sub>SD</sub>	Diode Forward Voltage*	I <sub>SD</sub> =35A, V <sub>GS</sub> =0V		0.9	1.2	V
<b>DYNAMIC</b>						
Q <sub>g</sub>	Total Gate Charge	V <sub>DD</sub> =15V, V <sub>GS</sub> =10V, I <sub>D</sub> =35A		59		nC
Q <sub>g</sub>	Total Gate Charge	V <sub>DD</sub> =15V, V <sub>GS</sub> =4.5V, I <sub>D</sub> =35A		31		
Q <sub>gs</sub>	Gate-Source Charge			10		
Q <sub>gd</sub>	Gate-Drain Charge			14		
R <sub>g</sub>	Gate Resistance	V <sub>DS</sub> =0V, V <sub>GS</sub> =0V, f=1MHz		1.7		Ω
C <sub>iss</sub>	Input Capacitance	V <sub>DS</sub> =25V, V <sub>GS</sub> =0V, f=1MHz		2560		pF
C <sub>oss</sub>	Output Capacitance			388		
C <sub>rss</sub>	Reverse Transfer Capacitance			127		
t <sub>d(on)</sub>	Turn-On Delay Time	V <sub>DD</sub> =15V, I <sub>D</sub> =35A, V <sub>GS</sub> =4.5V, R <sub>G</sub> =6.2Ω		45		ns
t <sub>r</sub>	Turn-On Rise Time			45		
t <sub>d(off)</sub>	Turn-Off Delay Time			68		
t <sub>f</sub>	Turn-Off Fall Time			34		

Notes: a, pulse test: pulse width ≤ 300us, duty cycle ≤ 2%, Guaranteed by design, not subject to production testing.

b, Matsuki Electric/ Force mos reserves the right to improve product design, functions and reliability without notice.



**N-Channel 30V (D-S) MOSFET**

**Typical Characteristics (T<sub>J</sub> = 25°C Noted)**

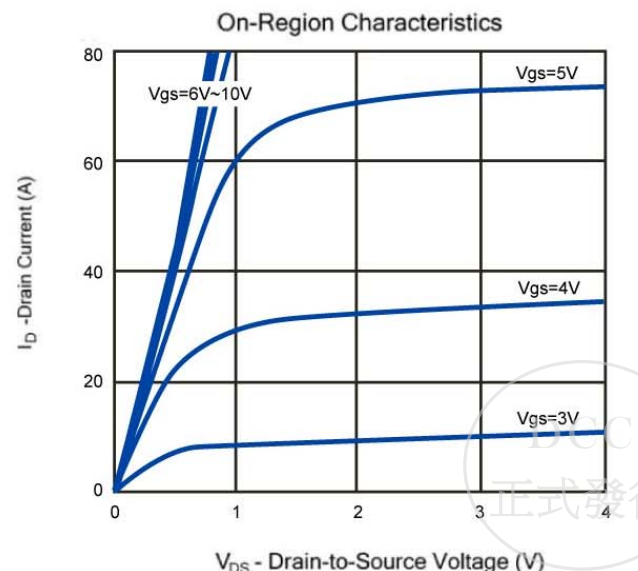
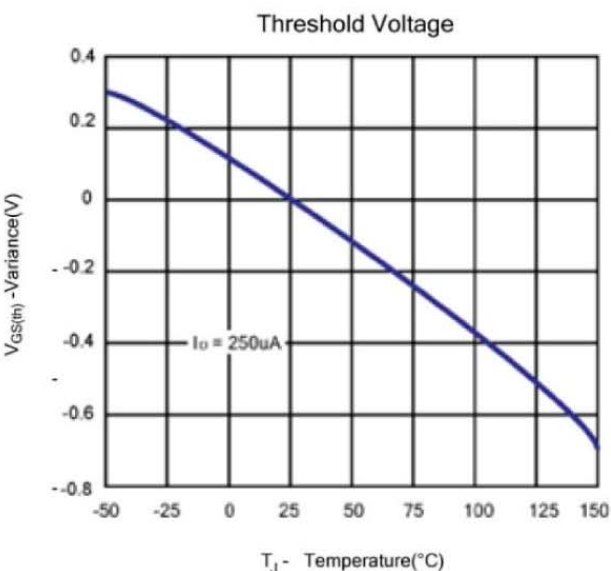
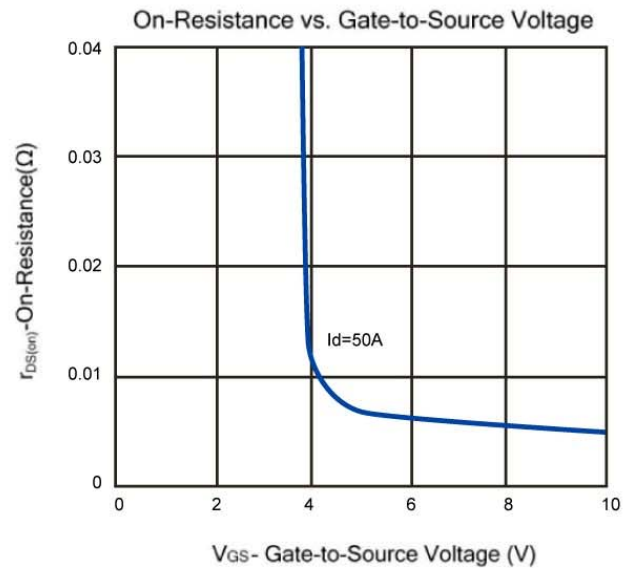
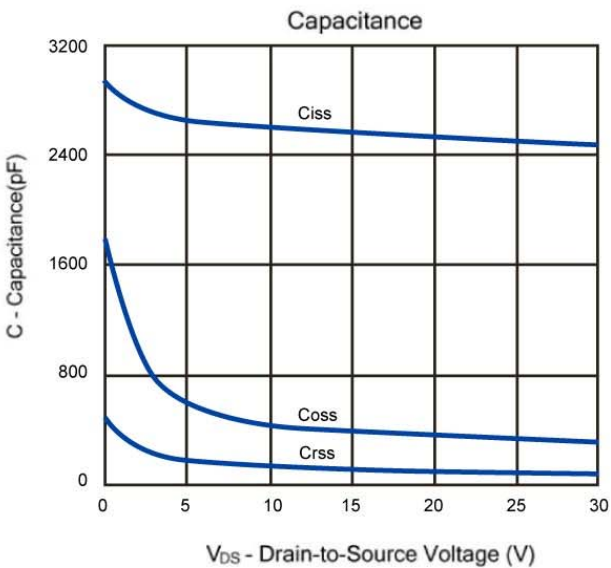
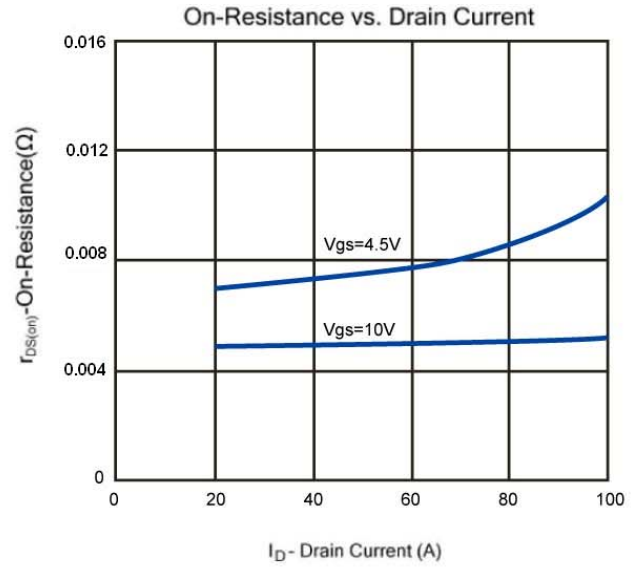
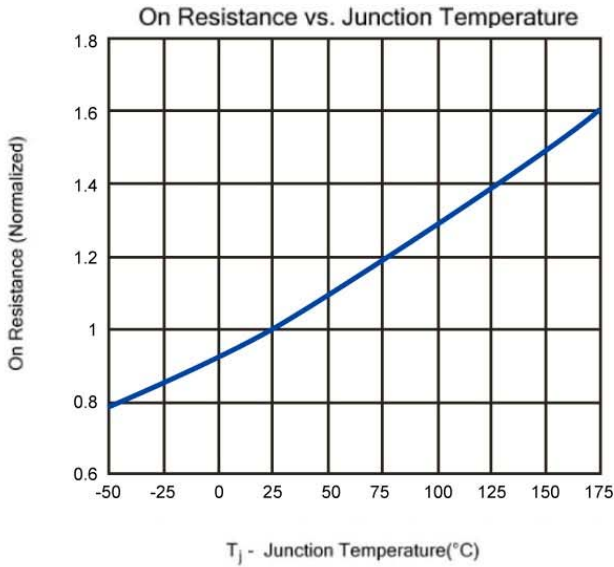

**N-Channel 30V (D-S) MOSFET**

Typical Characteristics (T<sub>J</sub> =25°C Noted)

**Gate Charge**

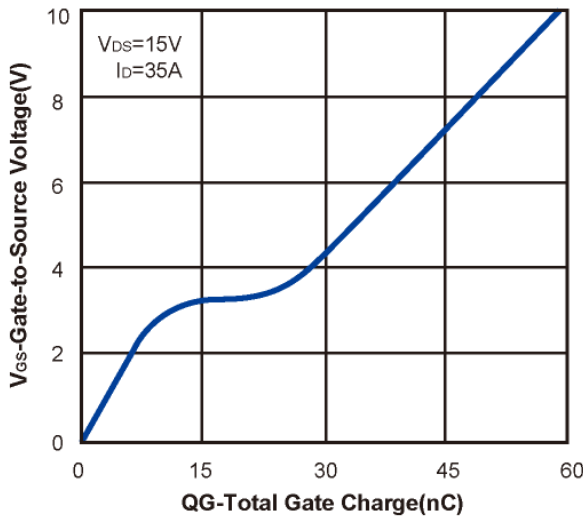

**Body-diode characteristics**

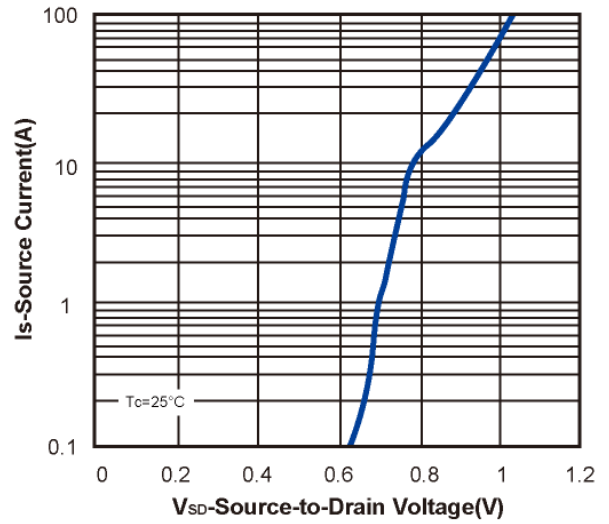

**Maximum Forward Biased Safe Operating Area**

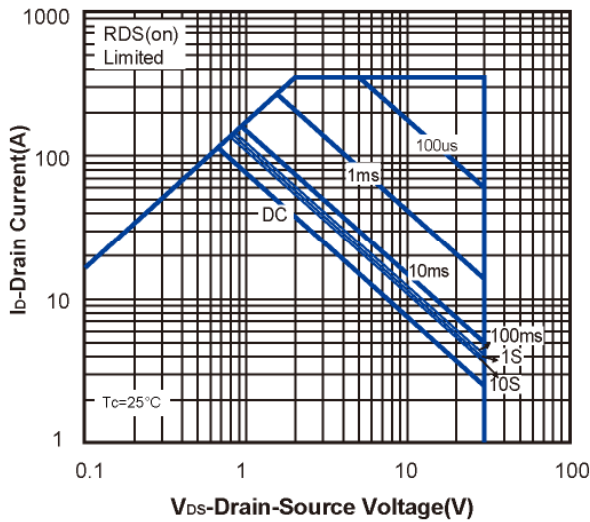

**Normalized Thermal Transient Impedance, Junction-to-Case**

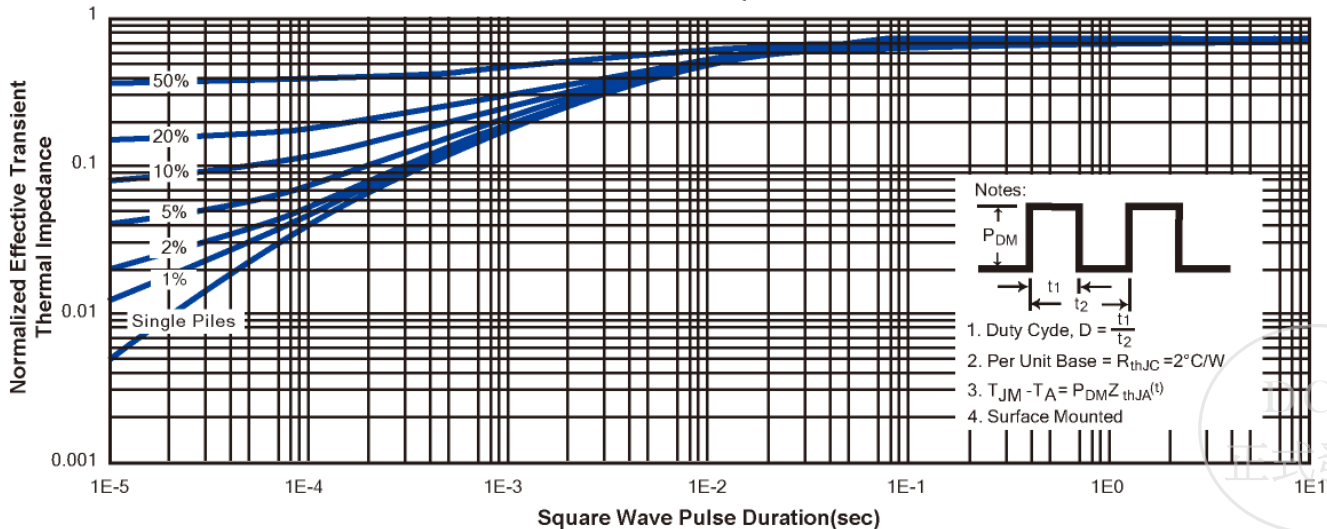

**TO-220 Package Outline**

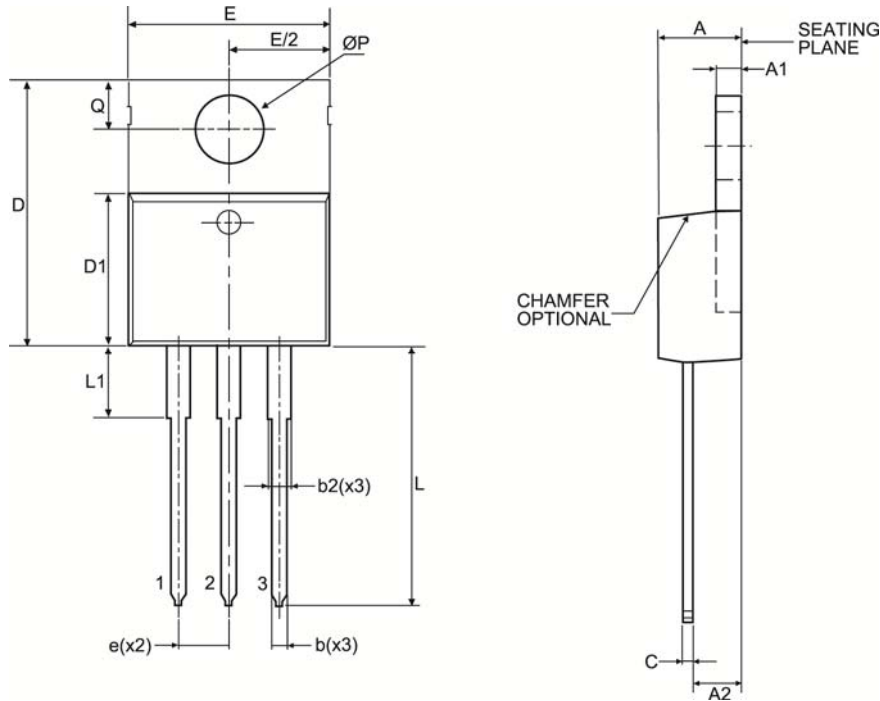

Symbol	MILLIMETERS (mm)	
	MIN	MAX
A	3.50	4.90
A1	1.00	1.40
A2	2.00	3.00
b	0.70	1.40
c	0.35	0.65
D	14.00	16.50
D1	8.30	9.50
E	9.60	10.70
e	2.54 BSC	
L	12.50	15.00
$\varnothing P$	3.60 TYP	
Q	2.50	3.10
b2	1.10	1.80
L1	2.40	3.20



## X-ON Electronics

Largest Supplier of Electrical and Electronic Components

*Click to view similar products for [MOSFET](#) category:*

*Click to view products by [MQTSUKI](#) manufacturer:*

Other Similar products are found below :

[614233C](#) [648584F](#) [MCH3443-TL-E](#) [MCH6422-TL-E](#) [FDPF9N50NZ](#) [FW216A-TL-2W](#) [FW231A-TL-E](#) [APT5010JVR](#) [NTNS3A92PZT5G](#)  
[IRF100S201](#) [JANTX2N5237](#) [2SK2464-TL-E](#) [2SK3818-DL-E](#) [FCA20N60\\_F109](#) [FDZ595PZ](#) [STD6600NT4G](#) [FSS804-TL-E](#) [2SJ277-DL-E](#)  
[2SK1691-DL-E](#) [2SK2545\(Q,T\)](#) [D2294UK](#) [405094E](#) [423220D](#) [MCH6646-TL-E](#) [TPCC8103,L1Q\(CM](#) [367-8430-0972-503](#) [VN1206L](#)  
[424134F](#) [026935X](#) [051075F](#) [SBVS138LT1G](#) [614234A](#) [715780A](#) [NTNS3166NZT5G](#) [751625C](#) [873612G](#) [IRF7380TRHR](#)  
[IPS70R2K0CEAKMA1](#) [RJK60S3DPP-E0#T2](#) [RJK60S5DPK-M0#T0](#) [APT5010JVFR](#) [APT12031JFLL](#) [APT12040JVR](#) [DMN3404LQ-7](#)  
[NTE6400](#) [JANTX2N6796U](#) [JANTX2N6784U](#) [JANTXV2N5416U4](#) [SQM110N05-06L-GE3](#) [SIHF35N60E-GE3](#)