

# MSKSEMI 美森科

SEMICONDUCTOR



ESD



TVS



TSS



MOV



GDT



PLED

## 1.5SMCXXXA(CA)(MS)

Product specification

## Features

- For surface mounted applications in order to optimize board space
- Low profile package
- Built-in strain relief
- Glass passivated junction
- Low inductance
- Excellent clamping capability
- 1500W peak pulse power capability at 10/1000µs waveform, repetition rate (duty cycle): 0.01%
- Fast response time
- Typical  $I_R$  less than 1µA above 12V
- High Temperature soldering: 260°C/10 seconds at terminals
- Plastic package has underwriters laboratory flammability 94V-0
- Meets MSL level 1, per J-STD-020





## Mechanical Data

- Case: JEDEC DO-214AB. Molded plastic over glass passivated junction
- Terminal: Solder plated, solderable per MIL-STD-750, Method 2026
- Polarity: Color band denotes cathode except bi-directional models
- Standard Packaging: 16mm tape (EIA STD RS-481)
- Weight: 0.26g

## Applications

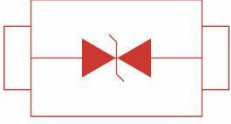
- I/O interface
- AC/DC power supply
- Low frequency signal transmission line (RS232, RS485, etc.)

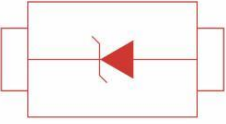
## Reference News

PACKAGE OUTLINE	PIN CONFIGURATION	Marking Information
		
<b>Unipolar</b>		
		
<b>Bipolar</b>		

## Part number code

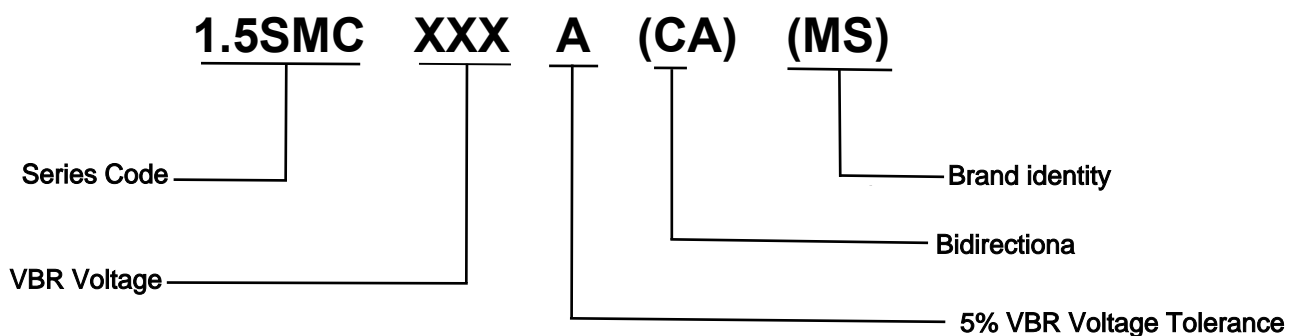

## Maximum Ratings and Characteristics

Ratings at 25°C ambient temperature unless otherwise specified.

Rating	Symbol	Value	Units
Peak pulse power dissipation at 10/1000µs waveform (Note1, Note2, Fig.1)	P <sub>PPM</sub>	1500	Watts
Peak pulse current of at 10/1000µs waveform (Note 1, Fig.3)	I <sub>PPM</sub>	See Table	Amps
Steady state power dissipation at T <sub>A</sub> =50°C (Fig.5)	P <sub>M(AV)</sub>	6.5	Watts
Peak forward surge current, 8.3ms single half sine-wave superimposed on rated load, (JEDEC Method) (Note3, Fig.6)	I <sub>FSM</sub>	200	Amps
Operating junction and Storage Temperature Range.	T <sub>J</sub> , T <sub>STG</sub>	-55 to +150	°C
Typical thermal resistance junction to lead	R <sub>θJL</sub>	15	°C/W
Typical thermal resistance junction to ambient	R <sub>θJA</sub>	75	°C/W

Notes: 1. Non-repetitive current pulse, per Fig.3 and derated above T<sub>A</sub>=25°C per Fig.2.

2. Mounted on 8.0mm×8.0mm copper pads to each terminal.

3. 8.3ms single half sine-wave, or equivalent square wave, duty cycle=4 pulses per minutes maximum.

## Electrical Characteristics (T<sub>A</sub>=25°C)

Part Number		Device Marking Code		Reverse Stand-Off Voltage	Breakdown Voltage @I <sub>T</sub>	Test Current	Maximum Clamping Voltage@I <sub>PP</sub>	Peak Pulse Current	Reverse Leakage @V <sub>RWM</sub>
Unidirectional	Bidirectional	UNI	BI	V <sub>RWM</sub> (V)	V <sub>BR</sub> (V)	I <sub>T</sub> (mA)	V <sub>C</sub> (V)	I <sub>PP</sub> (A)	I <sub>R</sub> (µA)
1.5SMC6.8A	1.5SMC6.8CA	6V8A	6V8C	5.80	6.45~7.14	10	10.5	144.8	1000
1.5SMC7.5A	1.5SMC7.5CA	7V5A	7V5C	6.40	7.13~7.88	10	11.3	134.5	500
1.5SMC8.2A	1.5SMC8.2CA	8V2A	8V2C	7.02	7.79~8.61	10	12.1	125.6	200
1.5SMC9.1A	1.5SMC9.1CA	9V1A	9V1C	7.78	8.65~9.55	1	13.4	113.4	50
1.5SMC10A	1.5SMC10CA	10A	10C	8.55	9.50~10.50	1	14.5	104.8	10
1.5SMC11A	1.5SMC11CA	11A	11C	9.40	10.50~11.60	1	15.6	97.4	5
1.5SMC12A	1.5SMC12CA	12A	12C	10.20	11.40~12.60	1	16.7	91.0	5
1.5SMC13A	1.5SMC13CA	13A	13C	11.10	12.40~13.70	1	18.2	83.5	1
1.5SMC15A	1.5SMC15CA	15A	15C	12.80	14.30~15.80	1	21.2	71.7	1
1.5SMC16A	1.5SMC16CA	16A	16C	13.60	15.20~16.80	1	22.5	67.6	1
1.5SMC18A	1.5SMC18CA	18A	18C	15.30	17.10~18.90	1	25.2	60.3	1
1.5SMC20A	1.5SMC20CA	20A	20C	17.10	19.00~21.00	1	27.7	54.9	1
1.5SMC22A	1.5SMC22CA	22A	22C	18.80	20.90~23.10	1	30.6	49.7	1
1.5SMC24A	1.5SMC24CA	24A	24C	20.50	22.80~25.20	1	33.2	45.8	1
1.5SMC27A	1.5SMC27CA	27A	27C	23.10	25.70~28.40	1	37.5	40.5	1
1.5SMC30A	1.5SMC30CA	30A	30C	25.60	28.50~31.50	1	41.4	36.7	1
1.5SMC33A	1.5SMC33CA	33A	33C	28.20	31.40~34.70	1	45.7	33.3	1
1.5SMC36A	1.5SMC36CA	36A	36C	30.80	34.20~37.80	1	49.9	30.5	1
1.5SMC39A	1.5SMC39CA	39A	39C	33.30	37.10~41.00	1	53.9	28.2	1

Part Number		Device Marking Code		Reverse Stand-Off Voltage	Breakdown Voltage @ $I_T$	Test Current	Maximum Clamping Voltage@ $I_{PP}$	Peak Pulse Current	Reverse Leakage @ $V_{RWM}$
Unidirectional	Bidirectional	UNI	BI	$V_{RWM}(V)$	$V_{BR}(V)$	$I_T(mA)$	$V_C(V)$	$I_{PP}(A)$	$I_R(\mu A)$
1.5SMC43A	1.5SMC43CA	43A	43C	36.80	40.90~45.20	1	59.3	25.6	1
1.5SMC47A	1.5SMC47CA	47A	47C	40.20	44.70~49.40	1	64.8	23.5	1
1.5SMC51A	1.5SMC51CA	51A	51C	43.60	48.50~53.60	1	70.1	21.7	1
1.5SMC56A	1.5SMC56CA	56A	56C	47.80	53.20~58.80	1	77.0	19.7	1
1.5SMC62A	1.5SMC62CA	62A	62C	53.00	58.90~65.10	1	85.0	17.9	1
1.5SMC68A	1.5SMC68CA	68A	68C	58.10	64.60~71.40	1	92.0	16.5	1
1.5SMC75A	1.5SMC75CA	75A	75C	64.10	71.30~78.80	1	103.0	14.8	1
1.5SMC82A	1.5SMC82CA	82A	82C	70.10	77.90~86.10	1	113.0	13.5	1
1.5SMC91A	1.5SMC91CA	91A	91C	77.80	86.50~95.50	1	125.0	12.2	1
1.5SMC100A	1.5SMC100CA	100A	100C	85.50	95.00~105.00	1	137.0	11.1	1
1.5SMC110A	1.5SMC110CA	110A	110C	94.00	105.00~116.00	1	152.0	10.0	1
1.5SMC120A	1.5SMC120CA	120A	120C	102.00	114.00~126.00	1	165.0	9.2	1
1.5SMC130A	1.5SMC130CA	130A	130C	111.00	124.00~137.00	1	179.0	8.5	1
1.5SMC150A	1.5SMC150CA	150A	150C	128.00	143.00~158.00	1	207.0	7.3	1
1.5SMC160A	1.5SMC160CA	160A	160C	136.00	152.00~168.00	1	219.0	6.9	1
1.5SMC170A	1.5SMC170CA	170A	170C	145.00	162.00~179.00	1	234.0	6.5	1
1.5SMC180A	1.5SMC180CA	180A	180C	154.00	171.00~189.00	1	246.0	6.2	1
1.5SMC200A	1.5SMC200CA	200A	200C	171.00	190.00~210.00	1	274.0	5.5	1
1.5SMC220A	1.5SMC220CA	220A	220C	185.00	209.00~231.00	1	328.0	4.6	1
1.5SMC250A	1.5SMC250CA	250A	250C	214.00	237.00~263.00	1	344.0	4.4	1
1.5SMC300A	1.5SMC300CA	300A	300C	256.00	285.00~315.00	1	414.0	3.7	1
1.5SMC350A	1.5SMC350CA	350A	350C	300.00	332.00~368.00	1	482.0	3.2	1
1.5SMC400A	1.5SMC400CA	400A	400C	342.00	380.00~420.00	1	548.0	2.8	1
1.5SMC440A	1.5SMC440CA	440A	440C	376.00	418.00~462.00	1	602.0	2.5	1
1.5SMC480A	1.5SMC480CA	480A	480C	408.00	456.00~504.00	1	658.0	2.3	1
1.5SMC510A	1.5SMC510CA	510A	510C	434.00	485.00~535.00	1	698.0	2.1	1
1.5SMC530A	1.5SMC530CA	530A	530C	450.00	503.50~556.50	1	725.0	2.1	1
1.5SMC540A	1.5SMC540CA	540A	540C	459.00	513.00~567.00	1	740.0	2.0	1
1.5SMC550A	1.5SMC550CA	550A	550C	467.00	522.50~577.50	1	760.0	2.0	1

**Ratings and Characteristic Curves ( $T_A=25^\circ\text{C}$  unless otherwise noted)**

Figure 1. Peak Pulse Power Rating Curve

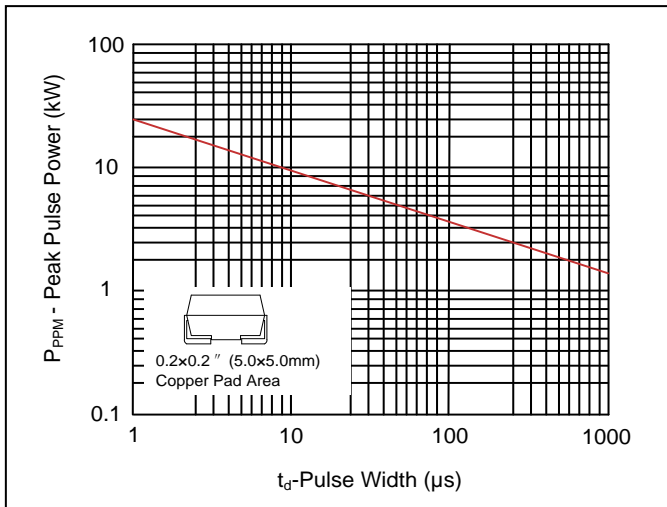

Figure 2. Pulse Derating Curve

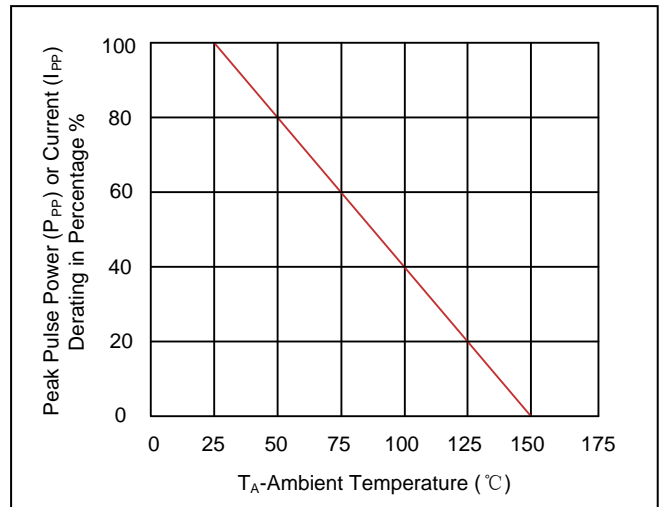

Figure 3. Pulse Waveform

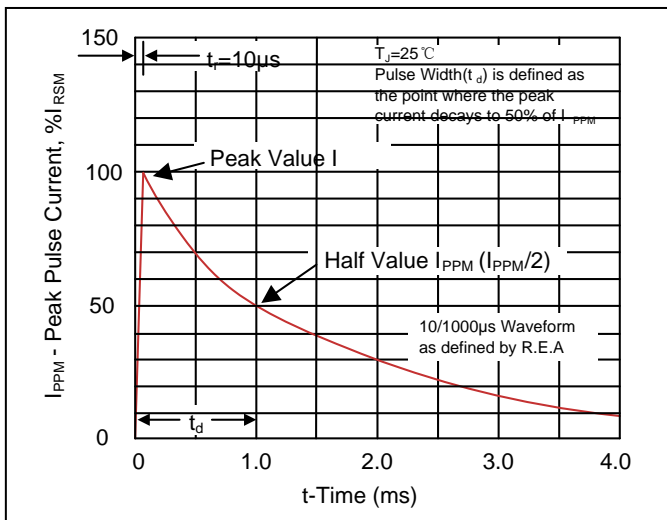

Figure 4. Typical Junction Capacitance

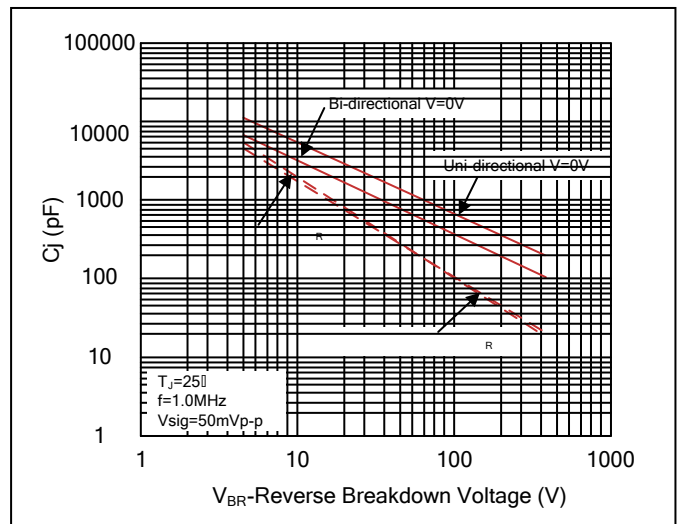

Figure 5. Steady State Power Dissipation Derating Curve

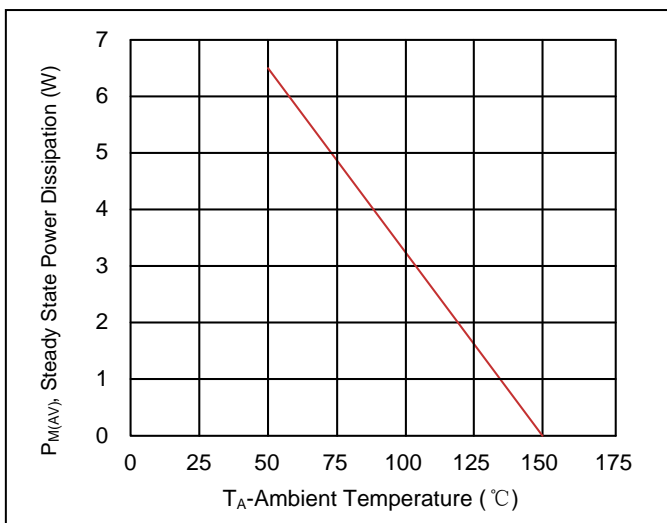
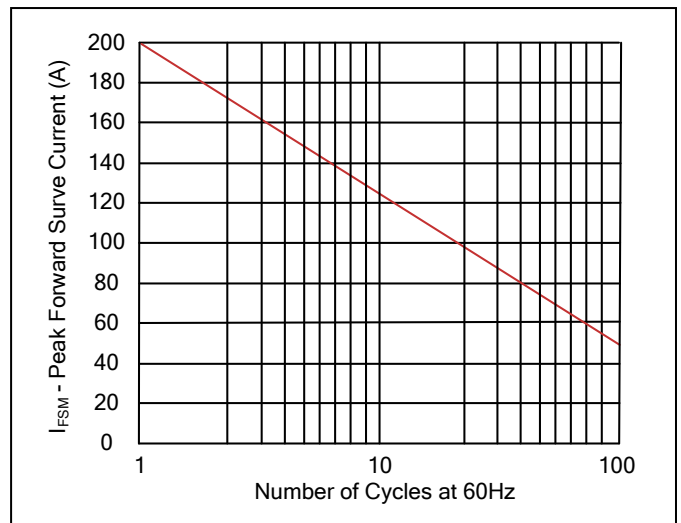
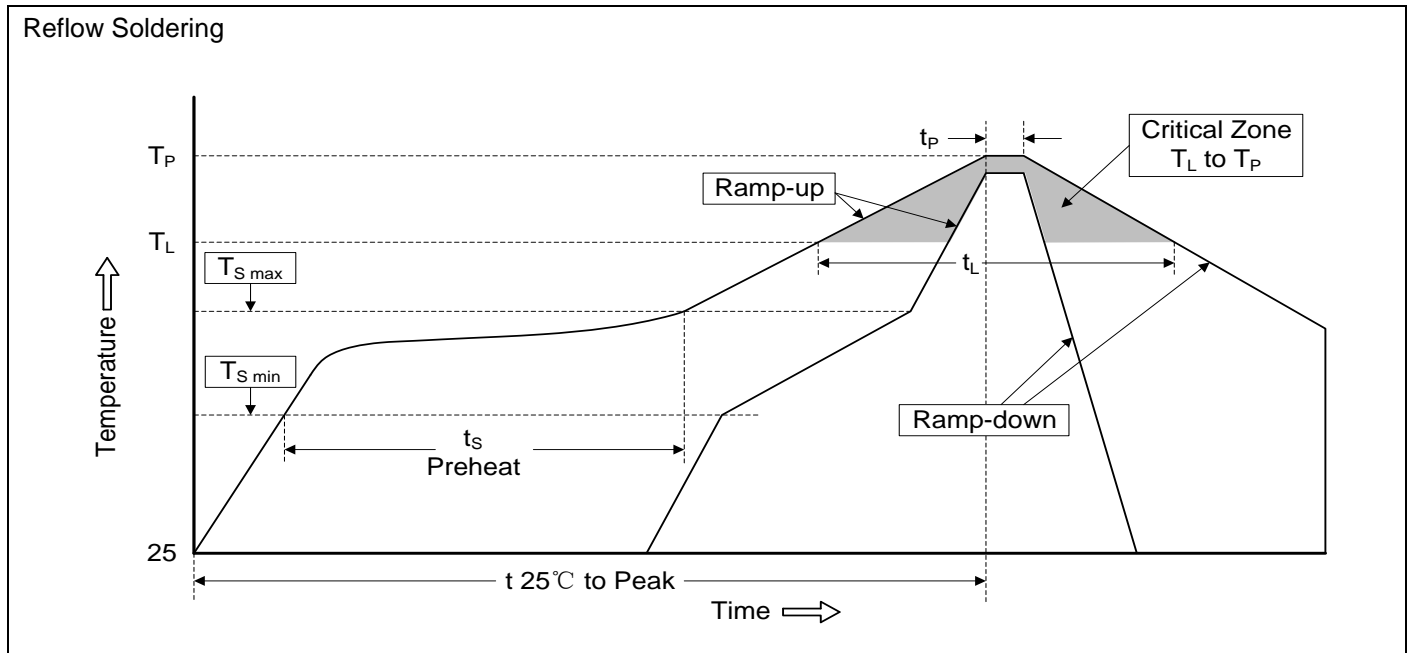

Figure 6. Maximum Non-Repetitive Forward Surge Current Uni-Directional Only



**Recommended Soldering Conditions**



**Recommended Conditions**

Profile Feature	Pb-Free Assembly
Average ramp-up rate ( $T_L$ to $T_P$ )	3°C/second max.
Preheat -Temperature Min ( $T_{S\ min}$ ) -Temperature Max ( $T_{S\ max}$ ) -Time (min to max) ( $t_s$ )	150°C 200°C 60-180 seconds
$T_{S\ max}$ to $T_L$ -Ramp-up Rate	3°C/second max.
Time maintained above: -Temperature ( $T_L$ ) -Time ( $t_L$ )	217°C 60-150 seconds
Peak Temperature ( $T_P$ )	260°C
Time within 5°C of actual Peak Temperature ( $t_p$ )	20-40 seconds
Ramp-down Rate	6°C/second max.
Time 25°C to Peak Temperature	8 minutes max.

**PACKAGE MECHANICAL DATA**

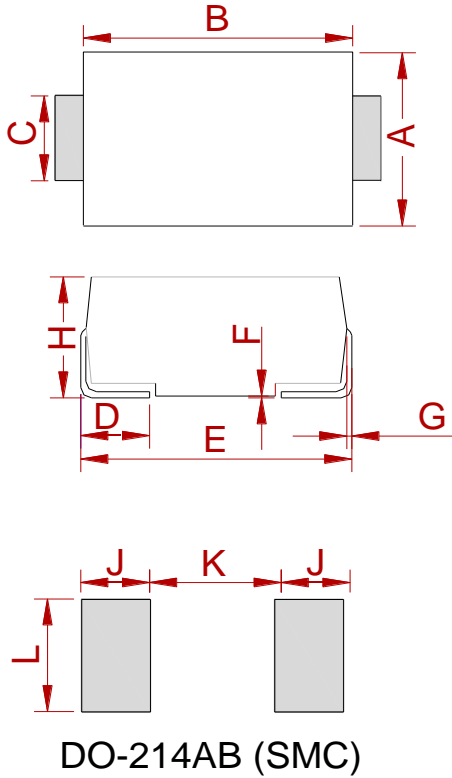

Ref.	Dimensions			
	Millimeters		Inches	
	Min.	Max.	Min.	Max.
A	5.75	6.25	0.226	0.246
B	6.90	7.40	0.272	0.291
C	2.75	3.25	0.108	0.128
D	0.95	1.52	0.037	0.060
E	7.70	8.20	0.303	0.323
F	0.051	0.203	0.002	0.008
G	0.15	0.31	0.006	0.012
H	2.15	2.62	0.085	0.103
J	2.40		0.094	
K		4.20		0.165
L	3.30		0.130	

**REEL SPECIFICATION**

P/N	PKG	QTY
1.5SMCXXXA(CA)(MS)	SMC	3000

## Attention

- Any and all MSKSEMI Semiconductor products described or contained herein do not have specifications that can handle applications that require extremely high levels of reliability, such as life-support systems, aircraft's control systems, or other applications whose failure can be reasonably expected to result in serious physical and/or material damage. Consult with your MSKSEMI Semiconductor representative nearest you before using any MSKSEMI Semiconductor products described or contained herein in such applications.
- MSKSEMI Semiconductor assumes no responsibility for equipment failures that result from using products at values that exceed, even momentarily, rated values (such as maximum ratings, operating condition ranges, or other parameters) listed in products specifications of any and all MSKSEMI Semiconductor products described or contained herein.
- Specifications of any and all MSKSEMI Semiconductor products described or contained herein stipulate the performance, characteristics, and functions of the described products in the independent state, and are not guarantees of the performance, characteristics, and functions of the described products as mounted in the customer's products or equipment. To verify symptoms and states that cannot be evaluated in an independent device, the customer should always evaluate and test devices mounted in the customer's products or equipment.
- MSKSEMI Semiconductor strives to supply high-quality high-reliability products. However, any and all semiconductor products fail with some probability. It is possible that these probabilistic failures could give rise to accidents or events that could endanger human lives, that could give rise to smoke or fire, or that could cause damage to other property. When designing equipment, adopt safety measures so that these kinds of accidents or events cannot occur. Such measures include but are not limited to protective circuits and error prevention circuits for safe design, redundant design, and structural design.
- In the event that any or all MSKSEMI Semiconductor products (including technical data, services) described or contained herein are controlled under any of applicable local export control laws and regulations, such products must not be exported without obtaining the export license from the authorities concerned in accordance with the above law.
- No part of this publication may be reproduced or transmitted in any form or by any means, electronic or mechanical, including photocopying and recording, or any information storage or retrieval system, or otherwise, without the prior written permission of MSKSEMI Semiconductor.
- Information (including circuit diagrams and circuit parameters) herein is for example only ; it is not guaranteed for volume production. MSKSEMI Semiconductor believes information herein is accurate and reliable, but no guarantees are made or implied regarding its use or any infringements of intellectual property rights or other rights of third parties.
- Any and all information described or contained herein are subject to change without notice due to product/technology improvement, etc. When designing equipment, refer to the "Delivery Specification" for the MSKSEMI Semiconductor product that you intend to use.



## X-ON Electronics

Largest Supplier of Electrical and Electronic Components

*Click to view similar products for [ESD Suppressors / TVS Diodes](#) category:*

*Click to view products by [MSKSEMI](#) manufacturer:*

Other Similar products are found below :

[60KS200C](#) [D18V0L1B2LP-7B](#) [D5V0F4U5P5-7](#) [NTE4902](#) [P4KE27CA](#) [P6KE11CA](#) [P6KE8.2A](#) [SA60CA](#) [SA64CA](#) [SMBJ12CATR](#)  
[SMBJ33CATR](#) [SMBJ6.5A](#) [SMBJ8.0A](#) [ESD101-B1-02ELS E6327](#) [ESD112-B1-02EL E6327](#) [ESD7451N2T5G](#) [19180-510](#) [CPDT-5V0USP-](#)  
[HF](#) [3.0SMCJ33CA-F](#) [3.0SMCJ36A-F](#) [HSPC16701B02TP](#) [JANTX1N6126A](#) [D3V3Q1B2DLP3-7](#) [D55V0M1B2WS-7](#) [SCM1293A-04SO](#)  
[ESD200-B1-CSP0201 E6327](#) [SM12-7](#) [CEN955 W/DATA](#) [VESD12A1A-HD1-GS08](#) [CPDQC5V0-HF](#) [D1213A-01LP4-7B](#) [ESD101-B1-02EL](#)  
[E6327](#) [AOZ8808DI-03](#) [5KP15A](#) [5KP48A](#) [5KP90A](#) [ESD3V3D7-TP](#) [15KPA36A-LF](#) [P4KE56CA](#) [P4KE68A](#) [P4KE91CATR](#) [P6KE120A](#)  
[P6KE13CA](#) [P6KE43CA](#) [P6KE6.8CA](#) [P6KE8.2](#) [P6SMBJ20CA](#) [JANTX1N6072A](#) [SR2835ESKG](#) [SA90CA](#)