

MSKSEMI 美森科

SEMICONDUCTOR



ESD



TVS



TSS



MOV



GDT



PLED

1.5SMCXXXA(CA)(MS)

Product specification

Features

- For surface mounted applications in order to optimize board space
- Low profile package
- Built-in strain relief
- Glass passivated junction
- Low inductance
- Excellent clamping capability
- 1500W peak pulse power capability at 10/1000µs waveform, repetition rate (duty cycle): 0.01%
- Fast response time
- Typical I_R less than 1µA above 12V
- High Temperature soldering: 260°C/10 seconds at terminals
- Plastic package has underwriters laboratory flammability 94V-0
- Meets MSL level 1, per J-STD-020





Mechanical Data

- Case: JEDEC DO-214AB. Molded plastic over glass passivated junction
- Terminal: Solder plated, solderable per MIL-STD-750, Method 2026
- Polarity: Color band denotes cathode except bi-directional models
- Standard Packaging: 16mm tape (EIA STD RS-481)
- Weight: 0.26g

Applications

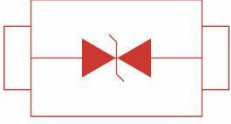
- I/O interface
- AC/DC power supply
- Low frequency signal transmission line (RS232, RS485, etc.)

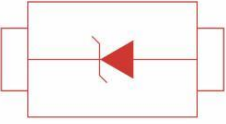
Reference News

| PACKAGE OUTLINE | PIN CONFIGURATION | Marking Information |
|---|---|---|
|  |  |  |
| Unipolar | | |
|  |  |  |
| Bipolar | | |

Part number code

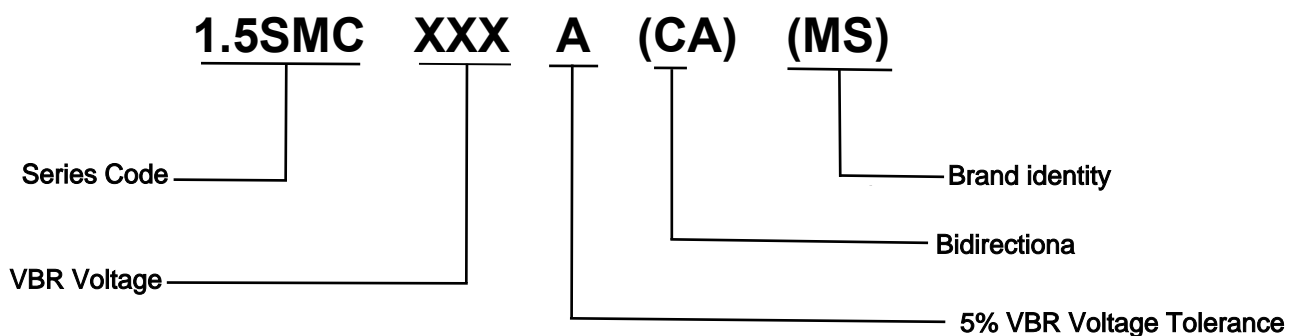

Maximum Ratings and Characteristics

Ratings at 25°C ambient temperature unless otherwise specified.

| Rating | Symbol | Value | Units |
|---|-----------------------------------|-------------|-------|
| Peak pulse power dissipation at 10/1000μs waveform (Note1, Note2, Fig.1) | P _{PPM} | 1500 | Watts |
| Peak pulse current of at 10/1000μs waveform (Note 1, Fig.3) | I _{PPM} | See Table | Amps |
| Steady state power dissipation at T _A =50°C (Fig.5) | P _{M(AV)} | 6.5 | Watts |
| Peak forward surge current, 8.3ms single half sine-wave superimposed on rated load, (JEDEC Method) (Note3, Fig.6) | I _{FSM} | 200 | Amps |
| Operating junction and Storage Temperature Range. | T _J , T _{STG} | -55 to +150 | °C |
| Typical thermal resistance junction to lead | R _{θJL} | 15 | °C/W |
| Typical thermal resistance junction to ambient | R _{θJA} | 75 | °C/W |

Notes: 1. Non-repetitive current pulse, per Fig.3 and derated above T_A=25°C per Fig.2.

2. Mounted on 8.0mm×8.0mm copper pads to each terminal.

3. 8.3ms single half sine-wave, or equivalent square wave, duty cycle=4 pulses per minutes maximum.

Electrical Characteristics (T_A=25°C)

| Part Number | | Device Marking Code | | Reverse Stand-Off Voltage | Breakdown Voltage @I _T | Test Current | Maximum Clamping Voltage@I _{PP} | Peak Pulse Current | Reverse Leakage @V _{RWM} |
|----------------|---------------|---------------------|------|---------------------------|-----------------------------------|---------------------|--|---------------------|-----------------------------------|
| Unidirectional | Bidirectional | UNI | BI | V _{RWM} (V) | V _{BR} (V) | I _T (mA) | V _C (V) | I _{PP} (A) | I _R (μA) |
| 1.5SMC6.8A | 1.5SMC6.8CA | 6V8A | 6V8C | 5.80 | 6.45~7.14 | 10 | 10.5 | 144.8 | 1000 |
| 1.5SMC7.5A | 1.5SMC7.5CA | 7V5A | 7V5C | 6.40 | 7.13~7.88 | 10 | 11.3 | 134.5 | 500 |
| 1.5SMC8.2A | 1.5SMC8.2CA | 8V2A | 8V2C | 7.02 | 7.79~8.61 | 10 | 12.1 | 125.6 | 200 |
| 1.5SMC9.1A | 1.5SMC9.1CA | 9V1A | 9V1C | 7.78 | 8.65~9.55 | 1 | 13.4 | 113.4 | 50 |
| 1.5SMC10A | 1.5SMC10CA | 10A | 10C | 8.55 | 9.50~10.50 | 1 | 14.5 | 104.8 | 10 |
| 1.5SMC11A | 1.5SMC11CA | 11A | 11C | 9.40 | 10.50~11.60 | 1 | 15.6 | 97.4 | 5 |
| 1.5SMC12A | 1.5SMC12CA | 12A | 12C | 10.20 | 11.40~12.60 | 1 | 16.7 | 91.0 | 5 |
| 1.5SMC13A | 1.5SMC13CA | 13A | 13C | 11.10 | 12.40~13.70 | 1 | 18.2 | 83.5 | 1 |
| 1.5SMC15A | 1.5SMC15CA | 15A | 15C | 12.80 | 14.30~15.80 | 1 | 21.2 | 71.7 | 1 |
| 1.5SMC16A | 1.5SMC16CA | 16A | 16C | 13.60 | 15.20~16.80 | 1 | 22.5 | 67.6 | 1 |
| 1.5SMC18A | 1.5SMC18CA | 18A | 18C | 15.30 | 17.10~18.90 | 1 | 25.2 | 60.3 | 1 |
| 1.5SMC20A | 1.5SMC20CA | 20A | 20C | 17.10 | 19.00~21.00 | 1 | 27.7 | 54.9 | 1 |
| 1.5SMC22A | 1.5SMC22CA | 22A | 22C | 18.80 | 20.90~23.10 | 1 | 30.6 | 49.7 | 1 |
| 1.5SMC24A | 1.5SMC24CA | 24A | 24C | 20.50 | 22.80~25.20 | 1 | 33.2 | 45.8 | 1 |
| 1.5SMC27A | 1.5SMC27CA | 27A | 27C | 23.10 | 25.70~28.40 | 1 | 37.5 | 40.5 | 1 |
| 1.5SMC30A | 1.5SMC30CA | 30A | 30C | 25.60 | 28.50~31.50 | 1 | 41.4 | 36.7 | 1 |
| 1.5SMC33A | 1.5SMC33CA | 33A | 33C | 28.20 | 31.40~34.70 | 1 | 45.7 | 33.3 | 1 |
| 1.5SMC36A | 1.5SMC36CA | 36A | 36C | 30.80 | 34.20~37.80 | 1 | 49.9 | 30.5 | 1 |
| 1.5SMC39A | 1.5SMC39CA | 39A | 39C | 33.30 | 37.10~41.00 | 1 | 53.9 | 28.2 | 1 |

| Part Number | | Device Marking Code | | Reverse Stand-Off Voltage | Breakdown Voltage @ I_T | Test Current | Maximum Clamping Voltage@ I_{PP} | Peak Pulse Current | Reverse Leakage @ V_{RWM} |
|----------------|---------------|---------------------|------|---------------------------|---------------------------|--------------|------------------------------------|--------------------|-----------------------------|
| Unidirectional | Bidirectional | UNI | BI | $V_{RWM}(V)$ | $V_{BR}(V)$ | $I_T(mA)$ | $V_C(V)$ | $I_{PP}(A)$ | $I_R(\mu A)$ |
| 1.5SMC43A | 1.5SMC43CA | 43A | 43C | 36.80 | 40.90~45.20 | 1 | 59.3 | 25.6 | 1 |
| 1.5SMC47A | 1.5SMC47CA | 47A | 47C | 40.20 | 44.70~49.40 | 1 | 64.8 | 23.5 | 1 |
| 1.5SMC51A | 1.5SMC51CA | 51A | 51C | 43.60 | 48.50~53.60 | 1 | 70.1 | 21.7 | 1 |
| 1.5SMC56A | 1.5SMC56CA | 56A | 56C | 47.80 | 53.20~58.80 | 1 | 77.0 | 19.7 | 1 |
| 1.5SMC62A | 1.5SMC62CA | 62A | 62C | 53.00 | 58.90~65.10 | 1 | 85.0 | 17.9 | 1 |
| 1.5SMC68A | 1.5SMC68CA | 68A | 68C | 58.10 | 64.60~71.40 | 1 | 92.0 | 16.5 | 1 |
| 1.5SMC75A | 1.5SMC75CA | 75A | 75C | 64.10 | 71.30~78.80 | 1 | 103.0 | 14.8 | 1 |
| 1.5SMC82A | 1.5SMC82CA | 82A | 82C | 70.10 | 77.90~86.10 | 1 | 113.0 | 13.5 | 1 |
| 1.5SMC91A | 1.5SMC91CA | 91A | 91C | 77.80 | 86.50~95.50 | 1 | 125.0 | 12.2 | 1 |
| 1.5SMC100A | 1.5SMC100CA | 100A | 100C | 85.50 | 95.00~105.00 | 1 | 137.0 | 11.1 | 1 |
| 1.5SMC110A | 1.5SMC110CA | 110A | 110C | 94.00 | 105.00~116.00 | 1 | 152.0 | 10.0 | 1 |
| 1.5SMC120A | 1.5SMC120CA | 120A | 120C | 102.00 | 114.00~126.00 | 1 | 165.0 | 9.2 | 1 |
| 1.5SMC130A | 1.5SMC130CA | 130A | 130C | 111.00 | 124.00~137.00 | 1 | 179.0 | 8.5 | 1 |
| 1.5SMC150A | 1.5SMC150CA | 150A | 150C | 128.00 | 143.00~158.00 | 1 | 207.0 | 7.3 | 1 |
| 1.5SMC160A | 1.5SMC160CA | 160A | 160C | 136.00 | 152.00~168.00 | 1 | 219.0 | 6.9 | 1 |
| 1.5SMC170A | 1.5SMC170CA | 170A | 170C | 145.00 | 162.00~179.00 | 1 | 234.0 | 6.5 | 1 |
| 1.5SMC180A | 1.5SMC180CA | 180A | 180C | 154.00 | 171.00~189.00 | 1 | 246.0 | 6.2 | 1 |
| 1.5SMC200A | 1.5SMC200CA | 200A | 200C | 171.00 | 190.00~210.00 | 1 | 274.0 | 5.5 | 1 |
| 1.5SMC220A | 1.5SMC220CA | 220A | 220C | 185.00 | 209.00~231.00 | 1 | 328.0 | 4.6 | 1 |
| 1.5SMC250A | 1.5SMC250CA | 250A | 250C | 214.00 | 237.00~263.00 | 1 | 344.0 | 4.4 | 1 |
| 1.5SMC300A | 1.5SMC300CA | 300A | 300C | 256.00 | 285.00~315.00 | 1 | 414.0 | 3.7 | 1 |
| 1.5SMC350A | 1.5SMC350CA | 350A | 350C | 300.00 | 332.00~368.00 | 1 | 482.0 | 3.2 | 1 |
| 1.5SMC400A | 1.5SMC400CA | 400A | 400C | 342.00 | 380.00~420.00 | 1 | 548.0 | 2.8 | 1 |
| 1.5SMC440A | 1.5SMC440CA | 440A | 440C | 376.00 | 418.00~462.00 | 1 | 602.0 | 2.5 | 1 |
| 1.5SMC480A | 1.5SMC480CA | 480A | 480C | 408.00 | 456.00~504.00 | 1 | 658.0 | 2.3 | 1 |
| 1.5SMC510A | 1.5SMC510CA | 510A | 510C | 434.00 | 485.00~535.00 | 1 | 698.0 | 2.1 | 1 |
| 1.5SMC530A | 1.5SMC530CA | 530A | 530C | 450.00 | 503.50~556.50 | 1 | 725.0 | 2.1 | 1 |
| 1.5SMC540A | 1.5SMC540CA | 540A | 540C | 459.00 | 513.00~567.00 | 1 | 740.0 | 2.0 | 1 |
| 1.5SMC550A | 1.5SMC550CA | 550A | 550C | 467.00 | 522.50~577.50 | 1 | 760.0 | 2.0 | 1 |

Ratings and Characteristic Curves ($T_A=25^\circ\text{C}$ unless otherwise noted)

Figure 1. Peak Pulse Power Rating Curve

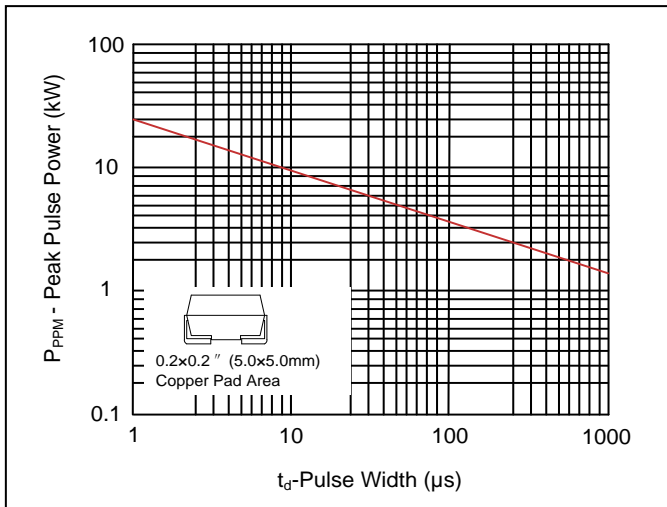

Figure 2. Pulse Derating Curve

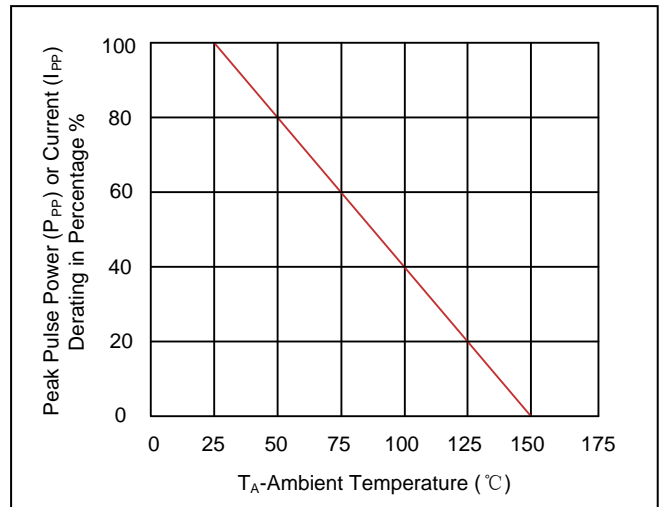

Figure 3. Pulse Waveform

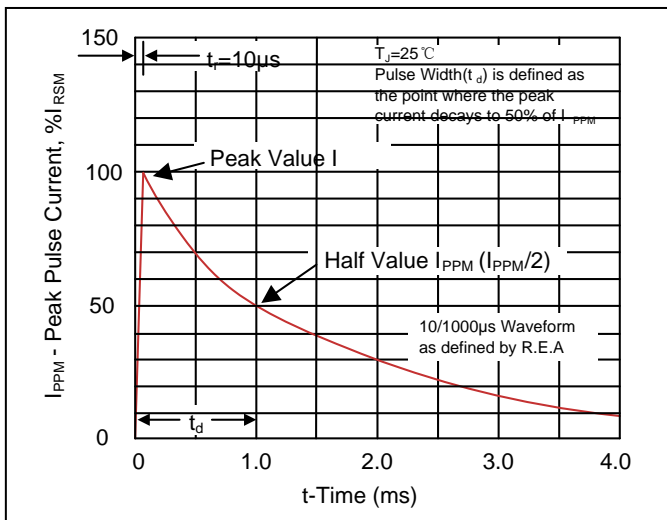

Figure 4. Typical Junction Capacitance

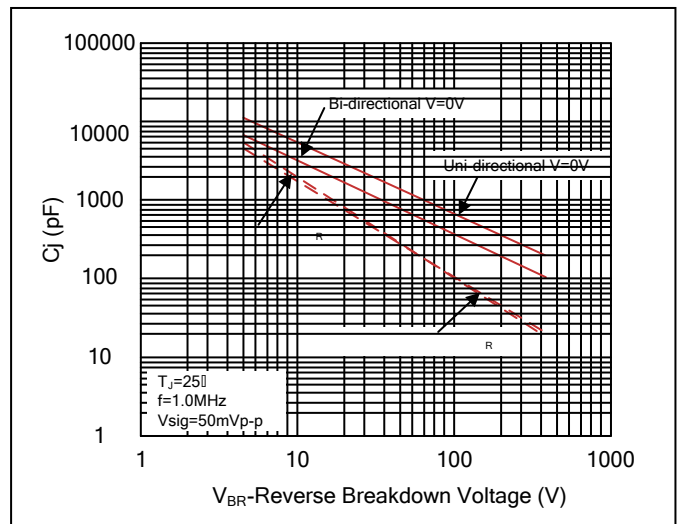

Figure 5. Steady State Power Dissipation Derating Curve

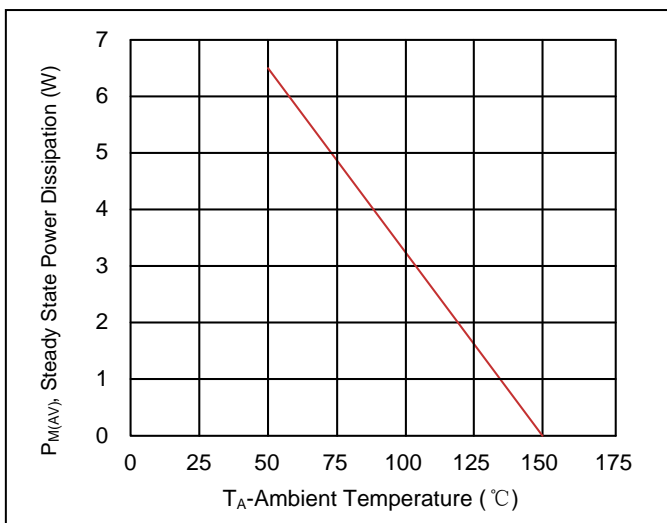
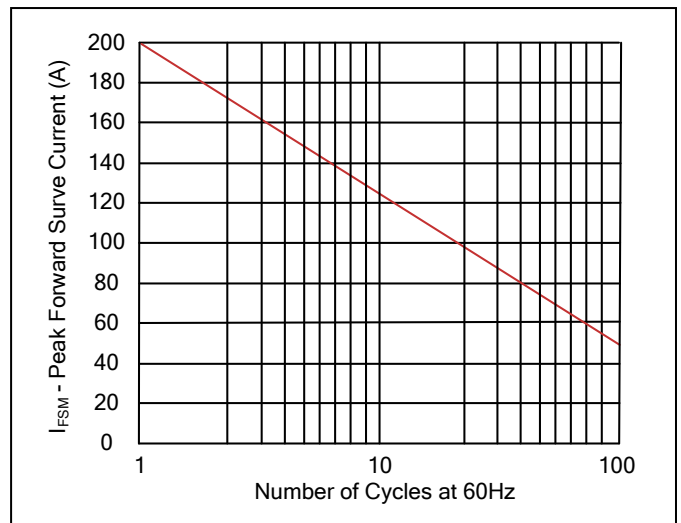
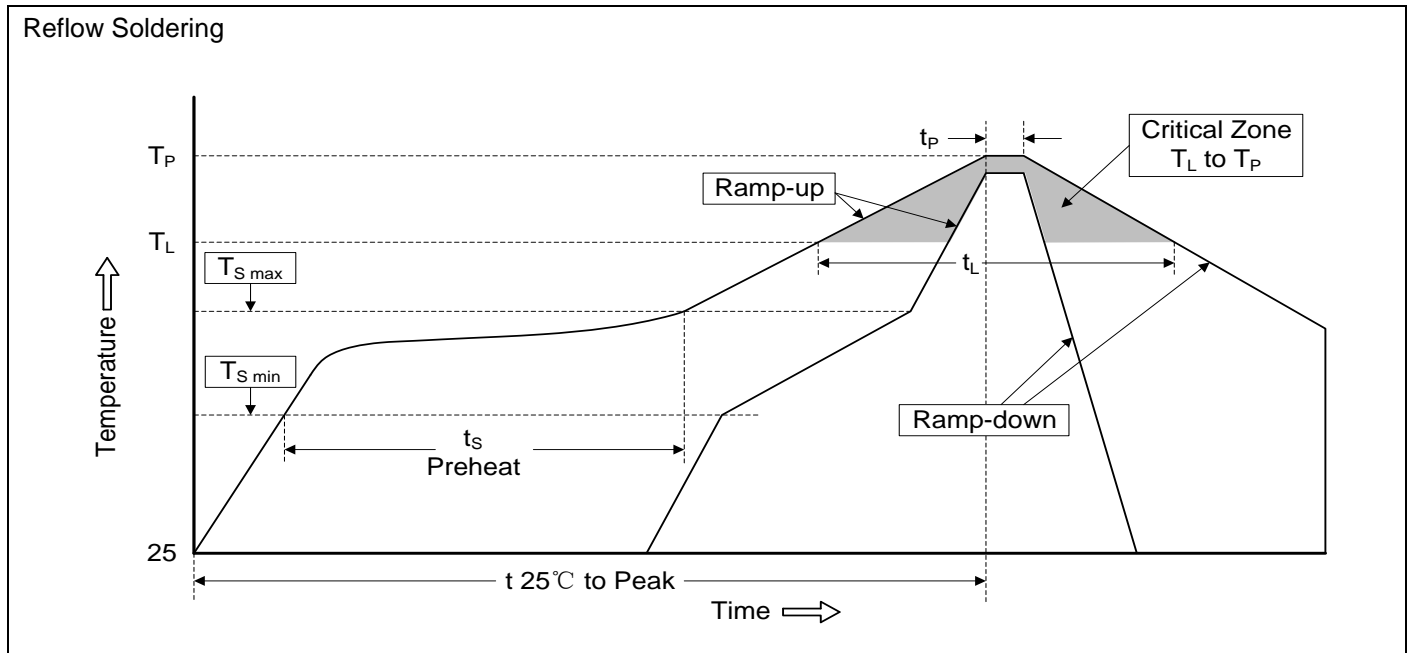

Figure 6. Maximum Non-Repetitive Forward Surge Current Uni-Directional Only



Recommended Soldering Conditions



Recommended Conditions

| Profile Feature | Pb-Free Assembly |
|---|----------------------------------|
| Average ramp-up rate (T_L to T_P) | 3°C/second max. |
| Preheat -Temperature Min ($T_{S\ min}$) -Temperature Max ($T_{S\ max}$) -Time (min to max) (t_s) | 150°C 200°C 60-180 seconds |
| $T_{S\ max}$ to T_L -Ramp-up Rate | 3°C/second max. |
| Time maintained above: -Temperature (T_L) -Time (t_L) | 217°C 60-150 seconds |
| Peak Temperature (T_P) | 260°C |
| Time within 5°C of actual Peak Temperature (t_p) | 20-40 seconds |
| Ramp-down Rate | 6°C/second max. |
| Time 25°C to Peak Temperature | 8 minutes max. |

PACKAGE MECHANICAL DATA

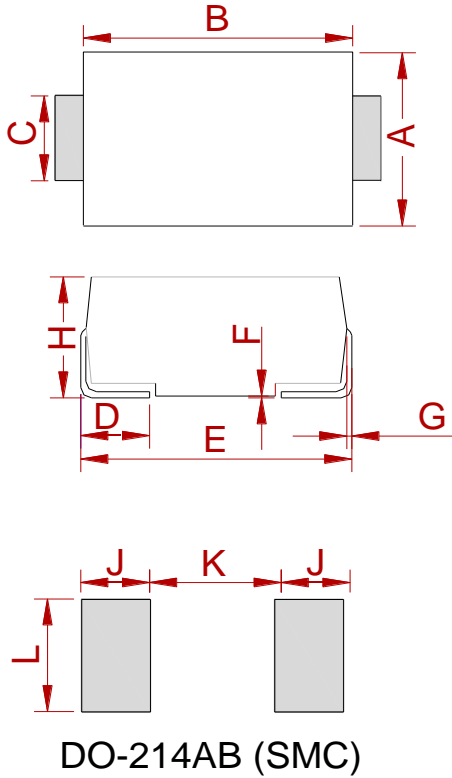

| Ref. | Dimensions | | | |
|------|-------------|-------|--------|-------|
| | Millimeters | | Inches | |
| | Min. | Max. | Min. | Max. |
| A | 5.75 | 6.25 | 0.226 | 0.246 |
| B | 6.90 | 7.40 | 0.272 | 0.291 |
| C | 2.75 | 3.25 | 0.108 | 0.128 |
| D | 0.95 | 1.52 | 0.037 | 0.060 |
| E | 7.70 | 8.20 | 0.303 | 0.323 |
| F | 0.051 | 0.203 | 0.002 | 0.008 |
| G | 0.15 | 0.31 | 0.006 | 0.012 |
| H | 2.15 | 2.62 | 0.085 | 0.103 |
| J | 2.40 | | 0.094 | |
| K | | 4.20 | | 0.165 |
| L | 3.30 | | 0.130 | |

REEL SPECIFICATION

| P/N | PKG | QTY |
|--------------------|-----|------|
| 1.5SMCXXXA(CA)(MS) | SMC | 3000 |

Attention

- Any and all MSKSEMI Semiconductor products described or contained herein do not have specifications that can handle applications that require extremely high levels of reliability, such as life-support systems, aircraft's control systems, or other applications whose failure can be reasonably expected to result in serious physical and/or material damage. Consult with your MSKSEMI Semiconductor representative nearest you before using any MSKSEMI Semiconductor products described or contained herein in such applications.
- MSKSEMI Semiconductor assumes no responsibility for equipment failures that result from using products at values that exceed, even momentarily, rated values (such as maximum ratings, operating condition ranges, or other parameters) listed in products specifications of any and all MSKSEMI Semiconductor products described or contained herein.
- Specifications of any and all MSKSEMI Semiconductor products described or contained herein stipulate the performance, characteristics, and functions of the described products in the independent state, and are not guarantees of the performance, characteristics, and functions of the described products as mounted in the customer's products or equipment. To verify symptoms and states that cannot be evaluated in an independent device, the customer should always evaluate and test devices mounted in the customer's products or equipment.
- MSKSEMI Semiconductor strives to supply high-quality high-reliability products. However, any and all semiconductor products fail with some probability. It is possible that these probabilistic failures could give rise to accidents or events that could endanger human lives, that could give rise to smoke or fire, or that could cause damage to other property. When designing equipment, adopt safety measures so that these kinds of accidents or events cannot occur. Such measures include but are not limited to protective circuits and error prevention circuits for safe design, redundant design, and structural design.
- In the event that any or all MSKSEMI Semiconductor products (including technical data, services) described or contained herein are controlled under any of applicable local export control laws and regulations, such products must not be exported without obtaining the export license from the authorities concerned in accordance with the above law.
- No part of this publication may be reproduced or transmitted in any form or by any means, electronic or mechanical, including photocopying and recording, or any information storage or retrieval system, or otherwise, without the prior written permission of MSKSEMI Semiconductor.
- Information (including circuit diagrams and circuit parameters) herein is for example only ; it is not guaranteed for volume production. MSKSEMI Semiconductor believes information herein is accurate and reliable, but no guarantees are made or implied regarding its use or any infringements of intellectual property rights or other rights of third parties.
- Any and all information described or contained herein are subject to change without notice due to product/technology improvement, etc. When designing equipment, refer to the "Delivery Specification" for the MSKSEMI Semiconductor product that you intend to use.

X-ON Electronics

Largest Supplier of Electrical and Electronic Components

Click to view similar products for [ESD Suppressors / TVS Diodes](#) category:

Click to view products by [MSKSEMI](#) manufacturer:

Other Similar products are found below :

[60KS200C](#) [D18V0L1B2LP-7B](#) [D5V0F4U5P5-7](#) [NTE4902](#) [P4KE27CA](#) [P6KE11CA](#) [P6KE8.2A](#) [SA60CA](#) [SA64CA](#) [SMBJ12CATR](#)
[SMBJ33CATR](#) [SMBJ6.5A](#) [SMBJ8.0A](#) [ESD101-B1-02ELS E6327](#) [ESD112-B1-02EL E6327](#) [ESD7451N2T5G](#) [19180-510](#) [CPDT-5V0USP-](#)
[HF](#) [3.0SMCJ33CA-F](#) [3.0SMCJ36A-F](#) [HSPC16701B02TP](#) [JANTX1N6126A](#) [D3V3Q1B2DLP3-7](#) [D55V0M1B2WS-7](#) [SCM1293A-04SO](#)
[ESD200-B1-CSP0201 E6327](#) [SM12-7](#) [CEN955 W/DATA](#) [VESD12A1A-HD1-GS08](#) [CPDQC5V0-HF](#) [D1213A-01LP4-7B](#) [ESD101-B1-02EL](#)
[E6327](#) [AOZ8808DI-03](#) [5KP15A](#) [5KP48A](#) [5KP90A](#) [ESD3V3D7-TP](#) [15KPA36A-LF](#) [P4KE56CA](#) [P4KE68A](#) [P4KE91CATR](#) [P6KE120A](#)
[P6KE13CA](#) [P6KE43CA](#) [P6KE6.8CA](#) [P6KE8.2](#) [P6SMBJ20CA](#) [JANTX1N6072A](#) [SR2835ESKG](#) [SA90CA](#)