

MSKSEMI 美森科

SEMICONDUCTOR



ESD



TVS



TSS



MOV



GDT



PLED

AON6236-MS

Product specification

Description

The AON6236-MS uses advanced trench technology to provide excellent RDS(ON) , low gate charge and operation with gate voltages as low as 4.5V. This device is suitable for use as a Battery protection or in other Switching application.

Features



$V_{DS} = 40V$ $I_D = 50A$

$R_{DS(ON)} < 14m\Omega$ $V_{GS} = 10V$

Application

- Battery protection
- Load switch
- Uninterruptible power supply

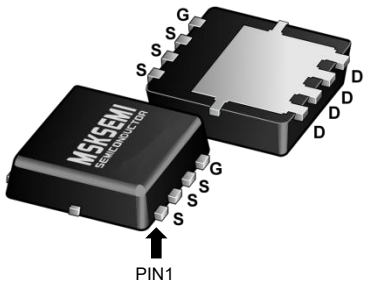
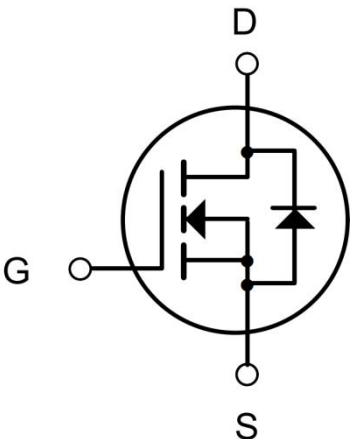
Reference News

PACKAGE OUTLINE	N-Channel MOSFET	Marking
 <p>DFN5X6-8L</p>		

Absolute Maximum Ratings (TC=25°C unless otherwise noted)

Symbol	Parameter	Rating	Units
V_{DS}	Drain- Source Voltage	40	V
V_{GS}	Gate- Source Voltage	± 20	V
$I_D @ T_C = 25^\circ C$	Continuous Drain Current, $V_{GS} @ 10V$ ¹	50	A
$I_D @ T_C = 100^\circ C$	Continuous Drain Current, $V_{GS} @ 10V$ ¹	38	A
I_{DM}	Pulsed Drain Current ²	160	A
EAS	Single Pulse Avalanche Energy ³	50	mJ
T_{STG}	Storage Temperature Range	-55 to 175	°C
T_J	Operating Junction Temperature Range	-55 to 175	°C

Thermal Characteristic

Thermal Resistance, Junction-to-Case ^(Note 2)	R _{θJC}	1.76	°C/W
--	------------------	------	------

Electrical Characteristics (TA=25°C unless otherwise noted)

Symbol	Parameter	Test Condition	Min.	Typ.	Max.	Units
Off Characteristic						
V _{(BR)DSS}	Drain-Source Breakdown Voltage	V _{GS} =0V, I _D =250μA	40	-	-	V
I _{DSS}	Zero Gate Voltage Drain Current	V _{DS} =40V, V _{GS} = 0V,	-	-	1	μA
I _{GSS}	Gate to Body Leakage Current	V _{DS} =0V, V _{GS} = ±20V	-	-	±100	μA
On Characteristics						
V _{GS(th)}	Gate Threshold Voltage	V _{DS} =V _{GS} , I _D =250μA	1.0	1.6	2.5	V
R _{DS(on)}	Static Drain-Source on-Resistance	V _{GS} =10V, I _D =30A	-	11	14	mΩ
g _{FS}	Forward Transconductance	V _{DS} =5V, I _D =20A	30	-	-	S
Dynamic Characteristics ^(Note 4)						
C _{iss}	Input Capacitance	V _{DS} =25V, V _{GS} =0V, f=1.0MHz	-	1540	-	pF
C _{oss}	Output Capacitance		-	171	-	pF
C _{rss}	Reverse Transfer Capacitance		-	115	-	pF
Switching Characteristics ^(Note 4)						
t _{d(on)}	Turn-on Delay Time	V _{DD} =20V, I _D =20A, R _L =1Ω	-	5	-	ns
t _r	Turn-on Rise Time		-	24	-	ns
t _{d(off)}	Turn-off Delay Time		-	38	-	ns
t _f	Turn-off Fall Time	V _{GS} =10V, R _{GEN} =3Ω	-	12	-	ns
Q _g	Total Gate Charge	V _{DS} =30V, I _D =30A, V _{GS} =10V	-	24	-	nC
Q _{gs}	Gate-Source Charge		-	5.9	-	nC
Q _{gd}	Gate-Drain Charge		-	3.6	-	nC
Drain-Source Diode Characteristics and Maximum Ratings						
I _S	Drain Forward Current ^(Note 2)		-	-	48	A
V _{SD}	Drain Forward Current ^(Note 3)	V _{GS} =0V, I _S =30A	-	-	1.2	V
t _{rr}	Reverse Recovery Time	T _J =25°C, I _F =30A	-	9	-	ns
Q _{rr}	Reverse Recovery Charge	di/dt=100A/μs ^(Note 3)	-	15	-	nC
t _{on}	Forward Turn-On Time	Intrinsic turn-on time is negligible(turn-on is dominated br LS+LD)				

Notes:

1. Repetitive Rating: Pulse width limited by maximum junction temperature.
2. Surface Mounted on FR4 Board, t_s≤10 sec.
3. Pulse Test: Pulse Width ≤ 300μs, Duty Cycle≤2%.
4. Guaranteed by design, not subject to production
5. EAS condition: T_J=25°C, V_{DD}=30V, V_G=10V, L=0.5mH, R_g=25Ω

Test circuit

1) E_{AS} test Circuits

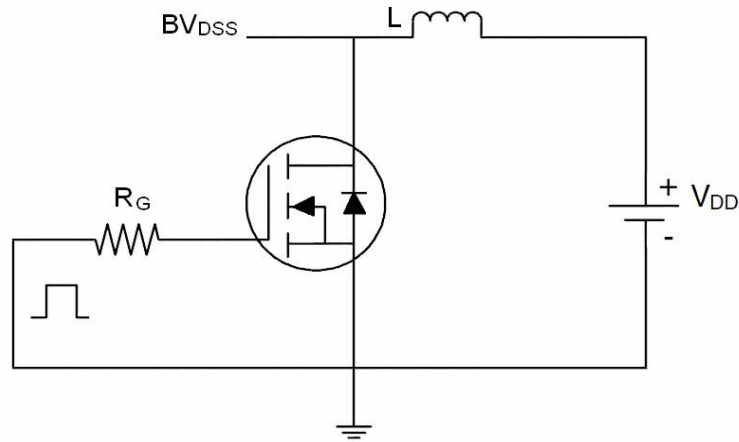

2) Gate charge test Circuit

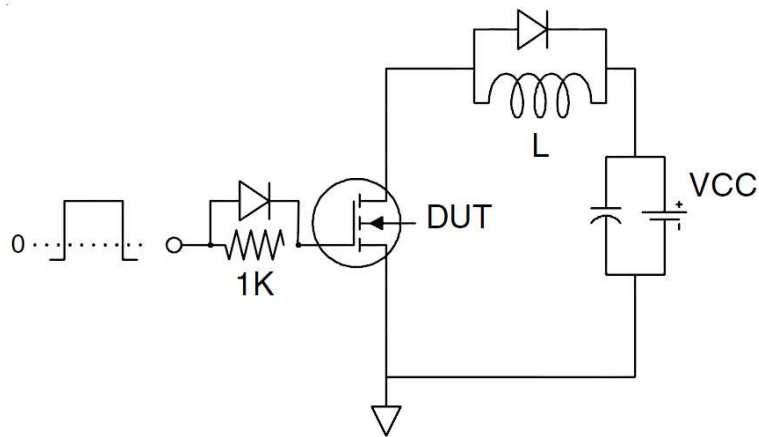

3) Switch Time Test Circuit

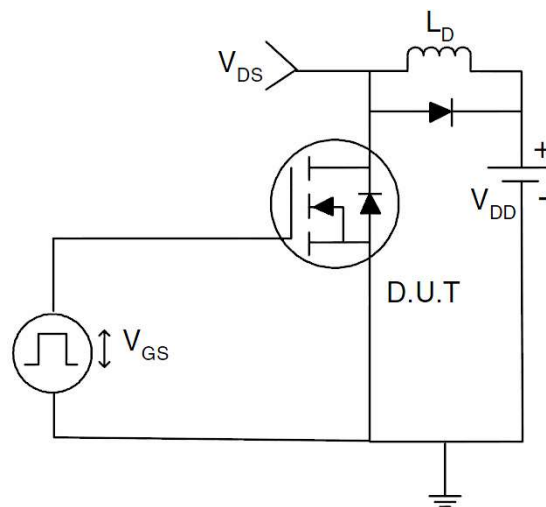

Typical Characteristics

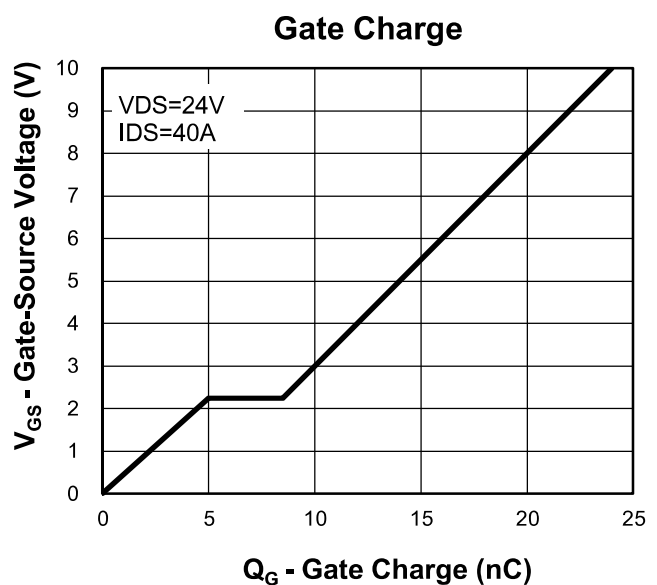
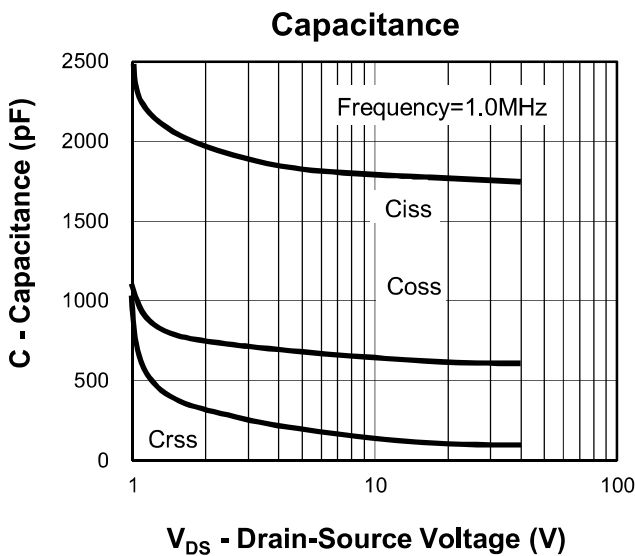
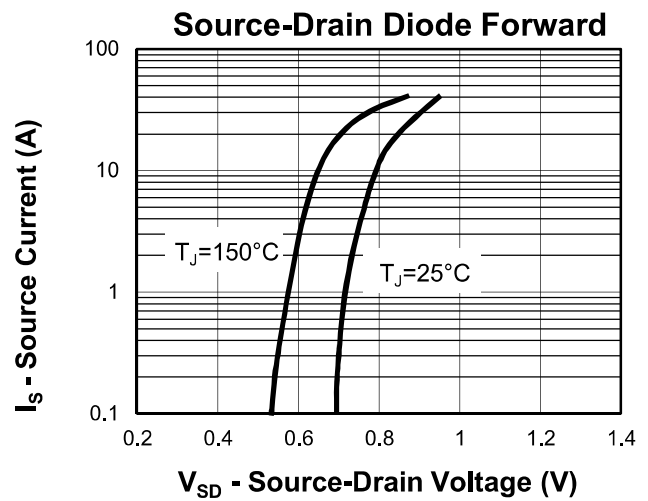
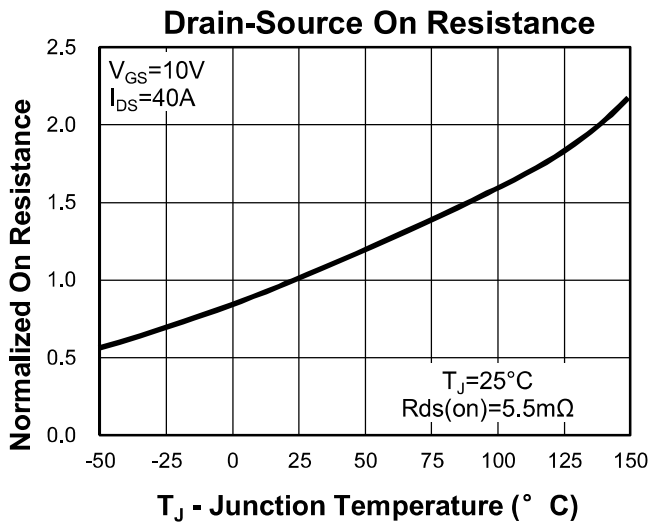
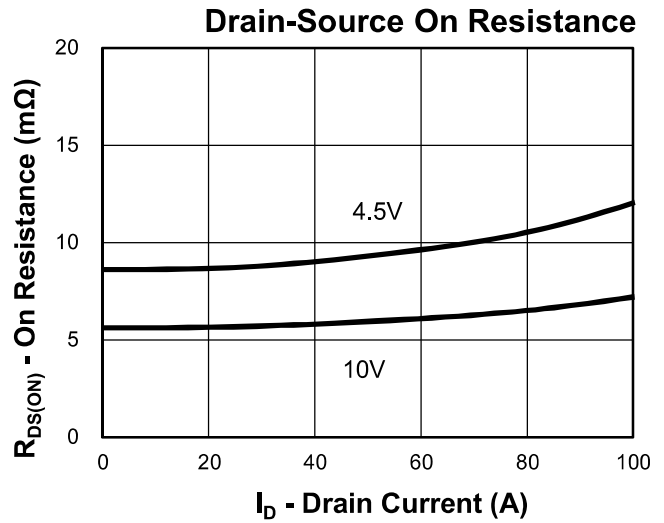
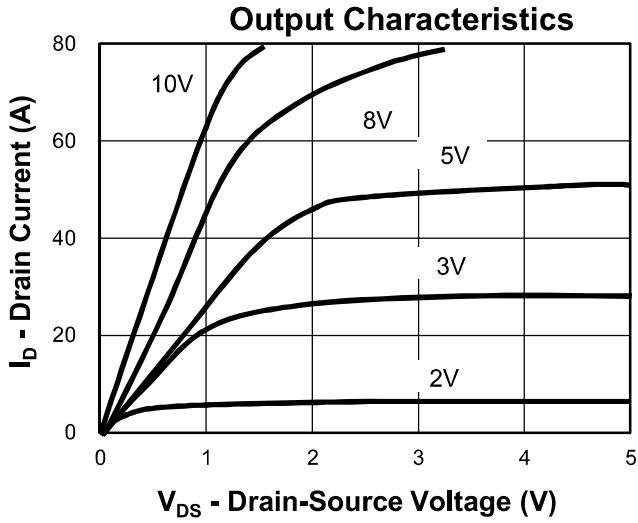

Typical Characteristics

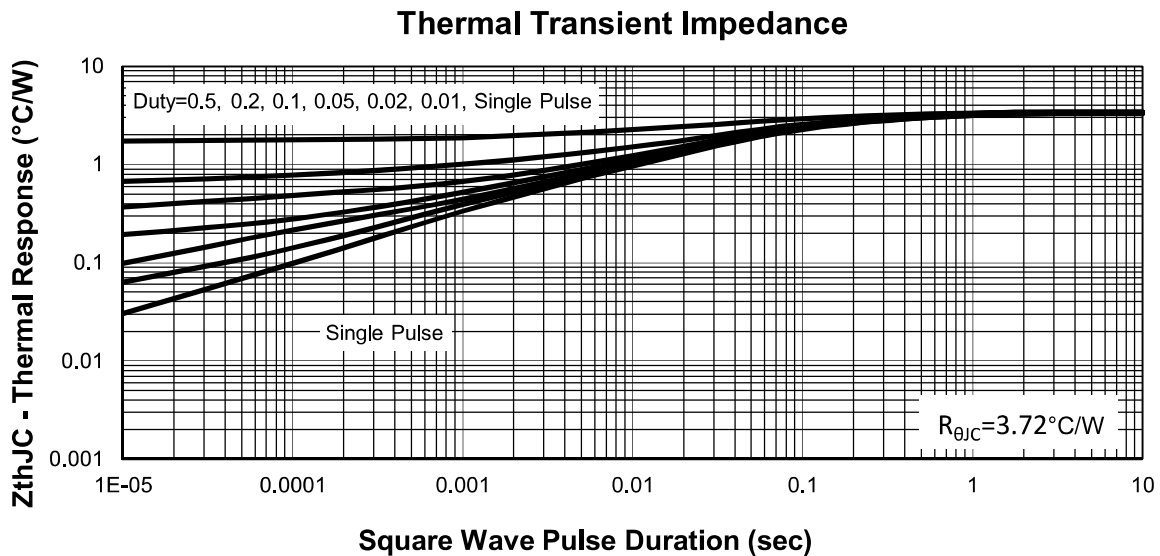
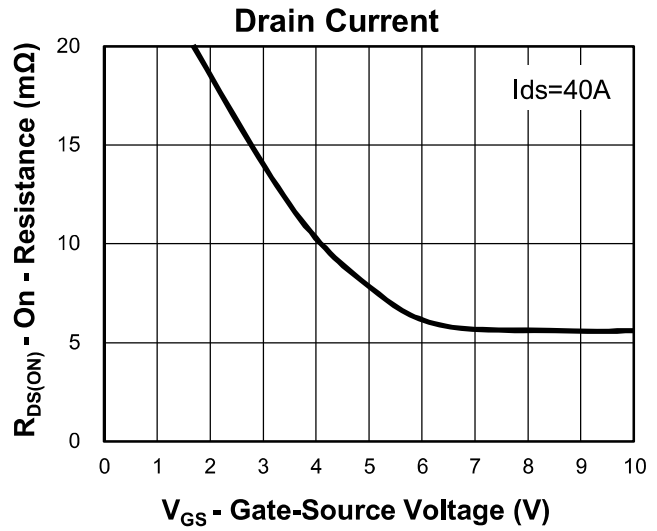
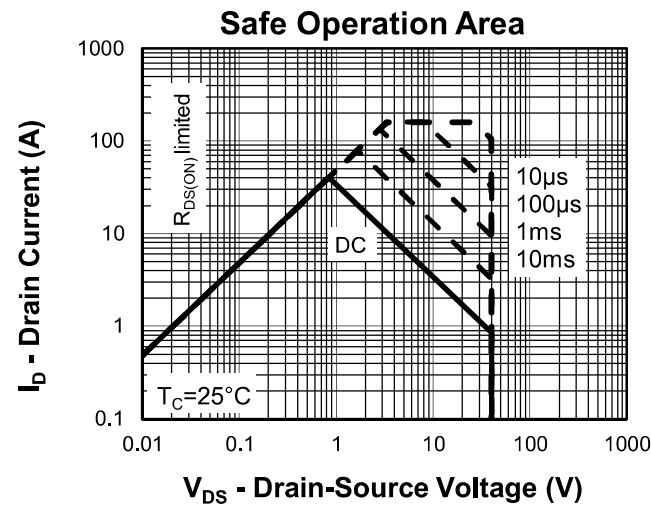
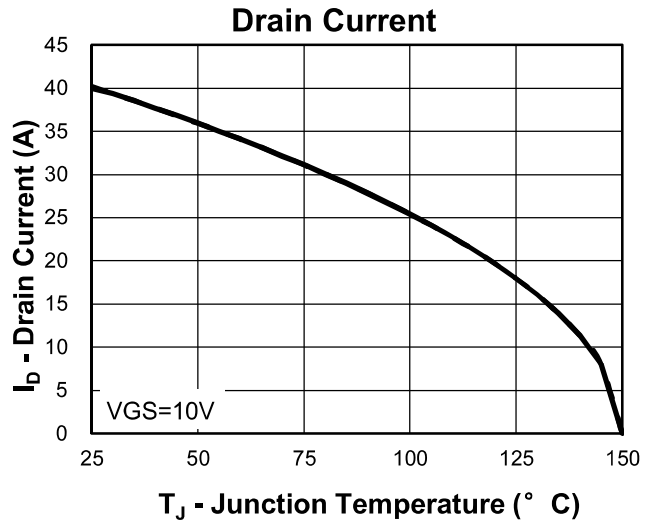
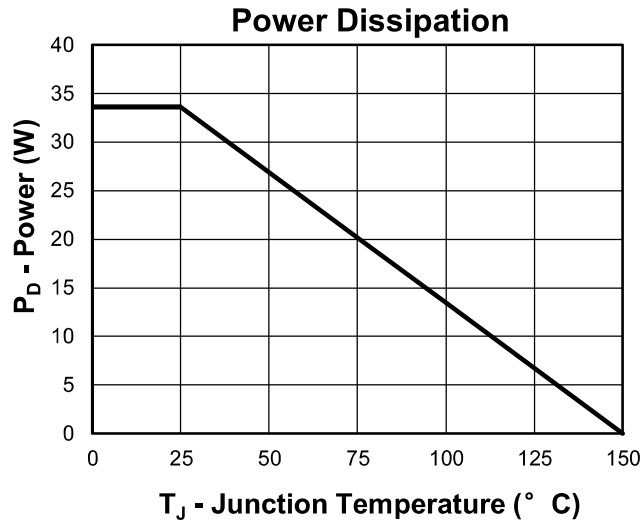

DFN5X6-8L Package Information

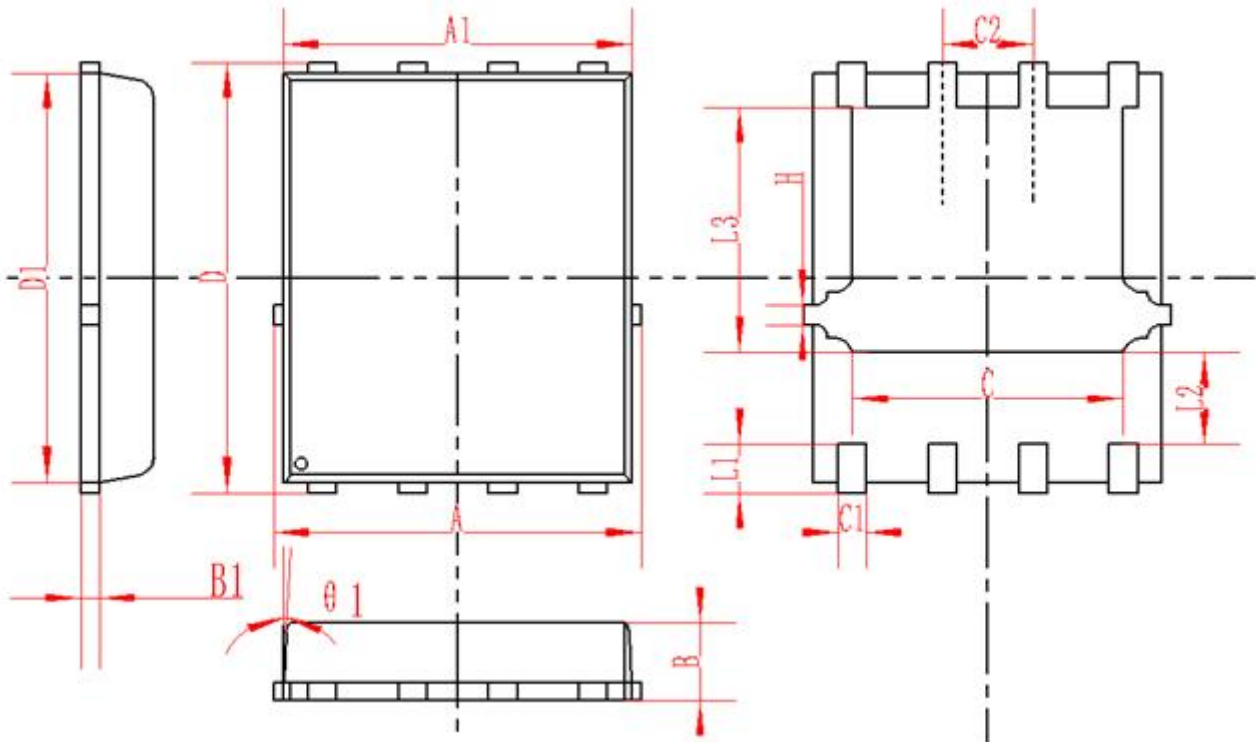

SYMBOL	MM			INCH		
	MIN	NOM	MAX	MIN	NOM	MAX
A	4.95	5	5.05	0.195	0.197	0.199
A1	4.82	4.9	4.98	0.190	0.193	0.196
D	5.98	6	6.02	0.235	0.236	0.237
D1	5.67	5.75	5.83	0.223	0.226	0.230
B	0.9	0.95	1	0.035	0.037	0.039
B1	0.254REF			0.010REF		
C	3.95	4	4.05	0.156	0.157	0.159
C1	0.35	0.4	0.45	0.014	0.016	0.018
C2	1.27TYP			0.5TYP		
$\theta 1$	8°	10°	12°	8°	10°	12°
L1	0.63	0.64	0.65	0.025	0.025	0.026
L2	1.2	1.3	1.4	0.047	0.051	0.055
L3	3.415	3.42	3.425	0.134	0.135	0.135
H	0.24	0.25	0.26	0.009	0.010	0.010

REEL SPECIFICATION

P/N	PKG	QTY
AON6236-MS	DFN5X6-8L	5000

Attention

- Any and all MSKSEMI Semiconductor products described or contained herein do not have specifications that can handle applications that require extremely high levels of reliability, such as life-support systems, aircraft's control systems, or other applications whose failure can be reasonably expected to result in serious physical and/or material damage. Consult with your MSKSEMI Semiconductor representative nearest you before using any MSKSEMI Semiconductor products described or contained herein in such applications.
- MSKSEMI Semiconductor assumes no responsibility for equipment failures that result from using products at values that exceed, even momentarily, rated values (such as maximum ratings, operating condition ranges, or other parameters) listed in products specifications of any and all MSKSEMI Semiconductor products described or contained herein.
- Specifications of any and all MSKSEMI Semiconductor products described or contained herein stipulate the performance, characteristics, and functions of the described products in the independent state, and are not guarantees of the performance, characteristics, and functions of the described products as mounted in the customer's products or equipment. To verify symptoms and states that cannot be evaluated in an independent device, the customer should always evaluate and test devices mounted in the customer's products or equipment.
- MSKSEMI Semiconductor strives to supply high-quality high-reliability products. However, any and all semiconductor products fail with some probability. It is possible that these probabilistic failures could give rise to accidents or events that could endanger human lives, that could give rise to smoke or fire, or that could cause damage to other property. When designing equipment, adopt safety measures so that these kinds of accidents or events cannot occur. Such measures include but are not limited to protective circuits and error prevention circuits for safe design, redundant design, and structural design.
- In the event that any or all MSKSEMI Semiconductor products (including technical data, services) described or contained herein are controlled under any of applicable local export control laws and regulations, such products must not be exported without obtaining the export license from the authorities concerned in accordance with the above law.
- No part of this publication may be reproduced or transmitted in any form or by any means, electronic or mechanical, including photocopying and recording, or any information storage or retrieval system, or otherwise, without the prior written permission of MSKSEMI Semiconductor.
- Information (including circuit diagrams and circuit parameters) herein is for example only ; it is not guaranteed for volume production. MSKSEMI Semiconductor believes information herein is accurate and reliable, but no guarantees are made or implied regarding its use or any infringements of intellectual property rights or other rights of third parties.
- Any and all information described or contained herein are subject to change without notice due to product/technology improvement, etc. When designing equipment, refer to the "Delivery Specification" for the MSKSEMI Semiconductor product that you intend to use.

X-ON Electronics

Largest Supplier of Electrical and Electronic Components

Click to view similar products for [MOSFET](#) category:

Click to view products by [MSKSEMI](#) manufacturer:

Other Similar products are found below :

[IRFD120](#) [JANTX2N5237](#) [2SK2267\(Q\)](#) [BUK455-60A/B](#) [TK100A10N1,S4X\(S](#) [MIC4420CM-TR](#) [VN1206L](#) [NDP4060](#) [SI4482DY](#)
[IRS2092STRPBF-EL](#) [IPS70R2K0CEAKMA1](#) [TK31J60W5,S1VQ\(O](#) [TK31J60W,S1VQ\(O](#) [TK16J60W,S1VQ\(O](#) [2SK2614\(TE16L1,Q\)](#)
[DMN1017UCP3-7](#) [EFC2J004NUZTDG](#) [P85W28HP2F-7071](#) [DMN1053UCP4-7](#) [NTE2384](#) [DMC2700UDMQ-7](#) [DMN2080UCB4-7](#)
[DMN61D9UWQ-13](#) [US6M2GTR](#) [DMN31D5UDJ-7](#) [DMP22D4UFO-7B](#) [IPS60R3K4CEAKMA1](#) [DMN1006UCA6-7](#) [DMN16M9UCA6-7](#)
[STF5N65M6](#) [IRF40H233XTMA1](#) [STU5N65M6](#) [DMN6022SSD-13](#) [DMN13M9UCA6-7](#) [DMTH10H4M6SPS-13](#) [IPS60R360PFD7SAKMA1](#)
[DMN2990UFB-7B](#) [SSM3K35CT,L3F](#) [IPLK60R1K0PFD7ATMA1](#) [2N7002W-G](#) [MCAC30N06Y-TP](#) [IPWS65R035CFD7AXKSA1](#)
[MCQ7328-TP](#) [SSM3J143TU,LXHF](#) [DMN12M3UCA6-7](#) [PJMF280N65E1_T0_00201](#) [PJMF380N65E1_T0_00201](#)
[PJMF280N60E1_T0_00201](#) [PJMF600N65E1_T0_00201](#) [PJMF900N65E1_T0_00201](#)