

MSKSEMI 美森科

SEMICONDUCTOR



ESD



TVS



TSS



MOV



GDT



PLED

AZ1117H-XXXTRE1-MS

Product specification

概述

AZ1117H-XXXTRE1-MS 是一款低压差的线性稳压器。







特点

- 包括三端可调输出和固定电压输出版本（固定电压包括 1.2V, 1.5V, 1.8V, 2.5V, 3.3V, 5V 等，其他电压规格可根据用户定制）
- 最大输出电流为 1A
- 输出电压精度高达 ±2%
- 稳定工作电压范围为高达 12V
- 电压线性度为 0.2%
- 负载线性度为 0.4%
- 环境温度：T_A 的范围是 -20°C ~ 125°C

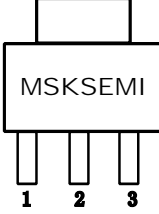
用途

- 计算机主板、显卡
- LCD 监视器及 LCD TV
- DVD 解码板
- ADSL 等设备
- 开关电源的后级稳压

包装和订单信息

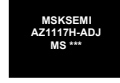
产品编号	输出电压	封装		引脚排列	管体标记	最小包装 (PCS)
AZ1117H-1.2TRE1-MS	1.2V	SOT-223				2500
AZ1117H-1.5TRE1-MS	1.5V					2500
AZ1117H-1.8TRE1-MS	1.8V					2500
AZ1117H-2.5TRE1-MS	2.5V					2500
AZ1117H-3.3TRE1-MS	3.3V					2500
AZ1117H-5.0TRE1-MS	5.0V					2500
AZ1117H-ADJTRE1-MS	ADJ					2500

注：***代表内部生产批号

引脚定义

引脚号	符号	定义
1	GND	接地脚
2	Vout	输出端
3	Vin	输入端

固定电
压型

引脚号	符号	定义
1	Adj.	可调端
2	Vout	输出端
3	Vin	输入端

可调电
压型

极限值

参数名称	符号	数值	单位
最大输入电压	V _{in}	18	V
最大结温	T _J	125	°C
最大环境温度	T _A	125	°C
贮存温度	T _s	-65~+150	°C
焊接温度和时间		300°C,10S	

推荐工作条件

名称	最小	推荐	最大	单位
输入电压范围			15	V
工作环境温度	0		125	°C

功能图

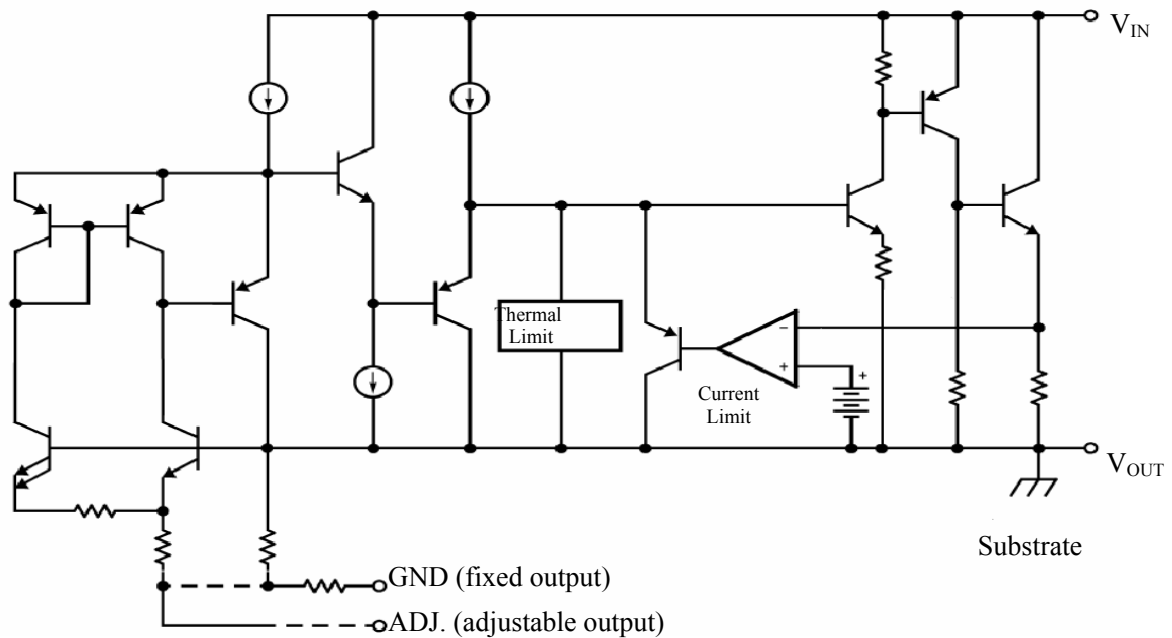

主要参数和工作特性

Tj=25°C

参数	参数说明	条件	最小值	典型值	最大值	单位
Vref	参考电压	I _{out} =10mA, V _{in} -V _{out} =2V 10mA ≤ I _{out} ≤ 1A, 1.5V ≤ V _{in} -V _{out} ≤ 10V	1.225	1.25	1.275	V
Vout	输出电压	AZ1117H-1.2TRE1-MS 10mA ≤ I _{out} ≤ 1A, 2.7V ≤ V _{in} ≤ 10V	1.176	1.2	1.224	V
		AZ1117H-1.5TRE1-MS 10mA ≤ I _{out} ≤ 1A, 3.0V ≤ V _{in} ≤ 10V	1.47	1.5	1.53	V
		AZ1117H-1.8TRE1-MS 10mA ≤ I _{out} ≤ 1A, 3.25V ≤ V _{in} ≤ 10V	1.764	1.80	1.836	V
		AZ1117H-2.5TRE1-MS 10mA ≤ I _{out} ≤ 1A, 3.9 V ≤ V _{in} ≤ 10V	2.45	2.50	2.55	V
		AZ1117H-3.3TRE1-MS 10mA ≤ I _{out} ≤ 1A, 5.3 V ≤ V _{in} ≤ 12V	3.235	3.3	3.365	V
		AZ1117H-5.0TRE1-MS 10mA ≤ I _{out} ≤ 1A, 6.5V ≤ V _{in} ≤ 12V	4.9	5	5.1	V
ΔVout	电压线性度	AZ1117H-ADJTRE1-MS I _{out} =10mA, V ≤ V _{in} -V _{out} ≤ 10V		5	18	mV
		AZ1117H-1.2TRE1-MS I _{out} =10mA, 2.7V ≤ V _{in} ≤ 10V		5	18	mV
		AZ1117H-1.5TRE1-MS I _{out} =10mA, 2.75V ≤ V _{in} ≤ 10V		5	18	mV
		AZ1117H-1.8TRE1-MS I _{out} =10mA, 3.25V ≤ V _{in} ≤ 10V		5	18	mV
		AZ1117H-2.5TRE1-MS I _{out} =10mA, 3.9V ≤ V _{in} ≤ 10V		5	18	mV
		AZ1117H-3.3TRE1-MS I _{out} =10mA, 5.3 V ≤ V _{in} ≤ 12V		9	18	mV
ΔVout	负载线性度	AZ1117H-ADJTRE1-MS V _{in} = 3.25V, 10mA ≤ I _{out} ≤ 1A		9	18	mV
		AZ1117H-1.2TRE1-MS V _{in} = 2.7V, 10mA ≤ I _{out} ≤ 1A		9	18	mV
		AZ1117H-1.5TRE1-MS V _{in} = 3.25V, 10mA ≤ I _{out} ≤ 1A		9	18	mV

主要参数和工作特性

		AZ1117H-1.8TRE1-MS Vin = 3.25V, 10mA ≤ Iout ≤ 1A		10	18	mV
		AZ1117H-2.5TRE1-MS Vin = 4.5 V, 10mA ≤ Iout ≤ 1A		10	18	mV
		AZ1117H-3.3TRE1-MS Vin = 5.3V, 0 ≤ Iout ≤ 1A		12	20	mV
		AZ1117H-5.0TRE1-MS Vin = 6.5V, 0 ≤ Iout ≤ 1A		12	20	mV
Vin-Vout	最小输入输出电压差	ΔVout, ΔVref, =1%, Iout=1A			1.4	V
Ilimit	最小负载电流	AZ1117H-ADJTRE1-MS			10	mA
Iq	静态电流	AZ1117H-ADJTRE1-MS, Vin = 4.0V			12	mA
		AZ1117H-1.2TRE1-MS, Vin = 4.8V			12	mA
		AZ1117H-1.5TRE1-MS, Vin = 4.8V			12	mA
		AZ1117H-1.8TRE1-MS, Vin = 4.8V			12	mA
		AZ1117H-2.5TRE1-MS, Vin = 4.8V			12	mA
		AZ1117H-3.3TRE1-MS, Vin = 4.8V			12	mA
		AZ1117H-5.0TRE1-MS, Vin = 4.8V			12	mA

封装信息

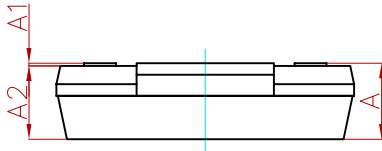
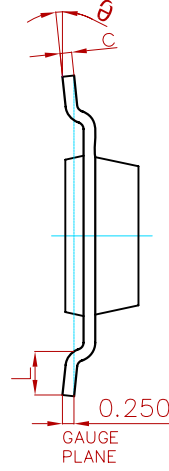
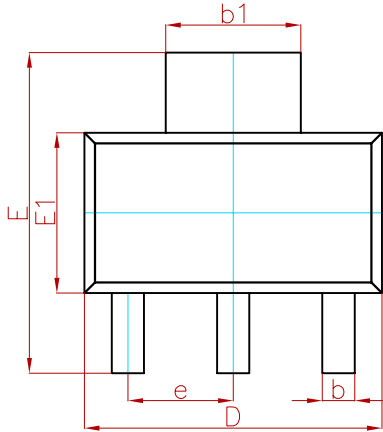

Symbol	Dimensions In Millimeters		Dimensions In Inches	
	Min.	Max.	Min.	Max.
A	—	1.800	—	0.071
A1	0.020	0.100	0.001	0.004
A2	1.500	1.700	0.059	0.067
b	0.660	0.840	0.026	0.033
b_1	2.900	3.100	0.114	0.122
c	0.230	0.350	0.009	0.014
D	6.300	6.700	0.248	0.264
E	6.700	7.300	0.264	0.287
E1	3.300	3.700	0.130	0.146
e	2.300(BSC)		0.091(BSC)	
L	0.750	—	0.030	—
θ	0°	10°	0°	10°

焊盘布局建议

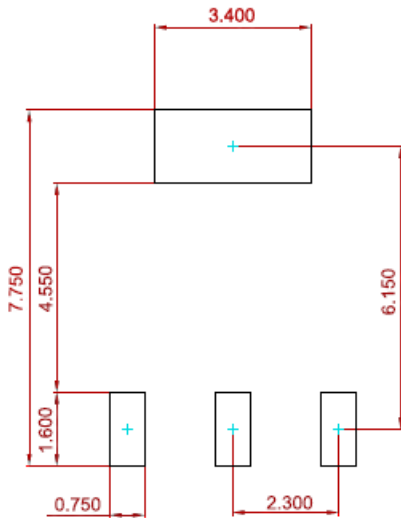

Note:

1. Controlling dimension: in millimeters.
2. General tolerance: ± 0.050 mm.
3. The pad layout is for reference purposes only.

Attention

- Any and all MSKSEMI Semiconductor products described or contained herein do not have specifications that can handle applications that require extremely high levels of reliability, such as life-support systems, aircraft's control systems, or other applications whose failure can be reasonably expected to result in serious physical and/or material damage. Consult with your MSKSEMI Semiconductor representative nearest you before using any MSKSEMI Semiconductor products described or contained herein in such applications.
- MSKSEMI Semiconductor assumes no responsibility for equipment failures that result from using products at values that exceed, even momentarily, rated values (such as maximum ratings, operating condition ranges, or other parameters) listed in products specifications of any and all MSKSEMI Semiconductor products described or contained herein.
- Specifications of any and all MSKSEMI Semiconductor products described or contained herein stipulate the performance, characteristics, and functions of the described products in the independent state, and are not guarantees of the performance, characteristics, and functions of the described products as mounted in the customer's products or equipment. To verify symptoms and states that cannot be evaluated in an independent device, the customer should always evaluate and test devices mounted in the customer's products or equipment.
- MSKSEMI Semiconductor strives to supply high-quality high-reliability products. However, any and all semiconductor products fail with some probability. It is possible that these probabilistic failures could give rise to accidents or events that could endanger human lives, that could give rise to smoke or fire, or that could cause damage to other property. When designing equipment, adopt safety measures so that these kinds of accidents or events cannot occur. Such measures include but are not limited to protective circuits and error prevention circuits for safe design, redundant design, and structural design.
- In the event that any or all MSKSEMI Semiconductor products (including technical data, services) described or contained herein are controlled under any of applicable local export control laws and regulations, such products must not be exported without obtaining the export license from the authorities concerned in accordance with the above law.
- No part of this publication may be reproduced or transmitted in any form or by any means, electronic or mechanical, including photocopying and recording, or any information storage or retrieval system, or otherwise, without the prior written permission of MSKSEMI Semiconductor.
- Information (including circuit diagrams and circuit parameters) herein is for example only ; it is not guaranteed for volume production. MSKSEMI Semiconductor believes information herein is accurate and reliable, but no guarantees are made or implied regarding its use or any infringement of intellectual property rights or other rights of third parties.
- Any and all information described or contained herein are subject to change without notice due to product/technology improvement, etc. When designing equipment, refer to the "Delivery Specification" for the MSKSEMI Semiconductor product that you intend to use.

X-ON Electronics

Largest Supplier of Electrical and Electronic Components

Click to view similar products for [Linear Voltage Regulators](#) category:

Click to view products by [MSKSEMI](#) manufacturer:

Other Similar products are found below :

[LV5684PVD-XH](#) [MCDTSA6-2R](#) [L7815ACV-DG](#) [714954EB](#) [ZMR500QFTA](#) [BA033LBSG2-TR](#) [LV5680P-E](#) [L79M05T-E](#) [L78LR05D-MA-E](#) [NCV317MBTG](#) [NTE7227](#) [MP2018GZD-33-P](#) [MP2018GZD-5-P](#) [LV5680NPVC-XH](#) [LT1054CN8](#) [UA78L09CLP](#) [UA78L09CLPR](#) [CAT6221-PPTD-GT3](#) [MC78M09CDTRK](#) [NCV51190MNTAG](#) [78M05](#) [HT7150-1](#) [UM1540DB-18](#) [XC6234H281VR-G](#) [WL2834CA-6/TR](#) [TPL730F33-5TR](#) [TLS850F1TA](#) [V50](#) [TPS549B22RVFR](#) [UM1540DB-33](#) [WL9200P3-50B](#) [WL9100P3-33B](#) [XC6219B152MR](#) [WL2855K33-3/TR](#) [PJ54BM33SE](#) [PJ9500M25SA](#) [MD7218E33PC1](#) [H7533-2PR](#) [SK7812AU](#) [SD1A30](#) [78L33](#) [TP78L33T3](#) [SK6513ST3A-50](#) [SK6054D4-09](#) [SK6054D4-18](#) [SK6054D4-11](#) [SK6054D4-10](#) [LM79L12F](#) [HLP2985AIM5X-5.0](#) [HLP2992AIM5X-5.0/NOPB](#) [HMIC5205-5.0YM5-TR](#)