

MSKSEMI 美森科

SEMICONDUCTOR



ESD



TVS



TSS



MOV



GDT



PLED

HT75XX-3-MS/HT75XX-3(MS)

Product specification

GENERAL DESCRIPTION

HT75XX-3-MS/HT75XX-3(MS) series are a set of Low Dropout Linear RegulatorICs implemented inCMOS technology.They can withstand voltage 30V.And they are available with lowvoltage drop andlow quiescent current,widely used in audio,video and communication appliances

FEATURES

- Low Power Consumption
- Low Voltage Drop
- Low Temperature Coefficient
- Withstanding Voltage 30V
- Quiescent Current 1.5μA
- Output Voltage Accuracy:tolerance±2%
- High output current:100mA

TYPICAL APPLICATIONS

- Battery-powered Equipments
- Communication Equipments
- Audio/Video Equipments

Reference News and Marking

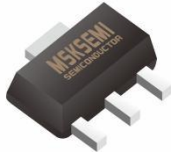
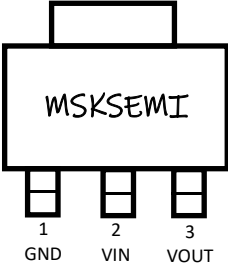
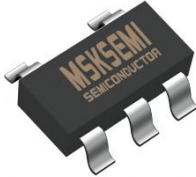
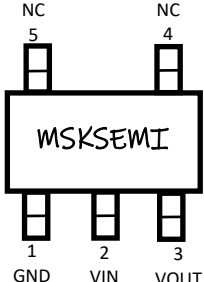
SOT-89		SOT-23-5	
			

HT7528-3-MS	HT7530-3-MS	HT7533-3-MS	HT7536-3-MS	HT7540-3-MS	HT7544-3-MS	HT7550-3-MS
MSKSEMI HT7528-3	MSKSEMI HT7530-3	MSKSEMI HT7533-3	MSKSEMI HT7536-3	MSKSEMI HT7540-3	MSKSEMI HT7544-3	MSKSEMI HT7550-3
HT7528-3(MS)	HT7530-3(MS)	HT7533-3(MS)	HT7536-3(MS)	HT7540-3(MS)	HT7544-3(MS)	HT7550-3(MS)
7528-3 MSK	7530-3 MSK	7533-3 MSK	7536-3 MSK	7540-3 MSK	7544-3 MSK	7550-3 MSK

NOTE:HT75XX-3-MS is SOT-89, HT75XX-3 (MS) is SOT-23-5.

PIN DESCRIPTION

PIN No.		Name	Functions Description
SOT23-5	SOT89		
1	1	GND	ground
2	2	VIN	input
3	3	Vout	output
4		NC	No Connect
5		NC	No Connect

Order information

Series	Output	Package	QTY	Series	Output	Package	QTY
HT7528-3-MS	2.8V	SOT-89-3	1000	HT7528-3(MS)	2.8V	SOT-23-5	3000
HT7530-3-MS	3.0V			HT7530-3(MS)	3.0V		
HT7533-3-MS	3.3V			HT7533-3(MS)	3.3V		
HT7536-3-MS	3.6V			HT7536-3(MS)	3.6V		
HT7540-3-MS	4.0V			HT7540-3(MS)	4.0V		
HT7544-3-MS	4.4V			HT7544-3(MS)	4.4V		
HT7550-3-MS	5.0V			HT7550-3(MS)	5.0V		

FUNCTIONAL BLOCK DIAGRAM

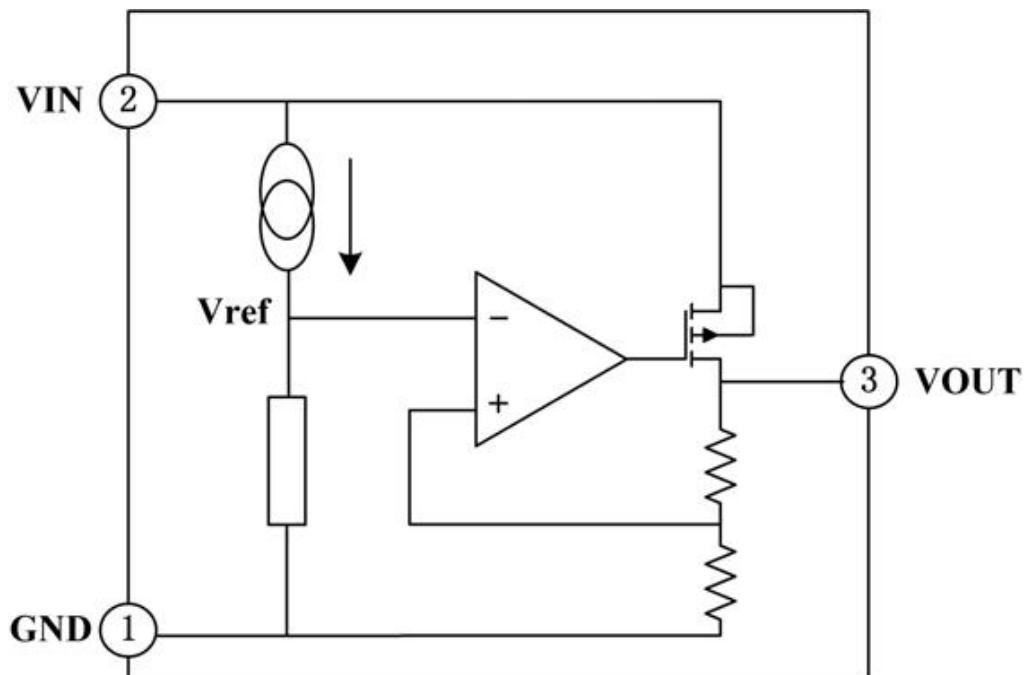

ABSOLUTE MAXIMUM RATINGS

Description	Symbol	Value range	Unit
LimitPowerVoltage	V _{IN}	-0.3~+33	V
Storage Temperature Range	T _{STG}	-50~+125	°C
Operating Free-air Temperature Range	T _A	-40~+85	°C

Note :Stresses greater than those listed under“Absolute Maximum Ratings”may cause permanent damage to the device.These are stress ratings only,and functional operation of the device at these or any other conditions beyond those indicated under“Recommended Operating Conditions”is not implied.Exposure to“Absolute Maximum Ratings”for extended periods may affect device reliability.

HEATDISSIPATION

Description	Symbol	Package	Value range	Unit
Thermal resistance	θ_{JA}	SOT89-3	200	°C/W
		SOT23-5	500	°C/W
Power dissipation	P _w	SOT89-3	500	mW
		SOT23-5	200	mW

DC CHARACTERISTICS(unless otherwise noted TA=+25°C)

Series HT7528-3-MS/HT7528-3(MS)

Parameter	Symbol	Test Condition	Min.	Typ.	Max.	Unit
Output Voltage	V _{OUT}	V _{IN} =V _{OUT} +2.0V, I _{OUT} =10mA	2.744	2.80	2.856	V
Output Current	I _{OUT}	V _{IN} =V _{OUT} +2.0V	70	100	—	mA
Load Regulation	ΔV_{OUT}	V _{IN} =V _{OUT} +2.0V 1mA≤I _{OUT} ≤50mA	—	25	60	mV
Voltage Drop	V _{DIF}	I _{OUT} =1mA,ΔV _{OUT} =2%	—	30	100	mV
Quiescent Current	I _{SS}	No Load	—	1.5	2.5	μA
Line Regulation	$\frac{\Delta V_{OUT}}{V_{OUT}} \cdot \frac{\Delta V_{IN}}{V_{IN}}$	V _{OUT} +1.0V≤V _{IN} ≤30V, I _{OUT} =1mA	—	—	0.2	%/V
Input Voltage	V _{IN}	—	—	—	30	V
Temperature Coefficient	$\frac{\Delta V_{OUT}}{\Delta T_A} \cdot V_{OUT}$	V _{OUT} +2.0V,I _{OUT} =10mA, -40C≤T _A ≤85°C	—	100	—	ppm/ °C

Note:WhenV_{in}=V_{OUT}+2.0V,as the output voltage declined 2%,the V_{DIF}=V_{in}-V_{OUT}.

Series HT7530-3-MS/HT7530-3(MS)

Parameter	Symbol	Test Condition	Min.	Typ.	Max.	Unit
Output Voltage	V _{OUT}	V _{IN} =V _{OUT} +2.0V, I _{OUT} =10mA	2.94	3.00	3.06	V
Output Current	I _{OUT}	V _{IN} =V _{OUT} +2.0V	70	100	—	mA
Load Regulation	ΔV _{OUT}	V _{IN} =V _{OUT} +2.0V 1mA≤I _{OUT} ≤50mA	—	25	60	mV
Voltage Drop	V _{DIF}	I _{OUT} =1mA, ΔV _{OUT} =2%	—	30	100	mV
Quiescent Current	I _{SS}	No Load	—	1.5	2.5	μA
Line Regulation	$\frac{\Delta V_{OUT}}{\Delta V_{IN}} \cdot V_{OUT}^*$	V _{OUT} +1.0V≤V _{IN} ≤30V, I _{OUT} =1mA	—	—	0.2	%/V
Input Voltage	V _{IN}	—	—	—	30	V
Temperature Coefficient	$\frac{\Delta V_{OUT}}{\Delta T_A} \cdot V_{OUT}$	V _{OUT} +2.0V, I _{OUT} =10mA, -40C≤T _A ≤85°C	—	100	—	ppm/ °C

Note:When V_{in}=V_{OUT}+2.0V, as the output voltage declined 2%, the V_{DIF}=V_{in}- V_{OUT}.

Series HT7533-3-MS/HT7533-3(MS)

Parameter	Symbol	Test Condition	Min.	Typ.	Max.	Unit
Output Voltage	V _{OUT}	V _{IN} =V _{OUT} +2.0V, I _{OUT} =10mA	3.234	3.30	3.366	V
Output Current	I _{OUT}	V _{IN} =V _{OUT} +2.0V	70	100	—	mA
Load Regulation	ΔV _{OUT}	V _{IN} =V _{OUT} +2.0V 1mA≤I _{OUT} ≤50mA	—	25	60	mV
Voltage Drop	V _{DIF}	I _{OUT} =1mA, ΔV _{OUT} =2%	—	25	55	mV
Quiescent Current	I _{SS}	No Load	—	1.5	2.5	μA
Line Regulation	$\frac{\Delta V_{OUT}}{\Delta V_{IN}} \cdot V_{OUT}^*$	V _{OUT} +1.0V≤V _{IN} ≤30V, I _{OUT} =1mA	—	—	0.2	%/V
Input Voltage	V _{IN}	—	—	—	30	V
Temperature Coefficient	$\frac{\Delta V_{OUT}}{\Delta T_A} \cdot V_{OUT}$	V _{OUT} +2.0V, I _{OUT} =10mA, -40C≤T _A ≤85°C	—	100	—	ppm/ °C

Note:When V_{in}=V_{OUT}+2.0V, as the output voltage declined 2%, the V_{DIF}=V_{in}-V_{OUT}.

Series HT7536-3-MS/HT7536-3(MS)

Parameter	Symbol	Test Condition	Min.	Typ.	Max.	Unit
Output Voltage	V _{OUT}	V _{IN} =V _{OUT} +2.0V, I _{OUT} =10mA	3.528	3.60	3.672	V
Output Current	I _{OUT}	V _{IN} =V _{OUT} +2.0V	70	100	—	mA
Load Regulation	ΔV _{OUT}	V _{IN} =V _{OUT} +2.0V I _{mA} ≤I _{OUT} ≤50mA	—	25	60	mV
Voltage Drop	V _{DIF}	I _{OUT} =1mA, ΔV _{OUT} =2%	—	25	55	mV
Quiescent Current	I _{SS}	No Load	—	1.5	2.5	μA
Line Regulation	$\frac{\Delta V_{OUT}}{V_{OUT}} \cdot \frac{\Delta V_{IN}}{\Delta V_{IN}}$	V _{OUT} +1.0V≤V _{IN} ≤30V, I _{OUT} =1mA	—	—	0.2	%/V
Input Voltage	V _{IN}	—	—	—	30	V
Temperature Coefficient	$\frac{\Delta V_{OUT}}{\Delta T_A} \cdot V_{OUT}$	V _{OUT} +2.0V, I _{OUT} =10mA, -40C≤T _A ≤85°C	—	100	—	ppm/ °C

Note: When V_{IN}=V_{OUT}+2.0V, as the output voltage declined 2%, the V_{DIF}=V_{IN}-V_{OUT}.

Series HT7540-3-MS/HT7540-3(MS)

Parameter	Symbol	Test Condition	Min.	Typ.	Max.	Unit
Output Voltage	V _{OUT}	V _{IN} =V _{OUT} +2.0V, I _{OUT} =10mA	3.92	4.0	4.08	V
Output Current	I _{OUT}	V _{IN} =V _{OUT} +2.0V	70	100	—	mA
Load Regulation	ΔV _{OUT}	V _{IN} =V _{OUT} +2.0V I _{mA} ≤I _{OUT} ≤50mA	—	25	60	mV
Voltage Drop	V _{DIF}	I _{OUT} =1mA, ΔV _{OUT} =2%	—	25	55	mV
Quiescent Current	I _{SS}	No Load	—	1.5	2.5	μA
Line Regulation	$\frac{\Delta V_{OUT}}{V_{OUT}} \cdot \frac{\Delta V_{IN}}{\Delta V_{IN}}$	V _{OUT} +1.0V≤V _{IN} ≤30V, I _{OUT} =1mA	—	—	0.2	%/V
Input Voltage	V _{IN}	—	—	—	30	V
Temperature Coefficient	$\frac{\Delta V_{OUT}}{\Delta T_A} \cdot V_{OUT}$	V _{OUT} +2.0V, I _{OUT} =10mA, -40C≤T _A ≤85°C	—	100	—	ppm/ °C

Note: When V_{IN}=V_{OUT}+2.0V, as the output voltage declined 2%, the V_{DIF}=V_{IN}-V_{OUT}.

Series HT7544-3-MS/HT7544-3(MS)

Parameter	Symbol	Test Condition	Min.	Typ.	Max.	Unit
Output Voltage	V _{OUT}	V _{IN} =V _{OUT} +2.0V, I _{OUT} =10mA	4.312	4.4	4.488	V
Output Current	I _{OUT}	V _{IN} =V _{OUT} +2.0V	70	100	—	mA
Load Regulation	ΔV _{OUT}	V _{IN} =V _{OUT} +2.0V 1mA≤I _{OUT} ≤50mA	—	25	60	mV
Voltage Drop	V _{DIF}	I _{OUT} =1mA,ΔV _{OUT} =2%	—	25	55	mV
Quiescent Current	I _{SS}	No Load	—	1.5	2.5	μA
Line Regulation	$\frac{\Delta V_{OUT}}{V_{OUT}} \cdot \frac{\Delta V_{IN}}{\Delta V_{IN}}$	V _{OUT} +1.0V≤V _{IN} ≤30V, I _{OUT} =1mA	—	—	0.2	%/V
Input Voltage	V _{IN}	—	—	—	30	V
Temperature Coefficient	$\frac{\Delta V_{OUT}}{\Delta T_A} \cdot V_{OUT}$	V _{OUT} +2.0V,I _{OUT} =10mA, -40C≤T _A ≤85°C	—	100	—	ppm/ °C

Note:When V_{IN}=V_{OUT}+2.0V,as the output voltage declined 2%,the V_{DIF}=V_{IN}-V_{OUT}.

Series HT7550-3-MS/HT7550-3(MS)

Parameter	Symbol	Test Condition	Min.	Typ.	Max.	Unit
Output Voltage	V _{OUT}	V _{IN} =V _{OUT} +2.0V, I _{OUT} =10mA	4.9	5.0	5.1	V
Output Current	I _{OUT}	V _{IN} =V _{OUT} +2.0V	100	150	—	mA
Load Regulation	ΔV _{OUT}	V _{IN} =V _{OUT} +2.0V 1mA≤I _{OUT} ≤50mA	—	25	60	mV
Voltage Drop	V _{DIF}	I _{OUT} =1mA,ΔV _{OUT} =2%	—	25	55	mV
Quiescent Current	I _{SS}	No Load	—	1.5	2.5	μA
Line Regulation	$\frac{\Delta V_{OUT}}{V_{OUT}} \cdot \frac{\Delta V_{IN}}{\Delta V_{IN}}$	V _{OUT} +1.0V≤V _{IN} ≤30V, I _{OUT} =1mA	—	—	0.2	%/V
Input Voltage	V _{IN}	—	—	—	30	V
Temperature Coefficient	$\frac{\Delta V_{OUT}}{\Delta T_A} \cdot V_{OUT}$	V _{OUT} +2.0V,I _{OUT} =10mA, -40C≤T _A ≤85°C	—	100	—	ppm/ °C

Note:When V_{IN}=V_{OUT}+2.0V,as the output voltage declined 2%,the V_{DIF}=V_{IN}-V_{OUT}.

FUNCTIONAL DESCRIPTION

HT75XX-3-MS/HT75XX-3(MS) series are linear voltage regulator ICs withstanding 30V voltage. The series IC consists of a voltage reference, an error amplifier, a current limiter and a phase compensation circuit plus a driver transistor. The output stabilization capacitor is also compatible with low ESR ceramic capacitors.

The over current protection circuit and the over voltage protection circuit are built-in. The protection circuit will operate when the output current or input voltage reaches limit level.

TYPICAL APPLICATION CIRCUIT

Basic Circuit

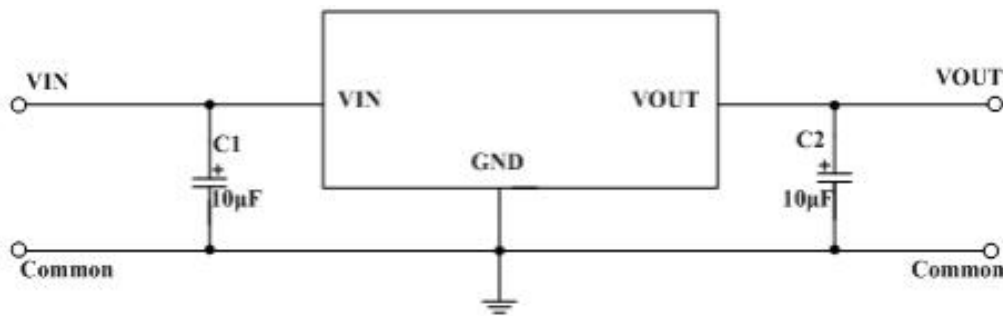

PACKAGE INFORMATION

SOT89

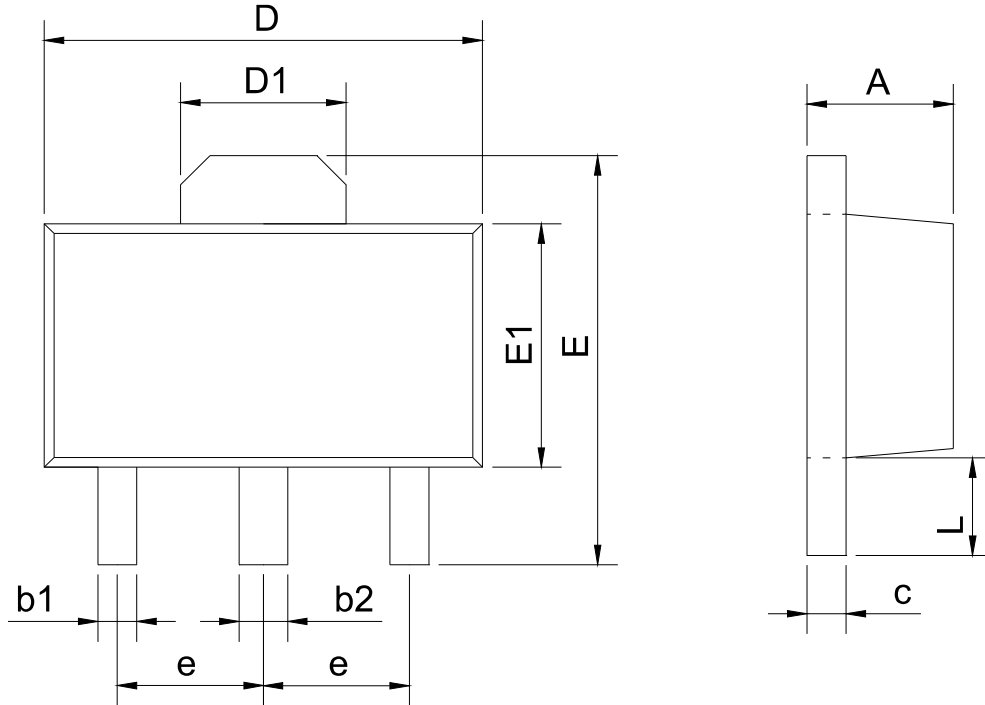

SYMBOL	mm	
	min	max
A	1.40	1.60
b1	0.35	0.50
b2	0.45	0.60
c	0.36	0.46
D	4.30	4.70
D1	1.40	1.80
E	4.00	4.40
E1	2.30	2.70
e	1.50BSC	
L	0.80	1.20

SOT23-5

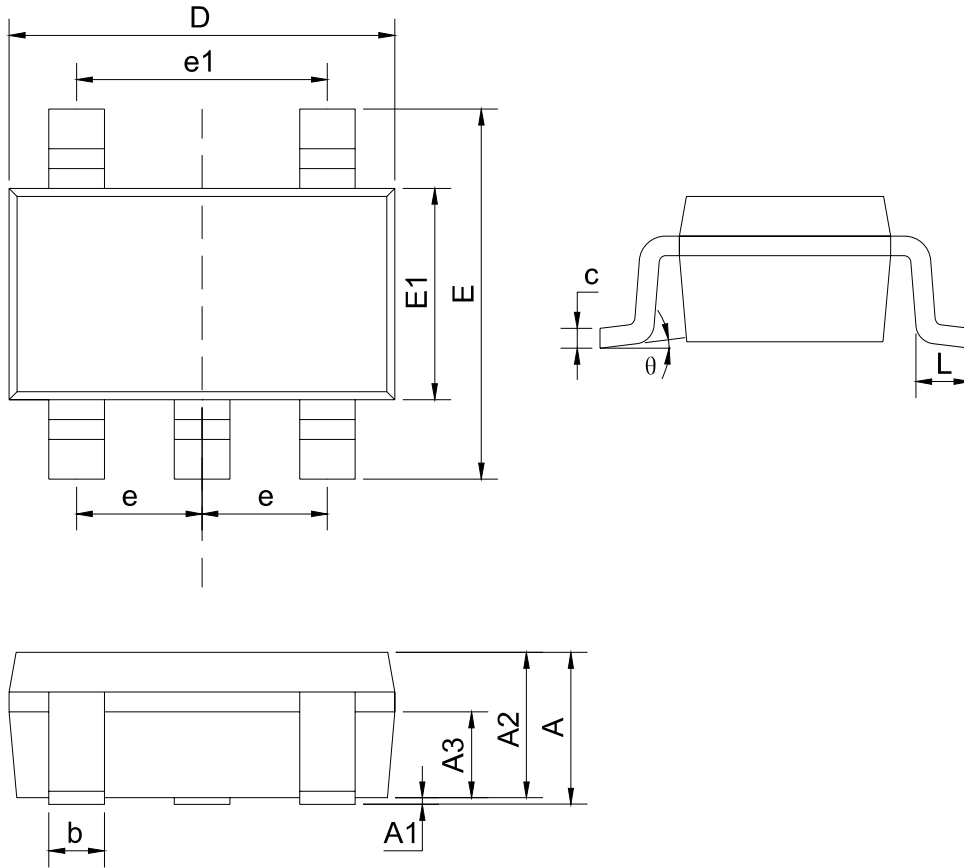

SYMBOL	mm	
	min	max
A		1.35
A1	0.04	0.15
A2	1.00	1.20
A3	0.55	0.75
b	0.38	0.48
c	0.10	0.25
D	2.72	3.12
E	2.60	3.00
E1	1.40	1.80
e	0.95BSC	
e1	1.90BSC	
L	0.30	0.60
θ	0	8°

Attention

- Any and all MSKSEMI Semiconductor products described or contained herein do not have specifications that can handle applications that require extremely high levels of reliability, such as life-support systems, aircraft's control systems, or other applications whose failure can be reasonably expected to result in serious physical and/or material damage. Consult with your MSKSEMI Semiconductor representative nearest you before using any MSKSEMI Semiconductor products described or contained herein in such applications.
- MSKSEMI Semiconductor assumes no responsibility for equipment failures that result from using products at values that exceed, even momentarily, rated values (such as maximum ratings, operating condition ranges, or other parameters) listed in products specifications of any and all MSKSEMI Semiconductor products described or contained herein.
- Specifications of any and all MSKSEMI Semiconductor products described or contained herein stipulate the performance, characteristics, and functions of the described products in the independent state, and are not guarantees of the performance, characteristics, and functions of the described products as mounted in the customer's products or equipment. To verify symptoms and states that cannot be evaluated in an independent device, the customer should always evaluate and test devices mounted in the customer's products or equipment.
- MSKSEMI Semiconductor strives to supply high-quality high-reliability products. However, any and all semiconductor products fail with some probability. It is possible that these probabilistic failures could give rise to accidents or events that could endanger human lives, that could give rise to smoke or fire, or that could cause damage to other property. When designing equipment, adopt safety measures so that these kinds of accidents or events cannot occur. Such measures include but are not limited to protective circuits and error prevention circuits for safe design, redundant design, and structural design.
- In the event that any or all MSKSEMI Semiconductor products (including technical data, services) described or contained herein are controlled under any of applicable local export control laws and regulations, such products must not be exported without obtaining the export license from the authorities concerned in accordance with the above law.
- No part of this publication may be reproduced or transmitted in any form or by any means, electronic or mechanical, including photocopying and recording, or any information storage or retrieval system, or otherwise, without the prior written permission of MSKSEMI Semiconductor.
- Information (including circuit diagrams and circuit parameters) herein is for example only ; it is not guaranteed for volume production. MSKSEMI Semiconductor believes information herein is accurate and reliable, but no guarantees are made or implied regarding its use or any infringement of intellectual property rights or other rights of third parties.
- Any and all information described or contained herein are subject to change without notice due to product/technology improvement, etc. When designing equipment, refer to the "Delivery Specification" for the MSKSEMI Semiconductor product that you intend to use.

X-ON Electronics

Largest Supplier of Electrical and Electronic Components

Click to view similar products for [LDO Voltage Regulators](#) category:

Click to view products by [MSKSEMI](#) manufacturer:

Other Similar products are found below :

[AP7363-SP-13](#) [NCV8664CST33T3G](#) [L79M05TL-E](#) [AP7362-HA-7](#) [PT7M8202B12TA5EX](#) [TCR3DF185,LM\(CT](#) [TLF4949EJ](#)
[NCP4687DH15T1G](#) [NCV8703MX30TCG](#) [LP2951CN](#) [NCV4269CPD50R2G](#) [AP7315-25W5-7](#) [NCV47411PAAJR2G](#) [AP2111H-1.2TRG1](#)
[ZLDO1117QK50TC](#) [AZ1117ID-ADJTRG1](#) [NCV4263-2CPD50R2G](#) [NCP114BMX075TCG](#) [MC33269T-3.5G](#) [TLE4471GXT](#) [AP7315-33SA-](#)
[7](#) [NCV4266-2CST33T3G](#) [NCP715SQ15T2G](#) [NCV8623MN-50R2G](#) [NCV563SQ18T1G](#) [NCV8664CDT33RKG](#) [NCV4299CD250R2G](#)
[NCP715MX30TBG](#) [NCV8702MX25TCG](#) [L974113TR](#) [TLE7270-2E](#) [NCV562SQ25T1G](#) [AP2213D-3.3TRG1](#) [AP2202K-2.6TRE1](#)
[NCV8170BMX300TCG](#) [NCV8152MX300180TCG](#) [NCP700CMT45TBG](#) [AP7315-33W5-7](#) [LD56100DPU28R](#) [NCP154MX180300TAG](#)
[AP2210K-3.0TRE1](#) [AP2113AMTR-G1](#) [NJW4104U2-33A-TE1](#) [MP2013AGG-5-P](#) [NCV8775CDT50RKG](#) [NJM2878F3-45-TE1](#) [S-](#)
[19214B00A-V5T2U7](#) [S-19214B50A-V5T2U7](#) [S-19213B50A-V5T2U7](#) [S-19214BC0A-E8T1U7*1](#)