

MSKSEMI 美森科

SEMICONDUCTOR



ESD



TVS



TSS



MOV



GDT



PLED

MIC29302WU(MS)

Product specification

概述

MIC29302WU(MS) 是一款低压差、大电流且精度高的电压调节器电路。以超 β PNP 工艺制作的 PNP 管 作为调节元件。满载条件 (3A) 下, 输入输出压差仅 370mV (典型值)、地端电流仅 37mA (典型值)。该器件也可应用于小电流、极低压差的电源系统。

MIC29302WU(MS) 具有过流保护、输入电压反接保护、过热保护以及瞬态尖峰电压保护功能。通过 设置使能端的逻辑电位, 可控制器件工作或休眠, 在休眠状态下, 器件的功率消耗极低; 使能端也可直接与输入端电源连接, 使器件处于工作状态。

MIC29302WU(MS) 采 用 T0-263-5 封装形式。



特点

- 大电流
- 低压差
- 地端电流小
- 精度高
- 瞬态响应快
- 电池反接和过载保护
- 零电流关断模式

应用

- 电源设备
- 高效“绿色 ”计算机系统
- 自动化电子应用
- 高效线性电源
- 高效无调节开关电源

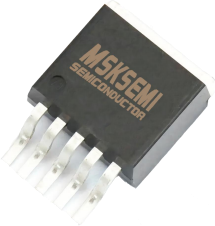
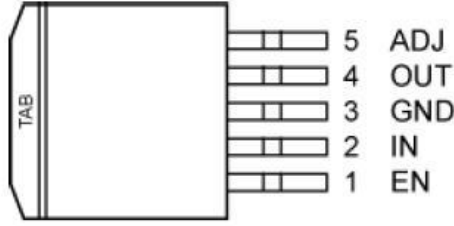
封装形式及引脚定义

封装	引脚排列	丝印
 <p>SOT-263-5</p>	 <p>5 ADJ 4 OUT 3 GND 2 IN 1 EN</p>	

引脚序号	引脚符号	引脚功能
1	EN	使能端, 与CMOS逻辑电平兼容。EN=H时, 器件工作; EN=L时, 器件休眠。
2	IN	输入端, 输入电压
3	GND	地端, 框架衬底也连接到器件地端
4	OUT	输出端
5	ADJ	调整反馈端, 连接于输出端与地端电阻分压网络, 以 设定输出电压值

引脚功能说明

极限参数^{注1}

- ◇ 输入电压 V_{IN} ^{注1}: -20V~+60V
- ◇ 使能电压 V_{EN} : -0.3V~ V_{IN}
- ◇ 焊接温度 (5S): 260°C
- ◇ 功耗: 内部限制
- ◇ 存储温度: -65°C~150°C
- ◇ 静电敏感极限: 见注2

工作极限条件^{注3}

- ◇ 工作结温: -40°C~125°C
- ◇ 最大输入电压: 26V
- ◇ 热阻: 2°C/W

电参数^{注4}

 (除注明外, 测试条件均为: $V_{IN}=V_{OUT}+1V$, $T_J=25^{\circ}C$, 粗体数值表示 $-40^{\circ}C \leq T_J \leq +125^{\circ}C$)

参数名称	测试条件	最小值	典型值	最大值	单位	
器件总体						
输出电压	$I_{OUT} = 10mA$	-1		1	%	
	$10mA \leq I_{OUT} \leq I_{FL}$, ($V_{OUT}+1V$) $\leq V_{IN} \leq 26V$	-2		2		
线性调整率	$I_{OUT}=10mA$, ($V_{OUT}+1V$) $\leq V_{IN} \leq 26V$		0.06	0.5	%	
负载调整率	$V_{IN} = V_{OUT} + 1V$, $10mA \leq I_{OUT} \leq 1.5A$		0.2	1	%	
输出电压温度系数	注5		20	100	ppm/ $^{\circ}C$	
输入输出压差	$\Delta V_{OUT} = -1\%$ ^{注6}	$I_{OUT}=100mA$		80	175	mV
		$I_{OUT}=1.5A$		250		mV
		$I_{OUT}=3A$		370	600	mV
地端电流	$V_{IN} = V_{OUT} + 1V$, $I_{OUT}=1.5A$		10	35	mA	
	$V_{IN} = V_{OUT} + 1V$, $I_{OUT}=3A$		37		mA	
输出限制电流	$V_{OUT} = 0V$ ^{注7}		4.5	5	A	
输出噪声电压*	$I_{OUT}=100mA$, $C_L=10\mu F$		400		$\mu V(rms)$	
	$I_{OUT}=100mA$, $C_L=33\mu F$		260		$\mu V(rms)$	
基准部分						
基准电压		1.228 1.215	1.240	1.252 1.265	V	
调整端偏置电流			40	80 120	nA	
基准电压温度系数			20		ppm/ $^{\circ}C$	
调整端偏置电流温度系数			0.1		nA/ $^{\circ}C$	
使能部分						
使能低电平(关)				0.8		
使能高电平(开)		2.4				
使能端输入电流	$V_{EN}=26V$		100	600 750	μA	
	$V_{EN}=0.8V$	0.7		2 4	μA	
关断输出电流	注8		10	500	μA	

 注1: 正电源电压的施加条件: $<100mS$, 占空比 $\leq 1\%$, 器件最大持续工作电源电压为26V。超过极限条件的电源电压会造成器件损坏。

注2: 静电敏感器件, 建议采取防静电措施。

注 3: 不允许超过极限应用条件使用。

注 4: 参数定义针对成品器件; 在双电源供电系统中, 调节器负载与负电源连接, 输出电压必须用二极管钳位到地。

注 5: 输出电压温度系数定义为, 最坏情况输出电压变化与全温度范围变化的比值。

注 6: 输入输出压差定义为, 施加 $V_{OUT}+1V$ 到 V_{IN} , 降低 V_{IN} , 当输出电压降低到其正常值的 99% 时, 输入电压与输出电压之间的压差。

注 7: 设定 $V_{IN}=V_{OUT}+1V$, 采用脉冲测试输出电流。

注 8: $V_{EN} \leq 0.8V$ 且 $V_{IN} \leq 26V$, $V_{OUT}=0V$ 。

典型特性曲线

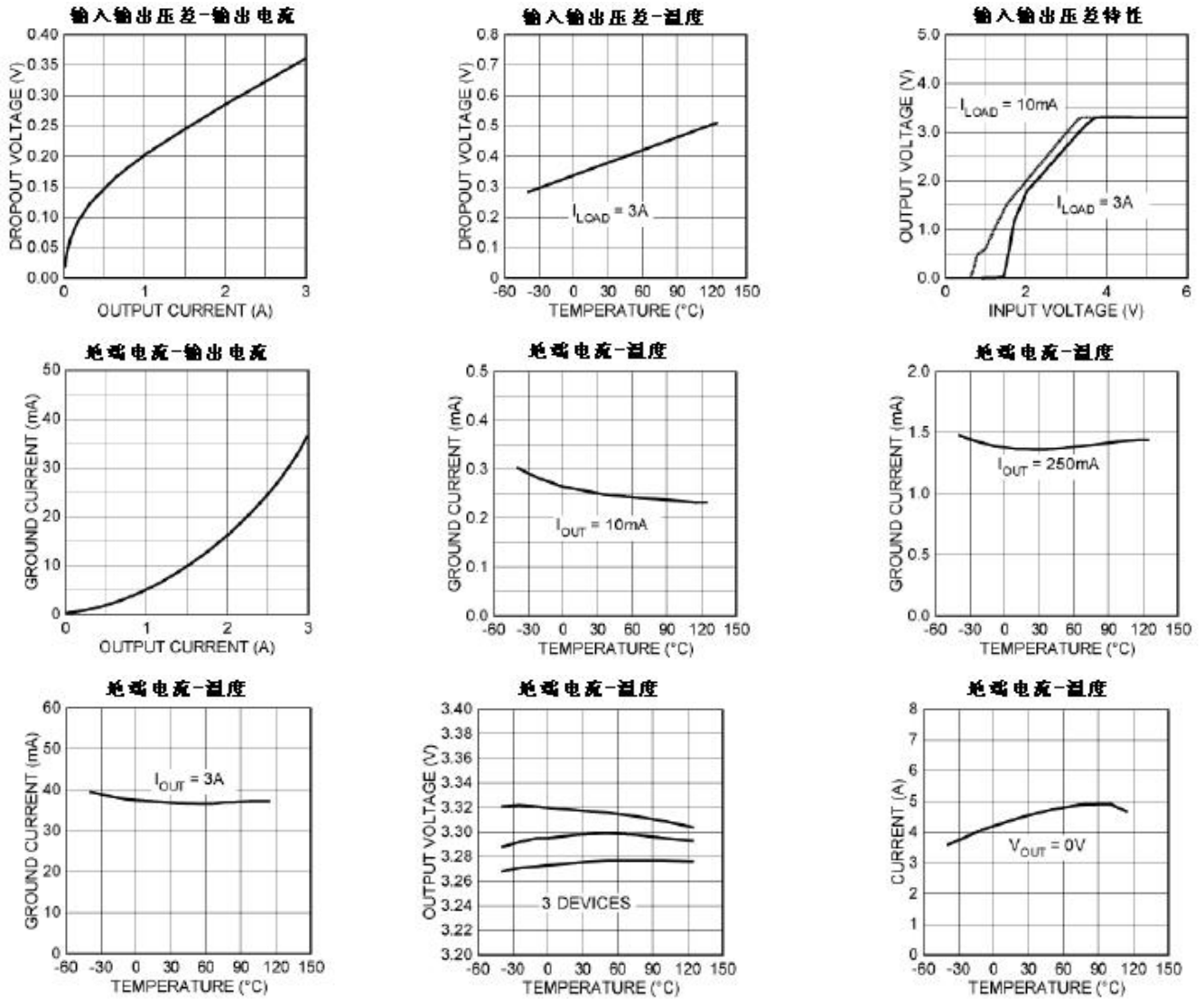

地端电流-输入电压

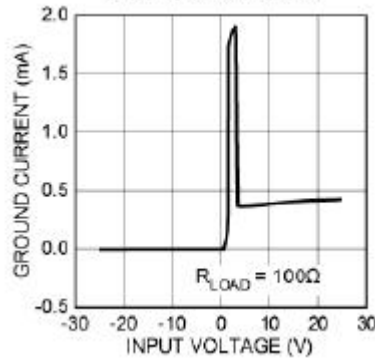

典型特性曲线 (续)

使能端电流-温度

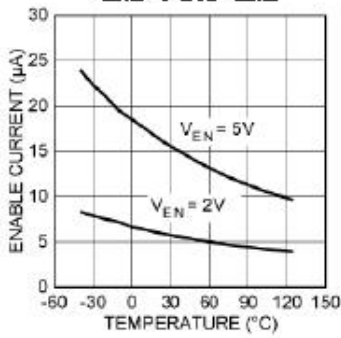

负载瞬态响应

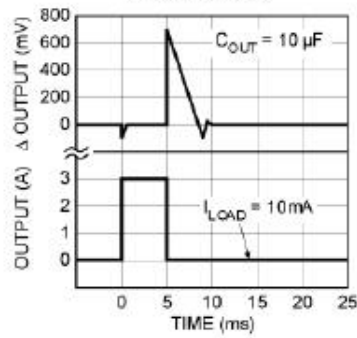

负载瞬态响应

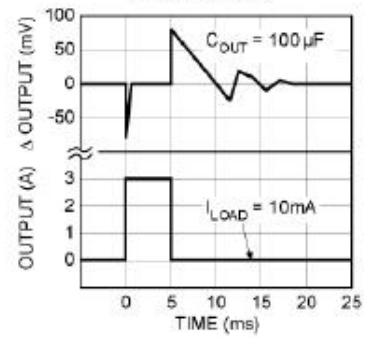

调整端电流-温度

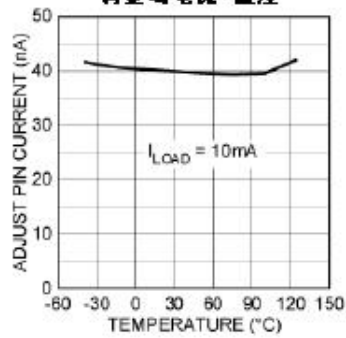

线性瞬态响应

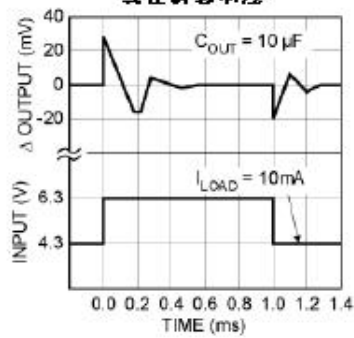

线性瞬态响应

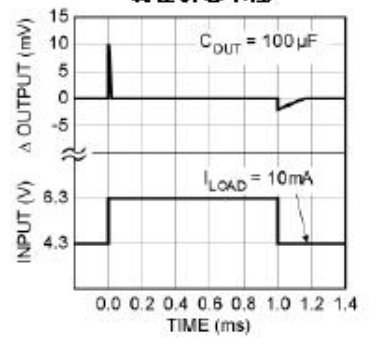

输出阻抗-频率

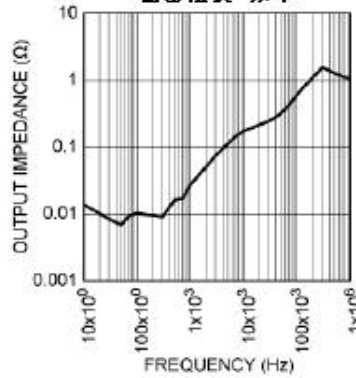

原理框图

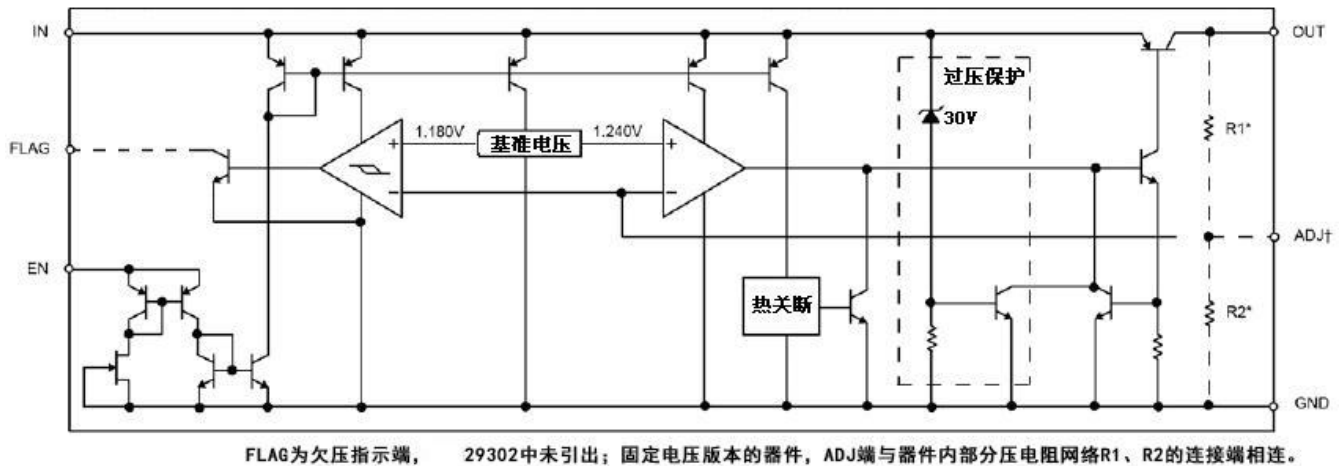

应用指南

保护功能

MIC29302WU(MS) 具有线性电流限制功能，在过载时输出电流是持续的；当温度超多器件最大安全工作温度 150℃时，热关断功能启动，有效关断输出；线性瞬态保护功能使器件能够承受-20V~+60V的输入电压尖峰冲击；当输入电压超过约 30V 时，过压检测功能启动，有效关断输出；逻辑电平就可以控制器件工作或关断，在关断状态下，器件消耗电流几乎为 0。

热设计举例

MIC29302WU(MS) 应用简单，热特性是最复杂也必须考虑的因素，热设计举例如下：

设输入电压 $V_{IN} = 5V$ ，输出电压 $V_{out} = 3.3V$ ，负载电流 $I_{out} = 1A$ ，环境温度 $T_A = 50^\circ C$ ，结到环境的热阻 $\theta_{JA} = 31.4^\circ C/W$ ，地端电流大约为 I_{OUT} 的 0.01

计算器件的功耗

$$P_D = I_{OUT} \cdot (1.01 V_{IN} - V_{OUT}) = 1.75W$$

器件工作结温

$$T_J = T_A + P_D \cdot \theta_{JA} = 50 + 1.75 \cdot 31.4 = 104.95^\circ C$$

小于器件正常工作的最高结温 125℃，可以保证器件可靠工作。

电容选择

为减小输出电压噪声，稳定输出电压，输出端需要滤波电容，容值的大小取决于输出电流，电流越小，容值选择可以越小。在全负载范围内，选取 10uF 铝电解电容就能满足应用，在要求负载瞬态响应快的应用领域，建议采用钽电容。

输入端与地之间建议采用 0.1uF 的电容进行滤波。

最小负载电流

如果负载电流过小，漏电流影响会使输出电压升高。因此需要最小 7mA 的负载电流，以保证 MIC29302 正常工作。

使能输入

使能输入端电位与 TTL/CMOS 电平兼容，可与逻辑器件直接接口，也可直接连接 30V 以下的电压。器件正常工作的使能端电流大约 20uA。

典型应用

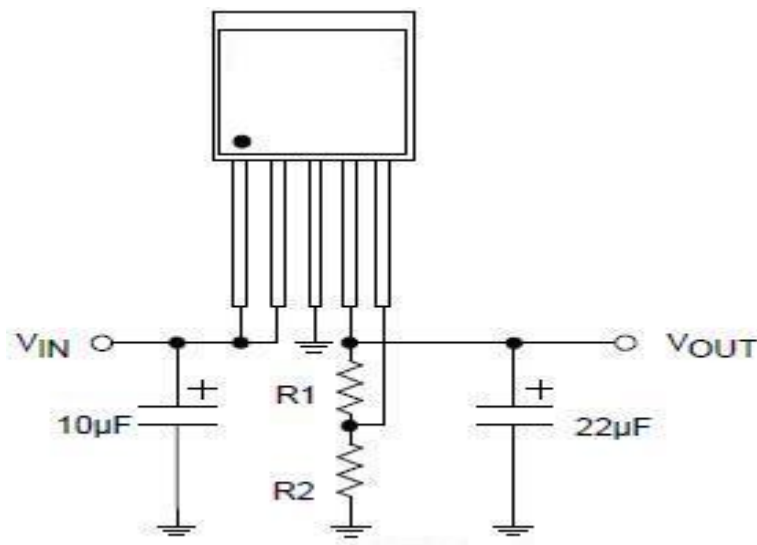

MIC29302WU(MS)典型应用图

$$R_1 = R_2 \times \left(\frac{V_{OUT}}{1.240} - 1 \right)$$

外形尺寸

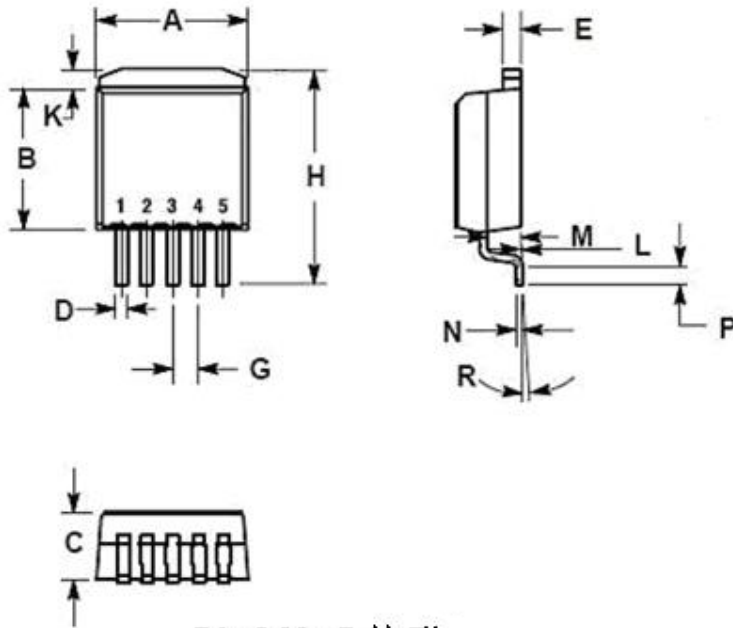

TO-263-5 外形

项目	规范 (mm)	
	Min	Max
A	9.804	10.236
B	9.042	9.347
C	4.318	4.572
D	0.66	0.914
E	1.143	1.397
G	1.702BSC	
K	1.78REF	
H	14.250	15.250
L	0	0.254
M	2.235	2.591
N	0.356	0.406
P	0.950	1.450
R	5° REF	

对应尺寸

订购信息

P/N	PKG	QTY
MIC29302WU(MS)	SOT-263-5	750

Attention

- Any and all MSKSEMI Semiconductor products described or contained herein do not have specifications that can handle applications that require extremely high levels of reliability, such as life-support systems, aircraft's control systems, or other applications whose failure can be reasonably expected to result in serious physical and/or material damage. Consult with your MSKSEMI Semiconductor representative nearest you before using any MSKSEMI Semiconductor products described or contained herein in such applications.
- MSKSEMI Semiconductor assumes no responsibility for equipment failures that result from using products at values that exceed, even momentarily, rated values (such as maximum ratings, operating condition ranges, or other parameters) listed in products specifications of any and all MSKSEMI Semiconductor products described or contained herein.
- Specifications of any and all MSKSEMI Semiconductor products described or contained herein stipulate the performance, characteristics, and functions of the described products in the independent state, and are not guarantees of the performance, characteristics, and functions of the described products as mounted in the customer's products or equipment. To verify symptoms and states that cannot be evaluated in an independent device, the customer should always evaluate and test devices mounted in the customer's products or equipment.
- MSKSEMI Semiconductor strives to supply high-quality high-reliability products. However, any and all semiconductor products fail with some probability. It is possible that these probabilistic failures could give rise to accidents or events that could endanger human lives, that could give rise to smoke or fire, or that could cause damage to other property. When designing equipment, adopt safety measures so that these kinds of accidents or events cannot occur. Such measures include but are not limited to protective circuits and error prevention circuits for safe design, redundant design, and structural design.
- In the event that any or all MSKSEMI Semiconductor products (including technical data, services) described or contained herein are controlled under any of applicable local export control laws and regulations, such products must not be exported without obtaining the export license from the authorities concerned in accordance with the above law.
- No part of this publication may be reproduced or transmitted in any form or by any means, electronic or mechanical, including photocopying and recording, or any information storage or retrieval system, or otherwise, without the prior written permission of MSKSEMI Semiconductor.
- Information (including circuit diagrams and circuit parameters) herein is for example only ; it is not guaranteed for volume production. MSKSEMI Semiconductor believes information herein is accurate and reliable, but no guarantees are made or implied regarding its use or any infringements of intellectual property rights or other rights of third parties.
- Any and all information described or contained herein are subject to change without notice due to product/technology improvement, etc. When designing equipment, refer to the "Delivery Specification" for the MSKSEMI Semiconductor product that you intend to use.

X-ON Electronics

Largest Supplier of Electrical and Electronic Components

Click to view similar products for [Linear Voltage Regulators](#) category:

Click to view products by [MSKSEMI](#) manufacturer:

Other Similar products are found below :

[LV5684PVD-XH](#) [MCDTSA6-2R](#) [L7815ACV-DG](#) [LV56801P-E](#) [UA7805CKC](#) [714954EB](#) [ZMR500QFTA](#) [BA033LBSG2-TR](#)
[NCV78M05ABDTRKG](#) [LV5680P-E](#) [L79M05T-E](#) [L78LR05D-MA-E](#) [NCV317MBTG](#) [NTE7227](#) [MP2018GZD-33-P](#) [MP2018GZD-5-P](#)
[LV5680NPVC-XH](#) [ZTS6538SE](#) [UA78L09CLP](#) [UA78L09CLPR](#) [CAT6221-PPTD-GT3](#) [MC78M09CDTRK](#) [NCV51190MNTAG](#)
[BL1118CS8TR1833](#) [BL8563CKETR18](#) [BL8077CKETR33](#) [BL9153-33CC3TR](#) [BL9161G-15BADRN](#) [BL9161G-28BADRN](#)
[BRCO7530MMC](#) [CJ7815B-TFN-ARG](#) [LM317C](#) [GM7333K](#) [GM7350K](#) [XC6206P332MR](#) [HT7533](#) [LM7912S/TR](#) [LT1764S/TR](#) [LM7805T](#)
[LM338T](#) [LM1117IMP-3.3/TR](#) [HT1117AM-3.3](#) [HT7550S](#) [AMS1117-3.3](#) [HT7150S](#) [78L12](#) [HT7550](#) [HT7533-1](#) [HXY6206I-2.5](#) [HT7133](#)