

MSKSEMI 美森科

SEMICONDUCTOR



ESD



TVS



TSS



MOV



GDT

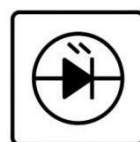

PLED

MIC5205

产品手册

概述

MIC5205 系列是一组低压差 (LDO) 转换器, 具有 2.8V 至 24V 宽电压输入范围、低压差、低功耗和小型化封装的特性, 输出电压范围为 3.0-5.0V。

MIC5205 低至 1.8 μ A 低静态电流特性, 电路也带有 CE 使能控制端口, 可使电路进入休眠状态。特别适用于电池供电、长时间待机系统设备应用, 能帮助降低系统设备的待机功耗, 有效延长待机时间和电池使用寿命。

特性

- 输入输出电压差低
- 温度漂移系数小
- 耐压 24V
- 工作静态电流 1.8 μ A, 最大 4 μ A
- 休眠静态电流最大 0.2 μ A
- 输出电压精度: $\pm 2\%$
- 输出过载保护
- 带有 CE 使能控制端口
- 工作温度 $-20^{\circ}\text{C} \sim +85^{\circ}\text{C}$

应用

- 手持式、电池供电设备
- 通信设备
- 音频、视频设备
- 低功耗微处理器
- 笔记本电脑、掌上型电脑和 PDA
- 车载导航系统
- 工业控制
- 智能家居

封装外形及引脚排列

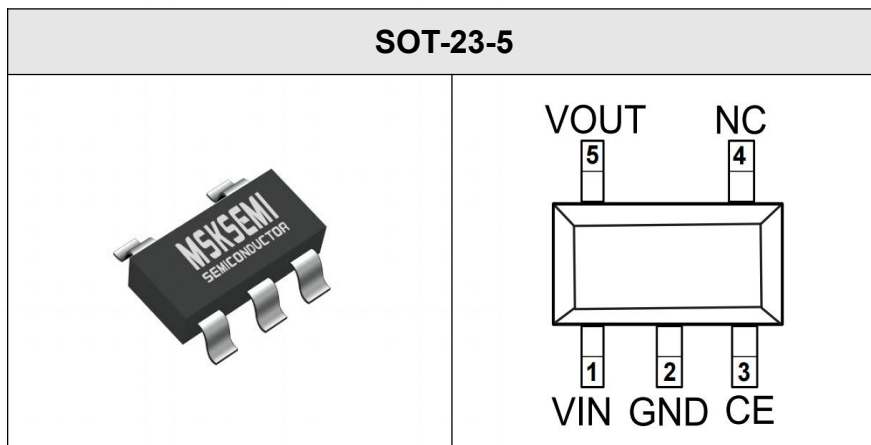

引脚功能描述

序号	符号	功能描述
1	VIN	输入端
2	VSS	地端
3	CE	使能端
4	NC	悬空
5	VOUT	输出端

电路方框图

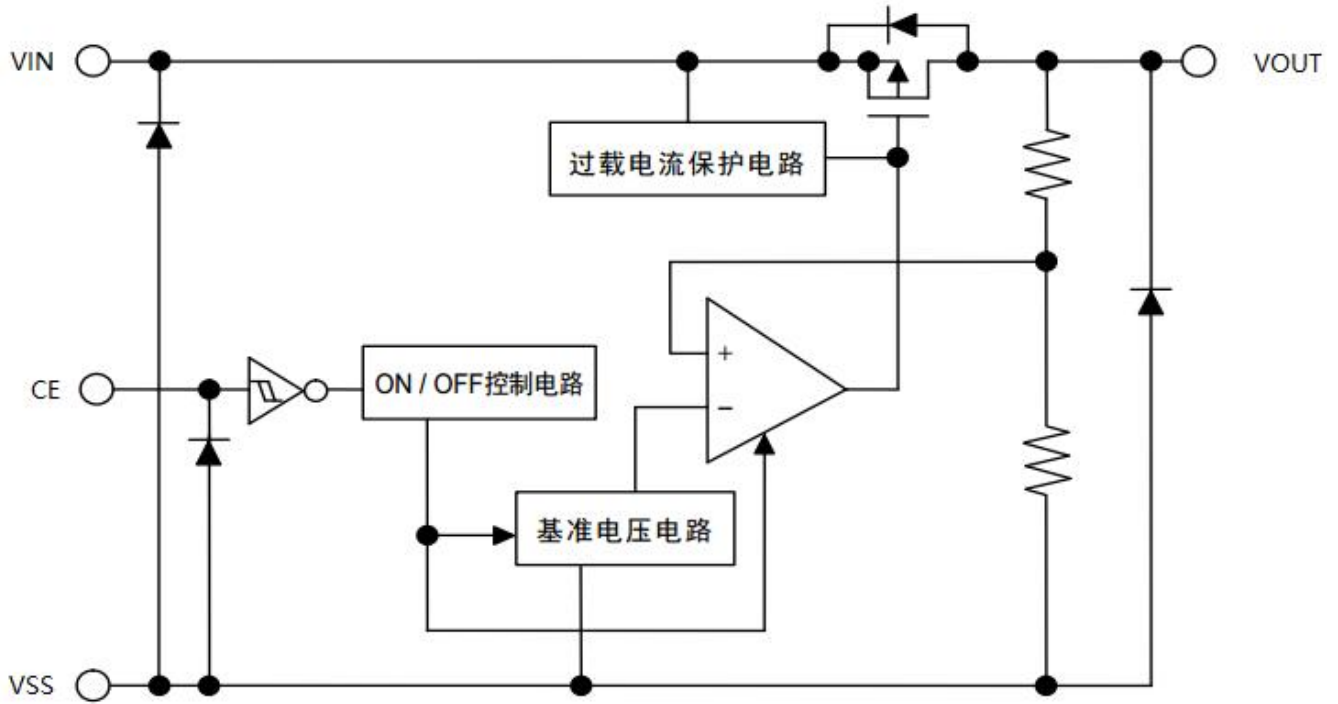

最大额定值 (无特别说明情况下, $T_A=25^{\circ}\text{C}$)

参数说明	符号	数值范围	单位
输入极限电压	V_{IN}	$-0.3 \sim +26$	V
使能口极限电压	V_{CE}	$-0.3 \sim +26$	V
输出极限电流	I_{out}	600	mA
贮存温度	T_{STG}	$-50 \sim +125$	$^{\circ}\text{C}$
工作温度	T_A	$-20 \sim +85$	$^{\circ}\text{C}$
结温 ⁽¹⁾	T_j	150	$^{\circ}\text{C}$

注: 超最大额定值应用可能会对器件造成永久性损伤。

散热信息

参数说明	符号	数值范围	单位
功耗	P_D	200	mW

电气参数 (无特别说明情况下, $T_A=25^{\circ}\text{C}$, $C_{IN}=C_{OUT}=1\mu\text{F}$)

参数说明	符号	测试条件	最小值	典型值	最大值	单位
输入电压	V_{IN}		3.0		24	V
输出电压	V_{OUT}		3.0		5.0	V
输出电压精度		$I_{OUT}=1\text{mA}$	-2		+2	%
输出电流	I_{OUT}	$V_{IN}=V_{OUT}+2.0\text{V}$	—	350	—	mA
负载调整率	ΔV_{OUT}	$V_{IN}=V_{OUT}+2.0\text{V}$ $1\text{mA}\leq I_{OUT}\leq 150\text{mA}$	—	15	—	mV
线性调整率	$\frac{\Delta V_{OUT}}{V_{OUT}} \cdot \Delta V_{IN}$	$V_{OUT}+1.0\text{V}\leq V_{IN}\leq 20\text{V}$ $I_{OUT}=10\text{mA}$	—	0.015	0.2	%/V
低压差	$V_{DIF}^{\text{①}}$	$I_{OUT}=100\text{mA}, V_{OUT}=3.3\text{V}$	—	200	—	mV
静态电流	I_{SS}	$V_{CE}=V_{IN}$	—	1.8	4	μA
休眠电流	$I_{STANDBY}$	$V_{CE}=V_{SS}$			0.2	μA
使能高电平	V_{CEH}	$V_{IN}=V_{OUT}+2.0\text{V}$	1.7		24	V
使能低电平	V_{CEL}	$V_{IN}=V_{OUT}+2.0\text{V}$	0		0.3	V
短路电流	I_{SHORT}	$V_{IN}=V_{OUT}+2.0\text{V}$	—	400	—	mA
温度系数	$\frac{\Delta V_{OUT}}{\Delta T_A} \cdot V_{OUT}$	$V_{IN}=V_{OUT}+2.0\text{V}$ $I_{OUT}=10\text{mA}$ $-40^{\circ}\text{C}\leq T_A\leq 125^{\circ}\text{C}$	—	± 100	—	ppm/ $^{\circ}\text{C}$
输出有源放电电阻	$R_{DIS}^{\text{②}}$	$V_{CE}<0.5\text{V}$		300		Ω

注:

- ①当 $V_{IN}=V_{OUT}+2.0\text{V}$, 固定负载条件下使输出电压下降 2%, 此时输入电压和输出电压的差值为低压差值 V_{DIF} 。
- ②输出有源放电电阻 R_{DIS} , 随着 V_{IN} 电压增大而降低。

应用说明

- 1、应用时尽量将电容接到 VIN 和 VOUT 脚位附近。
- 2、电路内部使用了相位补偿电路和利用输出电容的 ESR 来补偿。所以输出到地一定要接大于或者等于 1 μ F 的电容器。
- 3、注意输入输出电压、负载电流的使用条件，避免 IC 内部的功耗超出封装允许的最大功耗值

应用电路

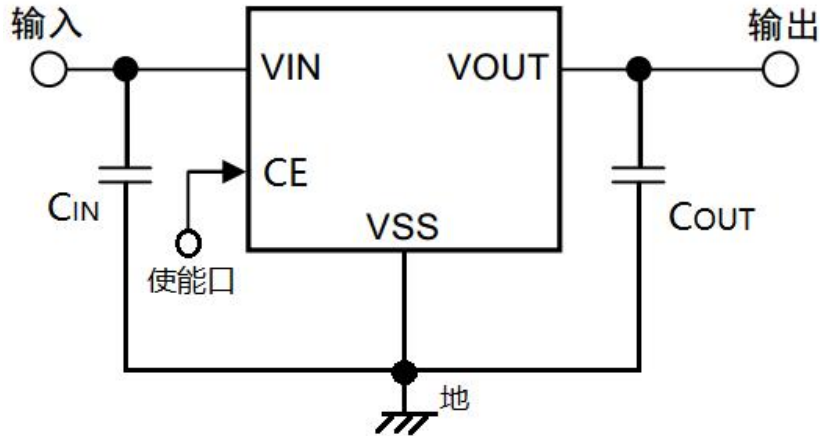

1. C_{IN} 用于稳定输入电容
2. C_{OUT} 可以使用的大于或等于 1 μ F 的陶瓷电容

典型的性能曲线

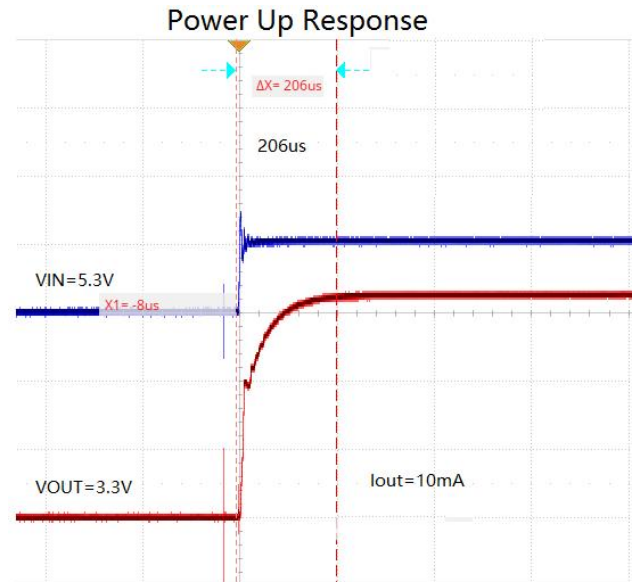
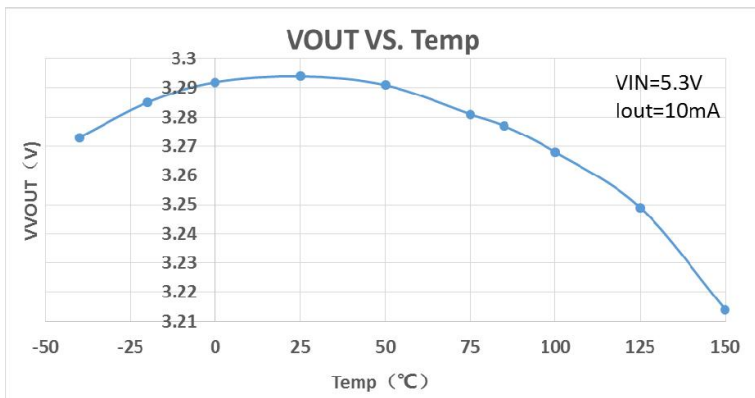

封装描述

SOT-23-5 封装

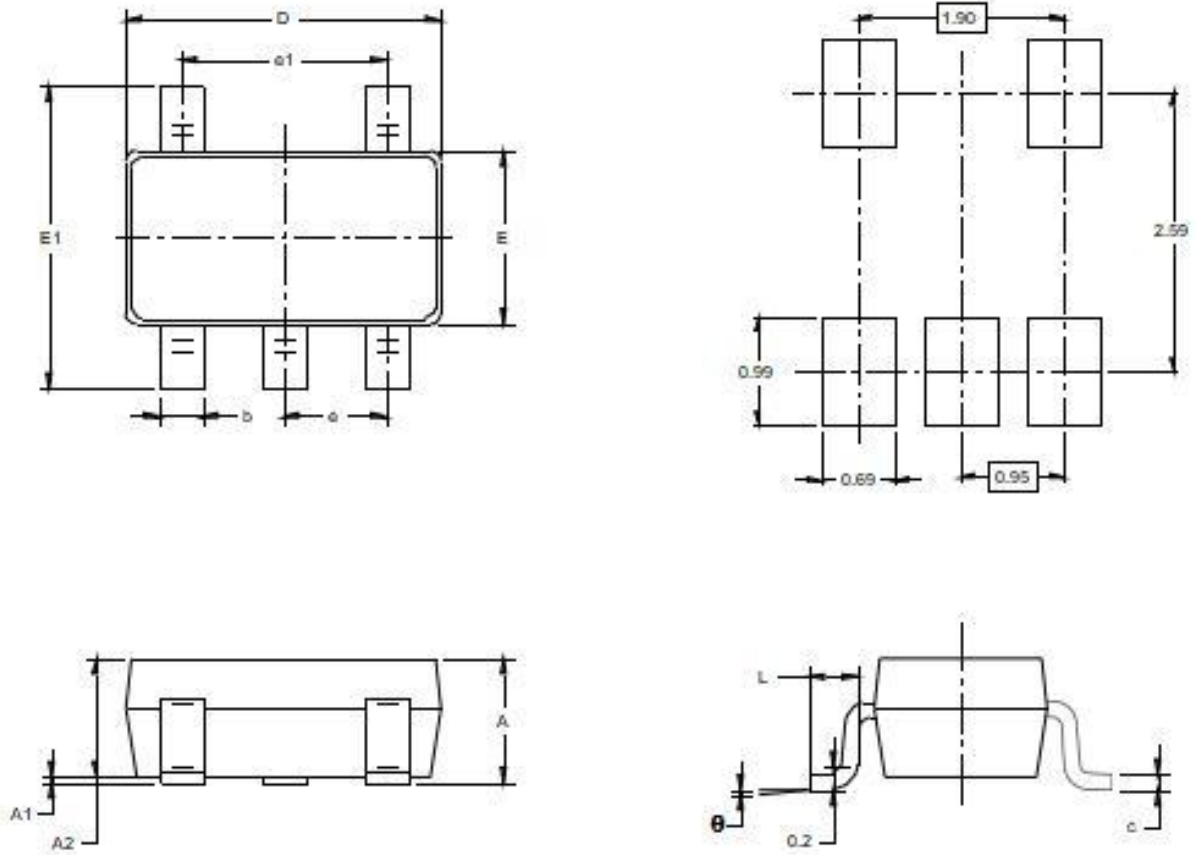

Symbol	Dimensions In Millimeters		Dimensions In Inches	
	MIN	MAX	MIN	MAX
A	1.050	1.250	0.041	0.049
A1	0.000	0.100	0.000	0.004
A2	1.050	1.150	0.041	0.045
b	0.300	0.500	0.012	0.020
c	0.100	0.200	0.004	0.008
D	2.820	3.020	0.111	0.119
E	1.500	1.700	0.059	0.067
E1	2.650	2.950	0.104	0.116
e	0.950 BSC		0.037 BSC	
1	1.900 BSC		0.075 BSC	
L	0.300	0.600	0.012	0.024
θ	0°	8°	0°	8°

封装/订购信息

订单型号	输出电压	容差	封装形式	包装/数量
MIC5205-3.0YM5-MS	3.0V	2%	SOT-23-5	盘装/3000pcs
MIC5205-3.3YM5-MS	3.3V			
MIC5205-3.6YM5-MS	3.6V			
MIC5205-4.0YM5-MS	4.0V			
MIC5205-4.4YM5-MS	4.4V			
MIC5205-5.0YM5-MS	5.0V			

Attention

- Any and all MSKSEMI Semiconductor products described or contained herein do not have specifications that can handle applications that require extremely high levels of reliability, such as life-support systems, aircraft's control systems, or other applications whose failure can be reasonably expected to result in serious physical and/or material damage. Consult with your MSKSEMI Semiconductor representative nearest you before using any MSKSEMI Semiconductor products described or contained herein in such applications.
- MSKSEMI Semiconductor assumes no responsibility for equipment failures that result from using products at values that exceed, even momentarily, rated values (such as maximum ratings, operating condition ranges, or other parameters) listed in products specifications of any and all MSKSEMI Semiconductor products described or contained herein.
- Specifications of any and all MSKSEMI Semiconductor products described or contained herein stipulate the performance, characteristics, and functions of the described products in the independent state, and are not guarantees of the performance, characteristics, and functions of the described products as mounted in the customer's products or equipment. To verify symptoms and states that cannot be evaluated in an independent device, the customer should always evaluate and test devices mounted in the customer's products or equipment.
- MSKSEMI Semiconductor strives to supply high-quality high-reliability products. However, any and all semiconductor products fail with some probability. It is possible that these probabilistic failures could give rise to accidents or events that could endanger human lives, that could give rise to smoke or fire, or that could cause damage to other property. When designing equipment, adopt safety measures so that these kinds of accidents or events cannot occur. Such measures include but are not limited to protective circuits and error prevention circuits for safe design, redundant design, and structural design.
- In the event that any or all MSKSEMI Semiconductor products (including technical data, services) described or contained herein are controlled under any of applicable local export control laws and regulations, such products must not be exported without obtaining the export license from the authorities concerned in accordance with the above law.
- No part of this publication may be reproduced or transmitted in any form or by any means, electronic or mechanical, including photocopying and recording, or any information storage or retrieval system, or otherwise, without the prior written permission of MSKSEMI Semiconductor.
- Information (including circuit diagrams and circuit parameters) herein is for example only ; it is not guaranteed for volume production. MSKSEMI Semiconductor believes information herein is accurate and reliable, but no guarantees are made or implied regarding its use or any infringements of intellectual property rights or other rights of third parties.
- Any and all information described or contained herein are subject to change without notice due to product/technology improvement, etc. When designing equipment, refer to the "Delivery Specification" for the MSKSEMI Semiconductor product that you intend to use.

X-ON Electronics

Largest Supplier of Electrical and Electronic Components

Click to view similar products for [Linear Voltage Regulators](#) category:

Click to view products by [MSKSEMI](#) manufacturer:

Other Similar products are found below :

[LV5684PVD-XH](#) [MCDTSA6-2R](#) [L7815ACV-DG](#) [LV56801P-E](#) [UA7805CKC](#) [714954EB](#) [ZMR500QFTA](#) [BA033LBSG2-TR](#)
[NCV78M05ABDTRKG](#) [LV5680P-E](#) [L79M05T-E](#) [L78LR05D-MA-E](#) [NCV317MBTG](#) [NTE7227](#) [MP2018GZD-33-P](#) [MP2018GZD-5-P](#)
[LV5680NPVC-XH](#) [ZTS6538SE](#) [UA78L09CLP](#) [UA78L09CLPR](#) [CAT6221-PPTD-GT3](#) [MC78M09CDTRK](#) [NCV51190MNTAG](#)
[BL1118CS8TR1833](#) [BL8563CKETR18](#) [BL8077CKETR33](#) [BL9153-33CC3TR](#) [BL9161G-15BADRN](#) [BL9161G-28BADRN](#)
[BRCO7530MMC](#) [CJ7815B-TFN-ARG](#) [LM317C](#) [GM7333K](#) [GM7350K](#) [XC6206P332MR](#) [HT7533](#) [LM7912S/TR](#) [LT1764S/TR](#) [LM7805T](#)
[LM338T](#) [LM1117IMP-3.3/TR](#) [HT1117AM-3.3](#) [HT7550S](#) [AMS1117-3.3](#) [HT7150S](#) [78L12](#) [HT7550](#) [HT7533-1](#) [HXY6206I-2.5](#) [HT7133](#)