

MSKSEMI 美森科

SEMICONDUCTOR



ESD



TVS



TSS

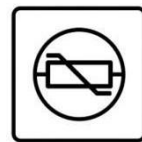

MOV



GDT



PLED

OPA376AIDBVR-MS/OPA2376AIDR-MS

Product specification

**Ultra Low Noise Rail-to-Rail I/O CMOS
Precision OPERATIONAL AMPLIFIERS**

GENERAL DESCRIPTION

The OPA376 family represents a new generation of low-noise operational amplifiers, offering outstanding dc precision and ac performance. Rail-to-Rail input and output, low offset (2μV), low noise (6nV/√Hz), quiescent current of 600 μA, and a 6-MHz bandwidth make this part very attractive for a variety of precision and portable applications.

In addition, this device has a reasonably wide supply range (2V to 5.5V) with excellent PSRR, making it attractive for applications that run directly from batteries without regulation.

The OPA376AIDBVR-MS (single), OPA2376AIDR-MS (dual) families of operational amplifiers are specified for operation from -25°C to +125°C.





FEATURES

- Input Offset Voltage: 2μV (Typical)
- Zero Drift: 0.03μV/°C (Typical)
- Ultra Low Noise: 6nV/√Hz at 1kHz
- Supply Range: 2V to 5.5V
- Gain Bandwidth: 6 MHz
- Slew rate: 5V/μs
- Quiescent current: 600μA (Vs=5V)
- Rail-to-Rail Input and Output
- Micro size Packages:
OPA376AIDBVR-MS: SOT-23-5
OPA2376AIDR-MS: SOP-8

APPLICATIONS

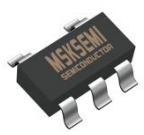
- ADC Buffer
- Audio Equipment
- Medical Instrumentation
- Handheld Test Equipment
- Active Filtering
- Sensor Signal Conditioning

Reference News

MODEL	Op Temp(°C)	PACKAGE OUTLINE		Marking	Minimum packaging (PCS)
OPA376AIDBVR-MS	-25°C~125°C	SOT-23-5			3000
OPA2376AIDR-MS	-25°C~125°C	SOP-8			2500

TYPICAL APPLICATION

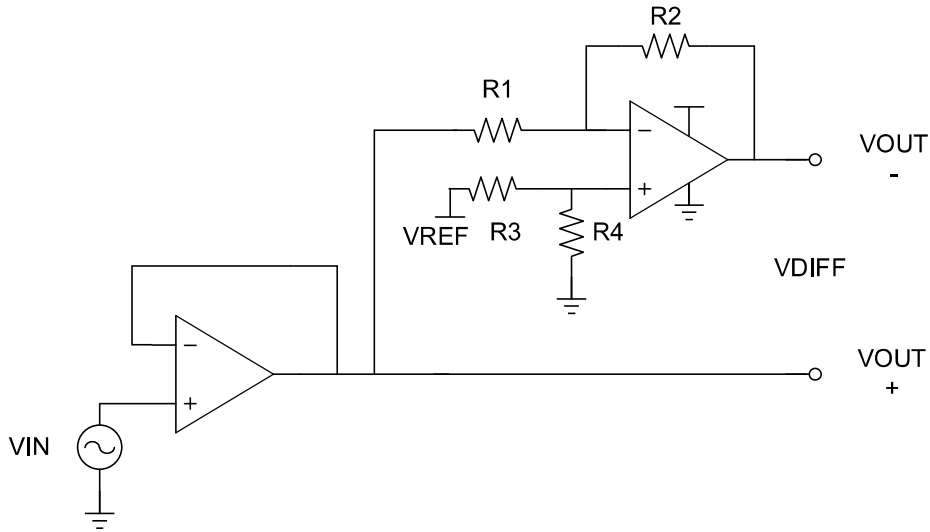
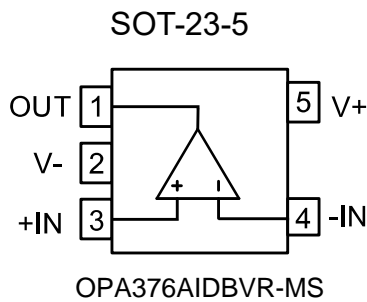

Figure 1. Typical Application

Pin Configuration and Functions (Top View)

Pin Description



PIN		I/O	DESCRIPTION
NAME	Number		
+IN	3	I	Positive (noninverting) input
-IN	4	I	Negative (inverting) input
OUT	1	O	Output
V-	2	-	Positive (highest) power supply
V+	5	-	Negative (lowest) power supply

Pin Configuration and Functions (Top View)

Pin Description

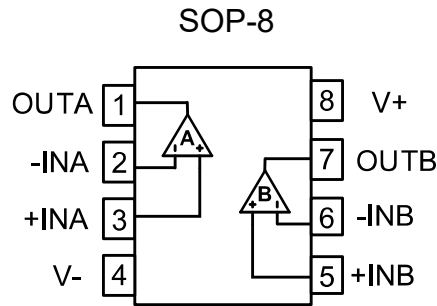

OPA2376AIDR-MS

PIN		I/O	DESCRIPTION
NAME	Number		
+INA	3		Noninverting input, channel A
+INB	5		Noninverting input, channel B
-INA	2		Inverting input, channel A
-INB	6		Inverting input, channel B
OUTA	1	0	Output, channel A
OUTB	7	0	Output, channel B
V-	4	—	Negative (lowest) power supply
V+	8	—	Positive (highest) power supply

SPECIFICATIONS

Absolute Maximum Ratings⁽¹⁾

		MIN	MAX	UNIT
Voltage	Supply Voltage		6	V
	Signal Input Terminals Voltage ⁽²⁾	(V-) - 0.5	(V+) + 0.5	V
	Signal Input Terminals Voltage ⁽³⁾	(V-) - 0.5	(V+) + 0.5	V
Current	Signal Input Terminals Current ⁽²⁾	-10	10	mA
	Signal output Terminals Current ⁽³⁾	-200	200	mA
	Output Short-Circuit ⁽⁴⁾	Continuous		
θ_{JA}	Operating Temperature Range	-25	125	°C
	Storage Temperature Range	-65	150	°C
	Junction Temperature	-40	150	°C

(1) Stresses above these ratings may cause permanent damage. Exposure to absolute maximum conditions for extended periods may degrade device reliability. These are stress ratings only, and functional operation of the device at these or any other conditions beyond those specified is not implied.

(2) Input terminals are diode clamped to the power-supply rails. Input signals that can swing more than 0.5V beyond the supply rails should be current limited to 10mA or less.

(3) Output terminals are diode-clamped to the power-supply rails. Output signals that can swing more than 0.5V beyond the supply rails should be current-limited to ± 200 mA or less.

(4) Short-circuit to ground, one amplifier per package.

ESD Ratings

			VALUE	UNIT
$V_{(ESD)}$	Electrostatic discharge	Human-Body Model (HBM)	± 4000	V
		Charged-Device Model (CDM)	± 500	V
		Machine Model	100	V

Recommended Operating Conditions

		MIN	MAX	UNIT
Supply voltage, $V_s = (V+) - (V-)$	Single-supply	2	5.5	V
	Dual-supply	± 1	± 2.75	V

ELECTRICAL CHARACTERISTICS(V_S = +5V)

 At T_A = 25°C, V_{CM}=V_{OUT}= V_S /2, unless otherwise noted.

PARAMETER	CONDITIONS	MIN	TYP	MAX	UNIT	
OFFSET VOLTAGE						
V _{OS}	Input Offset Voltage		2	10	μV	
dV _{OS} /dT	Input Offset Voltage Average Drift	T _A = -25°C to 125°C	0.03		μV/°C	
INPUT CURRENT						
I _B	Input Bias Current		500		pA	
I _{OS}	Input Offset Current		50		pA	
NOISE						
V _N	Input Voltage Noise	f=0.1Hz to 10Hz	0.3		μV _{PP}	
e _n	Input Voltage Noise Density	f=1kHz	6		nV/√Hz	
INPUT VOLTAGE						
V _{CM}	Common-Mode Voltage Range		V _S -0.1	V _S +0.1	V	
CMRR	Common-Mode Rejection Ratio	V _{CM} =0.1V to 4V	110	130	dB	
FREQUENCY RESPONSE						
GBW	Gain-Bandwidth Product	C _L =100pF		6	MHz	
SR	Slew Rate	G = +1, V _{IN} =2V Step		5	V/us	
t _s	Settling Time to 0.1%	G = +1, V _{IN} =2V Step		0.7	us	
THD+N	Total Harmonic Distortion +Noise	G=1, V _O =1V _{RMS} , f=1kHz, R _L =10kΩ		0.0004	%	
OUTPUT						
A _v	Open-Loop Voltage Gain	V _{OUT} =0.1V to 4.9V R _L =10kΩ	135	150	dB	
V _{OH}	High output voltage swing	R _L =10kΩ		10	20	mV
		R _L =2kΩ		50	60	mV

V _{OL}	Low output voltage swing	R _L =10kΩ		10	20	mV
		R _L =2kΩ		35	45	mV
I _{sc}	Output Short-Circuit Current	Source current		30		mA
		Sink current		65		mA
C _L ⁽¹⁾	Capacitive Load Drive	G = +1, V _{IN} =0.2V Step			560	pF
POWER SUPPLY						
PSRR	Power-Supply Rejection Ratio	V _S =1.5V to 5.5V	110	130		dB
V _S	Operating Voltage Range		2		5.5	V
I _Q	Quiescent Current/Amplifier	I _O =0A		600	700	uA

(1) Capacitive load drive means that above a given maximum value, the output waveform will oscillate under the step response.

TYPICAL CHARACTERISTICS

At $T_A = 25^\circ\text{C}$, $V_S = +5\text{V}$, $G=+1$, $V_{IN}=V_{OUT}= V_S / 2$, unless otherwise noted.

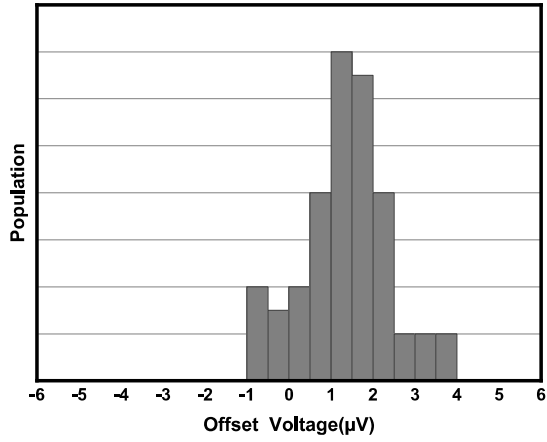

Figure 2. Offset Voltage Production Distribution

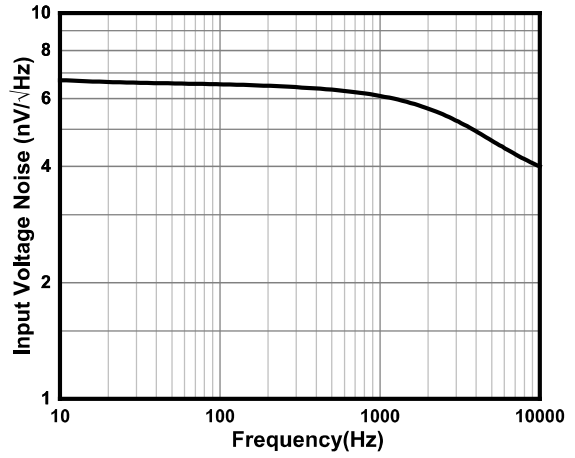

Figure 3. Input Voltage Noise Spectral Density

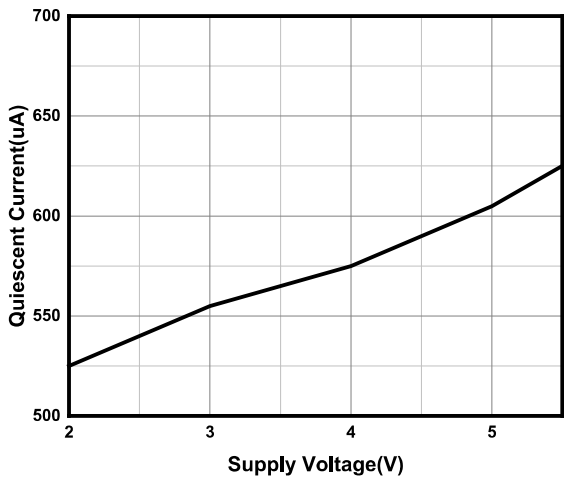

Figure 4. Quiescent Current vs Supply Voltage

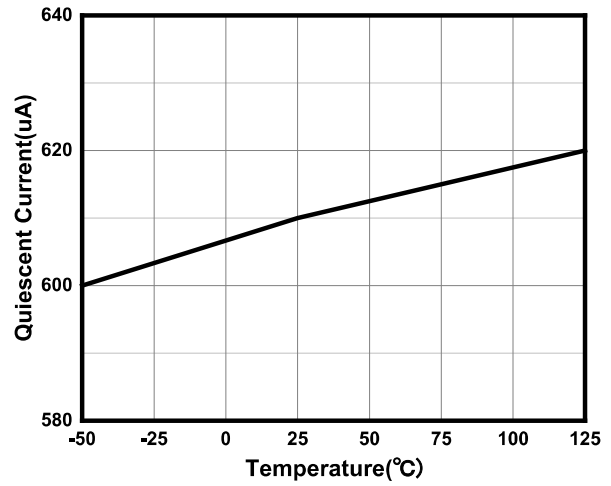

Figure 5. Quiescent Current vs Temperature

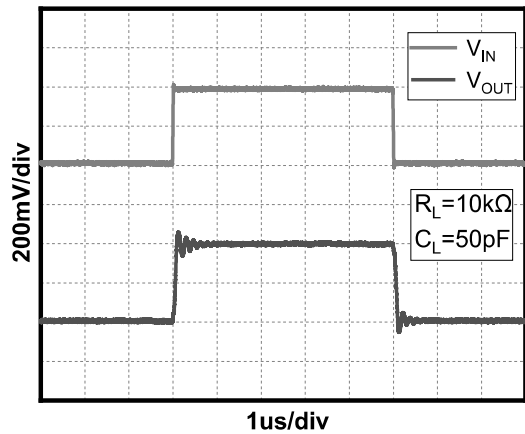

Figure 6. Small-Signal Step Response($V_S=5\text{V}$)

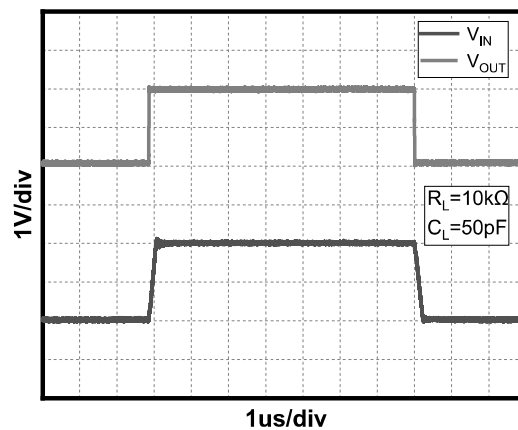
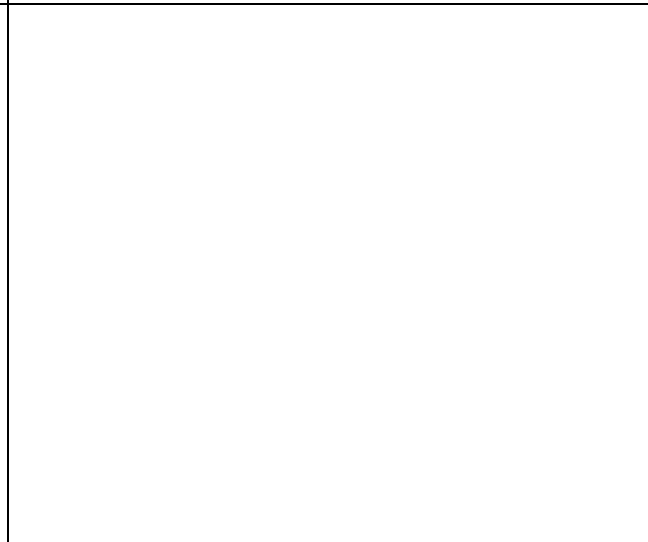
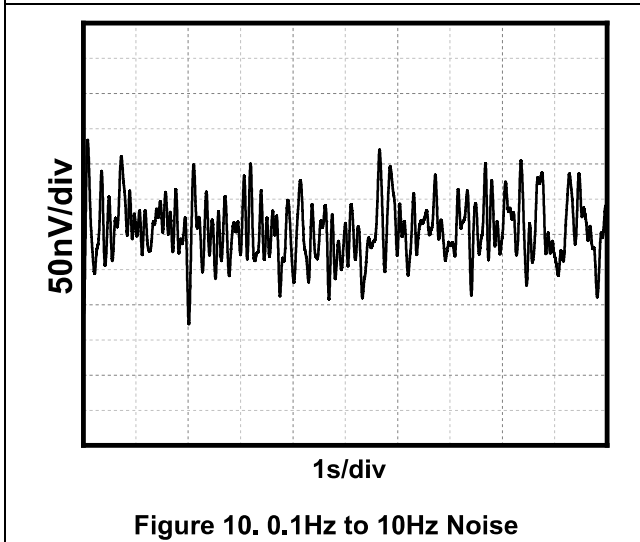
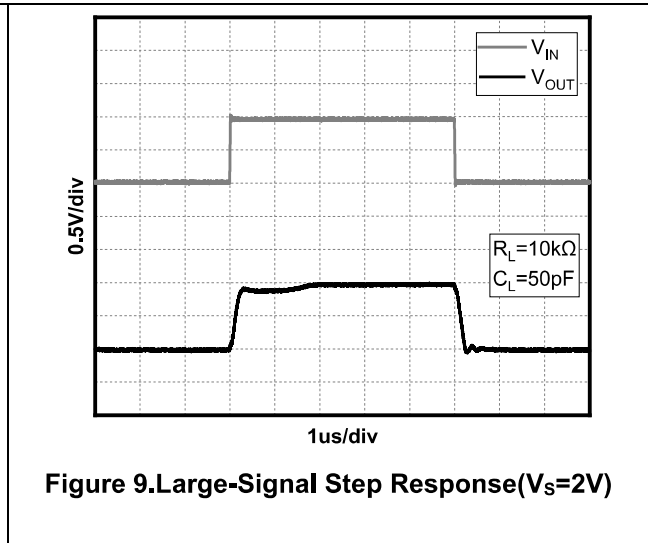
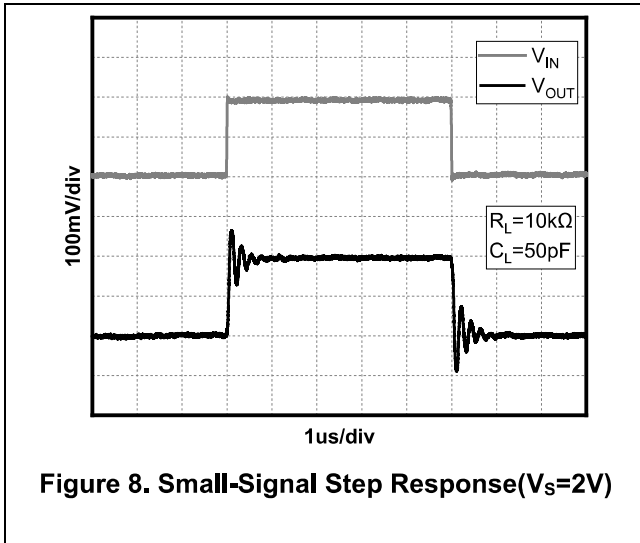

Figure 7. Large-Signal Step Response($V_S=5\text{V}$)

TYPICAL CHARACTERISTICS

At $T_A = 25^\circ\text{C}$, $V_S = +5\text{V}$, $G=+1$, $V_{IN}=V_{OUT}= V_S /2$, unless otherwise noted.



Detailed Description

Overview

The OPA376AIDBVR-MS OPA2376AIDR-MS devices are a low noise, unity-gain stable, rail-to-rail precision operational amplifier that operate in a single-supply voltage range of 2V to 5.5V ($\pm 1V$ to $\pm 2.75V$). A high supply voltage of 6V (absolute maximum) can permanently damage the amplifier. Rail-to-rail input and output wobbles significantly increase the dynamic range, especially in low-supply applications. Good layout practices require that a 0.1uF capacitor be used where it is tightly threaded through the power supply pin.

Phase Reversal Protection

The OPA376AIDBVR-MS OPA2376AIDR-MS devices have internal phase-reversal protection. Many op amps exhibit phase reversal when the input is driven beyond the linear common-mode range. This condition is most often encountered in noninverting circuits when the input is driven beyond the specified common-mode voltage range, causing the output to reverse into the opposite rail. The input of the OPA376AIDBVR-MS OPA2376AIDR-MS prevents phase reversal with excessive common-mode voltage. Instead, the appropriate rail limits the output voltage.

Typical Applications

1 Voltage Follower

As shown in Figure 11, the voltage gain is 1. With this circuit, the output voltage V_{OUT} is configured to be equal to the input voltage V_{IN} . Due to the high input impedance and low output impedance, the circuit can also stabilize the output voltage, the output voltage expression is

$$V_{OUT} = V_{IN} \quad (1)$$

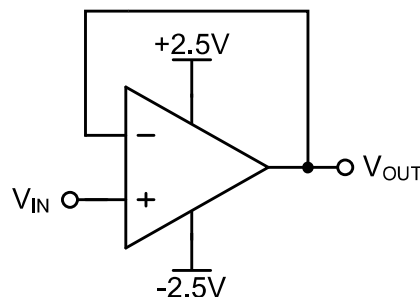

2 Inverting Proportional Amplifier

As shown in Figure 12, for a reverse-phase proportional amplifier, the input voltage V_{IN} is amplified by a voltage gain that depends on the ratio of R_1 to R_2 . The output voltage V_{OUT} is inversely with the input voltage V_{IN} . The input impedance of the circuit is equal to R_1 , and the output voltage expression is

(2)

$$V_{OUT} = -\frac{R_2}{R_1} V_{IN}$$

PACKAGE DESCRIPTION

SOT23-5

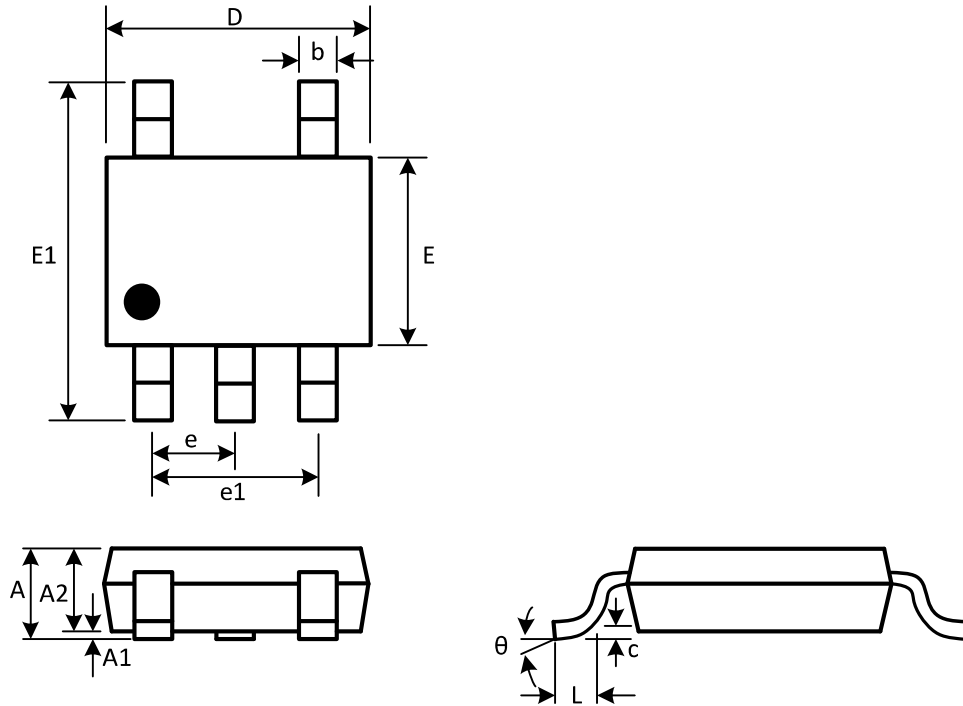

(Unit: mm)

Symbol	Min	Max
A	1.050	1.250
A1	0.000	0.100
A2	1.050	1.150
b	0.300	0.500
c	0.100	0.200
D	2.820	3.020
e	0.950(BSC)	
e1	1.800	2.000
E	1.500	1.700
E1	2.650	2.950
L	0.300	0.600
θ	0°	8°

SOP-8

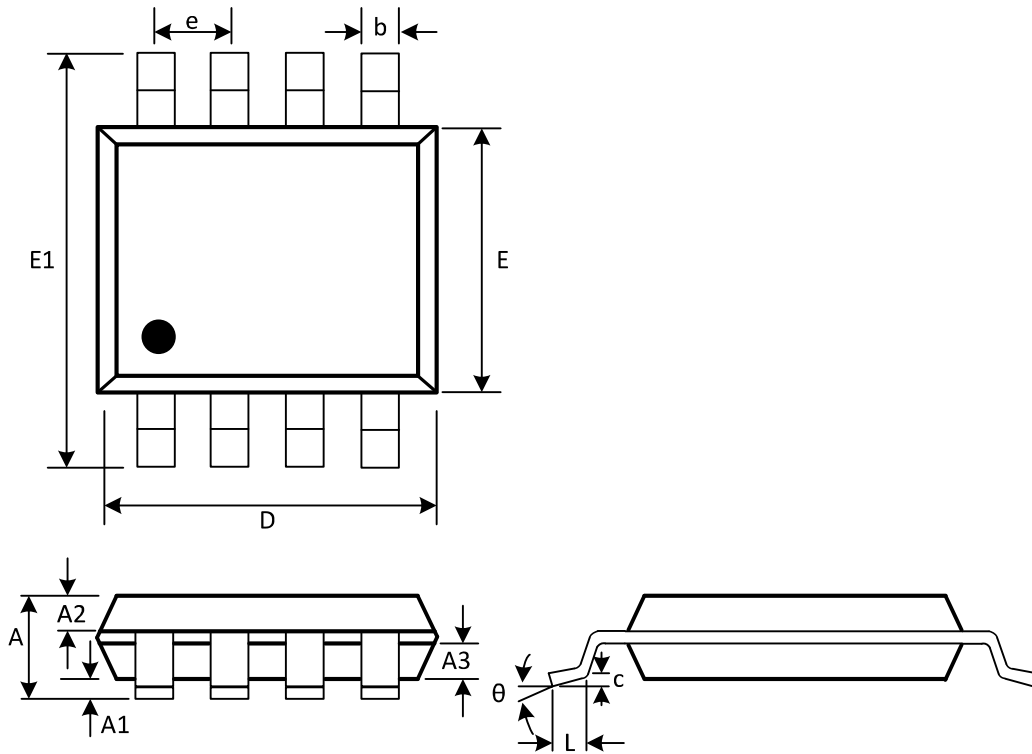

(Unit: mm)

Symbol	Min	Max
A	1.300	1.600
A1	0.050	0.200
A2	0.550	0.650
A3	0.550	0.650
b	0.356	0.456
c	0.203	0.233
D	4.800	5.000
e	1.270(BSC)	
E	3.800	4.000
E1	5.800	6.200
L	0.400	0.800
θ	0°	8°

Attention

- Any and all MSKSEMI Semiconductor products described or contained herein do not have specifications that can handle applications that require extremely high levels of reliability, such as life-support systems, aircraft's control systems, or other applications whose failure can be reasonably expected to result in serious physical and/or material damage. Consult with your MSKSEMI Semiconductor representative nearest you before using any MSKSEMI Semiconductor products described or contained herein in such applications.
- MSKSEMI Semiconductor assumes no responsibility for equipment failures that result from using products at values that exceed, even momentarily, rated values (such as maximum ratings, operating condition ranges, or other parameters) listed in products specifications of any and all MSKSEMI Semiconductor products described or contained herein.
- Specifications of any and all MSKSEMI Semiconductor products described or contained herein stipulate the performance, characteristics, and functions of the described products in the independent state, and are not guarantees of the performance, characteristics, and functions of the described products as mounted in the customer's products or equipment. To verify symptoms and states that cannot be evaluated in an independent device, the customer should always evaluate and test devices mounted in the customer's products or equipment.
- MSKSEMI Semiconductor strives to supply high-quality high-reliability products. However, any and all semiconductor products fail with some probability. It is possible that these probabilistic failures could give rise to accidents or events that could endanger human lives, that could give rise to smoke or fire, or that could cause damage to other property. When designing equipment, adopt safety measures so that these kinds of accidents or events cannot occur. Such measures include but are not limited to protective circuits and error prevention circuits for safe design, redundant design, and structural design.
- In the event that any or all MSKSEMI Semiconductor products (including technical data, services) described or contained herein are controlled under any of applicable local export control laws and regulations, such products must not be exported without obtaining the export license from the authorities concerned in accordance with the above law.
- No part of this publication may be reproduced or transmitted in any form or by any means, electronic or mechanical, including photocopying and recording, or any information storage or retrieval system, or otherwise, without the prior written permission of MSKSEMI Semiconductor.
- Information (including circuit diagrams and circuit parameters) herein is for example only ; it is not guaranteed for volume production. MSKSEMI Semiconductor believes information herein is accurate and reliable, but no guarantees are made or implied regarding its use or any infringements of intellectual property rights or other rights of third parties.
- Any and all information described or contained herein are subject to change without notice due to product/technology improvement, etc. When designing equipment, refer to the "Delivery Specification" for the MSKSEMI Semiconductor product that you intend to use.

X-ON Electronics

Largest Supplier of Electrical and Electronic Components

Click to view similar products for [Operational Amplifiers - Op Amps category](#):

Click to view products by [MSKSEMI manufacturer](#):

Other Similar products are found below :

[430227FB](#) [LT1678IS8](#) [NCV33202DMR2G](#) [NJM324E](#) [M38510/13101BPA](#) [NTE925](#) [AZV358MTR-G1](#) [AP4310AUMTR-AG1](#)
[AZV358MMTR-G1](#) [SCY33178DR2G](#) [NCV20034DR2G](#) [NTE778S](#) [NTE871](#) [NTE937](#) [NJU7057RB1-TE2](#) [SCY6358ADR2G](#)
[NJM2904CRB1-TE1](#) [UPC4570G2-E1-A](#) [UPC4741G2-E1-A](#) [UPC4574GR-9LG-E1-A](#) [NJM8532RB1-TE1](#) [EL2250CS](#) [EL5100IS](#) [EL5104IS](#)
[EL5127CY](#) [EL5127CYZ](#) [EL5133IW](#) [EL5152IS](#) [EL5156IS](#) [EL5162IS](#) [EL5202IY](#) [EL5203IY](#) [EL5204IY](#) [EL5210CS](#) [EL5210CYZ](#)
[EL5211IYE](#) [EL5220CY](#) [EL5223CLZ](#) [EL5223CR](#) [EL5224ILZ](#) [EL5227CLZ](#) [EL5227CRZ](#) [EL5244CS](#) [EL5246CS](#) [EL5246CSZ](#) [EL5250IY](#)
[EL5251IS](#) [EL5257IS](#) [EL5260IY](#) [EL5261IS](#)