

MSKSEMI 美森科

SEMICONDUCTOR



ESD



TVS



TSS



MOV



GDT



PLED

PC817x-MS

产品手册

特征

- 电流转换比(CTR: 最小 50% 工作条件 $I_F=5\text{mA}$, $V_{CE}=5\text{V}$)
- 绝缘电压: ($V_{ISO}=5,000\text{Vrms}$)
- 响应时间 (t_r : TYP. $6\mu\text{s}$; t_f : TYP. $5\mu\text{s}$)工作条件 $V_{CE}=2\text{V}$, $I_C=2\text{mA}$, $R_L=100\ \Omega$)
- ESD : HBM8000V&MM2000V



说明

- PC 817 系列光耦合器的组成是: 由一个 GaAs 的发射管和一个 NPN 的晶体管组成;
- PC 817 的引脚中心距是 2.54mm;

应用范围

- 开关电源.
- 电表.
- 电脑.
- 器具的应用, 测量机.
- 贮存器, 复印机, 自动售货机.
- 家用电器, 如风扇等.
- 信号传输系统.

参考信息

封装	丝印
 DIP-4	 说明: 印字中的“x”代表产品 CTR 分档: A、B、C、D 等; ***代表批次号;
 SOP-4	

框架结构

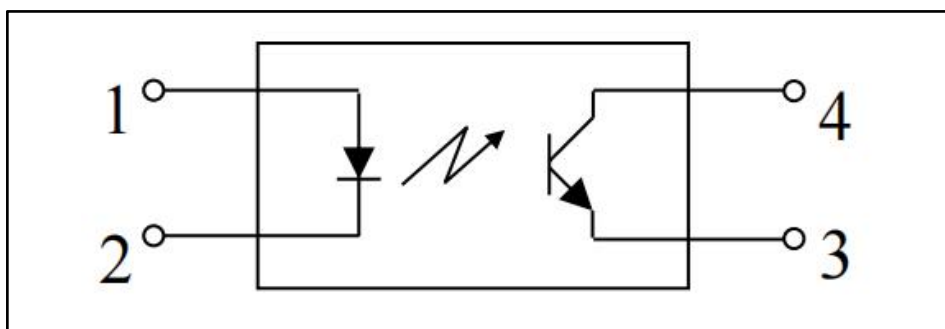

最大绝对额定值 (常温=25℃)

参数 Parameter		符号 Symbol	额定值 Rated Value	单位 Unit
输入 Inout	正向电流 Forward Current	I_F	50	mA
	反向电压 Reverse Voltage	V_R	6	V
	功耗率 Consume Power	P	70	mW
输出 Output	集极与射极电压 Collector and emitter Voltage	V_{CEO}	35	V
	射极与集极电压 Emitter and collector Voltage	V_{ECO}	6	
	集极电流 Collector Current	I_C	50	mA
	消耗功率 Consume Power	P_C	150	mW
总功率消耗 Total Consume Power		P_{tot}	200	mW
*1 绝缘电压 Insulation Voltage		V_{iso}	5,000	V_{rms}
最大绝缘电压 Max Insulation Voltage		V_{IOTM}	6,000	V
额定脉冲绝缘电压 Rated Impulse Insulation Voltage		V_{IORM}	630	V
工作温度 Working Temperature		T_{opr}	-55 to +110	℃
存贮温度 Deposit Temperature		T_{stg}	-55 to +125	
*2 焊锡温度 Soldering Temperature		T_{sol}	260	

*1. 交流测试, 时间 1 分钟, 湿度. =40~60% AC Test, 1 minute, humidity = 40~60%

如下是绝缘测试的方法. Insulation test method as below:

- (1) 将产品的两端短路。 Short circuit both terminals of photocoupler
- (2) 测试绝缘电压时无电流通过。 No Current when testing insulation voltage
- (3) 测试时加正弦波形电压。 Adding sine wave voltage when testing

*2. 锡焊时间为 10 秒 soldering time is 10 seconds

光电特性 (常温=25℃)

参数 Parameter		符号 Symbol	条件 Condition	最小 Min	中. Midium	最大 Max	单位 Unit
输入 Input	正向电压 Forward Current	V_F	$I_F=20mA$	---	1.20	1.40	V
	反向电压 Reverse Voltage	I_R	$V_R=5V$	---	---	5	uA
	集极电容 Collector capacitance	C_t	$V=0, f=1MHz$	---	30	250	pF
输出 Output	集极至射极电流 Collector to emitter Current	I_{CEO}	$V_{CE}=70V, I_F=0mA$	---	---	150	nA
	集极与射极衰减 电压 Collector and Emitter attenuation Voltage	BV_{CEO}	$I_C=0.1mA, I_F=0mA$	70	---	---	V
	射极与集极衰减电压 Emitter and Collector attenuation Voltage	BV_{ECO}	$I_E=10\mu A, I_F=0mA$	6	---	---	V

传输特性 Transforming Characteristics	*1 电流转换比 Current conversion ratio	CTR	IF=5mA VCE=5V	50	---	600	%
	集极与射极饱和电压 Collector and Emitter Saturation Voltage	V _{CE(sat)}	I _F =20mA I _C =1mA	---	0.1	0.2	V
	绝缘阻抗 Insulation Impedance	R _{iso}	DC500V 40~60%R.H.	5×10 ¹⁰	1×10 ¹¹	---	Ω
	电容量 capacitance	C _f	V=0, f=1MHz	---	0.6	1	pF
	转换频率 Transforming Frequency	f _c	V _{CE} =5V, I _C =2mA R _L =100Ω, -3dB	---	80	---	kHz
	上升时间 Rise time	t _r	V _{CE} =2V, I _C =2mA	---	6	18	μs
	下降时间 Descend Time	t _f	R _L =100Ω	---	5	18	μs

电流转换比 Current Conversion Ratio = $I_C / I_F \times 100\%$

电流转换比的等级分类 Grades of Current conversion ratio

等级标示 Grade Sign	最小 . Min (%)	最大 . Max (%)
A	100	160
B	130	260
C	200	400
D	300	600
A or B or C or D	50	600

说明 : 工作条件: I_F=5mA, V_{CE}=5V, T_a=25°C.

Note: Working condition: I_F=5mA, V_{CE}=5V, T_a=25°C.

RATING AND CHARACTERISTIC CURVES (PC817)

Fig.1 Forward Current vs. Ambient Temperature

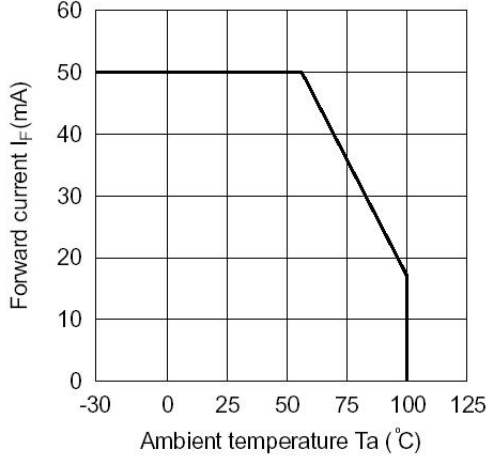

Fig.2 Collector Power Dissipation vs. Ambient Temperature

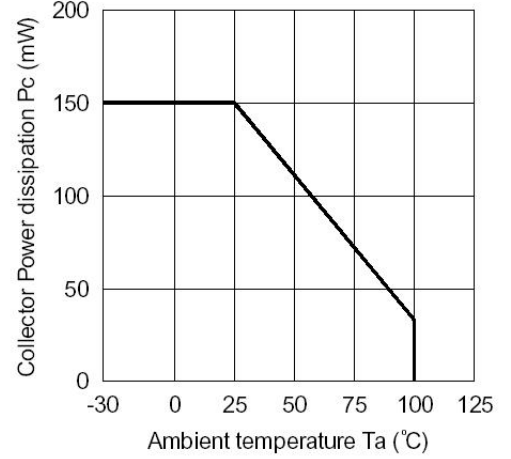

Fig.3 Collector-emitter Saturation Voltage vs. Forward Current

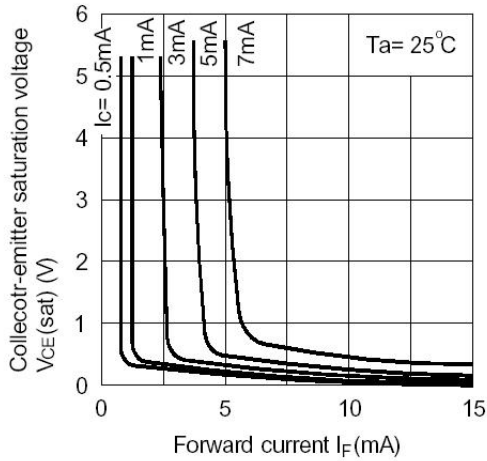

Fig.4 Forward Current vs. Forward Voltage

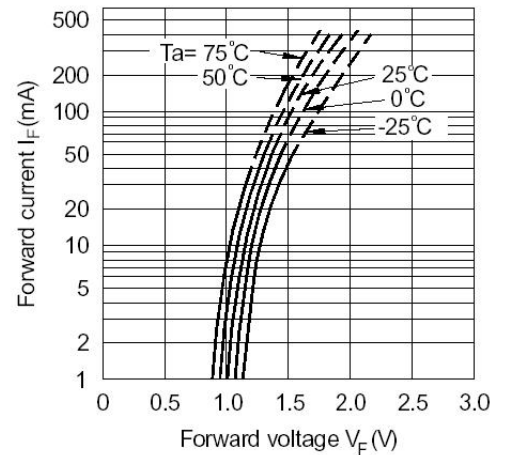

Fig.5 Current Transfer Ratio vs. Forward Current

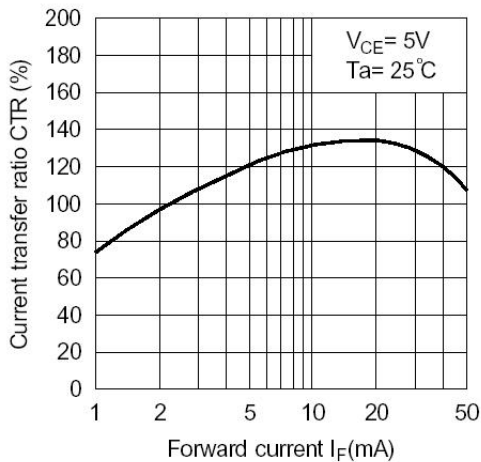
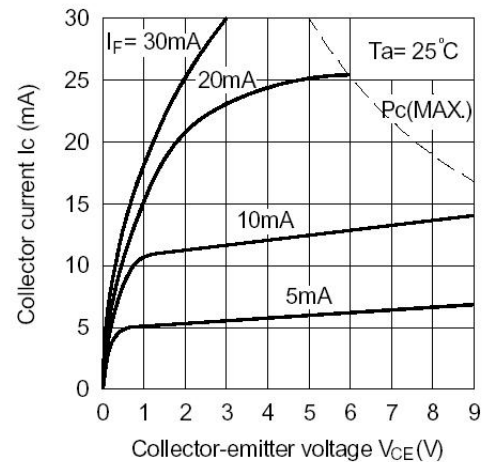

Fig.6 Collector Current vs. Collector-emitter Voltage



RATING AND CHARACTERISTIC CURVES (PC817)

Fig.1 Forward Current vs. Ambient Temperature

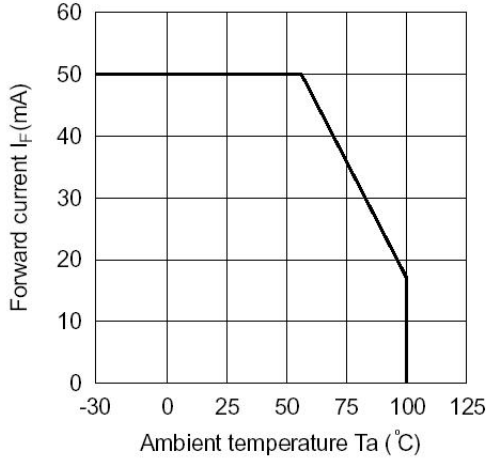

Fig.2 Collector Power Dissipation vs. Ambient Temperature

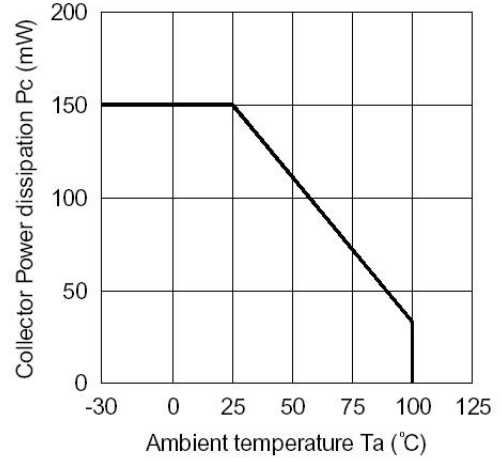

Fig.3 Collector-emitter Saturation Voltage vs. Forward Current

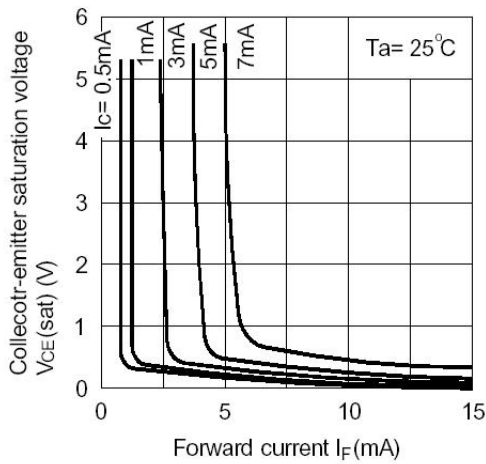

Fig.4 Forward Current vs. Forward Voltage

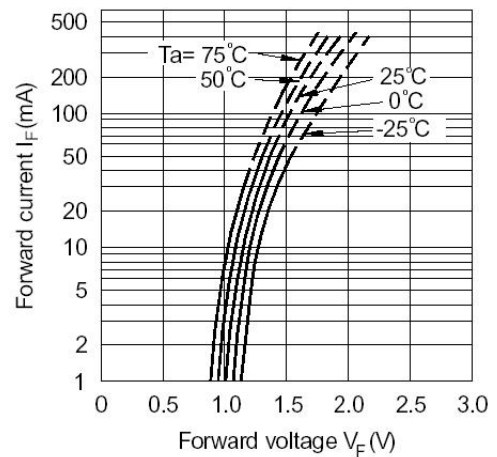

Fig.5 Current Transfer Ratio vs. Forward Current

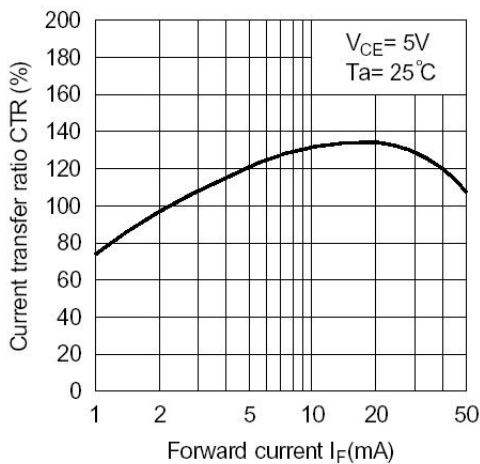
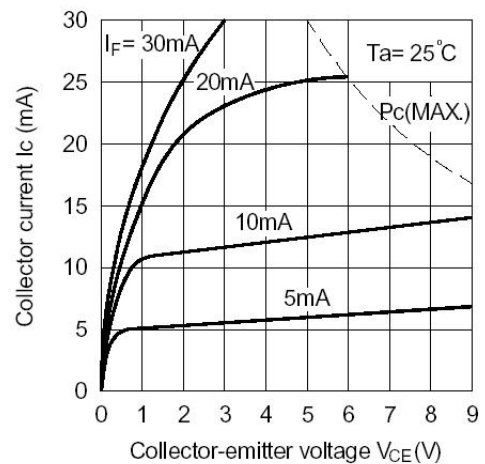

Fig.6 Collector Current vs. Collector-emitter Voltage



RATING AND CHARACTERISTIC CURVES (PC817)

Fig.7 Relative Current Transfer Ratio vs. Ambient Temperature

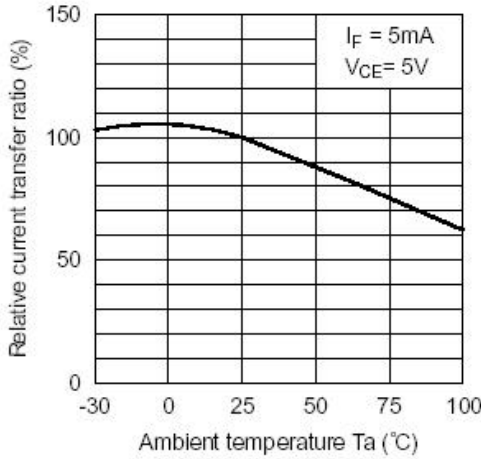

Fig.8 Collector-emitter Saturation Voltage vs. Ambient Temperature

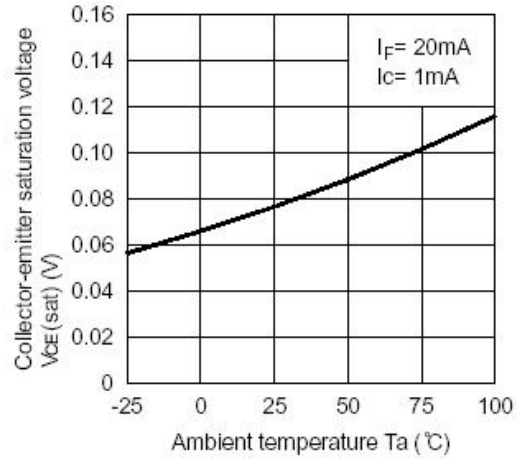

Fig.9 Collector Dark Current vs. Ambient Temperature

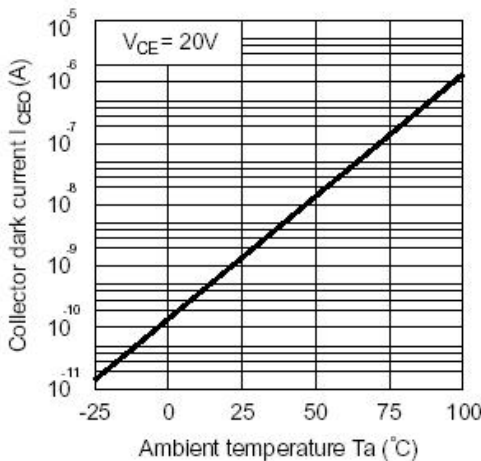

Fig.10 Response Time vs. Load Resistance

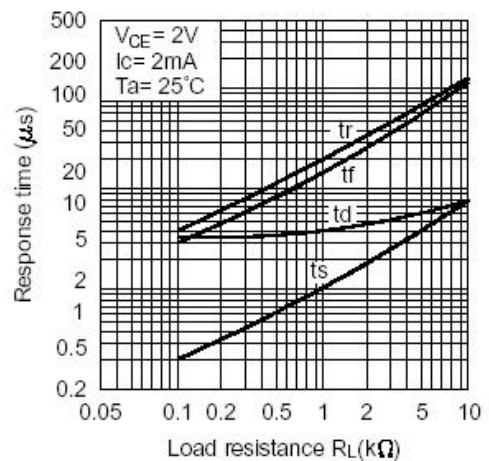
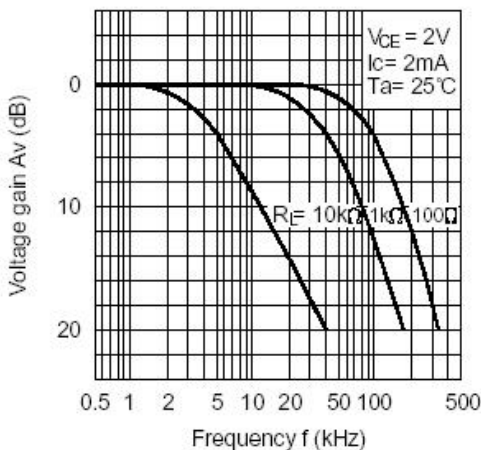
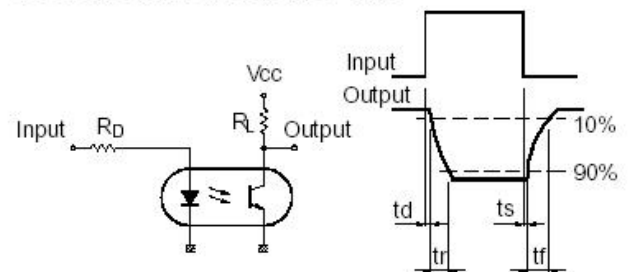

Fig.11 Frequency Response



Test Circuit for Response Time



Test Circuit for Frequency Response

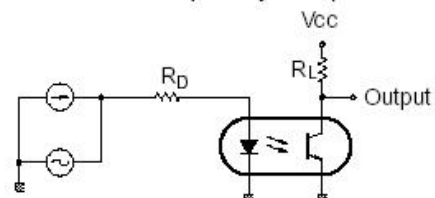

外形尺寸

Unit: mm (inch)

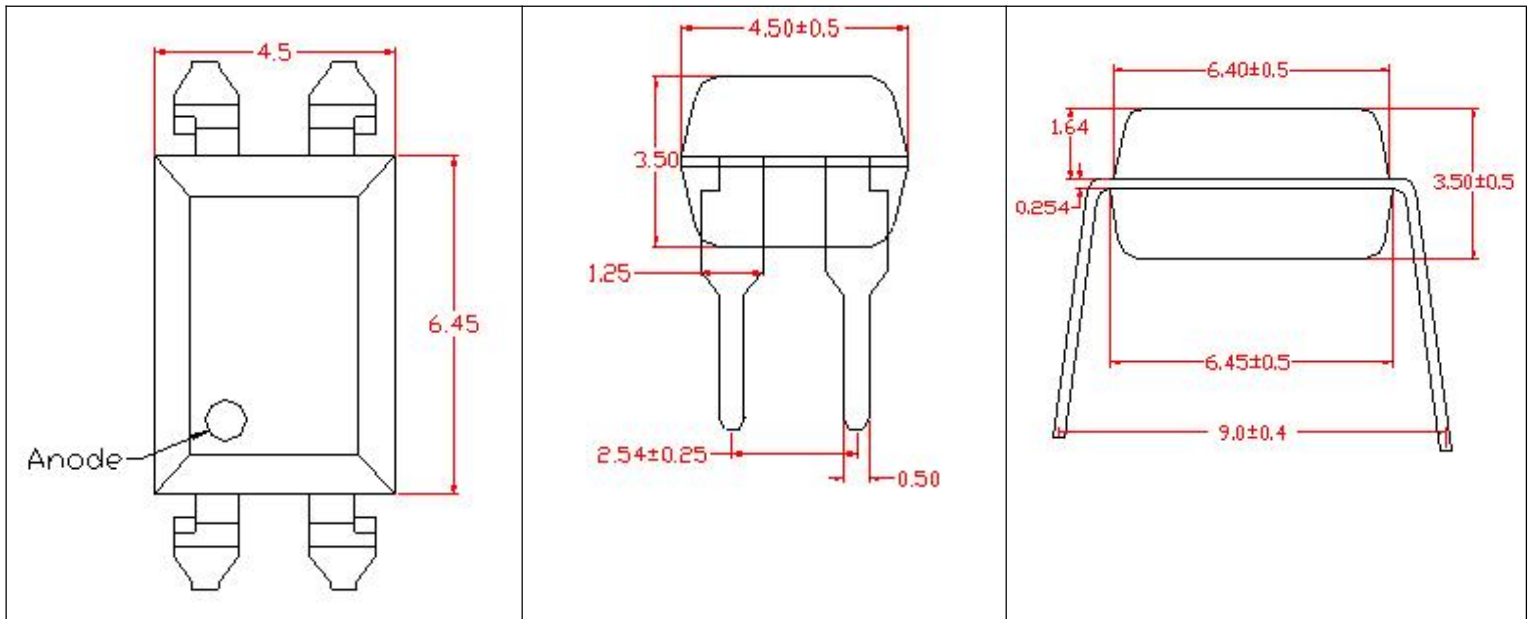

DIP-4

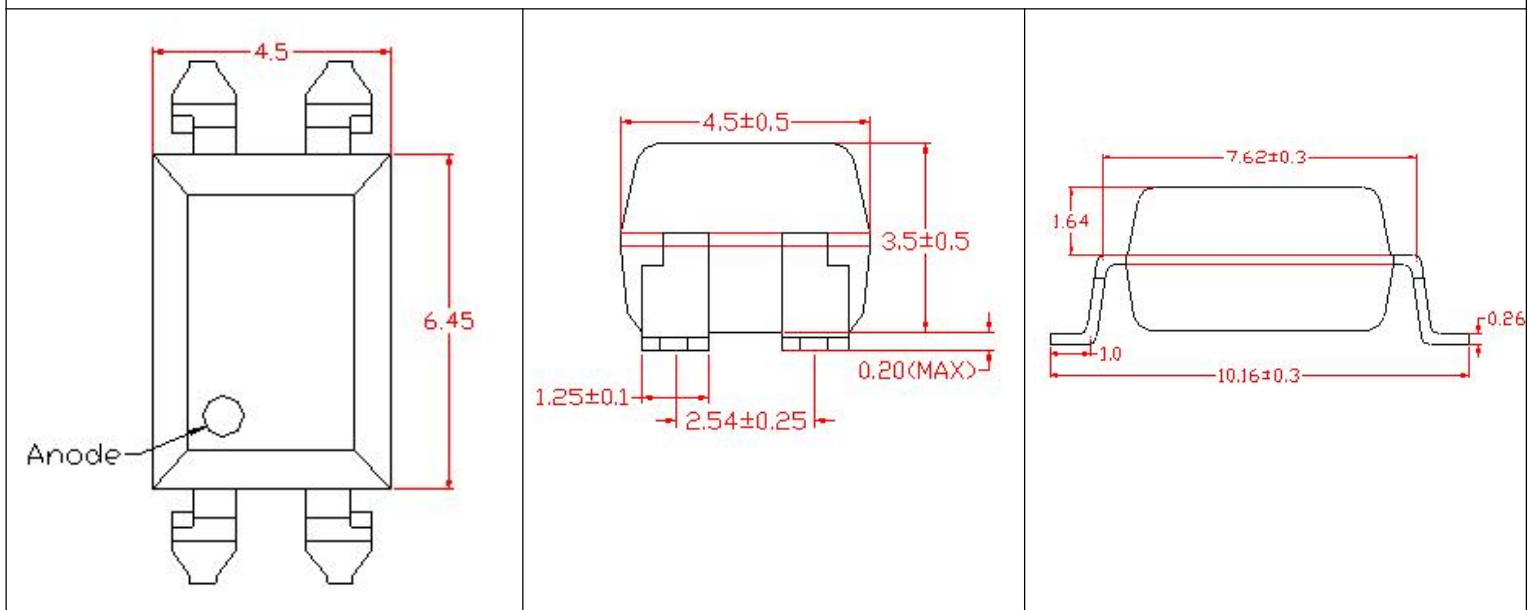

SOP-4

产品订购信息

产品名称	封装	包装	最小包装	包装数量
PC817X-MS	DIP-4	管装	100PCS/管	1000PCS/盒
PC817X-MS	SOP-4	卷盘	2000PCS/盘	10000PCS/盒

Attention

- Any and all MSKSEMI Semiconductor products described or contained herein do not have specifications that can handle applications that require extremely high levels of reliability, such as life-support systems, aircraft's control systems, or other applications whose failure can be reasonably expected to result in serious physical and/or material damage. Consult with your MSKSEMI Semiconductor representative nearest you before using any MSKSEMI Semiconductor products described or contained herein in such applications.
- MSKSEMI Semiconductor assumes no responsibility for equipment failures that result from using products at values that exceed, even momentarily, rated values (such as maximum ratings, operating condition ranges, or other parameters) listed in products specifications of any and all MSKSEMI Semiconductor products described or contained herein.
- Specifications of any and all MSKSEMI Semiconductor products described or contained herein stipulate the performance, characteristics, and functions of the described products in the independent state, and are not guarantees of the performance, characteristics, and functions of the described products as mounted in the customer's products or equipment. To verify symptoms and states that cannot be evaluated in an independent device, the customer should always evaluate and test devices mounted in the customer's products or equipment.
- MSKSEMI Semiconductor strives to supply high-quality high-reliability products. However, any and all semiconductor products fail with some probability. It is possible that these probabilistic failures could give rise to accidents or events that could endanger human lives, that could give rise to smoke or fire, or that could cause damage to other property. When designing equipment, adopt safety measures so that these kinds of accidents or events cannot occur. Such measures include but are not limited to protective circuits and error prevention circuits for safe design, redundant design, and structural design.
- In the event that any or all MSKSEMI Semiconductor products (including technical data, services) described or contained herein are controlled under any of applicable local export control laws and regulations, such products must not be exported without obtaining the export license from the authorities concerned in accordance with the above law.
- No part of this publication may be reproduced or transmitted in any form or by any means, electronic or mechanical, including photocopying and recording, or any information storage or retrieval system, or otherwise, without the prior written permission of MSKSEMI Semiconductor.
- Information (including circuit diagrams and circuit parameters) herein is for example only ; it is not guaranteed for volume production. MSKSEMI Semiconductor believes information herein is accurate and reliable, but no guarantees are made or implied regarding its use or any infringements of intellectual property rights or other rights of third parties.
- Any and all information described or contained herein are subject to change without notice due to product/technology improvement, etc. When designing equipment, refer to the "Delivery Specification" for the MSKSEMI Semiconductor product that you intend to use.

X-ON Electronics

Largest Supplier of Electrical and Electronic Components

Click to view similar products for [Photodiode Output Optocouplers](#) category:

Click to view products by [MSKSEMI](#) manufacturer:

Other Similar products are found below :

[TLP590B\(C,F\)](#) [TLP7820\(A-LF4.E\(O](#) [LTV-244-GB-G](#) [LTV2301GB-V-G](#) [EL816S1\(C\)\(TU\)](#) [EL817S1\(C\)\(TU\)-VG](#) [GX357NC](#) [PC817B](#)
[PC817C](#) [LTV-341W-TA1-H](#) [LTV-176G](#) [LTV-1003-TP1-G](#) [LTV-247-G-RT](#) [PC817B-MS](#) [FOC-817C-F](#) [CYPS2501-1\(K\)](#)
[CYTLP2362\(TPD2\)](#) [OR-3H7C-TP-G-\(GK\)](#) [ORPC-817MC-F](#) [ORPC-817D-C](#) [ORPC-817SB-TP-F](#) [PS2801C-4-F3-A/M](#) [PC817B](#)
[TLP183\(YH-TPL,E\(T](#) [TLP183\(GRH-TPL,E\(T](#) [TLP183\(TPL,E\(T](#) [TLP184\(V4GBTL,SE\(T](#) [TLP785\(BLL-TP6,F\(C](#) [TLP293\(GRH-TPL,E\(T](#)
[TLP383\(D4GL-TR,E](#) [TLP185\(BLL-TL,SE\(T](#) [TLP2309\(TPL,E\(O](#) [TLP785\(BL-TP6,F\(C](#) [TLP185\(GRL-TL,SE\(T](#) [TLP785\(GR-TP6,F\(C](#)
[TLP183\(BL-TPL,E\(T](#) [TLP2398\(TPL,E\(T](#) [TLP127GB-S](#) [LTV-354T-A\(UMW\)](#) [6N136S\(UMW\)](#) [PC817B-S](#) [FOC-817C](#) [EL1018](#) [LTV-214-](#)
[TP1-AK-G](#) [LTV-316J-TP1](#) [PC817C-MS](#) [CYTLP181\(GR-TP\)](#) [CYPC357\(C-TR\)](#) [CYPC356\(B-TP\)](#) [CYPC357\(B-TP\)](#)