

BU-1420771831 (CONN SMA JACK STR 50 OHM EDGE MNT)

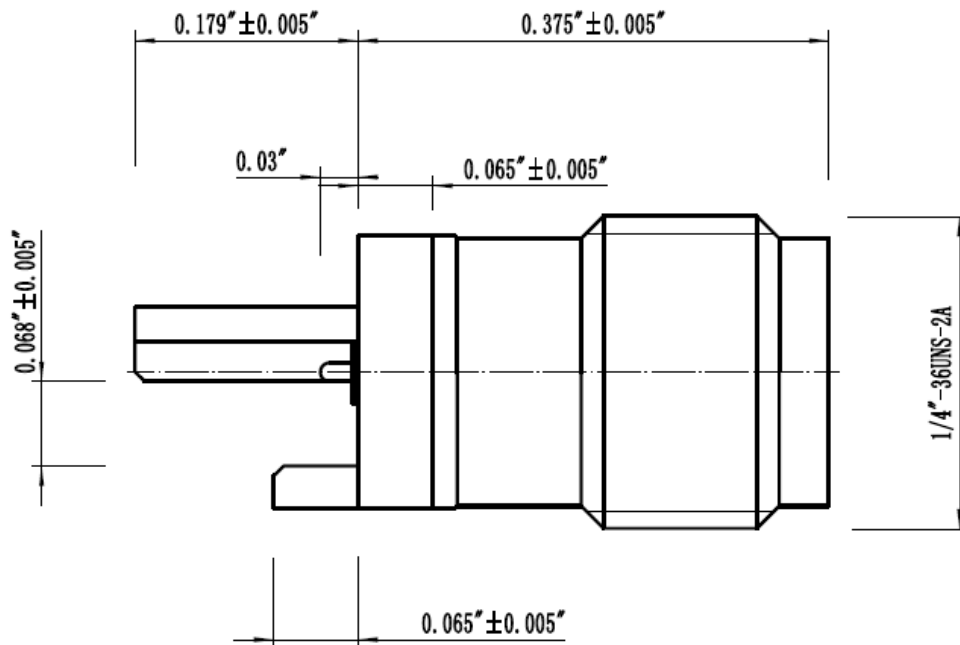

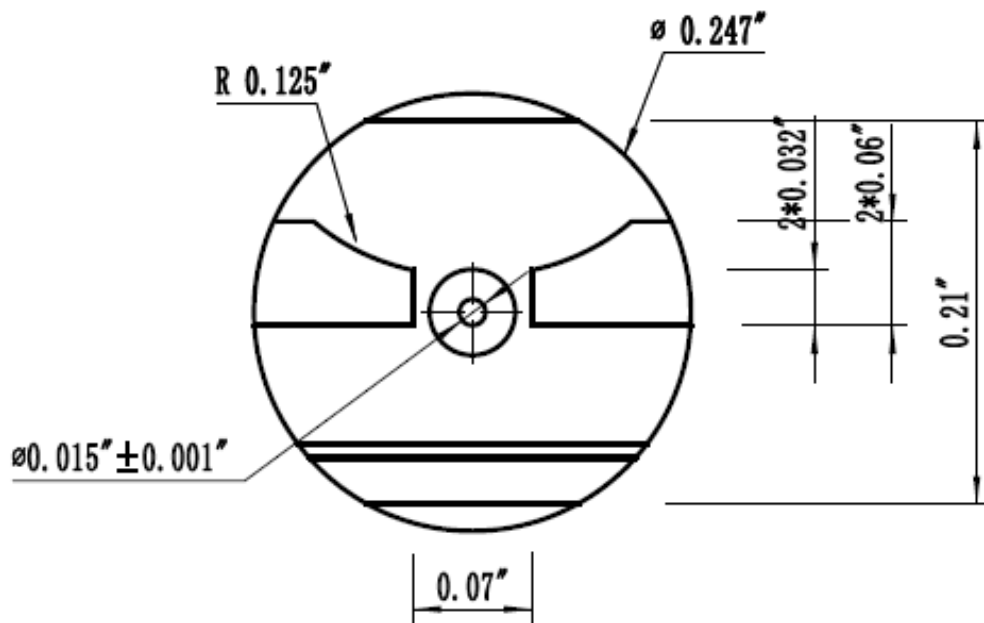

(Dimensions in Inches)

- Impedance: 50 Ohms
- Frequency Range: 0-18G
- Working Voltage: 335V at Sea Level
- Dielectric Withstanding Voltage: 1000V min at sea level
- Contact resistance: <3 milliohms
- Mating Torque: 7-10 Inch Pounds
- Material:
 - Body – 1U" Gold plated Brass
 - Contact – 5U" Gold plated Beryllium Copper
 - Insulator – Teflon
- Meets or Exceeds the applicable paragraph of MIL-C-39012
- Operating Temperature: -65°C (-85°F) to 150°C (302°F)
- RoHS 3 Compliant

X-ON Electronics

Largest Supplier of Electrical and Electronic Components

Click to view similar products for [RF Connectors / Coaxial Connectors](#) category:

Click to view products by [Mueller](#) manufacturer:

Other Similar products are found below :

[8915-1511-000](#) [89674-0827](#) [6001-7071-019](#) [6002-7051-003](#) [6059674-1](#) [619550-1](#) [630059-000](#) [M39030/3-01N](#) [6769](#) [CX050L2AQ](#) [7002-1541-010](#) [7002-1542-011](#) [7002-1572-002](#) [7003-1542-011](#) [7004-1512-000](#) [7009-1511-004](#) [7010-1511-000](#) [7029-1511-060](#) [7101-1541-010](#) [7101-1571-002](#) [7105-1521-002](#) [7145-1521-002](#) [7203-1571-003](#) [7209-1511-011](#) [7210-1511-015](#) [7210-1511-019](#) [7242-1511-000](#) [73137-5015](#) [73216-2241](#) [73404-2300](#) [7405-1521-005](#) [7405-1521-802](#) [8527](#) [8547](#) [FS11V](#) [877931](#) [9074-9513-000](#) [910A205F](#) [PL11SC-026](#) [PL40-5](#) [PL74C-221](#) [PL75MC-217](#) [PL803-7](#) [980-8666-005](#) [1200690078](#) [1-201144-1](#) [R107003010W](#) [R110A172100](#) [R112186000](#) [R113053000W](#)