



## FEATURES

- RoHS compliant
- 1.27µH to 17.6µH
- Up to 15.4A I<sub>DC</sub>
- Toroidal construction minimizes EMI
- Compact size
- Surface mount
- UL94 V-0 package materials
- Pick & place compatible
- J-STD-020C reflow
- Backward compatible with Sn/Pb soldering systems

## DESCRIPTION

The 4200 series is a range of surface mount toroidal inductors designed for use in switching power supplies and DC/DC converters. The parts are ideal for applications requiring low profile compact components in a surface mount package.

## SELECTION GUIDE

Order Code	Inductance (100kHz, 0.1V <sub>AC</sub> ) ±15% µH	DC Current <sup>1</sup> Max. A	DC Resistance Max. mΩ	SRF Min. MHz	Package Dimensions (Max.)			Pad Dimensions			Carrier Tape Dimensions			Package Weight Typ. g	Reel (Box) Quantity <sup>3</sup>
					A mm	B mm	C mm	D mm	E mm	F mm	G mm	H mm			
<b>Discontinued</b>															
42132C	1.27	14.3	2.5	244	15.70	9.4	15.37	12.70	11.18	20	24	9.5	3.5	300	
42212C	2.10	11.5	3.8	162	15.70	9.4	15.37	12.70	11.18	20	24	9.5	3.4	(60)	
42282C	2.84	13.9	3.5	116	17.00	9.9	17.00	14.48	12.45	24	32	10.5	5.0		
42422C	4.23	11.4	5.2	90	17.00	9.9	17.00	14.48	12.45	24	32	10.5	4.8	250	
42652C	6.5	12.4	6.0	57	18.80	9.9	18.80	16.26	14.20	24	32	10.7	6.8	(60)	
42842C	8.45	10.4	8.0	50	18.80	9.9	18.80	16.26	14.20	24	32	10.7	6.4		
42103C	10.2	15.4	6.0	38	23.88	9.9	23.88	21.08	17.78	32	44	1.08	12.3	180	
42183C	17.6	10.9	11.6	24	23.88	9.9	23.88	21.08	17.78	32	44	10.8	12.5	(35)	

## ABSOLUTE MAXIMUM RATINGS

Operating temperature range	-40°C to +125°C
Storage temperature range	-40°C to +130°C

## SOLDERING INFORMATION<sup>2</sup>

Peak reflow temperature	245°C
Pin finish	Pure tin dip
Moisture sensitivity level	1

All specifications typical at T<sub>A</sub>=25°C

- 1 Maximum DC current occurs when the temperature rise reaches 55°C.
- 2 For further information, please visit [www.murata-ps.com/rohs](http://www.murata-ps.com/rohs)
- 3 If components are required in tape & reel format, suffix order code with '-R', e.g. 42132C-R



For full details go to  
[www.murata-ps.com/rohs](http://www.murata-ps.com/rohs)

**INDUCTANCE Vs CURRENT**

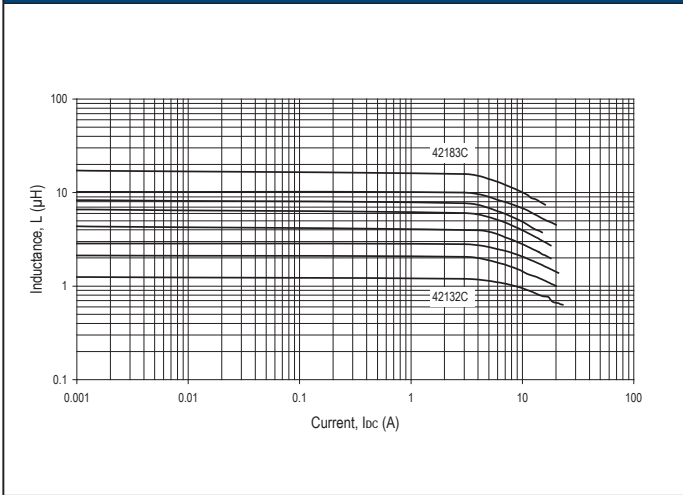

**INDUCTANCE Vs FREQUENCY**

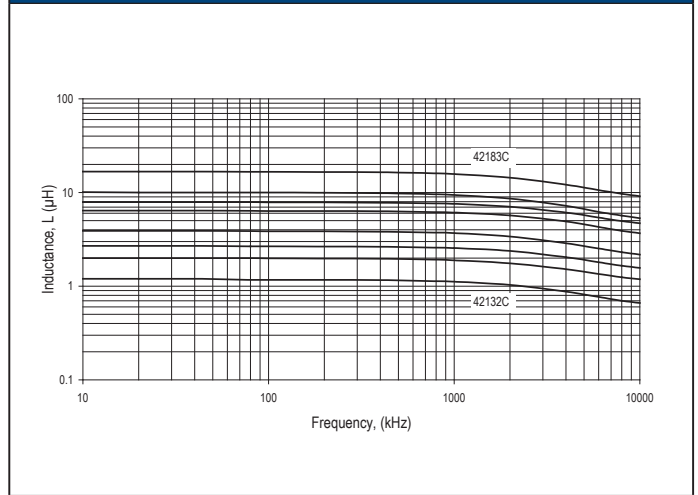

**TEMPERATURE Vs CURRENT**

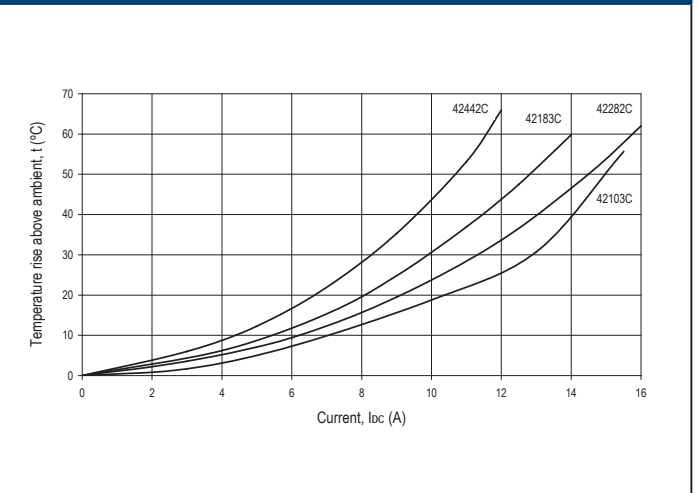
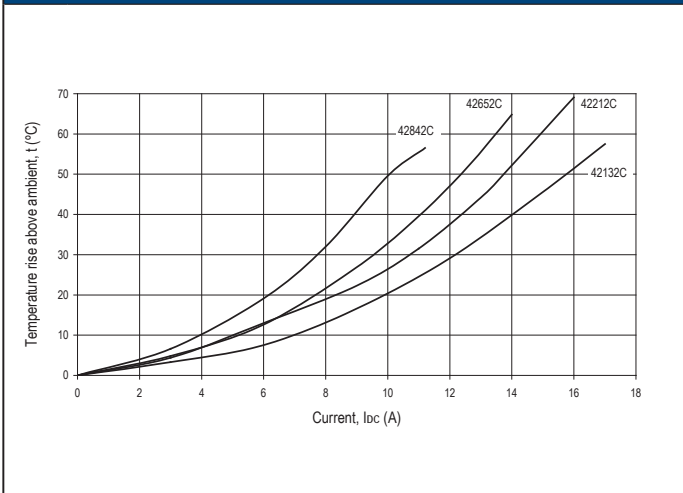

**PACKAGE SPECIFICATIONS**

**MECHANICAL DIMENSIONS**

See Selection Guide for dimensions.

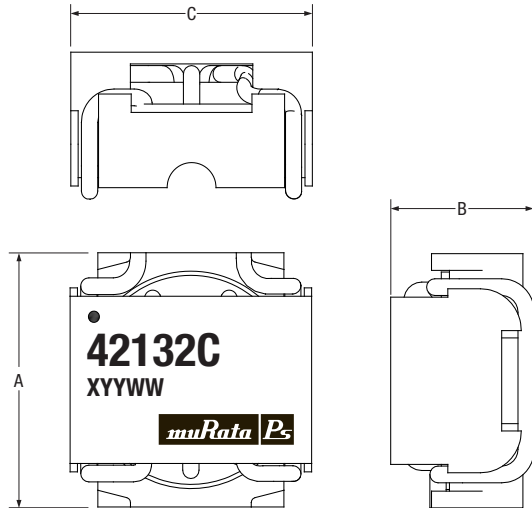

Package weight: See Selection Guide.

**RECOMMENDED FOOTPRINT DETAILS**

See Selection Guide for dimensions.

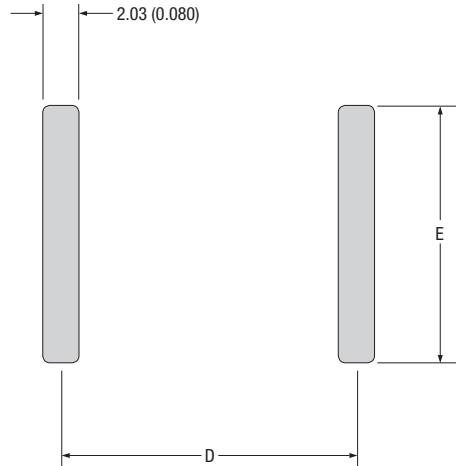

All dimensions in mm (inches).

**TAPE & REEL SPECIFICATIONS**

**TAPE OUTLINE DIMENSIONS**

See Selection Guide for dimensions.

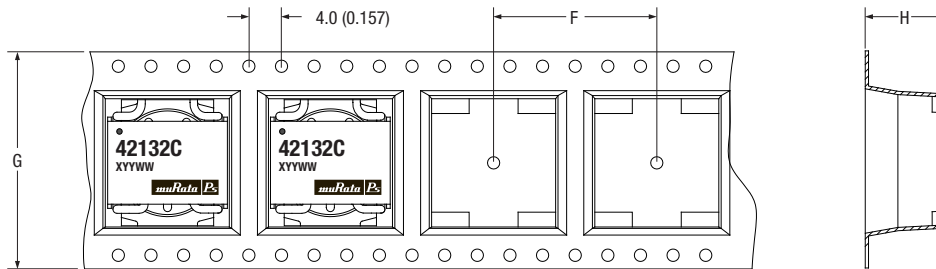

All dimensions in mm (inches).  
See Selection Guide for package quantities.

Murata Power Solutions, Inc.  
11 Cabot Boulevard, Mansfield, MA 02048-1151 U.S.A.  
ISO 9001 and 14001 REGISTERED

Murata Power Solutions, Inc. makes no representation that the use of its products in the circuits described herein, or the use of other technical information contained herein, will not infringe upon existing or future patent rights. The descriptions contained herein do not imply the granting of licenses to make, use, or sell equipment constructed in accordance therewith. Specifications are subject to change without notice.  
© 2018 Murata Power Solutions, Inc.

## X-ON Electronics

Largest Supplier of Electrical and Electronic Components

*Click to view similar products for [Fixed Inductors](#) category:*

*Click to view products by [Murata](#) manufacturer:*

Other Similar products are found below :

[CR43NP-680KC](#) [CR54NP-820KC](#) [CR54NP-8R5MC](#) [CTX32CT-100](#) [70F224AI](#) [MGDQ4-00004-P](#) [MHL1ECTTP18NJ](#) [MHL1JCTTD12NJ](#)  
[PE-51506NL](#) [PE-53601NL](#) [PE-53602NL](#) [PE-53630NL](#) [PE-53824SNLT](#) [PE-62892NL](#) [PE-92100NL](#) [PG0434.801NLT](#) [PG0936.113NLT](#)  
[9310-16](#) [PM06-2N7](#) [PM06-39NJ](#) [A01TK](#) [1206CS-471XJ](#) [HC2-2R2TR](#) [HC2LP-R47-R](#) [HC3-2R2-R](#) [1206CS-151XG](#) [RCH664NP-140L](#)  
[RCH664NP-4R7M](#) [RCH8011NP-221L](#) [RCP1317NP-332L](#) [RCP1317NP-391L](#) [RCR1010NP-470M](#) [RCR110DNP-331L](#) [DH2280-4R7M](#)  
[DS1608C-106](#) [ASPI-4020HI-R10M-T](#) [B10TJ](#) [B82477P4333M](#) [B82498B3101J000](#) [B82498B3680J000](#) [ELJ-RE27NJF2](#) [1812CS-153XJ](#)  
[1812CS-183XJ](#) [1812CS-223XJ](#) [1812LS-104XJ](#) [1812LS-105XJ](#) [1812LS-124XJ](#) [1812LS-154XJ](#) [1812LS-223XJ](#) [1812LS-224XJ](#)