



FEATURES

- UL62368-1 recognised
- EN62368-1 certified
- EN/IEC61558-1 recognition pending
- ANSI/AAMI ES60601-1, 1 MOPP/2 MOOP recognition pending
- Wide input voltage range 85-264VAC/120-370VDC
- Operating temperature range -40°C to 85°C
- 4.25kVAC isolation 'Hi Pot Test'
- 5V, 12V & 24V single regulated outputs
- Over current protection
- Short circuit protection
- Primary side regulation
- Meets EMC class B with no external components
- No external components required

PRODUCT OVERVIEW

The BAC3 series delivers an output power of 3 watts from -40°C to 65°C, operating up to 85°C with derating, from AC or DC input voltages. The BAC3 series small footprint is EMC class B compliant without the need of any external components. The BAC3 series is suited to medical applications with 1 MOPP and 2 MOOP.

With high efficiency at low loads and low no load power consumption, the BAC3 supports standby mode operation for applications in industrial, medical, automation, IOT as well as household and home automation.



For full details go to www.murata-ps.com/rohs

SELECTION GUIDE

Order Code	Output Power W	Output Voltage V	Output Current A	Ripple & Noise				Efficiency				Isolation Capacitance pF	MTTF ¹	
				115V		230V		115V		230V			MIL 217 kHrs	Telcordia
				Typ.	Max.	Typ.	Max.	Min.	Typ.	Min.	Typ.			
				mVp-p				%						
BAC3S05DC	3	5	0.6	45	60	45	60	75	77	72	75	45	993	20443
BAC3S12DC	3	12	0.25	50	100	60	100	77	80	74.5	77	45	1021	22386
BAC3S24DC	3	24	0.125	120	200	150	200	78	81	76	78	45	1059	24680

INPUT CHARACTERISTICS

Parameter	Conditions	Min.	Typ.	Max.	Units
Voltage range	All input types	85	115/230	264	VAC
	All input types	120		370	VDC
Input frequency		47	50/60	63	Hz
Switching frequency			64		kHz
Input current	Nominal Vin = 115VAC		65		mA
	Nominal Vin = 230VAC		40		mA
Inrush current	Nominal Vin = 115VAC		11		A
	Nominal Vin = 230VAC		23		
Input leakage current	250VAC		25		µA
No load power consumption	BAC3S05DC	115VAC		67	mW
		230VAC		150	
	BAC3S12DC	115VAC		46	
		230VAC		129	
	BAC3S24DC	115VAC		101	
		230VAC		155	

ISOLATION CHARACTERISTICS

Parameter	Conditions	Min.	Typ.	Max.	Units
Isolation test voltage	Production tested for 1 second	4250			VDC
	Qualification tested for 1 minute	4250			
Resistance	Viso = 1000VDC	100			MΩ

TEMPERATURE CHARACTERISTICS

Parameter	Conditions	Min.	Typ.	Max.	Units
Operation	Convection cooling 0.2m/s	-40		85	°C
Storage		-40		85	
Product temperature rise above ambient	BAC3S24DC		15		
	All others		20		

1. Calculated using MIL-HDBK-217F FN2 and Telcordia SR-332 calculation model at Ta=25°C with nominal input voltage 115VAC at full load.

All specifications typical at Ta=25°C, nominal input voltage and rated output current unless otherwise specified.

OUTPUT CHARACTERISTICS						
Parameter	Conditions	Min.	Typ.	Max.	Units	
Minimum load		10			%	
Initial voltage accuracy	All output types			±4	%	
Line regulation	Low line to high line	BAC3S24DC		±0.2	±0.5	%
		All others		±0.05	±0.5	
Load regulation	10% total load to 100% total load	115VAC	BAC3S05DC	±0.3	±1	%
			All others		±0.1	
		230VAC	BAC3S05DC	±0.2	±1	
			All others		±0.1	
Temperature coefficient				0.05	%/°C	
Transient response	Peak deviation - 50-75% & 75-50% swing		±2		%Vout	
	Settling time (within 1% Vout Nom.)		2		ms	
Current limit inception	BAC3S05DC		160		%	
	BAC3S12DC		150			
	BAC3S24DC		130			
Hold up time	115VAC		25		ms	
	230VAC		125			

ABSOLUTE MAXIMUM RATINGS	
Short-circuit protection	Continuous, automatic recovery
Input voltage	277VAC
Lead temperature 1.0mm from case for 7 +2/-0 seconds (to JEDEC JESD22-B106)	270±5°C
Shelf life (1 year)	Please refer to reconditioning application notes.
Wave Solder	Wave Solder profile not to exceed the profile recommended in IEC 61760-1 Section 6.1.3. Please refer to application notes for further information.

TECHNICAL NOTES**ISOLATION VOLTAGE**

'Hi Pot Test', 'Flash Tested', 'Withstand Voltage', 'Proof Voltage', 'Dielectric Withstand Voltage' & 'Isolation Test Voltage' are all terms that relate to the same thing, a test voltage, applied for a specified time, across a component designed to provide electrical isolation, to verify the integrity of that isolation.

Murata Power Solutions BAC3 series of AC/DC converters are all 100% production tested at their stated isolation voltage. This is 4.25kVDC for 1 second.

The BAC3 has been recognised by Underwriters Laboratory to 240VAC for Reinforced Insulation.

REPEATED HIGH-VOLTAGE ISOLATION TESTING

It is well known that repeated high-voltage isolation testing of a barrier component can actually degrade isolation capability, to a lesser or greater degree depending on materials, construction and environment. We therefore strongly advise against repeated high voltage isolation testing, but if it is absolutely required, that the voltage be reduced by 20% from specified test voltage.

SAFETY APPROVAL**ANSI/AAMI ES60601-1**

The BAC3 series is pending recognition by Underwriters Laboratory (UL) to ANSI/AAMI ES60601-1 and provides 1 MOPP (Means Of Patient Protection) and 2 MOOP (Means Of Operator Protection) based upon a working voltage of 240VAC max., between Primary and Secondary. File number E202895 applies.

EN62368-1

The BAC3 series has been certified by Demko (D) to EN62368 for reinforced insulation to a working voltage of 240VAC. File number D-07177 applies.

UL62368-1

The BAC3 series has been recognised by Underwriters Laboratory (UL) to UL62368 for reinforced insulation to a working voltage of 240AC. File number E151252 applies.

Creepage and clearance 8.4mm

Working altitude 5000M

EN/IEC61558-1

The BAC3 series is pending recognition to EN/IEC61558-1.

RoHS COMPLIANCE INFORMATION

This series is compatible with RoHS soldering systems with a peak wave solder temperature of 260°C for 10 seconds based on IEC 61760-1. Please refer to [application notes](#) for further information. The pin termination finish on this product series is Hot Dipped over Matte Tin with Nickel Preplate. The series is backward compatible with Sn/Pb soldering systems. For further information, please visit www.murata-ps.com/rohs

ENVIRONMENTAL VALIDATION TESTING

The following tests have been conducted on this product series, as part of our design verification process. The datasheet characteristics specify user operating conditions for this series, please contact Murata if further information about the tests is required.

Test	Standard	Condition
Temperature cycling	JEDEC JESD22-A104	200 cycles. -40°C to 105°C, 15 minutes hold at each extreme including transitions.
Humidity bias	JEDEC JESD22-A101	85±2°C, 85±5% R.H. for 1000 (+168/-24) hours
Storage life	JEDEC JESD22-A103	105°C +10/-0°C for ≥1000 hours
Vibration	BS EN 61373 with respect to BS EN 60068-2-64 2008, Test Fh Category 1 Class B.	5 – 150Hz. Level at each axis – Vertical, Traverse and Longitudinal: 5.72m/s ² rms. 5 hours in each axis. Crest factor: 3 Sigma. Device is secured via the pins.
Shock	BS EN 61373: 2010, Category 1 Class B	Test is 30ms duration, 3 shocks in each sense of 3 mutually perpendicular axes (18 shocks total). Level at each axis as follows: Vertical, Traverse and Longitudinal: 50m/s ² . Device is secured via pins.
Solderability	EIA/IPC/JEDEC J-STD-002 Test A1	Parts are baked for 4 hours at a temperature of 155°C, within 72 hours they are dipped in flux for 10 seconds. Followed by dipping the parts in a solder pot at 255°C ±5°C for 5 seconds (96SC tin/silver/copper)
Solder Heat	JEDEC JESD22-B106	The test sample is subjected to a molten solder bath at 270 ±5°C for 7 +2/-0 seconds (96SC tin/silver/copper). The leads are dipped in the solder bath to within 1mm of the device body.
Solder Heat (Hand)	MIL-STD 202 Method 210, Condition A	The soldering iron is heated to 350°C ± 10°C and applied to the terminations for a duration of 4 to 5 seconds.
Solvent cleaning	Resistance to cleaning agents	Solvent – Novec 71IPA & Topklean EL-20A. Pulsed ultrasonic immersion 45°C- 65°C
Solvent Resistance	MIL-STD-883 Method 2015	The parts and the bristle portion of the brush are immersed in Isopropanol for a minimum of 1 minute. The parts are brushed 3 times, after the third time the parts are blown dry and inspected.
Lead Integrity (Adhesion)	MIL-STD 883 Method 2025	Leads are bent through 90° until a fracture occurs.
Lead Integrity (Fatigue)	MIL-STD 883 Method 2004, Condition B ₁	The leads are bent to an angle of 15°. Each lead is subjected to 3 cycles.
Lead Integrity (Tension/Pull)	MIL-STD 883, Method 2004, Condition A ₁	Pull of 0.227kg applied for 30 seconds. The force is then increased until the pins snap.

EMC/ESD STANDARDS

Conducted emissions	EN55032/FCC class B
Radiated emissions	EN55032/FCC class B
ESD immunity	IEC/EN 61000-4-2, Level 1, criteria A
Radiated, radio-frequency, electromagnetic field immunity	IEC/EN61000-4-3, 10V/m perf criteria A 10V/m 80-1000MHz 3V/m 1.4-2.0GHz 1V/m 2.0-2.7GHz All 80% 1kHz am mod all perf criteria A
EFT/burst	IEC/EN61000-4-4, 2kV, perf criteria A
Surge immunity	IEC/EN61000-4-5, 1kV perf criteria A
Conducted field immunity	IEC/EN61000-4-6, 10 Vrms 0.15-80MHz 80% 1kHz am mod perf criteria A
Power frequency magnetic field immunity	IEC/EN61000-4-8, 50Hz/60Hz 30 A/m perf criteria A
Harmonic current emissions	IEC/EN61000-3-2
Voltage changes, voltage fluctuations and flicker	IEC/EN61000-3-3
Voltage dips, short interruptions and variations	IEC/EN61000-4-11, 100% for 20ms, 60% for 200ms, 30% for 500ms and 100% for 5s perf criteria A-A-A-C.

PART NUMBER STRUCTURE

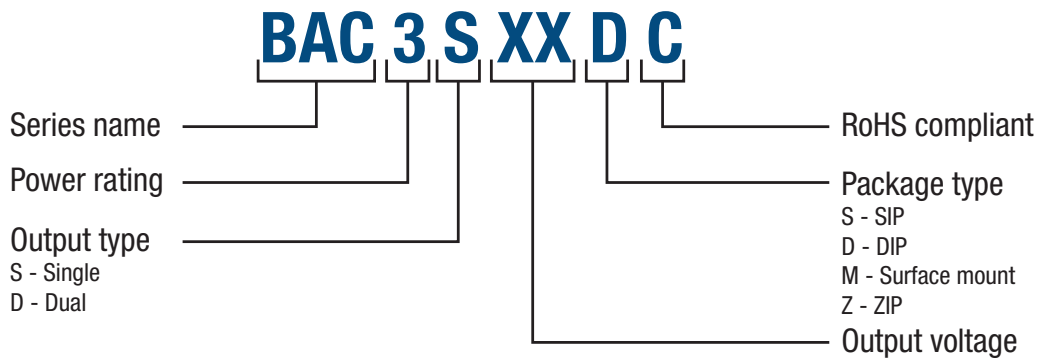

CHARACTERISATION TEST METHODS

Ripple & Noise Characterisation Method

Ripple and noise measurements are performed with the following test configuration.

C1 10µF electrolytic capacitor

Differential Mode Noise Test Schematic

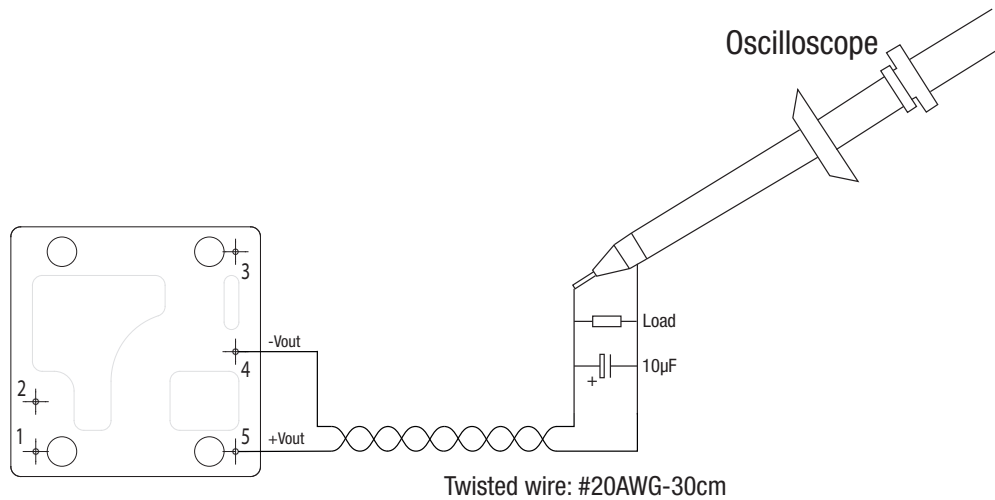

APPLICATION NOTES

Output Capacitance and start-up times

The BAC3 series does not require output capacitors to meet datasheet specification. To meet datasheet specification, output capacitance should not exceed:

Part No.	Maximum Load Capacitance	Load capacitance to meet start-up	Start-up times with maximum load capacitance	Start up times with 10µF
	µF	µF	ms	ms
BAC3S05DC	820	510	1800	510
BAC3S12DC	330	205	730	310
BAC3S24DC	180	300	730	300

When operational in an application will operate down to -40°C. For start-up below nominal input voltage ≤115VAC, at very low temperatures, please refer the temperature derating graphs.

APPLICATION NOTES

Minimum Load

The minimum load to meet full datasheet specification is 10% of the full rated load across the specified input voltage range.

Reconditioning

This series contains electrolytic capacitors, which require reconditioning if the product is stored non-powered for more than 2 years from the date of manufacture. To recondition the capacitors, an AC input voltage should be applied with output loading for 10 minutes. For further information please contact Murata.

EFFICIENCY VS LOAD

BAC3S05DC

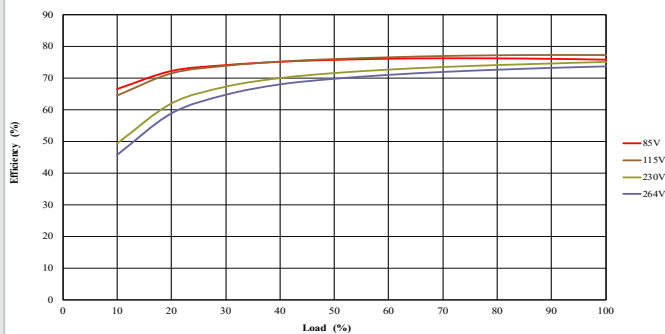

BAC3S12DC

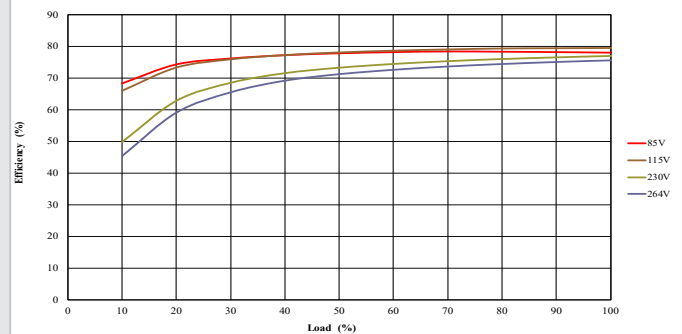

BAC3S24DC

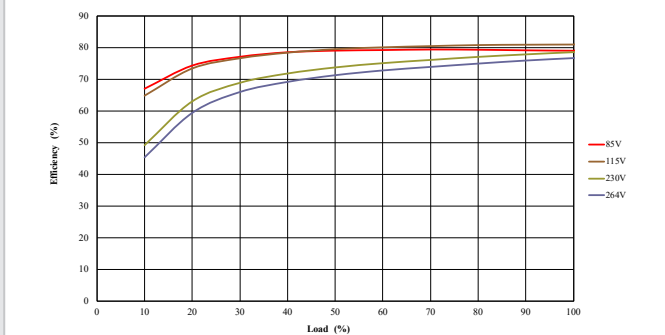

TEMPERATURE DERATING - PART OPERATIONAL

BAC3S05DC

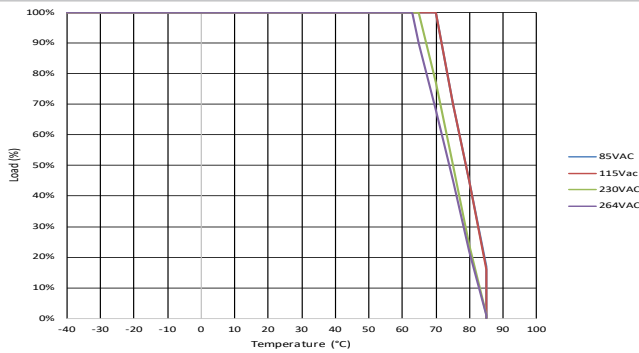

BAC3S12DC

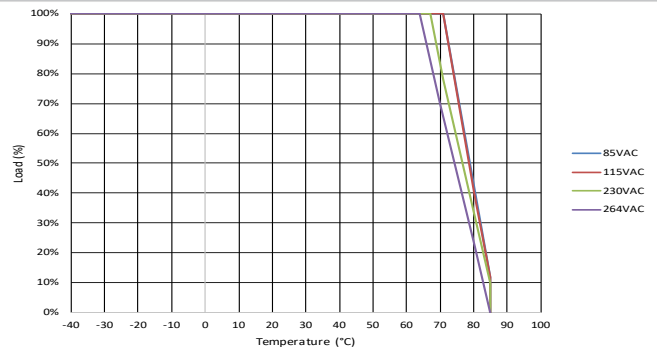

BAC3S24DC

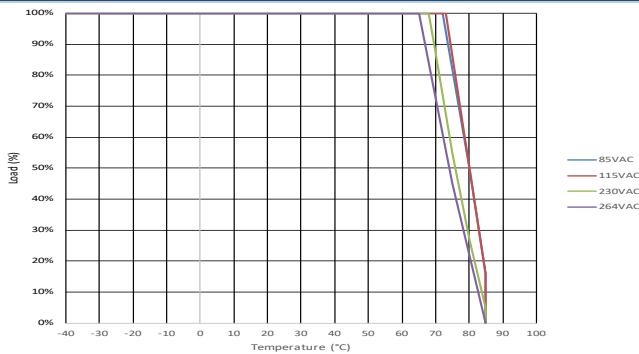

TEMPERATURE DERATING - COLD STARTUP

BAC3S05DC

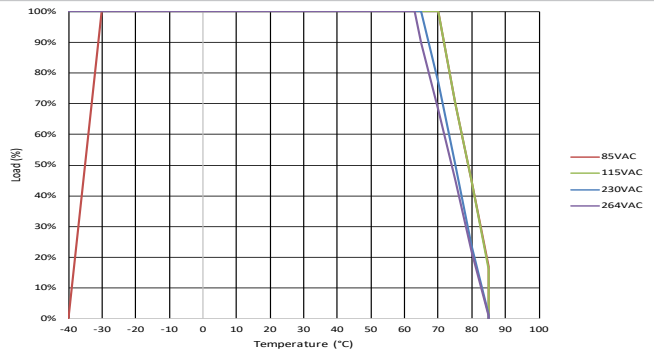

BAC3S12DC

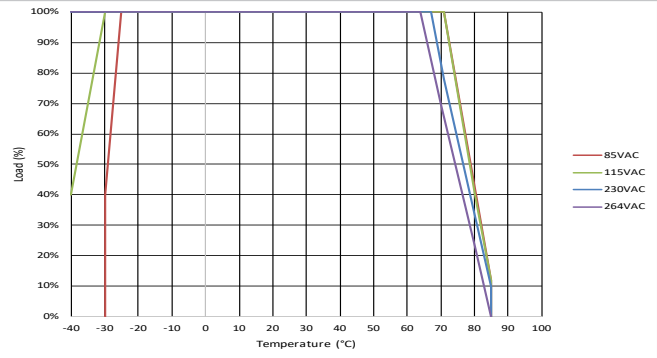

BAC3S24DC

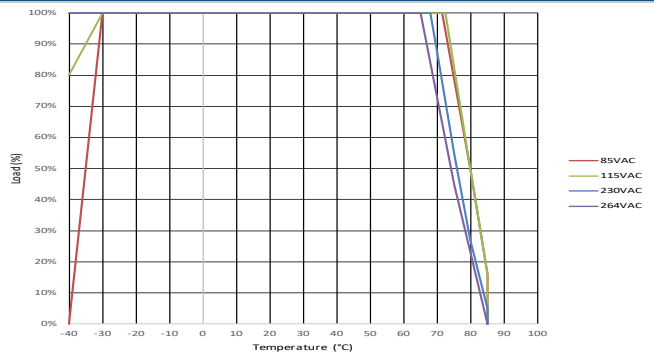

PACKAGE SPECIFICATIONS

MECHANICAL DIMENSIONS

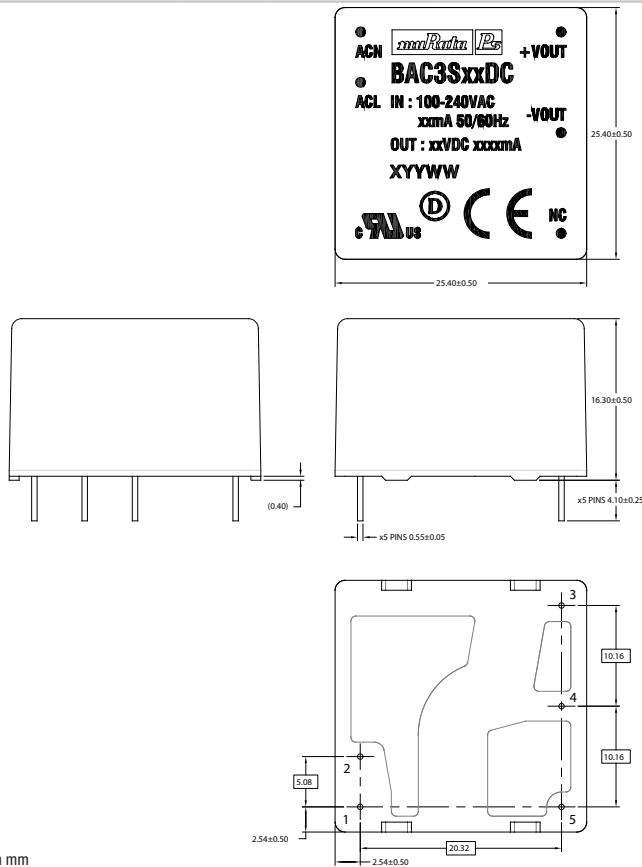

All dimensions in mm
Unless otherwise specified all pins within ±0.30 of true position.

Weight: 18g

PIN CONNECTIONS

Pin	Function
1	AC(N)
2	AC(L)
3	NC
4	-Vout
5	+Vout

TUBE OUTLINE DIMENSIONS

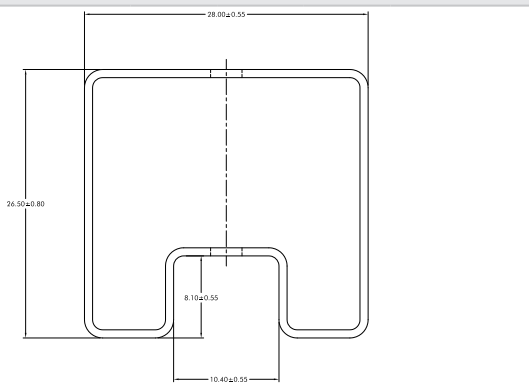

Unless otherwise specified all dimensions in mm.
Tube Length : 550mm±2.0.

Tube Quantity : 20

RECOMMENDED FOOTPRINT DETAILS

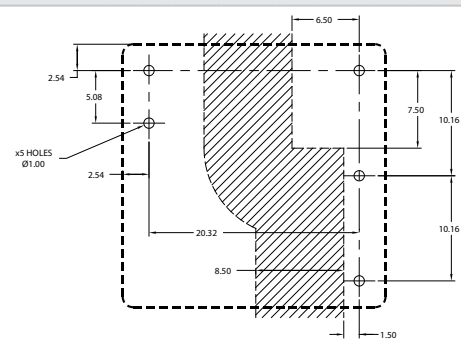

The isolation barrier shown must not have any copper traces even on internal layers. This is to avoid compromising the creepage and clearance distance. PCB layouts must take into consideration the required clearance and creepage requirements to maintain the clearance and creepage of the isolation barrier. All dimensions in mm (inches).



This product is subject to the following **operating requirements** and the **Life and Safety Critical Application Sales Policy**:

Refer to: <https://www.murata.com/en-eu/products/power/requirements>

Murata Power Solutions (Milton Keynes) Ltd. makes no representation that the use of its products in the circuits described herein, or the use of other technical information contained herein, will not infringe upon existing or future patent rights. The descriptions contained herein do not imply the granting of licenses to make, use, or sell equipment constructed in accordance therewith. Specifications are subject to change without notice.
© 2020 Murata Power Solutions (Milton Keynes) Ltd.

X-ON Electronics

Largest Supplier of Electrical and Electronic Components

Click to view similar products for [AC/DC Power Modules](#) category:

Click to view products by [Murata](#) manufacturer:

Other Similar products are found below :

[VI-HAM-CM](#) [ERP-350-12](#) [KPSB25-12-J](#) [KPSB25-15-J](#) [KPSB25-24-J](#) [KPSB25-36-J](#) [KPSB25-5-J](#) [KPSB6-12-J](#) [KPSB6-5-J](#) [TMPS 03-112](#)
[TMPS 03-115](#) [TMPS 03-124](#) [IRM-03-9S](#) [LFWLT300-CK](#) [TMPS 03-109](#) [TPP 40-112](#) [TPP 65-105](#) [TPP 65-112](#) [VOF-275-48](#) [RAC04-](#)
[12DC/277-E](#) [RAC04-12SC/277-E](#) [RAC04-05DC/277-E](#) [RAC04-0512DC/277-E](#) [PFE700SA-48/T](#) [MFM-15-12](#) [MFM-15-24](#) [MFM-15-5](#)
[MFM-20-12](#) [MFM-20-5](#) [MPM-05-12](#) [MPM-05-24](#) [MPM-05-5](#) [MPM-10-12](#) [MPM-10-24](#) [MPM-10-5](#) [MPM-15-12](#) [MPM-15-24](#) [MPM-15-5](#)
[MPM-20-12](#) [MPM-20-5](#) [MPM-30-12](#) [MPM-30-5](#) [RAC01-05SGA](#) [RAC01-05SGB](#) [RAC01-12SGB](#) [RAC02-05SGB](#) [RAC02-12SGA](#) [RAC02-](#)
[12SGB](#) [RAC03-05SGA](#) [RAC03-05SGB](#)