

BLA31AG300SN4#

“#” indicates a package specification code.



< List of part numbers with package codes >

BLA31AG300SN4D BLA31AG300SN4J BLA31AG300SN4B

Appearance & Shape

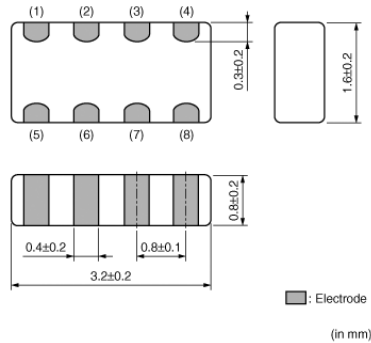

Features

The miniaturization of electronic equipment requires high performance EMI filters which enable high density mounting. BLA31A/B series consists of 4 circuits of ferrite beads.

BLA31A/B is suitable for EMI suppression in smaller digital equipment.

Features

1. BLA31A/B has 4 circuits in 3.2x1.6mm body with 0.8mm pitch.
2. Provides attenuation across a broad frequency range. Two types of impedance are available which meet general signal line and high speed signal line.
3. Original inner electrode structure enables extra low crosstalk.
4. The nickel barrier structure of the external electrodes provides excellent solder heat resistance. Both flow and reflow soldering methods can be employed.

Applications

Other Usage	For general
-------------	-------------

Packaging Information

Packaging	Specifications	Minimum Order Quantity
D	180mm Paper Tape	4000
J	330mm Paper Tape	10000
B	Bulk(Bag)	1000

Attention

- 1.This datasheet is downloaded from the website of Murata Manufacturing Co., Ltd. Therefore, it's specifications are subject to change or our products in it may be discontinued without advance notice. Please check with our sales representatives or product engineers before ordering.
- 2.This datasheet has only typical specifications because there is no space for detailed specifications. Therefore, please review our product specifications or consult the approval sheet for product specifications before ordering.

BLA31AG300SN4#

“#” indicates a package specification code.



Specifications

Shape	SMD
Size Code (in mm)	3216
Size Code (in inch)	1206
Length	3.2mm
Length Tolerance	±0.2mm
Width	1.6mm
Width Tolerance	±0.2mm
Thickness	0.8mm
Thickness Tolerance	±0.2mm
Impedance (at 100MHz)	30Ω
Impedance (at 100MHz) Tolerance	±25%
Rated Current (at 85°C)	200mA
Rated Current (at 125°C)	200mA
DC Resistance(max.)	0.1Ω
Operating Temperature Range	-55°C to 125°C
Mass(typ.)	0.018g
Number of Circuit	4

Attention

1.This datasheet is downloaded from the website of Murata Manufacturing Co., Ltd. Therefore, it's specifications are subject to change or our products in it may be discontinued without advance notice. Please check with our sales representatives or product engineers before ordering.

2.This datasheet has only typical specifications because there is no space for detailed specifications.

Therefore, please review our product specifications or consult the approval sheet for product specifications before ordering.

BLA31AG300SN4#

“#” indicates a package specification code.

Product Data

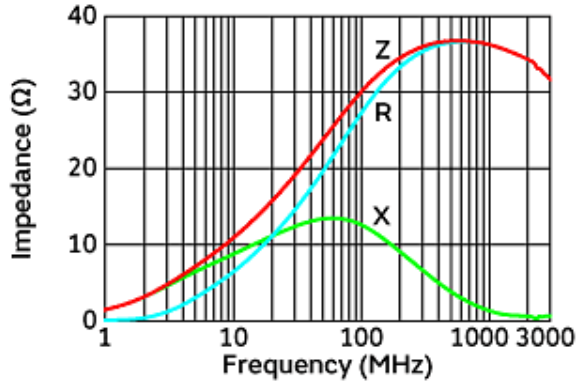

Impedance-Frequency Characteristics

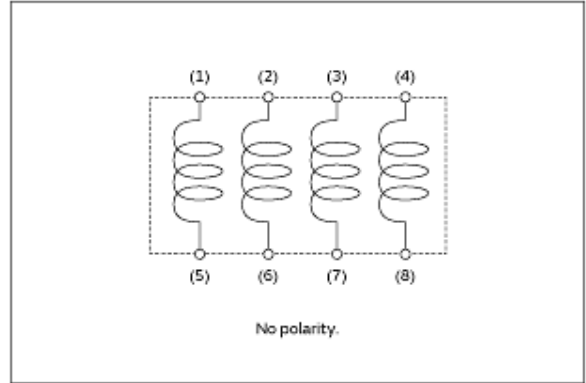

Equivalent Circuit

Attention

- 1.This datasheet is downloaded from the website of Murata Manufacturing Co., Ltd. Therefore, it's specifications are subject to change or our products in it may be discontinued without advance notice. Please check with our sales representatives or product engineers before ordering.
- 2.This datasheet has only typical specifications because there is no space for detailed specifications.
Therefore, please review our product specifications or consult the approval sheet for product specifications before ordering.

X-ON Electronics

Largest Supplier of Electrical and Electronic Components

Click to view similar products for [Ferrite Beads](#) category:

Click to view products by [Murata](#) manufacturer:

Other Similar products are found below :

[CZB1EGTTP700P](#) [CZB1JGTTD101P](#) [CZB1JGTTD151P](#) [CZB1JGTTD601P](#) [CZB2AFTTD800P](#) [CZB2AGTTD601P](#) [CZB2BFTTE600P](#) [PE-0402FB121ST](#) [EMI0805R-11](#) [NCB0603R301TR050F](#) [NCB0805A320TR050F](#) [NCB-H1206B680TR300F](#) [SMB2.5-1TR](#) [SMB2.5R-2](#)
[2943778301](#) [CZB1EGTTP121P](#) [CZB1JGTTD102P](#) [CZB1JGTTD121P](#) [CZB1JGTTD221P](#) [CZB2AGTTD301P](#) [CZB2BFTTE601P](#) [4221R-1](#)
[4221R-2](#) [4221R-3](#) [EMI0805R-2000](#) [EMI0805R-600](#) [SBY100505T-100Y-N](#) [NCB-GH0402D121TR060F](#) [NCB-H1812D125TR150F](#)
[CZB2AGTTD102P](#) [NCB0402P301TR005F](#) [NCB0603R152TR030F](#) [NCB0805A121TR050F](#) [NCB3312K900TR500F](#) [NCB-](#)
[H0805A221TR300F](#) [NCB-H1806E181TR300F](#) [NCB0402P300TR030F](#) [NCB0402P700TR050F](#) [NCB0805A102TR040F](#)
[NCB1806E151TR020F](#) [NCB-H0603R121TR300F](#) [NCB-H0805A220TR600F](#) [NCB-H0805A390TR400F](#) [CIM21J252NE](#) [CZB2BFTTE121P](#)
[EMI0805R-220](#) [74279250](#) [7427924](#) [CZB1JGTTD202P](#) [ABUPDE160808121Y00](#)