

# BLA31BD601SN4#

“#” indicates a package specification code.



< List of part numbers with package codes >

BLA31BD601SN4J BLA31BD601SN4D BLA31BD601SN4B

## Appearance & Shape

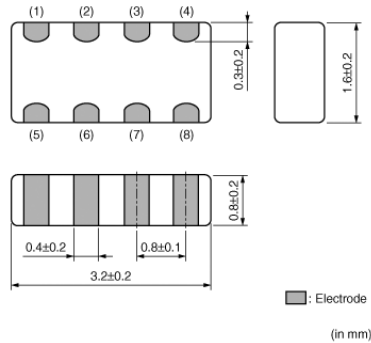

## Features

The miniaturize of electronic equipment requires high performance EMI filters which enables high density mounting. BLA31A/B series consists of 4 circuit of ferrite bead inductor. BLA31A/B is suitable for EMI suppression in smaller digital equipment.

### ★ FEATURES

1. BLA31A/B have 4 circuits in 3.2×1.6mm body with 0.8mm pitch.
2. Provides attenuation across a broad frequency range. Two types of impedance are available which meets general signal line and high speed signal line.
3. Original inner electrode structure enables extra low crosstalk.
4. The nickel barrier structure of the external electrodes provides excellent solder heat resistance. Both flow and reflow soldering methods can employed.

## Applications

Other Usage	For general
-------------	-------------

## Packaging Information

Packaging	Specifications	Minimum Order Quantity
J	330mm Paper Tape	10000
D	180mm Paper Tape	4000
B	Bulk(Bag)	1000

### Attention

1.This datasheet is downloaded from the website of Murata Manufacturing Co., Ltd. Therefore, it's specifications are subject to change or our products in it may be discontinued without advance notice. Please check with our sales representatives or product engineers before ordering.  
2.This datasheet has only typical specifications because there is no space for detailed specifications.  
Therefore, please review our product specifications or consult the approval sheet for product specifications before ordering.

# BLA31BD601SN4#

“#” indicates a package specification code.



## Specifications

Shape	SMD
Size Code (in mm)	3216
Size Code (in inch)	1206
Length	3.2mm
Length Tolerance	±0.2mm
Width	1.6mm
Width Tolerance	±0.2mm
Thickness	0.8mm
Thickness Tolerance	±0.2mm
Impedance (at 100MHz)	600Ω
Impedance (at 100MHz) Tolerance	±25%
Rated Current (at 85°C)	100mA
Rated Current (at 125°C)	100mA
DC Resistance(max.)	0.45Ω
Operating Temperature Range	-55°C to 125°C
Mass(typ.)	0.018g
Number of Circuit	4

### Attention

1.This datasheet is downloaded from the website of Murata Manufacturing Co., Ltd. Therefore, it's specifications are subject to change or our products in it may be discontinued without advance notice. Please check with our sales representatives or product engineers before ordering.

2.This datasheet has only typical specifications because there is no space for detailed specifications.

Therefore, please review our product specifications or consult the approval sheet for product specifications before ordering.

# BLA31BD601SN4#

“#” indicates a package specification code.

## Product Data

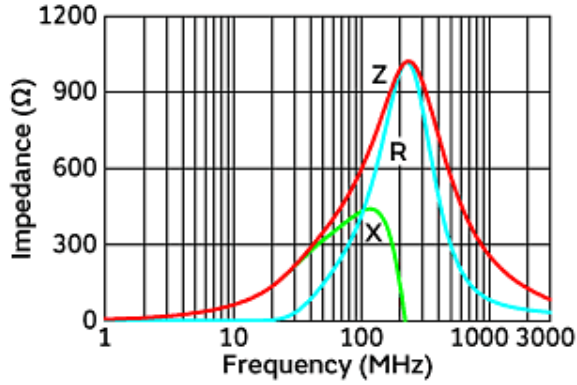

Impedance-Frequency Characteristics



Equivalent Circuit

**Attention**

- 1.This datasheet is downloaded from the website of Murata Manufacturing Co., Ltd. Therefore, it's specifications are subject to change or our products in it may be discontinued without advance notice. Please check with our sales representatives or product engineers before ordering.
- 2.This datasheet has only typical specifications because there is no space for detailed specifications. Therefore, please review our product specifications or consult the approval sheet for product specifications before ordering.

## X-ON Electronics

Largest Supplier of Electrical and Electronic Components

*Click to view similar products for [Ferrite Beads](#) category:*

*Click to view products by [Murata](#) manufacturer:*

Other Similar products are found below :

[CZB1EGTTP700P](#) [CZB1JGTTD101P](#) [CZB1JGTTD151P](#) [CZB1JGTTD601P](#) [CZB2AFTTD800P](#) [CZB2AGTTD601P](#) [CZB2BFTTE600P](#) [PE-0402FB121ST](#) [EMI0805R-11](#) [NCB0603R301TR050F](#) [NCB0805A320TR050F](#) [NCB-H1206B680TR300F](#) [SMB2.5-1TR](#) [SMB2.5R-2](#)  
[2943778301](#) [CZB1EGTTP121P](#) [CZB1JGTTD102P](#) [CZB1JGTTD121P](#) [CZB1JGTTD221P](#) [CZB2AGTTD301P](#) [CZB2BFTTE601P](#) [4221R-1](#)  
[4221R-2](#) [4221R-3](#) [EMI0805R-2000](#) [EMI0805R-600](#) [SBY100505T-100Y-N](#) [NCB-GH0402D121TR060F](#) [NCB-H1812D125TR150F](#)  
[CZB2AGTTD102P](#) [NCB0402P301TR005F](#) [NCB0603R152TR030F](#) [NCB0805A121TR050F](#) [NCB3312K900TR500F](#) [NCB-](#)  
[H0805A221TR300F](#) [NCB-H1806E181TR300F](#) [NCB0402P300TR030F](#) [NCB0402P700TR050F](#) [NCB0805A102TR040F](#)  
[NCB1806E151TR020F](#) [NCB-H0603R121TR300F](#) [NCB-H0805A220TR600F](#) [NCB-H0805A390TR400F](#) [CIM21J252NE](#) [CZB2BFTTE121P](#)  
[EMI0805R-220](#) [74279250](#) [7427924](#) [CZB1JGTTD202P](#) [ABUPDE160808121Y00](#)