

Typical units

FEATURES

- Regulated 3.3V and 5V outputs
- 5V @ 6Amps/3.3V @ 7 Amps capability
- 33 Watts total output power
- No-load operation
- Available input voltage ranges:
10-18V, 18-36V or 36-75V
- Small 2" x 2" x 0.45" package
- UL1950 and EN60950-1 safety approvals
- CE mark available (75V-input models)
- Continuous short-circuit protection
- Fully isolated, 1500Vdc guaranteed
- -40 to +100°C operating temperature
- Input under and overvoltage shutdown
- Output overvoltage protection
- Thermal shutdowns

PRODUCT OVERVIEW

For applications requiring 33 watts of power from 5V and 3.3V, DATEL offers a new power sharing DC/DC converter capable of meeting your output current requirements. The BWR-5/6-3.3/7-D48 (36-75V input), BWR-5/6-3.3/7-D24 (18-36V input) and BWR-5/6-3.3/7-D12 (10-18V input) are fully isolated DC/DC converters capable of delivering any combination of 5V and 3.3V loading up to a combined total of 33 Watts of output power.

Housed in a standard 2" x 2" x 0.45" metal package coated with electrically non-conductive finish, these converters utilize a shared control-loop system to assure load regulation of $\pm 1\%$ for 3.3V output and $\pm 1.5\%$ for 5V output. All models include input Pi filtering, input overvoltage and

undervoltage shutdown circuitry, output overvoltage protection, output short-circuit and current limiting protection, and thermal shutdown. Each design also provides trim capability and on/off control function. Fully synchronous output rectification renders high efficiency and no-load operation.

BWR power sharing modules offer low ripple and noise performance, high efficiency (88%), 1500Vdc of isolation voltage, and are fully specified for -40 to +100°C operation. These devices meet IEC950, UL1950 and EN6950 safety standards, including BASIC insulation requirements for "D48" models. CB reports are available on request. "D48" models are CE marked (meet LVD requirements).

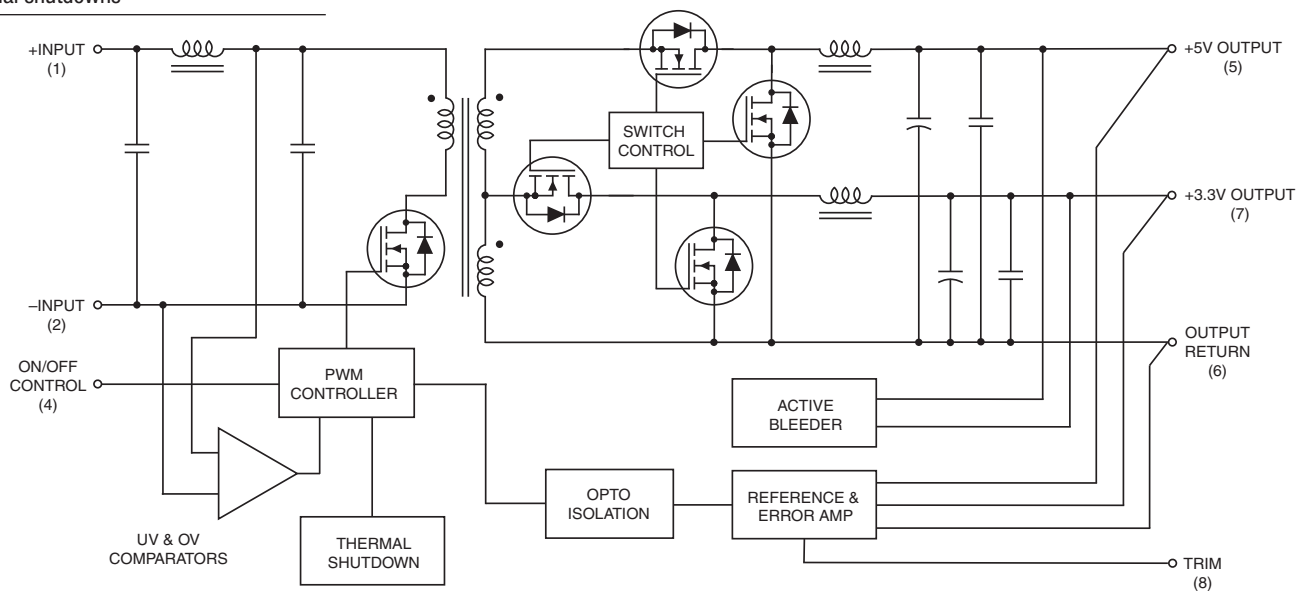

Typical topology is shown.

Figure 1. Simplified Schematic



For full details go to
www.murata-ps.com/rohs

Performance Specifications and Ordering Guide ^①

Models	Output				Input			Efficiency		Package (Case, Pinout)			
	V _{OUT} (Volts)	I _{OUT} ^② (Amps)	R/N (mVp-p) ^③		Regulation (Max.) ^⑦			V _{IN} Nom. (Volts)	Range (Volts)		I _{IN} ^⑤ (mA)	Min.	Typ.
			Typ.	Max.	Line	Load ^④	No Load ^⑥						
BWR-5/6-3.3/7-D12	5	6	40	100	±1%	±1.5%	±2.5%	12	10-18	70/3308	83%	86%	C4,P33
	3.3	7	95	140	±0.5%	±1%	±1.5%						
BWR-5/6-3.3/7-D24	5	6	40	100	±1%	±1.5%	±2.5%	24	18-36	50/1615	85%	88%	C4,P33
	3.3	7	95	140	±0.5%	±1%	±1.5%						
BWR-5/6-3.3/7-D48	5	6	40	100	±1%	±1.5%	±2.5%	48	36-75	25/780	85%	88%	C4,P33
	3.3	7	95	140	±0.5%	±1%	±1.5%						

- ① Typical at T_A = +25°C under nominal line voltage and balanced "full-load" conditions (5V @ 3.3A/3.3V @ 5A).
- ② Any combination of 5V/3.3V rated I_{OUT} current, not to exceed 33 Watts of output power. (See derating graphs.)
- ③ Ripple/Noise (R/N) measured over a 20MHz bandwidth. All models are specified with 1µF ceramic output capacitors.
- ④ Tested from 10% load to 100% load (other output at 10% load).

- ⑤ Nominal line voltage, no load/balanced full-power condition.
- ⑥ Tested from no-load to 100% load (other output at no-load).
- ⑦ Output trim may impact 5V load regulation.

PART NUMBER STRUCTURE

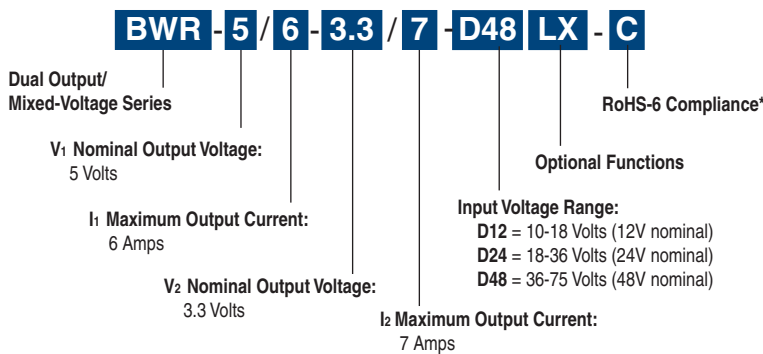

Optional Functions

BWR 33 Watt DC/DC's are designed with an On/Off Control function with positive polarity in the pin 4 position.

- L1 Pin length: 0.110 in. (2.79mm) ±0.010
- L2 Pin length: 0.145 in. (3.68mm) ±0.010

Pin length options require a minimum order quantity.

Refer to the last page for additional options.

* Contact MPS for availability.

MECHANICAL SPECIFICATIONS

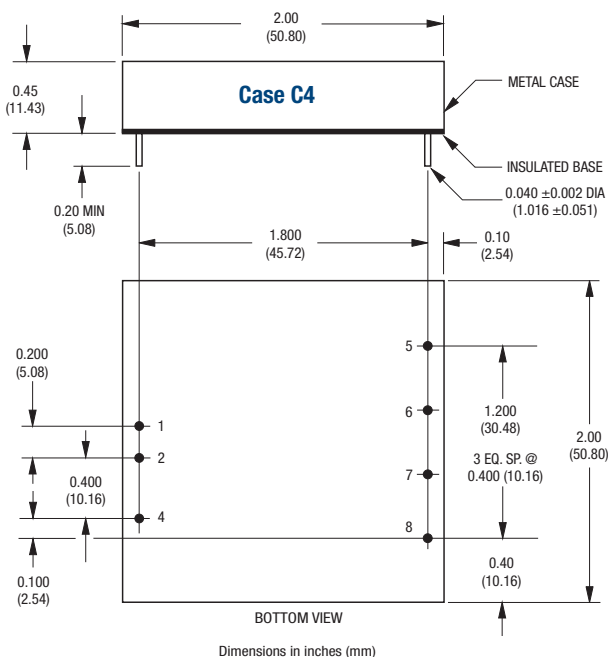

I/O Connections	
Pin	Function P33
1	+Input
2	-Input
3	No Pin
4	On/Off Control
5	+5V Output
6	Output Return
7	+3.3V Output
8	Trim

Notes:

For "D12" and "D24" models the case is connected to pin 2 (-Input).

For "D48" models, the case is connected to pin 1 (+Input).

Performance/Functional Specifications

Typical @ T_A = +25°C under nominal line voltage, balanced "full-load" conditions, unless noted. ①

Input	
Input Voltage Range:	
D12 Models	10-18 Volts (12V nominal)
D24 Models	18-36 Volts (24V nominal)
D48 Models	36-75 Volts (48V nominal)
Overvoltage Shutdown: ②	
D12 Models	19-23 Volts (21V nominal)
D24 Models	37-42 Volts (40V nominal)
D48 Models	77-81 Volts (79V nominal)
Start-Up Threshold: ②	
D12 Models	9-10 Volts (9.3V nominal)
D24 Models	16.5-18 Volts (17V nominal)
D48 Models	34-36 Volts (35V nominal)
Undervoltage Shutdown: ②	
D12 Models	8.5-9.6 Volts (9.3V nominal)
D24 Models	16-17 Volts (16.5V nominal)
D48 Models	32.5-35 Volts (34V nominal)
Input Current:	
Normal Operating Conditions	See Ordering Guide
Standby Mode:	
Off, OV, UV, Thermal Shutdown	10mA typical
Input Reflected Ripple Current:	
Source Impedance	<0.1, no external input filtering
D12 Models	200mA _{p-p} (150mA _{p-p} typical)
D24/D48 Models	250mA _{p-p} (225mA _{p-p} typical)
Internal Input Filter Type	Pi (0.022μF - 4.7μH - 2.46μF)
Reverse-Polarity Protection: ②	
D12 Models	1 minute duration, 6A maximum
D24 Models	1 minute duration, 4A maximum
D48 Models	1 minute duration, 2A maximum
On/Off Control (Pin 4): ② ③ ⑤	
D12, D24 & D48 Models	On = open or 13V to +V _{IN} , I _{IN} = 50μA max. Off = 0-0.8V, I _{IN} = 1mA max.
Output	
V_{OUT} Accuracy:	
5V Output	±3% maximum
3.3V Output	±1.5% maximum
Minimum Loading Per Specification	No load, see Performance Specifications
Ripple/Noise (20MHz BW) ② ④	See Ordering Guide
Line/Load Regulation ②	See Ordering Guide
Efficiency	See Ordering Guide / Efficiency Curves
Cross Regulation: ②	
5V Output (5V@0.6A, 3.3V@0.7-7A)	±6% maximum
3.3V Output (3.3V@0.7A, 5V@0.6-6A)	±0.5% maximum
Trim Range ②	±5%
Isolation Voltage:	
Input-to-Output	1500Vdc minimum
Isolation Capacitance	470pF
Isolation Resistance	100M
Primary to Secondary Insulation Level	
D12/D24 Models	Operational
D48 Models	Basic
Temperature Coefficient	±0.02%/per°C
Current Limit Inception: ②	
5V @ 95% V _{OUT} (3.3V @ 0A)	7.6-9.0 Amps
3.3V @ 98.5% V _{OUT} (5V @ 0A)	11.3-12.7 Amps

Output (continued)	
Short Circuit Current: ②	
5V Output	5 Amps average, continuous
3.3V Output	6 Amps average, continuous
Overvoltage Protection: ②	Magnetic feedback
5V Output	6.8 volts
3.3V Output	4.5Volts
Maximum Capacitive Loading	
D12 Models	3.3V 1000μF
	5V 470μF
D24, D48 Models	3.3V 2000μF
	5V 1000μF
Dynamic Characteristics	
Dynamic Load Response ②	
5V (50-100% load step to 4% V _{OUT})	300μsec maximum
3.3V (50-100% load step to 2.5% V _{OUT})	300μsec maximum
Start-Up Time ②	
V _{IN} to V _{OUT}	20msec maximum
On/Off to V _{OUT}	15msec maximum
Switching Frequency	285kHz (±15kHz)
Environmental	
MTBF ⑥	Bellcore, ground fixed, full power, +25°C operating ambient temperature
D12 Models	1.3 million hours
D24/D48 Models	1.67 million hours
Operating Temperature (Ambient) ②	
Without Derating:	
D12 Models	-40 to +50°C
D24 Models	-40 to +60°C
D48 Models	-40 to +68°C
With Derating	To +100°C (See Derating Curves)
Case Temperature	
Maximum Operational	+100°C
For Thermal Shutdown ②	+110°C minimum, +117°C maximum
Storage Temperature	-40 to +120°C
Flammability	UL 94V-0
Physical	
Dimensions	2" x 2" x 0.45" (50.8 x 50.8 x 11.43mm)
Internal Case Connection	
D12/D24 Models	-Input (Pin 2)
D48 Models	+Input (Pin 1)
Case Material	Corrosion resistant steel with non-conductive, epoxy-based, black enamel finish and plastic baseplate
Pin Material	Gold-plated copper alloy
Weight	2.7 ounces (76.5 grams)

① Balanced "full-load" is 5V @ 3.3A/3.3V @ 5A. All models are specified with external 1μF ceramic output capacitors.

② See Technical Notes/Graphs for details.

③ Applying a voltage to On/Off Control (pin 4) when no input power is applied to the converter may cause permanent damage.

④ Output noise may be further reduced with the installation of additional external output capacitors. See Technical Notes.

⑤ On/Off control is designed to be driven with open collector or by appropriate voltage levels. Voltages must be referenced to the input return pin (-Input).

⑥ Demonstrated MTBF available on request.

Absolute Maximum Ratings		
Input Voltage		
Continuous:	"D12" Models	23 Volts
	"D24" Models	42 Volts
	"D48" Models	81 Volts
Transient (100msec):	"D12" Models	25 Volts
	"D24" Models	50 Volts
	"D48" Models	100 Volts
Input Reverse-Polarity Protection ②		
	Input Current must be limited. 1 minute duration. Fusing recommended.	
"D12" Models	6 Amps	
"D24" Models	4 Amps	
"D48" Models	2 Amps	
Output Current ②		
	Current limited. Devices can withstand an indefinite output short circuit.	
On/Off Control (Pin 4) Max. Voltages		
Referenced to -Input (pin 2)	+VIN	
Storage Temperature		
	-40 to +120°C	
Lead Temperature (Soldering, 10 sec.)		
	+300°C	
<p>These are stress ratings. Exposure of devices to any of these conditions may adversely affect long-term reliability. Proper operation under conditions other than those listed in the Performance/Functional Specifications Table is not implied, nor recommended.</p>		

and remains within its specified accuracy band. Actual measured times will vary with input source impedance, external input/output capacitance, and the slew rate of the input voltages. The BWR-5/6-3.3/7 Series implements a soft start circuit that limits the duty cycle of the PWM controller at power up, thereby limiting the Input Inrush current.

The On/Off Control to V_{OUT} start-up time assumes the converter has its nominal input voltage applied but is turned off via the On/Off Control pin. The specification defines the interval between the time at which the converter is turned on and the fully loaded output voltage enters and remains within its specified accuracy band. Similar to the V_{IN} to V_{OUT} start-up, the On/Off Control to V_{OUT} start-up time is also governed by the internal soft start circuitry and external load capacitance.

Input Overvoltage/Undervoltage Shutdown and Start-Up Threshold

Under normal start-up conditions, devices will not begin to regulate until the ramping-up input voltage exceeds the Start-Up Threshold Voltage (35V for "D48" models). Once operating, devices will not turn off until the input voltage drops below the Undervoltage Shutdown limit (34V for "D48" models). Subsequent re-start will not occur until the input is brought back up to the Start-Up Threshold. This built in hysteresis prevents any unstable on/off situations from occurring at a single input voltage.

Input voltages exceeding the input overvoltage shutdown specification listed in the Performance/Functional Specifications will cause the device to shutdown. A built-in hysteresis of 0.6 to 1.6 Volts for all models will not allow the converter to restart until the input voltage is sufficiently reduced.

On/Off Control

The On/Off Control (pin 4) may be used for remote on/off operation. As shown in Figure 1, the control pin is referenced to the -Input (pin 2) and will be internally pulled to a high state. The standard BWR model is designed so that it is enabled when the control pin is left open and disabled when the control pin is pulled low (less than +0.8V relative to -Input).

Dynamic control of the on/off function is best accomplished with a mechanical relay or an open-collector/open-drain circuit (optically isolated if appropriate). The drive circuit should be able to sink approximately 1 mA for logic low.

The on/off control function is designed such that the converter can be disabled while the input power is ramping up, and then "released" once the input has stabilized.

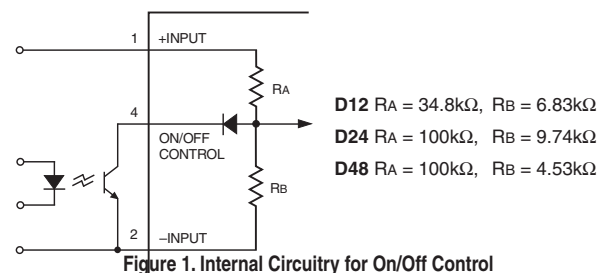

TECHNICAL NOTES

5V & 3.3V Regulation

The BWR 33 Watt Series converters are designed such that both the 5V and 3.3V outputs share a common regulation feedback control loop. Though the feedback loop is influenced by both outputs, the 3.3 Volt output is dominant. As a result, the 3.3 Volt regulation (1%) is superior to the 5 Volt regulation (1.5%).

The converters are specified for load regulation of 10% to 100% loading and for no-load to 100% loading. Operation below 10% of full load mandates an increase in the regulation tolerance of ±0.5% for 3.3 Volt output and an increase of ±1% for the 5 Volt output. A slight increase in switching noise may also be observed for operation below 10% loading.

Operation with a full load on 3.3 Volt output and light to no load on 5 Volt output is the most demanding for +5V regulation. Under such conditions the internal "bleeder" circuit is activated to provide an internal load thereby keeping regulation within the published specifications. The bleeder is activated gradually so as not to cause any erratic behavior on the converters outputs. A slight degradation in efficiency will occur while this internal load is activated.

Filtering and Noise Reduction

The BWR 33 Watt Series Converters achieve their rated ripple and noise specifications with the use of 1µF output capacitors. In critical applications, input/output noise may be further reduced by installing additional external I/O capacitors. Input capacitors should be selected for bulk capacitance, low ESR and high rms-ripple-current ratings. Output capacitors should be selected for low ESR and appropriate frequency response. All caps should have appropriate voltage ratings and be located as close to the converter as possible.

Start-Up Time

The V_{IN} to V_{OUT} start-up time is the interval of time where the input voltage crosses the turn-on threshold point, and the fully loaded output voltage enters

Current Limiting

When power demands from either output fall within 126% to 181% of the rated output current, the DC/DC converter will go into a current limiting mode. In this condition both output voltages will decrease proportionately with increases in output current, thereby maintaining a somewhat constant power dissipation. This is commonly referred to as power limiting (see Figures 2a and 2b). Current limit inception is defined as the point where the full-power output voltage falls below the specified tolerance. If the load current being drawn from the converter is significant enough, the unit will go into a short circuit condition. See "Short Circuit Condition."

Short Circuit Condition

When a converter is in current limit mode the output voltages will drop as the output current demand increases (see figures 2a and 2b). If the output voltage drops too low, the magnetically coupled voltage used to develop primary side voltages will also drop, thereby shutting down the PWM controller.

Following a time-out period of 5 to 15 milliseconds, the PWM will restart, causing the output voltages to begin ramping to their appropriate values. If the short-circuit condition persists, another shutdown cycle will be initiated. This on/off cycling is referred to as "hiccup" mode. The hiccup cycling reduces the average output current, thereby preventing internal temperatures from rising to excessive levels. The BWR is capable of enduring an indefinite short circuit output condition.

Thermal Shutdown

These BWR converters are equipped with Thermal Shutdown Circuitry. If the internal temperature of the DC/DC converter rises above the designed operating temperature, a precision temperature sensor will power down the unit. When the internal temperature decreases below the threshold of the temperature sensor the unit will self start.

Output Overvoltage Protection

Both output voltages are monitored for an overvoltage condition via magnetic coupling to the primary side. If either output voltage should rise to a level which could be damaging to the load circuitry, the sensing circuitry will power down the PWM controller causing the output voltages to decrease. Following a time-out of 5 to 15 milliseconds the PWM will restart, causing the output voltages to ramp to their appropriate values. If the fault condition persists, and the output voltages again climb to excessive levels, the overvoltage circuitry will initiate another shutdown cycle. This on/off cycling is referred to as "hiccup" mode.

Isolation/Case Connection

The BWR 33 Watt Series' 5V and 3.3V outputs (pins 5 & 7) and return (pin 6) are isolated from the +VIN and -VIN inputs (pins 1 & 2) via a transformer and an opto-coupled transistor. Case connections are made internal to the DC/DC converter. "D12 & D24" cases are connected to -Input (pin 2), "D48" to +Input (pin 1).

Typical Current Limiting Characteristics for 3.3V Output

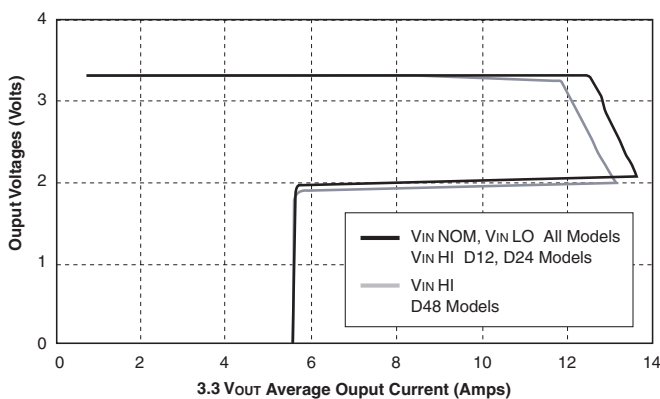

Figure 2a. Current Limiting Characteristics for 3.3V Output

Typical Current Limiting Characteristics for 5V Output
(3.3V Output @ 700mA)

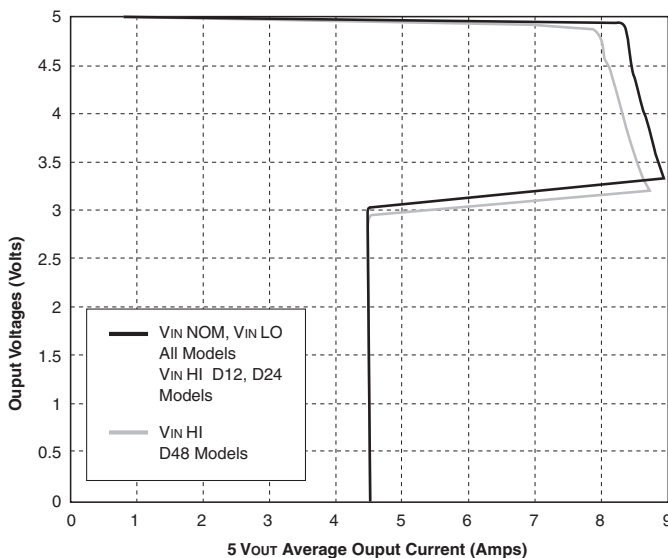

Figure 2b. Current Limiting Characteristics for 5V Output

Input Reverse-Polarity Protection

Upon applying a reverse-polarity voltage to the DC/DC converter, an internal diode will be forward biased, drawing excessive current from the power source. Therefore, it is required that the input current be limited by either an appropriately rated input fuse or a current limited power source.

Input Fusing

Certain applications and/or safety agencies may require the installation of fuses at the inputs of power conversion components. Fuses should also be used if the possibility of a sustained, non-current-limited, input-voltage polarity reversal exists. For DATEL BWR 33 Watt Series Converters, slow blow fuses are recommended with values no greater than the following.

V _{IN} Range	Fuse Value
"D12" Models	6 Amps
"D24" Models	4 Amps
"D48" Models	2 Amps

It is recommended that fuses be installed in the +Input line.

Trimming Output Voltages

These BWR converters have a trim capability (pin 8) that allow users to adjust the output voltages ±5%. A trim adjustment will cause an equal percentage of change in both outputs. Adjustments to the output voltages can be accomplished via a trim pot Figure 3 or a single fixed resistor as shown in Figures 4 and 5. A single fixed resistor can increase or decrease the output voltage depending on its connection. Fixed resistors should be metal-film types with absolute TCR's less than 100ppm/°C to minimize sensitivity to changes in temperature.

A single resistor connected from the Trim Pin (pin 8) the +3.3V Output (pin 7), see Figure 4, will decrease the output voltages. A resistor connected from the Trim Pin (pin 8) to Output Return (pin 6) will increase the output voltages.

Table 1 shows the typical Trim Resistor values for output voltage changes of 1 through 5%.

Trim adjustment greater than 5% can have an adverse affect on the converter's performance and is not recommended.

	Trim Down	Trim Up
0%		
1%	201.5k	123.7k
2%	92.5k	55.3k
3%	56.1k	32.6k
4%	38.0k	21.2k
5%	27.1k	14.3k

Table 1. Percentage of Output Voltage Change vs Trim Resistor Value (Ohms)

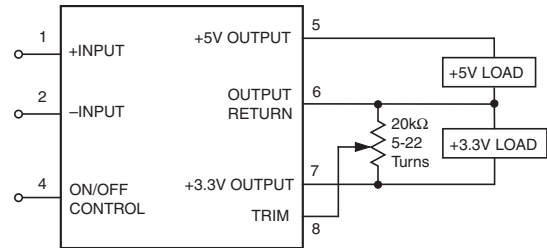

Figure 3. Trim Connections using a Trimpot

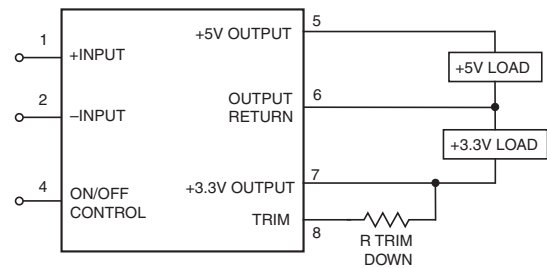

Figure 4. Decrease Output Voltage Trim Connections Using A Fixed Resistor

Trim Down

$$R_{T_{DOWN}} (k\Omega) = \left(\frac{3.55(V_0 - 1.273)}{3.3 - V_0} \right) - 13$$

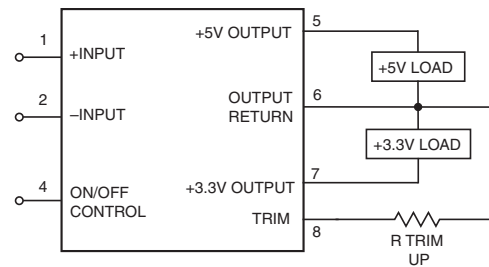

Figure 5. Increase Output Voltage Trim Connections Using A Fixed Resistor

Trim Up

$$R_{T_{UP}} (k\Omega) = \left(\frac{4.51}{V_0 - 3.3} \right) - 13$$

Note: Accuracy of adjustment is subject to the tolerances of resistor values, reference accuracy and factory-adjusted output accuracy. V₀ = desired output voltage.

Typical Performance Curves

D12 Model

Input Ripple Current ($V_{IN} = 18V, 5V @ 3A, 3.3V @ 4.5A$, no external filtering, source impedance $<0.1\Omega$.)

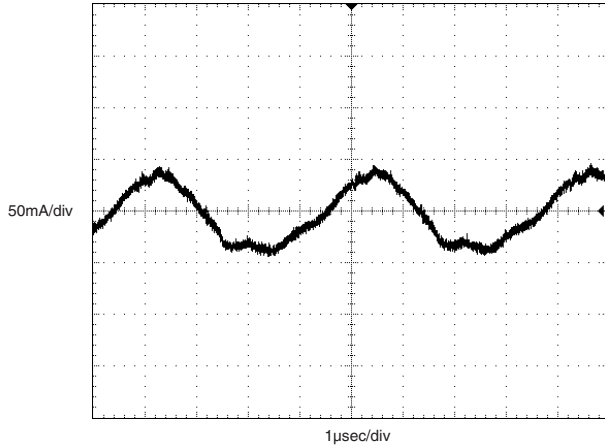

D24 Model

Input Ripple Current ($V_{IN} = 36V, 5V @ 3A, 3.3V @ 4.5A$, no external filtering, source impedance $<0.1\Omega$.)

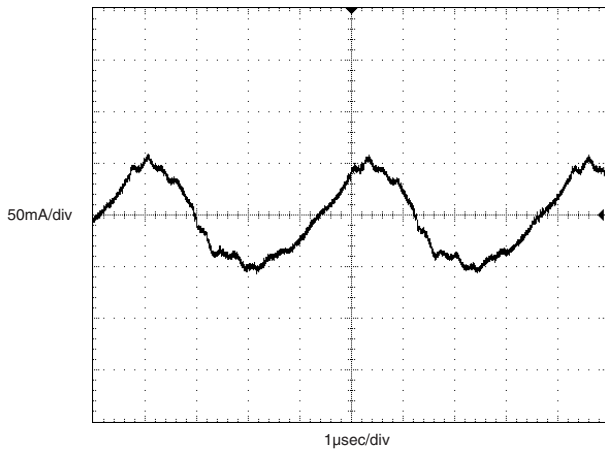

D48 Model

Input Ripple Current ($V_{IN} = 75V, 5V @ 3A, 3.3V @ 4.5A$, no external filtering, source impedance $<0.1\Omega$.)

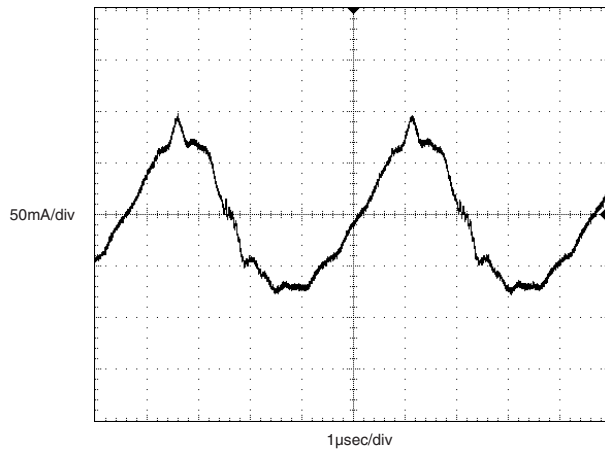

D12, D24, D48 Models

Output Ripple and Noise (PARD)

($V_{IN} = \text{nominal}, 5V @ 3A, 3.3V @ 4.5A$, external $1\mu F$ output capacitors.)

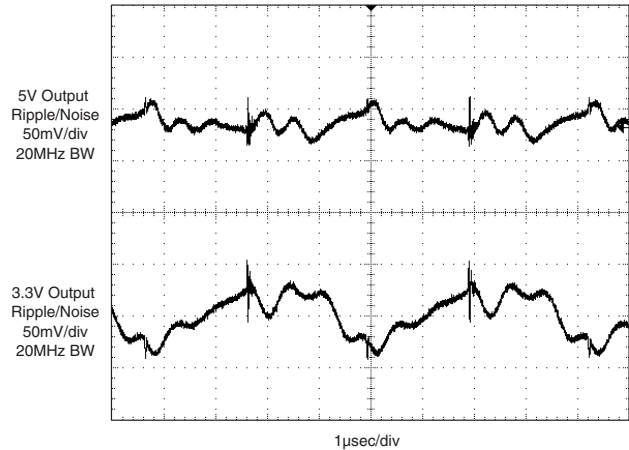

Output Ripple and Noise (PARD)

($V_{IN} = \text{nominal}, 5V @ 0A, 3.3V @ 7A$, external $1\mu F$ output capacitors.)

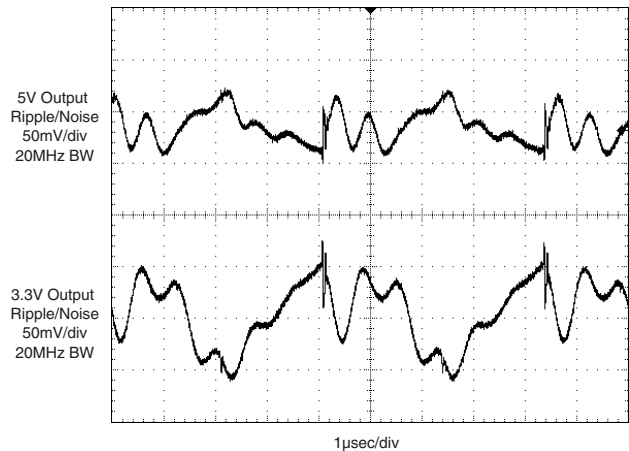

Output Ripple and Noise (PARD)

($V_{IN} = \text{nominal}, 5V @ 6A, 3.3V @ 0A$, external $1\mu F$ output capacitors.)

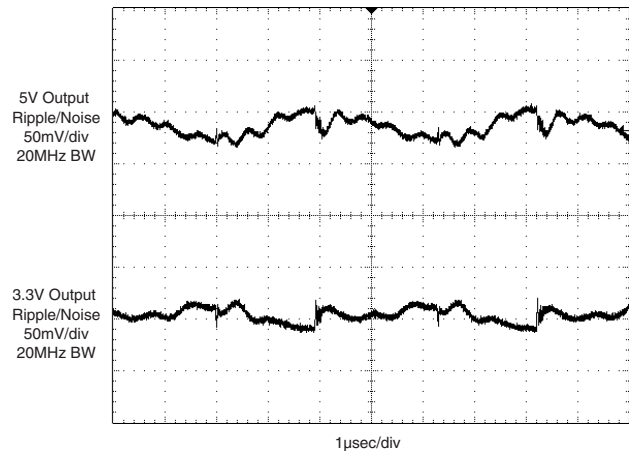

Typical Performance Curves

D12, D24, D48 Models

5V Output Half-Load to Full-Load Transient Response
(VIN = nominal, 3.3V @ 700mA, external 1μF output capacitors.)

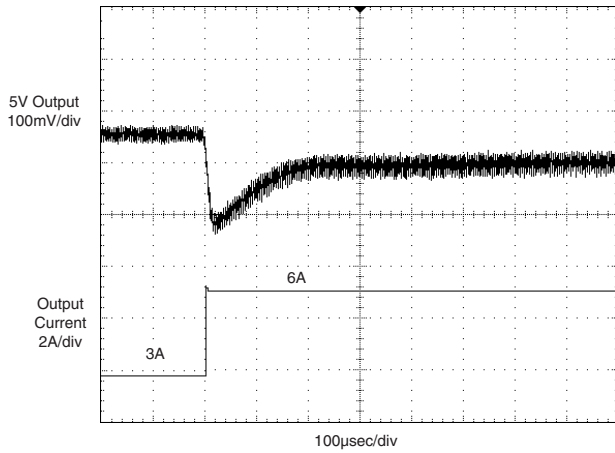

5V Output Full-Load to Half-Load Transient Response
(VIN = nominal, 3.3V @ 700mA, external 1μF output capacitors.)

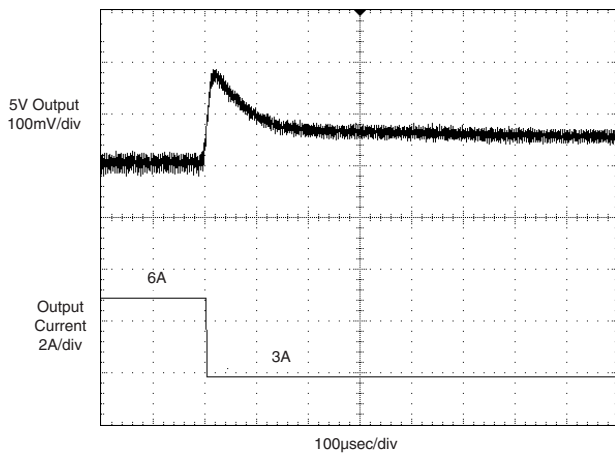

Cross Regulation Effects on +3.3Vout
(Reference Point 5V @ 3.9A, 3.3V @ 4A)

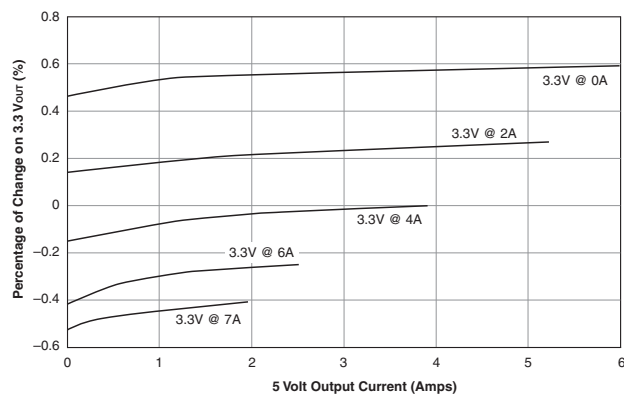

D12, D24, D48 Models

3.3V Output Half-Load to Full-Load Transient Response
(VIN = nominal, 5V @ 600mA, external 1μF output capacitors.)

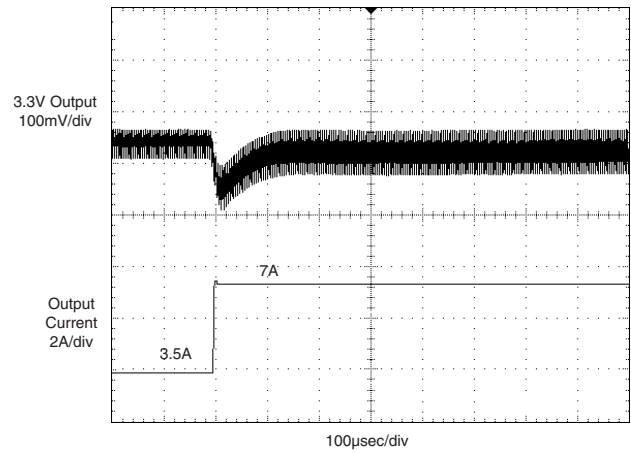

3.3V Output Full-Load to Half-Load Transient Response
(VIN = nominal, 5V @ 600mA, external 1μF output capacitors.)

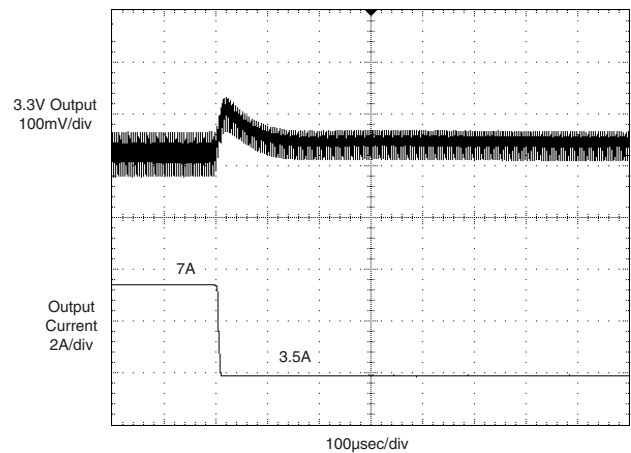

Cross Regulation Effects On +5Vout
(Reference Point 5V @ 4A, 3.3V @ 3.9A)

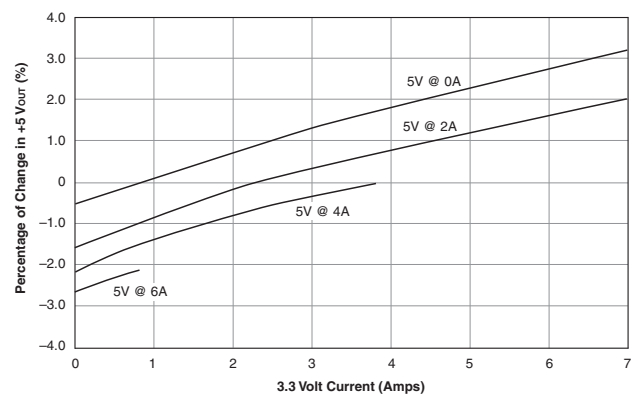

Typical Performance Curves

D12, D24, D48 Models

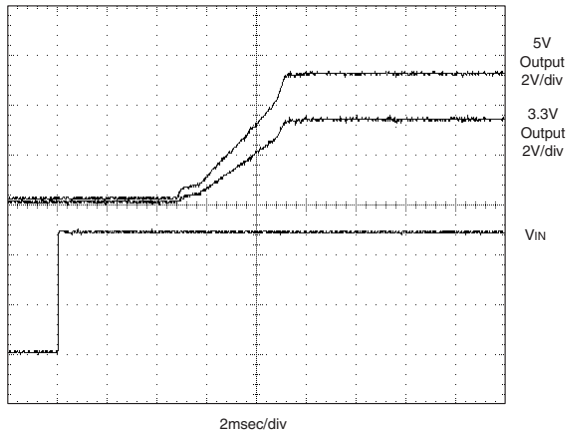

D12, D24, D48 Models

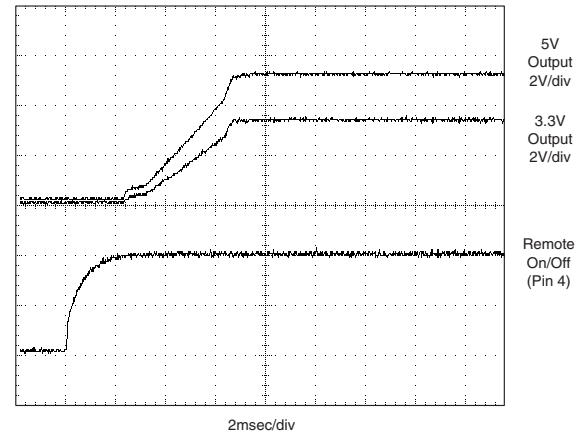

D12 Models

D12 - 3.3 Volt Output Efficiency vs. Line and Load (+5V @ 600mA)

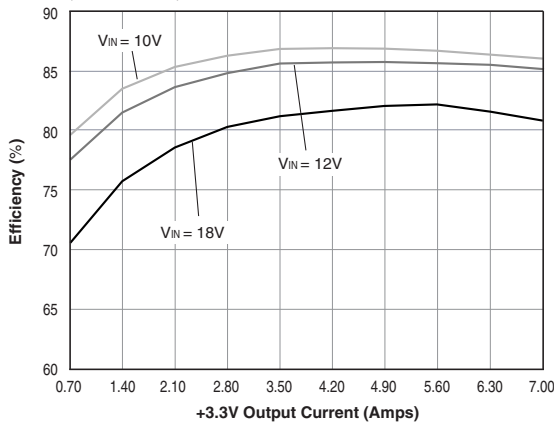

D24, D48 Models

D24/D48 - 3.3 Volt Output Efficiency vs. Line and Load (+5V @ 600mA)

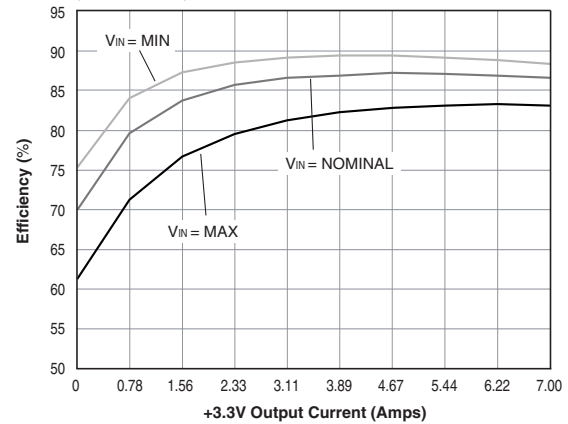

D12 - 5 Volt Output Efficiency vs. Line and Load (+3.3V @ 700mA)

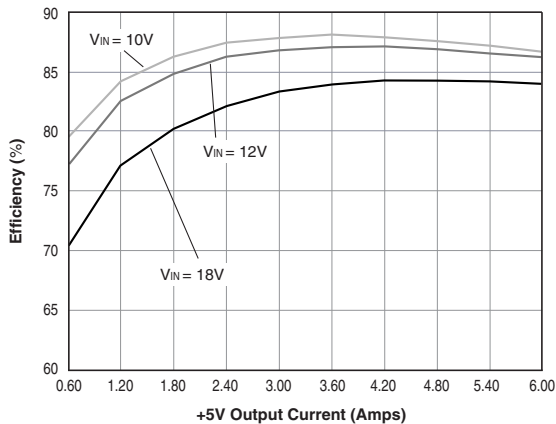

D24/D48 - 5 Volt Output Efficiency vs. Line and Load (+3.3V @ 700mA)

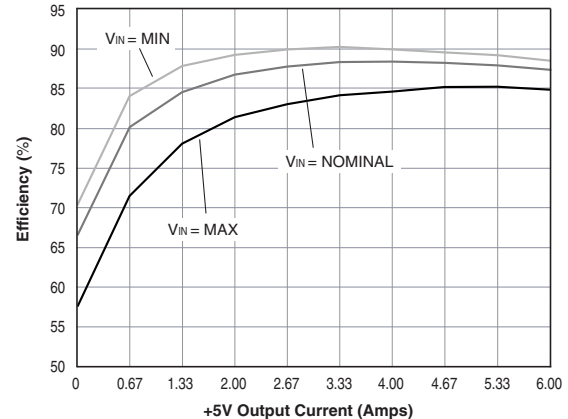

Temperature Derating and Electrical Performance Curves

D12 Models

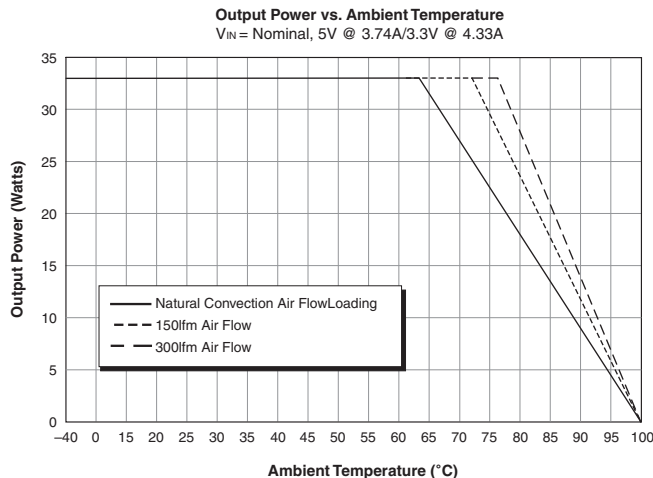
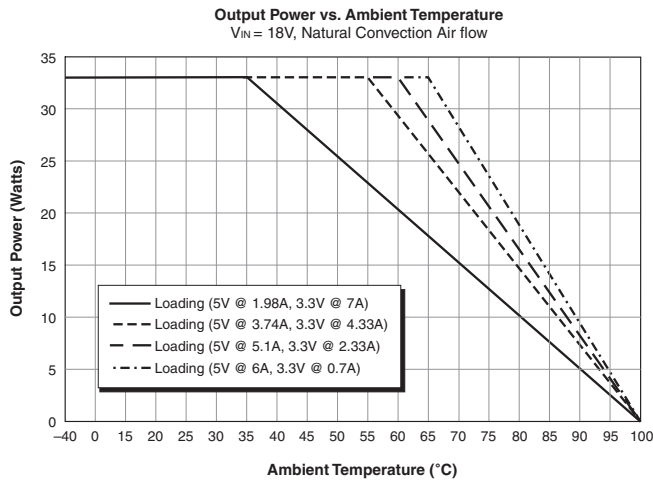
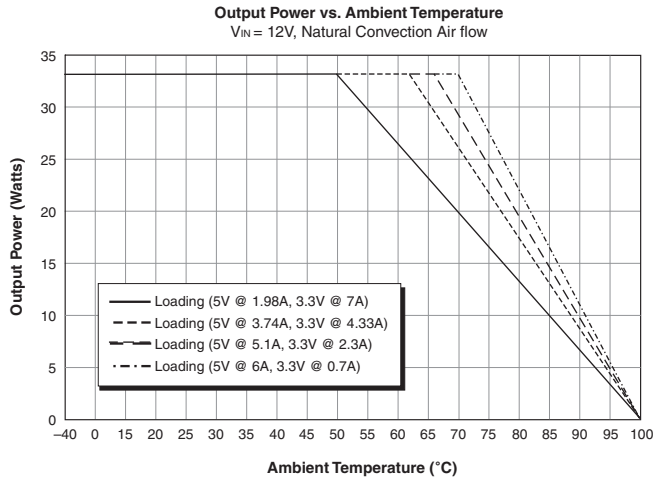

D24 Models

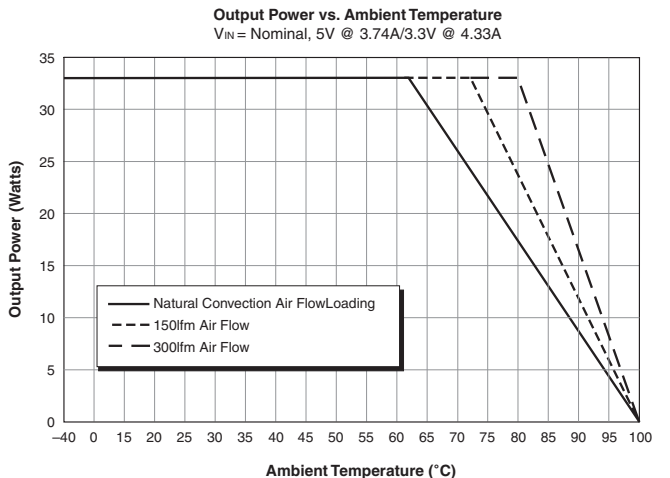
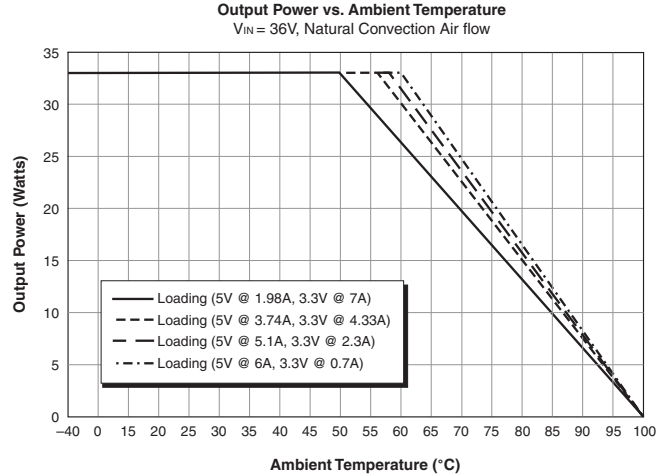
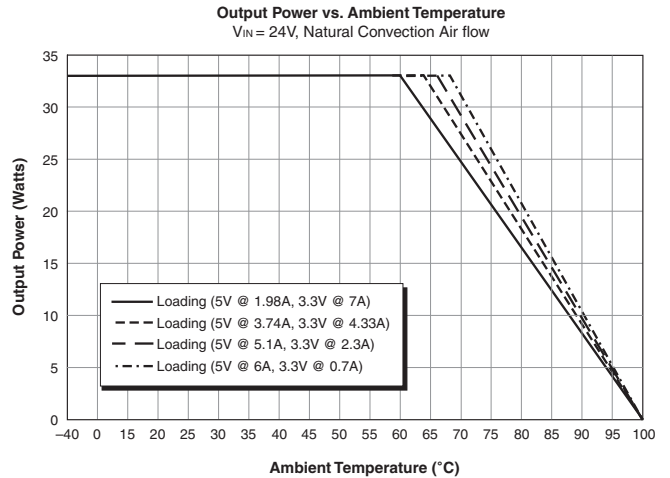

Temperature Derating and Electrical Performance Curves

D48 Models

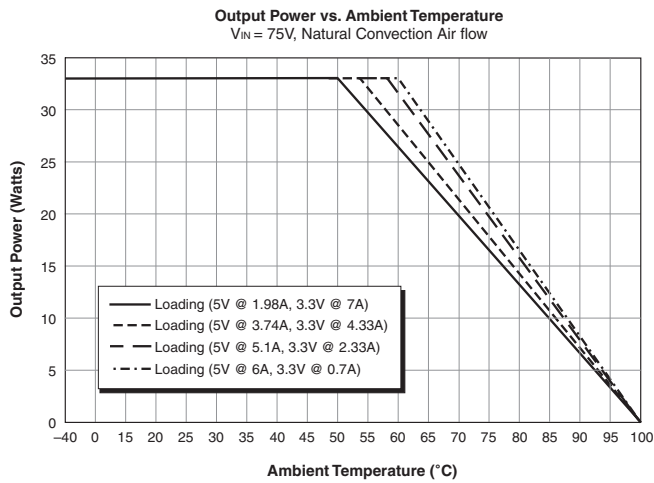
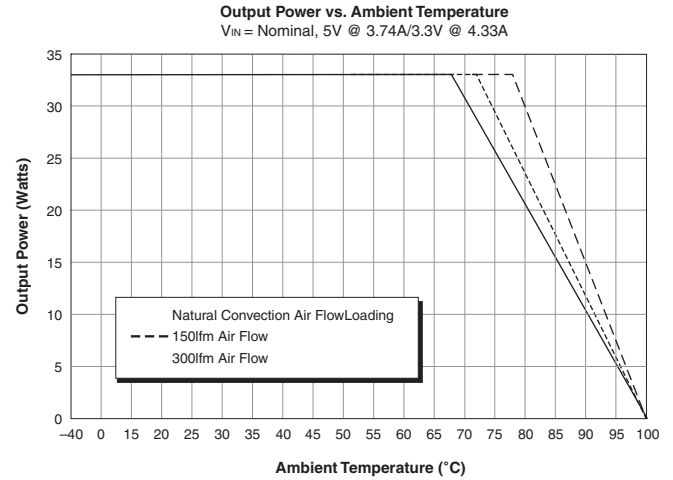
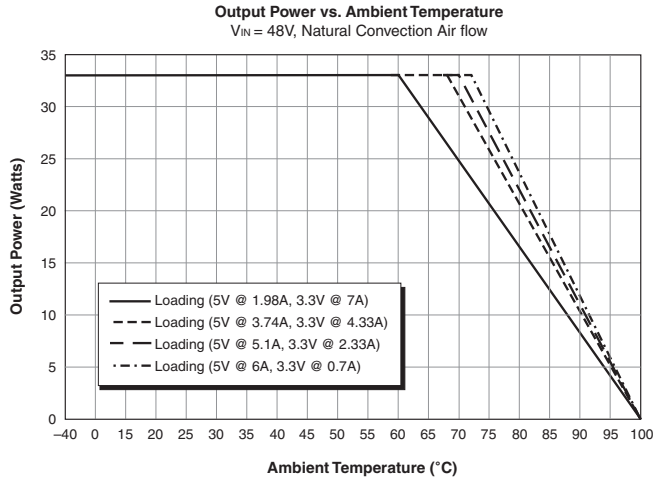

Options and Adaptations

Optional Functions

The dual output BWR 33W DC/DC converters offer two mechanical options. Per the Ordering Guide on page 2, the trailing DXX in each part number pertains to the base part number. Part-number suffixes are added after the "DXX," indicating the selection of standard options. The resulting part number is a "standard product" and is available to any customer desiring that particular combination of options, as described below.

Suffix Description

- Blank** On/Off Control function with positive polarity in pin 4 position. The pin length is 0.2 inches (5.08 mm).
- L1** Trim the pin length to 0.110 ± 0.010 inches (2.79 ± 0.25 mm). This option requires a minimum order quantity.
- L2** Trim the pin length to 0.145 ± 0.010 inches (3.68 ± 0.25 mm). This option requires a minimum order quantity.

Adaptations

There are various additional configurations available on BWR 33W DC/DC's. Because designating each of them with a standard part-number suffix is not always feasible, such are designated by DATEL in assigning a 5-digit "adaptation code" after the part-number suffixes. Once a configuration has been requested by a customer and created by DATEL, the resulting product is available to any customer as a "standard" off-the-shelf product. Contact DATEL directly if you are interested in your own set of options/adaptations. Our policy for minimum order quantities may apply.

Consequently, the following product is offered for sale:

BWR-5/6-3.3/7-D48-30745

Standard product, $48V_{IN}$, $5V/6A$ and $3.3V/7A$ outputs with modified case/pin out C22A/P60A (LW016FA compatible), negative On/Off logic, modified Trim function for $3.3V_{OUT}$ (no trim for $5V_{OUT}$) and trimmed pin length to 0.110 inches (2.8 mm).

Murata Power Solutions, Inc.
129 Flanders Road, Westborough, MA 01581 U.S.A.
ISO 9001 and 14001 REGISTERED

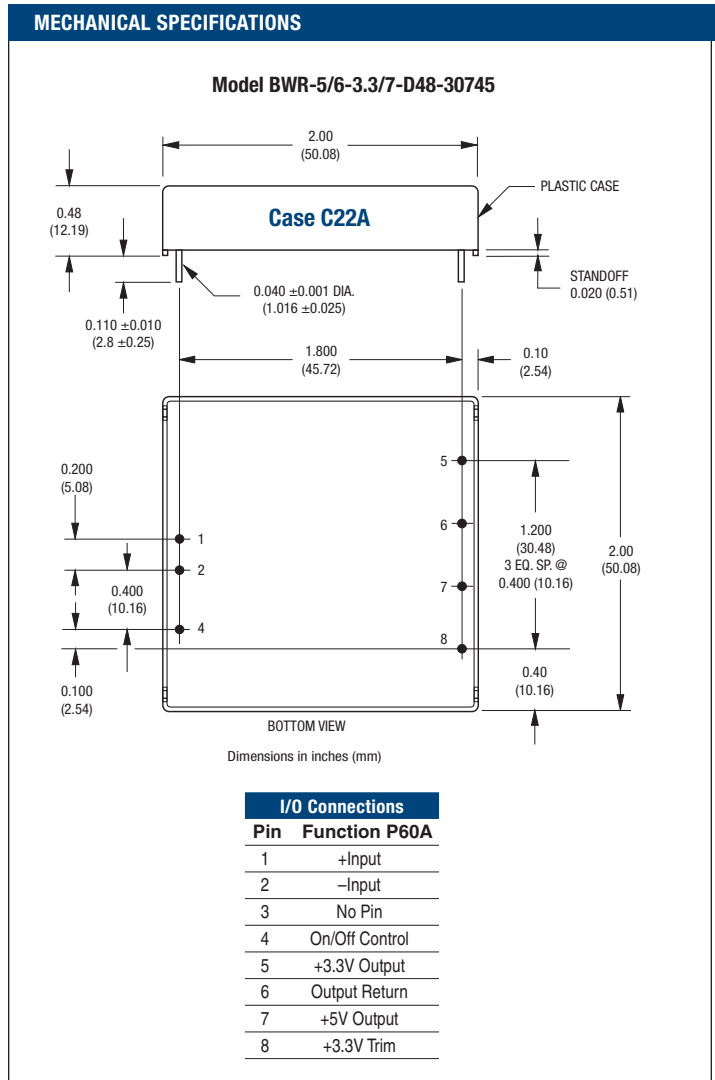

This product is subject to the following operating requirements and the Life and Safety Critical Application Sales Policy:
Refer to: <http://www.murata-ps.com/requirements/>

Murata Power Solutions, Inc. makes no representation that the use of its products in the circuits described herein, or the use of other technical information contained herein, will not infringe upon existing or future patent rights. The descriptions contained herein do not imply the granting of licenses to make, use, or sell equipment constructed in accordance therewith. Specifications are subject to change without notice.
© 2018 Murata Power Solutions, Inc.

X-ON Electronics

Largest Supplier of Electrical and Electronic Components

Click to view similar products for [Isolated DC/DC Converters](#) category:

Click to view products by [Murata](#) manufacturer:

Other Similar products are found below :

[ESM6D044440C05AAQ](#) [FMD15.24G](#) [PSL486-7LR](#) [PSR152.5-7IR](#) [Q48T30020-NBB0](#) [AVO240-48S12B-6L](#) [AVO250-48S28B-6L](#) [NAN-0505](#) [HW-L16D](#) [JAHW100Y1](#) [217-1617-001](#) [22827](#) [SPB05C-12](#) [SQ24S15033-PS0S](#) [18952](#) [19-130041](#) [CE-1003](#) [CE-1004](#) [GQ2541-7R](#) [PSE1000DCDC-12V](#) [RDS180245](#) [MAU228](#) [419-2065-201](#) [449-2075-101](#) [TME 0303S](#) [TME 0505S](#) [TME 1205S](#) [TME 1212S](#) [TME 2405S](#) [TME 2412S](#) [V300C24C150BG](#) [419-2062-200](#) [419-2063-401](#) [419-2067-101](#) [419-2067-501](#) [419-2068-001](#) [DCG40-5G](#) [DFC15U48D15](#) [449-2067-000](#) [XGS-0512](#) [XGS-1205](#) [XGS-1212](#) [XGS-2412](#) [XGS-2415](#) [XKS-1215](#) [033456](#) [NCT1000N040R050B](#) [SPB05B-15](#) [SPB05C-15](#) [TME 2415S](#)