

W-LAN Module Data Sheet

MP P/N: CMWC1ZZABR-107

Sample P/N: CMWC1ZZABR-107SMP

Evaluation Board P/N: CMWC1ZZABR-107EVK

Revision History

Revision Code	Date	Description	Comment
	2020-11-12	Initial release	
A	2020-12-16	RF Characteristics, Add output power table	

Contents

1. Scope	1
2. Part Number / Part Composition	1
3. Block Diagram	1
4. FCC/IC	1
5. Construction, Dimensions, Marking and Terminal Configurations	2
5.1 Construction.....	2
5.2 Dimensions (in mm).....	2
5.3 Label Marking	2
5.4 Pin assignment (top view).....	3
5.5 Recommended land pattern	4
5.6 Pin description	5
5.7 Configuration pins	6
6. Range	6
6.1 Absolute maximum rating ($T_a=25^{\circ}\text{C}$, $Z=50\text{ohm}$).....	6
6.2 Operating conditions.....	6
7. RoHS Compliance	6
8. RF Characteristics for IEEE802.11	7
9. Power Consumption	7
10. Power Up Sequence	7
11. Electrical Characteristics	8
11.1 I/O Static Ratings, 3.3V	8
11.2 Clock Specifications (optional)	8
11.2.1 RC32K Specifications	8
11.2.2 Crystal Specifications (32.768kHz).....	8
12. Reference Circuit	9
13. PCB Antenna Layout Guidance	9
14. Package	10
15. FCC/IC Statement	11

1. Scope

This product specification is applied to the IEEE802.11b/g/n WLAN module used for consumer applications.

Module size	: 22.0 x 19.0 x 2.4 (typ) mm
Chipset	: 88MW320
Interface	: UART, GPIO
Reference Clock	: Internal (external optional sleep clock)
ROM	: SPI Flash on module (2Mbytes)
Antenna	: Integrated PCB antenna
Certification	: FCC/CE/IC
MSL	: 3
RoHS	: This module is compliant with the RoHS directive

*This module delivered with pre-programmed test FW for RF evaluation.

2. Part Number / Part Composition

Sample Part Number	MP Part Number	Evaluation Board Part Number
CMWC1ZZABR-107SMP	CMWC1ZZABR-107	CMWC1ZZABR-107EVK

3. Block Diagram

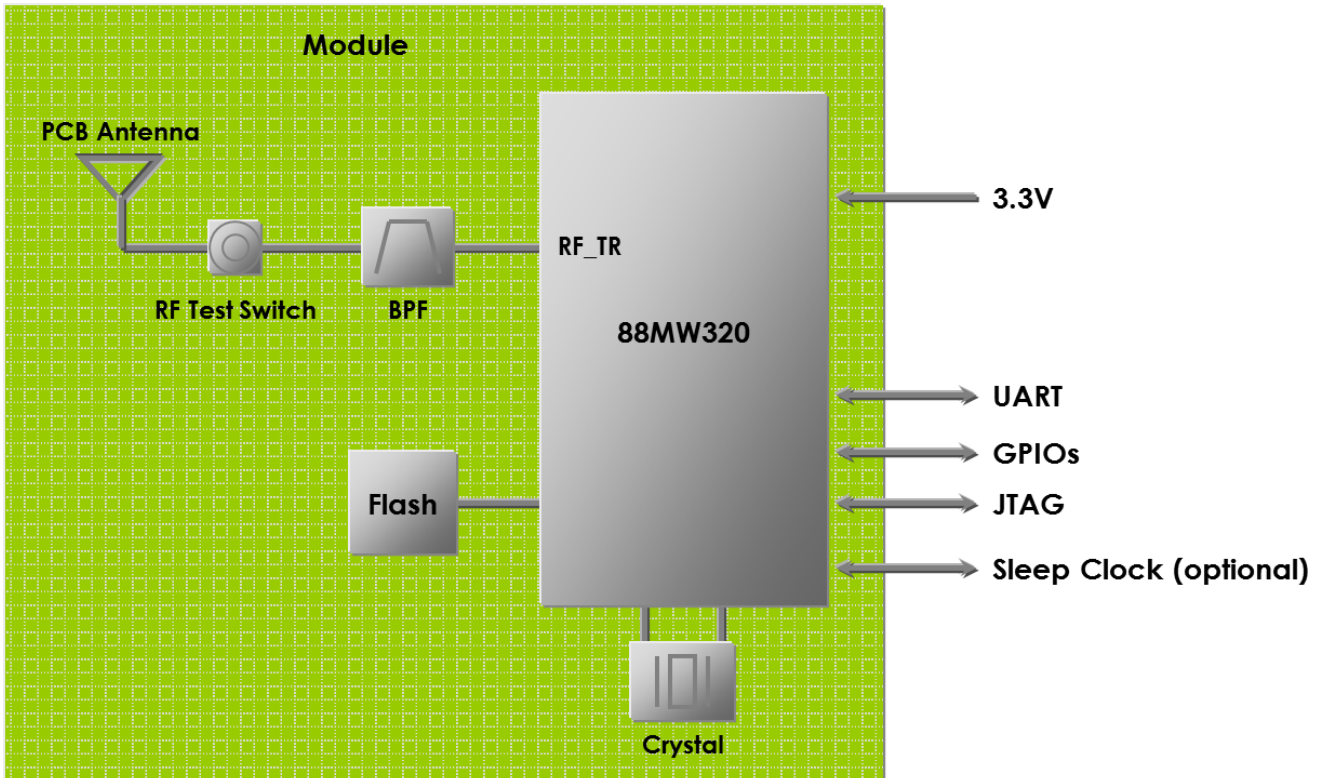

4. FCC/IC

FCC ID: VPYCMWC1ZZABR
IC ID: 772C-CMWC1ZZABR

5. Construction, Dimensions, Marking and Terminal Configurations

5.1 Construction

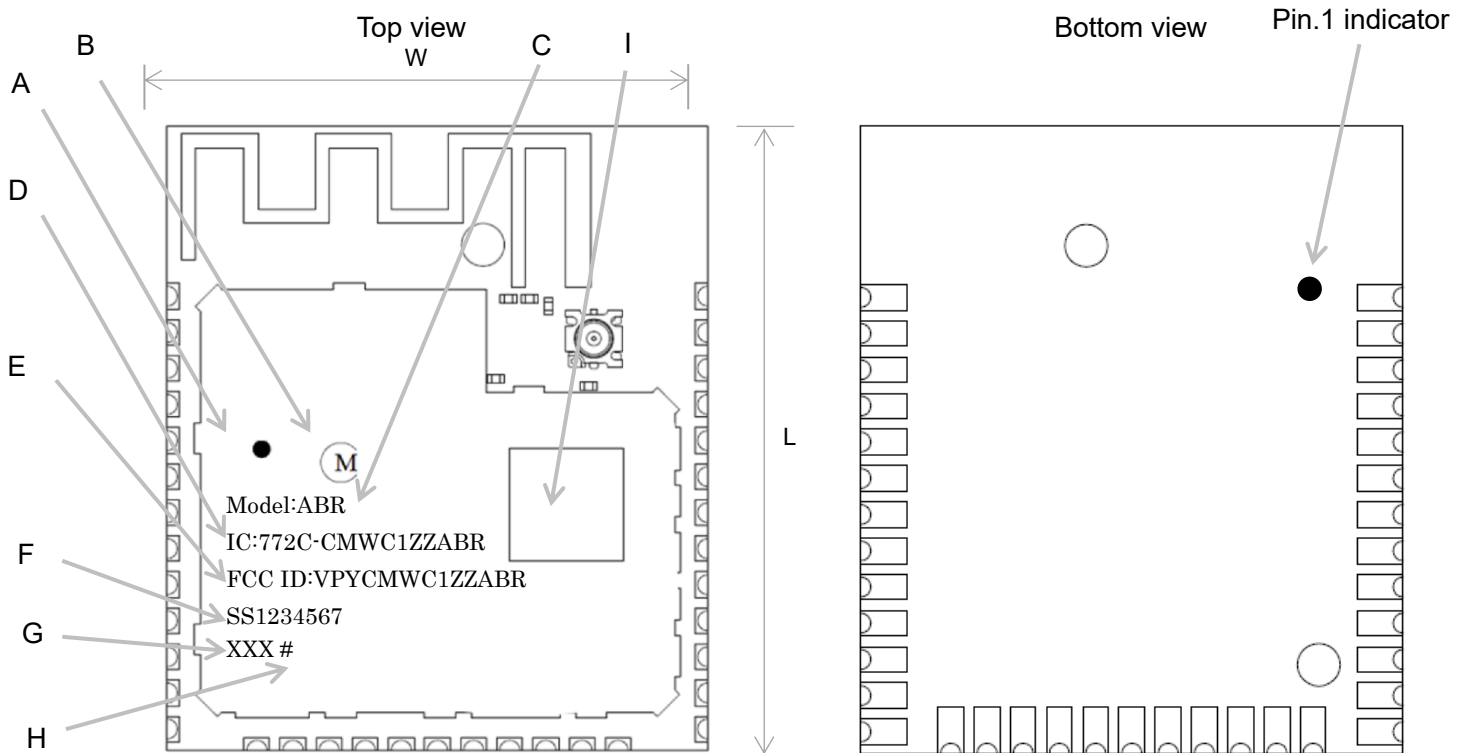

5.2 Dimensions (in mm)

Mark	Min.	Typ.	Max.
L	21.8	22	22.2
W	18.8	19	19.2
T	-	2.4	2.55

5.3 Label Marking

Mark	Name
A	Pin.1 indicator
B	Murata logo
C	Model Name / P/N
D	IC certification ID
E	FCC certification ID
F	Inspection code
G	Sub type number: 105
H	Version code
I	2D barcode (MAC address)

5.4 Pin assignment (top view)

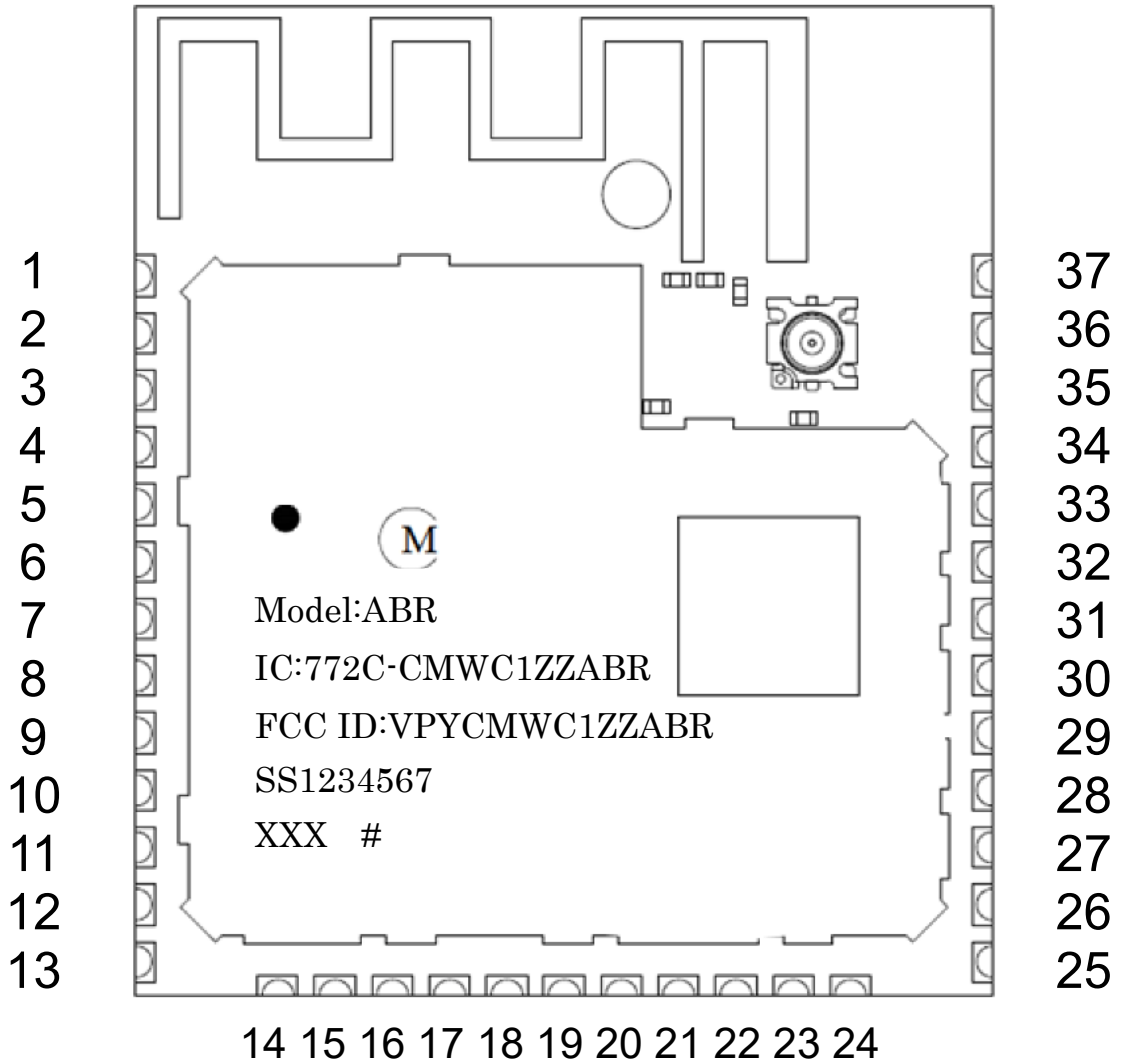

5.5 Recommended land pattern

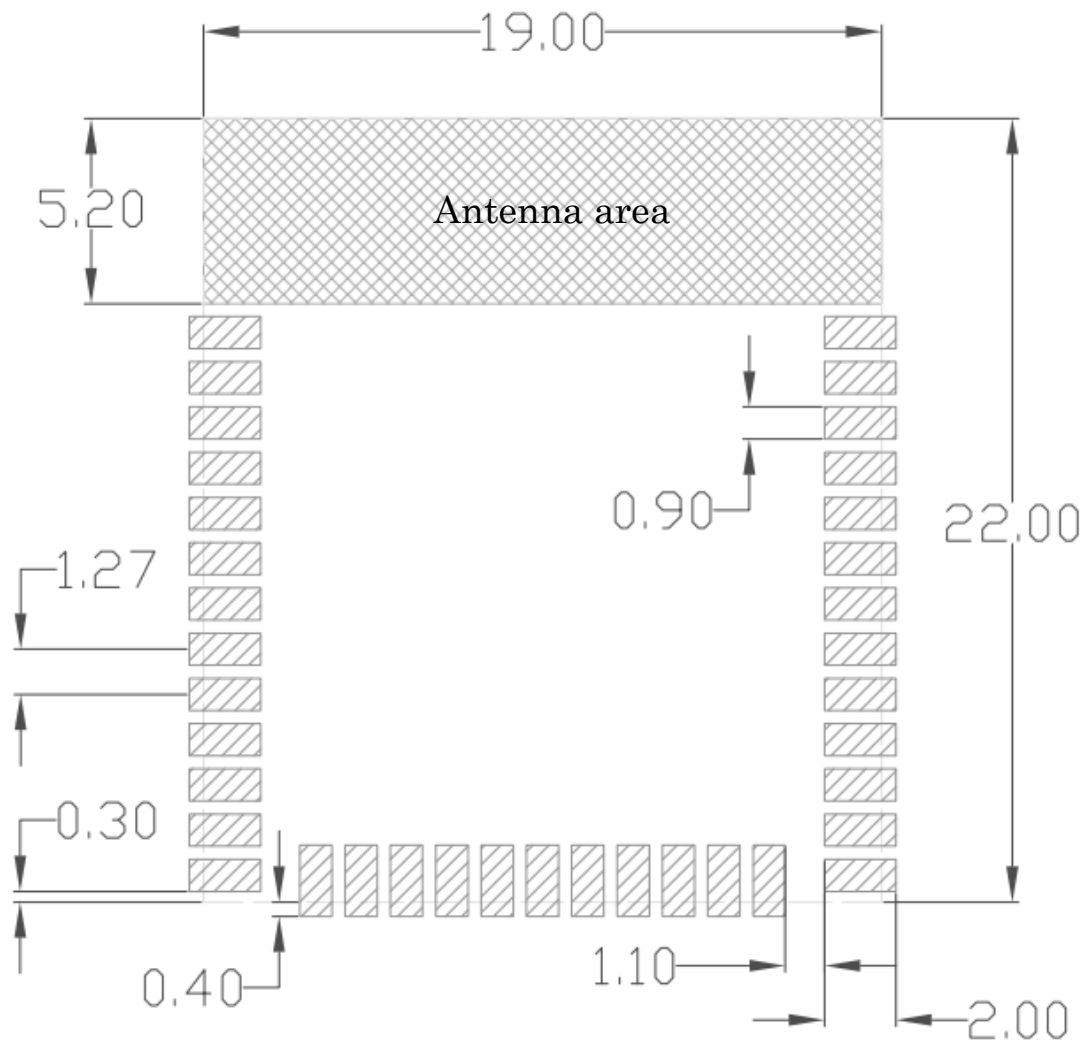

5.6 Pin description

No.	Name	Function	I/O	MW320 Pin No.	MW320 Pin Function
1	GPIO_16	CON[5]: Configuration Bit	I/O	30	GPIO_16
2	RESET_N	Module Reset (active low)	I	35	RESETn
3	GPIO_22	NC		36	GPIO_22
4	GPIO_23	Functional Button Pin (optional)	I	37	GPIO_23
5	GPIO_24	NC		38	GPIO_24
6	GND				
7	GPIO_25	32.768 kHz Crystal Input / Oscillator Input	I	39	GPIO_25
8	GPIO_26	32.768 kHz Crystal Output	O	40	GPIO_26
9	GND				
10	GPIO_27	CON[4]: Configuration Bit	I/O	51	GPIO_27
11	GPIO_39	NC		52	GPIO_39
12	GND				
13	VDD33	3.3V DC Power Supply	P		
14	GPIO_40	LED_1: Module Status Indication (optional)	O	55	GPIO_40
15	GPIO_41	LED_2: Link Status Indication (optional)	O	56	GPIO_41
16	GPIO_42	NC		58	GPIO_42
17	GPIO_43	NC		59	GPIO_43
18	GPIO_44	NC		60	GPIO_44
19	GPIO_45	NC		61	GPIO_45
20	GND				
21	GPIO_46	NC		62	GPIO_46
22	GPIO_47	NC		63	GPIO_47
23	GPIO_48	Debug Log (optional)	O	64	GPIO_48
24	GPIO_49	NC		65	GPIO_49
25	GPIO_0	UART CTS (optional)	I	1	GPIO_0
26	GPIO_1	UART RTS (optional)	O	2	GPIO_1
27	GPIO_2	UART Transmit	O	3	GPIO_2
28	GPIO_3	UART Receive	I	4	GPIO_3
29	GND				
30	GPIO_4	NC		6	GPIO_4
31	GPIO_5	NC		7	GPIO_5
32	GND				
33	GPIO_6	TDO: JTAG Test Data (optional)	O	8	GPIO_6
34	GPIO_7	TCK: JTAG Test Clock (optional)	I	9	GPIO_7
35	GPIO_8	TMS: JTAG Controller Select (optional)	I/O	10	GPIO_8
36	GPIO_9	TDI: JTAG Test Data (optional)	I	11	GPIO_9
37	GPIO_10	TRSTn: JTAG Test Reset (active low) (optional)	I	12	GPIO_10

5.7 Configuration pins

This table shows the pins used as configuration inputs to set parameters following a reset. The definition of these pins changes immediately after reset to their usual function. To set a configuration bit to 0, attach a 100kohm resistor from the pin to ground. No external circuitry is required to set a configuration bit to 1.

Configuration Bits	Pin name	Configuration Function
CON[5]	GPIO_16	Boot Options 00 = boot from UART 01 = reserved 10 = reserved 11 = boot from Flash (default)
CON[4]	GPIO_27	

6. Range

6.1 Absolute maximum rating ($T_a=25^{\circ}\text{C}$, $Z=50\text{ohm}$)

Parameter	Condition	Rating	Units
Storage Temperature		-40 /+85	$^{\circ}\text{C}$
Supply Voltage	VDD33 $T_a=25^{\circ}\text{C}$	3.6	V

Note: Stresses in excess of the absolute ratings may cause permanent damage. Functional operation is not implied under these conditions. Exposure to absolute ratings for extended periods of time may adversely affect reliability. No damage assuming only one parameter is set at limit at a time with all other parameters are set within operating condition.

6.2 Operating conditions

Parameter	Min.	Max.	Units
Operating Temperature	-30	+85	$^{\circ}\text{C}$
Supply Voltage	VDD33 3.0	3.6	V

* Functionality is guaranteed but specifications require derating at extreme temperatures

* This module is not approved for use when being powered by AC power lines, either directly or indirectly through another device.

7. RoHS Compliance

This component can meet with RoHS compliance.

8. RF Characteristics for IEEE802.11

Conditions: 25°C, VDD33= 3.3V

Tx Power Level	Min.	Typ.	Max.	Units
802.11b (11Mbps)	-	17	-	dBm
802.11g (54Mbps)**	-	15	-	dBm
802.11n (HT20 MCS7)**	-	14	-	dBm
Rx Minimum Input Level Sensitivity	Min.	Typ.	Max.	Units
802.11b (11Mbps)	-	-	-76	dBm
802.11g (54Mbps)	-	-	-65	dBm
802.11n (HT20 MCS7)	-	-	-64	dBm

*Test performed through Murata RF switch connector P/N: MM8030-2610.

**For compliance of FCC regulation, it is necessary to set output power as below table.

11b			11g			11n		
CH1	CH2-10	CH11	CH1	CH2-10	CH11	CH1	CH2-10	CH11
17	17	17	12	15	10	10	14	8

9. Power Consumption

Conditions: 25°C, VDD33= 3.3V, Tx on continuous mode

Condition	Typ.	Max.	Units
802.11b (11Mbps), Tx power=17dBm	303	365	mA
802.11g (54Mbps), Tx power=15dBm	285	330	mA
802.11n (HT20 MCS7), Tx power=14dBm	282	325	mA
Rx Idle	83	100	mA

10. Power Up Sequence

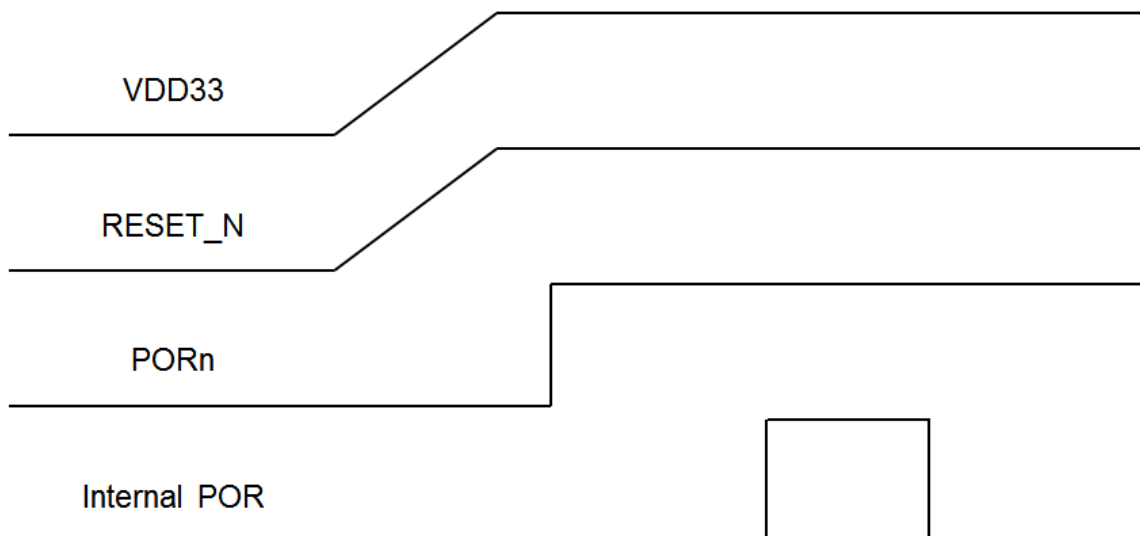

11. Electrical Characteristics

11.1 I/O Static Ratings, 3.3V

Symbol	Parameter	Condition	Min.	Typ.	Max.	Units
V _{IL}	Input low voltage	-	-0.4	-	VDD33*30%	V
V _{IH}	Input high voltage	-	VDD33*70%	-	VDD33+0.4	V
V _{HYS}	Input hysteresis	-	150	-	-	mV
I _{OL@0.4V}	-	-	4	-	-	mA
I _{OH@VDDIO-0.5V}	-	-	3	-	-	mA
Input capacitance	-	-	-	-	5	pF
Input leakage 1	-	VDD33 is ON, 0<V(PAD)<VDD33	-	-	5	μA

11.2 Clock Specifications (optional)

11.2.1 RC32K Specifications

Parameter	Condition	Min.	Typ.	Max.	Units
Frequency before calibration	-	18.6	31.8	39.8	kHz
Startup time	-	-	0.9	-	ms
After-calibration frequency accuracy	Use 32.768kHz crystal as reference clock	32.3	32.7	33.1	kHz
Temperature tolerance	-	-	65	-	ppm/C
Duty cycle	-	40	50	60	%

11.2.2 Crystal Specifications (32.768kHz)

Parameter	Condition	Min.	Typ.	Max.	Units
Crystal frequency	-	-	32.768	-	kHz
Frequency accuracy tolerance	-	-40	-	40	ppm
Startup time	-	-	-	600	ms
Duty cycle tolerance	-	-	50	-	%
Crystal load capacitance	-	-	12.5	-	pF
Crystal shunt capacitance	-	-	-	7	pF
Equivalent Series Resistance (ESR)	-	-	-	100	kΩ

12. Reference Circuit

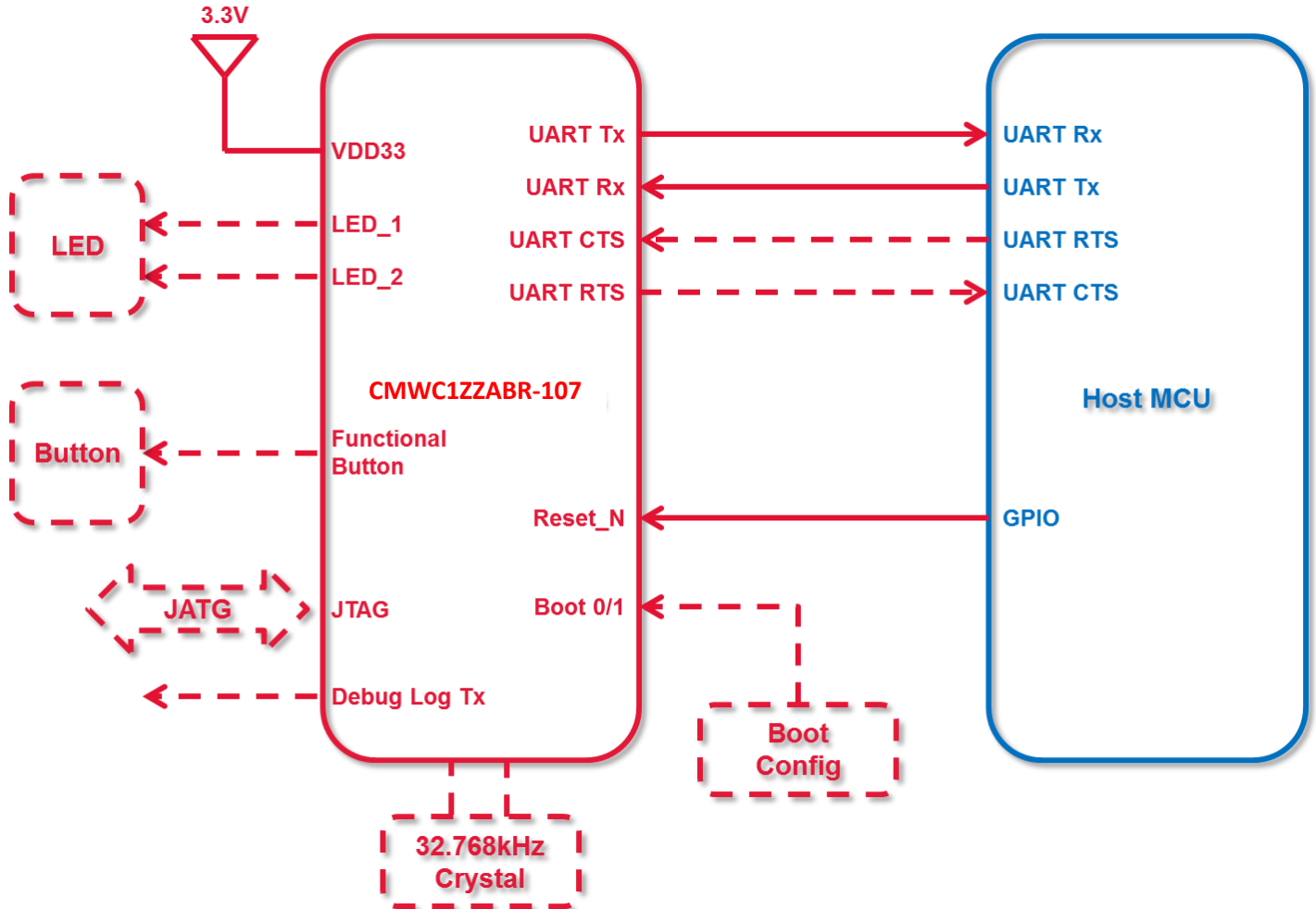

13. PCB Antenna Layout Guidance

If to use internal PCB antenna, some guides must be followed in order to get best antenna performance.

- (1) Place the antenna area on the corner or edge of the main board.
- (2) No ground, circuit, component under the antenna area, including the reverse side of PCB. No ground area is as large as possible.
- (3) Metal component should be at least 10mm away from PCB antenna.
- (4) Plastic case should be at least 10mm away from PCB antenna. If it's metal case, it's recommended to use external antenna.

14. Package

This module product is packaged in tray.

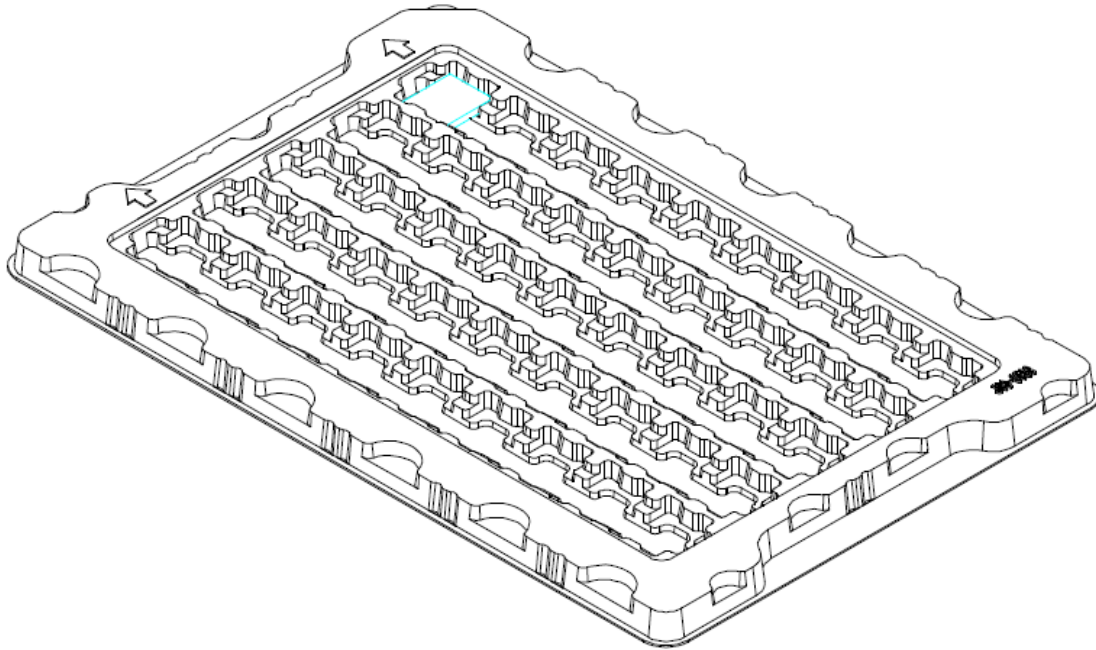

1 tray: 45pcs products
1 inner box: 6 trays with products
1 outer box: 4 inner boxes
MOQ: 1080pcs

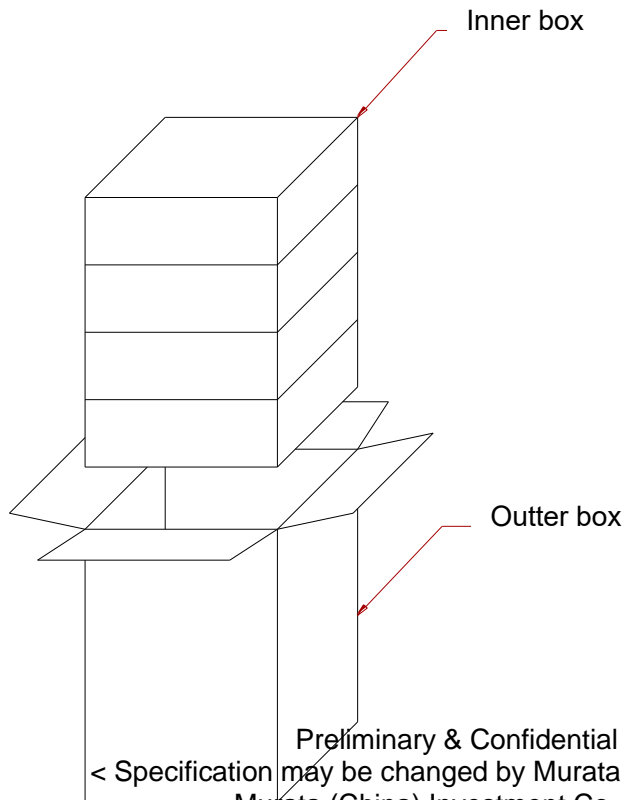

15. FCC/IC Statement

FCC statement:

This module has been tested and found to comply with the FCC Part15.

These limits are designed to provide reasonable protection against harmful interference in approved installations.

This equipment generates, uses, and can radiate radio frequency energy and, if not installed and used in accordance the instructions, may cause harmful interference to radio communications.

However, there is no guarantee that interference will not occur in a particular installation.

This device complies with part 15 of the FCC Rules. Operation is subject to the following two conditions: (1) This device may not cause harmful interference, and (2) this device must accept any interference received, including interference that may cause undesired operation.

Modifications or changes to this equipment not expressly approved by Murata Manufacturing Co., Ltd. may void the user's authority to operate this equipment.

The modular transmitter must be equipped with either a permanently affixed label or must be capable of electronically displaying its FCC identification number

(A) If using a permanently affixed label, the modular transmitter must be labeled with its own FCC identification number, and, if the FCC identification number is not visible when the module is installed inside another device, then the outside of the device into which the module is installed must also display a label referring to the enclosed module. This exterior label can use wording such as the following: "Contains Transmitter Module FCC ID: [VPYCMWC1ZZABR]" or "Contains FCC ID: [VPYCMWC1ZZABR]."

(B) If the modular transmitter uses an electronic display of the FCC identification number, the information must be readily accessible and visible on the modular transmitter or on the device in which it is installed. If the module is installed inside another device, then the outside of the device into which the module is installed must display a label referring to the enclosed module. This exterior label can use wording such as the following: "Contains FCC certified transmitter module(s)."

To satisfy FCC RF Exposure requirements for mobile and base station transmission devices, a separation distance of 20 cm or more should be maintained between the antenna of this device and persons during operation. To ensure compliance, operation at closer than this distance is not recommended. The antenna(s) used for this transmitter must not be co-located or operating in conjunction with any other antenna or transmitter.

IC statement:

Label of the end product:

The final end product must be labeled in a visible area with the following "Contains transmitter module IC: [772C-CMWC1ZZABR] "

This Class B digital apparatus complies with Canadian ICES-003.

Cet appareil numérique de la classe B est conforme à la norme NMB-003 du Canada.

This device complies with RSS-247 of the Industry Canada Rules. Operation is subject to the following two conditions: (1) This device may not cause harmful interference, and (2) this device must accept any interference received, including interference that may cause undesired operation.

Ce dispositif est conforme à la norme CNR-247 d'Industrie Canada applicable aux appareils radio exempts de licence. Son fonctionnement est sujet aux deux conditions suivantes: (1) le dispositif ne doit pas produire de brouillage préjudiciable, et (2) ce dispositif doit accepter tout brouillage reçu, y compris un brouillage susceptible de provoquer un fonctionnement indésirable.

Radiation Exposure Statement:

This equipment complies with IC radiation exposure limits set forth for an uncontrolled environment. This equipment should be installed and operated with minimum distance 20cm between the radiator & your body.

Déclaration d'exposition aux radiations:

Cet équipement est conforme aux limites d'exposition aux rayonnements IC établies pour un environnement non contrôlé. Cet équipement doit être installé et utilisé avec un minimum de 20cm de distance entre la source de rayonnement et votre corps.

NOTICE

1. Storage Conditions

Please use this product within 6month after receipt.

- The product shall be stored without opening the packing under the ambient temperature from 5 to 35 °C and humidity from 20 ~ 70 %RH.
(Packing materials, in particular, may be deformed at the temperature over 40 °C)
- The product left more than 6months after reception, it needs to be confirmed the solderability before used.
- The product shall be stored in non corrosive gas (Cl₂, NH₃, SO₂, Nox, etc.).
- Any excess mechanical shock including, but not limited to, sticking the packing materials by sharp object and dropping the product, shall not be applied in order not to damage the packing materials.

This product is applicable to MSL3 (Based on IPC/JEDEC J-STD-020)

- After the packing opened, the product shall be stored at <30 °C / <60 %RH and the product shall be used within 168 hours.
- When the color of the indicator in the packing changed, the product shall be baked before soldering.

Baking condition: 125 +5/-0 °C, 24 hours, 1 time

The products shall be baked on the heat-resistant tray because the material is not heat-resistant.

2. Handling Conditions :

Be careful in handling or transporting products because excessive stress or mechanical shock may break products.

Handle with care if products may have cracks or damages on their terminals, the characteristics of products may change. Do not touch products with bear hands that may result in poor solderability.

3. Standard PCB Design (Land Pattern and Dimensions) :

All the ground terminals should be connected to the ground patterns. Furthermore, the ground pattern should be provided between IN and OUT terminals. Please refer to the specifications for the standard land dimensions.

The recommended land pattern and dimensions is as Murata's standard. The characteristics of products may vary depending on the pattern drawing method, grounding method, land dimensions, land forming method of the NC terminals and the PCB material and thickness. Therefore, be sure to verify the characteristics in the actual set. When using non-standard lands, contact Murata beforehand.

4. Notice for Chip Placer :

When placing products on the PCB, products may be stressed and broken by uneven forces from a worn-out chucking locating claw or a suction nozzle. To prevent products from damages, be sure to follow the specifications for the maintenance of the chip placer being used. For the positioning of products on the PCB, be aware that mechanical chucking may damage products.

5. Soldering Conditions :

The recommendation conditions of soldering are as in the following figure.

When products are immersed in solvent after mounting, pay special attention to maintain the

temperature difference within 100 °C. Soldering must be carried out by the above mentioned conditions to prevent products from damage. Set up the highest temperature of reflow within 260 °C. Contact Murata before use if concerning other soldering conditions.

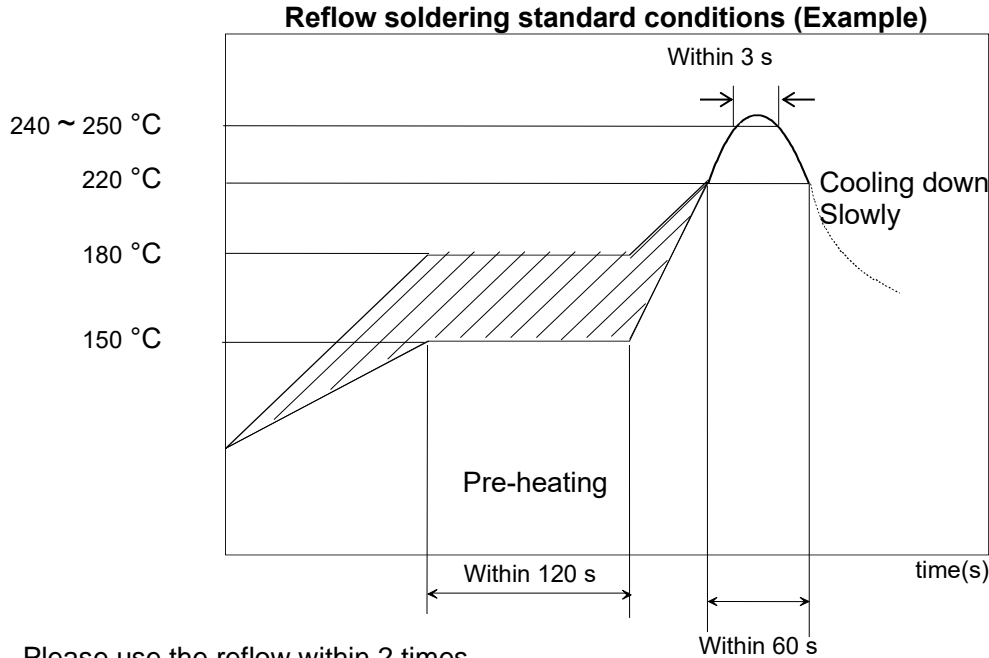

Please use the reflow within 2 times.

Use rosin type flux or weakly active flux with a chlorine content of 0.2 wt % or less.

6. Cleaning :

Since this Product is Moisture Sensitive, any cleaning is not permitted.

7. Operational Environment Conditions :

Products are designed to work for electronic products under normal environmental conditions (ambient temperature, humidity and pressure). Therefore, products have no problems to be used under the similar conditions to the above-mentioned. However, if products are used under the following circumstances, it may damage products and leakage of electricity and abnormal temperature may occur.

- In an atmosphere containing corrosive gas (Cl₂, NH₃, SO_x, NO_x, etc.).
- In an atmosphere containing combustible and volatile gases.
- Dusty place.
- Direct sunlight place.
- Water splashing place.
- Humid place where water condenses.
- Freezing place.

If there are possibilities for products to be used under the preceding clause, consult with Murata before actual use.

As it might be a cause of degradation or destruction to apply static electricity to products, do not apply static electricity or excessive voltage while assembling and measuring.

8. Input Power Capacity :

Products shall be used in the input power capacity as specified in this specifications.

Inform Murata beforehand, in case that the components are used beyond such input power capacity range.

 **CAUTION**

PLEASE READ THIS NOTICE BEFORE USING OUR PRODUCTS.

Please make sure that your product has been evaluated and confirmed from the aspect of the fitness for the specifications of our product when our product is mounted to your product.

All the items and parameters in this product specification/datasheet/catalog have been prescribed on the premise that our product is used for the purpose, under the condition and in the environment specified in this specification. You are requested not to use our product deviating from the condition and the environment specified in this specification.

Please note that the only warranty that we provide regarding the products is its conformance to the specifications provided herein. Accordingly, we shall not be responsible for any defects in products or equipment incorporating such products, which are caused under the conditions other than those specified in this specification.

WE HEREBY DISCLAIMS ALL OTHER WARRANTIES REGARDING THE PRODUCTS, EXPRESS OR IMPLIED, INCLUDING WITHOUT LIMITATION ANY WARRANTY OF FITNESS FOR A PARTICULAR PURPOSE, THAT THEY ARE DEFECT-FREE, OR AGAINST INFRINGEMENT OF INTELLECTUAL PROPERTY RIGHTS.

The product shall not be used in any application listed below which requires especially high reliability for the prevention of such defect as may directly cause damage to the third party's life, body or property. You acknowledge and agree that, if you use our products in such applications, we will not be responsible for any failure to meet such requirements.

Furthermore, YOU AGREE TO INDEMNIFY AND DEFEND US AND OUR AFFILIATES AGAINST ALL CLAIMS, DAMAGES, COSTS, AND EXPENSES THAT MAY BE INCURRED, INCLUDING WITHOUT LIMITATION, ATTORNEY FEES AND COSTS, DUE TO THE USE OF OUR PRODUCTS IN SUCH APPLICATIONS.

- Aircraft equipment.
- Aerospace equipment
- Undersea equipment.
- Power plant control equipment
- Medical equipment.
- Transportation equipment (vehicles, trains, ships, elevator, etc.).
- Traffic signal equipment.
- Disaster prevention / crime prevention equipment.
- Burning / explosion control equipment
- Application of similar complexity and/ or reliability requirements to the applications listed in the

above.

We expressly prohibit you from analyzing, breaking, Reverse-Engineering, remodeling altering, and reproducing our product. Our product cannot be used for the product which is prohibited from being manufactured, used, and sold by the regulations and laws in the world.

We do not warrant or represent that any license, either express or implied, is granted under any our patent right, copyright, mask work right, or our other intellectual property right relating to any combination, machine, or process in which our products or services are used. Information provided by us regarding third-party products or services does not constitute a license from us to use such products or services or a warranty or endorsement thereof. Use of such information may require a license from a third party under the patents or other intellectual property of the third party, or a license from us under our patents or other intellectual property.

Please do not use our products, our technical information and other data provided by us for the purpose of developing of mass-destruction weapons and the purpose of military use.

Moreover, you must comply with "foreign exchange and foreign trade law", the "U.S. export administration regulations", etc.

Please note that we may discontinue the manufacture of our products, due to reasons such as end of supply of materials and/or components from our suppliers.

Customer acknowledges that Murata will, if requested by you, conduct a failure analysis for defect or alleged defect of Products only at the level required for consumer grade Products, and thus such analysis may not always be available or be in accordance with your request (for example, in cases where the defect was caused by components in Products supplied to Murata from a third party).

By signing on specification sheet or approval sheet, you acknowledge that you are the legal representative for your company and that you understand and accept the validity of the contents herein. When you are not able to return the signed version of specification sheet or approval sheet within 90 days from receiving date of specification sheet or approval sheet, it shall be deemed to be your consent on the

content of specification sheet or approval sheet.

Customer acknowledges that engineering samples may deviate from specifications and may contain defects due to their development status.

We reject any liability or product warranty for engineering samples.

In particular we disclaim liability for damages caused by

- the use of the engineering sample other than for evaluation purposes, particularly the installation or integration in the product to be sold by you,
- deviation or lapse in function of engineering sample,
- improper use of engineering samples.

We disclaim any liability for consequential and incidental damages.

If you can't agree the above contents, you should inquire our sales.

X-ON Electronics

Largest Supplier of Electrical and Electronic Components

Click to view similar products for [WiFi Modules - 802.11 category](#):

Click to view products by [Murata manufacturer](#):

Other Similar products are found below :

[KBPC10/15/2506WP](#) [WIFI-RT5392-SB-R10](#) [SX-PCEAN2C-SP](#) [849WM520100E](#) [WIFI-AT2350](#) [7265.NGWG.SW](#) [HDG204-DN-3](#) [FXX-3061-MIX](#) [EMIO-1533-00A2](#) [7265.NGWWB.W](#) [PPC-WL-KIT02-R11](#) [RC-CC2640-B](#) [HLK-7688A](#) [E70-433T14S](#) [WH-NB73-BA](#) [NF-02-PA](#) [EAR00364](#) [ATSAMW25H18-MR210PB1961](#) [3168.NGWG](#) [MY-WF003U](#) [AX210.NGWG.NV](#) [ESP-15F32Mbit](#) [ESP32-S32Mb](#) [TG-01M](#) [ESP-13](#) [ESP-01F-2M](#) [ESP-01E-2M](#) [ESP-12S-8285-2M](#) [ESP-20](#) [ESP32-SL](#) [ESP-12K-PSRAM](#) [ESP-12K](#) [ESP-12K-PSRAM-IPEX](#) [ESP-12H](#) [BW18](#) [BW12-16Mb](#) [BW14](#) [BW15](#) [BW16](#) [TG-12F](#) [SIM7600CE-L1S](#) [CB3S\(tjrl\)](#) [CB3S\(hvk9\)](#) [CB3S\(qh6\)](#) [WB2S\(csyd\)](#) [WB3S\(ppty\)](#) [WB3S\(h238\)](#) [WB3S\(uvmz\)](#) [1005869](#) [1012](#)