

## Chip Common Mode Choke Coil

**DLP31SN□□□ML2□**

## Reference Specification

### 1.Scope

This reference specification applies to Chip Common Mode Choke Coil DLP31SN\_ML Series.

### 2.Part Numbering

(ex.)  $\frac{DL}{(1)} \frac{P}{(2)} \frac{31}{(3)} \frac{S}{(4)} \frac{N}{(5)} \frac{551}{(6)} \frac{M}{(7)} \frac{L}{(8)} \frac{2}{(9)} \frac{L}{(10)}$

- |                                 |  |
|---------------------------------|--|
| (1) Chip Common Mode Choke Coil | (6) Impedance (Typ. at 100MHz)               |
| (2) Structure (P : Film Type)   | (7) Circuit                                  |
| (3) Dimension (L×W)             | (8) Features                                 |
| (4) Type                        | (9) Number of Line                           |
| (5) Category                    | (10) Packaging Code    L : Taping / B : Bulk |

### 3.Rating

| Customer Part Number | Murata Part Number | Common Mode Impedance<br>(at 100MHz, Under Standard Testing Condition) | Rated Voltage | Withstanding Voltage | Rated Current | DC Resistance | Insulation Resistance |
|----------------------|--------------------|--|---------------|----------------------|---------------|---------------|-----------------------|
|                      | DLP31SN121ML2L     | 120Ω ±20%  | 16V(DC)       | 40V(DC)              | 100mA         | 2.0Ω max.     | 100MΩ min.            |
|                      | DLP31SN121ML2B     |  |               |                      |               | 2.5Ω max.     |                       |
|                      | DLP31SN221ML2L     | 220Ω ±20%  |               |                      |               | 3.6Ω max.     |                       |
|                      | DLP31SN221ML2B     |  |               |                      |               |               |                       |
|                      | DLP31SN551ML2L     | 550Ω ±20%  |               |                      |               |               |                       |
|                      | DLP31SN551ML2B     |  |               |                      |               |               |                       |

Operating Temperature : -40 to +85°C    Storage Temperature    : -40 to +85°C

### 4. Standard Testing Conditions

<Unless otherwise specified>  
 Temperature : Ordinary Temperature    15 to 35°C  
 Humidity : Ordinary Humidity    25 to 85%(RH)

<In case of doubt>  
 Temperature : 20 ± 2°C  
 Humidity : 60 to 70%(RH)  
 Atmospheric Pressure : 86 to 106kPa

### 5.Style and Dimensions

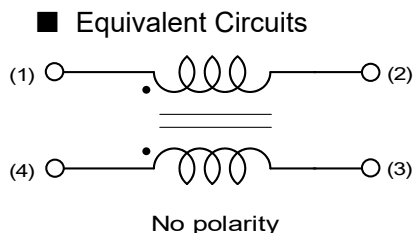
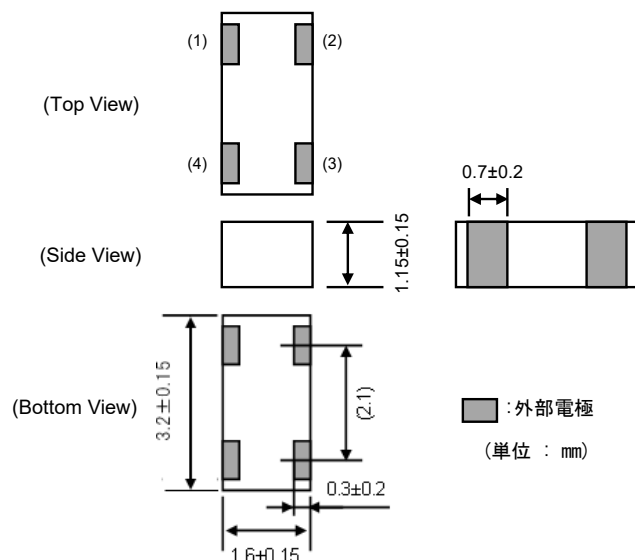

■ Unit Mass (Typical value)  
0.030g

### 6.Marking

No Marking.

# Reference Only

## 7. Electrical Performance

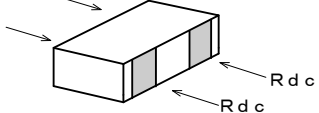
| No. | Item                         | Specification                  | Test Method  |
|-----|------------------------------|--------------------------------|--|
| 7.1 | Common Mode Impedance        | Meet item 3.                   | Measuring Frequency : 100±1MHz (ref.item 10.)<br>Measuring Equipment : KEYSIGHT4291A or the equivalents<br>(In case of doubt in standard condition, the heat treatment (200°C, about 10 minutes) shall be applied. |
| 7.2 | Withstanding Voltage         | Products shall not be damaged. | Test Voltage : 2.5 times for Rated Voltage<br>Time : 1 to 5 seconds<br>Charge Current : 1 mA max.(ref.item 10.)  |
| 7.3 | DC Resistance (Rdc)          | Meet item 3.                   | Measuring current : 100mA max.(ref.item 10.)<br>   |
| 7.4 | Insulation Resistance (I.R.) |                                | Measuring voltage : Rated Voltage<br>Measuring time : 1 minute max. (ref.item 10.)   |

## 8. Mechanical Performance

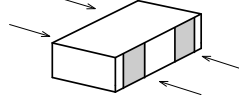
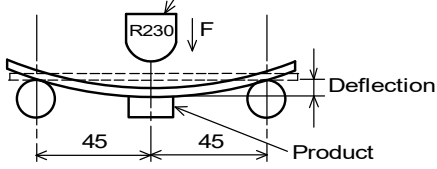
| No.                          | Item                         | Specification  | Test Method  |              |   |              |      |            |  |
|------------------------------|------------------------------|--|--|--------------|---|--------------|------|------------|--|
| 8.1                          | Appearance and Dimensions    | Meet item 5.   | Visual Inspection and measured with Slide Calipers.  |              |   |              |      |            |  |
| 8.2                          | Solderability                | The electrodes shall be at least 95% covered with new solder coating.<br>  | Flux : Ethanol solution of rosin, 25(wt)%<br>Pre-Heating : 150°C, 1minute<br>Solder : Sn-3.0Ag-0.5Cu<br>Solder Temperature : 245±5°C<br>Immersion Time : 3±1 seconds<br>Immersion and emersion rates : 25 mm / s         |              |   |              |      |            |  |
| 8.3                          | Resistance to Soldering Heat | Meet Table 1.<br><table border="1" style="margin-left: 20px;"> <tr> <td>Appearance</td> <td>No damaged</td> </tr> <tr> <td>Common Mode Impedance Change</td> <td>within ± 20%</td> </tr> <tr> <td>I.R.</td> <td>100MΩ min.</td> </tr> </table> | Appearance   | No damaged   | Common Mode Impedance Change  | within ± 20% | I.R. | 100MΩ min. | Flux : Ethanol solution of rosin, 25(wt)%<br>Pre-Heating : 150°C, 1minute<br>Solder : Sn-3.0Ag-0.5Cu<br>Solder Temperature : 270±5°C<br>Immersion Time : 10±0.5 seconds<br>Immersion and emersion rates : 25 mm / s<br>Then measured after exposure in the room condition for 4 to 48 hours. |
| Appearance                   | No damaged                   |  |  |              |   |              |      |            |  |
| Common Mode Impedance Change | within ± 20%                 |  |  |              |   |              |      |            |  |
| I.R.                         | 100MΩ min.                   |  |  |              |   |              |      |            |  |
| 8.4                          | Bending Strength             | DC Resistance Change<br><table border="1" style="margin-left: 20px;"> <tr> <td>DC Resistance Change</td> <td>within ± 30%</td> </tr> </table>  | DC Resistance Change   | within ± 30% | Substrate : (t = 1.6 mm).<br>Deflection : 2 mm<br>Speed of Applying Force : 0.5 mm / s<br>Keeping time : 30 seconds<br>Pressure jig<br> |              |      |            |  |
| DC Resistance Change         | within ± 30%                 |  |  |              |   |              |      |            |  |
| 8.5                          | Drop                         | Products shall be no failure.  | It shall be dropped on concrete or steel board.<br>Method : free fall<br>Height : 75 cm<br>Attitude from which the product is dropped : 3 directions<br>The Number of Times : 3 times for each direction (Total 9 times) |              |   |              |      |            |  |

# Reference Only

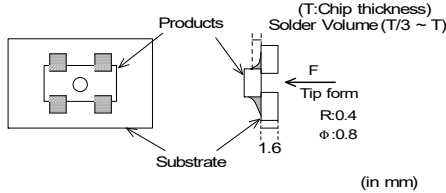
| No. | Item             | Specification   | Test Method  |
|-----|------------------|---|--|
| 8.6 | Bonding Strength | No evidence of coming off glass-epoxy substrate.<br>Products shall not be mechanical damaged. | It shall be soldered on the substrate.<br>Applying Force(F) : 9.8N<br>Applying Time : 30±1seconds<br><br>                                      |
| 8.7 | Vibration        | Meet Table 1.   | It shall be soldered on the substrate.<br>Oscillation Frequency : 10 to 55 to 10Hz for 1 minute<br>Total Amplitude : 1.5mm<br>Testing Time : A period of 2 hours in each of 3 mutually perpendicular directions. (Total 6 hours) |

### 9.Environmental Performance (Products shall be soldered on the glass-epoxy substrate)

| No. | Item              | Specification | Test Method  |
|-----|-------------------|---------------|--|
| 9.1 | Temperature Cycle | Meet Table 1. | 1 Cycle<br>Step 1 -40°C(+0°C,-3°C) / 30(+3,-0) min<br>Step 2 Ordinary Temp. / within 3 min<br>Step 3 +85(+3°C,-0°C) / 30(+3,-0) min<br>Step 4 Ordinary Temp. / within 3 min<br>Total of 100 cycles.<br>Then measured after exposure in the room condition for 4 to 48 hours. |
| 9.2 | Humidity          |               | Temperature : 40±2°C<br>Humidity : 90 to 95 % (RH)<br>Time : 1000 hours(+48 hours,-0 hours)<br>Then measured after exposure in the room condition for 4 to 48 hours.   |
| 9.3 | Heat life         |               | Temperature : 85±2°C<br>Test Voltage : 2 times for Rated Voltage<br>Time : 1000 hours(+48 hours,-0 hours)<br>Then measured after exposure in the room condition for 4 to 48 hours. (ref. Item 10.)   |
| 9.4 | Cold Resistance   |               | Temperature : -40± 2°C<br>Time : 1000 hours(+48 hours,-0 hours)<br>Then measured after exposure in the room condition for 4 to 48 hours.   |

### 10. Terminal to be Tested.

When measuring and supplying the voltage, the following terminal is applied.

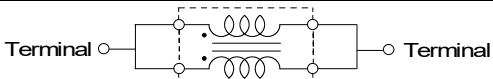
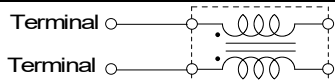
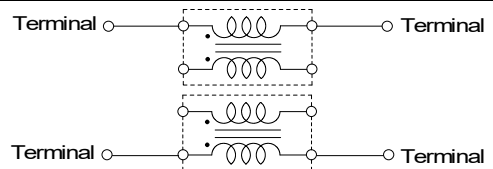
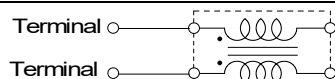
| No.  | Item   | Terminal to be Tested  |
|------|--|--|
| 10.1 | Common Mode Impedance (Measurement Terminal) |  |
| 10.2 | Withstanding Voltage (Measurement Terminal)  |  |
| 10.3 | DC Resistance (Measurement Terminal)         |  |
| 10.4 | Insulation Resistance (Measurement Terminal) |  |
| 10.5 | Heat Life (Supply Terminal)                  |  |

### 11. Measuring method for common mode impedance.

Measured common mode impedance may be included measurement error due to stray capacitance, residual inductance of test fixture.

To correct this error, the common mode impedance should be calculate as follows;

- (1) Measure admittance of the fixture(opened),  $G_0$   $B_0$ .
- (2) Measure impedance of the fixture(shorted),  $R_s$   $X_s$ .
- (3) Measure admittance of the specimen,  $G_m$   $B_m$ .
- (4) Calculate corrected impedance  $|Z|$  using the formula below.

$$|Z| = (R_x^2 + X_x^2)^{1/2}$$

Where

$$R_x = \frac{G_m - G_0}{(G_m - G_0)^2 + (B_m - B_0)^2} - R_s$$

$$X_x = \frac{-(B_m - B_0)}{(G_m - G_0)^2 + (B_m - B_0)^2} - X_s$$

### 12. P.C.B., Flux, Solder and Soldering condition

Test shall be done using P.C.B., Flux, Solder and Soldering condition which are specified in item 16 except the case of being specified special condition.

### 13. Impedance Frequency Characteristics(Typical)

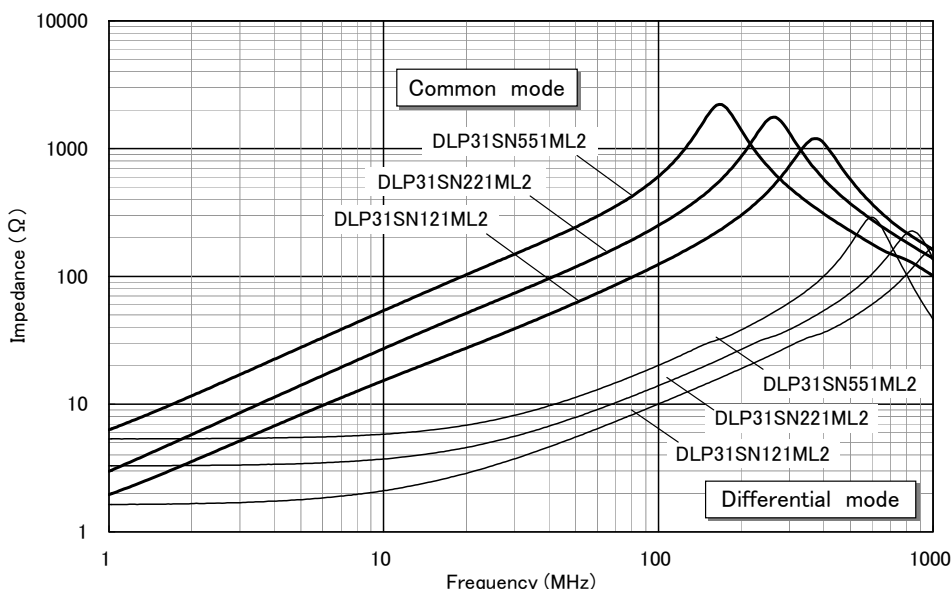

### 14. Specification of Packaging

#### 14.1 Appearance and Dimensions ( 8mm-wide,Plastic tape)

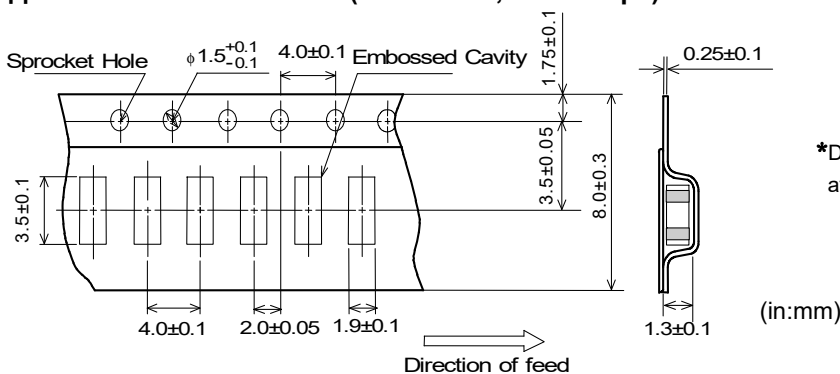

\*Dimension of the Cavity is measured at the bottom side.

(in:mm)

### 14.2 Specification of Taping

- (1)Packing quantity(Standard quantity) 3000 pcs. / reel
- (2)Packing Method  
Products shall be packaged in each embossed cavity of plastic tape and sealed with cover tape.
- (3)Sprocket Hole  
Sprocket hole shall be located on the left hand side toward the direction of feed.
- (4)Spliced point  
The cover tape have no spliced point.
- (5)Missing components number  
Missing components number within 0.1% of the number per reel or 1 pc.,whichever is greater,and are not continuous.The specified quantity per reel is kept.

### 14.3 Pull Strength of Plastic Tape

|              |          |
|--------------|----------|
| Plastic Tape | 5N min.  |
| Cover Tape   | 10N min. |

### 14.4 Peeling off force of Cover Tape

0.2 to 0.7N(Minimum value is Typical)  
Speed of Peeling off : 300 mm/min.

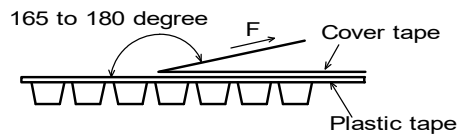

### 14.5 Dimension of Leader-tape,Trailer and Reel

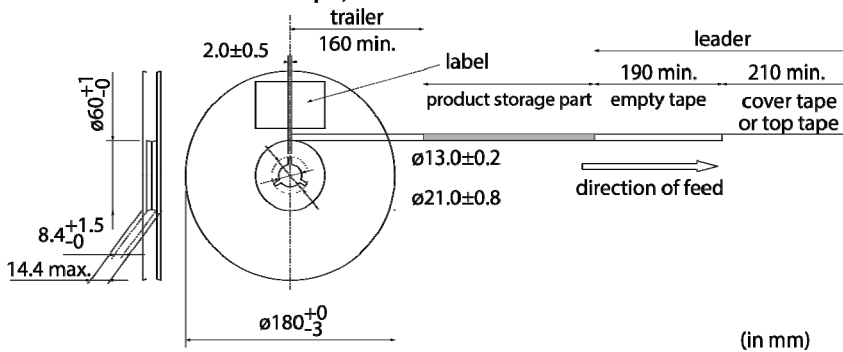

### 14.6 Marking for reel

Customer part number, MURATA part number, Inspection number(\*1), RoHS Marking(\*2), Quantity, etc

\*1) « Expression of Inspection No. »      □□    0000    XXX  
  (1)     (2)     (3)

- (1) Factory Code
- (2) Date                      First digit                      : Year / Last digit of year  
  Second digit                    : Month / Jan. to Sep. → 1 to 9, Oct. to Dec. → O,N,D  
  Third, Fourth digit : Day
- (3) Serial No.

\*2) « Expression of RoHS Marking»      ROHS – Y (Δ)  
  (1) (2)

- (1) RoHS regulation conformity parts.
- (2) MURATA classification number

### 14.7 Marking for Outside package

Customer name Purchasing Order Number, Customer Part Number, MURATA part number, RoHS Marking (\*2), Quantity, etc

### 14.8 Specification of Outer Case

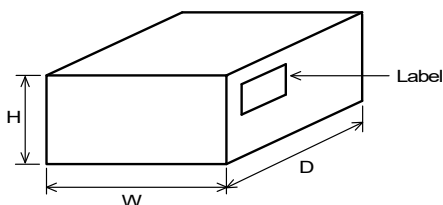

| Outer Case Dimensions (mm) |     |    | Standard Reel Quantity in Outer Case (Reel) |
|----------------------------|-----|----|---|
| W                          | D   | H  |   |
| 186                        | 186 | 93 | 5   |

\* Above Outer Case size is typical. It depends on a quantity of an order.

## 15. Caution

### 15.1 Mounting Direction

Mount products in right direction.

Wrong direction which is 90° rotated from right direction causes not only open or short circuit but also flames or other serious trouble.

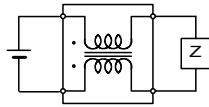

right direction

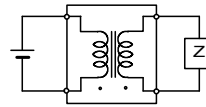

wrong direction

### 15.2 Limitation of Applications

Please contact us before using our products for the applications listed below which require especially high reliability for the prevention of defects which might directly cause damage to the third party's life, body or property.

- |   |   |
|---|---|
| <ul style="list-style-type: none"> <li>(1) Aircraft equipment</li> <li>(2) Aerospace equipment</li> <li>(3) Undersea equipment</li> <li>(4) Power plant control equipment</li> <li>(5) Medical equipment</li> </ul> | <ul style="list-style-type: none"> <li>(6) Transportation equipment (vehicles, trains, ships, etc.)</li> <li>(7) Traffic signal equipment</li> <li>(8) Disaster prevention / crime prevention equipment</li> <li>(9) Data-processing equipment</li> <li>(10) Applications of similar complexity and /or reliability requirements to the applications listed in the above</li> </ul> |
|---|---|

### 15.3 Corrosive gas

Please refrain from use since contact with environments with corrosive gases (sulfur gas [hydrogen sulfide, sulfur dioxide, etc.], chlorine, ammonia, etc.) or oils (cutting oil, silicone oil, etc.) that have come into contact with the previously stated corrosive gas environment will result in deterioration of product quality or an open from deterioration due to corrosion of product electrode, etc. We will not bear any responsibility for use under these environments.

## 16. Notice

This product is designed for solder mounting.

Please consult us in advance for applying other mounting method such as conductive adhesive.

### 16.1 Flux and Solder

|        |   |
|--------|---|
| Flux   | Use rosin-based flux, but not highly acidic flux (with chlorine content exceeding 0.2(wt)%.)<br>Do not use water-soluble flux.  |
| Solder | Use Sn-3.0Ag-0.5Cu solder.<br>Use of Sn-Zn based solder will deteriorate performance of products.<br>In case of using Sn-Zn based solder, please contact Murata in advance. |

### 16.2 Assembling

<Thermal Shock>

Pre-heating should be in such a way that the temperature difference between solder and ceramic surface is limited to 100°C MAX. Also cooling into solvent after soldering should be in such a way that the temperature difference is limited to 100°C max.

### 16.3 Resin coating

The impedance value may change and/or it may affect on the product's performance due to high cure-stress of resin to be used for coating / molding products. So please pay your careful attention when you select resin. In prior to use, please make the reliability evaluation with the product mounted in your application set.

### 16.4 Attention regarding P.C.B. bending

The following shall be considered when designing and laying out P.C.B.'s.

- (1) P.C.B. shall be designed so that products are not subject to the mechanical stress due to warping the board.

[Products direction]

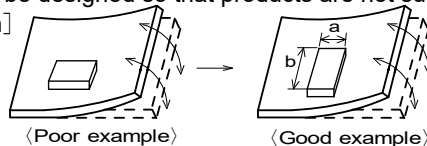

Products shall be location the sideways Direction (Length : a<b) to the mechanical Stress.

(2) Components location on P.C.B. separation.

It is effective to implement the following measures, to reduce stress in separating the board.

It is best to implement all of the following three measures; however, implement as many measures as possible to reduce stress.

| Contents of Measures   | Stress Level |
|--|--------------|
| (1) Turn the mounting direction of the component parallel to the board separation surface. | A > D *1     |
| (2) Add slits in the board separation part.  | A > B        |
| (3) Keep the mounting position of the component away from the board separation surface.    | A > C        |

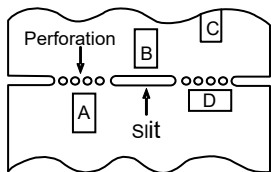

\*1 A > D is valid when stress is added vertically to the perforation as with Hand Separation.  
If a Cutting Disc is used, stress will be diagonal to the PCB, therefore A > D is invalid.

(3) Mounting Components Near Screw Holes

When a component is mounted near a screw hole, it may be affected by the board deflection that occurs during the tightening of the screw. Mount the component in a position as far away from the screw holes as possible.

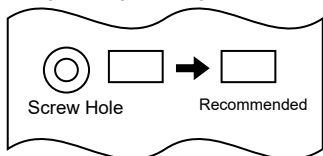

### 16.5 Attention Regarding P.C.B. Design

< The Arrangement of Products >

P.C.B. shall be designed so that products are far from the portion of perforation.

The portion of perforation shall be designed as narrow as possible, and shall be designed so as not to be applied the stress in the case of P.C.B. separation.

Products shall not be arranged on the line of a series of holes when there are big holes in P.C.B.

(Because the stress concentrate on the line of holes.)

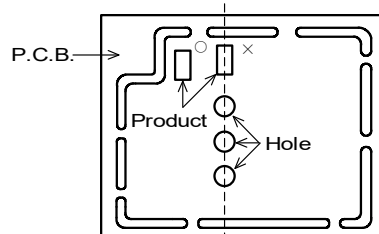
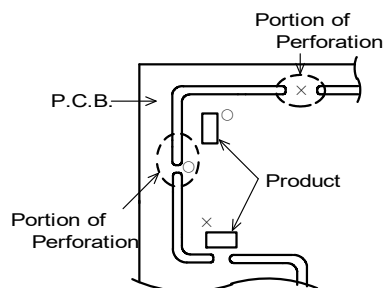

< Products Placing >

Support pins shall be set under P.C.B. to prevent causing a warp to P.C.B. during placing the products on the other side of P.C.B.

< P.C.B. Separation >

P.C.B. shall not be separated with hand.

P.C.B. shall be separated with the fixture so as not to cause P.C.B. bending.

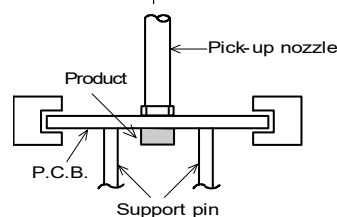

### 16.6 Standard Land Dimensions (Flow and Reflow)

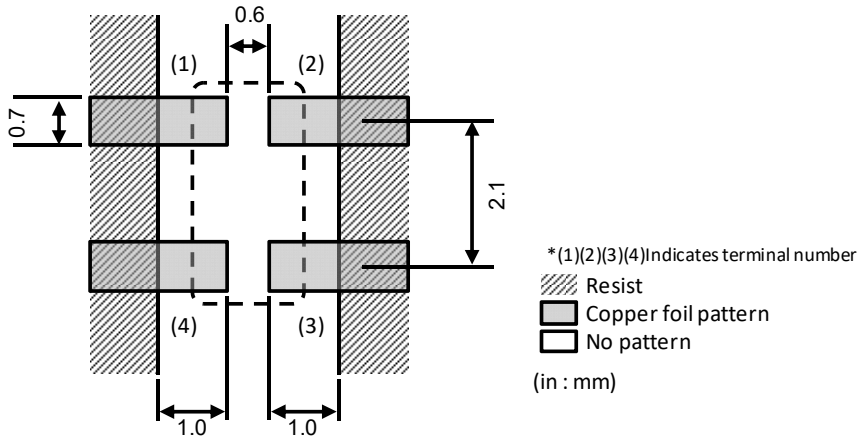

### 16.7 Soldering

#### (1) Standard printing pattern of solder paste

- Standard thickness of the solder paste should be 150 to 200 $\mu$ m.
- Use the solder paste printing pattern of the right pattern.
- For the resist and copper foil pattern, use standard land dimensions.
- Use the Solder Sn-3.0Ag-0.5Cu for pattern printing.

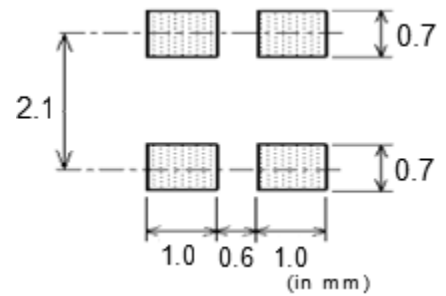

#### (2) Soldering Conditions

Standard soldering profile and the limit soldering profile is as follows.

The excessive limit soldering conditions may cause leaching of the electrode and / or resulting in the deterioration of product quality.

- On flow soldering (e.g. double wave soldering), use the product in consideration of the conditions of solder, solder temperature and immersion time (melting time) because longer soldering time may cause the corrosion of the electrode.
- On dipping soldering, use the product in consideration of the conditions of solder, solder temperature, flux, preheat and so on because de-wetting may be caused.

#### ① Flow soldering profile

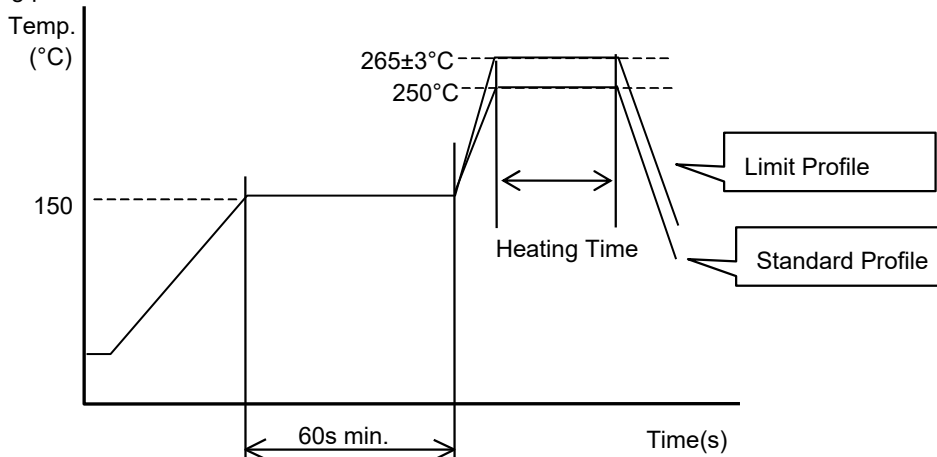

|               | Standard Profile | Limit Profile   |
|---------------|------------------|-----------------|
| Pre-heating   | 150°C、60s min.   |                 |
| Heating       | 250°C、4~6s       | 265±3°C、5s max. |
| Cycle of flow | 2 times          | 2 times         |



② Reflow soldering profile

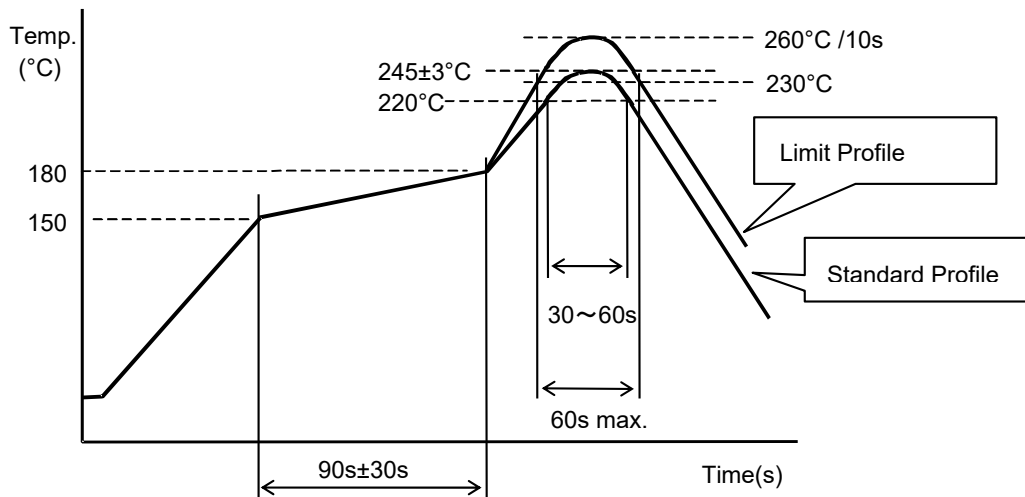

|                  | Standard Profile     | Limit Profile         |
|------------------|----------------------|-----------------------|
| Pre-heating      | 150~180°C 、 90s±30s  |                       |
| Heating          | above 220°C、 30s~60s | above 230°C、 60s max. |
| Peak temperature | 245±3°C              | 260°C、 10s            |
| Cycle of reflow  | 2 times              | 2 times               |

(3) Printing of Adhesive

Adhesive amount shall be about 0.3mg per chip to obtain enough adhesive strength. When the adhesive come into the land pattern, causing poor solderability. The adhesive position is as follows.

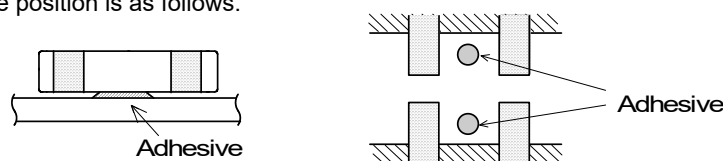

(4) Reworking with Soldering iron

• The following conditions shall be strictly followed when using a soldering iron after being mounted by flow or reflow soldering.

- Pre-heating: 150°C, 1 min
- Tip temperature: 350°C max.
- Soldering time : 3(+1,-0) seconds.
- Soldering iron output: 30W max.
- Tip diameter: φ3mm max.
- Times : 2times max.

Notes : Do not touch the products directly with the soldering iron.

(5) Solder Volume

Solder shall be used not to be exceeded the upper limits as shown below.

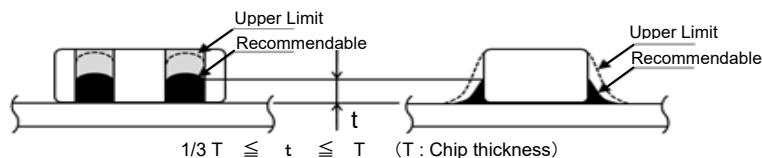

Accordingly increasing the solder volume, the mechanical stress to product is also increased. Excessive solder volume may cause the failure of mechanical or electrical performance.

## 16.8 Cleaning Conditions

Products shall be cleaned on the following conditions.

- (1) Cleaning temperature shall be limited to 60°C max. (40°C max. for Isopropyl alcohol.)
- (2) Ultrasonic cleaning shall comply with the following conditions, avoiding the resonance phenomenon at the mounted products and P.C.B..
  - Power : 20W/l max.
  - Frequency : 28kHz to 40kHz
  - Time : 5 minutes max.
- (3) Cleaner
  1. Alternative cleaner • Isopropyl alcohol (IPA)
  2. Aqueous agent • PINE ALPHA ST-100S
- (4) There shall be no residual flux and residual cleaner after cleaning.

In the case of using aqueous agent, products shall be dried completely after rinse with de-ionized water in order to remove the cleaner.
- (5) Other cleaning  
Please contact us.

## 16.9 Handling of a substrate

After mounting products on a substrate, do not apply any stress to the product caused by bending or twisting to the substrate when cropping the substrate, inserting and removing a connector from the substrate or tightening screw to the substrate.

Excessive mechanical stress may cause cracking in the product.

Bending

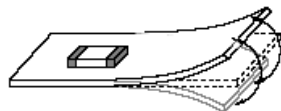

Twisting

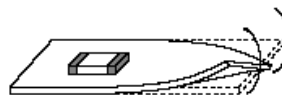

## 16.10 Operating Environment

Do not use this product under the following environmental conditions, on deterioration of the performance, such as insulation resistance may result from the use.

- (1) in corrosive gases (acidic gases, alkaline gases, chlorine, sulfur gases, organic gases and etc.)
- (2) in the atmosphere where liquid such as organic solvent, may splash on the products.

## 16.11 Storage Conditions

- (1) Storage period
  - Use the products within 12 months after delivered.
  - Solderability should be checked if this period is exceeded.
- (2) Storage environment condition
  - Products should be stored in the warehouse on the following conditions.
    - Temperature : -10 to +40°C
    - Humidity : 15 to 85% relative humidity
    - No rapid change on temperature and humidity
  - Products should not be stored in corrosive gases, such as sulfurous, acid gases, alkaline gases, to prevent the following deterioration.
    - Poor solderability due to the oxidized electrode.
  - Products should be stored on the palette for the prevention of the influence from humidity, dust and so on.
  - Products should be stored in the warehouse without heat shock, vibration, direct sunlight and so on.
  - Avoid storing the product by itself bare (i.e. exposed directly to air).
- (3) Delivery
  - Care should be taken when transporting or handling product to avoid excessive vibration or mechanical shock.

## 17. Note

- (1) Please make sure that your product has been evaluated in view of your specifications with our product being mounted to your product.
- (2) You are requested not to use our product deviating from the reference specifications.
- (3) The contents of this reference specification are subject to change without advance notice. Please approve our product specifications or transact the approval sheet for product specifications before ordering.

## X-ON Electronics

Largest Supplier of Electrical and Electronic Components

*Click to view similar products for [Common Mode Chokes / Filters](#) category:*

*Click to view products by [Murata](#) manufacturer:*

Other Similar products are found below :

[74279408](#) [PE-62911NL](#) [PE-64683](#) [ST6118T-R](#) [T8114NLT](#) [RD5122-10-6M0](#) [TCM0806G-350-2P-T](#) [TCM0806G-650-2P-T](#) [IND-0110](#)  
[UAL21V07012500](#) [UAL21VR0802000](#) [UAL24VR06500CH](#) [UALSC023000000](#) [UALSC1020JH000](#) [UALSC1520JH000](#)  
[UALSU10VR20010](#) [UALSU16VD30030](#) [UALSU16VD40010](#) [UALSU9H0305000](#) [UALSU9HF060300](#) [UALSU9VD070100](#) [36-00037](#)  
[5701610000](#) [UALW21HS072450](#) [UALSU9VD070400](#) [UALSU9HF050500](#) [UALSU9H0208000](#) [UALSCF25081300](#) [UAL24VK06450CH](#)  
[PLT10HH501100PNB](#) [PLT10HH401100PNB](#) [PLT10HH1026R0PNB](#) [PE-67531](#) [EXC-X4CH120X](#) [TLH10UB 113 0R5](#) [2752041447](#)  
[2752045447](#) [CMS3-11-R](#) [7351V](#) [CMF16-153131](#) [744252510](#) [T8116NLT](#) [FE2X10-4-2NL](#) [744253200](#) [744253101](#) [744252220](#) [TX8111NLT](#)  
[UAL30VR3500470](#) [CTX01-19077-R](#) [T8003NLT](#)