

DLW43SH101XK2#

“#” indicates a package specification code.

For CAN



< List of part numbers with package codes >

DLW43SH101XK2B DLW43SH101XK2K DLW43SH101XK2L

Appearance & Shape

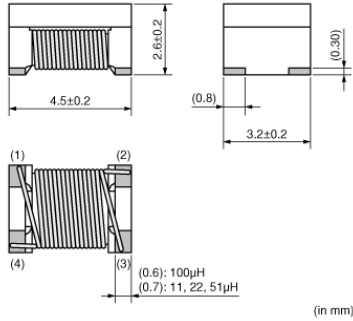
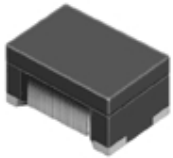

Packaging Information

Packaging	Specifications	Standard Packing Quantity
B	Bulk(Bag)	100
K	330mm Embossed Tape	2500
L	180mm Embossed Tape	500

Features

1. Small size: L4.5xW3.2xT2.6mm (EIAcode: 1812)
Tolerance: 0.2mm
2. Common mode inductance items of 11,22,51,100microH, and they can be used for each applications.

Applications
For Automotive.
Common mode noise suppression of automotive LAN for Flex Ray, CAN.

Applications

Automotive Usage	Powertrain/Safety
------------------	-------------------

Attention
1.This datasheet is downloaded from the website of Murata Manufacturing Co., Ltd. Therefore, it's specifications are subject to change or our products in it may be discontinued without advance notice. Please check with our sales representatives or product engineers before ordering.
2.This datasheet has only typical specifications because there is no space for detailed specifications.
Therefore, please review our product specifications or consult the approval sheet for product specifications before ordering.

DLW43SH101XK2#

“#” indicates a package specification code.



Specifications

Shape	SMD
Size Code (in mm)	4532
Size Code (in inch)	1812
Length	4.5mm
Length Tolerance	±0.2mm
Width	3.2mm
Width Tolerance	±0.2mm
Thickness	2.6mm
Thickness Tolerance	±0.2mm
Rated Current	200mA
Derating of Rated Current	No
Rated Voltage	50Vdc
Withstanding Voltage	125Vdc
DC Resistance(max.)	2Ω
DC Resistance	2.0Ω max.
Insulation Resistance(min.)	10MΩ
Operating Temperature Range	-40°C to 125°C
Mass(typ.)	0.17g
Number of Circuit	1
Common Mode Inductance	100μH-30%/+50% (at 1MHz)
Operating Temperature Range(Self-temperature rise is included)	No

Attention

1.This datasheet is downloaded from the website of Murata Manufacturing Co., Ltd. Therefore, it's specifications are subject to change or our products in it may be discontinued without advance notice. Please check with our sales representatives or product engineers before ordering.

2.This datasheet has only typical specifications because there is no space for detailed specifications.

Therefore, please review our product specifications or consult the approval sheet for product specifications before ordering.

DLW43SH101XK2#

“#” indicates a package specification code.

Product Data

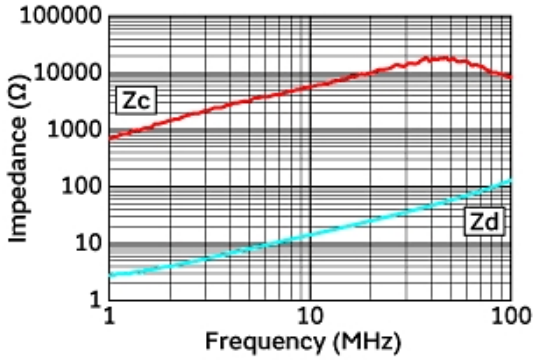

Impedance-Frequency Characteristics

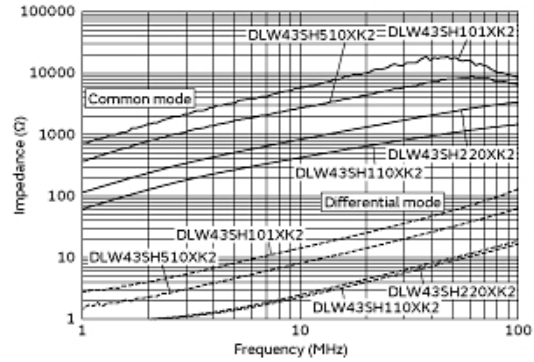

Impedance-Frequency Characteristics (Main Items)

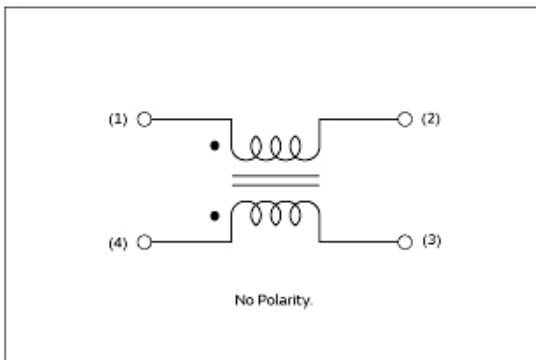

Equivalent Circuit

Attention

- 1.This datasheet is downloaded from the website of Murata Manufacturing Co., Ltd. Therefore, it's specifications are subject to change or our products in it may be discontinued without advance notice. Please check with our sales representatives or product engineers before ordering.
- 2.This datasheet has only typical specifications because there is no space for detailed specifications. Therefore, please review our product specifications or consult the approval sheet for product specifications before ordering.

X-ON Electronics

Largest Supplier of Electrical and Electronic Components

Click to view similar products for [Common Mode Chokes / Filters](#) category:

Click to view products by [Murata](#) manufacturer:

Other Similar products are found below :

[74279408](#) [PE-62911NL](#) [PE-64683](#) [ST6118T-R](#) [T8114NLT](#) [RD5122-10-6M0](#) [TCM0806G-350-2P-T](#) [TCM0806G-650-2P-T](#) [IND-0110](#)
[UAL21V07012500](#) [UAL21VR0802000](#) [UAL24VR06500CH](#) [UALSC023000000](#) [UALSC1020JH000](#) [UALSC1520JH000](#)
[UALSU10VR20010](#) [UALSU16VD30030](#) [UALSU16VD40010](#) [UALSU9H0305000](#) [UALSU9HF060300](#) [UALSU9VD070100](#) [36-00037](#)
[5701610000](#) [UALW21HS072450](#) [UALSU9VD070400](#) [UALSU9HF050500](#) [UALSU9H0208000](#) [UALSCF25081300](#) [UAL24VK06450CH](#)
[PLT10HH501100PNB](#) [PLT10HH401100PNB](#) [PLT10HH1026R0PNB](#) [PE-67531](#) [EXC-X4CH120X](#) [TLH10UB 113 0R5](#) [2752041447](#)
[2752045447](#) [CMS3-11-R](#) [7351V](#) [CMF16-153131](#) [744252510](#) [T8116NLT](#) [FE2X10-4-2NL](#) [744253200](#) [744253101](#) [744252220](#) [TX8111NLT](#)
[UAL30VR3500470](#) [CTX01-19077-R](#) [T8003NLT](#)