

FEATURES

- Universal 85 to 264Vac measurement range
- Self-powered directly from the AC supply
- Installs in "oiltight" 1.20 inch (30.5mm) round cutouts
- Four-digit LED display with overvoltage indication
- Reads true-rms value to 0.1V resolution
- Knockout punches and tooling available
- Digital replacement for analog panel meters
- Screw-style terminal block simplifies installation
- Self-resetting internal fuse for long-term reliability
- Provides moisture resistance to IP67/NEMA 6
- Supplied with EPDM rubber gasket and plastic hex nut
- UL/CSA approvals pending



Murata Power Solutions' new DMR20-1-ACV self-powered, AC line-voltage monitors are designed to measure and display the true-rms voltage of AC power systems. Simply connect any 85 to 264Vac 50/60Hz power source and these meters are fully operational—no additional components or power sources are required. The unit can also measure distorted AC power sources including triangle, square, and the quasi-sine output of many DC to AC power inverters.

The DMR20-1-ACV is housed in a rugged, round polycarbonate case that provides excellent protection against moisture, dust, shock and vibration. Panel installation is straightforward: Using readily available tooling, simply drill and punch a 1.2 inch (30.5mm) diameter hole and anti-rotation notch, insert the meter and gasket, and securely fasten the meter using the supplied hex nut. The supplied hardware is designed to provide protection to IP67/NEMA 6.

Their large, 0.30"/7.6mm, bright LED displays can be easily read from 10 feet away (3 meters). These meters accurately display ac voltages with 0.1V resolution. A built-in resettable fuse assures long term reliability. All DMR20-1-ACVs employ a 13-bit A/D converter and precision metal-film resistors to achieve outstanding performance over an operating temperature range of -25 to +60°C.

Performance/Functional Specifications

Typical at Ta = +25°C, fin = 60Hz

AC Input (TB1)

Voltage Range ①	85 to 264Vac (47-63 Hz)
Current Consumption	@Vin = 250Vac: 30mA (max.) @Vin = 120Vac: 15mA (max.)

Performance

Sampling Rate	2.5 readings/second
Resolution	0.1Vdc
Accuracy @ +25°C	±.1V (typ.), ±.2V (max.)
Temperature Drift	(-25 to +60°C) ±0.05V/°C (max.)

Mechanical

Dimensions	1.50" diameter x 1.15 depth" (38.1 x 29.2mm)
Display Type	Four digit, LED, 0.30" high (7.6mm)
Weight	0.8 ounce (23 grams)
Case Material	Polycarbonate
Terminal Block Torque	3.6 in-lbs (0.4 N-m)
Wire Size And Type	18-22AWG (0.83-0.33mm ²) copper, solid or stranded
Wire Insulation Strip Length	0.25" (6.4mm)

Environmental

Operating Temperature	-25 to +60°C
Storage Temperature	-40 to +75°C
Humidity (non-condensing)	0 to 85%

① Operation and accuracy at inputs above or below these ranges are not specified.

Ordering Information

DMR20-1-ACV-R-C 85 to 264Vac voltage monitor (Red LED)

Knockout Punches

DMR20-1-KP	1.2" (30.5mm) Round knockout punch (no keying notch)
DMR20-2-KP	1.2" (30.5mm) Round knockout punch (with four keying notches)
DMR20-3-KP	1/8" and 3/16" (3.2 and 4.7mm) key-notch nibbler tool

Note: An M30 x 1.5 nylon hex nut and EPDM sealing gasket are supplied with each meter. The "-C" suffix denotes RoHS compliance.



TECHNICAL NOTES



IMPORTANT! To ensure safe and reliable operation, DMR20-1-ACV AC voltage monitors must be installed and serviced by qualified technical personnel. Contact Murata Power Solutions if there is any doubt regarding installation or operation.

- 1. Measurement Type:** DMR20-1-ACV series AC voltmeters employ a precision true-rms signal conditioning IC, a 13-bit analog-to-digital converter, and a stable voltage reference to measure and display 85 to 264Vac 50/60Hz AC supplies. DMR20-1-ACV voltmeters can be powered from—and accurately measure—AC supplies with sine, triangle, square, and quasi-sine waveforms. High-frequency harmonic components up to 65kHz will be measured with minimal additional error.
- 2. Calibration:** DMR20-1-ACV voltmeters are factory calibrated; there are no provisions for calibrating these meters in the field.
- 3. Operating Range:** As the AC input voltage is lowered to 95.0Vac (50 or 60Hz) or below, the DMR20-1-ACV's display will begin to dim slightly, but it will remain accurate down to its 85Vac rating. Input voltages above 265Vac will cause the display to flash on and off at approximately one-second intervals.
- 4. Panel Installation:** All electrical connections to DMR20-1-ACV must be made after the voltmeter is securely attached to the panel, and with the input AC supply de-energized (off). In high-vibration environments, adequate strain reliefs must be used on all supply wiring. See Figure 1 for typical panel mounting details.

Tightening Torque:

The recommended tightening torque for the M30 x 1.5 plastic hex nut is 10 to 17 in-lbs (1.3 to 1.9 N-m). If a torque wrench is not available, this recommended range can be approximated by hand tightening the hex nut SLOWLY until it just bottoms out against the panel's rear surface. From this bottomed-out reference position, using a suitable tool, tightening the hex nut ¼ turn clockwise will produce approximately 10 in-lbs (1.3 N-m) of torque; tightening it 3/8 turn clockwise will produce approximately 17 in-lbs (1.9 N-m).

Check to make sure the housing's anti-rotation key is aligned with the notches on both the panel and the gasket before tightening the hex nut. Over tightening the hex nut will distort the rubber gasket and may damage the threads on both the nut and the housing, thereby compromising the installation's mechanical integrity and its ability to protect against environmental effects.

Panel Thickness:

When using both the factory supplied EPDM gasket and hex nut (the recommended standard installation method), the DMR20-1-ACV can be mounted in panels ranging from 0.032" to 0.250" (0.8 to 6.4mm) thick. When the gasket is not used, the panel thickness range is 0.075" to 0.325" (1.9 to 8.3mm). However, using the factory supplied hardware and tightening torque recommendations results in optimal resistance to vibration, dust, and moisture ingress.

Panel Materials:

Acceptable panel materials include aluminum, mild steels, plastics, FR-4 pc-board (fiberglass), and many other materials with a flat matte surface on both sides of the cutout. The DMR-20-x-KP tools can be used with most panel materials except for stainless steel or other hardened metals.

DMR20-1-ACV has passed vibration testing combined with temperature cycling while mounted to the materials noted above, using the specified tightening torques. If the voltmeter will be mounted to extremely smooth, slippery surfaces, the user is advised to test the completed assembly under the environmental conditions encountered in the end application.

- 5. AC Input Fusing and Wiring:** DMR20-1-ACV voltmeters contain an internal, self-resettable fuse. However, the supply wires connected to input terminals TB1-A and TB1-B must be fused with an external, user supplied, 0.25A/300V time delay/time lag fuse, in accordance with applicable regulatory codes.

All supply wiring must be rated for the voltages and currents they will conduct and comply with any code or application-mandated requirements pertaining to the user's specific installation. 300V, UL-rated hook-up wire suitable for the intended application is required. TB1 is to be used only for powering the meter's internal circuitry; it must not be used to supply power to external loads.

The recommended TB1 supply wire size is 18AWG to 22AWG (0.83mm² to 0.33mm²) solid or stranded copper wire. The supply wires must be properly stripped and attached to TB1 such that their insulation is not pinched by the screw terminal. Recommended insulation strip length is 0.25" (6.4mm). When using stranded wire, verify that there are no loose or stray strands that could potentially cause a short circuit across the AC supply input.

- 6. AC Input Polarity and Grounding:** The AC supply inputs TB1-A and TB1-B terminals are not polarity sensitive, that is, neither terminal is designated as "AC LO" or "AC HI." DMR20-1-ACV voltmeters do not include, nor require, a connection to earth/chassis ground.

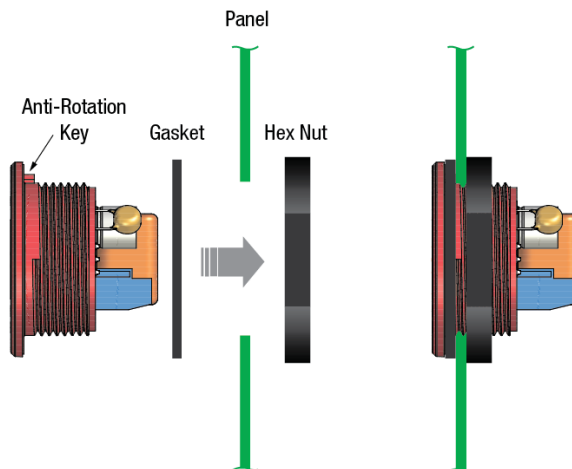
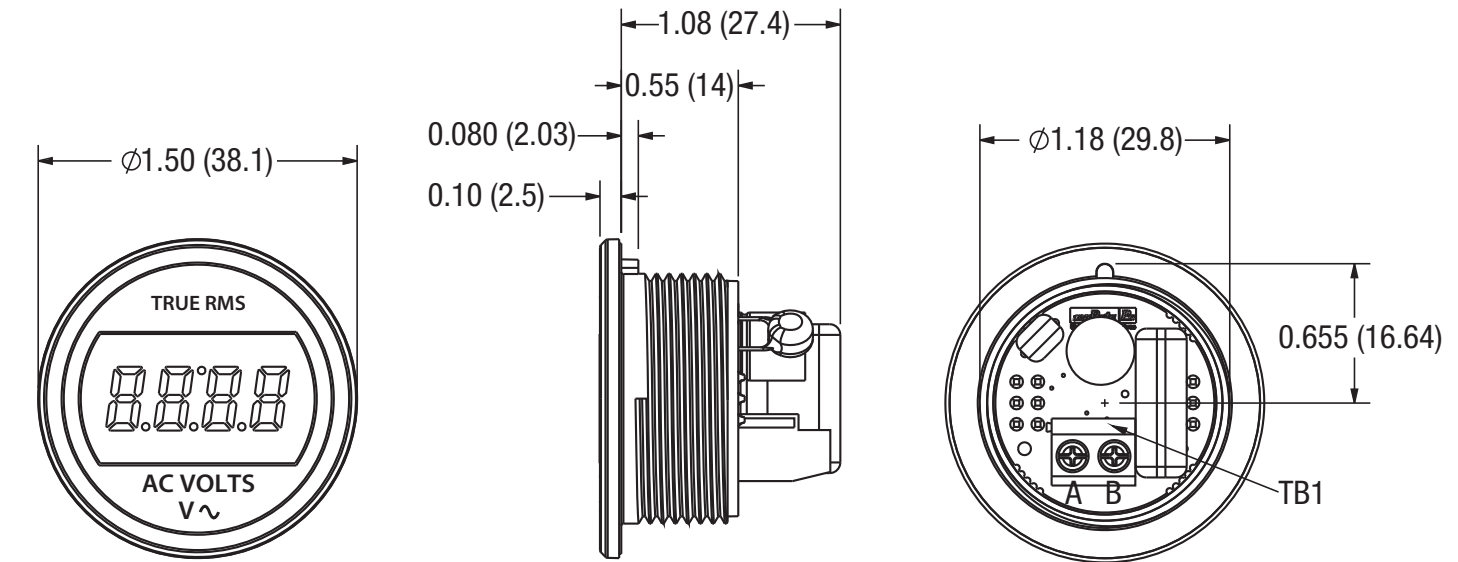

Figure 1. Panel Installation

MECHANICAL SPECIFICATIONS



Dimensions are in inches (mm).

Tolerances (unless otherwise specified):

.XX ± 0.02 (0.51)

.XXX ± 0.010 (0.254)

Angles ± 2°

Components are shown for reference only.

3D models are available at www.murata-ps.com/en/3d/meters.html

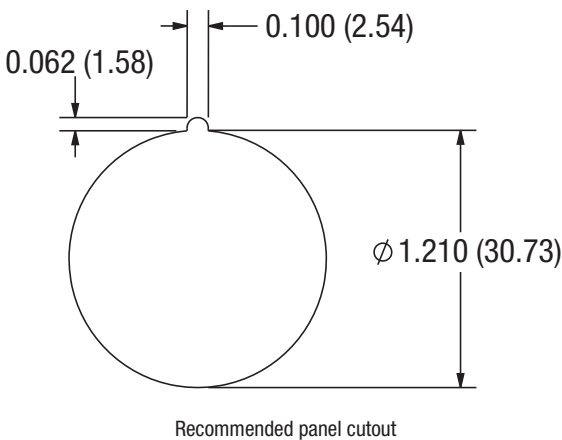

OSCILLOGRAMS

The graphs below show typical DMR20-1-ACV readings when the unit is powered from six common ac-voltage waveforms.

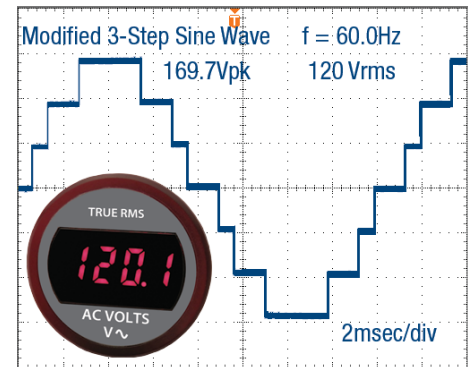
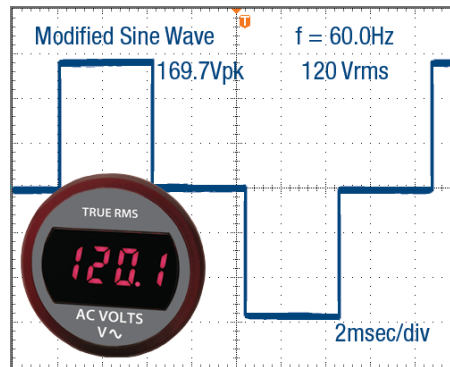
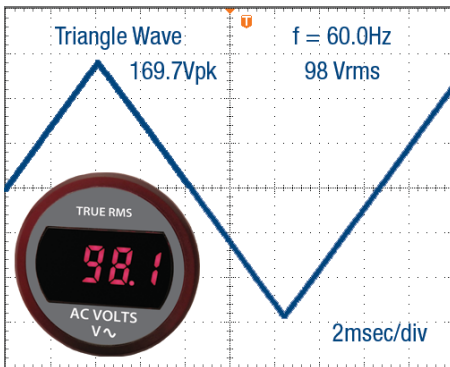
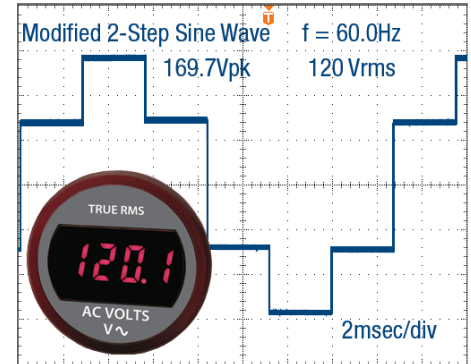
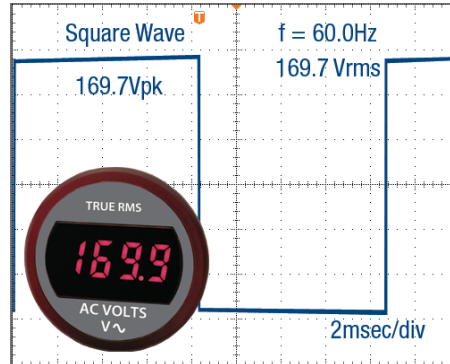
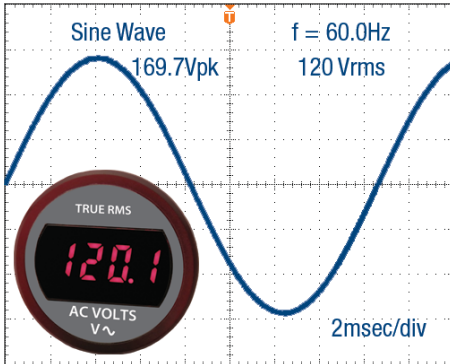

X-ON Electronics

Largest Supplier of Electrical and Electronic Components

Click to view similar products for [Digital Panel Meters](#) category:

Click to view products by [Murata](#) manufacturer:

Other Similar products are found below :

[M00558-00](#) [70.360.4828.0](#) [72331-00](#) [85310-25](#) [86642-00](#) [87268-13](#) [87316-00](#) [87719-26](#) [98107-56](#) [HB8260-R36-90](#) [DMS-20ACV-3-R-C](#)
[EM11DINAV81XR1X](#) [25.325.3253.1](#) [25.325.4253.1](#) [25.330.0453.1](#) [20046-20](#) [20182-23](#) [AP1021](#) [25.320.5053.0](#) [25.350.3453.1](#)
[25.394.3653.1](#) [25.521.3253.0](#) [28006-01](#) [04.630.1080.0](#) [20078-20](#) [EM11DINAV81XO1X](#) [85874-26](#) [87166-00](#) [87895-00](#) [28000-03](#) [K3GN-](#)
[NDT1-FLK 24VDC](#) [82322K-11](#) [86641-00](#) [87004-00](#) [HB8280R2490](#) [HB8260R4890](#) [SCE016MD3MV0W10](#) [20125-21](#) [86640-00](#) [PG-100-](#)
[103GP](#) [PG-100-102RP](#) [PG-100B-102R-H](#) [PG-100B-103R](#) [PG-100B-102R](#) [PG-100N-103R-W](#) [PG-100N-103R](#) [PG-100N-102R](#) [PG-100-](#)
[102GH](#) [PG-100-103RP](#) [PG-100B-103R-M](#)