



PRODUCT OVERVIEW

DMS01-AM-RS12-C is a robust, highly configurable, digital panel meter that provides precise measurement and display of DC current and supports a wide range of external shunts. DIP switches simplify selection and setup of shunt current / voltage input ranges and features a highly visible red 1" (25mm) tall, 3½ – 4½ digit seven-segment LED display with adjustable brightness. Independent offset and scale adjustment trim-potentiometers optimize precision for specialized applications and the internal digital filter enhances performance in electrically noisy environments. An external 12VDC power source provides power to the meter. An internal DC-DC converter accommodates a ±48V common-mode measurement range with respect to the power supply input and supports both high or low side measurement, simplifying a wide range of measurement applications. This digital panel meter ideal for laboratory instrumentation, factory automation, and any application that requiring precise current monitoring.

Features

- Measures ranges of 1A to 1200A
- 0.2% typical accuracy
- Supports user selectable 50 or 100 mV external shunts
- Bright 1" red LED display, readable at distance of 80 feet (~24 m)
- Adjustable display brightness
- Wide common-mode input range (±48V)
- Digital filter for optimizing measurements in electrically noisy environments
- Operates from an external 12VDC power supply
- Mounts with adhesive strips (supplied) or screws
- Two-year warranty

ORDERING INFORMATION

DMS01-AM-RS12-C	Digital DC Shunt Ammeter, 1" Red Display, 12VDC Power
-----------------	---

ACCESSORIES

Shunts		
Murata Model #	Full-scale Amps / Output Voltage	Resistance (mΩs at 25°C)
3020-01097-0	5A / 50mV	10.0000
3020-01107-0	10A / 100mV	10.0000
3020-01098-0	20A / 50mV	2.5000
3020-01096-0	50A / 50mV	1.0000
3020-01099-0	100A / 50mV	0.5000
3020-01108-0	100A / 100mV	1.0000
3020-01100-0	150A / 50mV	0.3300
3020-01101-0	200A / 50mV	0.2500
3020-01102-0	300A / 50mV	0.1670
3020-01103-0	500A / 50mV	0.1000
3020-01104-0	800A / 50mV	0.0625
3020-01105-0	1000A / 50mV	0.0500
3020-01106-0	1200A / 50mV	0.0417

SIMPLIFIED BLOCK DIAGRAM

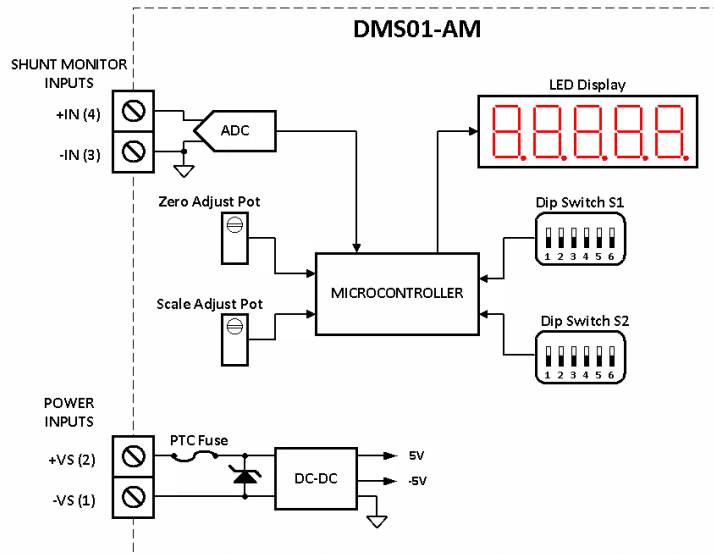

For full details go to
www.murata-ps.com/rohs

DC ELECTRICAL CHARACTERISTICS (Typical @ 25C, +12VDC supply unless otherwise noted)

Parameter	Min	Typ	Max	Units
Supply Voltage (Operating)	11	12	13	V
Absolute Maximum Supply Voltage	-1		+14	V
Supply Current ¹ (Operating at maximum intensity)			100	mA
(Operating at minimum intensity)			60	mA
Digits	3.5 – 4.5 Dependent upon on shunt resistor settings			
Digit Height	1 (25.4)			inch (mm)
Display Update Rate	2			Sa/s
Decimal Selection	auto			
Display Color	Red (627nm pk)			
Over-range indication	Flashing display			
Measurement range (50mV range)	-50		+50	mV
(100mV range)	-100		+100	mV
Accuracy		0.2%	1%	
Zero-Offset (50mV range)	-2		+2	count
(100mV range)	-2		+2	count
Current Range Options	See current range selection table			
Input Impedance		5G		Ω
Offset Trim Range		±1.5		% full-scale
Scale Trim Range		±1		%
Temperature Drift (0 to +50°C)		±0.08		count/°C
Absolute Maximum Input Voltage (+VIN to -VIN)	-16		+16	V
Common-Mode Input Range (-VIN) to (-VS)	-48		+48	V

¹ based on a display value of "1.888"

PHYSICAL/ENVIRONMENTAL

Parameter	Min	Typ	Max	Units
Operating Temperature	0		+50	C
Storage Temperature	-40		+75	C
Humidity (Non-condensing)			85	%RH
Weight		6.14 (174)		oz (g)
User Controls				
Brightness	single-turn potentiometer			
Offset and Gain Adjustment	QTY 2 12-turn trim potentiometers			
Dipswitches (QTY 2), configuration of:				
- Input voltage range	"S1" and "S2" 6-position each			
- Digital filter enable				
- Current range				
- Scale and offset trim enable				
Overall Dimensions	5.86 (149) L x 3.36 (86) W x 1.43 (37) H			inch (mm)
Terminal Blocks	Min	Typ	Max	Units
Wire Size	24		14	AWG
Insulation Strip Length		0.25 (6)		inch (mm)
Screw Tightening torque		56.6 (0.4)		oz-in (N-m)

OPERATION

Measurement Type and Capabilities

- The DMS01-AM measures DC current using an external shunt resistor with two user-selectable input ranges of $\pm 50\text{mV}$ and $\pm 100\text{mV}$.
- Measurements are displayed between 3-1/2 and 4-1/2 digits of resolution depending on the current range selected.
- 21 current range options can be selected based on dipswitch settings.
- The meter's measurement terminals are electrically isolated from the power terminals through a DC-DC converter, providing a high common-mode input range ($\pm 48\text{V}$) for the input (relative to the power terminals), simplifying a wide range of measurement applications.
- Meter requires an external 12VDC power supply (not included).

REAR PANEL LAYOUT, SCREW TERMINAL CONNECTIONS & CONTROLS

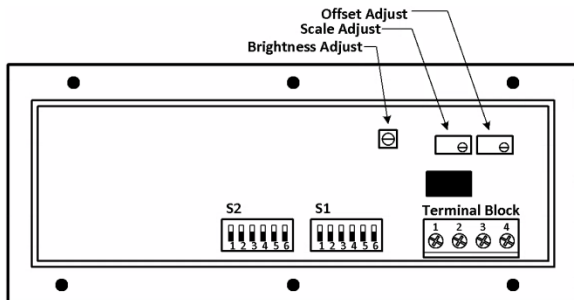

Terminal Block		
Terminal #	Name	Function
1	-VS	Power Supply Terminals (+12VDC)
2	+VS	
3	-IN	Measurement Input Terminals (Shunt Connections)
4	+IN	

Brightness Adjust – This single-turn potentiometer supports adjustment of the meter's LED display brightness for maximum readability. Turning the pot clockwise increases brightness, while turning it counterclockwise decreases brightness.

Offset Adjust – This 12-turn potentiometer supports the adjustment of meter offset. In the vast majority of applications, this function is not needed as the meter's offset is precisely adjusted to zero at factory calibration. Turning the pot clockwise will give a negative offset, while turning it counterclockwise gives a positive offset.

Scale Adjust – This 12-turn potentiometer supports the adjustment of the meter's scale. In the vast majority of applications, this function is not needed as the meter's scale is precisely adjusted at factory calibration. Turning the pot clockwise decreases the gain, while turning it counterclockwise increases the gain.

S1, S2 – These two 6-position dipswitches are used to configure the meter's various options. Details may be found in the [Meter Configuration](#) section of this datasheet.

CONNECTION EXAMPLES

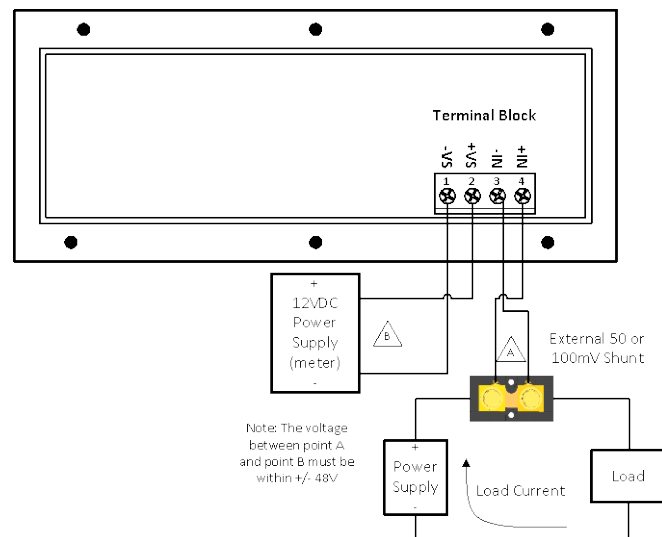
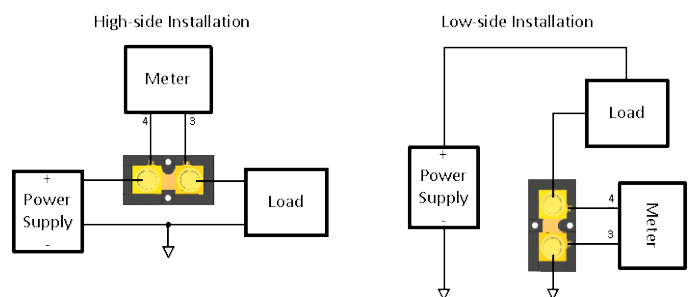

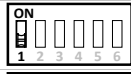
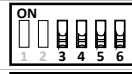



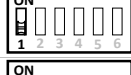









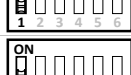





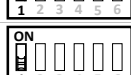



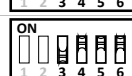

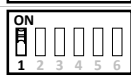
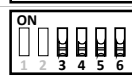
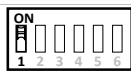
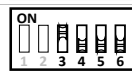

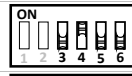
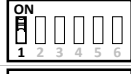



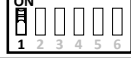

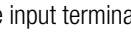

Figure 1 & 2



The above example illustrates an application where the total load current of the system needs to be measured. Therefore, the shunt is connected in series with the system load, at the same time, the shunt measurement points connected to terminals 3 & 4, as shown. The potential difference (VDC) across these points is converted and displayed as DC current, and indicates total system load. This is a high-side installation. See [Figure 1 & 2](#) above for an example of low-side installation.

METER CONFIGURATION

Input Range Selection

Current Range	S1					DIPSWITCH		Description
	SW1	SW3	SW4	SW5	SW6	S2	S1	
Shunt Input Voltage	OFF	OFF	OFF	OFF	OFF			<p>Current Ranges: The ammeter uses 5 switches (SW3 - SW6 on S1 and SW1 on S2) to control the different current range options as shown. If all switches are set to off or if switches are set beyond the 1200A range the meter will display the voltage across the shunt.</p>
±1.000	OFF	ON	OFF	OFF	OFF			
±2.000	OFF	OFF	ON	OFF	OFF			
±5.000	OFF	ON	ON	OFF	OFF			
±10.00	OFF	OFF	OFF	ON	OFF			
±15.00	OFF	ON	OFF	ON	OFF			
±20.00	OFF	OFF	ON	ON	OFF			
±30.00	OFF	ON	ON	ON	OFF			
±50.00	OFF	OFF	OFF	OFF	ON			
±75.00	OFF	ON	OFF	OFF	ON			
±80.00	OFF	OFF	ON	OFF	ON			
±100.0	OFF	ON	ON	OFF	ON			
±150.0	OFF	OFF	OFF	ON	ON			
±200.0	OFF	ON	OFF	ON	ON			
±250.0	OFF	OFF	ON	ON	ON			
±300.0	OFF	ON	ON	ON	ON			
±400.0	ON	OFF	OFF	OFF	OFF			
±500.0	ON	ON	OFF	OFF	OFF			
±600.0	ON	OFF	ON	OFF	OFF			
±800.0	ON	ON	ON	OFF	OFF			
±1000	ON	OFF	OFF	ON	OFF			
±1200	ON	ON	OFF	ON	OFF			
Shunt Input Voltage	All other positions will show the voltage at the input terminals.							

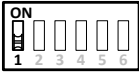
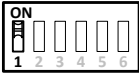
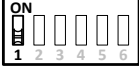
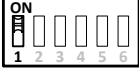
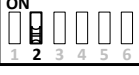
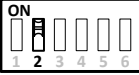
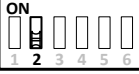
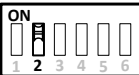
METER CONFIGURATION			
Current Range Selection			
Input Range	SW1	Dipswitch S1	Description
±50mV	OFF		SW1 on S1 controls the meter's input range. In the OFF position the input range is ±50mV, while in the ON position the meter's range is ±100mV.
±100mV	ON		
Current Range Selection			
Input Range	SW1	Dipswitch S1	Description
±50mV	OFF		SW1 on S1 controls the meter's input range. In the OFF position the input range is ±50mV, while in the ON position the meter's range is ±100mV.
±100mV	ON		
Digital Filter On/Off Selection			
Digital Filter	SW2	Dipswitch S1	Description
OFF	OFF		SW2 on S1 controls the meter's digital filter. In the OFF position, the filter is disabled and readings are updated at maximum speed. In the ON position, the filter is enabled, and readings are processed through a moving average filter, which results in more stable readings, but a slower response.
ON	ON		
Scale and Offset Trim Adjust Enable On/Off			
Trim Enable	SW2	Dipswitch S2	Description
OFF	OFF		The DMS01 ammeter provides two potentiometers for adjustment of the measurement scale and offset controls which can be enabled by SW2 on S2. When the switch is set to the OFF position the trim is disabled. When the switch is set to the ON position the trim is enabled.
ON	ON		

TECHNICAL NOTES



1. Calibration

The DMS01-AM is calibrated at the factory at the time of manufacture. When the Trim Enable switch (SW2 on S2) is turned off, the unit ignores the scale and offset potentiometer settings and reverts to factory calibration. When the Trim Enable switch is turned ON, the unit's effective calibration may be changed by the user and may no longer be within datasheet specifications.

2. Protection and Fusing

The DMS01-AM contains an internal PTC fuse as well as other protective elements that are intended for protection against brief electrical transients and misconnect conditions. Additional external protective components such as fuses and transient suppressors may be required depending on the application in which the meter is deployed.

3. Noisy Power Supplies

In systems with noisy power supplies, connecting an external, non-polarized capacitor across the +VS and -VS inputs can help reduce measurement errors. In certain situations, the use of twisted pair or shield wiring may be required.

4. Installation

IMPORTANT! To ensure safe and reliable operation, DMS01 meters must be installed and serviced by qualified technical personnel. Contact Murata Power Solutions if there is any doubt regarding their installation or operation.

5. Over-range Limit

The meter will flash on and off when the input of the meter exceeds its minimum or maximum input voltage/current.

PANEL INSTALLATION

PANEL CUTOUT

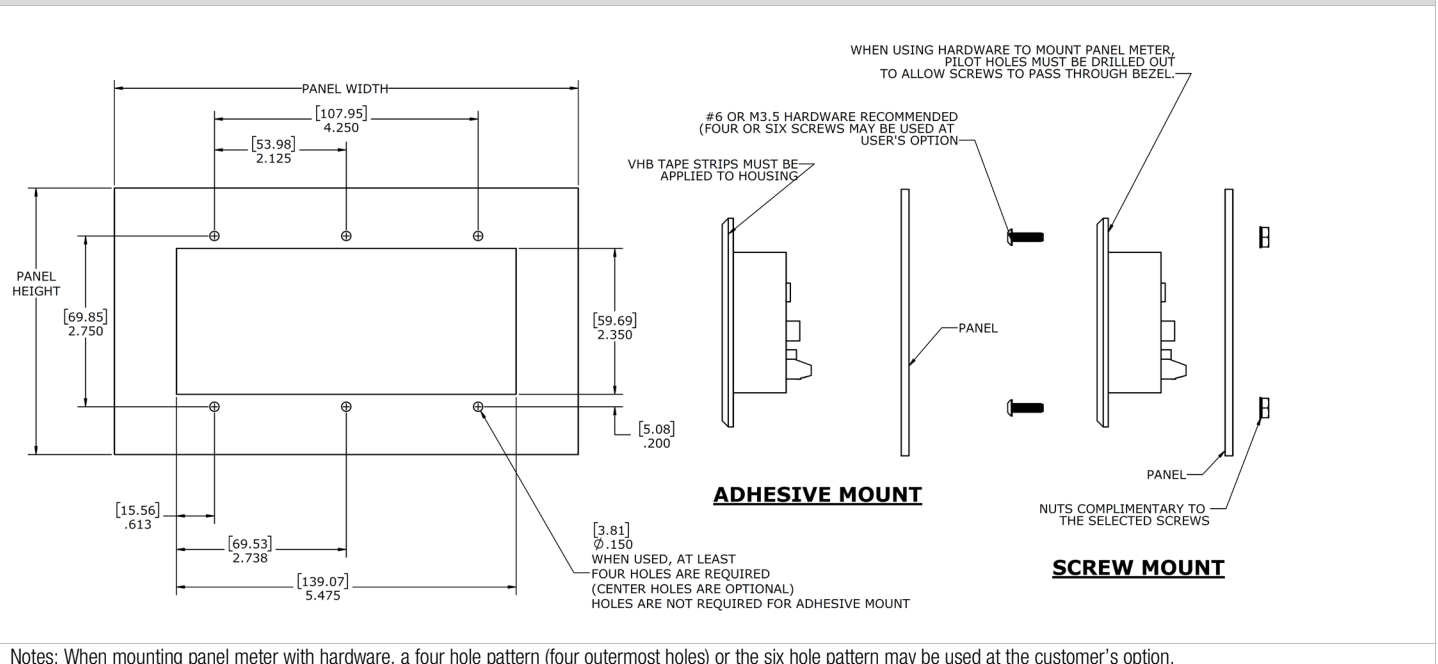

Notes: When mounting panel meter with hardware, a four hole pattern (four outermost holes) or the six hole pattern may be used at the customer's option.

MECHANICAL SPECIFICATIONS

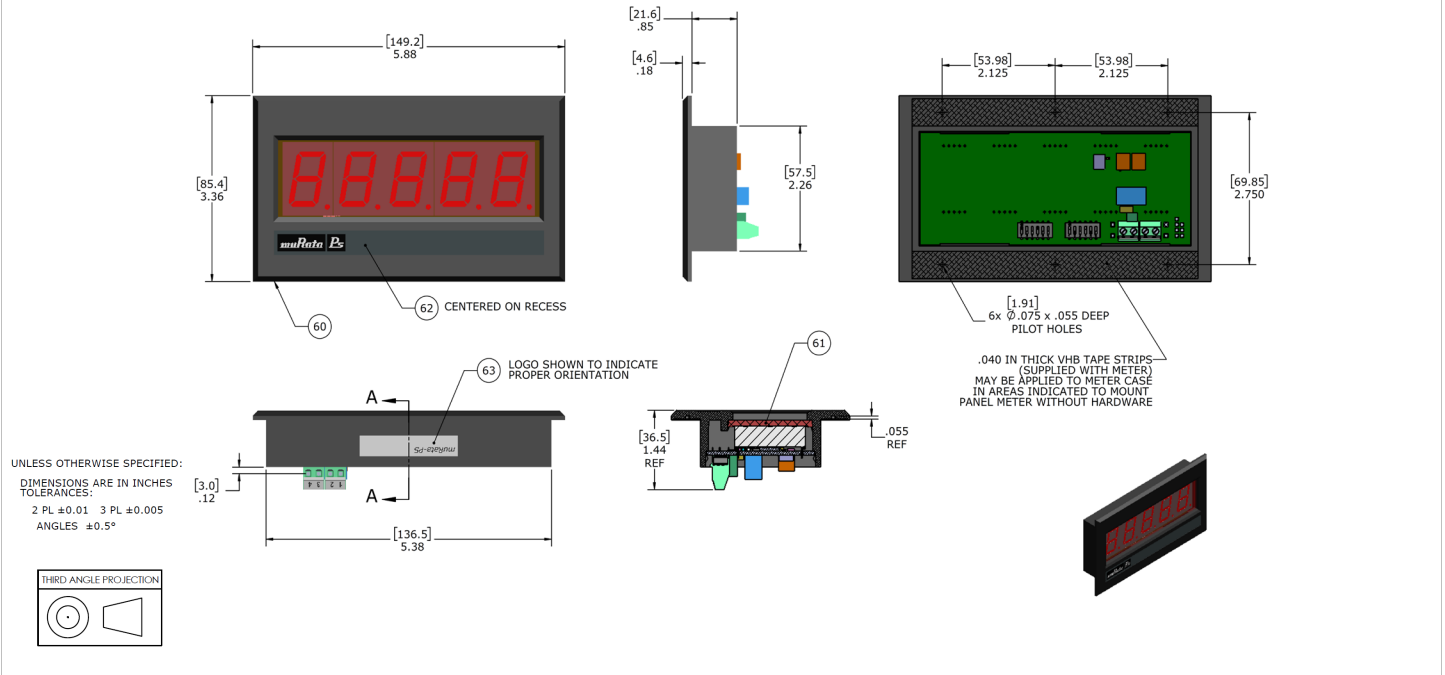

APPLICATION NOTES

Document Number	Description	URL Link to Document
DMS-AN25	Application Note: DMS01 Meter Measurement and Calibration	Click to open application note

Murata Power Solutions, Inc.
129 Flanders Rd. Westborough, Ma 01581, USA.
ISO 9001 and 14001 REGISTERED



This product is subject to the following operating requirements and the Life and Safety Critical Application Sales Policy:
Refer to: <https://www.murata-ps.com/requirements/>

Murata Power Solutions, Inc. makes no representation that the use of its products in the circuits described herein, or the use of other technical information contained herein, will not infringe upon existing or future patent rights. The descriptions contained herein do not imply the granting of licenses to make, use, or sell equipment constructed in accordance therewith. Specifications are subject to change without notice.
©2020 Murata Power Solutions, Inc..

X-ON Electronics

Largest Supplier of Electrical and Electronic Components

Click to view similar products for [Digital Panel Meters](#) category:

Click to view products by [Murata](#) manufacturer:

Other Similar products are found below :

[M00558-00](#) [70.360.4828.0](#) [72331-00](#) [85310-25](#) [86642-00](#) [87268-13](#) [87316-00](#) [87719-26](#) [98107-56](#) [HB8260-R36-90](#) [DMS-20ACV-3-R-C](#)
[EM11DINAV81XR1X](#) [25.325.3253.1](#) [25.325.4253.1](#) [25.330.0453.1](#) [20046-20](#) [20182-23](#) [AP1021](#) [25.320.5053.0](#) [25.350.3453.1](#)
[25.394.3653.1](#) [25.521.3253.0](#) [28006-01](#) [04.630.1080.0](#) [20078-20](#) [EM11DINAV81XO1X](#) [85874-26](#) [87166-00](#) [87895-00](#) [28000-03](#) [K3GN-](#)
[NDT1-FLK 24VDC](#) [82322K-11](#) [86641-00](#) [87004-00](#) [HB8280R2490](#) [HB8260R4890](#) [SCE016MD3MV0W10](#) [20125-21](#) [86640-00](#) [PG-100-](#)
[103GP](#) [PG-100-102RP](#) [PG-100B-102R-H](#) [PG-100B-103R](#) [PG-100B-102R](#) [PG-100N-103R-W](#) [PG-100N-103R](#) [PG-100N-102R](#) [PG-100-](#)
[102GH](#) [PG-100-103RP](#) [PG-100B-103R-M](#)