



Typical unit

Output (V)	Current (A)	Nominal Input (V)
11.4	53	50

PRODUCT OVERVIEW

The DRE-11.4/53-L48NB-C regulated DC-DC converter module is designed to perform as an Intermediate Bus Converter delivering 11.4Vdc @ 53A (600W) in an standard 5pin DOSA compliant eighth brick package.

The DRE module operates over a V_{in} range of 36-60Vdc delivering full power @ 55°C with 300LFM air flow.

Applications include (but are not limited to) Telecommunications infrastructure equipment, Network security, Wireless base stations, routers, computing equipment and other applications requiring a highly efficient, 600W intermediate bus converter that will support a V_{in} range of 36-60Vdc. Designed & tested to meet the rigorous requirements of the IPC9592, Rev B standard.

FEATURES

- Designed for Regulated Intermediate Bus Architectures (RIBA).
- Industry standard 5pin eighth brick package.
- 95.5% high efficiency at full load On/Off control.
- 36-60Vdc input voltage range (50V nominal).
- Monotonic startup into pre-biased output conditions.
- Stable No Load operation.
- Output Over-current & Over-temperature protection.
- Input Under Voltage Lock Out.
- Negative Logic Standard configuration (Positive logic optional).
- 2250Vdc Input to output isolation, functional insulation.
- RoHS compliant.
- Certification to UL/EN/IEC 60950
- Designed & tested to meet the requirements of IPC9592, Rev B.

Features include input Under Voltage Lock Out (UVLO), Over Temperature Protection shutdown (OTP), Over Current/Current Limit Protection (OCP), Output Over Voltage Protection (OVP), Galvanic (2250Vdc) Input to Output Isolation and functional insulation, along with UL 60950 safety certification and CB report (available upon request).

General PCB Layout

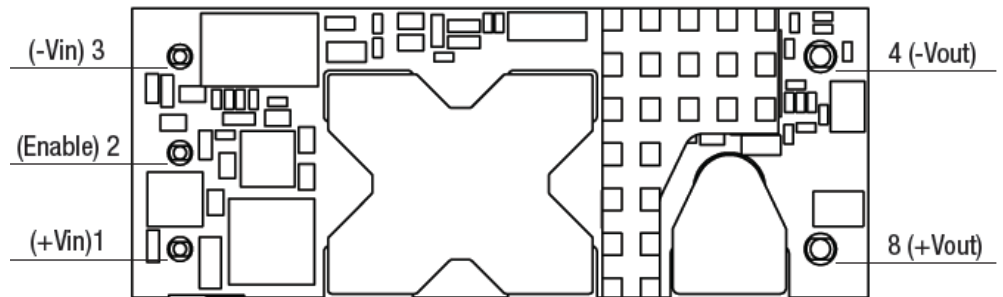

Figure 1. Bottom View (Pin Side View)



For full details go to
www.murata-ps.com/rohs

PERFORMANCE SPECIFICATIONS SUMMARY AND ORDERING GUIDE

Model Family	Output					Input				Efficiency		Dimensions	
	Vout [1] (V)	Iout (A)	Power [2] (W)	Ripple & Noise (mVp-p)		Regulation (max.) Line	VIN Nom. (V)	Range (V)	Iin, no load (mA)	Iin, full load (A)	Min.		Typ.
				Typ.	Max.						94.5%	95.5%	
DRE-11.4/53-L48	11.4	53	604	100	150	±0.4%	50	36-60	150	12.2	94.5%	95.5%	See Mechanical Specifications

Notes:

[1] Output voltage @ 0% load.

[2] Output power @ 100% load.

[3] Please refer to the model number structure for additional ordering part numbers and options.

[4] All specifications are typical unless noted. General conditions for Specifications are +25°C, Vin=nominal, Vout = nominal (no trim installed), full rated load. Adequate airflow must be supplied for extended testing under power.

All models are tested and specified with an external 1µF, and 10 µF paralleled output capacitors and a 220µF external input capacitor. All capacitors are low ESR types. Caps are layout dependent. These capacitors are necessary to accommodate our test equipment and may not be required in your applications. All models are stable and regulate within spec under no-load conditions.

PART NUMBER STRUCTURE

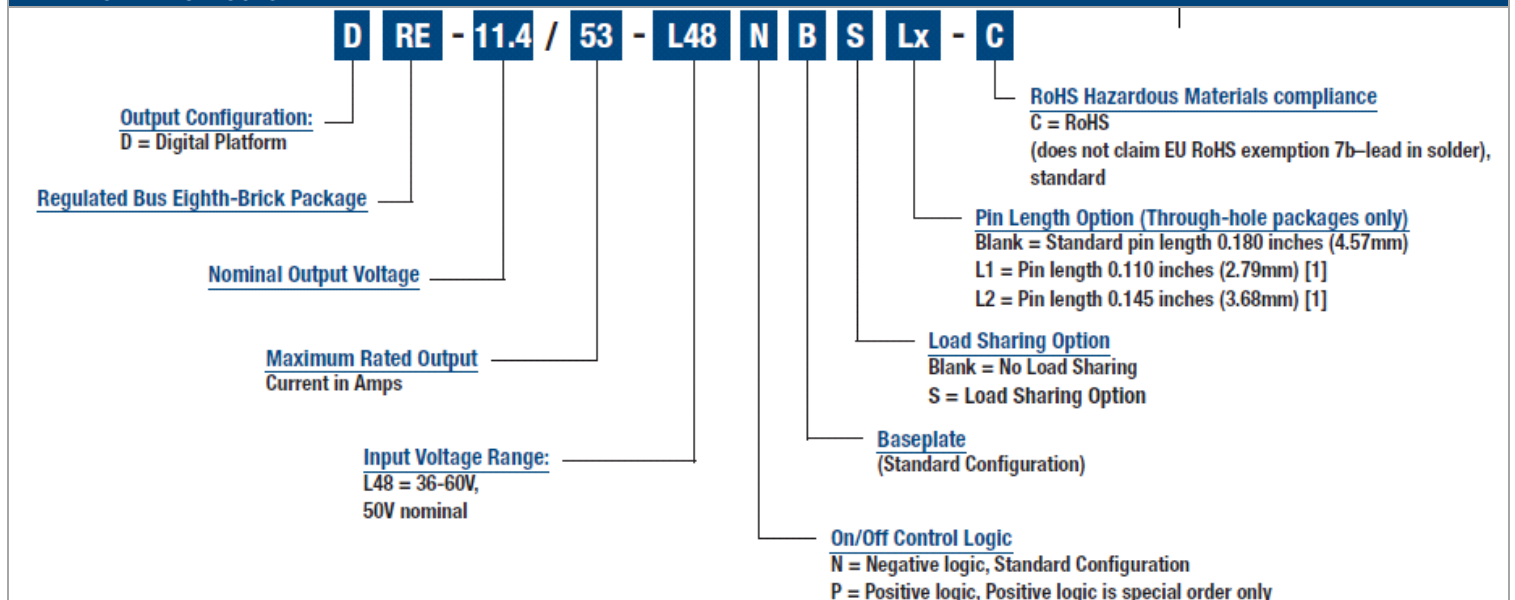

Notes:

[1] Special quantity order is required; samples available with standard pin length only.

[2] Some model number combinations may not be available. See website or contact your local Murata sales representative.

FUNCTIONAL SPECIFICATIONS

ABSOLUTE MAXIMUM RATINGS		Conditions [1]	Minimum	Typical/Nominal	Maximum	Units
Input Voltage, Continuous			36	50	60	Vdc
Isolation Voltage		Input to Output		2250		Vdc
On/Off Remote Control		Power on, referred to -Vin	0		20	Vdc
Output Power			0	604	605	W
Output Current		Current-limited, no damage, short-circuit protected	0	53	53	A
Storage Temperature Range		Vin=Zero (no power)	-40		125	°C
Absolute maximums are stress ratings. Exposure of devices to greater than any of these conditions may adversely affect long-term reliability. Proper operation under conditions other than those listed in the Performance/Functional Specifications Table is not implied or recommended.						
INPUT		Conditions [1]				
Recommended External Fuse		Fast blow			25	A
Internal Filter Type				Pi		
Input Voltage						
Operating Voltage Range			36	50	60	Vdc
Start-up Threshold		Rising input voltage	34	35	36	Vdc
Undervoltage Shutdown		Falling input voltage	32	33	34	Vdc
Overvoltage Shutdown			64	66	68	Vdc
Hysteresis			1			Vdc
Input Current						
Full Load Conditions		Vin=Nominal		12.2	13.2	A
Low Line		Vin=Min.		17	18	A
No Load Current		Iout=Min., unit=ON		150	250	mA
Shut-Down Mode Input Current				20	50	mA
Reflected (back) Ripple Current		Measured at input with specified filter [2]			400	mApp
		Measured at input without filter			1000	mApp
GENERAL and SAFETY						
Efficiency		Vin=Nominal, full load	94.5	95.5		%
		Vin=Max., full load	93.4	94.8		%
Isolation		Input To Output		2250		Vdc
Insulation Safety Rating		Functional				
Safety		Certified to UL-60950-1, CSA-C22.2 No. 60950-1, IEC/EN60950-1, 2nd edition.		Yes		
Calculated MTBF		Telcordia SR-332, issue 3, method 1, case1, ground fixed, Tambient = +25°C		6000		khrs
DYNAMIC CHARACTERISTICS						
Fixed Switching Frequency				220		kHz
Startup Time		Power on to Vout regulated	20	25	30	ms
		Remote ON to Vout regulated		2.5	5	ms
Dynamic Load Response		50-75-50% load step, settling time to within 1% of Vout			500	µsec
Dynamic Load Peak Deviation		with 2000µF output capacitance, 50% ceramic, 50% OSCON or POSCAP			±350	mV
FEATURES and OPTIONS						
Remote On/Off Control [3]						
"N" suffix:						
Negative Logic, ON/OFF State		ON=Ground pin or external voltage	-0.1		0.8	Vdc
		OFF=Pin open or external voltage	2.5		20	Vdc
Control Current		Open collector/drain		0.1	0.2	mA/mA
"P" suffix:						
Positive Logic, ON/OFF State		ON=Pin open or external voltage	3.5		20	
		OFF=Ground pin or external voltage	0		1	
Control Current		Open collector/drain		None		

FUNCTIONAL SPECIFICATIONS (CONT.)

OUTPUT		Minimum	Typical/Nominal	Maximum	Units
Total Output Power		0	604	605	W
Output Voltage					
Nominal Output Voltage(at 50% Load)			11.40		Vdc
Output Voltage @ 0% to 100% Load		11.38	11.40	11.42	Vdc
Over-Voltage Protection	Magnetic feedback	12.54	14.25	15.96	Vdc
Output Voltage (S option-with Droop mode current sharing)					
Nominal Output Voltage		10.73	11.19	11.65	Vdc
Output Voltage @ 0% Load		11.15	11.40	11.65	Vdc
Output Voltage @ 50% Load		10.94	11.19	11.44	Vdc
Output Voltage @ 100% Load		10.73	10.98	11.23	Vdc
Over-Voltage Protection	Magnetic feedback	12.31	13.99	15.66	Vdc
Output Current					
Output Current Range		0	53	53	A
Current Limit Inception	90% of Vout, after warm up	58.30	66.25	74.20	A
Short Circuit					
Short Circuit Duration	Output shorted to ground, no damage		Continuous		
Short Circuit protection method	Current limiting, hiccup mode				
Regulation					
Line Regulation	Vin = Min. to Max., Vout = Nom; Iout = Nom.			±0.4	% of Vout
Ripple and Noise	With 600µF output capacitance, 50% ceramic, 50% OSCON or POSCAP, 20MHz BW		100	150	mVpp
Maximum Capacitive Loading	Typically 50% ceramic, 50% Oscon or POSCAP			3125	µF
MECHANICAL					
Outline Dimensions (Please refer to outline drawing)					
With Baseplate	L x W x H		2.3 x 0.9 x 0.57		Inches
			58.4 x 22.9 x 14.48		mm
Weight			1.41		Ounces
			40		Grams
Through Hole Pin Diameter			0.04 & 0.06		Inches
			1.016 x 1.524		mm
Through Hole Pin Material			Copper alloy		
TH Pin Plating Metal and Thickness	Nickel subplate		50		µ-inches
	Gold overplate		5		µ-inches
ENVIRONMENTAL					
Operating Ambient Temperature Range	With Derating	-40		85	°C
Storage Temperature	Vin=Zero (no power)	-40		125	°C
Thermal Protection/Shutdown	Measured in the center		120		°C

Notes:

- [1] Unless otherwise noted, all specifications are at nominal input voltage, nominal output voltage and full load.
 General conditions are +25 Degree Celsius ambient temperature, near sea level altitude, natural convection airflow. All models are tested and specified with external parallel 1µF and 10 µF multi-layer ceramic output capacitors.
 A 220µF external input capacitor is used. All capacitors are low-ESR types wired close to the converter. These capacitors are necessary for our test equipment and may not be needed in the user's application.
- [2] Measured at the input pin+ of module with a simulated source impedance of 10µH, 220µF, 100V, across source, 500µF, 100V external capacitors across input pins.
- [3] The Remote On/Off Control is referred to -Vin. For external transistor control, use open collector logic or equivalent

PERFORMANCE DATA

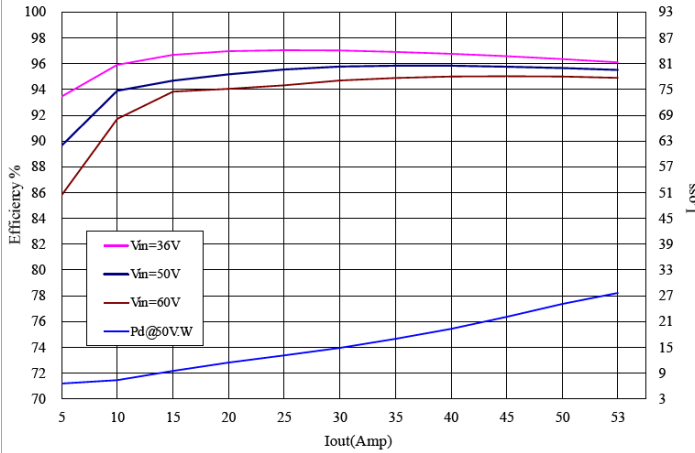

Efficiency vs. Line Voltage and Load Current @ 25°C

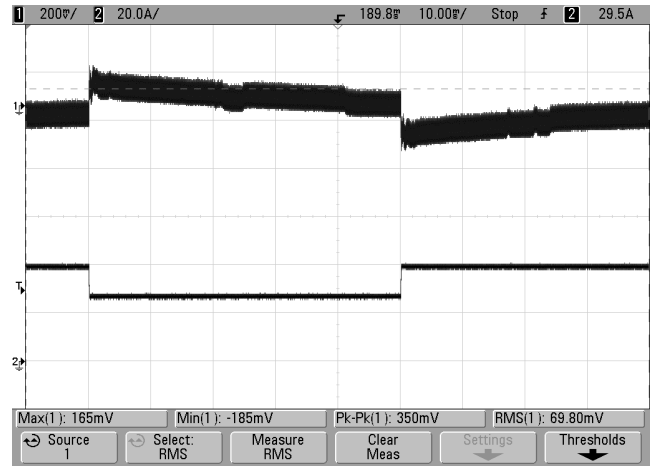

Transient Response @25°C
(V_{in}=50V, V_{out}=nom., I_{out}=50-75% of full load, C_{out}=2000μF, ScopeBW=20MHz, 10ms/div)

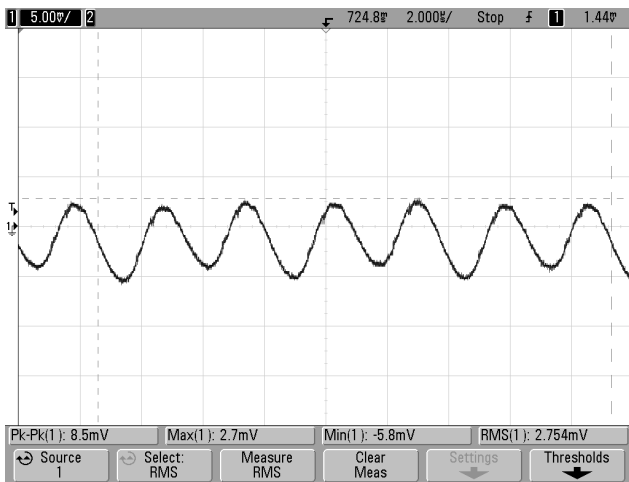

Ripple and Noise @25°C
(V_{in} = 50V, V_{out} = nom., I_{out} = 0A, C_{out} = 400μF, ScopeBW = 20MHz, 2μs/div)

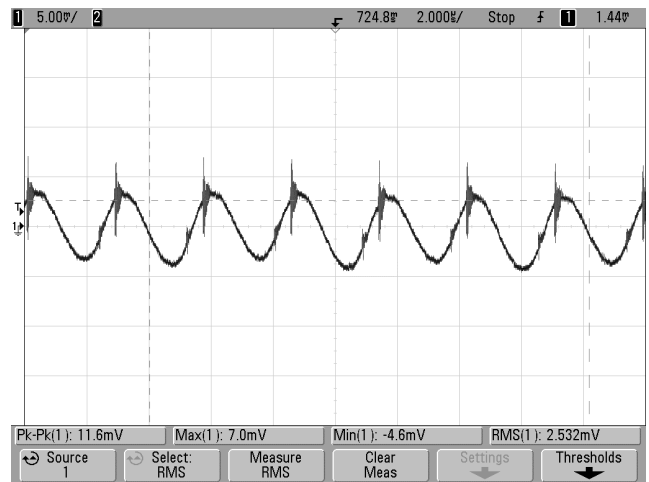

Ripple and Noise @25°C
(V_{in} = 50V, V_{out} = nom., I_{out} = 50A, C_{out} = 400μF, ScopeBW = 20MHz, 2μs/div)



Turn-on transient at full load current
(5ms/div, Top Trace: V_{out}, 5V/div; Bottom Trace: ON/OFF, 2V/div)



Turn-on transient at full load current
(5ms/div, Top Trace: V_{out}, 5V/div; Bottom Trace: V_{in}, 20V/div)

Thermal Derating (DRE-11.4/53-L48, Unit mounted on a 10 X 10 inch PCB)

TRANSVERSE (AIRFLOW FROM Vin- TO Vin+)

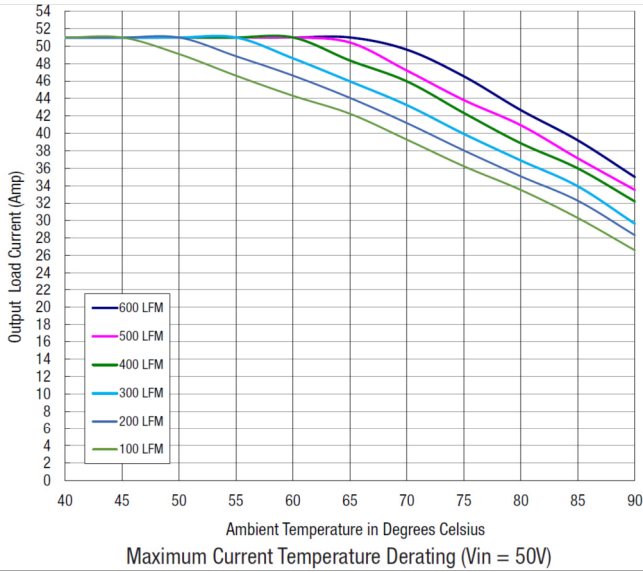

LONGITUDINAL (AIRFLOW FROM Vin TO Vout)

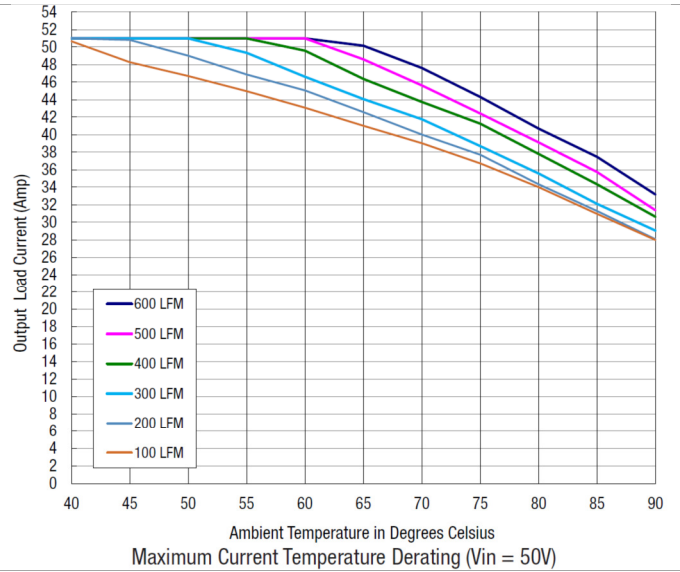

TRANSVERSE AIRFLOW; (Baseplate Variant)

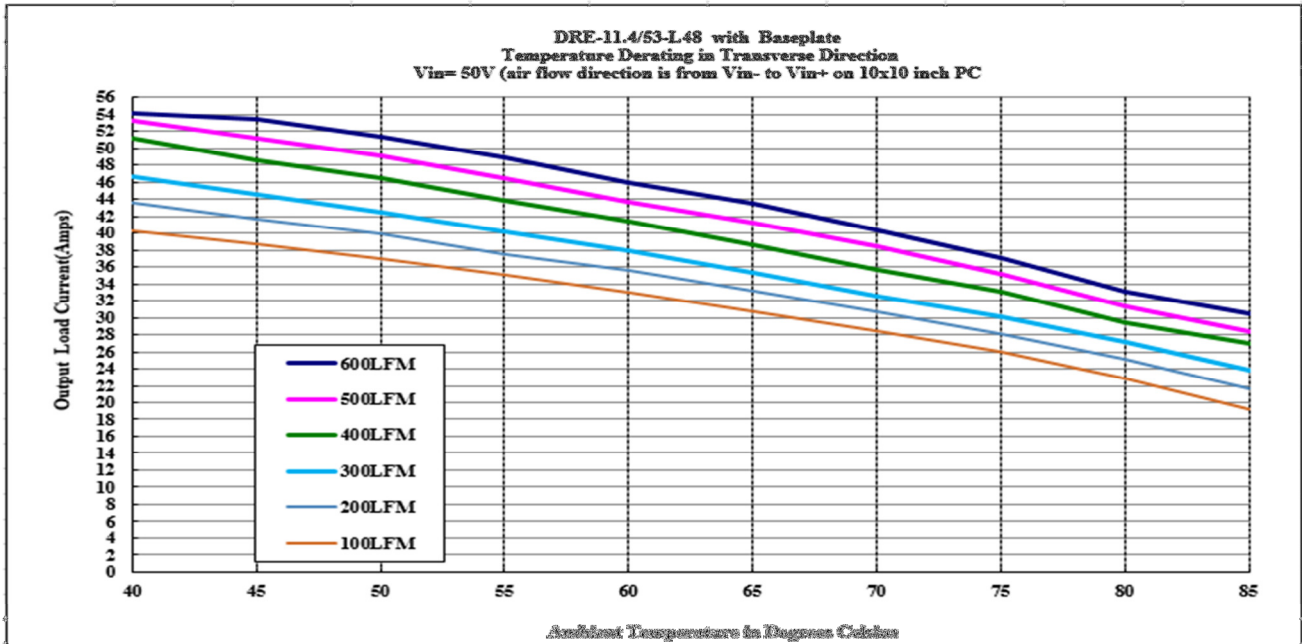

LONGITUDINAL AIRFLOW; (Baseplate Variant)

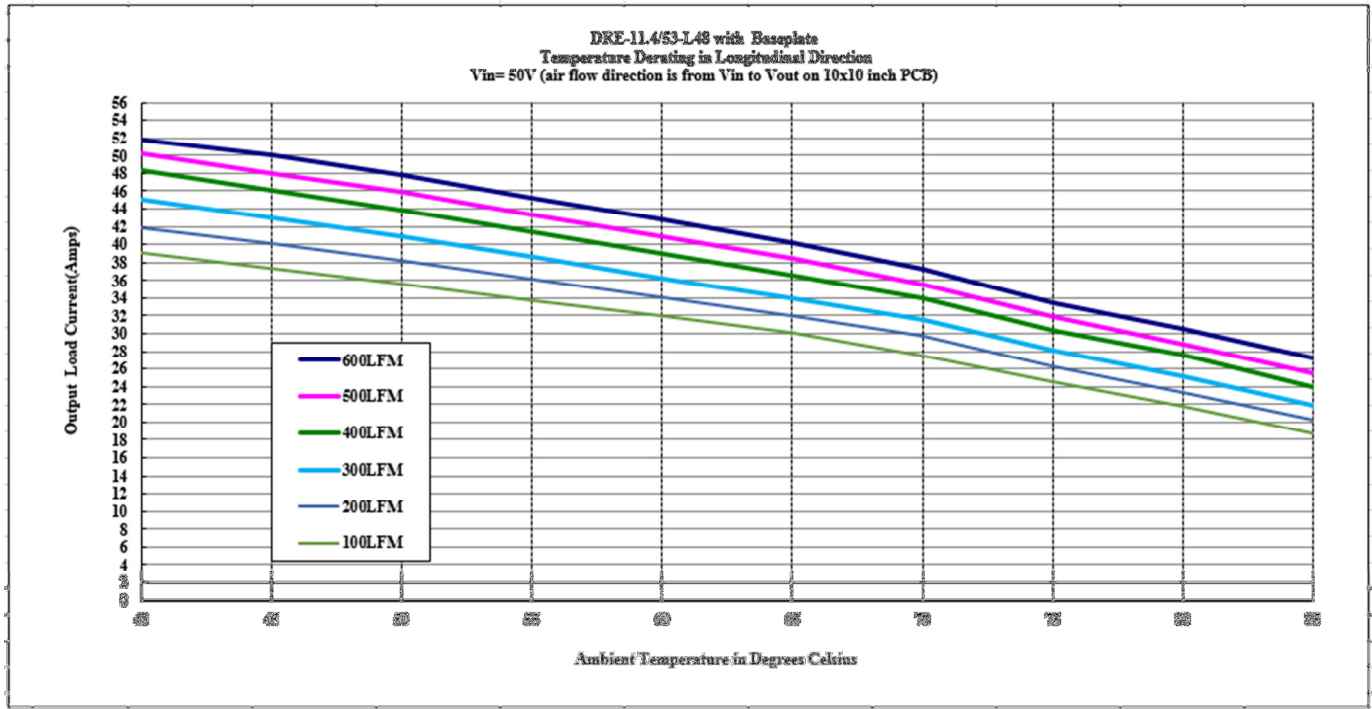

TRANSVERSE AIRFLOW; (Heatsink Variant)

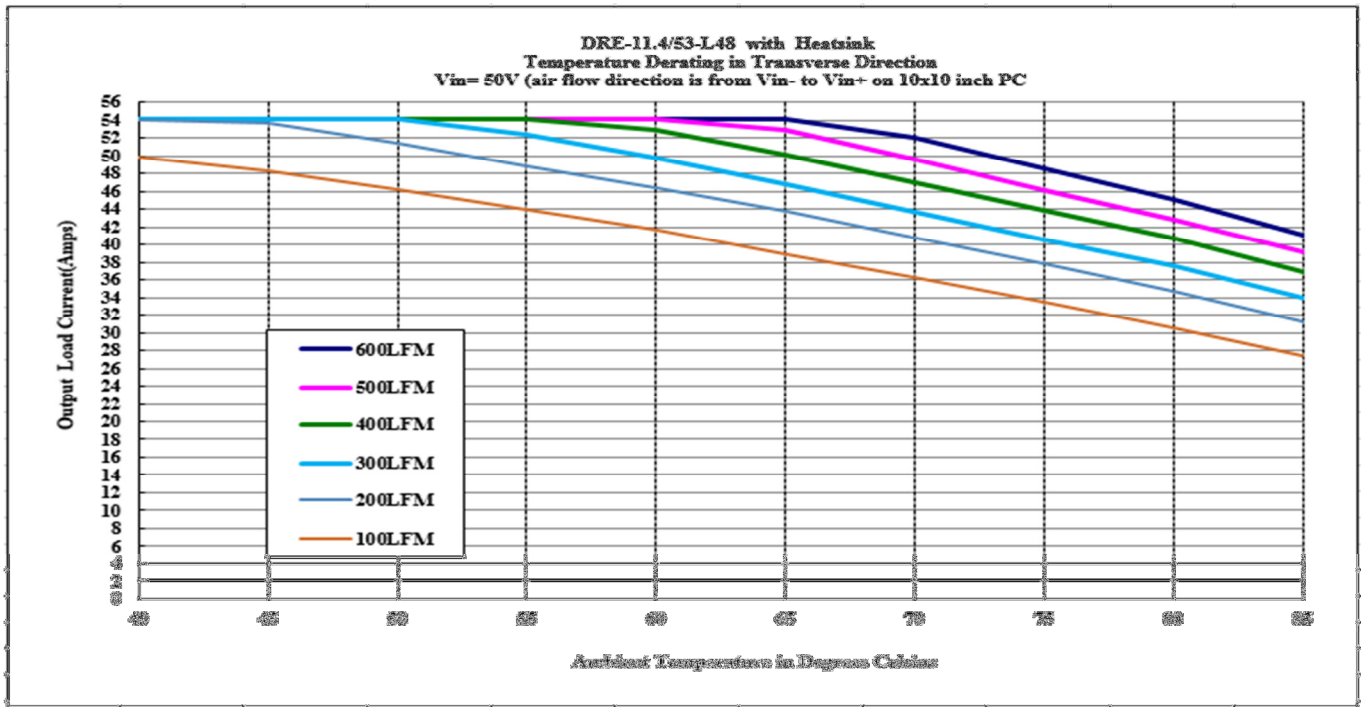

LONGITUDINAL AIRFLOW; (Baseplate Variant)

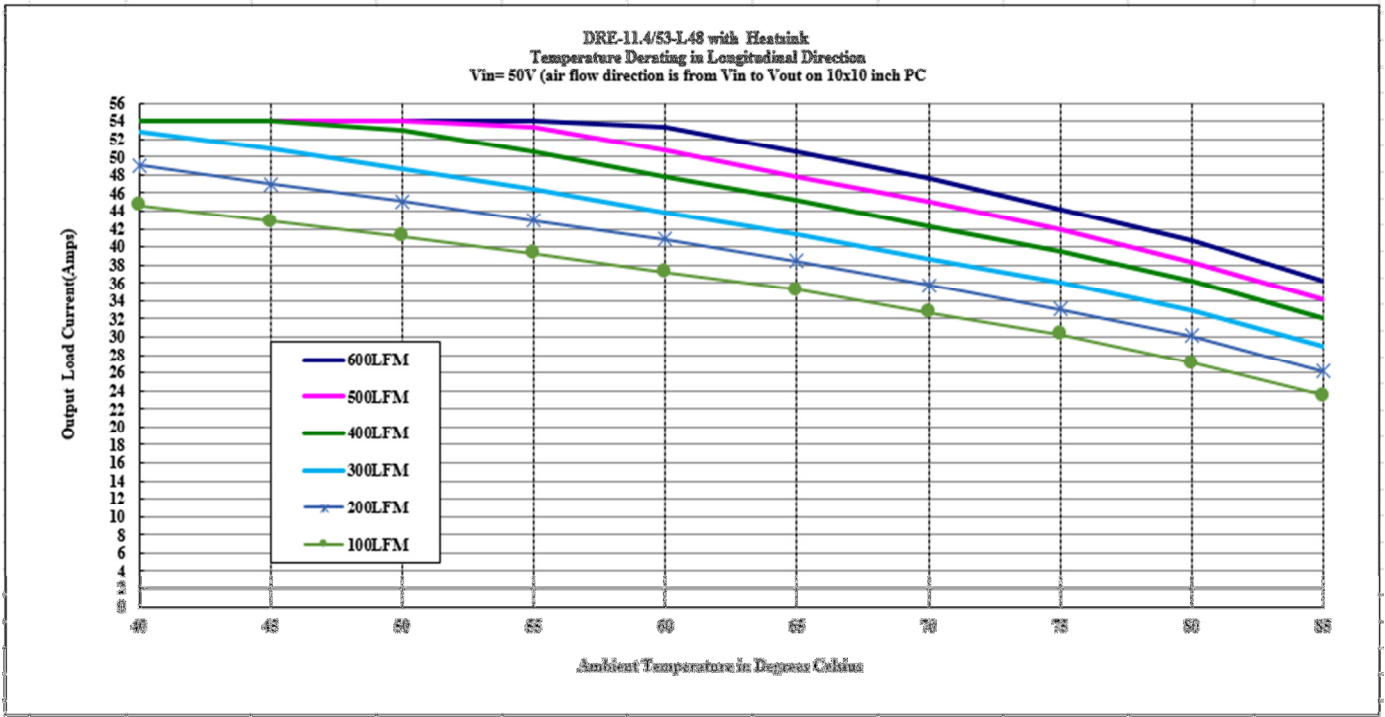

MECHANICAL SPECIFICATIONS

Dimensions are in inches (mm shown for ref. only)

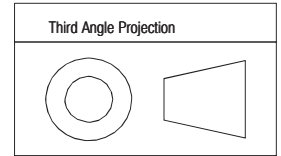
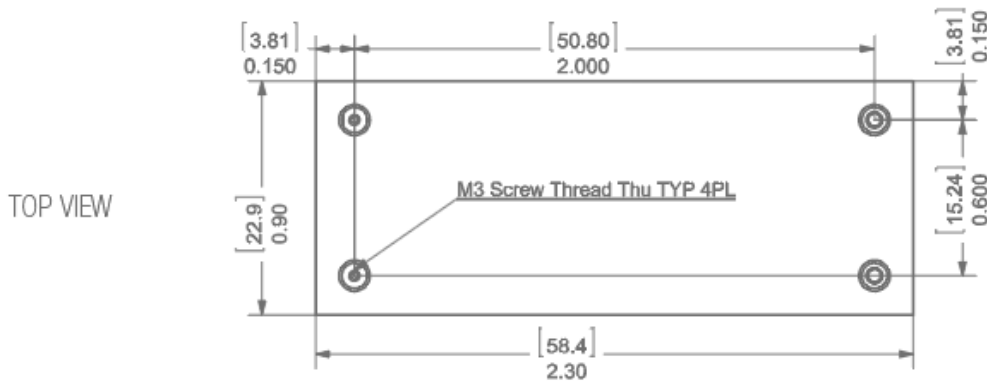

Tolerances (unless otherwise specified):

.XX ± 0.02 (0.5)

.XXX ± 0.010 (0.25) Angles ± 2°

INPUT/OUTPUT CONNECTIONS

Pin	Function
1	Vin(+)
2	On/Off
3	Vin(-)
4	Vout(-)
8	Vout(+)

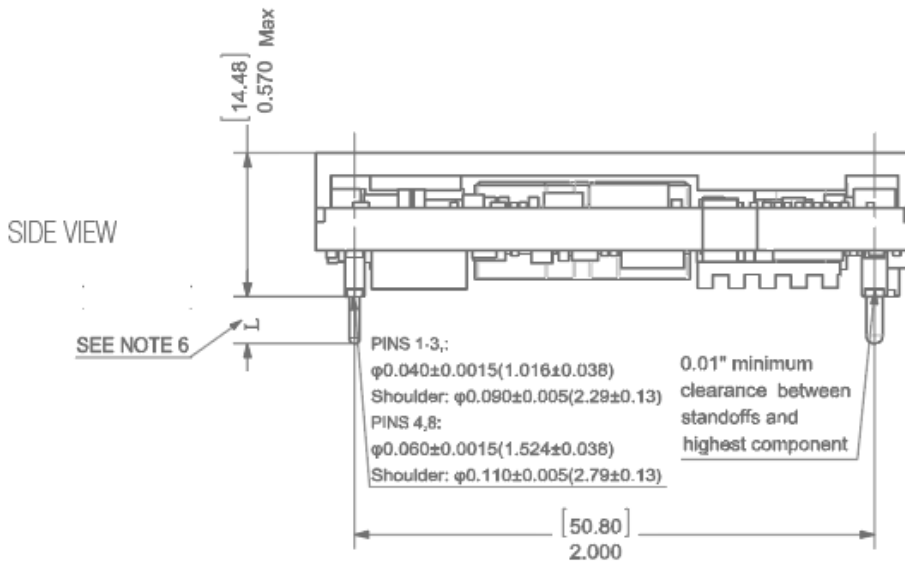

Notes:

UNLESS OTHERWISE SPECIFIED:

- [1] M3 SCREW USED TO BOLT UNIT'S BASEPLATE TO OTHER SURFACES (SUCH AS HEATSINK) MUST NOT EXCEED 0.110" (2.5mm) DEPTH BELOW THE SURFACE OF BASEPLATE
- [2] APPLIED TORQUE PER SCREW SHOULD NOT EXCEED 5.3in-lb (0.6Nm); [3] ALL DIMENSION ARE IN INCHES[MILLIMETER];
- [4] ALL TOLERANCES:
 $x.xx \times in, \pm 0.02in$ ($x.xx \times mm, \pm 0.5mm$)
 $x.x \times in, \pm 0.01in$ ($x.x \times mm, \pm 0.25mm$)
- [5] COMPONENT WILL VARY BETWEEN MODELS [6] STANDARD PIN LENGTH: 0.180 Inch FOR L1 PIN LENGTH OPTION IN MODEL NAME, THE L LENGTH SHOULD BE 0.110 INCH FOR L2 PIN LENGTH OPTION IN MODEL NAME, USE STANDARD L2 PIN WITH PIN LENGTH TO 0.145 Inch

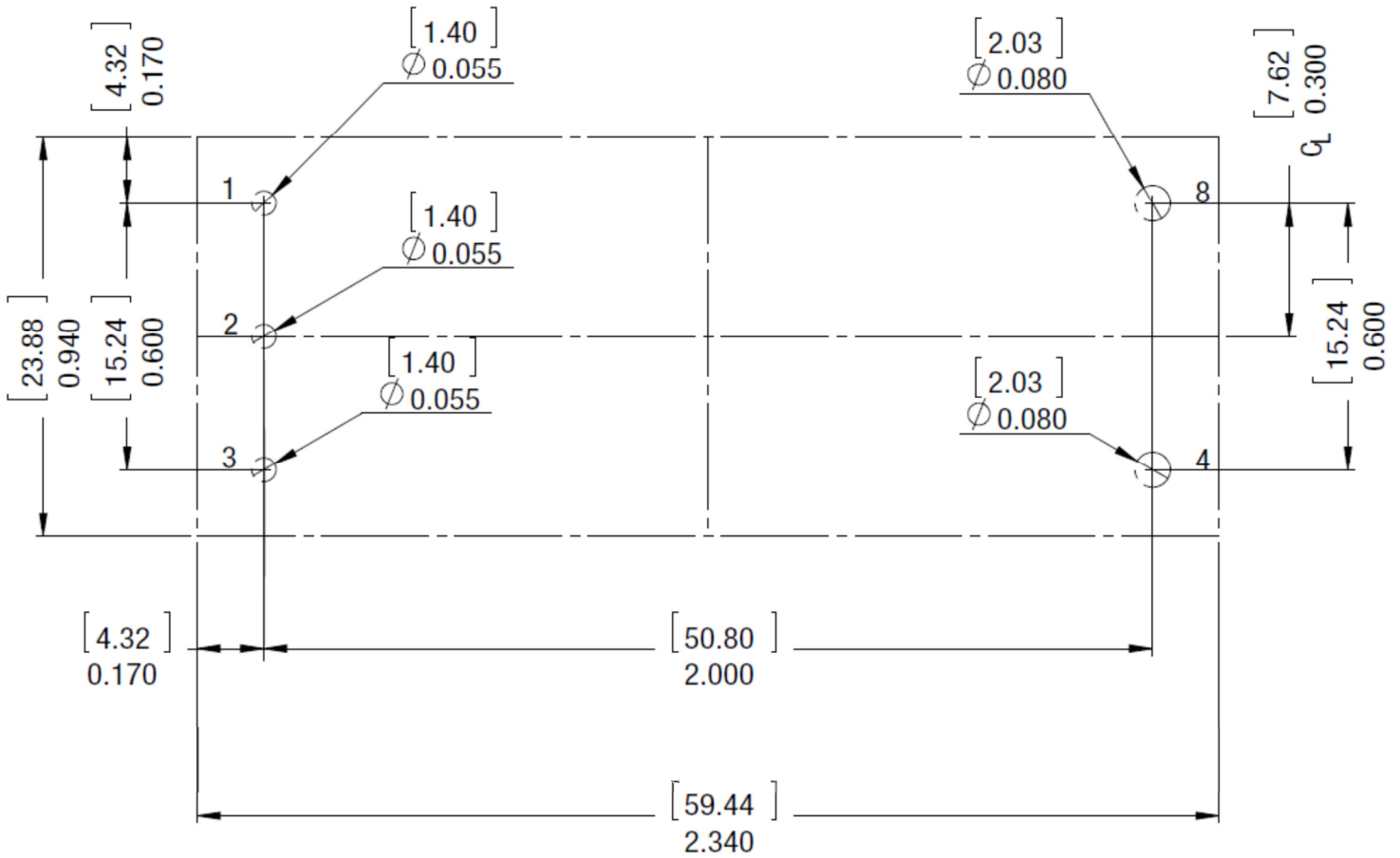

Dimensions are in inches (mm shown for ref. only)

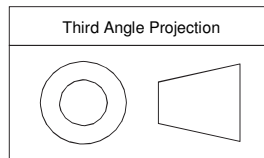

Tolerances (unless otherwise specified):
 .XX ± 0.02 (0.5)
 .XXX ± 0.010 (0.25) Angles ± 2°

Components are shown for reference only
 and may vary between units.

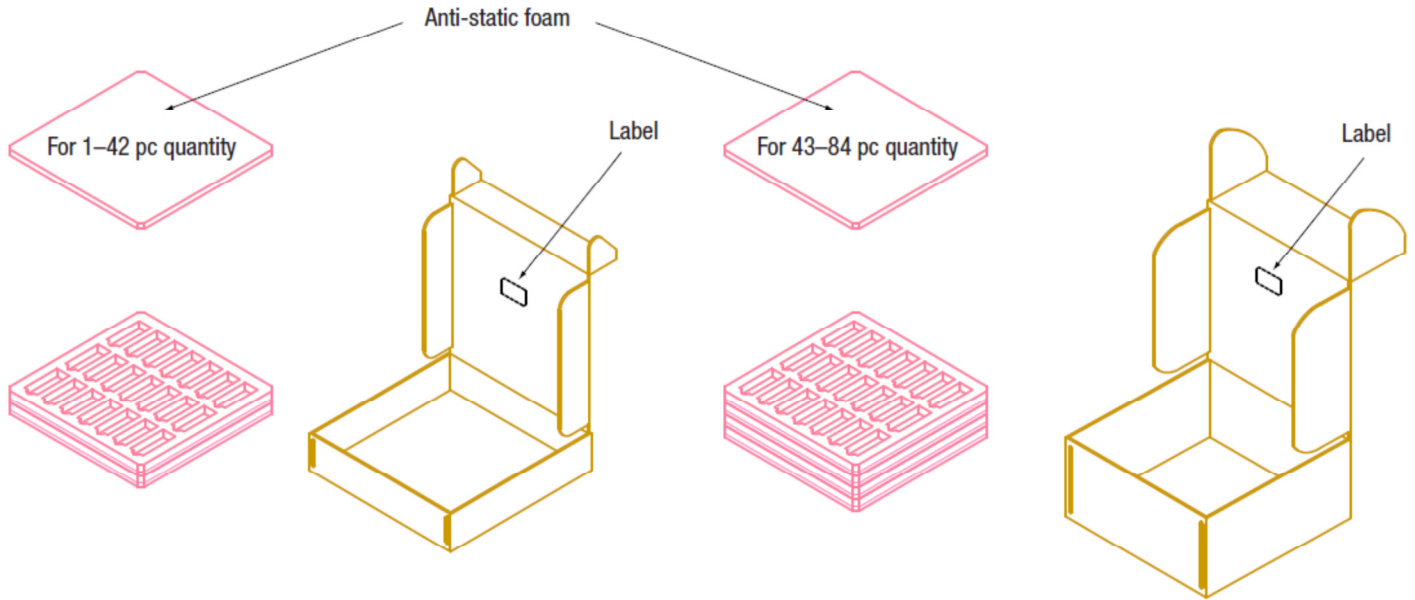

SHIPPING TRAY

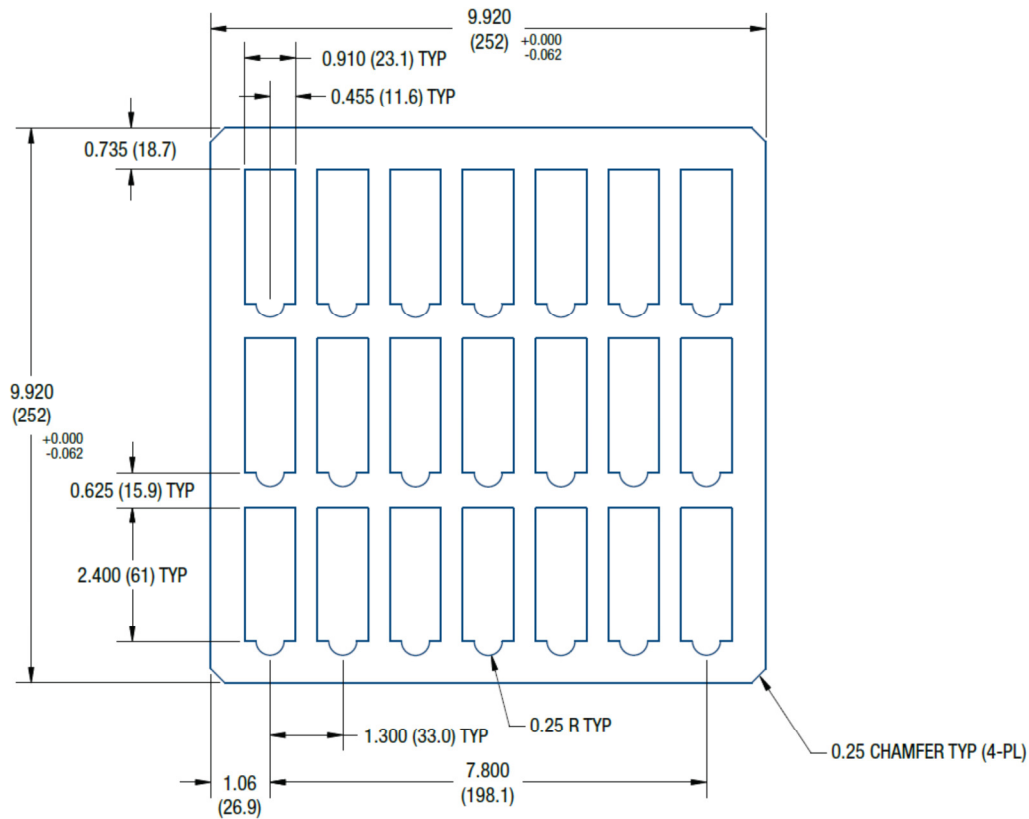

Notes:

- [1] DRE modules are supplied in a 21-piece (3-by-7) shipping tray.
- [2] The tray is an anti-static closed-cell polyethylene foam. Dimensions are shown above.
- [3] Dimensions in inches (mm)

TECHNICAL NOTES

<https://www.murata-ps.com/support>

THROUGH-HOLE SOLDERING GUIDELINES

Murata Power Solutions recommends the specifications below when installing these converters. These specifications vary depending on the solder type. Exceeding these specifications may cause damage to the product. Your production environment may differ; therefore please thoroughly review these guidelines with your process engineers.

Wave Solder Operations for through-hole mounted products (THMT)

For Sn/Ag/Cu based solders:

Maximum Preheat Temperature	115°C.
Maximum Pot Temperature	270°C.
Maximum Solder Dwell Time	7 seconds

For Sn/Pb based solders:

Maximum Preheat Temperature	105°C.
Maximum Pot Temperature	250°C.
Maximum Solder Dwell Time	6 seconds

Input Fusing

Certain applications and/or safety agencies may require fuses at the inputs of power conversion components. Fuses should also be used when there is the possibility of sustained input voltage reversal which is not current limited. For greatest safety, we recommend a fast blow fuse installed in the ungrounded input supply line with a value which is approximately twice the maximum line current, calculated at the lowest input voltage.

The installer must observe all relevant safety standards and regulations. For safety agency approvals, install the converter in compliance with the end-user safety standard.

Input Under-Voltage Shutdown and Start-Up Threshold

Under normal start-up conditions, converters will not begin to regulate properly until the rising input voltage exceeds and remains at the Start-Up Threshold Voltage (see Specifications). Once operating, converters will not turn off until the input voltage drops below the Under-Voltage Shutdown Limit. Subsequent restart will not occur until the input voltage rises again above the Start-Up Threshold. This built-in hysteresis prevents any unstable on/off operation at a single input voltage.

Users should be aware however of input sources near the Under-Voltage Shutdown whose voltage decays as input current is consumed (such as capacitor inputs), the converter shuts off and then restarts as the external capacitor recharges. Such situations could oscillate. To prevent this, make sure the operating input voltage is well above the UV Shutdown voltage AT ALL TIMES.

Start-Up Delay

Assuming that the output current is set at the rated maximum, the V_{in} to V_{out} Start-Up Time (see Specifications) is the time interval between the point when the rising input voltage crosses the Start-Up Threshold and the fully loaded regulated output voltage enters and remains within its specified regulation band. Actual measured times will vary with input source impedance, external input capacitance, input voltage slew rate and final value of the input voltage as it appears at the converter.

These converters include a soft start circuit to moderate the duty cycle of the PWM controller at power up, thereby limiting the input inrush current. The On/Off Remote Control interval from inception to V_{out} regulated assumes that the converter already has its input voltage stabilized above the Start-Up Threshold before the On command. The interval is measured from the On command until the output enters and remains within its specified regulation band. The specification assumes that the output is fully loaded at maximum rated current.

Input Source Impedance

These converters will operate to specifications without external components, assuming that the source voltage has very low impedance and reasonable input voltage regulation. Since real-world voltage sources have finite impedance, performance is improved by adding external filter components. Some- times only a small ceramic capacitor is sufficient. Since it is difficult to totally characterize all applications, some experimentation may be needed. Note that external input capacitors must accept high speed switching currents.

I/O Filtering, Input Ripple Current and Output Noise

All models in this converter series are tested and specified for input reflected ripple current and output noise using designated external input/output components, circuits and layout as shown in the figures below. External input capacitors (C_{in} in the figure) serve primarily as energy storage elements, minimizing line voltage variations caused by transient IR drops in the input conductors. Users should select input capacitors for bulk capacitance (at appropriate frequencies), low ESR and high RMS ripple current ratings. In the figure below, the C_{bus} and L_{bus} components simulate a typical DC voltage bus. Your specific system configuration may require additional considerations. Please note that the values of C_{in} , L_{bus} and C_{bus} will vary according to the specific converter model.

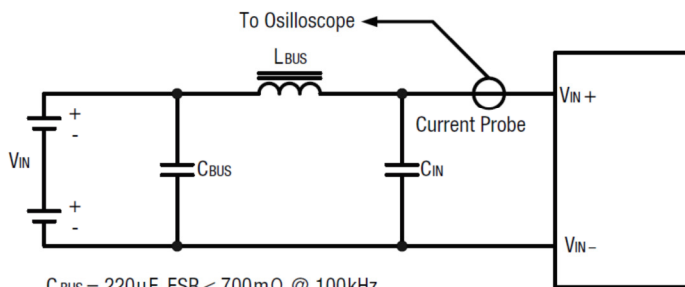

$C_{BUS} = 220\mu F$, ESR < 700mΩ @ 100kHz
 $C_{IN} = 500\mu F$, ESR < 100mΩ @ 100kHz
 $L_{BUS} = 10\mu H$

In critical applications, output ripple and noise (also referred to as periodic and random deviations (PARD)) may be reduced by adding filter elements such as multiple external capacitors. Be sure to calculate component temperature rise from reflected AC current dissipated inside the capacitor ESR.

Minimum Output Loading Requirements

All models regulate within specification and are stable under no load to full load conditions. Operation under no load might however slightly increase output ripple and noise.

Thermal Shutdown

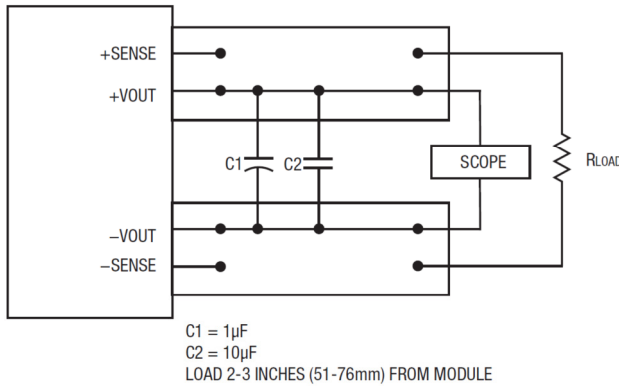

Figure 3. Measuring Output Ripple and Noise (PARD)

To protect against thermal overstress, these converters include thermal shutdown circuitry. If environmental conditions cause the temperature of the DC/DC's to rise above their operating temperature range (up to the shutdown temperature) an on-board electronic temperature sensor will power down the unit. When the temperature decreases below the turn-on threshold, the converter will automatically restart. There is a small amount of hysteresis to prevent rapid on/off cycling.

The temperature sensor is typically located adjacent to the switching controller, approximately in the center of the unit. See the Performance and Functional Specifications.

CAUTION: If you operate too close to the thermal limits, the converter may shut down suddenly without warning. Be sure to thoroughly test your application to the fan flowrate specifications.

Temperature Derating Curves

The graphs in this data sheet illustrate typical operation under a variety of conditions. The Derating curves show the maximum continuous ambient air temperature and decreasing maximum output current, which is acceptable under increasing forced (airflow measured in Linear Feet per Minute "LFM"). Note that these are AVERAGE measurements. The converter will accept brief increases in current or reduced airflow as long as the average is not exceeded.

Note that the temperatures are of the ambient airflow, not the converter itself which is obviously running at higher temperature than the outside air. Also note that very low flow rates (below about 25 LFM) are similar to "natural convection," that is, not using fan-forced airflow.

Murata Power Solutions performs characterization measurements in a closed cycle wind tunnel with calibrated airflow. Both thermocouples and an infrared camera system are used to observe thermal performance. As a practical matter, it is quite difficult to insert an anemometer to precisely measure airflow in most applications. Sometimes it is possible to estimate the effective airflow if you thoroughly understand the enclosure geometry, entry/exit orifice areas and the fan flowrate specifications.

CAUTION: If you exceed these Derating guidelines, the converter may have an unplanned Over Temperature shut down. Also, these graphs are all collected near Sea Level altitude. Be sure to reduce the derating for higher altitude.

Output Fusing

The converter is extensively protected against current, voltage and temperature extremes. However your application circuit may need additional protection. In the extremely unlikely event of output circuit failure, excessive voltage could be applied to your circuit. Consider using appropriate external protection.

Output Current Limiting

As soon as the output current increases to approximately 125% to 150% of its maximum rated value, the DC/DC converter shall enter current limiting mode. The output voltage shall decrease proportionally with increase in output current, thereby maintaining a somewhat constant power output. This is also commonly referred to as power limiting.

Current limiting inception is defined as the point at which full power falls below the rated tolerance. See the Performance/Functional Specifications. Note particularly that the output current may briefly rise above its rated value in normal operation as long as the average power is not exceeded. This enhances reliability and continued operation of your application. If the output current is too high the converter shall enter short circuit protection.

Output Short Circuit Protection

When a converter is in current-limit mode, the output voltage will drop as the output current demand increases. If the output voltage drops too low (approximately 98% of nominal output voltage for most models), the magnetically coupled voltage used to develop the PWM bias voltage will also drop, thereby shutting down the PWM controller.

Following a time-out period, the PWM will restart, causing the output voltage to begin rising to its appropriate value. If the short-circuit condition persists, another shutdown cycle will initiate. This rapid on/off cycling is called "hiccup mode." The hiccup cycling reduces the average output current, thereby preventing excessive internal temperatures and/or component damage.

The "hiccup" system differs from older latching short circuit systems because you do not have to power down the converter to make it restart. The system will automatically restore operation as soon as the short circuit condition is removed.

Remote On/Off Control

On the input side, a remote On/Off Control can be specified with either positive or negative logic.

Positive: Models equipped with positive logic are enabled when the On/Off pin is left open or is pulled high to +Vin with respect to -Vin. An internal bias current causes the open pin to rise to approximately +15V. Some models will also turn on at lower intermediate voltages (see Specifications). Positive-logic devices are disabled when the On/Off is grounded or brought to within a low voltage (see Specifications) with respect to -Vin.

Negative: Models with negative logic are on (enabled) when the On/Off is grounded or brought to within a low voltage (see Specifications) with respect to -Vin. The device is off (disabled) when the On/Off is left open or is pulled high to approximately +15V with respect to -Vin.

Dynamic control of the On/Off function should be able to sink the specified signal current when brought low and withstand appropriate voltage when brought high. Be aware to that there is a finite time in milliseconds (see Specifications) between the time of On/Off Control activation and a stable, regulated output. This time will vary slightly with output load type and current and input conditions.

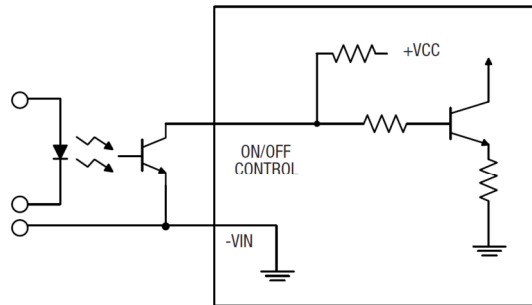

Figure 4. Driving the On/Off Control Pin (suggested circuit)

Output Capacitive Load

These converters do not require external capacitance added to achieve rated specifications. Users should only consider adding capacitance to reduce switching noise and/or to handle spike current step loads. Install only enough capacitance to achieve noise objectives. Excess external capacitance may cause regulation problems, slower transient response and possible instability. Proper wiring of the Sense inputs will improve these factors under capacitive load.

The maximum rated output capacitance and ESR specification is given for a capacitor installed immediately adjacent to the converter. Any extended output wiring or smaller wire gauge or less ground plane may tolerate somewhat higher capacitance. Also, capacitors with higher ESR may use a larger capacitance.

Load Sharing

Load sharing occurs when two or more DREs are connected in parallel, at both the input and output terminals, to supply greater output current than one unit alone or to offer system redundancy for moderate loads. If one converter fails, the other converter(s) will carry the load until the system is repaired.

The DRE's design allows load sharing using the "droop" method, also called the "direct connect" technique. Simply put, at light loads, the converter shall exhibit slightly higher output voltage and shall carry more of the output current. Since the DRE's synchronous rectifier design will not accept appreciable reverse output current, starting at zero load, the DRE with the higher output voltage will carry more of the full load until the voltage at the output drops to that of the lower DRE's.

Load Sharing Guidelines

If you wish to operate two or more DRE's in load sharing, use the following guidelines:

[1] Operate both converters connected in parallel from the same 48V input power source. This simplifies the design and makes for more balanced power sharing. Using two different 48V input supplies must be carefully analyzed to avoid overloading one of the converters and is not recommended.

Make sure the single 48V input source can supply the total current needed by all the parallel-connected DRE's. (Actually, it is possible to rate the full system at more than the current capacity of a single DRE. However, you now lose the redundancy protection feature.)

[2] Use conservative loading. Do not assume for example that two parallel DRE's can always supply "times two" amounts of output current. Allow for limits in input voltage and other factors.

If one DRE overloads while in load share, it will protect itself by entering overcurrent mode. If the whole system is running close to maximum output current, the remaining good DRE will soon also enter overcurrent mode. These two events probably will not happen together, possibly leaving the system operating in degraded mode for a while. The solution here is conservative design to avoid getting close to the load limits.

[3] Make the input wiring lengths and wire gauges identical on both inputs and outputs. If in doubt, make some precision measurements under full load. But if you attempt to measure the current in one of the converters using a series shunt, remember that the current meter, itself, may introduce enough finite resistance to affect the readings. (Hint: Use a non-contacting "clamp-on" Hall effect DC current meter with zero IR loss.)

[4] If you add the optional input filters, use identical components with the same layout.

[5] Operate both converters in the same temperature and airflow environment. Under load sharing, small differences in cooling can amplify into load imbalances.

[6] Avoid operation near the low input voltage limit of the converter. Another subtle factor here is the external source impedance of the input supply. A source with higher impedance at full load may make the net input voltage seen by the converter close to its minimum input voltage. Be sure to account for the decrease in effective input voltage under load.

For battery sources, this means that the batteries should be freshly charged and that the AC trickle charger is in good working order. Note that older batteries increase their internal cell impedance even if their no-load output voltage appears acceptable. Remember that what counts here is the voltage seen at the DRE input connections with full current.

[7] As with any system design, thoroughly test the DRE's connected in load sharing before committing the design to a real application.

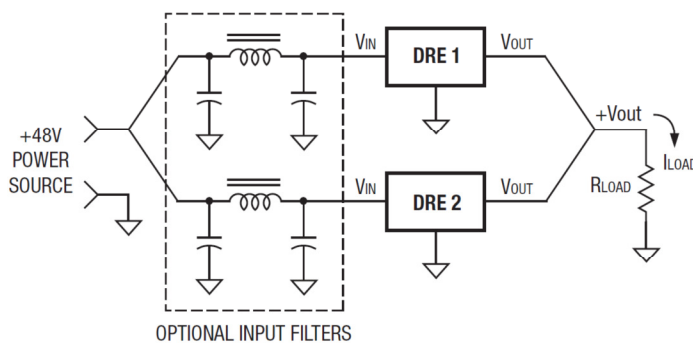

Figure 5. Load Sharing Block Diagram

CAUTION – This converter is not internally fused. To avoid danger to persons or equipment and to retain safety certification, the user must connect an external fast-blow input fuse as listed in the specifications.
Be sure that the PC board pad area and etch size are adequate to provide enough current so that the fuse will blow with an overload.

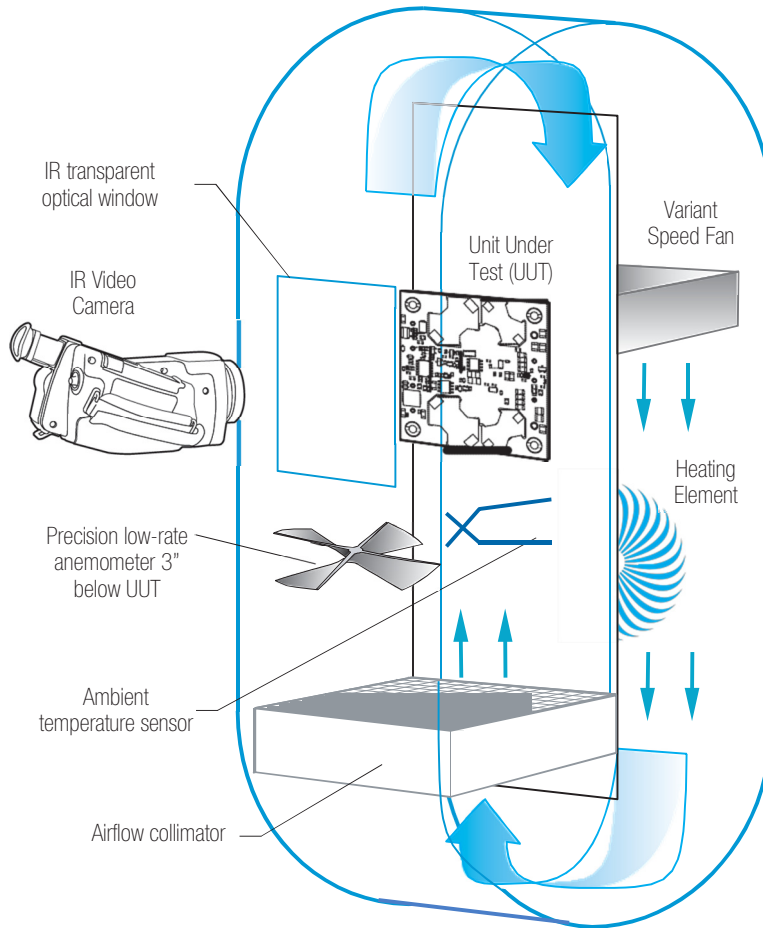

Fig 6. Vertical Wind Tunnel

Vertical Wind Tunnel

Murata Power Solutions employs a computer controlled custom designed closed loop vertical wind tunnel, infrared video camera system, and test instrumentation for accurate airflow and heat dissipation analysis of power products.

The system includes a precision low flow-rate anemometer, variable speed fan, power supply input and load controls, temperature gauges, and adjustable heating element.

The IR camera monitors the thermal performance of the Unit Under Test (UUT) under static steady-state conditions. A special optical port is used which is transparent to infrared wavelengths.

Both through-hole and surface mount converters are soldered down to a 10" x 10" host carrier board, for realistic heat absorption and spreading. Both longitudinal and transverse airflow studies are possible by rotation of this carrier board since there are often significant differences in the heat dissipation in the two airflow directions.

The combination of adjustable airflow, adjustable ambient heat, and adjustable Input/Output currents and voltages mean that a very wide range of measurement conditions can be studied.

The collimator reduces the amount of turbulence adjacent to the UUT. Such turbulence influences the effective heat transfer characteristics and gives false readings. Excess turbulence removes more heat from some surfaces and less heat from others, possibly causing uneven overheating.

Both sides of the UUT are studied since there are different thermal gradients on each side. The adjustable heating element and fan, built-in temperature gauges, and no-contact IR camera mean that power supplies are tested in real-world conditions.

Emissions Performance

Murata Power Solutions measures its products for conducted emissions against the EN 55022 and CISPR 22 standards. Passive resistance loads are employed and the output is set to the maximum voltage. If you set up your own emissions testing, make sure the output load is rated at continuous power while doing the tests.

The recommended external input and output capacitors (if required) are included. Please refer to the fundamental switching frequency. All of this information is listed in the Product Specifications. An external discrete filter is installed and the circuit diagram is shown below.

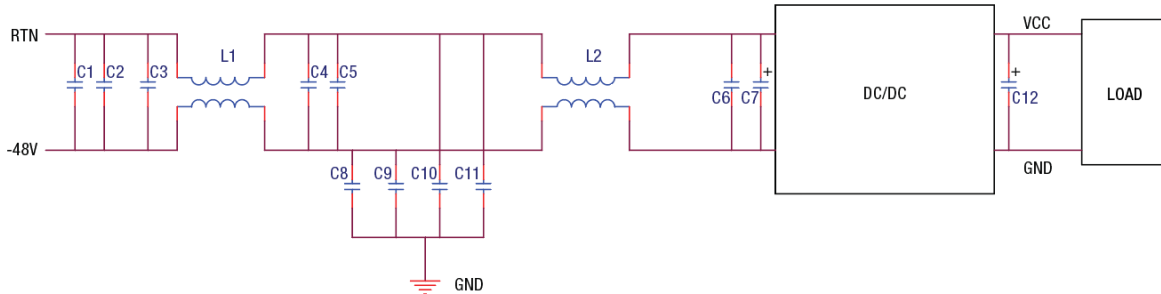

[1] Conducted Emissions Parts List

Reference	Part Number	Description	Vendor
C1, C2, C3, C4, C5	GRM32ER72A105KA01L	SMD CERAMIC-100V-1000nF-X7R-1210	Murata
C6	GRM319R72A104KA01D	SMD CERAMIC100V-100nF-±10%-X7R-1206	Murata
L1, L2	PG0060T	COMMON MODE-473uH-±25%-14A	Pulse
C8, C9, C10, C11	GRM55DR72J224KW01L	SMD CERAMIC 630V-0.22uF-±10%-X7R-2220	Murata
C7	UHE2A221MHD	Aluminum100V-220uF-±10%-long lead	Nichicon
C12	N/A	---	

[2] Conducted Emissions Test Equipment Used

Hewlett Packard HP8594L Spectrum Analyzer – S/N 3827A00153

2Line V-networks LS1-15V 50Ω/50uH Line Impedance Stabilization Network

[3] Conducted Emissions Test Results – Positive Line

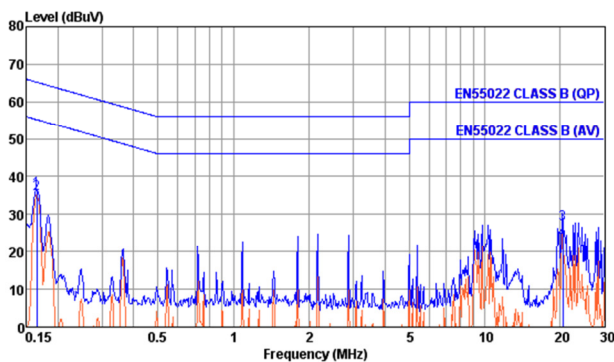

Graph 1. Conducted emissions performance, Positive Line
CISPR 22, Class B, full load

[3] Conducted Emissions Test Results – Negative Line

Graph 2.

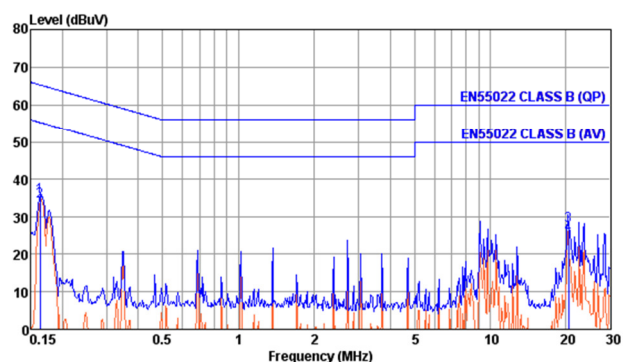

Conducted emissions performance, Negative Line
CISPR 22, Class B, full load

[4] Layout Recommendations

Most applications can use the filtering which is already installed inside the converter or with the addition of the recommended external capacitors. For greater emissions suppression, consider additional filter components and/or shielding. Emissions performance will depend on the user's PC board layout, the chassis shielding environment and choice of external components.

Since many factors affect both the amplitude and spectra of emissions, we recommend using an engineer who is experienced at emissions suppression.

Murata Power Solutions, Inc.
129 Flanders Rd, Westborough, MA 01581 USA
ISO 9001 and 14001 REGISTERED



This product is subject to the following operating requirements and the Life and Safety Critical Application Sales Policy:

Refer to: <http://www.murata-ps.com/requirements/>

Murata Power Solutions, Inc. makes no representation that the use of its products in the circuits described herein, or the use of other technical information contained herein, will not infringe upon existing or future patent rights. The descriptions contained herein do not imply the granting of licenses to make, use, or sell equipment constructed in accordance therewith. Specifications are subject to change without notice.

© 2019 Murata Power Solutions, Inc.

X-ON Electronics

Largest Supplier of Electrical and Electronic Components

Click to view similar products for [Isolated DC/DC Converters](#) category:

Click to view products by [Murata](#) manufacturer:

Other Similar products are found below :

[ESM6D044440C05AAQ](#) [FMD15.24G](#) [PSL486-7LR](#) [PSR152.5-7IR](#) [Q48T30020-NBB0](#) [AVO240-48S12B-6L](#) [AVO250-48S28B-6L](#) [NAN-0505](#) [HW-L16D](#) [JAHW100Y1](#) [217-1617-001](#) [22827](#) [SPB05C-12](#) [SQ24S15033-PS0S](#) [18952](#) [19-130041](#) [CE-1003](#) [CE-1004](#) [GQ2541-7R](#) [PSE1000DCDC-12V](#) [RDS180245](#) [MAU228](#) [419-2065-201](#) [449-2075-101](#) [J80-0041NL](#) [V300C24C150BG](#) [419-2062-200](#) [419-2063-401](#) [419-2067-101](#) [419-2067-501](#) [419-2068-001](#) [DCG40-5G](#) [DFC15U48D15](#) [449-2067-000](#) [XGS-0512](#) [XGS-1205](#) [XGS-1212](#) [XGS-2412](#) [XGS-2415](#) [XKS-1215](#) [033456](#) [NCT1000N040R050B](#) [SPB05B-15](#) [SPB05C-15](#) [SSQE48T25025-NAA0G](#) [L-DA20](#) [HP3040-9RG](#) [HP1001-9RTG](#) [NVD0.4YJJ-M6G](#) [XKS-2415](#)