

Micro Chip Transformer DXW21BN7511□□ Reference Specification

1. Scope

This reference specification applies to Micro Chip Transformer.

2. Part Numbering

(ex.) $\frac{DX}{(1)} \frac{W}{(2)} \frac{21}{(3)} \frac{B}{(4)} \frac{N}{(5)} \frac{75}{(6)} \frac{11}{(7)} \frac{T}{(8)} \frac{L}{(9)}$

- | | |
|------------------------------------|---|
| (1) Micro Chip Transformer | (6) Port Impedance (75: 75ohm) |
| (2) Structure (W: Winding Type) | (7) Impedance ratio (11: one to one) |
| (3) Dimension (LxW) | (8) Main Application (T: Televisions/ S: Satellite STB) |
| (4) Type of Transformer (B: Balun) | (9) Packing Code L:Taping / B:Bulk |
| (5) Category | |

3. Electrical Specification 1

Customer Part Number	Murata Part Number	Freq. Range	Port Impedance [ohm]	Insertion Loss [dB max.] at Freq. Range	CMRR [dB min.] at Freq. Range	DC Resistance [ohm max.]
	DXW21BN7511TL	50-1200 MHz	75/75	50-870MHz:max.1.0 870-1200MHz: max.1.2	20	0.77
	DXW21BN7511TB					
	DXW21BN7511SL	1-1.5 GHz	75/75	1.4	20	0.59
	DXW21BN7511SB					

Electrical Specification 2

Rated Voltage [DCV]	Withstand Voltage [DCV]	Rated Power [dBm]	Insulation Resistance [Mohm min.]
20	50	27	10

Operating Temperature : -40 to +85°C Storage Temperature : -40 to +85°C

4. Standard Testing Condition

<Unless otherwise specified>
 Temperature : Ordinary Temperature 15 to 35°C
 Humidity : Ordinary Humidity 25 to 85%(RH)

<In case of doubt>
 Temperature : 20 ± 2°C
 Humidity : 60 to 70%(RH)
 Atmospheric Pressure : 86 to 106kPa

5. Style and Dimensions

■Equivalent Circuit

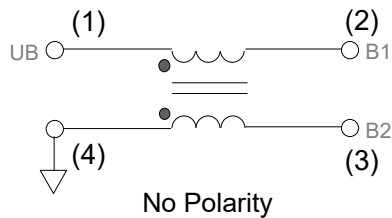

■Unit Mass (typ.)
0.011g

■Dimension

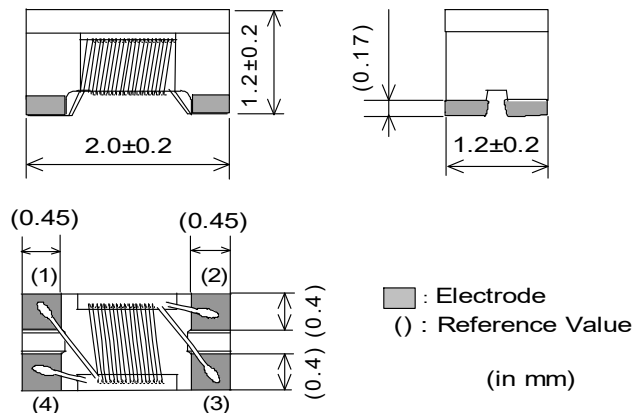

6. Marking

No Marking.

7. Electrical Performance

No.	Item	Specification	Definition and Measurement Method
7.1	Insertion Loss (IL)	Meet item 3.	<p>Insertion Loss is given by Sds21 mag. extracted from the below circuit.</p> $IL[dB] = 20\log_{10}(Sds21)$ <p>Where Sds21 is S-parameter of single mode stimulus - Differential mode response</p> <p>Parasitics and loss factors caused by the test board have to be removed.</p>
7.2	CMRR	Meet item 3.	<p>CMRR is given by the following equation, S-parameters are extracted from the below circuit.</p> $CMRR[dB] = 20\log_{10}(Sds21/Scs21)=20\log_{10}\{(S21+S31)/(S21-S31)\}$ <p>Where Sds21 is S-parameter of single mode stimulus - Differential mode response Scs21 is S-parameter of single mode stimulus - Common mode response</p> <p>Parasitics and loss factors caused by the test board have to be removed.</p>
7.3	Withstand Voltage	No damage.	<p>Test Voltage : 50V Time : 5 seconds Charge Current : 1mA max.</p>
7.4	DC Resistance (Rdc)	Meet item 3.	<p>Measuring current : 10mA max. (In case of doubt in the above mentioned standard condition, measure by 4 terminal method.)</p>
7.5	Insulation Resistance (I.R.)	Meet item 3.	<p>Measuring voltage : Rated Voltage Measuring time : 1 minute max.</p>

8. Mechanical Performance

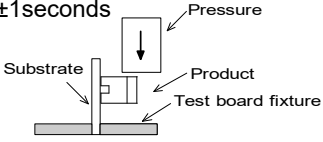
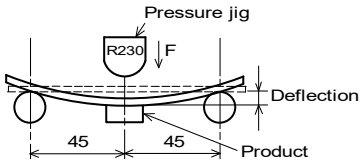
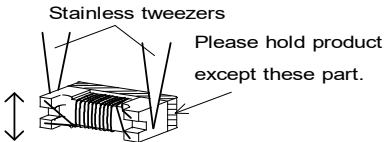
No.	Item	Specification	Test Method							
8.1	Appearance and Dimensions	Meet all dimension on item 5.	Visual Inspection and measurement with microscope.							
8.2	Bonding Strength	No evidence of coming off substrate. Products shall not be mechanical damaged.	It shall be soldered on the substrate. Applying Force(F) : 5N Applying Time : 5±1seconds 							
8.3	Bending Strength	Meet Table 1. Table 1 <table border="1" style="width: 100%; border-collapse: collapse;"> <tr> <td style="width: 30%;">Appearance</td> <td rowspan="6" style="text-align: center; vertical-align: middle;">No damaged Meet Item 3.</td> </tr> <tr> <td>IL</td> </tr> <tr> <td>CMRR</td> </tr> <tr> <td>DC Resistance</td> </tr> <tr> <td>I.R.</td> </tr> <tr> <td>Withstand Voltage</td> </tr> </table>	Appearance	No damaged Meet Item 3.	IL	CMRR	DC Resistance	I.R.	Withstand Voltage	It shall be soldered on the Glass-epoxy substrate. Deflection : 2mm (t=1.0mm). Keeping time : 5 seconds Speed of Applying Force : 0.5mm/s 
Appearance	No damaged Meet Item 3.									
IL										
CMRR										
DC Resistance										
I.R.										
Withstand Voltage										
8.4	Drop		It shall be dropped on concrete or steel board. Method : free fall Height : 1 m The Number of Times : 3 times							
8.5	Vibration		It shall be soldered on the substrate. Oscillation Frequency : 10 to 55 to 10Hz for 1 minute Total Amplitude : 1.5mm Testing Time : A period of 2 hours in each of 3 mutually perpendicular directions. (Total 6 hours)							
8.6	Solderability	The electrodes shall be at least 90% covered with new solder coating.	Flux: Ethanol solution of rosin, 25(wt)% includes activator equivalent to 0.06 to 0.10(wt)% chlorine Pre-Heating : 80 to 120°C 1minute Solder : Sn-3.0Ag-0.5Cu Solder Temperature : 245±3°C Immersion Time : 4±1 seconds Immersion and emersion rates : 25mm/s 							
8.7	Resistance to Soldering Heat	Meet Table 1.	Flux : Ethanol solution of rosin, 25(wt)% includes activator equipment to 0.06 to 0.10(wt)% chlorine Pre-Heating : 80 to 120°C , 1minute Solder : Sn-3.0Ag-0.5Cu Solder Temperature : 260±5°C Immersion Time : 5±0.5 seconds Immersion and emersion rates : 25mm/s Then measured after exposure in the room condition for 4 to 48 hours.							

9. Environmental Performance(Products shall be soldered on the substrate.)

No.	Item	Specification	Test Method
9.1	Temperature Cycle	Meet Table 1.	1 Cycle Step 1 -40°C(+0°C,-3°C) / 30±3 min Step 2 Ordinary Temp. / 10 to 15 minutes Step 3 +85°C(+3°C,-0°C) / 30±3 min Step 4 Ordinary Temp. / 10 to 15 minutes Total of 100 cycles Then measured after exposure in the room condition for 4 to 48 hours
9.2	Humidity		Temperature : 40±2°C Humidity : 90~95%(RH) Time : 1000(+48 hours,-0 hours) Then measured after exposure in the room condition for 4 to 48 hours.
9.3	Heat life		Temperature : 85±2°C Applying Rated Power Time : 1000(+48 hours,-0 hours) Then measured after exposure in the room condition for 4 to 48 hours.
9.4	Cold Resistance		Temperature : -40± 2°C Time : 1000(+48 hours,-0 hours) Then measured after exposure in the room condition for 4 to 48 hours.

10. Specification of Packaging

10.1 Appearance and Dimensions (8mm-wide,Plastic tape)

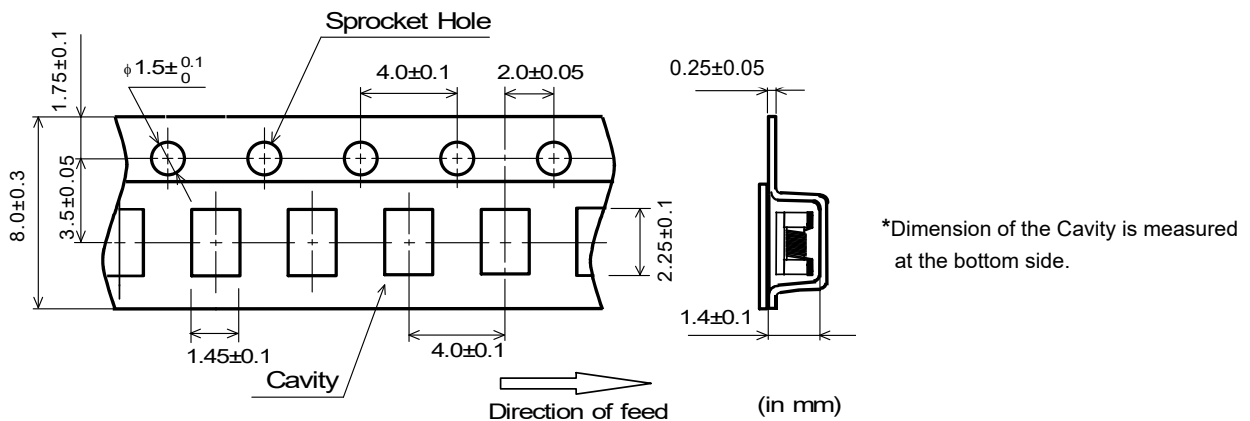

10.2 Specification of Taping

- (1)Packing quantity(Standard quantity) 2000 pcs. / reel
- (2)Packing Method
Products shall be packaged in each embossed cavity of plastic tape and sealed with cover tape.
- (3) Spliced point
The cover tape have no spliced point.
- (4) Sprocket Hole
Sprocket hole shall be located on the left hand side toward the direction of feed.
- (5)Missing components number
Missing components number within 0.025% of the number per reel or 1 pc, whichever is greater, and are not continuous. The specified quantity per reel is kept.

10.3 Pull Strength of the Tape Package

Plastic Tape	5N min.
Cover Tape	10N min.

10.4 Peeling force of the Cover Tape

0.2 to 0.7N(Minimum value is Typical)
Peeling verosity is 300 mm / min

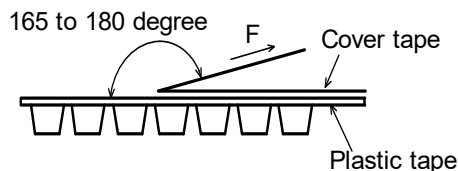

10.5 Dimensions of Leader-tape, Trailer and Reel

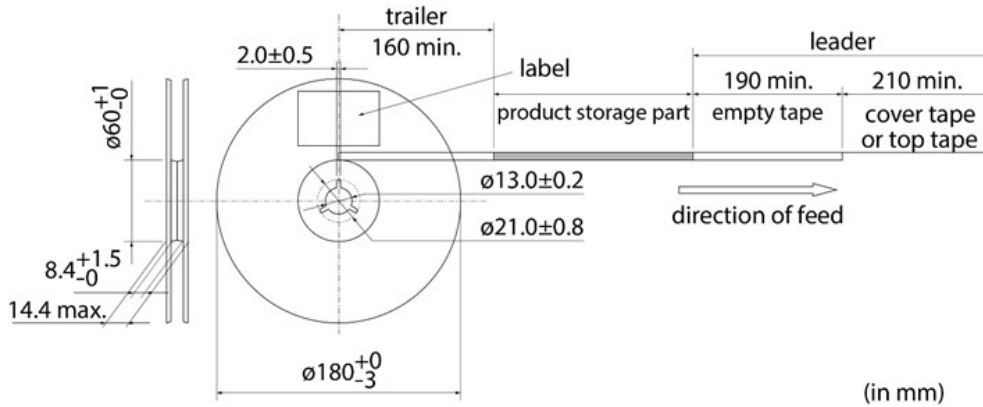

10.6 Marking for reel

Customer part number, MURATA part number, Inspection number(*1), RoHS Marking(*2), Quantity, etc

*1) « Expression of Inspection No. »

□□ 0000 ×××
(1) (2) (3)

(1) Factory Code

(2) Date

First digit : Year / Last digit of year

Second digit : Month / Jan. to Sep. → 1 to 9, Oct. to Dec. → O,N,D

Third, Fourth digit : Day

(3) Serial No.

*2) « Expression of RoHS Marking »

ROHS - Y (Δ)
(1) (2)

(1) RoHS regulation conformity parts.

(2) MURATA classification number

10.7 Marking for Outside package

Customer name Purchasing Order Number, Customer Part Number, MURATA part number, RoHS Marking (*2), Quantity, etc

10.8 Specification of Outer Case

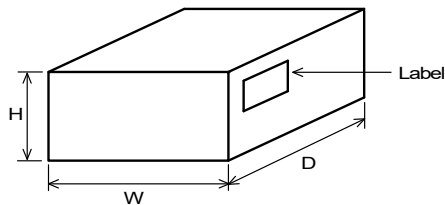

Outer Case Dimensions (mm)			Standard Reel Quantity in Outer Case (Reel)
W	D	H	
186	186	93	5

* Above Outer Case size is typical. It depends on a quantity of an order.

11. ⚠ Caution

11.1 Mounting Direction

Mount products in right direction.

Wrong direction which is 90° rotated from right direction causes not only open or short circuit but also flames or other serious trouble.

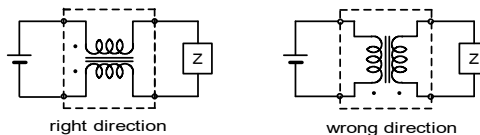

11.2 Limitation of Application

Please contact us before using our products for the applications listed below which require especially high reliability for the prevention of defects which might directly cause damage to the third party's life, body or property.

- | | |
|-----------------------------------|--|
| (1) Aircraft equipment | (6) Transportation equipment (vehicles, trains, ships, etc.) |
| (2) Aerospace equipment | (7) Traffic signal equipment |
| (3) Undersea equipment | (8) Disaster prevention / crime prevention equipment |
| (4) Power plant control equipment | (9) Data-processing equipment |
| (5) Medical equipment | (10) Applications of similar complexity and / or reliability requirements to the applications listed in the above. |

12. Notice

Products can only be soldered with reflow.

This product is designed for solder mounting.

Please consult us in advance for applying other mounting method such as conductive adhesive.

12.1 Flux and Solder

Flux	Use rosin-based flux, (with converting chlorine content 0.06 to 0.1(wt)%), but not highly acidic flux (with Halogen content exceeding 0.2(wt)% conversion to chlorine). Do not use water-soluble flux.
Solder	Use Sn-3.0Ag-0.5Cu solder

12.2 Assembling

<Exclusive use of Reflow soldering>

Flow soldering may cause deterioration in insulation resistance.

So, reflow soldering shall be applied for this product.

12.3 Cleaning Conditions

Do not clean after soldering. Some cleaning agents may degrade bonding strength, and characteristics of products by detaching. If cleaning, please contact us.

12.4 Resin coating

The electrical performance may change due to high cure-stress of resin to be used for coating/molding products. An open circuit issue may occur by mechanical stress caused by the resin, amount/cured shape of resin, or operating condition etc. Some resin contains some impurities or chloride possible to generate chlorine by hydrolysis under some operating condition may cause corrosion of wire of coil, leading to open circuit. So, please pay your careful attention when you select resin in case of coating/molding the products with the resin. Prior to use the coating resin, please make sure no reliability issue is observed by evaluating products mounted on your board.

12.5 Attention regarding P.C.B. bending

The following shall be considered when designing and laying out P.C.B.'s.

- (1) P.C.B. shall be designed so that products are not subject to the mechanical stress due to warping the board.

[Products direction]

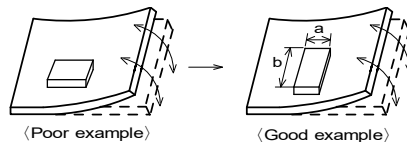

Products shall be location the sideways Direction (Length : $a < b$) to the mechanical Stress.

- (2) Components location on P.C.B. separation.

It is effective to implement the following measures, to reduce stress in separating the board.

It is best to implement all of the following three measures; however, implement as many measures as possible to reduce stress.

Contents of Measures	Stress Level
(1) Turn the mounting direction of the component parallel to the board separation surface.	A > D *1
(2) Add slits in the board separation part.	A > B
(3) Keep the mounting position of the component away from the board separation surface.	A > C

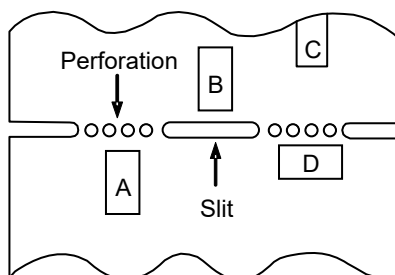

*1 A > D is valid when stress is added vertically to the perforation as with Hand Separation. If a Cutting Disc is used, stress will be diagonal to the PCB, therefore A > D is invalid.

(3) Mounting Components Near Screw Holes

When a component is mounted near a screw hole, it may be affected by the board deflection that occurs during the tightening of the screw. Mount the component in a position as far away from the screw holes as possible.

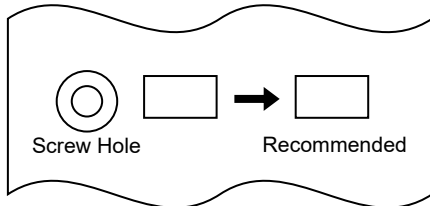

12.6 Attention Regarding P.C.B. Design

< The Arrangement of Products >

P.C.B. shall be designed so that products are far from the portion of perforation.

The portion of perforation shall be designed as narrow as possible and shall be designed so as not to be applied the stress in the case of P.C.B. separation.

Products shall not be arranged on the line of a series of holes when there are big holes in P.C.B. (Because the stress concentrate on the line of holes.)

< Products Placing >

Support pins shall be set under P.C.B. to prevent causing a warp to P.C.B. during placing the products on the other side of P.C.B.

< P.C.B. Separation >

P.C.B. shall not be separated with hand.

P.C.B. shall be separated with the fixture so as not to cause P.C.B. bending.

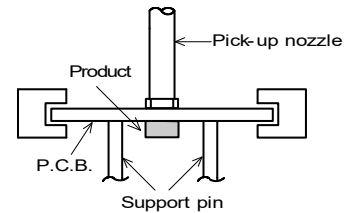
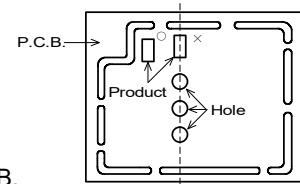
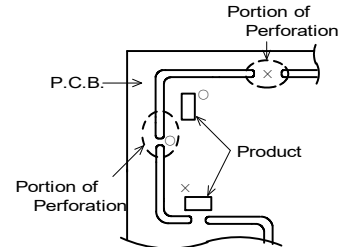

12.7 Standard Land Dimensions (Reflow)

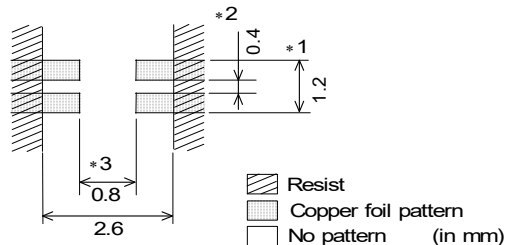

- *1 If the pattern is made with wider than 1.2mm. It will result to let component turn around, because melting speed is different. In the worst case, short circuit between lines may be occurred.
- *2 If the pattern is made with less than 0.4mm, in the worst case, short circuit between lines may be occurred due to the spread of soldering paste or mount placing accuracy.
- *3 If the pattern is made with wider than 0.8mm, the strength of bending will be reduced.
- *4 Do not use gilded pattern. A copper wire may cause open by dissolution of metallization.

12.8 Standard Soldering Condition

1. Reflow Soldering

(1) Standard printing pattern for soldering.

- Standard thickness of the solder paste should be 100 to 150µm.
- Use the solder paste printing pattern of the right pattern.
- For the resist and copper foil pattern, use standard land dimensions.
- Use the Solder Sn-3.0Ag-0.5Cu for pattern printing.
- Spread of soldering paste between lines may cause short circuit of lines.

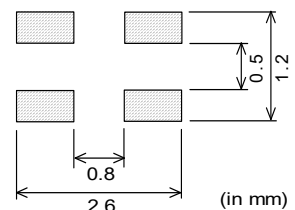

(2) Soldering Temperature

Temperature difference between soldering and surface of components must be within 150°C, in preheating. When components are immersed in liquid after soldering, temperature difference should be within 100°C. If preheating is not enough, components may be cracked and cause deterioration in insulation resistance.

(3) Soldering Condition

Standard soldering profile and the limit soldering profile is as follows.

The excessive limit soldering conditions may cause leaching of the electrode and / or resulting in the deterioration of product quality.

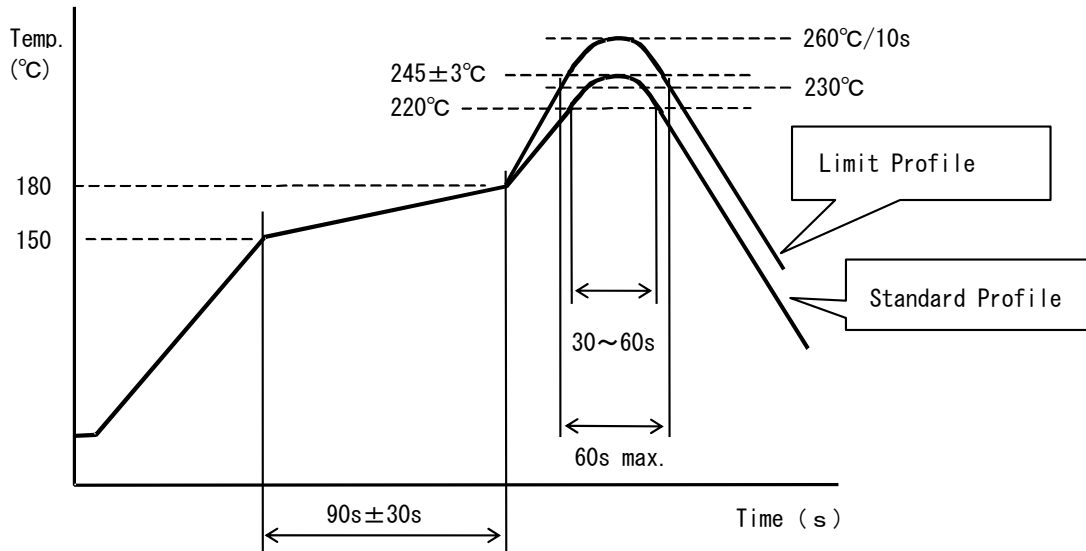

	Standard Profile	Limit Profile
Pre-heating	150~180°C、90s±30s	
Heating	above 220°C、30s~60s	above 230°C、60s max.
Peak temperature	245±3°C	260°C、10s
Cycle of reflow	2 times	2 times

2. Reworking with Soldering iron

The following conditions must be strictly followed when using a soldering iron after being mounted by reflow soldering.

- Pre-heating: 150°C, 1 min
- Soldering iron output: 30W max.
- Tip temperature: 350°C max.
- Tip diameter: φ3mm max.
- Soldering time : 3(+1,-0) seconds.
- Times : 2times max.

Notes: Do not touch the products directly with the soldering iron.

3. Solder Volume

Solder shall be used not to be exceeded the upper limits as shown below.

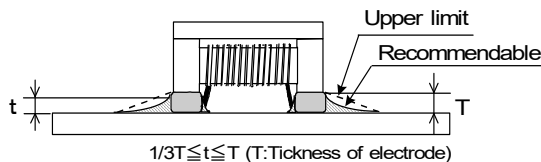

Accordingly increasing the solder volume, the mechanical stress to Chip is also increased. Exceeding solder volume may cause the failure of mechanical or electrical performance.

12.9 Caution for use

- When you hold products with a tweezer, please hold like a figure of the right side, and sharp material, such as a pair of tweezers, shall not be touched to the winding portion to prevent the breaking of wire.
- Mechanical shock should not be applied to the products mounted on the board to prevent the breaking of the core.

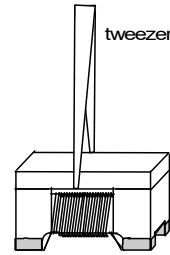

12.10 Handling of a substrate

After mounting products on a substrate, do not apply any stress to the product caused by bending or twisting to the substrate when cropping the substrate, inserting and removing a connector from the substrate or tightening screw to the substrate.

Excessive mechanical stress may cause cracking in the product.

Bending

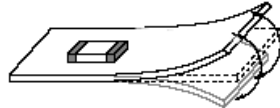

Twisting

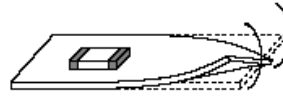

12.11 Brushing of neighborhood of products

When you clean the neighborhood of products such as connector pins, bristles of cleaning brush shall not be touched to the winding portion to prevent the breaking of wire.

12.12 Operating Environment

Do not use this product under the following environmental conditions, on deterioration of the performance, such as insulation resistance may result from the use.

- (1) in corrosive gases (acidic gases, alkaline gases, chlorine, sulfur gases, organic gases and etc.)
- (2) in the atmosphere where liquid such as organic solvent, may splash on the products.

12.13 Storage Condition

(1) Storage period

Use the products within 12 months after delivered.
Solderability should be checked if this period is exceeded.

(2) Storage environment conditions

·Products should be stored in the warehouse on the following conditions.

Temperature : -10 ~ +40°C

Humidity : 15 to 85% relative humidity No rapid change on temperature and humidity.

- Products should not be stored in corrosive gases, such as sulfurous, acid gases, alkaline gases, to prevent the following deterioration. Poor solderability due to the oxidized electrode.
- Products should be stored on the palette for the prevention of the influence from humidity, dust and so on.
- Products should be stored in the warehouse without heat shock, vibration, direct sunlight and so on.
- Avoid storing the product by itself bare (i.e. exposed directly to air).

(3) Delivery

Care should be taken when transporting or handling product to avoid excessive vibration or mechanical shock.

13. Notes

- (1) Please make sure that your product has been evaluated in view of your specifications with our product being mounted to your product.
- (2) You are requested not to use our product deviating from the reference specifications.
- (3) The contents of this reference specification are subject to change without advance notice. Please approve our product specifications or transact the approval sheet for product specifications before ordering.

X-ON Electronics

Largest Supplier of Electrical and Electronic Components

Click to view similar products for [Signal Conditioning category](#):

Click to view products by [Murata manufacturer](#):

Other Similar products are found below :

[MAPDCC0001](#) [MAPDCC0004](#) [PD0409J5050S2HF](#) [880157](#) [HHS-109-PIN](#) [DC1417J5005AHF](#) [AFS14A30-2185.00-T3](#) [AFS14A35-1591.50-T3](#) [DS-323-PIN](#) [B39321R801H210](#) [1A0220-3](#) [JP510S](#) [LFB212G45SG8C341](#) [LFB322G45SN1A504](#) [LFL182G45TC3B746](#) [SF2159E](#) [30057](#) [FM-104-PIN](#) [CER0813B](#) [MAPDCC0005](#) [3A325](#) [40287](#) [41180](#) [ATB3225-75032NCT](#) [BD0810N50100AHF](#) [BD2425J50200AHF](#) [C5060J5003AHF](#) [JHS-115-PIN](#) [JP503AS](#) [DC0710J5005AHF](#) [DC2327J5005AHF](#) [DC3338J5005AHF](#) [43020](#) [LFB2H2G60BB1C106](#) [LFL15869MTC1B787](#) [X3C19F1-20S](#) [XC3500P-20S](#) [10013-20](#) [SF2194E](#) [CDBLB455KCAX39-B0](#) [TGL2208-SM, EVAL](#) [RF1353C](#) [1E1305-3](#) [1F1304-3S](#) [1G1304-30](#) [B0922J7575AHF](#) [2020-6622-20](#) [TP-102-PIN](#) [TP-103-PIN](#) [BD1222J50200AHF](#)