

**Chip Monolithic Ceramic Capacitor for Automotive limited to Conductive Glue Mounting  
GCB155M91A153KE03\_ (0402, X9M:MURATA, 15000pF, DC10V)**

\_: packaging code

**Reference Sheet**

**1.Scope**

This product specification is applied to Chip Monolithic Ceramic Capacitor limited to Conductive Glue Mounting Type used for Automotive Electronic equipment with conductive glue mounting.

**2.MURATA Part NO. System**

|       |                      |                    |                                   |                     |                           |                             |                             |                   |   |
|-------|----------------------|--------------------|-----------------------------------|---------------------|---------------------------|-----------------------------|-----------------------------|-------------------|---|
| (Ex.) | GCB                  | 15                 | 5                                 | M9                  | 1A                        | 153                         | K                           | E03               | D |
|       | (1)L/W<br>Dimensions | (2)T<br>Dimensions | (3)Temperature<br>Characteristics | (4)Rated<br>Voltage | (5)Nominal<br>Capacitance | (6)Capacitance<br>Tolerance | (7)Murata's Control<br>Code | (8)Packaging Code |   |

**3. Type & Dimensions**



(Unit:mm)

|         |          |          |              |          |
|---------|----------|----------|--------------|----------|
| (1)-1 L | (1)-2 W  | (2) T    | e            | g        |
| 1.0±0.1 | 0.5±0.05 | 0.5±0.05 | 0.15 to 0.35 | 0.3 min. |

**4.Rated value**

|  |                            |                         |                            |                                 |  |
|--|----------------------------|-------------------------|----------------------------|---------------------------------|--|
| (3) Temperature Characteristics<br>(Public STD Code):X9M(MURATA) |                            | (4)<br>Rated<br>Voltage | (5) Nominal<br>Capacitance | (6)<br>Capacitance<br>Tolerance | Specifications and Test<br>Methods<br>(Operating<br>Temp. Range) |
| Temp. coeff<br>or<br>Cap. Change                                 | Temp. Range<br>(Ref.Temp.) |                         |                            |                                 |  |
| -50 to 15 %  | -55 to 200 °C<br>(25 °C)   | DC 10 V                 | 15000 pF                   | ±10 %                           | -55 to 200 °C  |

**5.Package**

| mark | (8) Packaging             | Packaging Unit  |
|------|---------------------------|-----------------|
| D    | φ180mm Reel<br>PAPER W8P2 | 10000 pcs./Reel |
| J    | φ330mm Reel<br>PAPER W8P2 | 50000 pcs./Reel |

Product specifications in this catalog are as of Dec.14,2016,and are subject to change or obsolescence without notice.  
Please consult the approval sheet before ordering.  
Please read rating and !Cautions first.

| No                               | AEC-Q200 Test Item                     | Specification.  | AEC-Q200 Test Method   |            |                           |            |   |   |            |                          |            |                           |            |             |        |   |        |   |
|----------------------------------|--|---|--|------------|---------------------------|------------|---|---|------------|--------------------------|------------|---------------------------|------------|-------------|--------|---|--------|---|
| 1                                | Pre-and Post-Stress<br>Electrical Test |   | -  |            |                           |            |   |   |            |                          |            |                           |            |             |        |   |        |   |
| 2                                | High Temperature<br>Exposure (Storage) | The measured and observed characteristics should satisfy the specifications in the following table. | Mount the capacitor on the test jig using a conductive glue.<br>(Refer to No.16 as for conductive glue.)<br>Set the capacitor for 1000+/-12h at 150±3°C(for R9) , 200+/-3°C(for M9).<br><br>• Initial measurement<br>Perform a heat treatment at 150+0/-10 °Cfor 1h and then sit for 24+/-2h at room temperature.<br>Perform the initial measurement.<br>• Measurement after test<br>Sit for 24+/-2h at room temperature, then measure.  |            |                           |            |   |   |            |                          |            |                           |            |             |        |   |        |   |
|                                  | Appearance                             | No marking defects  |  |            |                           |            |   |   |            |                          |            |                           |            |             |        |   |        |   |
|                                  | Capacitance<br>Change                  | Within ±10%   |  |            |                           |            |   |   |            |                          |            |                           |            |             |        |   |        |   |
|                                  | Dissipation<br>Factor                  | 0.2max  |  |            |                           |            |   |   |            |                          |            |                           |            |             |        |   |        |   |
|                                  | Insulation<br>Resistance<br>25°C       | Within the specified initial value.   |  |            |                           |            |   |   |            |                          |            |                           |            |             |        |   |        |   |
| 3                                | Temperature Cycling                    | The measured and observed characteristics should satisfy the specifications in the following table. | Mount the capacitor on the test jig using a conductive glue.<br>(Refer to No.16 as for conductive glue.)<br>Perform the 1000 cycles test according to the four heat treatments listed in the following table.<br><table border="1" style="margin-left: 20px;"> <thead> <tr> <th>Step</th> <th>1</th> <th>2</th> <th>3</th> <th>4</th> </tr> </thead> <tbody> <tr> <td>Temp. (°C)</td> <td>Min.Operating Temp.+0/-3</td> <td>Room Temp.</td> <td>Max.Operating Temp. +3/-0</td> <td>Room Temp.</td> </tr> <tr> <td>Time (min.)</td> <td>15+/-3</td> <td>1</td> <td>15+/-3</td> <td>1</td> </tr> </tbody> </table> • Initial measurement<br>Perform a heat treatment at 150+0/-10 °Cfor 1h and then sit for 24+/-2h at room temperature.<br>Perform the initial measurement.<br>• Measurement after test<br>Sit for 24+/-2h at room temperature, then measure. | Step       | 1                         | 2          | 3 | 4 | Temp. (°C) | Min.Operating Temp.+0/-3 | Room Temp. | Max.Operating Temp. +3/-0 | Room Temp. | Time (min.) | 15+/-3 | 1 | 15+/-3 | 1 |
|                                  | Step                                   | 1   |  | 2          | 3                         | 4          |   |   |            |                          |            |                           |            |             |        |   |        |   |
|                                  | Temp. (°C)                             | Min.Operating Temp.+0/-3  |  | Room Temp. | Max.Operating Temp. +3/-0 | Room Temp. |   |   |            |                          |            |                           |            |             |        |   |        |   |
|                                  | Time (min.)                            | 15+/-3  |  | 1          | 15+/-3                    | 1          |   |   |            |                          |            |                           |            |             |        |   |        |   |
|                                  | Appearance                             | No marking defects  |  |            |                           |            |   |   |            |                          |            |                           |            |             |        |   |        |   |
| Capacitance<br>Change            | Within ±7.5%                           |   |  |            |                           |            |   |   |            |                          |            |                           |            |             |        |   |        |   |
| Dissipation<br>Factor            | 0.2max                                 |   |  |            |                           |            |   |   |            |                          |            |                           |            |             |        |   |        |   |
| Insulation<br>Resistance<br>25°C | Within the specified initial value.    |   |  |            |                           |            |   |   |            |                          |            |                           |            |             |        |   |        |   |
| 4                                | Destructive<br>Physical Analysis       | No defects or abnormalities   | Per EIA-469  |            |                           |            |   |   |            |                          |            |                           |            |             |        |   |        |   |
| 5                                | Moisture Resistance                    | specifications in the following table.  | Mount the capacitor on the test jig using a conductive glue.<br>(Refer to No.16 as for conductive glue.)<br>Apply the 24h heat (25 to 65°C) and humidity (80 to 98%) treatment shown below, 10 consecutive times.<br> <p style="text-align: center;">One cycle 24hours</p> • Initial measurement<br>Perform a heat treatment at 150+0/-10 °Cfor 1h and then sit for 24+/-2h at room temperature.<br>Perform the initial measurement.<br>• Measurement after test<br>Perform a heat treatment at 150+0/-10°C for 1h and then let sit for 24+/-2h at room temperature, then measure.   |            |                           |            |   |   |            |                          |            |                           |            |             |        |   |        |   |
|                                  | Appearance                             | No marking defects  |  |            |                           |            |   |   |            |                          |            |                           |            |             |        |   |        |   |
|                                  | Capacitance<br>Change                  | Within ±10%   |  |            |                           |            |   |   |            |                          |            |                           |            |             |        |   |        |   |
|                                  | Dissipation<br>Factor                  | 0.2max  |  |            |                           |            |   |   |            |                          |            |                           |            |             |        |   |        |   |
|                                  | Insulation<br>Resistance<br>25°C       | Within the specified initial value.   |  |            |                           |            |   |   |            |                          |            |                           |            |             |        |   |        |   |

| No                         | AEC-Q200 Test Item         | Specification.  | AEC-Q200 Test Method   |                                     |  |
|----------------------------|----------------------------|---|--|-------------------------------------|--|
| 6                          | Biased Humidity            | The measured and observed characteristics should satisfy the specifications in the following table. | Mount the capacitor on the test jig using a conductive glue.<br>(Refer to No.16 as for conductive glue.)<br>Apply the rated voltage and 1.3+0.2/-0vdc (add 6.8kΩ resistor)<br>at 85+/-3°C and 80 to 85% humidity for 1000+/-12h.<br>The charge/discharge current is less than 50mA.<br><br>• Initial measurement<br>Perform a heat treatment at 150+0/-10 °Cfor 1h and then sit for 24+/-2h at room temperature.<br>Perform the initial measurement.<br>• Measurement after test<br>Perform a heat treatment at 150+0/-10°C for 1h and then let sit for 24+/-2h at room temperature, then measure. |                                     |  |
|                            | Appearance                 | No marking defects  |  |                                     |  |
|                            | Capacitance Change         | Within ±10%   |  |                                     |  |
|                            | Dissipation Factor         | 0.2 max   |  |                                     |  |
| 7                          | Operational Life           | The measured and observed characteristics should satisfy the specifications in the following table. | Mount the capacitor on the test jig using a conductive glue.<br>(Refer to No.16 as for conductive glue.)<br>Apply 150% of the rated voltage for 1000+/-12h at Max.Operating Temp. +/-3°C.The charge/discharge current is less than 50mA.<br><br>• Initial measurement<br>Perform a heat treatment at 150+0/-10 °Cfor 1h and then sit for 24+/-2h at room temperature.<br>Perform the initial measurement.<br>• Measurement after test<br>Perform a heat treatment at 150+0/-10°C for 1h and then let sit for 24+/-2h at room temperature, then measure.  |                                     |  |
|                            | Appearance                 | No marking defects  |  |                                     |  |
|                            | Capacitance Change         | Within ±12.5%   |  |                                     |  |
|                            | Dissipation Factor         | 0.2max  |  |                                     |  |
| 8                          | External Visual            | No defects or abnormalities   | Visual inspection  |                                     |  |
|                            | Physical Dimension         | Within the specified dimensions   |  |                                     |  |
|                            | 10                         | Resistance to Solvents  |  | Appearance                          | Per MIL-STD-202 Method 215<br>Solvent 1 : 1 part (by volume) of isopropyl alcohol<br>3 parts (by volume) of mineral spirits<br>Solvent 2 : Terpene defluxer<br>Solvent 3 : 42 parts (by volume) of water<br>1part (by volume) of propylene glycol monomethyl ether<br>1 part (by volume) of monoethanolamine |
|                            |                            | Capacitance   |  | Within the specified initial value. |  |
| Dissipation Factor         |                            | Within the specified initial value.   |  |                                     |  |
| Insulation Resistance 25°C |                            | Within the specified initial value.   |  |                                     |  |
| 11                         | Mechanical Shock           | Appearance  | Mount the capacitor on the test jig using a conductive glue.<br>(Refer to No.16 as for conductive glue.)<br>Three shocks in each direction should be applied along 3 mutually perpendicular axes of the test specimen (18 shocks).<br>The specified test pulse should be Half-sine and should have a duration :0.5ms, peak value:1500g and velocity change: 4.7m/s.  |                                     |  |
|                            | Capacitance                | Within the specified initial value.   |  |                                     |  |
|                            | Dissipation Factor         | Within the specified initial value.   |  |                                     |  |
|                            | Insulation Resistance 25°C | Within the specified initial value.   |  |                                     |  |
| 12                         | Vibration                  | Appearance  | Mount the capacitor on the test jig using a conductive glue.<br>(Refer to No.16 as for conductive glue.)<br>The capacitor should be subjected to a simple harmonic motion having a total amplitude of 1.5mm, the frequency being varied uniformly between the approximate limits of 10 and 2000Hz.<br>The frequency range, from 10 to 2000Hz and return to 10Hz, should be traversed in approximately 20 minutes.<br>This motion should be applied for 12 items in each 3 mutually perpendicular directions (total of 36 times).   |                                     |  |
|                            | Capacitance                | Within the specified initial value.   |  |                                     |  |
|                            | Dissipation Factor         | Within the specified initial value.   |  |                                     |  |
|                            | Insulation Resistance 25°C | Within the specified initial value.   |  |                                     |  |

| No                                  | AEC-Q200 Test Item                                | Specification.  | AEC-Q200 Test Method  |                          |               |               |           |                          |                          |             |              |            |         |               |               |               |
|-------------------------------------|---|---|---|--------------------------|---------------|---------------|-----------|--------------------------|--------------------------|-------------|--------------|------------|---------|---------------|---------------|---------------|
| 13                                  | Thermal Shock                                     | The measured and observed characteristics shall satisfy the specifications in the following table.  | Mount the capacitor on the test jig using a conductive glue.<br>(Refer to No.16 as for conductive glue.)<br>Perform the 300 cycles according to the two heat treatments listed in the following table(Maximum transfer time is 20s). <table border="1" style="margin: 10px 0;"> <thead> <tr> <th>Step</th> <th>1</th> <th>2</th> </tr> </thead> <tbody> <tr> <td>Temp.(°C)</td> <td>Min.Operating Temp.+0/-3</td> <td>Max.Operating Temp.+3/-0</td> </tr> <tr> <td>Time (min.)</td> <td>15+/-3</td> <td>15+/-3</td> </tr> </tbody> </table> • Initial measurement<br>Perform a heat treatment at 150+0/-10 °Cfor 1h and then sit for 24+/-2h at room temperature.<br>• Measurement after test<br>Sit for 24+/-2h at room temperature, then measure. | Step                     | 1             | 2             | Temp.(°C) | Min.Operating Temp.+0/-3 | Max.Operating Temp.+3/-0 | Time (min.) | 15+/-3       | 15+/-3     |         |               |               |               |
|                                     | Step  | 1   |   | 2                        |               |               |           |                          |                          |             |              |            |         |               |               |               |
|                                     | Temp.(°C)   | Min.Operating Temp.+0/-3  |   | Max.Operating Temp.+3/-0 |               |               |           |                          |                          |             |              |            |         |               |               |               |
|                                     | Time (min.)                                       | 15+/-3  |   | 15+/-3                   |               |               |           |                          |                          |             |              |            |         |               |               |               |
| Appearance                          | No marking defects                                |   |   |                          |               |               |           |                          |                          |             |              |            |         |               |               |               |
| Capacitance Change                  | Within ±10.0%                                     |   |   |                          |               |               |           |                          |                          |             |              |            |         |               |               |               |
| 14                                  | ESD   | Appearance  | Per AEC-Q200-002  |                          |               |               |           |                          |                          |             |              |            |         |               |               |               |
|                                     |   | Capacitance   |   |                          |               |               |           |                          |                          |             |              |            |         |               |               |               |
|                                     |   | Dissipation Factor  |   |                          |               |               |           |                          |                          |             |              |            |         |               |               |               |
|                                     |   | Insulation Resistance 25°C  |   |                          |               |               |           |                          |                          |             |              |            |         |               |               |               |
| 15                                  | Electrical Chatacterization                       | Appearance  | Visual inspection.<br>The capacitance/D.F. should be measured at 25°C at the frequency and voltage shown in the table. <table border="1" style="margin: 10px 0;"> <thead> <tr> <th rowspan="2">Char.<br/>Item</th> <th colspan="2">C ≤ 10μF</th> <th rowspan="2">10μF &lt; C</th> </tr> <tr> <th>6.3V max.</th> <th>10V min.</th> </tr> </thead> <tbody> <tr> <td>Frequency</td> <td>1.0+/-0.1kHz</td> <td>120+/-24Hz</td> </tr> <tr> <td>Voltage</td> <td>0.5+/-0.1Vrms</td> <td>1.0+/-0.2Vrms</td> <td>0.5+/-0.1Vrms</td> </tr> </tbody> </table>   | Char.<br>Item            | C ≤ 10μF      |               | 10μF < C  | 6.3V max.                | 10V min.                 | Frequency   | 1.0+/-0.1kHz | 120+/-24Hz | Voltage | 0.5+/-0.1Vrms | 1.0+/-0.2Vrms | 0.5+/-0.1Vrms |
|                                     |   | Char.<br>Item   |   |                          | C ≤ 10μF      |               |           | 10μF < C                 |                          |             |              |            |         |               |               |               |
|                                     |   |   |   | 6.3V max.                | 10V min.      |               |           |                          |                          |             |              |            |         |               |               |               |
|                                     |   | Frequency   |   | 1.0+/-0.1kHz             | 120+/-24Hz    |               |           |                          |                          |             |              |            |         |               |               |               |
|                                     |   | Voltage   |   | 0.5+/-0.1Vrms            | 1.0+/-0.2Vrms | 0.5+/-0.1Vrms |           |                          |                          |             |              |            |         |               |               |               |
|                                     |   | Capacitance   |   | Shown in Rated value.    |               |               |           |                          |                          |             |              |            |         |               |               |               |
|                                     |   | Dissipation Factor  |   | 0.1max                   |               |               |           |                          |                          |             |              |            |         |               |               |               |
| Insulation Resistance 25 °C         | More than 2,000MΩ or 50Ω·F (Whichever is smaller) |   |   |                          |               |               |           |                          |                          |             |              |            |         |               |               |               |
| Insulation Resistance 150°C(for R9) | More than 200MΩ or 5Ω·F (Whichever is smaller)    |   |   |                          |               |               |           |                          |                          |             |              |            |         |               |               |               |
| Insulation Resistance 200°C(for M9) | More than 0.5MΩ or 0.1Ω·F (Whichever is smaller)  |   |   |                          |               |               |           |                          |                          |             |              |            |         |               |               |               |
| Dielectric Strength                 | No failure  | No failure should be observed when 250% of the rated voltage is applied between the terminations for 1 to 5s, provided the charge/ discharge current is less than 50mA. |   |                          |               |               |           |                          |                          |             |              |            |         |               |               |               |

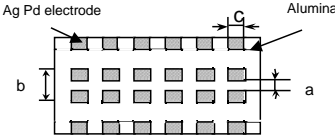
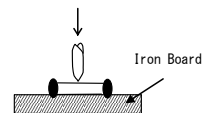
| No                         | AEC-Q200 Test Item                      |                    | Specification.  | AEC-Q200 Test Method  |      |                 |       |                     |       |                          |      |                     |   |                          |       |                     |      |      |       |      |      |      |
|----------------------------|---|--------------------|---|---|------|-----------------|-------|---------------------|-------|--------------------------|------|---------------------|---|--------------------------|-------|---------------------|------|------|-------|------|------|------|
| 16                         | Terminal Strength                       | Appearance         | No marking defects  | Mount the capacitor on the test jig in Fig.1 using a conductive glue (Equivalent to H9626 made by NAMICS).<br>The conductive glue is hardened at 200°C for 60minutes.<br>Then apply *shear tension in parallel with the test jig for 60seconds.<br><br>*Show in the table 1<br><table border="1" style="margin-left: auto; margin-right: auto;"> <thead> <tr> <th>Type</th> <th>Share Tension</th> </tr> </thead> <tbody> <tr> <td>GCB15</td> <td>2. 0N</td> </tr> <tr> <td>GCB18</td> <td>2. 7N</td> </tr> </tbody> </table> <p style="text-align: center;">Tab l e. 1</p>  <table border="1" style="margin-left: auto; margin-right: auto;"> <thead> <tr> <th>Type</th> <th>a</th> <th>b</th> <th>c</th> </tr> </thead> <tbody> <tr> <td>GCB15</td> <td>0. 4</td> <td>1. 5</td> <td>0. 5</td> </tr> <tr> <td>GCB18</td> <td>1. 0</td> <td>3. 0</td> <td>1. 2</td> </tr> </tbody> </table> <p style="text-align: center;">Fig. 1 (in mm)</p> | Type | Share Tension   | GCB15 | 2. 0N               | GCB18 | 2. 7N                    | Type | a                   | b | c                        | GCB15 | 0. 4                | 1. 5 | 0. 5 | GCB18 | 1. 0 | 3. 0 | 1. 2 |
|                            |   | Type               | Share Tension   |   |      |                 |       |                     |       |                          |      |                     |   |                          |       |                     |      |      |       |      |      |      |
|                            |   | GCB15              | 2. 0N   |   |      |                 |       |                     |       |                          |      |                     |   |                          |       |                     |      |      |       |      |      |      |
|                            |   | GCB18              | 2. 7N   |   |      |                 |       |                     |       |                          |      |                     |   |                          |       |                     |      |      |       |      |      |      |
| Type                       | a                                       | b                  | c   |   |      |                 |       |                     |       |                          |      |                     |   |                          |       |                     |      |      |       |      |      |      |
| GCB15                      | 0. 4                                    | 1. 5               | 0. 5  |   |      |                 |       |                     |       |                          |      |                     |   |                          |       |                     |      |      |       |      |      |      |
| GCB18                      | 1. 0                                    | 3. 0               | 1. 2  |   |      |                 |       |                     |       |                          |      |                     |   |                          |       |                     |      |      |       |      |      |      |
| Capacitance                | Within the specified initial value.     |                    |   |   |      |                 |       |                     |       |                          |      |                     |   |                          |       |                     |      |      |       |      |      |      |
| Dissipation Factor         | Within the specified initial value.     |                    |   |   |      |                 |       |                     |       |                          |      |                     |   |                          |       |                     |      |      |       |      |      |      |
| Insulation Resistance 25°C | Within the specified initial value.     |                    |   |   |      |                 |       |                     |       |                          |      |                     |   |                          |       |                     |      |      |       |      |      |      |
| 17                         | Beam Load Test                          |                    | Destruction value should be exceed following one.<br><br>< Chip L dimension : 2.5mm max. ><br>Chip thickness > 0.5mm rank : 20N<br>Chip thickness = 0.5mm rank : 8N | Place the capacitor in the beam load fixture as Fig 2.<br>Apply a force.<br>< Chip Length : 2.5mm max. ><br><br> <p style="text-align: center;">Fig.2</p> Speed supplied the Stress Load : 0.5mm/s   |      |                 |       |                     |       |                          |      |                     |   |                          |       |                     |      |      |       |      |      |      |
| 18                         | Capacitance Temperature Characteristics | Capacitance Change | R9 : Within +/-15%<br>(-55°C to +150°C)<br>M9 : Within +15 / -50%<br>(-55°C to +200°C)  | The capacitance change should be measured after 5 minutes at each specified temperature stage.<br>Capacitance value as a reference is the value in step 3.<br><br><table border="1" style="margin-left: auto; margin-right: auto;"> <thead> <tr> <th>Step</th> <th>Temperature(°C)</th> </tr> </thead> <tbody> <tr> <td>1</td> <td>Reference Temp.+/-2</td> </tr> <tr> <td>2</td> <td>Min. Operating Temp.+/-3</td> </tr> <tr> <td>3</td> <td>Reference Temp.+/-2</td> </tr> <tr> <td>4</td> <td>Max. Operating Temp.+/-3</td> </tr> <tr> <td>5</td> <td>Reference Temp.+/-2</td> </tr> </tbody> </table> <ul style="list-style-type: none"> <li>• Initial measurement</li> </ul> Perform a heat treatment at 150+0/-10 °Cfor 1h and then sit for 24+/-2h at room temperature.<br>Perform the initial measurement.  | Step | Temperature(°C) | 1     | Reference Temp.+/-2 | 2     | Min. Operating Temp.+/-3 | 3    | Reference Temp.+/-2 | 4 | Max. Operating Temp.+/-3 | 5     | Reference Temp.+/-2 |      |      |       |      |      |      |
| Step                       | Temperature(°C)                         |                    |   |   |      |                 |       |                     |       |                          |      |                     |   |                          |       |                     |      |      |       |      |      |      |
| 1                          | Reference Temp.+/-2                     |                    |   |   |      |                 |       |                     |       |                          |      |                     |   |                          |       |                     |      |      |       |      |      |      |
| 2                          | Min. Operating Temp.+/-3                |                    |   |   |      |                 |       |                     |       |                          |      |                     |   |                          |       |                     |      |      |       |      |      |      |
| 3                          | Reference Temp.+/-2                     |                    |   |   |      |                 |       |                     |       |                          |      |                     |   |                          |       |                     |      |      |       |      |      |      |
| 4                          | Max. Operating Temp.+/-3                |                    |   |   |      |                 |       |                     |       |                          |      |                     |   |                          |       |                     |      |      |       |      |      |      |
| 5                          | Reference Temp.+/-2                     |                    |   |   |      |                 |       |                     |       |                          |      |                     |   |                          |       |                     |      |      |       |      |      |      |

1. Tape Carrier Packaging(Packaging Code:D/E/F/J)

1.1 Minimum Quantity(pcs./reel)

| Type  |   | φ180mm reel | φ330mm reel |
|-------|---|-------------|-------------|
|       |   | Paper Tape  |             |
|       |   | Code:D/E    | Code:J/ F   |
| GCB15 | 5 | 10000       | 50000       |
| GCB18 | 8 | 4000        | 10000       |

1.2 Dimensions of Tape

(1)GCB15 <Paper Tape>

(in:mm)

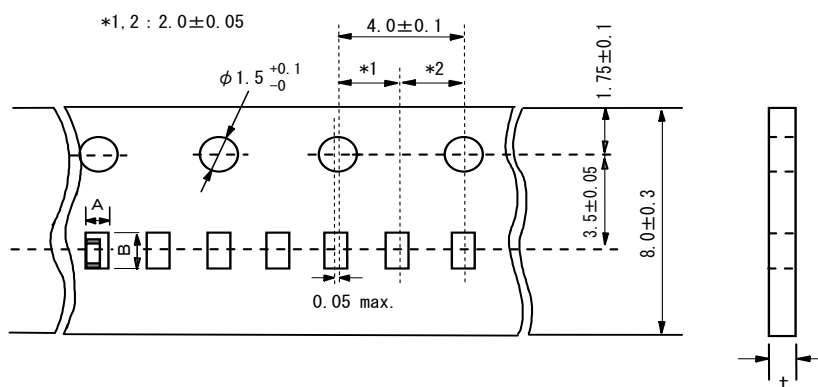

| Type  |   | Dimensions(Chip) |          |          | A *3 | B *3 | t        |
|-------|---|------------------|----------|----------|------|------|----------|
|       |   | L                | W        | T        |      |      |          |
| GCB15 | 5 | 1.0±0.1          | 0.5±0.05 | 0.5±0.05 | 0.65 | 1.15 | 0.8 max. |

\*3 Nominal value

(3)GCB18 <Paper Tape>

(in:mm)

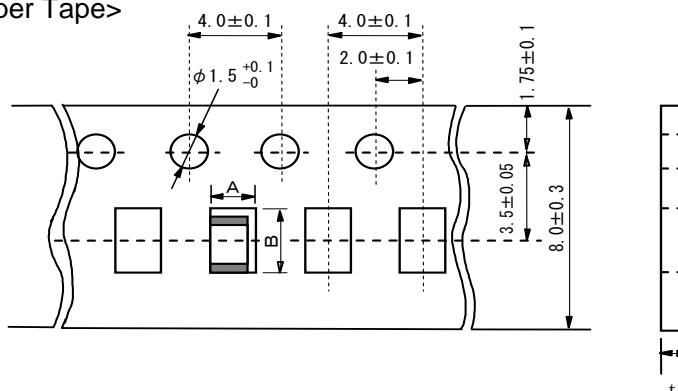

| Type  |   | Dimensions(Chip) |         |         | A         | B         | t        |
|-------|---|------------------|---------|---------|-----------|-----------|----------|
|       |   | L                | W       | T       |           |           |          |
| GCB18 | 8 | 1.6±0.2          | 0.8±0.1 | 0.8±0.1 | 1.05±0.10 | 1.85±0.10 | 1.1 max. |

Fig.1 Package Chips

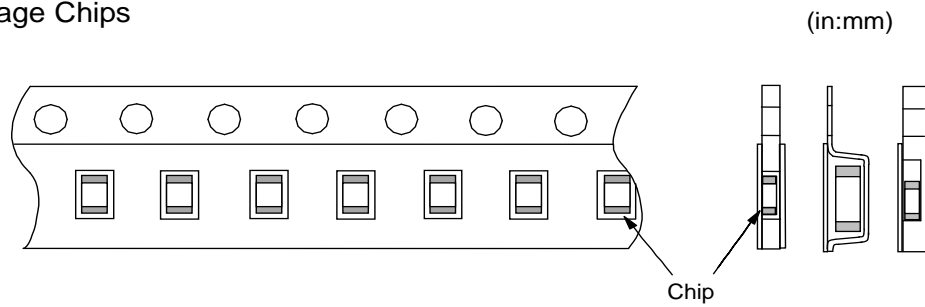

Fig.2 Dimensions of Reel



Fig.3 Taping Diagram

|            | W         | w <sub>1</sub> |
|------------|-----------|----------------|
| GCB18 max. | 16.5 max. | 10±1.5         |



1.3 Tapes for capacitors are wound clockwise shown in Fig.3.  
(The sprocket holes are to the right as the tape is pulled toward the user.)

1.4 Part of the leader and part of the vacant section are attached as follows.



1.5 Accumulate pitch : 10 of sprocket holes pitch =  $40 \pm 0.3$ mm

1.6 Chip in the tape is enclosed by top tape and bottom tape as shown in Fig.1.

1.7 The top tape and base tape are not attached at the end of the tape for a minimum of 5 pitches.

1.8 There are no jointing for top tape and bottom tape.

1.9 There are no fuzz in the cavity.

1.10 Break down force of top tape : 5N min.

Break down force of bottom tape : 5N min. (Only a bottom tape existence )

1.11 Reel is made by resin and appeaser and dimension is shown in Fig 2.

There are possibly to change the material and dimension due to some impairment.

1.12 Peeling off force : 0.1N to 0.6N in the direction as shown below.



1.13 Label that show the customer parts number, our parts number, our company name, inspection number and quantity, will be put in outside of reel.



■ Limitation of Applications

Please contact us before using our products for the applications listed below which require especially high reliability for the prevention of defects which might directly cause damage to the third party's life, body or property.

- ①Aircraft equipment    ②Aerospace equipment    ③Undersea equipment    ④Power plant control equipment
- ⑤Medical equipment    ⑥Transportation equipment(vehicles,trains,ships,etc.)    ⑦Traffic signal equipment
- ⑧Disaster prevention / crime prevention equipment    ⑨Data-processing equipment
- ⑩Application of similar complexity and/or reliability requirements to the applications listed in the above.

■ Storage and Operation condition

1. If store the chip monolithic ceramic capacitors in an atmosphere consisting of high temperature or humidity, sulfur or chlorine gases, contaminants attach to the surface of external electrode, and bondability with conductive glue may deteriorate. Do not store the capacitors in an atmosphere consisting of corrosive gas (e.g., hydrogen sulfide, sulfur dioxide, chlorine, ammoria gas, etc.). Storage environment must be at room temperature of +5°C to +40°C and a relative humidity of 20% to 70%, and use the product within six months after receipt.

In case of packaging, do not open the last wrappend, polyethylene bag, till just before using. After unpacking, immediately reseal, or store in a desiccator containing a desiccant.

2. Due to moisture condensation caused by rapid humidity changes, or the photochemical change caused by direct sunlight on the terminal electrodes and/or the resin/epoxy coatings, the bondability with conductive glue and electrical performance may deteriorate. Do not store capacitors under direct sunlight or in high humidity conditions.

3. This product is chip monolithic ceramic capacitor limited to conductive glue mounting. Do not apply mounting method other than conductive glue. Flow or reflow soldering can result in a lack of adhesive strength on the outer electrode by poor wettability, which may result in chips breaking loose from the PCB.

■ Rating

1. Temperature Dependent Characteristics

1. The electrical characteristics of the capacitor can change with temperature.

1-1. For capacitors having larger temperature dependency, the capacitance may change with temperature changes. The following actions are recommended in order to ensure suitable capacitance values.

- (1) Select a suitable capacitance for the operating temperature range.
- (2) The capacitance may change within the rated temperature.

When you use a high dielectric constant type capacitor in a circuit that needs a tight (narrow) capacitance tolerance (e.g., a time-constant circuit), please carefully consider the temperature characteristics, and carefully confirm the various characteristics in actual use conditions and the actual system.

[Example of Temperature Characteristics X7R(R7)]

Sample: 0.1μF, Rated Voltage 50VDC

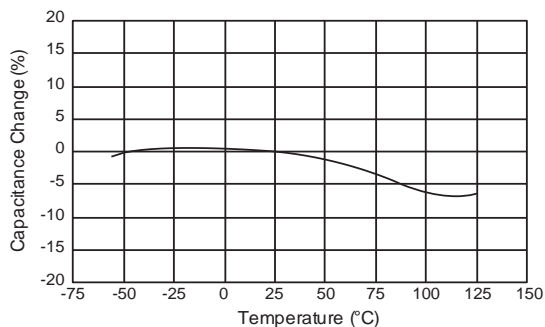

[Example of Temperature Characteristics X5R(R6)]

Sample: 22μF, Rated Voltage 4VDC

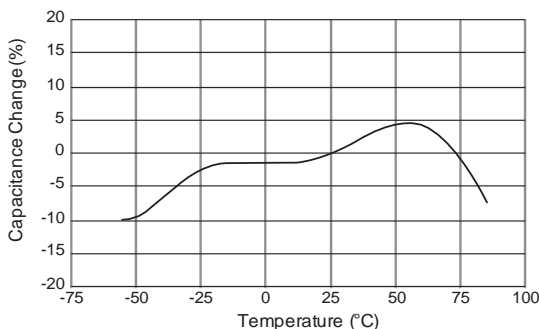

## 2.Measurement of Capacitance

1. Measure capacitance with the voltage and frequency specified in the product specifications.
  - 1-1. The output voltage of the measuring equipment may decrease occasionally when capacitance is high. Please confirm whether a prescribed measured voltage is impressed to the capacitor.
  - 1-2. The capacitance values of high dielectric constant type capacitors change depending on the AC voltage applied. Please consider the AC voltage characteristics when selecting a capacitor to be used in a AC circuit.

## 3.Applied Voltage

1. Do not apply a voltage to the capacitor that exceeds the rated voltage as called out in the specifications.
  - 1-1. Applied voltage between the terminals of a capacitor shall be less than or equal to the rated voltage.
    - (1) When AC voltage is superimposed on DC voltage, the zero-to-peak voltage shall not exceed the rated DC voltage. When AC voltage or pulse voltage is applied, the peak-to-peak voltage shall not exceed the rated DC voltage.
    - (2) Abnormal voltages (surge voltage, static electricity, pulse voltage, etc.) shall not exceed the rated DC voltage.

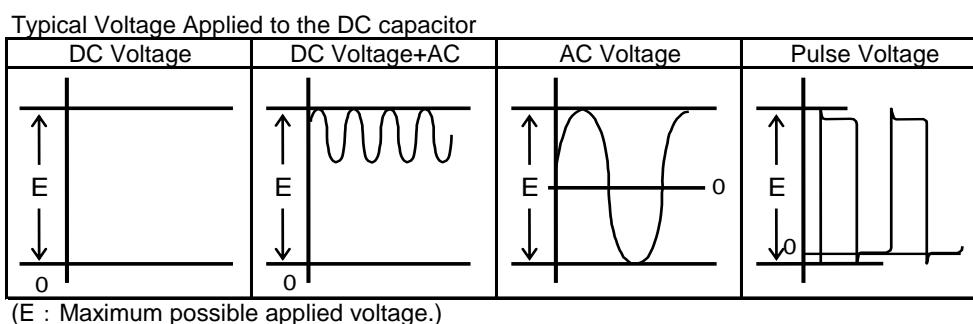

- 1-2. Influence of over voltage
 

Over voltage that is applied to the capacitor may result in an electrical short circuit caused by the breakdown of the internal dielectric layers .

The time duration until breakdown depends on the applied voltage and the ambient temperature.

## 4.Type of Applied Voltage and Self-heating Temperature

- 1.Confirm the operating conditions to make sure that no large current is flowing into the capacitor due to the continuous application of an AC voltage or pulse voltage.
 

When a DC rated voltage product is used in an AC voltage circuit or a pulse voltage circuit, the AC current or pulse current will flow into the capacitor; therefore check the self-heating condition.

Please confirm the surface temperature of the capacitor so that the temperature remains within the upper limits of the operating temperature, including the rise in temperature due to self-heating. When the capacitor is used with a high-frequency voltage or pulse voltage, heat may be generated by dielectric loss.

- <Applicable to Rated Voltage of less than 100VDC>
- 1-1. The load should be contained to the level such that when measuring at atmospheric temperature of 25°C, the product's self-heating remains below 20°C and the surface temperature of the capacitor in the actual circuit remains within the maximum operating temperature.

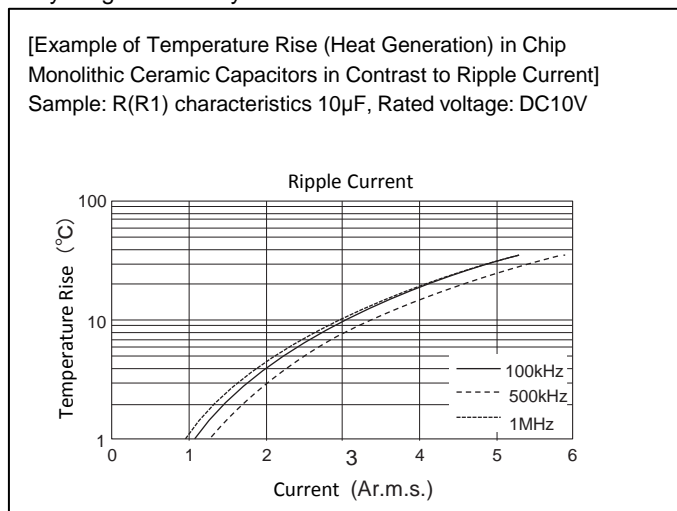

### 5. DC Voltage and AC Voltage Characteristic

1. The capacitance value of a high dielectric constant type capacitor changes depending on the DC voltage applied. Please consider the DC voltage characteristics when a capacitor is selected for use in a DC circuit.

1-1. The capacitance of ceramic capacitors may change sharply depending on the applied voltage. (See figure) Please confirm the following in order to secure the capacitance.

- (1) Determine whether the capacitance change caused by the applied voltage is within the allowed range .
- (2) In the DC voltage characteristics, the rate of capacitance change becomes larger as voltage increases, even if the applied voltage is below the rated voltage. When a high dielectric constant type capacitor is used in a circuit that requires a tight (narrow) capacitance tolerance (e.g., a time constant circuit), please carefully consider the voltage characteristics, and confirm the various characteristics in the actual operating conditions of the system.

2. The capacitance values of high dielectric constant type capacitors changes depending on the AC voltage applied. Please consider the AC voltage characteristics when selecting a capacitor to be used in a AC circuit.

[Example of DC Voltage Characteristics]

Sample: R(R1) Characteristics 0.1μF, Rated Voltage 50VDC

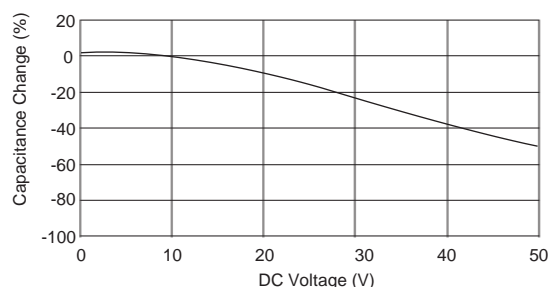

[Example of AC Voltage Characteristics]

Sample: X7R(R7) Characteristics 10μF, Rated Voltage 6.3VDC

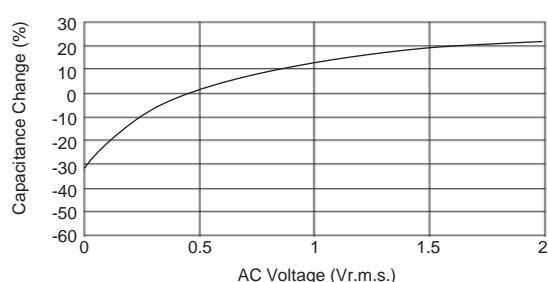

### 6. Capacitance Aging

1. The high dielectric constant type capacitors have an Aging characteristic in which the capacitance value decreases with the passage of time. When you use a high dielectric constant type capacitors in a circuit that needs a tight (narrow) capacitance tolerance (e.g., a time-constant circuit), please carefully consider the characteristics of these capacitors, such as their aging, voltage, and temperature characteristics. In addition, check capacitors using your actual appliances at the intended environment and operating conditions.

[ Example of Change Over Time (Aging characteristics) ]

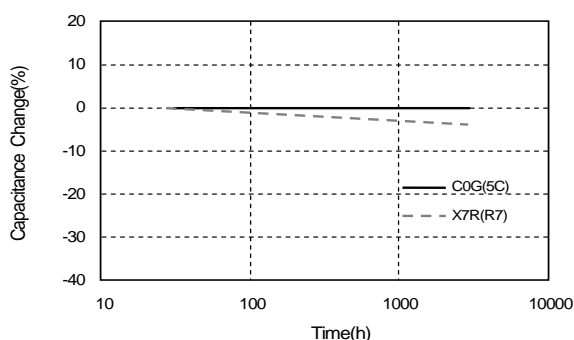

### 7.Vibration and Shock

1. Please confirm the kind of vibration and/or shock, its condition, and any generation of resonance. Please mount the capacitor so as not to generate resonance, and do not allow any impact on the terminals.

2. Mechanical shock due to being dropped may cause damage or a crack in the dielectric material of the capacitor. Do not use a dropped capacitor because the quality and reliability may be deteriorated.

3. When printed circuit boards are piled up or handled, the corner of another printed circuit board should not be allowed to hit the capacitor in order to avoid a crack or other damage to the capacitor.

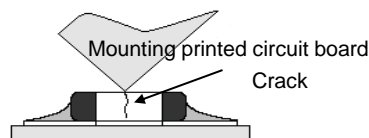
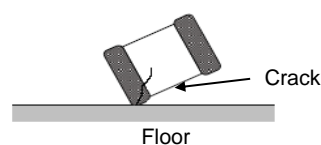

## ■ Mounting

### 1. Selection of Conductive Adhesive, Mounting Process, and Bonding Strength

- The acquired bonding strength may change greatly depending on the conductive adhesive to be used. Be sure to confirm the desired performance can be acquired in the assumed mounting process with the conductive adhesive to be used.

### 2. Maintenance of the Mounting (pick and place) Machine

- Make sure that the following excessive forces are not applied to the capacitors.
  - In mounting the capacitors on the printed circuit board, any bending force against them shall be kept to a minimum to prevent them from any damage or cracking. Please take into account the following precautions and recommendations for use in your process.
    - Adjust the lowest position of the pickup nozzle so as not to bend the printed circuit board.
    - Adjust the nozzle pressure within a static load of 1N to 3N during mounting.



- Dirt particles and dust accumulated between the suction nozzle and the cylinder inner wall prevent the nozzle from moving smoothly. This imposes greater force upon the chip during mounting, causing cracked chips. Also, the locating claw, when worn out, imposes uneven forces on the chip when positioning, causing cracked chips. The suction nozzle and the locating claw must be maintained, checked and replaced periodically.

### 3. Moisture proof

- To prevent the silver electrode migration, keep parts under low moisture condition with resin coating and the equivalent.

### 4. Coating

- A crack may be caused in the capacitor due to the stress of the thermal contraction of the resin during curing process. The stress is affected by the amount of resin and curing contraction. Select a resin with low curing contraction. The difference in the thermal expansion coefficient between a coating resin or a molding resin and the capacitor may cause the destruction and deterioration of the capacitor such as a crack or peeling, and lead to the deterioration of insulation resistance or dielectric breakdown. Select a resin for which the thermal expansion coefficient is as close to that of the capacitor as possible. A silicone resin can be used as an under-coating to buffer against the stress.
- Select a resin that is less hygroscopic. Using hygroscopic resins under high humidity conditions may cause the deterioration of the insulation resistance of a capacitor. An epoxy resin can be used as a less hygroscopic resin.
- The halogen system substance and organic acid are included in coating material, and a chip corrodes by the kind of Coating material. Do not use strong acid type.

## ■ Others

### 1. Under Operation of Equipment

- 1-1. Do not touch a capacitor directly with bare hands during operation in order to avoid the danger of an electric shock.
- 1-2. Do not allow the terminals of a capacitor to come in contact with any conductive objects (short-circuit).  
Do not expose a capacitor to a conductive liquid, inducing any acid or alkali solutions.
- 1-3. Confirm the environment in which the equipment will operate is under the specified conditions.  
Do not use the equipment under the following environments.
  - (1) Being splattered with water or oil.
  - (2) Being exposed to direct sunlight.
  - (3) Being exposed to ozone, ultraviolet rays, or radiation.
  - (4) Being exposed to toxic gas (e.g., hydrogen sulfide, sulfur dioxide, chlorine, ammonia gas etc.)
  - (5) Any vibrations or mechanical shocks exceeding the specified limits.
  - (6) Moisture condensing environments.
- 1-4. Use damp proof countermeasures if using under any conditions that can cause condensation.

### 2. Others

- 2-1. In an Emergency
  - (1) If the equipment should generate smoke, fire, or smell, immediately turn off or unplug the equipment.  
If the equipment is not turned off or unplugged, the hazards may be worsened by supplying continuous power.
  - (2) In this type of situation, do not allow face and hands to come in contact with the capacitor or burns may be caused by the capacitor's high temperature.
- 2-2. Disposal of waste  
When capacitors are disposed of, they must be burned or buried by an industrial waste vendor with the appropriate licenses.
- 2-3. Circuit Design
  - (1) Addition of Fail Safe Function  
Capacitors that are cracked by dropping or bending of the board may cause deterioration of the insulation resistance, and result in a short. If the circuit being used may cause an electrical shock, smoke or fire when a capacitor is shorted, be sure to install fail-safe functions, such as a fuse, to prevent secondary accidents.
  - (2) This series are not safety standard certified products.
- 2-4. Remarks  
Failure to follow the cautions may result, worst case, in a short circuit and smoking when the product is used.  
The above notices are for standard applications and conditions. Contact us when the products are used in special mounting conditions.  
Select optimum conditions for operation as they determine the reliability of the product after assembly.  
The data herein are given in typical values, not guaranteed ratings.

## ■ Rating

### **1. Operating Temperature**

1. The operating temperature limit depends on the capacitor.
  - 1-1. Do not apply temperatures exceeding the maximum operating temperature.  
It is necessary to select a capacitor with a suitable rated temperature that will cover the operating temperature range.  
It is also necessary to consider the temperature distribution in equipment and the seasonal temperature variable factor.
  - 1-2. Consider the self-heating factor of the capacitor  
The surface temperature of the capacitor shall not exceed the maximum operating temperature including self-heating.

### **2. Atmosphere Surroundings (gaseous and liquid)**

1. Restriction on the operating environment of capacitors.
  - 1-1. Capacitors, when used in the above, unsuitable, operating environments may deteriorate due to the corrosion of the terminations and the penetration of moisture into the capacitor.
  - 1-2. The same phenomenon as the above may occur when the electrodes or terminals of the capacitor are subject to moisture condensation.
  - 1-3. The deterioration of characteristics and insulation resistance due to the oxidization or corrosion of terminal electrodes may result in breakdown when the capacitor is exposed to corrosive or volatile gases or solvents for long periods of time.

### **3. Piezo-electric Phenomenon**

1. When using high dielectric constant type capacitors in AC or pulse circuits, the capacitor itself vibrates at specific frequencies and noise may be generated.  
Moreover, when the mechanical vibration or shock is added to capacitor, noise may occur.

## ■ Others

### 1. Transportation

1. The performance of a capacitor may be affected by the conditions during transportation.

1-1. The capacitors shall be protected against excessive temperature, humidity and mechanical force during transportation.

(1) Climatic condition

- low air temperature : -40°C
- change of temperature air/air : -25°C/+25°C
- low air pressure : 30 kPa
- change of air pressure : 6 kPa/min.

(2) Mechanical condition

Transportation shall be done in such a way that the boxes are not deformed and forces are not directly passed on to the inner packaging.

1-2. Do not apply excessive vibration, shock, or pressure to the capacitor.

(1) When excessive mechanical shock or pressure is applied to a capacitor, chipping or cracking may occur in the ceramic body of the capacitor.

(2) When the sharp edge of an air driver, tweezers, a chassis, etc. impacts strongly on the surface of the capacitor, the capacitor may crack and short-circuit.

1-3. Do not use a capacitor to which excessive shock was applied by dropping etc.  
A capacitor dropped accidentally during processing may be damaged.

### 2. Characteristics Evaluation in the Actual System

1. Evaluate the capacitor in the actual system, to confirm that there is no problem with the performance and specification values in a finished product before using.

2. Since a voltage dependency and temperature dependency exists in the capacitance of high dielectric type ceramic capacitors, the capacitance may change depending on the operating conditions in the actual system. Therefore, be sure to evaluate the various characteristics, such as the leakage current and noise absorptivity, which will affect the capacitance value of the capacitor.

3. In addition, voltages exceeding the predetermined surge may be applied to the capacitor by the inductance in the actual system. Evaluate the surge resistance in the actual system as required.

1. Please make sure that your product has been evaluated in view of your specifications with our product being mounted to your product.
2. You are requested not to use our product deviating from this product specification.
3. We consider it not appropriate to include any terms and conditions with regard to the business transaction in the product specifications, drawings or other technical documents. Therefore, if your technical documents as above include such terms and conditions such as warranty clause, product liability clause, or intellectual property infringement liability clause, they will be deemed to be invalid.



## X-ON Electronics

Largest Supplier of Electrical and Electronic Components

*Click to view similar products for [Multilayer Ceramic Capacitors MLCC - SMD/SMT category](#):*

*Click to view products by [Murata manufacturer](#):*

Other Similar products are found below :

[D55342E07B523DR-T/R](#) [NCA1206X7R104K16TRPF](#) [NIN-FB391JTRF](#) [NIN-FC2R7JTRF](#) [NMC0402NPO220J50TRPF](#)  
[NMC0402X5R105K6.3TRPF](#) [NMC0402X5R224K6.3TRPF](#) [NMC0402X7R103J25TRPF](#) [NMC0402X7R153K16TRPF](#)  
[NMC0402X7R392K50TRPF](#) [NMC0603NPO1R8C50TRPF](#) [NMC0603NPO201J50TRPF](#) [NMC0603NPO330G50TRPF](#)  
[NMC0603X5R475M6.3TRPF](#) [NMC0805NPO220J100TRPF](#) [NMC0805NPO270J50TRPF](#) [NMC0805NPO681F50TRPF](#)  
[NMC0805NPO820J50TRPF](#) [NMC1206X7R102K50TRPF](#) [NMC1210Y5V105Z50TRPLPF](#) [NMC-L0402NPO7R0C50TRPF](#) [NMC-](#)  
[L0603NPO2R2B50TRPF](#) [NMC-P0805NPO221J500TRPLPF](#) [NMC-P1206X7R103K1KVTRPLPF](#) [NMC-Q0402NPO8R2D200TRPF](#)  
[C1206C101J1GAC](#) [C1608C0G2A221J](#) [C1608X7R1E334K](#) [C2012C0G2A472J](#) [2220J2K00562KXT](#) [KHC201E225M76N0T00](#)  
[1812J2K00332KXT](#) [CCR06CG153FSV](#) [CDR14BP471CJUR](#) [CDR31BX103AKWR](#) [CDR33BX683AKUS](#) [CGA2B2C0G1H010C](#)  
[CGA2B2C0G1H040C](#) [CGA2B2C0G1H050C](#) [CGA2B2C0G1H060D](#) [CGA2B2C0G1H070D](#) [CGA2B2C0G1H120J](#) [CGA2B2C0G1H151J](#)  
[CGA2B2C0G1H1R5C](#) [CGA2B2C0G1H2R2C](#) [CGA2B2C0G1H390J](#) [CGA2B2C0G1H391J](#) [CGA2B2C0G1H3R3C](#) [CGA2B2C0G1H680J](#)  
[CGA2B2C0G1H6R8D](#)