

Chip Multilayer Ceramic Capacitors for General

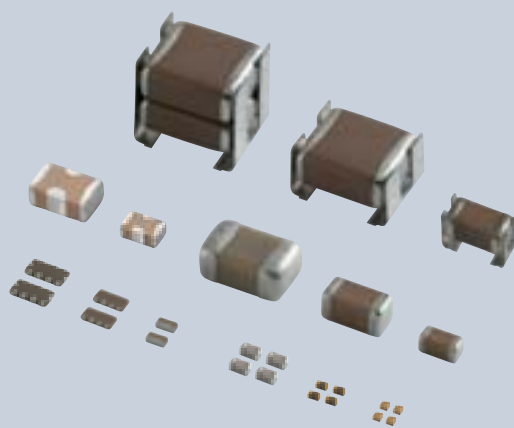

2018

Contents

Product specifications are as of September 2017.

Explanation of Symbols in This Catalog	··· p2	Part Numbering	·········· p5
Selection Guide	·········· p3	Capacitance Table	·········· p9
Catalog information	·········· p4		
<small>Cap. Table</small>			
<hr/>			
Chip Multilayer Ceramic Capacitors for General Purpose			
GRM Series	·········· p40		p10
GRM Series Specifications and Test Methods	·········· p108		
<hr/>			
High Effective Capacitance & High Ripple Current Chip Multilayer Ceramic Capacitors for General Purpose			
GR3 Series	·········· p109		p27
GR3 Series Specifications and Test Methods (1)	·········· p111		
GR3 Series Specifications and Test Methods (2)	·········· p114		
GR3 Series Specifications and Test Methods (3)	·········· p117		
<hr/>			
Soft Termination Chip Multilayer Ceramic Capacitors for General Purpose			
GRJ Series	·········· p120		p28
GRJ Series Specifications and Test Methods	·········· p124		
<hr/>			
Chip Multilayer Ceramic Capacitors for Ethernet LAN and Primary-secondary Coupling of DC-DC Converters			
GR4 Series	·········· p125		p30
GR4 Series Specifications and Test Methods (1)	·········· p127		
<hr/>			
Chip Multilayer Ceramic Capacitors for Camera Flash circuit only			
GR7 Series	·········· p130		p30
GR7 Series Specifications and Test Methods (1)	·········· p132		
<hr/>			
High Q Chip Multilayer Ceramic Capacitors for General Purpose			
GJM Series	·········· p135		p30
GJM Series Specifications and Test Methods (1)	·········· p157		
GJM Series Specifications and Test Methods (2)	·········· p160		
<hr/>			
High Q and High Power Chip Multilayer Ceramic Capacitors for General Purpose			
GQM Series	·········· p164		p31
GQM Series Specifications and Test Methods (1)	·········· p172		
GQM Series Specifications and Test Methods (2)	·········· p175		
GQM Series Specifications and Test Methods (3)	·········· p178		
GQM Series Specifications and Test Methods (4)	·········· p181		
<hr/>			
Based on the Electrical Appliance and Material Safety Law of Japan Chip Multilayer Ceramic Capacitors for General Purpose			
GA2 Series	·········· p184		p32
GA2 Series Specifications and Test Methods (1)	·········· p186		
<hr/>			
Safety Standard Certified Chip Multilayer Ceramic Capacitors for General Purpose / IEC60384-14 Class X2			
GA3 Series Type GB	·········· p189		p32
GA3 Series Type GB Specifications and Test Methods (1)	·········· p192		
<hr/>			
Safety Standard Certified Chip Multilayer Ceramic Capacitors for General Purpose / Acquired certifications of UL60950-1			
GA3 Series Type GD	·········· p196		p32
GA3 Series Type GD Specifications and Test Methods (1)	·········· p199		
GA3 Series Type GD Specifications and Test Methods (2)	·········· p203		
<hr/>			
Safety Standard Certified Chip Multilayer Ceramic Capacitors for General Purpose / Acquired certifications of IEC60384-14 Class X1/Y2 and UL60950-1			
GA3 Series Type GF	·········· p207		p33
GA3 Series Type GF Specifications and Test Methods (1)	·········· p211		
GA3 Series Type GF Specifications and Test Methods (2)	·········· p215		
<hr/>			
LW Reversed Low ESL Chip Multilayer Ceramic Capacitors for General Purpose			
LLL Series	·········· p219		p34
LLL Series Specifications and Test Methods	·········· p221		
<hr/>			

		Cap. Table
8 Terminals Low ESL Chip Multilayer Ceramic Capacitors for General Purpose		
LLA Series	p222	p34
LLA Series Specifications and Test Methods (1)	p224	
LLA Series Specifications and Test Methods (2)	p226	
10 Terminals Low ESL Chip Multilayer Ceramic Capacitors for General Purpose		
LLM Series	p228	p35
LLM Series Specifications and Test Methods (1)	p230	
LW Reversed Controlled ESR Low ESL Chip Multilayer Ceramic Capacitors for General Purpose		
LLR Series	p232	p35
LLR Series Specifications and Test Methods (1)	p234	
3 Terminals Low ESL Chip Multilayer Ceramic Capacitors for General Purpose		
NFM Series	p236	p35
NFM Series Specifications and Test Methods	p238	
Metal Terminal Type Multilayer Ceramic Capacitors for General Purpose		
KRM Series	p239	p36
KRM Series Specifications and Test Methods	p242	
High Effective Capacitance & High Allowable Ripple Current Metal Terminal Type Multilayer Ceramic Capacitors for General Purpose		
KR3 Series	p243	p37
KR3 Series Specifications and Test Methods (1)	p246	
Wire Bonding Mount Multilayer Microchip Capacitors for General Purpose		
GMA Series	p249	p37
GMA Series Specifications and Test Methods (1)	p252	
GMA Series Specifications and Test Methods (2)	p254	
Wire Bonding/AuSn Soldering Mount Chip Multilayer Ceramic Capacitors for General Purpose		
GMD Series	p256	p38
GMD Series Specifications and Test Methods (1)	p259	
GMD Series Specifications and Test Methods (2)	p261	
GMD Series Specifications and Test Methods (3)	p263	
⚠Caution/Notice/Soldering and Mounting	p265	
Introduction of Website SimSurfing	p291	
Product Information	p292	

Please check the MURATA website (<https://www.murata.com/>) if you cannot find a part number in this catalog.

EU RoHS Compliant

- All the products in this catalog comply with EU RoHS.
- EU RoHS is "the European Directive 2011/65/EU on the Restriction of the Use of Certain Hazardous Substances in Electrical and Electronic Equipment."
- For more details, please refer to our web page, "Murata's Approach for EU RoHS" (<https://www.murata.com/en-eu/support/compliance/rohs>).

Qualified Standards

- The products listed here have been produced by ISO 9001 certified factory.
 <Plant>
 - Fukui Murata Mfg. Co., Ltd.
 - Izumo Murata Mfg. Co., Ltd.
 - Murata Electronics Singapore (Pte.) Ltd.
 - Wuxi Murata Electronics Co., Ltd.
 - PHILIPPINE MANUFACTURING CO. OF MURATA, INC.



Explanation of Symbols in This Catalog



Links are provided to the latest information from the PDF version of the catalog, which is available on the web.

General	For applications that do not require the particular reliability such as the general equipment
Info-tainment	Infotainment for Automotive The product for entertainment equipment like car navigations, car audios, and body control equipment like wipers, power windows.
Powertrain	Powertrain/Safety for Automotive Product used for applications (running, turning, stopping and safety devices) which particularly concern human life, such as in devices for automobiles.
Medical Device	Medical-grade products for Implanted Medical Devices These products are intended for use in implanted medical devices such as cardiac pacemakers, cochlear implants, insulin pumps and gastric electrostimulators. They are suitable for use in non-critical circuits. *1 *1 Non-critical circuits This term refers to circuits in implanted medical devices that are not directly linked to life support, i.e. circuits that will not directly endanger the life of the patient should the functionality of the device be reduced or halted by failure of the circuit.
AEC-Q200	AEC-Q200 compliant product
Safety standard	Safety Standard Certified Product Products that acquired safety standard certification IEC60384-14 and products based on the Electrical Appliance and Material Safety Law of Japan.
Japanese Safety Law	Based on the Electrical Appliance and Material Safety Law of Japan Products that are based on the electrical appliance and material safety law of Japan.
High Q	Low dissipation for high frequency By devising ceramic materials and electrode materials, low dissipation is achieved in frequency bands of VHF, UHF and microwave or beyond.
Low ESL	Low inductance This capacitor is designed so that the parasitic inductance component (ESL) that the capacitor has on the high frequency side becomes lower.
Fail safe	Fail safe product This capacitor is designed to prevent failures as much as possible by short mode.
Deflecting crack	Product resistant to deflection cracking This capacitor is designed to prevent failures as much as possible by short mode caused by cracking when there is board deflection.
Soldering crack	Product with solder cracking suppression "This capacitor is configured with metal terminals and leads connected to the chip. The metal terminals and leads relieve the stress from expansion and contraction of the solder, to suppress solder cracking."
Anti-noise	Product suitable for acoustic noise reduction and low distortion This product suppresses acoustic noise, which occurs when a ceramic capacitor is used, by devising the materials and configuration.
Effective Cap	No DC bias characteristics Polymer capacitor is no capacitance change with DC bias due to aluminum oxidized film for dielectric.
EMI FIL®	Low-inductance product suitable for noise suppression. This product has extremely low ESL and is suitable for suppression of noise, including high frequencies. This product can also be used as a low-ESL, high-performance bypass capacitor.
Bonding	Product for bonding Since gold is used for the external electrodes, the capacitor can be mounted by die bonding/wire bonding.

Derating 1
This product is suitable when a voltage continuously applied to a capacitor in an operating circuit, is used below (derated) the rated voltage of the capacitor. This model guarantees the test conditions in the endurance test, at a rated voltage x 100% at the maximum operating temperature. A reliability assurance level equivalent to a common product can be secured, by using this product within the voltage and temperature derated conditions recommended in the figure below.

Recommended Conditions of the Derating Operating Voltage and Temperature

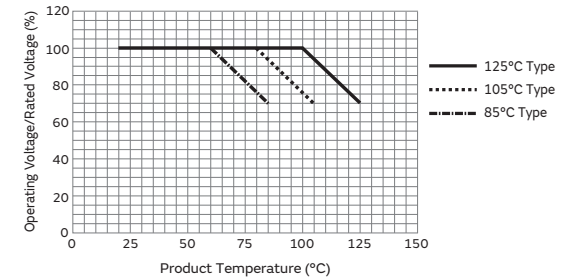

D1
Derating 1

Derating 2
When the product temperature exceeds 105°C, please use this product within the voltage and temperature derated conditions in the figure below.

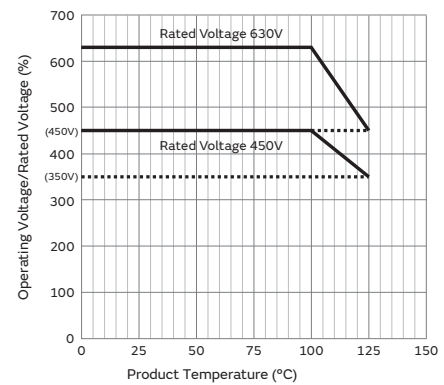

D2
Derating 2

Derating 3
Please apply the derating curve according to the operating temperature.
Please refer to detailed specifications sheet for details.

D3
Derating 3

Derating 4
When the product temperature exceeds 125°C, please use this product within the voltage and temperature derated conditions in the figure below.

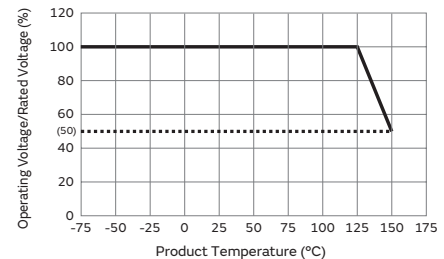

D4
Derating 4

Derating 5
Please apply the rated voltage derating over 150 °C.
Please refer to detailed specifications sheet for details.

D5
Derating 5

Selection Guide for Capacitors

For general

General SMD

Solder mounting

Chip type

	GRM		p40	
	GRM	For LCD backlight inverter circuit only		WEB
	GR3	Anti-noise	High effective capacitance & high ripple current	p109
	GRJ	Deflecting crack	Soft termination	p120
	GXM	Water Repellent		WEB
	GR4		For information devices only	p125
	GR7		For camera flash circuit only	p130
	GJM	High Q		p135
	GQM	High Q	High power	p164
	GA2	Japanese Safety Law	Based on the Electrical Appliance and Material Safety Law of Japan	p184
	GA3	Safety standard		p189
	LLL	Low ESL	LW reversed	p219
	LLA	Low ESL	8 terminals	p222
	LLM	Low ESL	10 terminals	p228
	LLR	Low ESL	LW reversed controlled ESR	p232
	NFM	Low ESL	3 terminals	p236
	GJ4	Anti-noise	Low distortion	WEB
	GJ8	Anti-noise	Low acoustic noise	WEB

On interposer board

	ZRA	Anti-noise		WEB
	ZRB	Anti-noise		WEB

Metal terminal type

	KRM	Anti-noise	Deflecting crack	Soldering crack		p239
	KR3	Anti-noise	Deflecting crack	Soldering crack	High effective capacitance & high ripple current	p243

Resin molding SMD type

	DK1	Safety standard		WEB
--	------------	-----------------	--	-----

Wire bonding mounting

Chip type

	GMA		Microchip	p249
	GMD			p256

Lead type

Solder mounting

	RDE	Anti-noise	Deflecting crack	Soldering crack		WEB
	DEH		High temperature low loss			WEB
	DEA		High temperature Class 1			WEB
	DEB		Class 2			WEB
	DEC					WEB
	DEF		For LCD backlight inverter circuit only			WEB
	DHR	Ultra-high voltage	Deflecting crack	Soldering crack		WEB
	DEJ	Japanese Safety Law	Based on the Electrical Appliance and Material Safety Law of Japan			WEB
	DE1	Safety standard	X1/Y1 Class certified product			WEB
	DE2	Safety standard	X1/Y2 Class certified product			WEB

Screw termination mounting

	DHS	Ultra-high voltage		WEB
	DHK	Ultra-high voltage	High voltage AC rated	WEB

Infotainment for automotive

SMD

Solder mounting

Chip type

	GRT			WEB
--	------------	--	--	-----

Powertrain/Safety for automotive

SMD

Solder mounting

Chip type

	GCM			WEB		
	GC3	Anti-noise	High effective capacitance & high ripple current	WEB		
	GCJ	Fail safe	Deflecting crack	Soft termination	WEB	
	GGM	Water Repellent		WEB		
	GCQ	High Q		WEB		
	GCD	Fail safe	Deflecting crack	MLSC design	WEB	
	GCE	Fail safe	Deflecting crack	Soft termination MLSC design	WEB	
	GGD	Fail safe	Deflecting crack	Water Repellent	MLSC design	WEB
	NFM	Low ESL		3 terminals	WEB	

Metal terminal type

	KCM	Anti-noise	Deflecting crack	Soldering crack		WEB
	KC3	Anti-noise	Deflecting crack	Soldering crack	High effective capacitance & high ripple current	WEB
	KCA	Safety standard	Anti-noise	Deflecting crack	Soldering crack	WEB

Limited to Conductive Glue Mounting

Chip type

	GCB	Deflecting crack	Soldering crack	Ni plating + Pd plating termination conductive glue mounting	WEB
	GCG	Deflecting crack	Soldering crack	AgPd termination conductive glue mounting	WEB

Lead type

Solder mounting

	RCE	Anti-noise	Deflecting crack	Soldering crack		WEB
	RHE	Anti-noise	Deflecting crack	Soldering crack	150°C operation leaded	WEB
	RHS	Anti-noise	Deflecting crack	Soldering crack	200°C operation leaded	WEB
	DE6	Safety standard				WEB

Medical-grade products for implanted medical devices

SMD

Solder mounting

Chip type

	GCH			WEB
--	------------	--	--	-----

Catalog Information

Catalog relates to a multilayer ceramic capacitor is below.

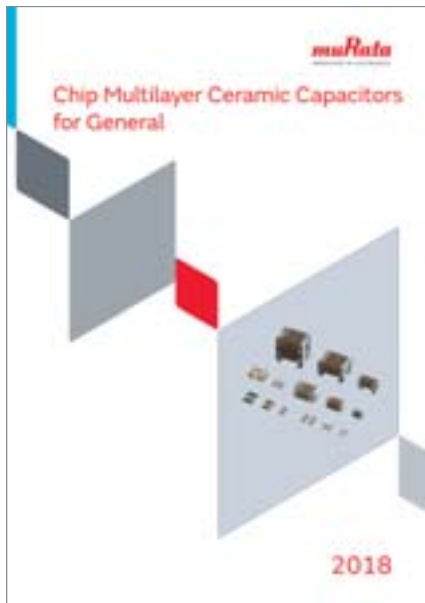

Chip Multilayer Ceramic Capacitors for General

Cat No. C02E-21

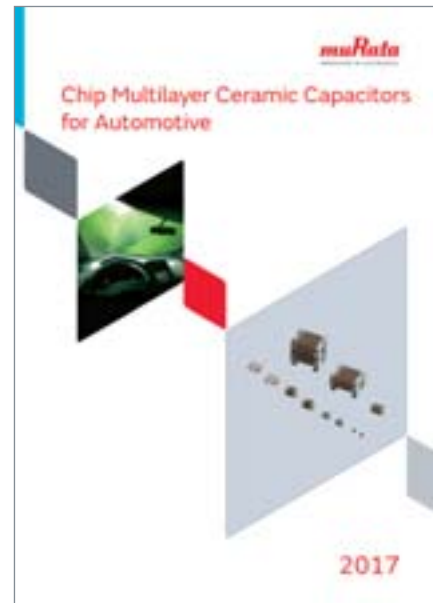

Chip Multilayer Ceramic Capacitors for Automotive

Cat No. C03E-9



Safety Certified Ceramic Capacitors/High Voltage Ceramic Capacitors

Cat No. C85E-5



Radial Lead Type Monolithic Ceramic Capacitors

Cat No. C49E-23

● Part Numbering

Chip Multilayer Ceramic Capacitors for General



(Part Number)

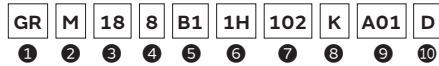

① Product ID ② Series

Product ID	Code	Series
GA	2	Based on the Electrical Appliance and Material Safety Law of Japan Chip Multilayer Ceramic Capacitors for General Purpose
	3	Safety Standard Certified Chip Multilayer Ceramic Capacitors for General Purpose
GJ	M	High Q Chip Multilayer Ceramic Capacitors for General Purpose
GM	A	Wire Bonding Mount Multilayer Microchip Capacitors for General Purpose
	D	Wire Bonding/AuSn Soldering Mount Chip Multilayer Ceramic Capacitors for General Purpose
GQ	M	High Q and High Power Chip Multilayer Ceramic Capacitors for General Purpose
GR	3	High Effective Capacitance & High Ripple Current Chip Multilayer Ceramic Capacitors for General Purpose
	4	Chip Multilayer Ceramic Capacitors for Camera Flash Circuit only
	7	Chip Multilayer Ceramic Capacitors for Ethernet LAN and Primary-secondary Coupling of DC-DC Converters
	J	Soft Termination Chip Multilayer Ceramic Capacitors for General Purpose
KR	M	Chip Multilayer Ceramic Capacitors for General Purpose
	3	High Effective Capacitance & High Allowable Ripple Current Metal Terminal Type Multilayer Ceramic Capacitors for General Purpose
LL	M	Metal Terminal Type Multilayer Ceramic Capacitors for General Purpose
	A	8 Terminals Low ESL Chip Multilayer Ceramic Capacitors for General Purpose
	L	LW Reversed Low ESL Chip Multilayer Ceramic Capacitors for General Purpose
	M	10 Terminals Low ESL Chip Multilayer Ceramic Capacitors for General Purpose
	R	LW Reversed Controlled ESR Low ESL Chip Multilayer Ceramic Capacitors for General Purpose

③ Chip Dimensions (LxW)

Code	Dimensions (LxW)	EIA
02	0.4x0.2mm	01005
0D	0.38x0.38mm	015015
03	0.6x0.3mm	0201
05	0.5x0.5mm	0202
08	0.8x0.8mm	0303
1U	0.6x1.0mm	02404
15	1.0x0.5mm	0402
18	1.6x0.8mm	0603
21	2.0x1.25mm	0805
22	2.8x2.8mm	1111
31	3.2x1.6mm	1206
32	3.2x2.5mm	1210
42	4.5x2.0mm	1808
43	4.5x3.2mm	1812
52	5.7x2.8mm	2211
55	5.7x5.0mm	2220

Continued on the following page. ↗

(Part Number)

GR	M	18	8	B1	1H	102	K	A01	D
1	2	3	4	5	6	7	8	9	10

Continued from the preceding page. ↘

④ Height Dimension (T) (Except KR□)

Code	Dimension (T)
2	0.2mm
3	0.3mm
4	0.4mm
5	0.5mm
6	0.6mm
7	0.7mm
8	0.8mm
9	0.85mm
A	1.0mm
B	1.25mm
C	1.6mm
D	2.0mm
E	2.5mm
M	1.15mm
Q	1.5mm
X	Depends on individual standards.

④ Height Dimension (T) (KR□ Only)

Code	Dimension (T)
E	1.8mm
F	1.9mm
K	2.7mm
L	2.8mm
Q	3.7mm
T	4.8mm
W	6.4mm

⑤ Temperature Characteristics

Temperature Characteristic Codes			Temperature Characteristics				Operating Temperature Range	Capacitance Change Each Temperature (%)					
Code	Public STD Code	Reference Temperature	Temperature Range	Capacitance Change or Temperature Coefficient	-55°C			*6		-10°C			
					Max.	Min.		Max.	Min.	Max.	Min.		
1X	SL	JIS	20°C	20 to 85°C	+350 to -1000ppm/°C	-55 to 125°C	-	-	-	-	-	-	
2C	CH	JIS	20°C	20 to 125°C	0±60ppm/°C	-55 to 125°C	0.82	-0.45	0.49	-0.27	0.33	-0.18	
3C	CJ	JIS	20°C	20 to 125°C	0±120ppm/°C	-55 to 125°C	1.37	-0.9	0.82	-0.54	0.55	-0.36	
3U	UJ	JIS	20°C	20 to 85°C	-750±120ppm/°C	-25 to 85°C	-	-	4.94	2.84	3.29	1.89	
4C	CK	JIS	20°C	20 to 125°C	0±250ppm/°C	-55 to 125°C	2.56	-1.88	1.54	-1.13	1.02	-0.75	
5C	COG	EIA	25°C	25 to 125°C	0±30ppm/°C	-55 to 125°C	0.58	-0.24	0.4	-0.17	0.25	-0.11	
5G	X8G	*2	25°C	25 to 150°C	0±30ppm/°C	-55 to 150°C	0.58	-0.24	0.4	-0.17	0.25	-0.11	
7U	U2J	EIA	25°C	25 to 125°C *3	-750±120ppm/°C	-55 to 125°C	8.78	5.04	6.04	3.47	3.84	2.21	
B1	B *1	JIS	20°C	-25 to 85°C	±10%	-25 to 85°C	-	-	-	-	-	-	
B3	B	JIS	20°C	-25 to 85°C	±10%	-25 to 85°C	-	-	-	-	-	-	
C7	X7S	EIA	25°C	-55 to 125°C	±22%	-55 to 125°C	-	-	-	-	-	-	
C8	X6S	EIA	25°C	-55 to 105°C	±22%	-55 to 105°C	-	-	-	-	-	-	
D7	X7T	EIA	25°C	-55 to 125°C	+22%, -33%	-55 to 125°C	-	-	-	-	-	-	
D8	X6T	EIA	25°C	-55 to 105°C	+22%, -33%	-55 to 105°C	-	-	-	-	-	-	
E7	X7U	EIA	25°C	-55 to 125°C	+22%, -56%	-55 to 125°C	-	-	-	-	-	-	
R1	R *1	JIS	20°C	-55 to 125°C	±15%	-55 to 125°C	-	-	-	-	-	-	
R6	X5R	EIA	25°C	-55 to 85°C	±15%	-55 to 85°C	-	-	-	-	-	-	
R7	X7R	EIA	25°C	-55 to 125°C	±15%	-55 to 125°C	-	-	-	-	-	-	
W0	X7T	EIA	25°C	-55 to 125°C	±10% *4	-55 to 125°C	-	-	-	-	-	-	
					+22%, -33% *5		-	-	-	-	-	-	

*1 Capacitance change is specified with 50% rated voltage applied.
 *2 Murata Temperature Characteristic Code.
 *3 Rated Voltage 100Vdc max: 25 to 85°C
 *4 Apply DC350V bias.
 *5 No DC bias.
 *6 -25°C (Reference Temperature 20°C) / -30°C (Reference Temperature 25°C)

Continued on the following page. ↗

(Part Number)

GR	M	18	8	B1	1H	102	K	A01	D
1	2	3	4	5	6	7	8	9	10

Continued from the preceding page. ↘

⑥ Rated Voltage

Code	Rated Voltage
OE	DC2.5V
OG	DC4V
OJ	DC6.3V
1A	DC10V
1C	DC16V
1E	DC25V
1H	DC50V
1J	DC63V
1K	DC80V
2A	DC100V
2D	DC200V
2E	DC250V
2W	DC450V
2H	DC500V
2J	DC630V
3A	DC1kV
3D	DC2kV
3F	DC3.15kV
BB	DC350V
E2	AC250V
GB	X2; AC250V (Safety Standard Certified Type GB)
GD	Y3; AC250V (Safety Standard Certified Type GD)
GF	Y2, X1/Y2; AC250V (Safety Standard Certified Type GF)
YA	DC35V

⑦ Capacitance

Expressed by three-digit alphanumerics. The unit is picofarad (pF). The first and second figures are significant digits, and the third figure expresses the number of zeros which follow the two numbers. If there is a decimal point, it is expressed by the capital letter "R." In this case, all figures are significant digits. If any alphabet, other than "R", is included, this indicates the specific part number is a non-standard part.

Ex.)

Code	Capacitance
R50	0.50pF
1R0	1.0pF
100	10pF
103	10000pF

⑧ Capacitance Tolerance

Code	Capacitance Tolerance
B	±0.1pF
C	±0.25pF
D	±0.5pF (Less than 10pF) ±0.5% (10pF and over)
F	±1%
G	±2%
J	±5%
K	±10%
M	±20%
W	±0.05pF

⑨ Individual Specification Code (Except LLR)

Expressed by three figures.

⑨ ESR (LLR Only)

Code	ESR
E01	100mΩ
E03	220mΩ
E05	470mΩ
E07	1000mΩ

⑩ Packaging

Code	Packaging
L	ø180mm Embossed Taping
D/E/W	ø180mm Paper Taping
K	ø330mm Embossed Taping
J/F	ø330mm Paper Taping
T	Bulk Tray

Please contact us if you find any part number not provided in this table.

3 Terminal Low ESL Multilayer Ceramic Capacitors

WEB 

(Part Number)

NF	M	3D	CC	102	R	1H	3	L
1	2	3	4	5	6	7	8	9

1 Product ID 2 Series

Product ID	Series
NFM	3 Terminals Low ESL Chip Multilayer Ceramic Capacitors

3 Dimensions (LxW)

Code	Dimensions (LxW)	EIA
15	1.0x0.5mm	0402
18	1.6x0.8mm	0603
21	2.0x1.25mm	0805
3D	3.2x1.25mm	1205
31	3.2x1.6mm	1206
41	4.5x1.6mm	1806

4 Features

Code	Features	
CC	For General	For Signal Lines
PC		For Large Current
PS		High Insertion Loss Type for Large Current
KC		For Very Large Current

5 Capacitance

Expressed by three figures. The unit is in pico-farad (pF). The first and second figures are significant digits, and the third figure expresses the number of zeros that follow the two figures.

6 Characteristics

Code	Capacitance Temperature Characteristics
B	±10%, ±12.5%, +10/-13%
C	±22%
D	+22/-33%
F	+30/-80%, +30/-84%
R	±15%, +15/-18%

7 Rated Voltage

Code	Rated Voltage
0E	2.5V
0G	4V
0J	6.3V
1A	10V
1C	16V
1E	25V
1H	50V
2A	100V

8 Electrode

Code	Electrode
3	Sn Plating

9 Packaging

Code	Packaging
B	Bulk
L	Embossed Taping (ø180mm Reel)
D	Paper Taping (ø180mm Reel)

Capacitance Table

How to read the Capacitance Table

L×W (mm)	0.4×0.2		0.6		
T max. (mm)	0.22		0.		
Rated Voltage (Vdc)	25		50		
Cap. / TC Code	COG	CΔ	COG	CK	CJ
0.10pF					
0.20pF	p140	p143	p146	p146	
1.0pF	p140	p143		p146	
2.0pF	p140	p143		p146	
3.0pF	p140	p143			p146

→ The values can be narrowed down in the order of size, rated voltage, and temperature characteristics.

→ Refers to the page of the part number list.
 Check the part number list for the applicable product number.

Temperature Characteristics Table

The Table is colored by temperature characteristic codes.
 Refer to the following Table for the meaning of each code.

EIA:	COG	U2J	X7R	X7S	X7T	X7U	X6S	X6T	X5R
JIS:	CK	CJ	CH	SL	UJ	R	B		
Murata Temperature Characteristic:	X8G								

Temperature Characteristic Codes		Temperature Characteristics			Operating Temperature Range	Capacitance Change Each Temperature (%)					
Public STD Code	Reference Temperature	Temperature Range	Capacitance Change or Temperature Coefficient	-55°C		*3		-10°C			
				Max.		Min.	Max.	Min.	Max.	Min.	
COG	EIA	25°C	25 to 125°C	0±30ppm/°C	-55 to 125°C	0.58	-0.24	0.4	-0.17	0.25	-0.11
CK	JIS	20°C	20 to 125°C	0±250ppm/°C	-55 to 125°C	2.56	-1.88	1.54	-1.13	1.02	-0.75
CJ	JIS	20°C	20 to 125°C	0±120ppm/°C	-55 to 125°C	1.37	-0.9	0.82	-0.54	0.55	-0.36
CH	JIS	20°C	20 to 125°C	0±60ppm/°C	-55 to 125°C	0.82	-0.45	0.49	-0.27	0.33	-0.18
SL	JIS	20°C	20 to 85°C	+350 to -1000ppm/°C	-55 to 125°C	-	-	-	-	-	-
U2J	EIA	25°C	25 to 125°C *2	-750±120ppm/°C	-55 to 125°C	8.78	5.04	6.04	3.47	3.84	2.21
UJ	JIS	20°C	20 to 85°C	-750±120ppm/°C	-25 to 85°C	-	-	4.94	2.84	3.29	1.89
X8G	*1	25°C	25 to 150°C	0±30ppm/°C	-55 to 150°C	0.58	-0.24	0.4	-0.17	0.25	-0.11
X7R	EIA	25°C	-55 to 125°C	±15%	-55 to 125°C	-	-	-	-	-	-
X7S	EIA	25°C	-55 to 125°C	±22%	-55 to 125°C	-	-	-	-	-	-
X7T	EIA	25°C	-55 to 125°C	+22%, -33%	-55 to 125°C	-	-	-	-	-	-
X7U	EIA	25°C	-55 to 125°C	+22%, -56%	-55 to 125°C	-	-	-	-	-	-
R	JIS	20°C	-55 to 125°C	±15%	-55 to 125°C	-	-	-	-	-	-
X6S	EIA	25°C	-55 to 105°C	±22%	-55 to 105°C	-	-	-	-	-	-
X6T	EIA	25°C	-55 to 105°C	+22%, -33%	-55 to 105°C	-	-	-	-	-	-
X5R	EIA	25°C	-55 to 85°C	±15%	-55 to 85°C	-	-	-	-	-	-
B	JIS	20°C	-25 to 85°C	±10%	-25 to 85°C	-	-	-	-	-	-

*1 Murata Temperature Characteristic Code.

*2 Rated Voltage 100Vdc max: 25 to 85°C

*3 -25°C (Reference Temperature 20°C) / -30°C (Reference Temperature 25°C)

Capacitance Table

(→ GRM Series Temperature Compensating Type)

p00	← Part Number List		JIS: CK CJ CH SL UJ					EIA: C0G U2J				
L×W (mm)	4.5×3.2					5.7×5.0						
T max. (mm)	1.5		2.0			1.5			2.0			
Rated Voltage (Vdc)	630	500	1000	630	500	1000	630	500	1000	630	500	
Cap. / TC Code	U2J	U2J	U2J	U2J	U2J	U2J	U2J	U2J	U2J	U2J	U2J	
0.10pF												
0.20pF												
0.50pF												
1.0pF												
2.0pF												
3.0pF												
4.0pF												
5.0pF												
6.0pF												
7.0pF												
8.0pF												
9.0pF												
10pF												
11pF												
12pF												
13pF												
15pF												
16pF												
17pF												
18pF												
19pF												
20pF												
21pF												
22pF												
23pF												
24pF												
27pF												
30pF												
33pF												
36pF												
39pF												
43pF												
47pF												
51pF												
56pF												
62pF												
68pF												
75pF												
82pF												
91pF												
100pF												
120pF												
150pF												
180pF												
220pF												
270pF												
330pF												
390pF												
470pF												
560pF												
680pF												
820pF												
910pF												
1000pF												
1200pF												
1500pF												
1800pF												
2200pF												
2700pF												
3300pF												
3900pF												
4700pF												
5600pF												
6800pF												
8200pF												
10000pF												
12000pF												
15000pF												
18000pF												
22000pF												
27000pF												
33000pF												
39000pF												
47000pF												
56000pF												
68000pF												
82000pF												
0.10μF												
0.12μF												

Capacitance Table

GRM Series High Dielectric Constant Type

p00 ← Part Number List JIS: R B EIA: X7R X7S X7T X7U X6S X6T X5R

L×W (mm)	0.4×0.2						0.6×0.3												1.0×0.5									
T max. (mm)	0.22						0.33												0.22									
Rated Voltage (Vdc)	16	10	6.3	4	2.5	50	35	25			16			10			6.3	4	10	6.3								
Cap. / TC Code	X7R	X7R	X5R, B	X5R, B	X6T	X5R	X6T	X7R	X5R, B	X5R	X7R, R	X6S	X5R, B	X7Δ, R	X6S	X5R, B	X7Δ, R	X5R, B	X7R, R	X6S	X5R, B	X6S	X5R, B	X6S	X5R, B			
100pF	p97	p97	p97	p97				p98	p98		p98																	
150pF	p97	p97	p97	p97				p98	p98		p98																	
220pF	p97	p97	p97	p97				p98	p98		p98																	
330pF	p97	p97	p97	p97				p98	p98		p98																	
470pF	p97	p97	p97	p97				p98	p98		p98																	
680pF		p97	p97	p97				p98	p98		p98																	
820pF		p97																										
1000pF	p97	p97	p97	p97	p97			p98	p98		p98	p98		p98														
1500pF			p97	p97	p97			p98	p98		p98	p98		p98														
2200pF			p97	p97	p97						p98						p99											
3300pF			p97	p97	p97						p98						p99											
4700pF			p97	p97	p97						p98						p99	p99	p99	p99				p99				
6800pF			p97	p97	p97						p98						p99	p99	p99	p99				p99				
10000pF			p97	p97	p97						p98						p99	p99	p99									
15000pF				p97		p97											p98	p99		p99	p99		p99	p99				
22000pF				p97		p97											p98	p99		p99	p99		p99	p99				
33000pF				p97		p98											p98	p99		p99	p99		p99	p99				
47000pF				p97		p98											p99	p99		p99	p99							
68000pF				p97		p98											p99	p99		p99	p99							
0.10μF				p97	p97	p98	p98			p98		p98	p98	p98	p98	p99	p99	p99	p99					p99	p100	p100	p100	p100
0.15μF																												
0.22μF																			p99			p99	p99	p99	p100	p100	p100	p100
0.33μF																												
0.47μF																											p100	p100
0.68μF																												
1.0μF																												p100
2.2μF																												
4.7μF																												
10μF																												
22μF																												
47μF																												
100μF																												
150μF																												
220μF																												

Continued on the following page. ↗

Capacitance Table

(→ GRM Series High Dielectric Constant Type)

p00 ← Part Number List JIS: R B EIA: X7R X7S X7T X7U X6S X6T X5R

L×W (mm)	1.0×0.5																										
T max. (mm)	0.22			0.3				0.33				0.55															
Rated Voltage (Vdc)	4		2.5	50		25		16		10	10		6.3		4	100		50		35		25		16			
Cap. / TC Code	X7T	X6Δ	X5R	X7T	X7R, R	B	X7R	B	X7R	B	X5R	X5R, B	X6T	X5R, B	X6T	X7R	X7R, R	X6S	X5R, B	X6S	X5R	X7R, R	X6S	X5R, B	X7R, R		
100pF																											
150pF																											
220pF					p100	p100	p100									p100	p101	p100		p101							
330pF					p100	p100	p100									p100	p101	p100		p101							
470pF					p100	p100	p100									p100	p101	p100		p101							
680pF					p100	p100	p100									p100	p101	p100		p101							
820pF																											
1000pF					p100	p100	p100									p100	p101	p100		p101							
1500pF					p100	p100	p100									p100	p101	p100		p101							
2200pF							p100	p100								p100	p101	p100		p101			p101			p101	
3300pF									p100	p100						p100	p101	p101		p101							
4700pF									p100	p100						p100	p101	p101		p101							p102
6800pF									p100	p100							p101	p101		p101			p101				
10000pF									p100	p100							p101	p101		p101			p101	p101		p101	p102
15000pF										p100							p101		p101			p101	p101		p101		
22000pF										p100							p101		p101			p101	p101		p101		
33000pF										p100							p101	p101	p101			p101	p101		p101		
47000pF																	p101	p101	p101			p101	p101		p101		
68000pF																	p101	p101	p101			p101	p101		p101	p101	p102
0.10μF	p100	p100		p100												p101		p101			p101			p101	p101	p102	
0.15μF																											p102
0.22μF	p100	p100		p100																p101	p101		p101	p101		p101	p102
0.33μF																											
0.47μF		p100																			p101					p101	
0.68μF																											
1.0μF		p100	p100									p100	p100	p100	p100				p101					p101	p102		
2.2μF																											
4.7μF																											
10μF																											
22μF																											
47μF																											
100μF																											
150μF																											
220μF																											

Continued on the following page. ↗

Capacitance Table

(→ GRM Series High Dielectric Constant Type)

p00 ← Part Number List JIS: R B EIA: X7R X7S X7T X7U X6S X6T X5R

L×W (mm)	1.0×0.5																															
T max. (mm)	0.55										0.6						0.65				0.7											
Rated Voltage (Vdc)	16		10		6.3		4		50		35		25		16		6.3		4		2.5		25		16		10		6.3		25	
Cap. / TC Code	X6S	X5R, B	X7R	X6S	X5R, B	X7R	X6S	X5R, B	X7R	X6S	X5R	X5R	X5R	X6S	X6S	X5R, B	X5R, B	X6T	X6T	X7T	X6T	X7T	X5R	X6S	X5R	X5R	X5R	X5R	X5R	X5R		
100pF																																
150pF																																
220pF																																
330pF																																
470pF																																
680pF																																
820pF																																
1000pF																																
1500pF																																
2200pF																																
3300pF																																
4700pF																																
6800pF																																
10000pF		p102																														
15000pF																																
22000pF																																
33000pF					p102																											
47000pF																																
68000pF																																
0.10μF					p102						p102																					
0.15μF					p102	p102					p102	p102																				
0.22μF		p102	p102		p102	p102			p102	p102	p102																					
0.33μF					p102	p102					p102	p102																				
0.47μF	p102				p102	p102					p102	p102																				
0.68μF					p102	p102					p102	p102																				
1.0μF		p102	p102		p102	p102	p102				p102	p102																				
2.2μF					p102						p102	p102																				
4.7μF																																
10μF																																
22μF																																
47μF																																
100μF																																
150μF																																
220μF																																

Continued on the following page. ↗

Capacitance Table

(→ GRM Series High Dielectric Constant Type)

L×W (mm)	1.0×0.5										1.6×0.8													
	0.7					0.5					0.55				0.9									
T max. (mm)	0.7					0.5					0.55				0.9									
Rated Voltage (Vdc)	16	10	6.3	4	2.5	25	16	6.3	4	16	10	6.3	250	200	25	16	10	6.3						
Cap. / TC Code	X6S	X5R	X7S	X6S	X7S	X5R	X5R	X5R, B	X5R, B	X5R	X5R	X6S	X5R	X7T	X6S	X7R	X7R	X7R	X5R, B	X6S	X5R, B	X7R	X5R	X6S
100pF																								
150pF																								
220pF																								
330pF																								
470pF																								
680pF																								
820pF																								
1000pF																								
1500pF																								
2200pF																								
3300pF																								
4700pF																								
6800pF																								
10000pF																								
15000pF																								
22000pF																								
33000pF																								
47000pF																								
68000pF																								
0.10μF																								
0.15μF																								
0.22μF																								
0.33μF																								
0.47μF																								
0.68μF																								
1.0μF																								
2.2μF																								
4.7μF																								
10μF																								
22μF																								
47μF																								
100μF																								
150μF																								
220μF																								

Continued on the following page. ↗

Capacitance Table

(→ GRM Series High Dielectric Constant Type)

p00 ← Part Number List JIS: R B EIA: X7R X7S X7T X7U X6S X6T X5R

L×W (mm)	1.6×0.8														2.0×1.25											
T max. (mm)	0.9		0.95				1.0								0.7	0.95										
Rated Voltage (Vdc)	6.3	4	25	16	10	50	35	25	16	10	6.3	4	16	50	35	25										
Cap. / TC Code	X5R, B	X5R	X5R	X6S	X5R, B	X7S	X5R, B	X5R	X6S	X5R	X7S	X6S	X5R	X7S	X6S	X7T	X7T	X5R, B	X6S	X5R, B	X6S	X5R, B	X6S	X5R	X7R	
100pF																										
150pF																										
220pF																										
330pF																										
470pF																										
680pF																										
820pF																										
1000pF																										
1500pF																										
2200pF																										
3300pF																										
4700pF																										
6800pF																										
10000pF																										
15000pF																										
22000pF																										
33000pF																										
47000pF																										
68000pF																										
0.10μF																										
0.15μF																										
0.22μF																										
0.33μF																										
0.47μF																										
0.68μF																										
1.0μF																										
2.2μF																										
4.7μF																										
10μF																										
22μF																										
47μF																										
100μF																										
150μF																										
220μF																										

Continued on the following page. ↗

Capacitance Table

(→ GRM Series High Dielectric Constant Type)

p00 ← Part Number List JIS: R B EIA: X7R X7S X7T X7U X6S X6T X5R

L×W (mm)	2.0×1.25																									
T max. (mm)	0.95						1.0						1.35		1.4											
Rated Voltage (Vdc)	25	16	10	6.3	4	2.5	500	250	200	35	25	16	25	16	50	25										
Cap. / TC Code	X6S	X5R, B	X7R	X5R, B	X7Δ	X5R, B	X6S	X5R, B	X6S	X5R	X6T	X7R	X7R	X7R	X6S	X7S	X6S	X7S	X5R	X6S	X5R, B	X7R	X5R, B	X5R, B	X7R	
100pF																										
150pF																										
220pF																										
330pF																										
470pF																										
680pF																										
820pF																										
1000pF																										
1500pF																										
2200pF																										
3300pF																										
4700pF																										
6800pF																										
10000pF																										
15000pF																										
22000pF																										
33000pF																										
47000pF																										
68000pF																										
0.10μF																										
0.15μF																										
0.22μF																										
0.33μF																										
0.47μF																										
0.68μF																										
1.0μF																										
2.2μF	p104	p104	p104	p104	p104																					
4.7μF		p104		p104	p104	p104																				
10μF		p104	p104				p104		p104																	
22μF							p104	p104		p104																
47μF											p104	p104														
100μF																										
150μF																										
220μF																										

Continued on the following page. ↗

Capacitance Table

(→ GRM Series High Dielectric Constant Type)

p00 ← Part Number List JIS: R B EIA: X7R X7S X7T X7U X6S X6T X5R

L×W (mm)	2.0×1.25																											
T max. (mm)	1.4										1.45																	
Rated Voltage (Vdc)	25	16	10	6.3	4	500	250	200	50	35	25	16	10	6.3	25	16	10	6.3	4	500	250	200	50	35	25	16	10	6.3
Cap. / TC Code	X5R, B	X6S	B	X7R	X6S	X7U	X6S	X7R	X7R	X7R	X7S	X6S	X7S	X6S	X5R	X7S	X6S	X5R	X7S	X6S	X5R	X7S	X6S	X5R	X7S	X6S	X5R	X7T
100pF																												
150pF																												
220pF																												
330pF																												
470pF																												
680pF																												
820pF																												
1000pF																												
1500pF																												
2200pF																												
3300pF																												
4700pF																												
6800pF																												
10000pF																												
15000pF																												
22000pF																												
33000pF																												
47000pF																												
68000pF																												
0.10μF																												
0.15μF																												
0.22μF																												
0.33μF																												
0.47μF																												
0.68μF																												
1.0μF																												
2.2μF																												
4.7μF																												
10μF	p10S	p10S	p10S	p10S																								
22μF			p10S	p10S	p10S	p10S																						
47μF																												
100μF																												
150μF																												
220μF																												

Continued on the following page. ↗

Capacitance Table

(→ GRM Series High Dielectric Constant Type)

p00 ← Part Number List	JIS: R B		EIA: X7R X7S X7T X7U X6S X6T X5R																				
	L×W (mm)	2.0×1.25						3.2×1.6															
T max. (mm)	1.45				0.95				1.0	1.25						1.8							
Rated Voltage (Vdc)	6.3	4	2.5	35	16	10	6.3	630	1000	630	500	250	200	50	25	1000	630	500	250	200	100	50	
Cap. / TC Code	X5R, B	X6S	X5R, B	X6S	X5R	X5R, B	X5R, B	X6S	X5R, B	X7R	X7R	X7R	X7R	X7R	B	X5R	X7R	X7R	X7R	X7R	X7R	X7R	X5R, B
100pF																							
150pF																							
220pF																							
330pF																							
470pF																							
680pF																							
820pF																							
1000pF																							
1500pF																							
2200pF																							
3300pF																							
4700pF																							
6800pF																							
10000pF																							
15000pF																							
22000pF																							
33000pF																							
47000pF																							
68000pF																							
0.10μF																							
0.15μF																							
0.22μF																							
0.33μF																							
0.47μF																							
0.68μF																							
1.0μF																							
2.2μF																							
4.7μF																							
10μF																							
22μF																							
47μF																							
100μF																							
150μF																							
220μF																							

Continued on the following page. ↗

Capacitance Table

(→ GRM Series High Dielectric Constant Type)

p00 ← Part Number List JIS: R B EIA: X7R X7S X7T X7U X6S X6T X5R

L×W (mm)	3.2×1.6																				3.2×2.5				
T max. (mm)	1.8										1.9										1.5				
Rated Voltage (Vdc)	25		16		10		6.3		4		25		16		10		6.3		4		2.5		1000	630	
Cap. / TC Code	X7R	X5R, B	X6S	X5R, B	X7R	X5R, B	X7Δ	X6S	X5R, B	X7U	X6S	X6S	X7S	X5R	X6S	X5R	X6T	X5R	X7U	X6Δ	X5R	X6S	X5R	X7R	X7R
100pF																									
150pF																									
220pF																									
330pF																									
470pF																									
680pF																									
820pF																									
1000pF																									
1500pF																									
2200pF																									
3300pF																									
4700pF																									
6800pF																									p106
10000pF																									p106
15000pF																									
22000pF																									p106
33000pF																									
47000pF																									
68000pF																									
0.10μF																									
0.15μF																									
0.22μF																									
0.33μF																									
0.47μF																									
0.68μF																									
1.0μF																									
2.2μF																									
4.7μF																									
10μF	p106	p106																							
22μF	p106	p106	p106	p106	p106	p106						p106	p106												
47μF					p106	p106	p106	p106	p106	p106	p106			p106	p106										
100μF																	p106	p106	p106	p106	p106	p106			
150μF																		p106		p106	p106	p106			
220μF																					p106		p106		

Continued on the following page. ↗

Capacitance Table

(→ GRM Series High Dielectric Constant Type)

p00 ← Part Number List JIS: R B EIA: X7R X7S X7T X7U X6S X6T X5R

L×W (mm)	3.2×2.5																									
T max. (mm)	1.5			1.8	2.0					2.2		2.7														
Rated Voltage (Vdc)	500	250	200	100	1000	630	500	250	200	100	25	100	80	63	50	35	25	16		10						
Cap. / TC Code	X7R	X7R	X7R	X7R	X7R	X7R	X7R	X7R	X7R	X7S	X7R	X7R	X7R	X7R	X7R	X5R,B	X7R	X5R,B	X7R	X5R,B	X7R	X6S	X5R,B	X7R	X5R,B	
100pF																										
150pF																										
220pF																										
330pF																										
470pF																										
680pF																										
820pF																										
1000pF																										
1500pF																										
2200pF																										
3300pF																										
4700pF																										
6800pF																										
10000pF																										
15000pF																										
22000pF																										
33000pF																										
47000pF																										
68000pF																										
0.10μF																										
0.15μF																										
0.22μF																										
0.33μF																										
0.47μF																										
0.68μF																										
1.0μF																										
2.2μF																										
4.7μF																										
10μF																										
22μF																										
47μF																										
100μF																										
150μF																										
220μF																										

Continued on the following page. ↗

Capacitance Table

(→ GRM Series High Dielectric Constant Type)

p00	← Part Number List			JIS: R B	EIA: X7R X7S X7T X7U X6S X6T X5R											
L×W (mm)	3.2×2.5			4.5×3.2						5.7×5.0						
T max. (mm)	2.7			1.5			2.0			2.0						
Rated Voltage (Vdc)	6.3	4	630	500	250	200	1000	630	500	250	200	1000	630	500	250	200
Cap. / TC Code	X7Δ	X5R, B	X7U	X7R	X7R	X7R	X7R	X7R	X7R	X7R	X7R	X7R	X7R	X7R	X7R	X7R
100pF																
150pF																
220pF																
330pF																
470pF																
680pF																
820pF																
1000pF																
1500pF																
2200pF																
3300pF																
4700pF																
6800pF																
10000pF																
15000pF																
22000pF																
33000pF																
47000pF																
68000pF																
0.10μF																
0.15μF																
0.22μF																
0.33μF																
0.47μF																
0.68μF																
1.0μF																
2.2μF																
4.7μF																
10μF																
22μF																
47μF																
100μF																
150μF																
220μF																

Capacitance Table

GR3 Series High Dielectric Constant Type

p00 ← Part Number List EIA: X7T

L×W (mm)	2.0×1.25		3.2×1.6						3.2×2.5				4.5×3.2			5.7×5.0								
T max. (mm)	1.0	1.45	1.0		1.25		1.8		1.5		2.0		1.5	2.0		2.0			2.7					
Rated Voltage (Vdc)	250	250	450	250	630	450	250	630	450	250	630	250	630	450	250	250	630	450	250	630	450	250	630	250
Cap. / TC Code	X7T	X7T	X7T	X7T	X7T	X7T	X7T	X7T	X7T	X7T	X7T	X7T	X7T	X7T	X7T	X7T	X7T	X7T	X7T	X7T	X7T	X7T	X7T	X7T
10000pF	p110		p110		p110																			
15000pF	p110		p110				p110																	
22000pF		p110				p110				p110														
33000pF				p110		p110							p110											
47000pF							p110		p110					p110										
68000pF									p110					p110				p110						
0.10μF										p110				p110							p110			
0.15μF															p110			p110			p110			
0.22μF																p110					p110		p110	
0.33μF																			p110			p110		
0.47μF																					p110	p110		
0.68μF																						p110		
1.0μF																								p110

Capacitance Table

GRJ Series High Dielectric Constant Type

p00 ← Part Number List EIA: X7R X7S X5R

L×W (mm)	1.6×0.8						2.0×1.25										3.2×1.6						
T max. (mm)	0.9						1.0	0.7	0.95	1.0	1.45						1.5	0.95	1.25				
Rated Voltage (Vdc)	100	50	35	25	16	6.3	6.3	100	50	100	250	250	100	50	25	16	10	100	100	50	1000	630	
Cap. / TC Code	X7R	X7R	X5R	X7R	X7R	X7R	X7S	X7R	X7R	X7R	X7R	X7R	X7R	X7R	X7R	X7R	X7R	X7S	X7R	X7R	X7R	X7R	
220pF										p121													
470pF									p121	p121												p122	
680pF																						p122	
1000pF	p121	p121						p121	p121		p121											p122	p122
1500pF											p121											p122	p122
2200pF	p121	p121						p121	p121		p121											p122	p122
3300pF											p121											p122	p122
4700pF	p121	p121						p121	p121		p121											p122	p122
6800pF											p121												p122
10000pF	p121	p121						p121	p121			p121											p122
15000pF												p121											
22000pF	p121	p121						p121	p121			p121											
33000pF																							
47000pF		p121		p121									p121	p121									
68000pF																							
0.10μF	p121	p121											p121	p121						p122	p122		
0.15μF																							
0.22μF		p121		p121												p121							
0.33μF																							
0.47μF					p121											p121							
0.68μF																							
1.0μF			p121	p121											p121	p121			p121				
2.2μF						p121											p121						
4.7μF							p121											p121					
10μF																			p121				
22μF																							
47μF																							

L×W (mm)	3.2×2.5						4.5×3.2						5.7×5.0		
T max. (mm)	2.8						2.85	1.5	2.0			2.0			
Rated Voltage (Vdc)	50	25	16	10	6.3	25	630	250	1000	630	250	1000	630	250	
Cap. / TC Code	X7R	X7S	X7R	X7R	X7R	X7R	X7S	X7R	X7R	X7R	X7R	X7R	X7R	X7R	
33000pF										p123					
47000pF										p123					
68000pF								p123				p123			
0.10μF										p123		p123			
0.15μF									p123				p123		
0.22μF											p123		p123		
0.33μF												p123		p123	
0.47μF												p123		p123	
0.68μF													p123	p123	
1.0μF														p123	
2.2μF															
4.7μF	p122														
10μF	p122	p122	p122												
22μF				p122	p122		p122								
47μF					p122	p122									

3.2×1.6														3.2×2.5						L×W (mm)			
1.25		1.35				1.8			1.9					1.5			2.0			2.3	T max. (mm)		
250	100	50	25	16	1000	630	250	100	50	25	16	10	6.3	1000	630	250	1000	630	250	100		Rated Voltage (Vdc)	
X7R	X7R	X7R	X7R	X7R	X7R	X7R	X7R	X7R	X7R	X7R	X7R	X7R	X7R	X7R	X7R	X7R	X7R	X7R	X7R	X7R	X7R	X7S	Cap. / TC Code
																							220pF
																							470pF
																							680pF
																							1000pF
																							1500pF
																							2200pF
																							3300pF
																							4700pF
						p122																	6800pF
					p122																		10000pF
	p122						p122																15000pF
	p122						p122																22000pF
																							33000pF
																							47000pF
	p122																						68000pF
																							0.10μF
																							0.15μF
																							0.22μF
																							0.33μF
																							0.47μF
																							0.68μF
																							1.0μF
																							2.2μF
																							4.7μF
																							10μF
																							22μF
																							47μF

Continued to the following table. ↗

Capacitance Table

GR4 Series High Dielectric Constant Type

p00 ← Part Number List EIA: X7R

L×W (mm)	0.4×0.2	4.5×3.2		5.7×5.0
T max. (mm)	1.5	1.5	2.0	2.0
Rated Voltage (Vdc)	2000	2000	2000	2000
Cap. / TC Code	X7R	X7R	X7R	X7R
100pF	p126			
120pF	p126			
150pF	p126			
180pF	p126			
220pF	p126			
270pF	p126			
330pF	p126			
390pF	p126			
470pF	p126			
560pF	p126			
680pF	p126			
820pF	p126			
1000pF	p126			
1200pF	p126			
1500pF	p126			
1800pF		p126		
2200pF		p126		
2700pF		p126		
3300pF		p126		
3900pF		p126		
4700pF			p126	
10000pF				p126

GR7 Series High Dielectric Constant Type

p00 ← Part Number List EIA: X7T

L×W (mm)	2.0×1.25		3.2×1.6		
T max. (mm)	1.0	1.45	1.0	1.25	1.8
Rated Voltage (Vdc)	350	350	350	350	350
Cap. / TC Code	X7T	X7T	X7T	X7T	X7T
10000pF	p131		p131		
15000pF	p131		p131		
22000pF		p131	p131	p131	
27000pF		p131	p131		
33000pF			p131	p131	
47000pF					p131

GJM Series Temperature Compensating Type

p00 ← Part Number List JIS: CK CJ CH EIA: COG

L×W (mm)	0.4×0.2		0.6×0.3				1.0×0.5			
T max. (mm)	0.22		0.33				0.55			
Rated Voltage (Vdc)	25		50		25		50			
Cap. / TC Code	COG	CΔ	COG	CK	CJ	CH	COG	CΔ	COG	CΔ
0.10pF									p149	p153
0.20pF	p136	p139	p142	p142		p142			p149	p153
1.0pF	p136	p139		p142			p143	p146	p149	p153
2.0pF	p136	p139		p142			p143	p146	p149	p153
3.0pF	p136	p139			p142		p143	p146	p150	p153
4.0pF	p137	p140					p143	p147	p150	p154
5.0pF	p137	p140					p144	p147	p150	p154
6.0pF	p137	p140					p144	p147	p151	p154
7.0pF	p138	p141					p144	p148	p151	p155
8.0pF	p138	p141					p145	p148	p151	p155
9.0pF	p138	p142					p145	p148	p152	p155
10pF	p139	p142					p146	p149	p152	p156
11pF	p139	p142					p146	p149	p152	p156
12pF	p139	p142					p146	p149	p152	p156
13pF	p139	p142					p146	p149	p152	p156
15pF	p139	p142					p146	p149	p152	p156
16pF	p139	p142					p146	p149	p152	p156
18pF	p139	p142					p146	p149	p152	p156
20pF	p139	p142					p146	p149	p152	p156
22pF	p139	p142					p146	p149	p152	p156
24pF							p146	p149	p152	p156
27pF							p146	p149	p152	p156
30pF							p146	p149	p152	p156
33pF							p146	p149	p152	p156
36pF									p152	p156
39pF									p152	p156
43pF									p152	p156
47pF									p153	p156

The indication for every 0.1 pF has been omitted for less than 10 pF. Refer to the Part Number List for details.

Capacitance Table

GQM Series Temperature Compensating Type

p00 ← Part Number List EIA: COG Murata Temperature Characteristic: X8G

L×W (mm)	1.0×0.5		1.6×0.8		2.0×1.25		2.8×2.8
T max. (mm)	0.55		0.8		1.0		1.35
Rated Voltage (Vdc)	200	100	250	500	250	500	
Cap. / TC Code	COG	COG	COG	X8G	X8G	COG	X8G
0.10pF	p165						
1.0pF	p165		p166	p166	p167	p168	p169
1.1pF	p165		p166	p166	p167	p168	p169
1.2pF	p165		p166	p167	p167	p168	p169
1.3pF	p165		p166	p167	p167	p168	p169
1.5pF	p165		p166	p167	p167	p168	p169
1.6pF	p165		p166	p167	p167	p168	p169
1.8pF	p165		p166	p167	p167	p168	p169
2.0pF	p165		p166	p167	p167	p168	p169
2.2pF	p165		p166	p167	p167	p168	p169
2.4pF	p165		p166	p167	p167	p168	p169
2.7pF	p165		p166	p167	p167	p168	p169
3.0pF	p165		p166	p167	p168	p168	p169
3.3pF	p165		p166	p167	p168	p168	p169
3.6pF	p165		p166	p167	p168	p168	p169
3.9pF	p165		p166	p167	p168	p168	p169
4.0pF	p165		p166	p167	p168	p168	p169
4.3pF	p165		p166	p167	p168	p168	p169
4.7pF	p165		p166	p167	p168	p168	p169
5.0pF	p165		p166	p167	p168	p168	p169
5.1pF	p165		p166	p167	p168	p168	p169
5.6pF	p165		p166	p167	p168	p168	p169
6.0pF	p165		p166	p167	p168	p168	p169
6.2pF	p165		p166	p167	p168	p168	p169
6.8pF	p165		p166	p167	p168	p168	p169
7.0pF	p165		p166	p167	p168	p168	p169
7.5pF	p165		p166	p167	p168	p168	p170
8.0pF	p165		p166	p167	p168	p169	p170
8.2pF	p165		p166	p167	p168	p169	p170
9.0pF	p165		p166	p167	p168	p169	p170
9.1pF	p165		p166	p167	p168	p169	p170
10pF	p165		p166	p167	p168	p169	p170
11pF	p165		p166	p167	p168	p169	p170
12pF	p165		p166	p167	p168	p169	p170
13pF	p165		p166	p167	p168	p169	p170
15pF	p165		p166	p167	p168	p169	p170
16pF	p165		p166	p167	p168	p169	p170
18pF	p165		p166	p167	p168	p169	p170
20pF	p165		p166	p167	p168	p169	p170
22pF	p165		p166	p167	p168	p169	p170
24pF	p165		p166	p167		p169	p170
27pF	p165		p166	p167		p169	p170
30pF	p165		p166	p167		p169	p170
33pF	p165		p166			p169	p170
36pF		p165	p166			p169	p170
39pF		p166	p166			p169	p170
43pF		p166	p166			p169	p170
47pF		p166	p166			p169	p170
51pF						p169	p170
56pF						p169	p170
62pF						p169	p170
68pF						p169	p170
75pF						p169	p170
82pF						p169	p170
91pF						p169	p171
100pF						p169	p171

The indication for every 0.1 pF has been omitted for less than 10 pF.
 Refer to the Part Number List for details.

Capacitance Table

GR2 Series High Dielectric Constant Type

p00 ← Part Number List EIA: X7R

L×W (mm)	4.5×2.0	4.5×3.2		5.7×5.0
T max. (mm)	1.5	1.5	2.0	2.0
Rated Voltage (Vac)	250	250	250	250
Cap. / TC Code	X7R	X7R	X7R	X7R
470pF	p185			
1000pF	p185			
2200pF		p185		
3300pF		p185		
4700pF			p185	
10000pF		p185		
22000pF		p185		
47000pF			p185	
0.10μF				p185

GA3 Series Type GD Temperature Compensating Type

p00 ← Part Number List JIS: SL

L×W (mm)	4.5×2.0
T max. (mm)	1.0
Rated Voltage (Vac)	250
Cap. / TC Code	SL
10pF	p197
12pF	p197
15pF	p197
18pF	p197
22pF	p197
27pF	p197
33pF	p197
39pF	p197
47pF	p197
56pF	p197
68pF	p197
82pF	p197

GA3 Series Type GB High Dielectric Constant Type

p00 ← Part Number List EIA: X7R

L×W (mm)	5.7×5.0			
T max. (mm)	1.5	2.0	2.5	2.9
Rated Voltage (Vac)	250	250	250	250
Cap. / TC Code	X7R	X7R	X7R	X7R
10000pF	p191			
15000pF	p191			
22000pF		p191		
33000pF			p191	
47000pF			p191	
56000pF				p191

GA3 Series Type GD High Dielectric Constant Type

p00 ← Part Number List EIA: X7R

L×W (mm)	4.5×2.0	4.5×3.2	
T max. (mm)	1.5	1.5	2.0
Rated Voltage (Vac)	250	250	250
Cap. / TC Code	X7R	X7R	X7R
100pF	p198		
150pF	p198		
220pF	p198		
330pF	p198		
470pF	p198		
680pF	p198		
1000pF	p198		
1500pF	p198		
1800pF		p198	
2200pF		p198	
4700pF			p198

Capacitance Table

GA3 Series Type GF Temperature Compensating Type

p00 ← Part Number List JIS: SL

L×W (mm)	4.5×2.0
T max. (mm)	1.0
Rated Voltage (Vac)	250
Cap. / TC Code	SL
10pF	p209
12pF	p209
15pF	p209
18pF	p209
22pF	p209
27pF	p209
33pF	p209
39pF	p209
47pF	p209
56pF	p209
68pF	p209
82pF	p209

GA3 Series Type GF High Dielectric Constant Type

p00 ← Part Number List EIA: X7R

L×W (mm)	4.5×2.0		5.7×2.8		5.7×5.0	
T max. (mm)	1.5	2.2	1.5	1.5	2.0	2.0
Rated Voltage (Vac)	250	250	250	250	250	250
Cap. / TC Code	X7R	X7R	X7R	X7R	X7R	X7R
100pF	p210		p210			
150pF	p210		p210			
220pF		p210	p210			
330pF		p210	p210			
470pF	p210		p210			
680pF	p210		p210			
1000pF		p210	p210			
1500pF			p210			
1800pF				p210		
2200pF				p210		
3300pF				p210		
4700pF					p210	

Capacitance Table

LLL Series High Dielectric Constant Type

p00 ← Part Number List EIA: X7R X7S X6S X5R

L×W (mm)	0.5×1.0			0.6×1.0	0.8×1.6								1.25×2.0										
T max. (mm)	0.35			0.45	0.5				0.55	0.6				0.5						0.7			
Rated Voltage (Vdc)	6.3	4		4	25	16	10	4	4	50	25	16	10	4	50	25	16	10	6.3	4	50	25	
Cap. / TC Code	X6S	X7S	X6S	X5R	X7R	X7R	X7R	X7S	X7S	X7R	X7R	X7R	X7R	X7S	X7R	X7R	X7R	X7R	X7R	X7S	X7R	X7R	
2200pF										p220													
4700pF										p220													
10000pF					p220										p220							p220	
22000pF						p220										p220						p220	
47000pF							p220						p220					p220					p220
0.10μF	p220							p220															p220
0.22μF	p220								p220														
0.47μF		p220																					
1.0μF			p220																				p220
2.2μF									p220														
4.3μF					p220																		
4.7μF																							
10μF																							

Continued to the following table. ↗

L×W (mm)	1.25×2.0				1.6×3.2																	
T max. (mm)	0.7		0.95		0.5				0.8						1.25							
Rated Voltage (Vdc)	10	16	10	4	50	25	16	10	50	25	16	10	6.3	50	25	16	10	6.3				
Cap. / TC Code	X7R	X7R	X7R	X7S	X7R	X7R	X7R	X7R	X7R	X7R	X7R	X7R	X7R	X7R	X7R	X7R	X7R	X7R	X5R			
2200pF																						
4700pF																						
10000pF					p220																	
22000pF						p220																
47000pF							p220															
0.10μF								p220														
0.22μF	p220	p220							p220													
0.47μF			p220							p220												
1.0μF				p220																		
2.2μF					p220																	
4.3μF																						
4.7μF																						
10μF																						p220

LLA Series High Dielectric Constant Type

p00 ← Part Number List EIA: X7R X7S

L×W (mm)	1.6×0.8	2.0×1.25												
T max. (mm)	0.55	0.55					0.95							
Rated Voltage (Vdc)	4	25	16	10	6.3	4	25	16	10	6.3	4			
Cap. / TC Code	X7S	X7R	X7R	X7R	X7R	X7S	X7R	X7R	X7R	X7R	X7S			
10000pF		p223									p223			
22000pF		p223									p223			
47000pF			p223								p223			
0.10μF	p223			p223							p223			
0.22μF	p223				p223						p223			
0.47μF	p223					p223					p223			
1.0μF							p223					p223		
2.2μF	p223												p223	
4.7μF														p223

Capacitance Table

LLM Series High Dielectric Constant Type

p00 ← Part Number List EIA: X7R X7S

L×W (mm)	2.0×1.25	
T max. (mm)	0.55	
Rated Voltage (Vdc)	6.3	4
Cap. / TC Code	X7R	X7S
0.22μF	p229	
0.47μF	p229	
1.0μF		p229

LLR Series High Dielectric Constant Type

p00 ← Part Number List EIA: X7S

L×W (mm)	0.8×1.6			
T max. (mm)	0.55			
Rated Voltage (Vdc)	4			
TC Code	X7S			
Cap. / ESR (mΩ)	100	220	470	1000
1.0μF	p233	p233	p233	p233

NFM Series

p00 ← Part Number List

L×W (mm)	1.0×0.5								1.6×0.8				2.0×1.25						3.2×1.25	3.2×1.6			4.5×1.6		
	0.35		0.5				0.65	0.7	0.7		0.9		0.95						0.9	1.5			1.2		
Rated Voltage (Vdc)	6.3	4	16	10	6.3	2.5	2.5	2.5	16	6.3	10	6.3	50	25	16	10	6.3	50	100	50	6.3	100	50	25	
Cap. / TC Code	-	-	-	-	-	-	-	-	-	-	-	-	-	-	-	-	-	-	-	-	-	-	-	-	
100pF									p237																
220pF									p237				p237					p237							
470pF									p237				p237					p237					p237		
1000pF									p237				p237					p237					p237		
2200pF			p237	p237					p237				p237					p237					p237		
10000pF																			p237	p237					
15000pF																			p237	p237					
22000pF			p237	p237					p237				p237					p237	p237	p237			p237		
47000pF			p237	p237																					
0.10μF				p237	p237				p237						p237				p237	p237					
0.20μF																									
0.22μF				p237	p237																				
0.47μF	p237	p237																							
1.0μF		p237																							
1.5μF																									
2.2μF																									
4.3μF																									
4.7μF																									
7.5μF																									
9.1μF																									
10μF																									
27μF																									

Capacitance Table

KRM Series High Dielectric Constant Type

p00 ← Part Number List EIA: X7R X7S X6S X5R

L×W (mm)	2.2×1.25					3.5×1.7					3.6×1.7	3.7×1.85	6.1×5.3												
T max. (mm)	1.9		2.0			2.0		2.9			2.9		2.9		3.0										3.9
Rated Voltage (Vdc)	25	16	25			25	100	50	35	25	50	100	1000	630	450	250	100	63	50	35	25	100			
Cap. / TC Code	X5R	X5R	X7S	X6S	X5R	X5R	X7R	X7R	X6S	X6S	X7R	X7R	X7R	X7R	X7R	X7R	X7R	X7R	X7R	X7R	X7R	X7R			
68000pF																							p241		
0.10μF																							p241		
0.15μF																							p241		
0.22μF																							p241		
0.33μF																							p241		
0.47μF																							p241		
0.68μF																							p241		
1.0μF											p241												p241		
1.5μF																									
2.2μF																							p241 p241		
4.7μF																							p241		
6.8μF																							p241 p241 p241		
10μF	p241	p241	p241	p241																			p241		
15μF																							p241 p241		
17μF																									
22μF																							p241		
33μF																									
47μF																									
68μF																									
100μF																									

Continued to the following table. ↗

L×W (mm)	6.1×5.3																			
T max. (mm)	3.9					5.0							6.7							
Rated Voltage (Vdc)	63	50	35	25		1000	630	450	250	100	50	35	25	100	63	50	35	25		
Cap. / TC Code	X7R	X7R	X7R	X7R	X7S	X7R	X7R	X7R	X7R	X7R	X7R	X7R	X7R	X7R	X7R	X7R	X7R	X7R	X7S	
68000pF																				
0.10μF																				
0.15μF																				
0.22μF																				
0.33μF																				
0.47μF																				
0.68μF																				
1.0μF																				
1.5μF																				
2.2μF																				
4.7μF																				
6.8μF																				
10μF	p241																			
15μF																				
17μF																				
22μF																				
33μF																				
47μF																				
68μF																				
100μF																				

Capacitance Table

KR3 Series High Dielectric Constant Type

p00 ← Part Number List EIA: X7T

L×W (mm)	6.1×5.3										
T max. (mm)	3.0			3.9			5.0		6.7		
Rated Voltage (Vdc)	630	450	250	630	450	250	450	250	630	450	250
Cap. / TC Code	X7T	X7T	X7T	X7T	X7T	X7T	X7T	X7T	X7T	X7T	X7T
0.10μF	p245										
0.15μF	p245										
0.22μF		p245		p245							
0.27μF				p245							
0.33μF		p245									
0.47μF		p245	p245						p245		
0.56μF					p245				p245		
0.68μF			p245				p245				
1.0μF						p245	p245				
1.2μF										p245	
1.5μF								p245			
2.2μF											p245

GMA Series High Dielectric Constant Type

p00 ← Part Number List JIS: R B EIA: X7R X5R

L×W (mm)	0.38×0.38			0.5×0.5						0.8×0.8									
T max. (mm)	0.35			0.4						0.6									
Rated Voltage (Vdc)	10			100	25	10			6.3	100	25	10			6.3				
Cap. / TC Code	X7R	R	B	X7R	X7R	B	X7R	R	B	X5R	B	X7R	X7R	B	X7R	R	B	X5R	B
100pF				p251															
150pF				p251															
220pF				p251															
330pF				p251															
470pF				p251															
680pF				p251															
1000pF	p251	p251	p251	p251															
1500pF	p251	p251	p251		p251	p251						p251							
1800pF	p251	p251	p251																
2200pF					p251	p251						p251							
3300pF					p251	p251						p251							
4700pF					p251	p251						p251							
6800pF							p251	p251	p251			p251							
10000pF	p251	p251					p251	p251	p251				p251	p251					
15000pF							p251	p251	p251				p251	p251					
22000pF							p251	p251	p251				p251	p251					
33000pF															p251	p251	p251		
47000pF															p251	p251	p251		
68000pF															p251	p251	p251		
0.10μF											p251	p251			p251	p251	p251		
0.47μF																		p251	p251

Capacitance Table

GMD Series High Dielectric Constant Type

p00 ← Part Number List JIS: R B EIA: X7R X5R

L×W (mm)	0.6×0.3										1.0×0.5												
T max. (mm)	0.33										0.55												
Rated Voltage (Vdc)	25			16			10			6.3		50			25			16			10		
Cap. / TC Code	X7R	R	B	X7R	R	B	X7R	R	B	X5R	B	X7R	R	B	X7R	R	B	X7R	R	B	X5R	B	
100pF	p257	p257	p257																				
120pF	p257	p257	p257																				
150pF	p257	p257	p257																				
180pF	p257	p257	p257																				
220pF	p257	p257	p257									p257	p257	p258									
270pF	p257	p257	p257									p257	p258	p258									
330pF	p257	p257	p257									p257	p258	p258									
390pF	p257	p257	p257									p257	p258	p258									
470pF	p257	p257	p257									p257	p258	p258									
560pF	p257	p257	p257									p257	p258	p258									
680pF	p257	p257	p257									p257	p258	p258									
820pF	p257	p257	p257									p257	p258	p258									
1000pF	p257	p257	p257									p257	p258	p258									
1200pF	p257	p257	p257									p257	p258	p258									
1500pF	p257	p257	p257									p257	p258	p258									
1800pF				p257	p257	p257						p257	p258	p258									
2200pF				p257	p257	p257						p257	p258	p258									
2700pF				p257	p257	p257						p257	p258	p258									
3300pF				p257	p257	p257						p257	p258	p258									
3900pF							p257	p257	p257			p257	p258	p258									
4700pF							p257	p257	p257			p257	p258	p258									
5600pF							p257	p257	p257						p258	p258	p258						
6800pF							p257	p257	p257						p258	p258	p258						
8200pF							p257	p257	p257						p258	p258	p258						
10000pF							p257	p257	p257						p258	p258	p258						
12000pF															p258	p258	p258						
15000pF															p258	p258	p258						
18000pF															p258	p258	p258						
22000pF															p258	p258	p258						
27000pF															p258	p258	p258						
33000pF															p258	p258	p258						
39000pF															p258	p258	p258						
47000pF															p258	p258	p258						
56000pF										p257	p257							p258	p258	p258			
68000pF										p257	p257							p258	p258	p258			
82000pF										p257	p257							p258	p258	p258			
0.10μF										p257	p257							p258	p258	p258			
0.12μF																					p258	p258	
0.15μF																					p258	p258	
0.18μF																					p258	p258	
0.22μF																					p258	p258	
0.27μF																					p258	p258	
0.33μF																					p258	p258	
0.39μF																					p258	p258	
0.47μF																					p258	p258	

Search Capacitors

Specifications and Test Methods, Package, Chart of Characteristic Data, please refer to the search web page.
<https://www.murata.com/en-global/products/capacitor>

Links are provided to the product detail pages on the web, and are shown below in the product number table from the PDF version of the catalog which is available on the web.

GRM Series Temperature Compensating

0.4x0.2mm

T max.	Rated Voltage	TC Code	Cap.	Tol.	Part Number
0.22mm	50Vdc	COG	0.20pF	±0.05pF	GRM0225C1HR20WA03#
				±0.1pF	GRM0225C1HR20BA03#
			0.30pF	±0.05pF	GRM0225C1HR30WA03#
				±0.1pF	GRM0225C1HR30BA03#
			0.40pF	±0.05pF	GRM0225C1HR40WA03#
				±0.1pF	GRM0225C1HR40BA03#
			0.50pF	±0.05pF	GRM0225C1HR50WA03#
				±0.1pF	GRM0225C1HR50BA03#



Status and Features Icons

The status and features of products can be checked at once. When ? is clicked, a description of each icon will be displayed

Stock Check (Where to buy)

Some products can request free samples. Reference inventory information from agents and web-based companies.

Data Sheet

The product details page can be output in PDF.

How to read part numbers

Describes the meaning of the part number

Series Information

This links to the introduction page of each series.

Detailed Specifications Sheet

- Rated value
- Specifications and Test Methods
- Package
- Caution, Notice (Storage, Soldering and Mounting,etc.)

Characteristics Data

The following characteristics data of the main products can be acquired.

- SPICE Netlist (mod type)
- S parameter (S2P type)
- Reliability Test Data *Typical data

- Shape (Dimensions)
- Rated Values

- Specification by Packaging Code/ Minimum Order Quantity
- Weight (1 pc/ø180mm reel)

Chart of Characteristic Data

The main products published characteristic data.

- Frequency characteristics (ESR, Impedance)
- DC bias characteristics
- AC voltage characteristics
- Capacitance - temperature characteristics
- Calorific property by ripple current

Design Tools SimSurfing

The SimSurfing design tools are useful for displaying the graph, downloading CSV data and overwriting the product number graph.

Chip Multilayer Ceramic Capacitors for General Purpose

GRM Series



This is Murata primary products renowned for both small size and large capacitance value with latest advanced technology.

Features

① Achieves large-capacity and small size in a multilayer structure.

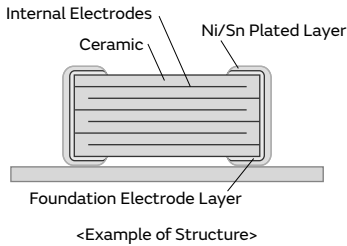

"Thin Layer Technology" for thinner layers

"Fine Particle Technology" for finer particles

"High Precision Lamination Technology" for more accuracy

② Sn plating is applied to the external electrodes; excellent solderability.

③ High reliability with no polarity.

	Ceramic Capacitors	Tantalum Capacitor	Aluminum Electrolytic Capacitor	Conductive Polymer Capacitor
Price	○	○	◎	○
Comparison between Impedance Frequency Characteristics	◎	△	△	○
Capacitance temperature characteristics	○	◎	○	○
DC breakdown voltage	◎	△	△	△
Polarity	No	Yes	Yes	Yes
Pulse response	◎	△	△	○
Allowable ripple current	◎	△	△	△
Reliability	◎	○	○	○
DC bias characteristics	△	◎	◎	◎

◎: Particularly excellent ○: Excellent △: Inferior

Specifications

Size (mm)	0.25×0.125mm to 5.7×5.0mm
Rated Voltage	2.5Vdc to 3150Vdc
Capacitance	0.10pF to 330µF
Main Applications	1. Rated voltage 100V Max. High Dielectric Constant Type . . . For decoupling and smoothing circuits Temperature Compensating Type . . . For tuning circuits, oscillating circuits, and high frequency filter circuits 2. Rated voltage 200V min. High Dielectric Constant Type . . . For clamp snubber circuits and smoothing circuits Temperature Compensating Type . . . Power supply damper snubber

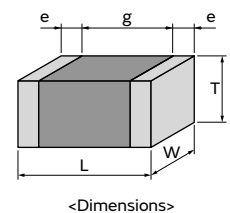

This catalog contains only a portion of the product lineup.
 Please refer to the capacitor search tool on the Murata Web site for details.

GRM
 GR3
 GRJ
 GR4
 GR7
 GJM
 GQM
 GA2
 GA3 GB
 GA3 GD
 GA3 GF
 LLL
 LLA
 LLM
 LLR
 NFM
 KRM
 KR3
 GMA
 GMD
 △Caution /Notice

GRM Series Temperature Compensating Type Part Number List

0.4×0.2mm

T max.	Rated Voltage	TC Code	Cap.	Tol.	Part Number
0.22mm	50Vdc	COG	0.20pF	±0.05pF	GRM0225C1HR20WA03#
				±0.1pF	GRM0225C1HR20BA03#
			0.30pF	±0.05pF	GRM0225C1HR30WA03#
				±0.1pF	GRM0225C1HR30BA03#
			0.40pF	±0.05pF	GRM0225C1HR40WA03#
				±0.1pF	GRM0225C1HR40BA03#
			0.50pF	±0.05pF	GRM0225C1HR50WA03#
				±0.1pF	GRM0225C1HR50BA03#
			0.60pF	±0.05pF	GRM0225C1HR60WA03#
				±0.1pF	GRM0225C1HR60BA03#
			0.70pF	±0.05pF	GRM0225C1HR70WA03#
				±0.1pF	GRM0225C1HR70BA03#
			0.80pF	±0.05pF	GRM0225C1HR80WA03#
				±0.1pF	GRM0225C1HR80BA03#
			0.90pF	±0.05pF	GRM0225C1HR90WA03#
				±0.1pF	GRM0225C1HR90BA03#
			1.0pF	±0.05pF	GRM0225C1H1R0WA03#
				±0.1pF	GRM0225C1H1R0BA03#
				±0.25pF	GRM0225C1H1R0CA03#
			1.1pF	±0.05pF	GRM0225C1H1R1WA03#
				±0.1pF	GRM0225C1H1R1BA03#
				±0.25pF	GRM0225C1H1R1CA03#
			1.2pF	±0.05pF	GRM0225C1H1R2WA03#
				±0.1pF	GRM0225C1H1R2BA03#
				±0.25pF	GRM0225C1H1R2CA03#
			1.3pF	±0.05pF	GRM0225C1H1R3WA03#
				±0.1pF	GRM0225C1H1R3BA03#
				±0.25pF	GRM0225C1H1R3CA03#
			1.4pF	±0.05pF	GRM0225C1H1R4WA03#
				±0.1pF	GRM0225C1H1R4BA03#
				±0.25pF	GRM0225C1H1R4CA03#
			1.5pF	±0.05pF	GRM0225C1H1R5WA03#
				±0.1pF	GRM0225C1H1R5BA03#
				±0.25pF	GRM0225C1H1R5CA03#
			1.6pF	±0.05pF	GRM0225C1H1R6WA03#
				±0.1pF	GRM0225C1H1R6BA03#
				±0.25pF	GRM0225C1H1R6CA03#
			1.7pF	±0.05pF	GRM0225C1H1R7WA03#
				±0.1pF	GRM0225C1H1R7BA03#
				±0.25pF	GRM0225C1H1R7CA03#
			1.8pF	±0.05pF	GRM0225C1H1R8WA03#
				±0.1pF	GRM0225C1H1R8BA03#
				±0.25pF	GRM0225C1H1R8CA03#
			1.9pF	±0.05pF	GRM0225C1H1R9WA03#
				±0.1pF	GRM0225C1H1R9BA03#
				±0.25pF	GRM0225C1H1R9CA03#
			2.0pF	±0.05pF	GRM0225C1H2R0WA03#
				±0.1pF	GRM0225C1H2R0BA03#
±0.25pF	GRM0225C1H2R0CA03#				
2.1pF	±0.05pF	GRM0225C1H2R1WA03#			
	±0.1pF	GRM0225C1H2R1BA03#			
	±0.25pF	GRM0225C1H2R1CA03#			

T max.	Rated Voltage	TC Code	Cap.	Tol.	Part Number
0.22mm	50Vdc	COG	2.2pF	±0.05pF	GRM0225C1H2R2WA03#
				±0.1pF	GRM0225C1H2R2BA03#
				±0.25pF	GRM0225C1H2R2CA03#
			2.3pF	±0.05pF	GRM0225C1H2R3WA03#
				±0.1pF	GRM0225C1H2R3BA03#
				±0.25pF	GRM0225C1H2R3CA03#
			2.4pF	±0.05pF	GRM0225C1H2R4WA03#
				±0.1pF	GRM0225C1H2R4BA03#
				±0.25pF	GRM0225C1H2R4CA03#
			2.5pF	±0.05pF	GRM0225C1H2R5WA03#
				±0.1pF	GRM0225C1H2R5BA03#
				±0.25pF	GRM0225C1H2R5CA03#
			2.6pF	±0.05pF	GRM0225C1H2R6WA03#
				±0.1pF	GRM0225C1H2R6BA03#
				±0.25pF	GRM0225C1H2R6CA03#
			2.7pF	±0.05pF	GRM0225C1H2R7WA03#
				±0.1pF	GRM0225C1H2R7BA03#
				±0.25pF	GRM0225C1H2R7CA03#
			2.8pF	±0.05pF	GRM0225C1H2R8WA03#
				±0.1pF	GRM0225C1H2R8BA03#
				±0.25pF	GRM0225C1H2R8CA03#
			2.9pF	±0.05pF	GRM0225C1H2R9WA03#
				±0.1pF	GRM0225C1H2R9BA03#
				±0.25pF	GRM0225C1H2R9CA03#
			3.0pF	±0.05pF	GRM0225C1H3R0WA03#
				±0.1pF	GRM0225C1H3R0BA03#
				±0.25pF	GRM0225C1H3R0CA03#
			3.1pF	±0.05pF	GRM0225C1H3R1WA03#
				±0.1pF	GRM0225C1H3R1BA03#
				±0.25pF	GRM0225C1H3R1CA03#
			3.2pF	±0.05pF	GRM0225C1H3R2WA03#
				±0.1pF	GRM0225C1H3R2BA03#
				±0.25pF	GRM0225C1H3R2CA03#
			3.3pF	±0.05pF	GRM0225C1H3R3WA03#
				±0.1pF	GRM0225C1H3R3BA03#
				±0.25pF	GRM0225C1H3R3CA03#
			3.4pF	±0.05pF	GRM0225C1H3R4WA03#
				±0.1pF	GRM0225C1H3R4BA03#
				±0.25pF	GRM0225C1H3R4CA03#
			3.5pF	±0.05pF	GRM0225C1H3R5WA03#
				±0.1pF	GRM0225C1H3R5BA03#
				±0.25pF	GRM0225C1H3R5CA03#
			3.6pF	±0.05pF	GRM0225C1H3R6WA03#
				±0.1pF	GRM0225C1H3R6BA03#
				±0.25pF	GRM0225C1H3R6CA03#
			3.7pF	±0.05pF	GRM0225C1H3R7WA03#
				±0.1pF	GRM0225C1H3R7BA03#
				±0.25pF	GRM0225C1H3R7CA03#
3.8pF	±0.05pF	GRM0225C1H3R8WA03#			
	±0.1pF	GRM0225C1H3R8BA03#			
	±0.25pF	GRM0225C1H3R8CA03#			
3.9pF	±0.05pF	GRM0225C1H3R9WA03#			
	±0.1pF	GRM0225C1H3R9BA03#			
	±0.25pF	GRM0225C1H3R9CA03#			

Part number # indicates the package specification code.

- GRM
- GR3
- GRJ
- GR4
- GR7
- GJM
- GQM
- GA2
- GA3 GB
- GA3 GD
- GA3 GF
- LLL
- LLA
- LLM
- LLR
- NFM
- KRM
- KR3
- GMA
- GMD
- ⚠Caution /Notice

GRM Series Temperature Compensating Type Part Number List

(→ 0.4×0.2mm)

T max.	Rated Voltage	TC Code	Cap.	Tol.	Part Number	T max.	Rated Voltage	TC Code	Cap.	Tol.	Part Number
0.22mm	50Vdc	COG	4.0pF	±0.05pF	GRM0225C1H4R0WA03#	0.22mm	50Vdc	COG	5.6pF	±0.1pF	GRM0225C1H5R6BA03#
				±0.1pF	GRM0225C1H4R0BA03#					±0.25pF	GRM0225C1H5R6CA03#
				±0.25pF	GRM0225C1H4R0CA03#					±0.5pF	GRM0225C1H5R6DA03#
			4.1pF	±0.05pF	GRM0225C1H4R1WA03#				5.7pF	±0.05pF	GRM0225C1H5R7WA03#
				±0.1pF	GRM0225C1H4R1BA03#					±0.1pF	GRM0225C1H5R7BA03#
				±0.25pF	GRM0225C1H4R1CA03#					±0.25pF	GRM0225C1H5R7CA03#
			4.2pF	±0.05pF	GRM0225C1H4R2WA03#				5.8pF	±0.05pF	GRM0225C1H5R8WA03#
				±0.1pF	GRM0225C1H4R2BA03#					±0.1pF	GRM0225C1H5R8BA03#
				±0.25pF	GRM0225C1H4R2CA03#					±0.25pF	GRM0225C1H5R8CA03#
			4.3pF	±0.05pF	GRM0225C1H4R3WA03#				5.9pF	±0.05pF	GRM0225C1H5R9WA03#
				±0.1pF	GRM0225C1H4R3BA03#					±0.1pF	GRM0225C1H5R9BA03#
				±0.25pF	GRM0225C1H4R3CA03#					±0.25pF	GRM0225C1H5R9CA03#
			4.4pF	±0.05pF	GRM0225C1H4R4WA03#				6.0pF	±0.05pF	GRM0225C1H6R0WA03#
				±0.1pF	GRM0225C1H4R4BA03#					±0.1pF	GRM0225C1H6R0BA03#
				±0.25pF	GRM0225C1H4R4CA03#					±0.25pF	GRM0225C1H6R0CA03#
			4.5pF	±0.05pF	GRM0225C1H4R5WA03#				6.1pF	±0.05pF	GRM0225C1H6R1WA03#
				±0.1pF	GRM0225C1H4R5BA03#					±0.1pF	GRM0225C1H6R1BA03#
				±0.25pF	GRM0225C1H4R5CA03#					±0.25pF	GRM0225C1H6R1CA03#
			4.6pF	±0.05pF	GRM0225C1H4R6WA03#				6.2pF	±0.05pF	GRM0225C1H6R2WA03#
				±0.1pF	GRM0225C1H4R6BA03#					±0.1pF	GRM0225C1H6R2BA03#
				±0.25pF	GRM0225C1H4R6CA03#					±0.25pF	GRM0225C1H6R2CA03#
			4.7pF	±0.05pF	GRM0225C1H4R7WA03#				6.3pF	±0.05pF	GRM0225C1H6R3WA03#
				±0.1pF	GRM0225C1H4R7BA03#					±0.1pF	GRM0225C1H6R3BA03#
				±0.25pF	GRM0225C1H4R7CA03#					±0.25pF	GRM0225C1H6R3CA03#
			4.8pF	±0.05pF	GRM0225C1H4R8WA03#				6.4pF	±0.05pF	GRM0225C1H6R4WA03#
				±0.1pF	GRM0225C1H4R8BA03#					±0.1pF	GRM0225C1H6R4BA03#
				±0.25pF	GRM0225C1H4R8CA03#					±0.25pF	GRM0225C1H6R4CA03#
			4.9pF	±0.05pF	GRM0225C1H4R9WA03#				6.5pF	±0.05pF	GRM0225C1H6R5WA03#
				±0.1pF	GRM0225C1H4R9BA03#					±0.1pF	GRM0225C1H6R5BA03#
				±0.25pF	GRM0225C1H4R9CA03#					±0.25pF	GRM0225C1H6R5CA03#
			5.0pF	±0.05pF	GRM0225C1H5R0WA03#				6.6pF	±0.05pF	GRM0225C1H6R6WA03#
				±0.1pF	GRM0225C1H5R0BA03#					±0.1pF	GRM0225C1H6R6BA03#
				±0.25pF	GRM0225C1H5R0CA03#					±0.25pF	GRM0225C1H6R6CA03#
			5.1pF	±0.05pF	GRM0225C1H5R1WA03#				6.7pF	±0.05pF	GRM0225C1H6R7WA03#
				±0.1pF	GRM0225C1H5R1BA03#					±0.1pF	GRM0225C1H6R7BA03#
				±0.25pF	GRM0225C1H5R1CA03#					±0.25pF	GRM0225C1H6R7CA03#
			5.2pF	±0.05pF	GRM0225C1H5R2WA03#				6.8pF	±0.05pF	GRM0225C1H6R8WA03#
				±0.1pF	GRM0225C1H5R2BA03#					±0.1pF	GRM0225C1H6R8BA03#
				±0.25pF	GRM0225C1H5R2CA03#					±0.25pF	GRM0225C1H6R8CA03#
			5.3pF	±0.05pF	GRM0225C1H5R3WA03#				6.9pF	±0.05pF	GRM0225C1H6R9WA03#
				±0.1pF	GRM0225C1H5R3BA03#					±0.1pF	GRM0225C1H6R9BA03#
				±0.25pF	GRM0225C1H5R3CA03#					±0.25pF	GRM0225C1H6R9CA03#
			5.4pF	±0.05pF	GRM0225C1H5R4WA03#					±0.5pF	GRM0225C1H5R5DA03#
				±0.1pF	GRM0225C1H5R4BA03#					±0.5pF	GRM0225C1H5R5CA03#
				±0.25pF	GRM0225C1H5R4CA03#					±0.5pF	GRM0225C1H5R5BA03#
			5.5pF	±0.05pF	GRM0225C1H5R5WA03#				5.6pF	±0.05pF	GRM0225C1H5R6WA03#
				±0.1pF	GRM0225C1H5R5BA03#					±0.05pF	GRM0225C1H5R6BA03#
				±0.25pF	GRM0225C1H5R5CA03#					±0.05pF	GRM0225C1H5R6CA03#

Part number # indicates the package specification code.



GRM Series Temperature Compensating Type Part Number List

(→ 0.4×0.2mm)

T max.	Rated Voltage	TC Code	Cap.	Tol.	Part Number
0.22mm	50Vdc	COG	6.9pF	±0.5pF	GRM0225C1H6R9DA03#
				7.0pF	±0.05pF
			±0.1pF		GRM0225C1H7R0BA03#
			±0.25pF		GRM0225C1H7R0CA03#
			±0.5pF		GRM0225C1H7R0DA03#
			7.1pF	±0.05pF	GRM0225C1H7R1WA03#
				±0.1pF	GRM0225C1H7R1BA03#
				±0.25pF	GRM0225C1H7R1CA03#
			7.2pF	±0.05pF	GRM0225C1H7R2WA03#
				±0.1pF	GRM0225C1H7R2BA03#
				±0.25pF	GRM0225C1H7R2CA03#
			7.3pF	±0.05pF	GRM0225C1H7R3WA03#
				±0.1pF	GRM0225C1H7R3BA03#
				±0.25pF	GRM0225C1H7R3CA03#
			7.4pF	±0.05pF	GRM0225C1H7R4WA03#
				±0.1pF	GRM0225C1H7R4BA03#
				±0.25pF	GRM0225C1H7R4CA03#
			7.5pF	±0.05pF	GRM0225C1H7R5WA03#
				±0.1pF	GRM0225C1H7R5BA03#
				±0.25pF	GRM0225C1H7R5CA03#
			7.6pF	±0.05pF	GRM0225C1H7R6WA03#
				±0.1pF	GRM0225C1H7R6BA03#
				±0.25pF	GRM0225C1H7R6CA03#
			7.7pF	±0.05pF	GRM0225C1H7R7WA03#
				±0.1pF	GRM0225C1H7R7BA03#
				±0.25pF	GRM0225C1H7R7CA03#
			7.8pF	±0.05pF	GRM0225C1H7R8WA03#
				±0.1pF	GRM0225C1H7R8BA03#
				±0.25pF	GRM0225C1H7R8CA03#
			7.9pF	±0.05pF	GRM0225C1H7R9WA03#
				±0.1pF	GRM0225C1H7R9BA03#
				±0.25pF	GRM0225C1H7R9CA03#
			8.0pF	±0.05pF	GRM0225C1H8R0WA03#
				±0.1pF	GRM0225C1H8R0BA03#
				±0.25pF	GRM0225C1H8R0CA03#
			8.1pF	±0.05pF	GRM0225C1H8R1WA03#
				±0.1pF	GRM0225C1H8R1BA03#
				±0.25pF	GRM0225C1H8R1CA03#
			8.2pF	±0.05pF	GRM0225C1H8R2WA03#
				±0.1pF	GRM0225C1H8R2BA03#
				±0.25pF	GRM0225C1H8R2CA03#
			8.3pF	±0.05pF	GRM0225C1H8R3WA03#

T max.	Rated Voltage	TC Code	Cap.	Tol.	Part Number
0.22mm	50Vdc	COG	8.3pF	±0.1pF	GRM0225C1H8R3BA03#
				±0.25pF	GRM0225C1H8R3CA03#
				±0.5pF	GRM0225C1H8R3DA03#
			8.4pF	±0.05pF	GRM0225C1H8R4WA03#
				±0.1pF	GRM0225C1H8R4BA03#
				±0.25pF	GRM0225C1H8R4CA03#
			8.5pF	±0.05pF	GRM0225C1H8R5WA03#
				±0.1pF	GRM0225C1H8R5BA03#
				±0.25pF	GRM0225C1H8R5CA03#
			8.6pF	±0.05pF	GRM0225C1H8R6WA03#
				±0.1pF	GRM0225C1H8R6BA03#
				±0.25pF	GRM0225C1H8R6CA03#
			8.7pF	±0.05pF	GRM0225C1H8R7WA03#
				±0.1pF	GRM0225C1H8R7BA03#
				±0.25pF	GRM0225C1H8R7CA03#
			8.8pF	±0.05pF	GRM0225C1H8R8WA03#
				±0.1pF	GRM0225C1H8R8BA03#
				±0.25pF	GRM0225C1H8R8CA03#
			8.9pF	±0.05pF	GRM0225C1H8R9WA03#
				±0.1pF	GRM0225C1H8R9BA03#
				±0.25pF	GRM0225C1H8R9CA03#
			9.0pF	±0.05pF	GRM0225C1H9R0WA03#
				±0.1pF	GRM0225C1H9R0BA03#
				±0.25pF	GRM0225C1H9R0CA03#
			9.1pF	±0.05pF	GRM0225C1H9R1WA03#
				±0.1pF	GRM0225C1H9R1BA03#
				±0.25pF	GRM0225C1H9R1CA03#
			9.2pF	±0.05pF	GRM0225C1H9R2WA03#
				±0.1pF	GRM0225C1H9R2BA03#
				±0.25pF	GRM0225C1H9R2CA03#
			9.3pF	±0.05pF	GRM0225C1H9R3WA03#
				±0.1pF	GRM0225C1H9R3BA03#
				±0.25pF	GRM0225C1H9R3CA03#
			9.4pF	±0.05pF	GRM0225C1H9R4WA03#
				±0.1pF	GRM0225C1H9R4BA03#
				±0.25pF	GRM0225C1H9R4CA03#
			9.5pF	±0.05pF	GRM0225C1H9R5WA03#
				±0.1pF	GRM0225C1H9R5BA03#
				±0.25pF	GRM0225C1H9R5CA03#
			9.6pF	±0.05pF	GRM0225C1H9R6WA03#
				±0.1pF	GRM0225C1H9R6BA03#
				±0.25pF	GRM0225C1H9R6CA03#

- GRM
- GR3
- GRJ
- GR4
- GR7
- GJM
- GQM
- GA2
- GA3 GB
- GA3 GD
- GA3 GF
- LLL
- LLA
- LLM
- LLR
- NFM
- KRM
- KR3
- GMA
- GMD
- ⚠Caution /Notice

Part number # indicates the package specification code.

GRM Series Temperature Compensating Type Part Number List

(→ 0.4×0.2mm)

T max.	Rated Voltage	TC Code	Cap.	Tol.	Part Number	T max.	Rated Voltage	TC Code	Cap.	Tol.	Part Number
0.22mm	50Vdc	COG	9.6pF	±0.5pF	GRM0225C1H9R6DA03#	0.22mm	50Vdc	CK	0.50pF	±0.05pF	GRM0224C1HR50WA03#
				±0.05pF	GRM0225C1H9R7WA03#					±0.1pF	GRM0224C1HR50BA03#
				±0.1pF	GRM0225C1H9R7BA03#					±0.05pF	GRM0224C1HR51WA03#
				±0.25pF	GRM0225C1H9R7CA03#					±0.05pF	GRM0224C1HR60WA03#
				±0.5pF	GRM0225C1H9R7DA03#					±0.1pF	GRM0224C1HR60BA03#
			9.8pF	±0.05pF	GRM0225C1H9R8WA03#	0.70pF			±0.05pF	GRM0224C1HR70WA03#	
				±0.1pF	GRM0225C1H9R8BA03#				±0.1pF	GRM0224C1HR70BA03#	
				±0.25pF	GRM0225C1H9R8CA03#				0.80pF	±0.05pF	GRM0224C1HR80WA03#
				±0.5pF	GRM0225C1H9R8DA03#					±0.1pF	GRM0224C1HR80BA03#
			9.9pF	±0.05pF	GRM0225C1H9R9WA03#	0.90pF			±0.05pF	GRM0224C1HR90WA03#	
				±0.1pF	GRM0225C1H9R9BA03#				±0.1pF	GRM0224C1HR90BA03#	
				±0.25pF	GRM0225C1H9R9CA03#	1.0pF			±0.05pF	GRM0224C1H1R0WA03#	
				±0.5pF	GRM0225C1H9R9DA03#				±0.1pF	GRM0224C1H1R0BA03#	
			10pF	±2%	GRM0225C1H100GA03#	1.1pF			±0.05pF	GRM0224C1H1R1WA03#	
				±5%	GRM0225C1H100JA03#				±0.1pF	GRM0224C1H1R1BA03#	
			11pF	±2%	GRM0225C1H110GA03#	1.2pF			±0.25pF	GRM0224C1H1R1CA03#	
				±5%	GRM0225C1H110JA03#				±0.05pF	GRM0224C1H1R2WA03#	
			12pF	±2%	GRM0225C1H120GA03#	1.3pF			±0.1pF	GRM0224C1H1R2BA03#	
				±5%	GRM0225C1H120JA03#				±0.25pF	GRM0224C1H1R2CA03#	
			13pF	±2%	GRM0225C1H130GA03#	1.4pF			±0.05pF	GRM0224C1H1R3WA03#	
				±5%	GRM0225C1H130JA03#				±0.1pF	GRM0224C1H1R3BA03#	
			15pF	±2%	GRM0225C1H150GA03#	1.5pF			±0.25pF	GRM0224C1H1R3CA03#	
				±5%	GRM0225C1H150JA03#				±0.05pF	GRM0224C1H1R4WA03#	
			16pF	±2%	GRM0225C1H160GA03#	1.6pF			±0.1pF	GRM0224C1H1R4BA03#	
				±5%	GRM0225C1H160JA03#				±0.25pF	GRM0224C1H1R4CA03#	
			17pF	±5%	GRM0225C1H170JA02#	1.7pF			±0.05pF	GRM0224C1H1R5WA03#	
			18pF	±5%	GRM0225C1H180JA02#				±0.1pF	GRM0224C1H1R5BA03#	
			19pF	±5%	GRM0225C1H190JA02#	1.8pF			±0.25pF	GRM0224C1H1R5CA03#	
			20pF	±5%	GRM0225C1H200JA02#				±0.05pF	GRM0224C1H1R6WA03#	
			21pF	±5%	GRM0225C1H210JA02#	1.9pF			±0.1pF	GRM0224C1H1R6BA03#	
			22pF	±5%	GRM0225C1H220JA02#				±0.25pF	GRM0224C1H1R6CA03#	
			23pF	±5%	GRM0225C1H230JA02#	2.0pF			±0.05pF	GRM0224C1H2R0WA03#	
			24pF	±5%	GRM0225C1H240JA02#				±0.1pF	GRM0224C1H2R0BA03#	
			27pF	±5%	GRM0225C1H270JA02#	2.1pF			±0.25pF	GRM0224C1H2R0CA03#	
			30pF	±5%	GRM0225C1H300JA02#				±0.05pF	GRM0223C1H2R1WA03#	
			33pF	±5%	GRM0225C1H330JA02#	2.2pF			±0.1pF	GRM0223C1H2R1BA03#	
			36pF	±5%	GRM0225C1H360JA02#				±0.25pF	GRM0223C1H2R1CA03#	
			39pF	±5%	GRM0225C1H390JA02#	2.3pF			±0.05pF	GRM0223C1H2R2WA03#	
			43pF	±5%	GRM0225C1H430JA02#				±0.1pF	GRM0223C1H2R2BA03#	
			47pF	±5%	GRM0225C1H470JA02#	2.4pF			±0.25pF	GRM0223C1H2R2CA03#	
			51pF	±5%	GRM0225C1H510JA02#				±0.05pF	GRM0223C1H2R3WA03#	
			56pF	±5%	GRM0225C1H560JA02#	CJ			±0.1pF	GRM0223C1H2R3BA03#	
			62pF	±5%	GRM0225C1H620JA02#				±0.25pF	GRM0223C1H2R3CA03#	
			68pF	±5%	GRM0225C1H680JA02#	2.1pF			±0.05pF	GRM0223C1H2R4WA03#	
			75pF	±5%	GRM0225C1H750JA02#				±0.1pF		
			82pF	±5%	GRM0225C1H820JA02#	2.2pF			±0.25pF		
			91pF	±5%	GRM0225C1H910JA02#				±0.05pF		
			100pF	±5%	GRM0225C1H101JA02#	2.3pF			±0.1pF		
			CK	0.20pF	±0.05pF				GRM0224C1HR20WA03#	±0.1pF	
					±0.1pF	GRM0224C1HR20BA03#			±0.25pF		
				0.30pF	±0.05pF	GRM0224C1HR30WA03#				±0.1pF	
					±0.1pF	GRM0224C1HR30BA03#			±0.25pF		
			0.40pF	±0.05pF	GRM0224C1HR40WA03#	±0.1pF					
				±0.1pF	GRM0224C1HR40BA03#				±0.25pF		

Part number # indicates the package specification code.

GRM Series Temperature Compensating Type Part Number List

(→ 0.4×0.2mm)

T max.	Rated Voltage	TC Code	Cap.	Tol.	Part Number	T max.	Rated Voltage	TC Code	Cap.	Tol.	Part Number
0.22mm	50Vdc	CJ	2.4pF	±0.1pF	GRM0223C1H2R4BA03#	0.22mm	50Vdc	CH	4.2pF	±0.1pF	GRM0222C1H4R2BA03#
				±0.25pF	GRM0223C1H2R4CA03#					±0.25pF	GRM0222C1H4R2CA03#
			2.5pF	±0.05pF	GRM0223C1H2R5WA03#				4.3pF	±0.05pF	GRM0222C1H4R3WA03#
				±0.1pF	GRM0223C1H2R5BA03#					±0.1pF	GRM0222C1H4R3BA03#
				±0.25pF	GRM0223C1H2R5CA03#					±0.25pF	GRM0222C1H4R3CA03#
			2.6pF	±0.05pF	GRM0223C1H2R6WA03#				4.4pF	±0.05pF	GRM0222C1H4R4WA03#
				±0.1pF	GRM0223C1H2R6BA03#					±0.1pF	GRM0222C1H4R4BA03#
				±0.25pF	GRM0223C1H2R6CA03#					±0.25pF	GRM0222C1H4R4CA03#
			2.7pF	±0.05pF	GRM0223C1H2R7WA03#				4.5pF	±0.05pF	GRM0222C1H4R5WA03#
				±0.1pF	GRM0223C1H2R7BA03#					±0.1pF	GRM0222C1H4R5BA03#
				±0.25pF	GRM0223C1H2R7CA03#					±0.25pF	GRM0222C1H4R5CA03#
			2.8pF	±0.05pF	GRM0223C1H2R8WA03#				4.6pF	±0.05pF	GRM0222C1H4R6WA03#
				±0.1pF	GRM0223C1H2R8BA03#					±0.1pF	GRM0222C1H4R6BA03#
				±0.25pF	GRM0223C1H2R8CA03#					±0.25pF	GRM0222C1H4R6CA03#
			2.9pF	±0.05pF	GRM0223C1H2R9WA03#				4.7pF	±0.05pF	GRM0222C1H4R7WA03#
				±0.1pF	GRM0223C1H2R9BA03#					±0.1pF	GRM0222C1H4R7BA03#
				±0.25pF	GRM0223C1H2R9CA03#					±0.25pF	GRM0222C1H4R7CA03#
			3.0pF	±0.05pF	GRM0223C1H3R0WA03#				4.8pF	±0.05pF	GRM0222C1H4R8WA03#
				±0.1pF	GRM0223C1H3R0BA03#					±0.1pF	GRM0222C1H4R8BA03#
				±0.25pF	GRM0223C1H3R0CA03#					±0.25pF	GRM0222C1H4R8CA03#
			3.1pF	±0.05pF	GRM0223C1H3R1WA03#				4.9pF	±0.05pF	GRM0222C1H4R9WA03#
				±0.1pF	GRM0223C1H3R1BA03#					±0.1pF	GRM0222C1H4R9BA03#
				±0.25pF	GRM0223C1H3R1CA03#					±0.25pF	GRM0222C1H4R9CA03#
			3.2pF	±0.05pF	GRM0223C1H3R2WA03#				5.0pF	±0.05pF	GRM0222C1H5R0WA03#
		±0.1pF		GRM0223C1H3R2BA03#	±0.1pF	GRM0222C1H5R0BA03#					
		±0.25pF		GRM0223C1H3R2CA03#	±0.25pF	GRM0222C1H5R0CA03#					
		3.3pF	±0.05pF	GRM0223C1H3R3WA03#	5.1pF	±0.05pF	GRM0222C1H5R1WA03#				
			±0.1pF	GRM0223C1H3R3BA03#		±0.1pF	GRM0222C1H5R1BA03#				
			±0.25pF	GRM0223C1H3R3CA03#		±0.25pF	GRM0222C1H5R1CA03#				
		3.4pF	±0.05pF	GRM0223C1H3R4WA03#	5.2pF	±0.05pF	GRM0222C1H5R2WA03#				
			±0.1pF	GRM0223C1H3R4BA03#		±0.1pF	GRM0222C1H5R2BA03#				
			±0.25pF	GRM0223C1H3R4CA03#		±0.25pF	GRM0222C1H5R2CA03#				
		3.5pF	±0.05pF	GRM0223C1H3R5WA03#	5.3pF	±0.05pF	GRM0222C1H5R3WA03#				
			±0.1pF	GRM0223C1H3R5BA03#		±0.1pF	GRM0222C1H5R3BA03#				
			±0.25pF	GRM0223C1H3R5CA03#		±0.25pF	GRM0222C1H5R3CA03#				
		3.6pF	±0.05pF	GRM0223C1H3R6WA03#	5.4pF	±0.05pF	GRM0222C1H5R4WA03#				
			±0.1pF	GRM0223C1H3R6BA03#		±0.1pF	GRM0222C1H5R4BA03#				
			±0.25pF	GRM0223C1H3R6CA03#		±0.25pF	GRM0222C1H5R4CA03#				
		3.7pF	±0.05pF	GRM0223C1H3R7WA03#	5.5pF	±0.05pF	GRM0222C1H5R5WA03#				
			±0.1pF	GRM0223C1H3R7BA03#		±0.1pF	GRM0222C1H5R5BA03#				
			±0.25pF	GRM0223C1H3R7CA03#		±0.25pF	GRM0222C1H5R5CA03#				
		3.8pF	±0.05pF	GRM0223C1H3R8WA03#	5.6pF	±0.05pF	GRM0222C1H5R6WA03#				
			±0.1pF	GRM0223C1H3R8BA03#		±0.1pF	GRM0222C1H5R6BA03#				
			±0.25pF	GRM0223C1H3R8CA03#		±0.25pF	GRM0222C1H5R6CA03#				
		3.9pF	±0.05pF	GRM0223C1H3R9WA03#	5.7pF	±0.05pF	GRM0222C1H5R7WA03#				
			±0.1pF	GRM0223C1H3R9BA03#		±0.1pF	GRM0222C1H5R7BA03#				
			±0.25pF	GRM0223C1H3R9CA03#		±0.25pF	GRM0222C1H5R7CA03#				
		CH	50Vdc	4.0pF	±0.05pF	GRM0222C1H4R0WA03#	0.22mm	50Vdc	CH	4.2pF	±0.05pF
±0.1pF	GRM0222C1H4R0BA03#				±0.1pF	GRM0222C1H5R7BA03#					
±0.25pF	GRM0222C1H4R0CA03#				±0.25pF	GRM0222C1H5R7CA03#					
4.1pF	±0.05pF			GRM0222C1H4R1WA03#	5.7pF	±0.05pF				GRM0222C1H5R7WA03#	
	±0.1pF			GRM0222C1H4R1BA03#		±0.1pF				GRM0222C1H5R7BA03#	
	±0.25pF			GRM0222C1H4R1CA03#		±0.25pF				GRM0222C1H5R7CA03#	
4.2pF	±0.05pF			GRM0222C1H4R2WA03#	5.7pF	±0.05pF				GRM0222C1H5R7DA03#	
	±0.1pF			GRM0222C1H4R2BA03#		±0.1pF				GRM0222C1H5R7BA03#	
	±0.25pF			GRM0222C1H4R2CA03#		±0.25pF				GRM0222C1H5R7CA03#	

- GRM
- GR3
- GRJ
- GR4
- GR7
- GJM
- GQM
- GA2
- GA3 GB
- GA3 GD
- GA3 GF
- LLL
- LLA
- LLM
- LLR
- NFM
- KRM
- KR3
- GMA
- GMD
- ⚠Caution /Notice

Part number # indicates the package specification code.

GRM Series Temperature Compensating Type Part Number List

(→ 0.4×0.2mm)

T max.	Rated Voltage	TC Code	Cap.	Tol.	Part Number
0.22mm	50Vdc	CH	5.8pF	±0.05pF	GRM0222C1H5R8WA03#
				±0.1pF	GRM0222C1H5R8BA03#
				±0.25pF	GRM0222C1H5R8CA03#
				±0.5pF	GRM0222C1H5R8DA03#
			5.9pF	±0.05pF	GRM0222C1H5R9WA03#
				±0.1pF	GRM0222C1H5R9BA03#
				±0.25pF	GRM0222C1H5R9CA03#
				±0.5pF	GRM0222C1H5R9DA03#
			6.0pF	±0.05pF	GRM0222C1H6R0WA03#
				±0.1pF	GRM0222C1H6R0BA03#
				±0.25pF	GRM0222C1H6R0CA03#
				±0.5pF	GRM0222C1H6R0DA03#
			6.1pF	±0.05pF	GRM0222C1H6R1WA03#
				±0.1pF	GRM0222C1H6R1BA03#
				±0.25pF	GRM0222C1H6R1CA03#
				±0.5pF	GRM0222C1H6R1DA03#
			6.2pF	±0.05pF	GRM0222C1H6R2WA03#
				±0.1pF	GRM0222C1H6R2BA03#
				±0.25pF	GRM0222C1H6R2CA03#
				±0.5pF	GRM0222C1H6R2DA03#
			6.3pF	±0.05pF	GRM0222C1H6R3WA03#
				±0.1pF	GRM0222C1H6R3BA03#
				±0.25pF	GRM0222C1H6R3CA03#
				±0.5pF	GRM0222C1H6R3DA03#
			6.4pF	±0.05pF	GRM0222C1H6R4WA03#
				±0.1pF	GRM0222C1H6R4BA03#
				±0.25pF	GRM0222C1H6R4CA03#
				±0.5pF	GRM0222C1H6R4DA03#
			6.5pF	±0.05pF	GRM0222C1H6R5WA03#
				±0.1pF	GRM0222C1H6R5BA03#
				±0.25pF	GRM0222C1H6R5CA03#
				±0.5pF	GRM0222C1H6R5DA03#
			6.6pF	±0.05pF	GRM0222C1H6R6WA03#
				±0.1pF	GRM0222C1H6R6BA03#
				±0.25pF	GRM0222C1H6R6CA03#
				±0.5pF	GRM0222C1H6R6DA03#
			6.7pF	±0.05pF	GRM0222C1H6R7WA03#
				±0.1pF	GRM0222C1H6R7BA03#
				±0.25pF	GRM0222C1H6R7CA03#
				±0.5pF	GRM0222C1H6R7DA03#
			6.8pF	±0.05pF	GRM0222C1H6R8WA03#
				±0.1pF	GRM0222C1H6R8BA03#
				±0.25pF	GRM0222C1H6R8CA03#
				±0.5pF	GRM0222C1H6R8DA03#
			6.9pF	±0.05pF	GRM0222C1H6R9WA03#
				±0.1pF	GRM0222C1H6R9BA03#
				±0.25pF	GRM0222C1H6R9CA03#
				±0.5pF	GRM0222C1H6R9DA03#
			7.0pF	±0.05pF	GRM0222C1H7R0WA03#
				±0.1pF	GRM0222C1H7R0BA03#
				±0.25pF	GRM0222C1H7R0CA03#
				±0.5pF	GRM0222C1H7R0DA03#
			7.1pF	±0.05pF	GRM0222C1H7R1WA03#
				±0.1pF	GRM0222C1H7R1BA03#

T max.	Rated Voltage	TC Code	Cap.	Tol.	Part Number
0.22mm	50Vdc	CH	7.1pF	±0.25pF	GRM0222C1H7R1CA03#
				±0.5pF	GRM0222C1H7R1DA03#
			7.2pF	±0.05pF	GRM0222C1H7R2WA03#
				±0.1pF	GRM0222C1H7R2BA03#
				±0.25pF	GRM0222C1H7R2CA03#
			7.3pF	±0.05pF	GRM0222C1H7R3WA03#
				±0.1pF	GRM0222C1H7R3BA03#
				±0.25pF	GRM0222C1H7R3CA03#
			7.4pF	±0.05pF	GRM0222C1H7R4WA03#
				±0.1pF	GRM0222C1H7R4BA03#
				±0.25pF	GRM0222C1H7R4CA03#
			7.5pF	±0.05pF	GRM0222C1H7R5WA03#
				±0.1pF	GRM0222C1H7R5BA03#
				±0.25pF	GRM0222C1H7R5CA03#
			7.6pF	±0.05pF	GRM0222C1H7R6WA03#
				±0.1pF	GRM0222C1H7R6BA03#
				±0.25pF	GRM0222C1H7R6CA03#
			7.7pF	±0.05pF	GRM0222C1H7R7WA03#
				±0.1pF	GRM0222C1H7R7BA03#
				±0.25pF	GRM0222C1H7R7CA03#
			7.8pF	±0.05pF	GRM0222C1H7R8WA03#
				±0.1pF	GRM0222C1H7R8BA03#
				±0.25pF	GRM0222C1H7R8CA03#
			7.9pF	±0.05pF	GRM0222C1H7R9WA03#
				±0.1pF	GRM0222C1H7R9BA03#
				±0.25pF	GRM0222C1H7R9CA03#
			8.0pF	±0.05pF	GRM0222C1H8R0WA03#
				±0.1pF	GRM0222C1H8R0BA03#
				±0.25pF	GRM0222C1H8R0CA03#
			8.1pF	±0.05pF	GRM0222C1H8R1WA03#
				±0.1pF	GRM0222C1H8R1BA03#
				±0.25pF	GRM0222C1H8R1CA03#
			8.2pF	±0.05pF	GRM0222C1H8R2WA03#
				±0.1pF	GRM0222C1H8R2BA03#
				±0.25pF	GRM0222C1H8R2CA03#
			8.3pF	±0.05pF	GRM0222C1H8R3WA03#
				±0.1pF	GRM0222C1H8R3BA03#
				±0.25pF	GRM0222C1H8R3CA03#
			8.4pF	±0.05pF	GRM0222C1H8R4WA03#
				±0.1pF	GRM0222C1H8R4BA03#
				±0.25pF	GRM0222C1H8R4CA03#

Part number # indicates the package specification code.

GRM
 GR3
 GRJ
 GR4
 GR7
 GJM
 GQM
 GA2
 GA3 GB
 GA3 GD
 GA3 GF
 LLL
 LLA
 LLM
 LLR
 NFM
 KRM
 KR3
 GMA
 GMD
 ⚠Caution /Notice

GRM Series Temperature Compensating Type Part Number List

(→ 0.4×0.2mm)

T max.	Rated Voltage	TC Code	Cap.	Tol.	Part Number	T max.	Rated Voltage	TC Code	Cap.	Tol.	Part Number	
0.22mm	50Vdc	CH	8.5pF	±0.05pF	GRM0222C1H8R5WA03#	0.22mm	50Vdc	CH	9.8pF	±0.25pF	GRM0222C1H9R8CA03#	
				±0.1pF	GRM0222C1H8R5BA03#					±0.5pF	GRM0222C1H9R8DA03#	
				±0.25pF	GRM0222C1H8R5CA03#					9.9pF	±0.05pF	GRM0222C1H9R9WA03#
				±0.5pF	GRM0222C1H8R5DA03#						±0.1pF	GRM0222C1H9R9BA03#
			8.6pF	±0.05pF	GRM0222C1H8R6WA03#				±0.25pF	GRM0222C1H9R9CA03#		
				±0.1pF	GRM0222C1H8R6BA03#				±0.5pF	GRM0222C1H9R9DA03#		
				±0.25pF	GRM0222C1H8R6CA03#				10pF	±2%	GRM0222C1H100GA03#	
				±0.5pF	GRM0222C1H8R6DA03#					±5%	GRM0222C1H100JA03#	
			8.7pF	±0.05pF	GRM0222C1H8R7WA03#				11pF	±2%	GRM0222C1H110GA03#	
				±0.1pF	GRM0222C1H8R7BA03#					±5%	GRM0222C1H110JA03#	
				±0.25pF	GRM0222C1H8R7CA03#				12pF	±2%	GRM0222C1H120GA03#	
				±0.5pF	GRM0222C1H8R7DA03#					±5%	GRM0222C1H120JA03#	
			8.8pF	±0.05pF	GRM0222C1H8R8WA03#				13pF	±2%	GRM0222C1H130GA03#	
				±0.1pF	GRM0222C1H8R8BA03#					±5%	GRM0222C1H130JA03#	
				±0.25pF	GRM0222C1H8R8CA03#				15pF	±2%	GRM0222C1H150GA03#	
				±0.5pF	GRM0222C1H8R8DA03#					±5%	GRM0222C1H150JA03#	
			8.9pF	±0.05pF	GRM0222C1H8R9WA03#				16pF	±2%	GRM0222C1H160GA03#	
				±0.1pF	GRM0222C1H8R9BA03#					±5%	GRM0222C1H160JA03#	
				±0.25pF	GRM0222C1H8R9CA03#				17pF	±5%	GRM0222C1H170JA02#	
				±0.5pF	GRM0222C1H8R9DA03#					18pF	±5%	GRM0222C1H180JA02#
			9.0pF	±0.05pF	GRM0222C1H9R0WA03#				19pF		±5%	GRM0222C1H190JA02#
				±0.1pF	GRM0222C1H9R0BA03#					20pF	±5%	GRM0222C1H200JA02#
				±0.25pF	GRM0222C1H9R0CA03#				21pF		±5%	GRM0222C1H210JA02#
				±0.5pF	GRM0222C1H9R0DA03#					22pF	±5%	GRM0222C1H220JA02#
			9.1pF	±0.05pF	GRM0222C1H9R1WA03#				23pF		±5%	GRM0222C1H230JA02#
				±0.1pF	GRM0222C1H9R1BA03#					24pF	±5%	GRM0222C1H240JA02#
				±0.25pF	GRM0222C1H9R1CA03#				27pF		±5%	GRM0222C1H270JA02#
				±0.5pF	GRM0222C1H9R1DA03#					30pF	±5%	GRM0222C1H300JA02#
			9.2pF	±0.05pF	GRM0222C1H9R2WA03#				33pF		±5%	GRM0222C1H330JA02#
				±0.1pF	GRM0222C1H9R2BA03#					36pF	±5%	GRM0222C1H360JA02#
				±0.25pF	GRM0222C1H9R2CA03#				39pF		±5%	GRM0222C1H390JA02#
				±0.5pF	GRM0222C1H9R2DA03#					43pF	±5%	GRM0222C1H430JA02#
			9.3pF	±0.05pF	GRM0222C1H9R3WA03#				47pF		±5%	GRM0222C1H470JA02#
				±0.1pF	GRM0222C1H9R3BA03#					51pF	±5%	GRM0222C1H510JA02#
				±0.25pF	GRM0222C1H9R3CA03#				56pF		±5%	GRM0222C1H560JA02#
				±0.5pF	GRM0222C1H9R3DA03#					62pF	±5%	GRM0222C1H620JA02#
			9.4pF	±0.05pF	GRM0222C1H9R4WA03#				68pF		±5%	GRM0222C1H680JA02#
				±0.1pF	GRM0222C1H9R4BA03#					75pF	±5%	GRM0222C1H750JA02#
				±0.25pF	GRM0222C1H9R4CA03#				82pF		±5%	GRM0222C1H820JA02#
				±0.5pF	GRM0222C1H9R4DA03#					91pF	±5%	GRM0222C1H910JA02#
			9.5pF	±0.05pF	GRM0222C1H9R5WA03#				100pF		±5%	GRM0222C1H101JA02#
				±0.1pF	GRM0222C1H9R5BA03#					120pF	±5%	GRM0225C1E121JA02#
				±0.25pF	GRM0222C1H9R5CA03#				150pF		±5%	GRM0225C1E151JA02#
				±0.5pF	GRM0222C1H9R5DA03#					180pF	±5%	GRM0225C1E181JA02#
			9.6pF	±0.05pF	GRM0222C1H9R6WA03#				220pF		±5%	GRM0225C1E221JA02#
				±0.1pF	GRM0222C1H9R6BA03#					120pF	±5%	GRM0222C1E121JA02#
				±0.25pF	GRM0222C1H9R6CA03#				150pF		±5%	GRM0222C1E151JA02#
				±0.5pF	GRM0222C1H9R6DA03#					180pF	±5%	GRM0222C1E181JA02#
			9.7pF	±0.05pF	GRM0222C1H9R7WA03#				220pF		±5%	GRM0222C1E221JA02#
				±0.1pF	GRM0222C1H9R7BA03#					120pF	±5%	GRM0225C1C121JA02#
				±0.25pF	GRM0222C1H9R7CA03#				150pF		±5%	GRM0225C1C151JA02#
				±0.5pF	GRM0222C1H9R7DA03#					180pF	±5%	GRM0225C1C181JA02#
			9.8pF	±0.05pF	GRM0222C1H9R8WA03#				220pF		±5%	GRM0225C1C221JA02#
				±0.1pF	GRM0222C1H9R8BA03#					CH	120pF	±5%

GRM
 GR3
 GRJ
 GR4
 GR7
 GJM
 GQM
 GA2
 GA3 GB
 GA3 GD
 GA3 GF
 LLL
 LLA
 LLM
 LLR
 NFM
 KRM
 KR3
 GMA
 GMD
 ⚠Caution / Notice

Part number # indicates the package specification code.

GRM Series Temperature Compensating Type Part Number List

(→ 0.4×0.2mm)

T max.	Rated Voltage	TC Code	Cap.	Tol.	Part Number
0.22mm	16Vdc	CH	150pF	±5%	GRM0222C1C151JA02#
			180pF	±5%	GRM0222C1C181JA02#
			220pF	±5%	GRM0222C1C221JA02#

0.6×0.3mm

T max.	Rated Voltage	TC Code	Cap.	Tol.	Part Number
0.33mm	100Vdc	COG	0.10pF	±0.05pF	GRM0335C2AR10WA01#
				±0.1pF	GRM0335C2AR10BA01#
			0.20pF	±0.05pF	GRM0335C2AR20WA01#
				±0.1pF	GRM0335C2AR20BA01#
			0.30pF	±0.05pF	GRM0335C2AR30WA01#
				±0.1pF	GRM0335C2AR30BA01#
			0.40pF	±0.05pF	GRM0335C2AR40WA01#
				±0.1pF	GRM0335C2AR40BA01#
			0.50pF	±0.05pF	GRM0335C2AR50WA01#
				±0.1pF	GRM0335C2AR50BA01#
			0.60pF	±0.05pF	GRM0335C2AR60WA01#
				±0.1pF	GRM0335C2AR60BA01#
			0.70pF	±0.05pF	GRM0335C2AR70WA01#
				±0.1pF	GRM0335C2AR70BA01#
			0.80pF	±0.05pF	GRM0335C2AR80WA01#
				±0.1pF	GRM0335C2AR80BA01#
			0.90pF	±0.05pF	GRM0335C2AR90WA01#
				±0.1pF	GRM0335C2AR90BA01#
			1.0pF	±0.05pF	GRM0335C2A1R0WA01#
				±0.1pF	GRM0335C2A1R0BA01#
				±0.25pF	GRM0335C2A1R0CA01#
			1.1pF	±0.05pF	GRM0335C2A1R1WA01#
				±0.1pF	GRM0335C2A1R1BA01#
				±0.25pF	GRM0335C2A1R1CA01#
			1.2pF	±0.05pF	GRM0335C2A1R2WA01#
				±0.1pF	GRM0335C2A1R2BA01#
				±0.25pF	GRM0335C2A1R2CA01#
			1.3pF	±0.05pF	GRM0335C2A1R3WA01#
				±0.1pF	GRM0335C2A1R3BA01#
				±0.25pF	GRM0335C2A1R3CA01#
			1.4pF	±0.05pF	GRM0335C2A1R4WA01#
				±0.1pF	GRM0335C2A1R4BA01#
				±0.25pF	GRM0335C2A1R4CA01#
			1.5pF	±0.05pF	GRM0335C2A1R5WA01#
				±0.1pF	GRM0335C2A1R5BA01#
				±0.25pF	GRM0335C2A1R5CA01#
			1.6pF	±0.05pF	GRM0335C2A1R6WA01#
				±0.1pF	GRM0335C2A1R6BA01#
				±0.25pF	GRM0335C2A1R6CA01#
			1.7pF	±0.05pF	GRM0335C2A1R7WA01#
				±0.1pF	GRM0335C2A1R7BA01#
				±0.25pF	GRM0335C2A1R7CA01#
			1.8pF	±0.05pF	GRM0335C2A1R8WA01#
				±0.1pF	GRM0335C2A1R8BA01#
				±0.25pF	GRM0335C2A1R8CA01#
			1.9pF	±0.05pF	GRM0335C2A1R9WA01#
				±0.1pF	GRM0335C2A1R9BA01#

T max.	Rated Voltage	TC Code	Cap.	Tol.	Part Number
0.33mm	100Vdc	COG	1.9pF	±0.25pF	GRM0335C2A1R9CA01#
				±0.05pF	GRM0335C2A2R0WA01#
				±0.1pF	GRM0335C2A2R0BA01#
			2.0pF	±0.25pF	GRM0335C2A2R0CA01#
				±0.05pF	GRM0335C2A2R1WA01#
				±0.1pF	GRM0335C2A2R1BA01#
			2.1pF	±0.25pF	GRM0335C2A2R1CA01#
				±0.05pF	GRM0335C2A2R2WA01#
				±0.1pF	GRM0335C2A2R2BA01#
			2.2pF	±0.25pF	GRM0335C2A2R2CA01#
				±0.05pF	GRM0335C2A2R3WA01#
				±0.1pF	GRM0335C2A2R3BA01#
			2.3pF	±0.25pF	GRM0335C2A2R3CA01#
				±0.05pF	GRM0335C2A2R4WA01#
				±0.1pF	GRM0335C2A2R4BA01#
			2.4pF	±0.25pF	GRM0335C2A2R4CA01#
				±0.05pF	GRM0335C2A2R5WA01#
				±0.1pF	GRM0335C2A2R5BA01#
			2.5pF	±0.25pF	GRM0335C2A2R5CA01#
				±0.05pF	GRM0335C2A2R6WA01#
				±0.1pF	GRM0335C2A2R6BA01#
			2.6pF	±0.25pF	GRM0335C2A2R6CA01#
				±0.05pF	GRM0335C2A2R7WA01#
				±0.1pF	GRM0335C2A2R7BA01#
			2.7pF	±0.25pF	GRM0335C2A2R7CA01#
				±0.05pF	GRM0335C2A2R8WA01#
				±0.1pF	GRM0335C2A2R8BA01#
			2.8pF	±0.25pF	GRM0335C2A2R8CA01#
				±0.05pF	GRM0335C2A2R9WA01#
				±0.1pF	GRM0335C2A2R9BA01#
			2.9pF	±0.25pF	GRM0335C2A2R9CA01#
				±0.05pF	GRM0335C2A3R0WA01#
				±0.1pF	GRM0335C2A3R0BA01#
			3.0pF	±0.25pF	GRM0335C2A3R0CA01#
				±0.05pF	GRM0335C2A3R1WA01#
				±0.1pF	GRM0335C2A3R1BA01#
3.1pF	±0.25pF	GRM0335C2A3R1CA01#			
	±0.05pF	GRM0335C2A3R2WA01#			
	±0.1pF	GRM0335C2A3R2BA01#			
3.2pF	±0.25pF	GRM0335C2A3R2CA01#			
	±0.05pF	GRM0335C2A3R3WA01#			
	±0.1pF	GRM0335C2A3R3BA01#			
3.3pF	±0.25pF	GRM0335C2A3R3CA01#			
	±0.05pF	GRM0335C2A3R4WA01#			
	±0.1pF	GRM0335C2A3R4BA01#			
3.4pF	±0.25pF	GRM0335C2A3R4CA01#			
	±0.05pF	GRM0335C2A3R5WA01#			
	±0.1pF	GRM0335C2A3R5BA01#			
3.5pF	±0.25pF	GRM0335C2A3R5CA01#			
	±0.05pF	GRM0335C2A3R6WA01#			
	±0.1pF	GRM0335C2A3R6BA01#			
3.6pF	±0.25pF	GRM0335C2A3R6CA01#			
	±0.05pF	GRM0335C2A3R7WA01#			
	±0.1pF	GRM0335C2A3R7BA01#			
3.7pF	±0.25pF	GRM0335C2A3R7CA01#			
	±0.05pF	GRM0335C2A3R7WA01#			
			±0.1pF	GRM0335C2A3R7BA01#	

Part number # indicates the package specification code.

GRM
 GR3
 GRJ
 GR4
 GR7
 GJM
 GQM
 GA2
 GA3 GB
 GA3 GD
 GA3 GF
 LLL
 LLA
 LLM
 LLR
 NFM
 KRM
 KR3
 GMA
 GMD
 ⚠Caution /Notice

GRM Series Temperature Compensating Type Part Number List

(→ 0.6×0.3mm)

T max.	Rated Voltage	TC Code	Cap.	Tol.	Part Number
0.33mm	100Vdc	COG	3.7pF	±0.25pF	GRM0335C2A3R7CA01#
				±0.05pF	GRM0335C2A3R8WA01#
			3.8pF	±0.1pF	GRM0335C2A3R8BA01#
				±0.25pF	GRM0335C2A3R8CA01#
				±0.05pF	GRM0335C2A3R9WA01#
			3.9pF	±0.1pF	GRM0335C2A3R9BA01#
				±0.25pF	GRM0335C2A3R9CA01#
				±0.05pF	GRM0335C2A4R0WA01#
			4.0pF	±0.1pF	GRM0335C2A4R0BA01#
				±0.25pF	GRM0335C2A4R0CA01#
				±0.05pF	GRM0335C2A4R1WA01#
			4.1pF	±0.1pF	GRM0335C2A4R1BA01#
				±0.25pF	GRM0335C2A4R1CA01#
				±0.05pF	GRM0335C2A4R2WA01#
			4.2pF	±0.1pF	GRM0335C2A4R2BA01#
				±0.25pF	GRM0335C2A4R2CA01#
				±0.05pF	GRM0335C2A4R3WA01#
			4.3pF	±0.1pF	GRM0335C2A4R3BA01#
				±0.25pF	GRM0335C2A4R3CA01#
				±0.05pF	GRM0335C2A4R4WA01#
			4.4pF	±0.1pF	GRM0335C2A4R4BA01#
				±0.25pF	GRM0335C2A4R4CA01#
				±0.05pF	GRM0335C2A4R5WA01#
			4.5pF	±0.1pF	GRM0335C2A4R5BA01#
				±0.25pF	GRM0335C2A4R5CA01#
				±0.05pF	GRM0335C2A4R6WA01#
			4.6pF	±0.1pF	GRM0335C2A4R6BA01#
				±0.25pF	GRM0335C2A4R6CA01#
				±0.05pF	GRM0335C2A4R7WA01#
			4.7pF	±0.1pF	GRM0335C2A4R7BA01#
				±0.25pF	GRM0335C2A4R7CA01#
				±0.05pF	GRM0335C2A4R8WA01#
			4.8pF	±0.1pF	GRM0335C2A4R8BA01#
				±0.25pF	GRM0335C2A4R8CA01#
				±0.05pF	GRM0335C2A4R9WA01#
			4.9pF	±0.1pF	GRM0335C2A4R9BA01#
				±0.25pF	GRM0335C2A4R9CA01#
				±0.05pF	GRM0335C2A5R0WA01#
			5.0pF	±0.1pF	GRM0335C2A5R0BA01#
				±0.25pF	GRM0335C2A5R0CA01#
				±0.05pF	GRM0335C2A5R1WA01#
			5.1pF	±0.1pF	GRM0335C2A5R1BA01#
				±0.25pF	GRM0335C2A5R1CA01#
				±0.5pF	GRM0335C2A5R1DA01#
				±0.05pF	GRM0335C2A5R2WA01#
			5.2pF	±0.1pF	GRM0335C2A5R2BA01#
				±0.25pF	GRM0335C2A5R2CA01#
				±0.5pF	GRM0335C2A5R2DA01#
				±0.05pF	GRM0335C2A5R3WA01#
			5.3pF	±0.1pF	GRM0335C2A5R3BA01#
				±0.25pF	GRM0335C2A5R3CA01#
				±0.5pF	GRM0335C2A5R3DA01#
				±0.05pF	GRM0335C2A5R4WA01#
			5.4pF	±0.1pF	GRM0335C2A5R4BA01#

T max.	Rated Voltage	TC Code	Cap.	Tol.	Part Number
0.33mm	100Vdc	COG	5.4pF	±0.25pF	GRM0335C2A5R4CA01#
				±0.5pF	GRM0335C2A5R4DA01#
			5.5pF	±0.05pF	GRM0335C2A5R5WA01#
				±0.1pF	GRM0335C2A5R5BA01#
				±0.25pF	GRM0335C2A5R5CA01#
			5.6pF	±0.05pF	GRM0335C2A5R6WA01#
				±0.1pF	GRM0335C2A5R6BA01#
				±0.25pF	GRM0335C2A5R6CA01#
			5.7pF	±0.05pF	GRM0335C2A5R7WA01#
				±0.1pF	GRM0335C2A5R7BA01#
				±0.25pF	GRM0335C2A5R7CA01#
			5.8pF	±0.05pF	GRM0335C2A5R8WA01#
				±0.1pF	GRM0335C2A5R8BA01#
				±0.25pF	GRM0335C2A5R8CA01#
			5.9pF	±0.05pF	GRM0335C2A5R9WA01#
				±0.1pF	GRM0335C2A5R9BA01#
				±0.25pF	GRM0335C2A5R9CA01#
			6.0pF	±0.05pF	GRM0335C2A6R0WA01#
				±0.1pF	GRM0335C2A6R0BA01#
				±0.25pF	GRM0335C2A6R0CA01#
			6.1pF	±0.05pF	GRM0335C2A6R1WA01#
				±0.1pF	GRM0335C2A6R1BA01#
				±0.25pF	GRM0335C2A6R1CA01#
			6.2pF	±0.05pF	GRM0335C2A6R2WA01#
				±0.1pF	GRM0335C2A6R2BA01#
				±0.25pF	GRM0335C2A6R2CA01#
			6.3pF	±0.05pF	GRM0335C2A6R3WA01#
				±0.1pF	GRM0335C2A6R3BA01#
				±0.25pF	GRM0335C2A6R3CA01#
			6.4pF	±0.05pF	GRM0335C2A6R4WA01#
				±0.1pF	GRM0335C2A6R4BA01#
				±0.25pF	GRM0335C2A6R4CA01#
			6.5pF	±0.05pF	GRM0335C2A6R5WA01#
				±0.1pF	GRM0335C2A6R5BA01#
				±0.25pF	GRM0335C2A6R5CA01#
			6.6pF	±0.05pF	GRM0335C2A6R6WA01#
				±0.1pF	GRM0335C2A6R6BA01#
				±0.25pF	GRM0335C2A6R6CA01#
			6.7pF	±0.05pF	GRM0335C2A6R7WA01#
				±0.1pF	GRM0335C2A6R7BA01#
				±0.25pF	GRM0335C2A6R7CA01#
			6.8pF	±0.05pF	GRM0335C2A6R8WA01#
				±0.1pF	GRM0335C2A6R8BA01#

- GRM
- GR3
- GRJ
- GR4
- GR7
- GJM
- GQM
- GA2
- GA3 GB
- GA3 GD
- GA3 GF
- LLL
- LLA
- LLM
- LLR
- NFM
- KRM
- KR3
- GMA
- GMD
- ⚠Caution /Notice

Part number # indicates the package specification code.

GRM Series Temperature Compensating Type Part Number List

(→ 0.6×0.3mm)

T max.	Rated Voltage	TC Code	Cap.	Tol.	Part Number
0.33mm	100Vdc	COG	6.8pF	±0.05pF	GRM0335C2A6R8WA01#
				±0.1pF	GRM0335C2A6R8BA01#
				±0.25pF	GRM0335C2A6R8CA01#
				±0.5pF	GRM0335C2A6R8DA01#
			6.9pF	±0.05pF	GRM0335C2A6R9WA01#
				±0.1pF	GRM0335C2A6R9BA01#
				±0.25pF	GRM0335C2A6R9CA01#
				±0.5pF	GRM0335C2A6R9DA01#
			7.0pF	±0.05pF	GRM0335C2A7R0WA01#
				±0.1pF	GRM0335C2A7R0BA01#
				±0.25pF	GRM0335C2A7R0CA01#
				±0.5pF	GRM0335C2A7R0DA01#
			7.1pF	±0.05pF	GRM0335C2A7R1WA01#
				±0.1pF	GRM0335C2A7R1BA01#
				±0.25pF	GRM0335C2A7R1CA01#
				±0.5pF	GRM0335C2A7R1DA01#
			7.2pF	±0.05pF	GRM0335C2A7R2WA01#
				±0.1pF	GRM0335C2A7R2BA01#
				±0.25pF	GRM0335C2A7R2CA01#
				±0.5pF	GRM0335C2A7R2DA01#
			7.3pF	±0.05pF	GRM0335C2A7R3WA01#
				±0.1pF	GRM0335C2A7R3BA01#
				±0.25pF	GRM0335C2A7R3CA01#
				±0.5pF	GRM0335C2A7R3DA01#
			7.4pF	±0.05pF	GRM0335C2A7R4WA01#
				±0.1pF	GRM0335C2A7R4BA01#
				±0.25pF	GRM0335C2A7R4CA01#
				±0.5pF	GRM0335C2A7R4DA01#
			7.5pF	±0.05pF	GRM0335C2A7R5WA01#
				±0.1pF	GRM0335C2A7R5BA01#
				±0.25pF	GRM0335C2A7R5CA01#
				±0.5pF	GRM0335C2A7R5DA01#
			7.6pF	±0.05pF	GRM0335C2A7R6WA01#
				±0.1pF	GRM0335C2A7R6BA01#
				±0.25pF	GRM0335C2A7R6CA01#
				±0.5pF	GRM0335C2A7R6DA01#
			7.7pF	±0.05pF	GRM0335C2A7R7WA01#
				±0.1pF	GRM0335C2A7R7BA01#
				±0.25pF	GRM0335C2A7R7CA01#
				±0.5pF	GRM0335C2A7R7DA01#
			7.8pF	±0.05pF	GRM0335C2A7R8WA01#
				±0.1pF	GRM0335C2A7R8BA01#
				±0.25pF	GRM0335C2A7R8CA01#
				±0.5pF	GRM0335C2A7R8DA01#
			7.9pF	±0.05pF	GRM0335C2A7R9WA01#
				±0.1pF	GRM0335C2A7R9BA01#
				±0.25pF	GRM0335C2A7R9CA01#
				±0.5pF	GRM0335C2A7R9DA01#
			8.0pF	±0.05pF	GRM0335C2A8R0WA01#
				±0.1pF	GRM0335C2A8R0BA01#
				±0.25pF	GRM0335C2A8R0CA01#
				±0.5pF	GRM0335C2A8R0DA01#
			8.1pF	±0.05pF	GRM0335C2A8R1WA01#
				±0.1pF	GRM0335C2A8R1BA01#

T max.	Rated Voltage	TC Code	Cap.	Tol.	Part Number
0.33mm	100Vdc	COG	8.1pF	±0.25pF	GRM0335C2A8R1CA01#
				±0.5pF	GRM0335C2A8R1DA01#
			8.2pF	±0.05pF	GRM0335C2A8R2WA01#
				±0.1pF	GRM0335C2A8R2BA01#
				±0.25pF	GRM0335C2A8R2CA01#
			8.3pF	±0.05pF	GRM0335C2A8R3WA01#
				±0.1pF	GRM0335C2A8R3BA01#
				±0.25pF	GRM0335C2A8R3CA01#
			8.4pF	±0.05pF	GRM0335C2A8R4WA01#
				±0.1pF	GRM0335C2A8R4BA01#
				±0.25pF	GRM0335C2A8R4CA01#
			8.5pF	±0.05pF	GRM0335C2A8R5WA01#
				±0.1pF	GRM0335C2A8R5BA01#
				±0.25pF	GRM0335C2A8R5CA01#
			8.6pF	±0.05pF	GRM0335C2A8R6WA01#
				±0.1pF	GRM0335C2A8R6BA01#
				±0.25pF	GRM0335C2A8R6CA01#
			8.7pF	±0.05pF	GRM0335C2A8R7WA01#
				±0.1pF	GRM0335C2A8R7BA01#
				±0.25pF	GRM0335C2A8R7CA01#
			8.8pF	±0.05pF	GRM0335C2A8R8WA01#
				±0.1pF	GRM0335C2A8R8BA01#
				±0.25pF	GRM0335C2A8R8CA01#
			8.9pF	±0.05pF	GRM0335C2A8R9WA01#
				±0.1pF	GRM0335C2A8R9BA01#
				±0.25pF	GRM0335C2A8R9CA01#
			9.0pF	±0.05pF	GRM0335C2A9R0WA01#
				±0.1pF	GRM0335C2A9R0BA01#
				±0.25pF	GRM0335C2A9R0CA01#
			9.1pF	±0.05pF	GRM0335C2A9R1WA01#
				±0.1pF	GRM0335C2A9R1BA01#
				±0.25pF	GRM0335C2A9R1CA01#
			9.2pF	±0.05pF	GRM0335C2A9R2WA01#
				±0.1pF	GRM0335C2A9R2BA01#
				±0.25pF	GRM0335C2A9R2CA01#
			9.3pF	±0.05pF	GRM0335C2A9R3WA01#
				±0.1pF	GRM0335C2A9R3BA01#
				±0.25pF	GRM0335C2A9R3CA01#
			9.4pF	±0.05pF	GRM0335C2A9R4WA01#
				±0.1pF	GRM0335C2A9R4BA01#
				±0.25pF	GRM0335C2A9R4CA01#

Part number # indicates the package specification code.

- GRM
- GR3
- GRJ
- GR4
- GR7
- GJM
- GQM
- GA2
- GA3 GB
- GA3 GD
- GA3 GF
- LLL
- LLA
- LLM
- LLR
- NFM
- KRM
- KR3
- GMA
- GMD
- ⚠Caution /Notice

GRM Series Temperature Compensating Type Part Number List

(→ 0.6×0.3mm)

T max.	Rated Voltage	TC Code	Cap.	Tol.	Part Number
0.33mm	100Vdc	COG	9.5pF	±0.05pF	GRM0335C2A9R5WA01#
				±0.1pF	GRM0335C2A9R5BA01#
				±0.25pF	GRM0335C2A9R5CA01#
				±0.5pF	GRM0335C2A9R5DA01#
			9.6pF	±0.05pF	GRM0335C2A9R6WA01#
				±0.1pF	GRM0335C2A9R6BA01#
				±0.25pF	GRM0335C2A9R6CA01#
				±0.5pF	GRM0335C2A9R6DA01#
			9.7pF	±0.05pF	GRM0335C2A9R7WA01#
				±0.1pF	GRM0335C2A9R7BA01#
				±0.25pF	GRM0335C2A9R7CA01#
				±0.5pF	GRM0335C2A9R7DA01#
			9.8pF	±0.05pF	GRM0335C2A9R8WA01#
				±0.1pF	GRM0335C2A9R8BA01#
				±0.25pF	GRM0335C2A9R8CA01#
				±0.5pF	GRM0335C2A9R8DA01#
			9.9pF	±0.05pF	GRM0335C2A9R9WA01#
				±0.1pF	GRM0335C2A9R9BA01#
				±0.25pF	GRM0335C2A9R9CA01#
				±0.5pF	GRM0335C2A9R9DA01#
			10pF	±2%	GRM0335C2A100GA01#
				±5%	GRM0335C2A100JA01#
			12pF	±2%	GRM0335C2A120GA01#
				±5%	GRM0335C2A120JA01#
			15pF	±2%	GRM0335C2A150GA01#
				±5%	GRM0335C2A150JA01#
			18pF	±2%	GRM0335C2A180GA01#
				±5%	GRM0335C2A180JA01#
			20pF	±2%	GRM0335C2A200GA01#
				±5%	GRM0335C2A200JA01#
			22pF	±2%	GRM0335C2A220GA01#
				±5%	GRM0335C2A220JA01#
			24pF	±2%	GRM0335C2A240GA01#
				±5%	GRM0335C2A240JA01#
			27pF	±2%	GRM0335C2A270GA01#
				±5%	GRM0335C2A270JA01#
			30pF	±2%	GRM0335C2A300GA01#
				±5%	GRM0335C2A300JA01#
			33pF	±2%	GRM0335C2A330GA01#
				±5%	GRM0335C2A330JA01#
			36pF	±2%	GRM0335C2A360GA01#
				±5%	GRM0335C2A360JA01#
			39pF	±2%	GRM0335C2A390GA01#
				±5%	GRM0335C2A390JA01#
			43pF	±2%	GRM0335C2A430GA01#
				±5%	GRM0335C2A430JA01#
			47pF	±2%	GRM0335C2A470GA01#
				±5%	GRM0335C2A470JA01#
			51pF	±2%	GRM0335C2A510GA01#
				±5%	GRM0335C2A510JA01#
			56pF	±2%	GRM0335C2A560GA01#
				±5%	GRM0335C2A560JA01#
			62pF	±2%	GRM0335C2A620GA01#
				±5%	GRM0335C2A620JA01#

T max.	Rated Voltage	TC Code	Cap.	Tol.	Part Number	
0.33mm	100Vdc	COG	68pF	±2%	GRM0335C2A680GA01#	
				±5%	GRM0335C2A680JA01#	
			75pF	±2%	GRM0335C2A750GA01#	
				±5%	GRM0335C2A750JA01#	
			82pF	±2%	GRM0335C2A820GA01#	
				±5%	GRM0335C2A820JA01#	
			91pF	±2%	GRM0335C2A910GA01#	
				±5%	GRM0335C2A910JA01#	
			100pF	±2%	GRM0335C2A101GA01#	
				±5%	GRM0335C2A101JA01#	
			CK	0.10pF	±0.05pF	GRM0334C2AR10WA01#
					±0.1pF	GRM0334C2AR20WA01#
				0.20pF	±0.05pF	GRM0334C2AR20WA01#
					±0.1pF	GRM0334C2AR20BA01#
				0.30pF	±0.05pF	GRM0334C2AR30WA01#
					±0.1pF	GRM0334C2AR30BA01#
				0.40pF	±0.05pF	GRM0334C2AR40WA01#
					±0.1pF	GRM0334C2AR40BA01#
				0.50pF	±0.05pF	GRM0334C2AR50WA01#
					±0.1pF	GRM0334C2AR50BA01#
				0.60pF	±0.05pF	GRM0334C2AR60WA01#
					±0.1pF	GRM0334C2AR60BA01#
				0.70pF	±0.05pF	GRM0334C2AR70WA01#
					±0.1pF	GRM0334C2AR70BA01#
				0.80pF	±0.05pF	GRM0334C2AR80WA01#
					±0.1pF	GRM0334C2AR80BA01#
				0.90pF	±0.05pF	GRM0334C2AR90WA01#
					±0.1pF	GRM0334C2AR90BA01#
				1.0pF	±0.05pF	GRM0334C2A1R0WA01#
					±0.1pF	GRM0334C2A1R0BA01#
		±0.25pF			GRM0334C2A1R0CA01#	
		1.1pF		±0.05pF	GRM0334C2A1R1WA01#	
				±0.1pF	GRM0334C2A1R1BA01#	
				±0.25pF	GRM0334C2A1R1CA01#	
		1.2pF		±0.05pF	GRM0334C2A1R2WA01#	
				±0.1pF	GRM0334C2A1R2BA01#	
				±0.25pF	GRM0334C2A1R2CA01#	
		1.3pF		±0.05pF	GRM0334C2A1R3WA01#	
				±0.1pF	GRM0334C2A1R3BA01#	
				±0.25pF	GRM0334C2A1R3CA01#	
		1.4pF	±0.05pF	GRM0334C2A1R4WA01#		
			±0.1pF	GRM0334C2A1R4BA01#		
			±0.25pF	GRM0334C2A1R4CA01#		
		1.5pF	±0.05pF	GRM0334C2A1R5WA01#		
			±0.1pF	GRM0334C2A1R5BA01#		
			±0.25pF	GRM0334C2A1R5CA01#		
		1.6pF	±0.05pF	GRM0334C2A1R6WA01#		
			±0.1pF	GRM0334C2A1R6BA01#		
			±0.25pF	GRM0334C2A1R6CA01#		
		1.7pF	±0.05pF	GRM0334C2A1R7WA01#		
			±0.1pF	GRM0334C2A1R7BA01#		
			±0.25pF	GRM0334C2A1R7CA01#		
		1.8pF	±0.05pF	GRM0334C2A1R8WA01#		
			±0.1pF	GRM0334C2A1R8BA01#		
			±0.25pF	GRM0334C2A1R8CA01#		

- GRM
- GR3
- GRJ
- GR4
- GR7
- GJM
- GQM
- GA2
- GA3 GB
- GA3 GD
- GA3 GF
- LLL
- LLA
- LLM
- LLR
- NFM
- KRM
- KR3
- GMA
- GMD
- ⚠Caution /Notice

Part number # indicates the package specification code.

GRM Series Temperature Compensating Type Part Number List

(→ 0.6×0.3mm)

T max.	Rated Voltage	TC Code	Cap.	Tol.	Part Number	
0.33mm	100Vdc	CK	1.9pF	±0.05pF	GRM0334C2A1R9WA01#	
				±0.1pF	GRM0334C2A1R9BA01#	
				±0.25pF	GRM0334C2A1R9CA01#	
			2.0pF	±0.05pF	GRM0334C2A2R0WA01#	
				±0.1pF	GRM0334C2A2R0BA01#	
				±0.25pF	GRM0334C2A2R0CA01#	
			CJ	2.1pF	±0.05pF	GRM0333C2A2R1WA01#
					±0.1pF	GRM0333C2A2R1BA01#
					±0.25pF	GRM0333C2A2R1CA01#
				2.2pF	±0.05pF	GRM0333C2A2R2WA01#
					±0.1pF	GRM0333C2A2R2BA01#
					±0.25pF	GRM0333C2A2R2CA01#
				2.3pF	±0.05pF	GRM0333C2A2R3WA01#
					±0.1pF	GRM0333C2A2R3BA01#
					±0.25pF	GRM0333C2A2R3CA01#
				2.4pF	±0.05pF	GRM0333C2A2R4WA01#
					±0.1pF	GRM0333C2A2R4BA01#
					±0.25pF	GRM0333C2A2R4CA01#
				2.5pF	±0.05pF	GRM0333C2A2R5WA01#
					±0.1pF	GRM0333C2A2R5BA01#
					±0.25pF	GRM0333C2A2R5CA01#
				2.6pF	±0.05pF	GRM0333C2A2R6WA01#
					±0.1pF	GRM0333C2A2R6BA01#
					±0.25pF	GRM0333C2A2R6CA01#
				2.7pF	±0.05pF	GRM0333C2A2R7WA01#
					±0.1pF	GRM0333C2A2R7BA01#
					±0.25pF	GRM0333C2A2R7CA01#
				2.8pF	±0.05pF	GRM0333C2A2R8WA01#
					±0.1pF	GRM0333C2A2R8BA01#
					±0.25pF	GRM0333C2A2R8CA01#
				2.9pF	±0.05pF	GRM0333C2A2R9WA01#
					±0.1pF	GRM0333C2A2R9BA01#
					±0.25pF	GRM0333C2A2R9CA01#
				3.0pF	±0.05pF	GRM0333C2A3R0WA01#
					±0.1pF	GRM0333C2A3R0BA01#
					±0.25pF	GRM0333C2A3R0CA01#
		3.1pF		±0.05pF	GRM0333C2A3R1WA01#	
				±0.1pF	GRM0333C2A3R1BA01#	
				±0.25pF	GRM0333C2A3R1CA01#	
		3.2pF		±0.05pF	GRM0333C2A3R2WA01#	
				±0.1pF	GRM0333C2A3R2BA01#	
				±0.25pF	GRM0333C2A3R2CA01#	
		3.3pF	±0.05pF	GRM0333C2A3R3WA01#		
			±0.1pF	GRM0333C2A3R3BA01#		
			±0.25pF	GRM0333C2A3R3CA01#		
		3.4pF	±0.05pF	GRM0333C2A3R4WA01#		
			±0.1pF	GRM0333C2A3R4BA01#		
			±0.25pF	GRM0333C2A3R4CA01#		
		3.5pF	±0.05pF	GRM0333C2A3R5WA01#		
			±0.1pF	GRM0333C2A3R5BA01#		
			±0.25pF	GRM0333C2A3R5CA01#		
		3.6pF	±0.05pF	GRM0333C2A3R6WA01#		
			±0.1pF	GRM0333C2A3R6BA01#		
			±0.25pF	GRM0333C2A3R6CA01#		

T max.	Rated Voltage	TC Code	Cap.	Tol.	Part Number	
0.33mm	100Vdc	CJ	3.7pF	±0.05pF	GRM0333C2A3R7WA01#	
				±0.1pF	GRM0333C2A3R7BA01#	
				±0.25pF	GRM0333C2A3R7CA01#	
			3.8pF	±0.05pF	GRM0333C2A3R8WA01#	
				±0.1pF	GRM0333C2A3R8BA01#	
				±0.25pF	GRM0333C2A3R8CA01#	
			3.9pF	±0.05pF	GRM0333C2A3R9WA01#	
				±0.1pF	GRM0333C2A3R9BA01#	
				±0.25pF	GRM0333C2A3R9CA01#	
			CH	4.0pF	±0.05pF	GRM0332C2A4R0WA01#
					±0.1pF	GRM0332C2A4R0BA01#
					±0.25pF	GRM0332C2A4R0CA01#
				4.1pF	±0.05pF	GRM0332C2A4R1WA01#
					±0.1pF	GRM0332C2A4R1BA01#
					±0.25pF	GRM0332C2A4R1CA01#
				4.2pF	±0.05pF	GRM0332C2A4R2WA01#
					±0.1pF	GRM0332C2A4R2BA01#
					±0.25pF	GRM0332C2A4R2CA01#
				4.3pF	±0.05pF	GRM0332C2A4R3WA01#
					±0.1pF	GRM0332C2A4R3BA01#
					±0.25pF	GRM0332C2A4R3CA01#
				4.4pF	±0.05pF	GRM0332C2A4R4WA01#
					±0.1pF	GRM0332C2A4R4BA01#
					±0.25pF	GRM0332C2A4R4CA01#
				4.5pF	±0.05pF	GRM0332C2A4R5WA01#
					±0.1pF	GRM0332C2A4R5BA01#
					±0.25pF	GRM0332C2A4R5CA01#
				4.6pF	±0.05pF	GRM0332C2A4R6WA01#
					±0.1pF	GRM0332C2A4R6BA01#
					±0.25pF	GRM0332C2A4R6CA01#
				4.7pF	±0.05pF	GRM0332C2A4R7WA01#
					±0.1pF	GRM0332C2A4R7BA01#
					±0.25pF	GRM0332C2A4R7CA01#
				4.8pF	±0.05pF	GRM0332C2A4R8WA01#
					±0.1pF	GRM0332C2A4R8BA01#
					±0.25pF	GRM0332C2A4R8CA01#
		4.9pF		±0.05pF	GRM0332C2A4R9WA01#	
				±0.1pF	GRM0332C2A4R9BA01#	
				±0.25pF	GRM0332C2A4R9CA01#	
		5.0pF		±0.05pF	GRM0332C2A5R0WA01#	
				±0.1pF	GRM0332C2A5R0BA01#	
				±0.25pF	GRM0332C2A5R0CA01#	
		5.1pF		±0.05pF	GRM0332C2A5R1WA01#	
				±0.1pF	GRM0332C2A5R1BA01#	
				±0.25pF	GRM0332C2A5R1CA01#	
		5.2pF	±0.05pF	GRM0332C2A5R2WA01#		
			±0.1pF	GRM0332C2A5R2BA01#		
			±0.25pF	GRM0332C2A5R2CA01#		
		5.3pF	±0.05pF	GRM0332C2A5R3WA01#		
			±0.1pF	GRM0332C2A5R3BA01#		
			±0.25pF	GRM0332C2A5R3CA01#		
					±0.5pF	GRM0332C2A5R3DA01#

Part number # indicates the package specification code.

- GRM
- GR3
- GRJ
- GR4
- GR7
- GJM
- GQM
- GA2
- GA3 GB
- GA3 GD
- GA3 GF
- LLL
- LLA
- LLM
- LLR
- NFM
- KRM
- KR3
- GMA
- GMD
- ⚠Caution /Notice

GRM Series Temperature Compensating Type Part Number List

(→ 0.6×0.3mm)

T max.	Rated Voltage	TC Code	Cap.	Tol.	Part Number
0.33mm	100Vdc	CH	5.4pF	±0.05pF	GRM0332C2A5R4WA01#
				±0.1pF	GRM0332C2A5R4BA01#
				±0.25pF	GRM0332C2A5R4CA01#
				±0.5pF	GRM0332C2A5R4DA01#
			5.5pF	±0.05pF	GRM0332C2A5R5WA01#
				±0.1pF	GRM0332C2A5R5BA01#
				±0.25pF	GRM0332C2A5R5CA01#
				±0.5pF	GRM0332C2A5R5DA01#
			5.6pF	±0.05pF	GRM0332C2A5R6WA01#
				±0.1pF	GRM0332C2A5R6BA01#
				±0.25pF	GRM0332C2A5R6CA01#
				±0.5pF	GRM0332C2A5R6DA01#
			5.7pF	±0.05pF	GRM0332C2A5R7WA01#
				±0.1pF	GRM0332C2A5R7BA01#
				±0.25pF	GRM0332C2A5R7CA01#
				±0.5pF	GRM0332C2A5R7DA01#
			5.8pF	±0.05pF	GRM0332C2A5R8WA01#
				±0.1pF	GRM0332C2A5R8BA01#
				±0.25pF	GRM0332C2A5R8CA01#
				±0.5pF	GRM0332C2A5R8DA01#
			5.9pF	±0.05pF	GRM0332C2A5R9WA01#
				±0.1pF	GRM0332C2A5R9BA01#
				±0.25pF	GRM0332C2A5R9CA01#
				±0.5pF	GRM0332C2A5R9DA01#
			6.0pF	±0.05pF	GRM0332C2A6R0WA01#
				±0.1pF	GRM0332C2A6R0BA01#
				±0.25pF	GRM0332C2A6R0CA01#
				±0.5pF	GRM0332C2A6R0DA01#
			6.1pF	±0.05pF	GRM0332C2A6R1WA01#
				±0.1pF	GRM0332C2A6R1BA01#
				±0.25pF	GRM0332C2A6R1CA01#
				±0.5pF	GRM0332C2A6R1DA01#
			6.2pF	±0.05pF	GRM0332C2A6R2WA01#
				±0.1pF	GRM0332C2A6R2BA01#
				±0.25pF	GRM0332C2A6R2CA01#
				±0.5pF	GRM0332C2A6R2DA01#
			6.3pF	±0.05pF	GRM0332C2A6R3WA01#
				±0.1pF	GRM0332C2A6R3BA01#
				±0.25pF	GRM0332C2A6R3CA01#
				±0.5pF	GRM0332C2A6R3DA01#
			6.4pF	±0.05pF	GRM0332C2A6R4WA01#
				±0.1pF	GRM0332C2A6R4BA01#
				±0.25pF	GRM0332C2A6R4CA01#
				±0.5pF	GRM0332C2A6R4DA01#
			6.5pF	±0.05pF	GRM0332C2A6R5WA01#
				±0.1pF	GRM0332C2A6R5BA01#
				±0.25pF	GRM0332C2A6R5CA01#
				±0.5pF	GRM0332C2A6R5DA01#
			6.6pF	±0.05pF	GRM0332C2A6R6WA01#
				±0.1pF	GRM0332C2A6R6BA01#
				±0.25pF	GRM0332C2A6R6CA01#
				±0.5pF	GRM0332C2A6R6DA01#
			6.7pF	±0.05pF	GRM0332C2A6R7WA01#
				±0.1pF	GRM0332C2A6R7BA01#

T max.	Rated Voltage	TC Code	Cap.	Tol.	Part Number
0.33mm	100Vdc	CH	6.7pF	±0.25pF	GRM0332C2A6R7CA01#
				±0.5pF	GRM0332C2A6R7DA01#
			6.8pF	±0.05pF	GRM0332C2A6R8WA01#
				±0.1pF	GRM0332C2A6R8BA01#
				±0.25pF	GRM0332C2A6R8CA01#
			6.9pF	±0.05pF	GRM0332C2A6R9WA01#
				±0.1pF	GRM0332C2A6R9BA01#
				±0.25pF	GRM0332C2A6R9CA01#
			7.0pF	±0.05pF	GRM0332C2A7R0WA01#
				±0.1pF	GRM0332C2A7R0BA01#
				±0.25pF	GRM0332C2A7R0CA01#
			7.1pF	±0.05pF	GRM0332C2A7R1WA01#
				±0.1pF	GRM0332C2A7R1BA01#
				±0.25pF	GRM0332C2A7R1CA01#
			7.2pF	±0.05pF	GRM0332C2A7R2WA01#
				±0.1pF	GRM0332C2A7R2BA01#
				±0.25pF	GRM0332C2A7R2CA01#
			7.3pF	±0.05pF	GRM0332C2A7R3WA01#
				±0.1pF	GRM0332C2A7R3BA01#
				±0.25pF	GRM0332C2A7R3CA01#
			7.4pF	±0.05pF	GRM0332C2A7R4WA01#
				±0.1pF	GRM0332C2A7R4BA01#
				±0.25pF	GRM0332C2A7R4CA01#
			7.5pF	±0.05pF	GRM0332C2A7R5WA01#
				±0.1pF	GRM0332C2A7R5BA01#
				±0.25pF	GRM0332C2A7R5CA01#
			7.6pF	±0.05pF	GRM0332C2A7R6WA01#
				±0.1pF	GRM0332C2A7R6BA01#
				±0.25pF	GRM0332C2A7R6CA01#
			7.7pF	±0.05pF	GRM0332C2A7R7WA01#
				±0.1pF	GRM0332C2A7R7BA01#
				±0.25pF	GRM0332C2A7R7CA01#
			7.8pF	±0.05pF	GRM0332C2A7R8WA01#
				±0.1pF	GRM0332C2A7R8BA01#
				±0.25pF	GRM0332C2A7R8CA01#
			7.9pF	±0.05pF	GRM0332C2A7R9WA01#
				±0.1pF	GRM0332C2A7R9BA01#
				±0.25pF	GRM0332C2A7R9CA01#
			8.0pF	±0.05pF	GRM0332C2A8R0WA01#
				±0.1pF	GRM0332C2A8R0BA01#
				±0.25pF	GRM0332C2A8R0CA01#

- GRM
- GR3
- GRJ
- GRU
- GR4
- GR7
- GJM
- GQM
- GA2
- GA3 GB
- GA3 GD
- GA3 GF
- LLL
- LLA
- LLM
- LLR
- NFM
- KRM
- KR3
- GMA
- GMD
- ⚠Caution /Notice

Part number # indicates the package specification code.

GRM Series Temperature Compensating Type Part Number List

(→ 0.6×0.3mm)

T max.	Rated Voltage	TC Code	Cap.	Tol.	Part Number
0.33mm	100Vdc	CH	8.1pF	±0.05pF	GRM0332C2A8R1WA01#
				±0.1pF	GRM0332C2A8R1BA01#
				±0.25pF	GRM0332C2A8R1CA01#
				±0.5pF	GRM0332C2A8R1DA01#
			8.2pF	±0.05pF	GRM0332C2A8R2WA01#
				±0.1pF	GRM0332C2A8R2BA01#
				±0.25pF	GRM0332C2A8R2CA01#
				±0.5pF	GRM0332C2A8R2DA01#
			8.3pF	±0.05pF	GRM0332C2A8R3WA01#
				±0.1pF	GRM0332C2A8R3BA01#
				±0.25pF	GRM0332C2A8R3CA01#
				±0.5pF	GRM0332C2A8R3DA01#
			8.4pF	±0.05pF	GRM0332C2A8R4WA01#
				±0.1pF	GRM0332C2A8R4BA01#
				±0.25pF	GRM0332C2A8R4CA01#
				±0.5pF	GRM0332C2A8R4DA01#
			8.5pF	±0.05pF	GRM0332C2A8R5WA01#
				±0.1pF	GRM0332C2A8R5BA01#
				±0.25pF	GRM0332C2A8R5CA01#
				±0.5pF	GRM0332C2A8R5DA01#
			8.6pF	±0.05pF	GRM0332C2A8R6WA01#
				±0.1pF	GRM0332C2A8R6BA01#
				±0.25pF	GRM0332C2A8R6CA01#
				±0.5pF	GRM0332C2A8R6DA01#
			8.7pF	±0.05pF	GRM0332C2A8R7WA01#
				±0.1pF	GRM0332C2A8R7BA01#
				±0.25pF	GRM0332C2A8R7CA01#
				±0.5pF	GRM0332C2A8R7DA01#
			8.8pF	±0.05pF	GRM0332C2A8R8WA01#
				±0.1pF	GRM0332C2A8R8BA01#
				±0.25pF	GRM0332C2A8R8CA01#
				±0.5pF	GRM0332C2A8R8DA01#
			8.9pF	±0.05pF	GRM0332C2A8R9WA01#
				±0.1pF	GRM0332C2A8R9BA01#
				±0.25pF	GRM0332C2A8R9CA01#
				±0.5pF	GRM0332C2A8R9DA01#
			9.0pF	±0.05pF	GRM0332C2A9R0WA01#
				±0.1pF	GRM0332C2A9R0BA01#
				±0.25pF	GRM0332C2A9R0CA01#
				±0.5pF	GRM0332C2A9R0DA01#
			9.1pF	±0.05pF	GRM0332C2A9R1WA01#
				±0.1pF	GRM0332C2A9R1BA01#
				±0.25pF	GRM0332C2A9R1CA01#
				±0.5pF	GRM0332C2A9R1DA01#
			9.2pF	±0.05pF	GRM0332C2A9R2WA01#
				±0.1pF	GRM0332C2A9R2BA01#
				±0.25pF	GRM0332C2A9R2CA01#
				±0.5pF	GRM0332C2A9R2DA01#
9.3pF	±0.05pF	GRM0332C2A9R3WA01#			
	±0.1pF	GRM0332C2A9R3BA01#			
	±0.25pF	GRM0332C2A9R3CA01#			
	±0.5pF	GRM0332C2A9R3DA01#			
9.4pF	±0.05pF	GRM0332C2A9R4WA01#			
	±0.1pF	GRM0332C2A9R4BA01#			

T max.	Rated Voltage	TC Code	Cap.	Tol.	Part Number
0.33mm	100Vdc	CH	9.4pF	±0.25pF	GRM0332C2A9R4CA01#
				±0.5pF	GRM0332C2A9R4DA01#
			9.5pF	±0.05pF	GRM0332C2A9R5WA01#
				±0.1pF	GRM0332C2A9R5BA01#
				±0.25pF	GRM0332C2A9R5CA01#
			9.6pF	±0.05pF	GRM0332C2A9R6WA01#
				±0.1pF	GRM0332C2A9R6BA01#
				±0.25pF	GRM0332C2A9R6CA01#
			9.7pF	±0.05pF	GRM0332C2A9R7WA01#
				±0.1pF	GRM0332C2A9R7BA01#
				±0.25pF	GRM0332C2A9R7CA01#
			9.8pF	±0.05pF	GRM0332C2A9R8WA01#
				±0.1pF	GRM0332C2A9R8BA01#
				±0.25pF	GRM0332C2A9R8CA01#
			9.9pF	±0.05pF	GRM0332C2A9R9WA01#
				±0.1pF	GRM0332C2A9R9BA01#
				±0.25pF	GRM0332C2A9R9CA01#
			10pF	±2%	GRM0332C2A100GA01#
				±5%	GRM0332C2A100JA01#
			12pF	±2%	GRM0332C2A120GA01#
				±5%	GRM0332C2A120JA01#
			15pF	±2%	GRM0332C2A150GA01#
				±5%	GRM0332C2A150JA01#
			18pF	±2%	GRM0332C2A180GA01#
				±5%	GRM0332C2A180JA01#
			20pF	±2%	GRM0332C2A200GA01#
				±5%	GRM0332C2A200JA01#
			22pF	±2%	GRM0332C2A220GA01#
				±5%	GRM0332C2A220JA01#
			24pF	±2%	GRM0332C2A240GA01#
				±5%	GRM0332C2A240JA01#
			27pF	±2%	GRM0332C2A270GA01#
				±5%	GRM0332C2A270JA01#
			30pF	±2%	GRM0332C2A300GA01#
				±5%	GRM0332C2A300JA01#
			33pF	±2%	GRM0332C2A330GA01#
				±5%	GRM0332C2A330JA01#
			36pF	±2%	GRM0332C2A360GA01#
				±5%	GRM0332C2A360JA01#
			39pF	±2%	GRM0332C2A390GA01#
				±5%	GRM0332C2A390JA01#
			43pF	±2%	GRM0332C2A430GA01#
				±5%	GRM0332C2A430JA01#
			47pF	±2%	GRM0332C2A470GA01#
				±5%	GRM0332C2A470JA01#
			51pF	±2%	GRM0332C2A510GA01#
				±5%	GRM0332C2A510JA01#
			56pF	±2%	GRM0332C2A560GA01#
±5%	GRM0332C2A560JA01#				

Part number # indicates the package specification code.



GRM Series Temperature Compensating Type Part Number List

(→ 0.6×0.3mm)

T max.	Rated Voltage	TC Code	Cap.	Tol.	Part Number	T max.	Rated Voltage	TC Code	Cap.	Tol.	Part Number		
0.33mm	100Vdc	CH	62pF	±2%	GRM0332C2A620GA01#	0.33mm	50Vdc	COG	1.8pF	±0.1pF	GRM0335C1H1R8BA01#		
				±5%	GRM0332C2A620JA01#					±0.25pF	GRM0335C1H1R8CA01#		
			68pF	±2%	GRM0332C2A680GA01#				1.9pF	±0.05pF	GRM0335C1H1R9WA01#		
				±5%	GRM0332C2A680JA01#					±0.1pF	GRM0335C1H1R9BA01#		
			75pF	±2%	GRM0332C2A750GA01#				2.0pF	±0.25pF	GRM0335C1H1R9CA01#		
				±5%	GRM0332C2A750JA01#					±0.05pF	GRM0335C1H2R0WA01#		
			82pF	±2%	GRM0332C2A820GA01#				2.1pF	±0.1pF	GRM0335C1H2R0BA01#		
				±5%	GRM0332C2A820JA01#					±0.25pF	GRM0335C1H2R0CA01#		
			91pF	±2%	GRM0332C2A910GA01#				2.2pF	±0.05pF	GRM0335C1H2R1WA01#		
				±5%	GRM0332C2A910JA01#					±0.1pF	GRM0335C1H2R1BA01#		
			100pF	±2%	GRM0332C2A101GA01#				2.3pF	±0.25pF	GRM0335C1H2R1CA01#		
				±5%	GRM0332C2A101JA01#					±0.05pF	GRM0335C1H2R2WA01#		
			50Vdc	COG	0.10pF				±0.05pF	GRM0335C1HR10WA01#	2.4pF	±0.1pF	GRM0335C1H2R2BA01#
									±0.1pF	GRM0335C1HR20BA01#		±0.25pF	GRM0335C1H2R2CA01#
					0.20pF				±0.05pF	GRM0335C1HR20WA01#	2.5pF	±0.05pF	GRM0335C1H2R3WA01#
	±0.1pF	GRM0335C1HR30BA01#							±0.1pF	GRM0335C1H2R3BA01#			
	0.30pF	±0.05pF			GRM0335C1HR30WA01#				2.6pF	±0.25pF	GRM0335C1H2R3CA01#		
		±0.1pF			GRM0335C1HR30BA01#					±0.05pF	GRM0335C1H2R4WA01#		
	0.40pF	±0.05pF			GRM0335C1HR40WA01#				2.7pF	±0.1pF	GRM0335C1H2R4BA01#		
		±0.1pF			GRM0335C1HR40BA01#					±0.25pF	GRM0335C1H2R4CA01#		
	0.50pF	±0.05pF			GRM0335C1HR50WA01#				2.8pF	±0.05pF	GRM0335C1H2R5WA01#		
		±0.1pF			GRM0335C1HR50BA01#					±0.1pF	GRM0335C1H2R5BA01#		
	0.60pF	±0.05pF			GRM0335C1HR60WA01#				2.9pF	±0.25pF	GRM0335C1H2R5CA01#		
		±0.1pF			GRM0335C1HR60BA01#					±0.05pF	GRM0335C1H2R6WA01#		
	0.70pF	±0.05pF			GRM0335C1HR70WA01#				3.0pF	±0.1pF	GRM0335C1H2R6BA01#		
		±0.1pF			GRM0335C1HR70BA01#					±0.25pF	GRM0335C1H2R6CA01#		
	0.80pF	±0.05pF			GRM0335C1HR80WA01#				3.1pF	±0.05pF	GRM0335C1H2R7WA01#		
		±0.1pF			GRM0335C1HR80BA01#					±0.1pF	GRM0335C1H2R7BA01#		
	0.90pF	±0.05pF			GRM0335C1HR90WA01#				3.2pF	±0.25pF	GRM0335C1H2R7CA01#		
		±0.1pF			GRM0335C1HR90BA01#					±0.05pF	GRM0335C1H2R8WA01#		
1.0pF	±0.05pF	GRM0335C1H1R0WA01#			3.3pF	±0.1pF	GRM0335C1H2R8BA01#						
	±0.1pF	GRM0335C1H1R0BA01#				±0.25pF	GRM0335C1H2R8CA01#						
	±0.25pF	GRM0335C1H1R0CA01#				±0.05pF	GRM0335C1H2R9WA01#						
1.1pF	±0.05pF	GRM0335C1H1R1WA01#			3.4pF	±0.1pF	GRM0335C1H2R9BA01#						
	±0.1pF	GRM0335C1H1R1BA01#				±0.25pF	GRM0335C1H2R9CA01#						
	±0.25pF	GRM0335C1H1R1CA01#				±0.05pF	GRM0335C1H3R0WA01#						
1.2pF	±0.05pF	GRM0335C1H1R2WA01#			3.5pF	±0.1pF	GRM0335C1H3R0BA01#						
	±0.1pF	GRM0335C1H1R2BA01#				±0.25pF	GRM0335C1H3R0CA01#						
	±0.25pF	GRM0335C1H1R2CA01#				±0.05pF	GRM0335C1H3R1WA01#						
1.3pF	±0.05pF	GRM0335C1H1R3WA01#			3.6pF	±0.1pF	GRM0335C1H3R1BA01#						
	±0.1pF	GRM0335C1H1R3BA01#				±0.25pF	GRM0335C1H3R1CA01#						
	±0.25pF	GRM0335C1H1R3CA01#				±0.05pF	GRM0335C1H3R2WA01#						
1.4pF	±0.05pF	GRM0335C1H1R4WA01#	3.7pF	±0.1pF	GRM0335C1H3R2BA01#								
	±0.1pF	GRM0335C1H1R4BA01#		±0.25pF	GRM0335C1H3R2CA01#								
	±0.25pF	GRM0335C1H1R4CA01#		±0.05pF	GRM0335C1H3R3WA01#								
1.5pF	±0.05pF	GRM0335C1H1R5WA01#	3.8pF	±0.1pF	GRM0335C1H3R3BA01#								
	±0.1pF	GRM0335C1H1R5BA01#		±0.25pF	GRM0335C1H3R3CA01#								
	±0.25pF	GRM0335C1H1R5CA01#		±0.05pF	GRM0335C1H3R4WA01#								
1.6pF	±0.05pF	GRM0335C1H1R6WA01#	3.9pF	±0.1pF	GRM0335C1H3R4BA01#								
	±0.1pF	GRM0335C1H1R6BA01#		±0.25pF	GRM0335C1H3R4CA01#								
	±0.25pF	GRM0335C1H1R6CA01#		±0.05pF	GRM0335C1H3R5WA01#								
1.7pF	±0.05pF	GRM0335C1H1R7WA01#	4.0pF	±0.1pF	GRM0335C1H3R5BA01#								
	±0.1pF	GRM0335C1H1R7BA01#		±0.25pF	GRM0335C1H3R5CA01#								
	±0.25pF	GRM0335C1H1R7CA01#		±0.05pF	GRM0335C1H3R6WA01#								
1.8pF	±0.05pF	GRM0335C1H1R8WA01#											

Part number # indicates the package specification code.

- GRM
- GR3
- GRJ
- GRU
- GR4
- GR7
- GJM
- GQM
- GA2
- GA3 GB
- GA3 GD
- GA3 GF
- LLL
- LLA
- LLM
- LLR
- NFM
- KRM
- KR3
- GMA
- GMD
- ⚠Caution /Notice

GRM Series Temperature Compensating Type Part Number List

(→ 0.6×0.3mm)

T max.	Rated Voltage	TC Code	Cap.	Tol.	Part Number
0.33mm	50Vdc	COG	3.6pF	±0.1pF	GRM0335C1H3R6BA01#
				±0.25pF	GRM0335C1H3R6CA01#
			3.7pF	±0.05pF	GRM0335C1H3R7WA01#
				±0.1pF	GRM0335C1H3R7BA01#
				±0.25pF	GRM0335C1H3R7CA01#
			3.8pF	±0.05pF	GRM0335C1H3R8WA01#
				±0.1pF	GRM0335C1H3R8BA01#
				±0.25pF	GRM0335C1H3R8CA01#
			3.9pF	±0.05pF	GRM0335C1H3R9WA01#
				±0.1pF	GRM0335C1H3R9BA01#
				±0.25pF	GRM0335C1H3R9CA01#
			4.0pF	±0.05pF	GRM0335C1H4R0WA01#
				±0.1pF	GRM0335C1H4R0BA01#
				±0.25pF	GRM0335C1H4R0CA01#
			4.1pF	±0.05pF	GRM0335C1H4R1WA01#
				±0.1pF	GRM0335C1H4R1BA01#
				±0.25pF	GRM0335C1H4R1CA01#
			4.2pF	±0.05pF	GRM0335C1H4R2WA01#
				±0.1pF	GRM0335C1H4R2BA01#
				±0.25pF	GRM0335C1H4R2CA01#
			4.3pF	±0.05pF	GRM0335C1H4R3WA01#
				±0.1pF	GRM0335C1H4R3BA01#
				±0.25pF	GRM0335C1H4R3CA01#
			4.4pF	±0.05pF	GRM0335C1H4R4WA01#
				±0.1pF	GRM0335C1H4R4BA01#
				±0.25pF	GRM0335C1H4R4CA01#
			4.5pF	±0.05pF	GRM0335C1H4R5WA01#
				±0.1pF	GRM0335C1H4R5BA01#
				±0.25pF	GRM0335C1H4R5CA01#
			4.6pF	±0.05pF	GRM0335C1H4R6WA01#
				±0.1pF	GRM0335C1H4R6BA01#
				±0.25pF	GRM0335C1H4R6CA01#
			4.7pF	±0.05pF	GRM0335C1H4R7WA01#
				±0.1pF	GRM0335C1H4R7BA01#
				±0.25pF	GRM0335C1H4R7CA01#
			4.8pF	±0.05pF	GRM0335C1H4R8WA01#
				±0.1pF	GRM0335C1H4R8BA01#
				±0.25pF	GRM0335C1H4R8CA01#
			4.9pF	±0.05pF	GRM0335C1H4R9WA01#
				±0.1pF	GRM0335C1H4R9BA01#
				±0.25pF	GRM0335C1H4R9CA01#
			5.0pF	±0.05pF	GRM0335C1H5R0WA01#
				±0.1pF	GRM0335C1H5R0BA01#
				±0.25pF	GRM0335C1H5R0CA01#
			5.1pF	±0.05pF	GRM0335C1H5R1WA01#
				±0.1pF	GRM0335C1H5R1BA01#
				±0.25pF	GRM0335C1H5R1CA01#
				±0.5pF	GRM0335C1H5R1DA01#
			5.2pF	±0.05pF	GRM0335C1H5R2WA01#
				±0.1pF	GRM0335C1H5R2BA01#
				±0.25pF	GRM0335C1H5R2CA01#
				±0.5pF	GRM0335C1H5R2DA01#
			5.3pF	±0.05pF	GRM0335C1H5R3WA01#
				±0.1pF	GRM0335C1H5R3BA01#

T max.	Rated Voltage	TC Code	Cap.	Tol.	Part Number
0.33mm	50Vdc	COG	5.3pF	±0.25pF	GRM0335C1H5R3CA01#
				±0.5pF	GRM0335C1H5R3DA01#
			5.4pF	±0.05pF	GRM0335C1H5R4WA01#
				±0.1pF	GRM0335C1H5R4BA01#
				±0.25pF	GRM0335C1H5R4CA01#
			5.5pF	±0.05pF	GRM0335C1H5R5WA01#
				±0.1pF	GRM0335C1H5R5BA01#
				±0.25pF	GRM0335C1H5R5CA01#
			5.6pF	±0.05pF	GRM0335C1H5R6WA01#
				±0.1pF	GRM0335C1H5R6BA01#
				±0.25pF	GRM0335C1H5R6CA01#
			5.7pF	±0.05pF	GRM0335C1H5R7WA01#
				±0.1pF	GRM0335C1H5R7BA01#
				±0.25pF	GRM0335C1H5R7CA01#
			5.8pF	±0.05pF	GRM0335C1H5R8WA01#
				±0.1pF	GRM0335C1H5R8BA01#
				±0.25pF	GRM0335C1H5R8CA01#
			5.9pF	±0.05pF	GRM0335C1H5R9WA01#
				±0.1pF	GRM0335C1H5R9BA01#
				±0.25pF	GRM0335C1H5R9CA01#
			6.0pF	±0.05pF	GRM0335C1H6R0WA01#
				±0.1pF	GRM0335C1H6R0BA01#
				±0.25pF	GRM0335C1H6R0CA01#
			6.1pF	±0.05pF	GRM0335C1H6R1WA01#
				±0.1pF	GRM0335C1H6R1BA01#
				±0.25pF	GRM0335C1H6R1CA01#
			6.2pF	±0.05pF	GRM0335C1H6R2WA01#
				±0.1pF	GRM0335C1H6R2BA01#
				±0.25pF	GRM0335C1H6R2CA01#
			6.3pF	±0.05pF	GRM0335C1H6R3WA01#
				±0.1pF	GRM0335C1H6R3BA01#
				±0.25pF	GRM0335C1H6R3CA01#
			6.4pF	±0.05pF	GRM0335C1H6R4WA01#
				±0.1pF	GRM0335C1H6R4BA01#
				±0.25pF	GRM0335C1H6R4CA01#
			6.5pF	±0.05pF	GRM0335C1H6R5WA01#
				±0.1pF	GRM0335C1H6R5BA01#
				±0.25pF	GRM0335C1H6R5CA01#
			6.6pF	±0.05pF	GRM0335C1H6R6WA01#
				±0.1pF	GRM0335C1H6R6BA01#
				±0.25pF	GRM0335C1H6R6CA01#

Part number # indicates the package specification code.

- GRM
- GR3
- GRJ
- GR4
- GR7
- GJM
- GQM
- GA2
- GA3 GB
- GA3 GD
- GA3 GF
- LLL
- LLA
- LLM
- LLR
- NFM
- KRM
- KR3
- GMA
- GMD
- ⚠Caution /Notice

GRM Series Temperature Compensating Type Part Number List

(→ 0.6×0.3mm)

T max.	Rated Voltage	TC Code	Cap.	Tol.	Part Number	T max.	Rated Voltage	TC Code	Cap.	Tol.	Part Number	
0.33mm	50Vdc	COG	6.7pF	±0.05pF	GRM0335C1H6R7WA01#	0.33mm	50Vdc	COG	8.0pF	±0.25pF	GRM0335C1H8R0CA01#	
				±0.1pF	GRM0335C1H6R7BA01#					±0.5pF	GRM0335C1H8R0DA01#	
				±0.25pF	GRM0335C1H6R7CA01#					8.1pF	±0.05pF	GRM0335C1H8R1WA01#
				±0.5pF	GRM0335C1H6R7DA01#						±0.1pF	GRM0335C1H8R1BA01#
			6.8pF	±0.05pF	GRM0335C1H6R8WA01#				±0.25pF	GRM0335C1H8R1CA01#		
				±0.1pF	GRM0335C1H6R8BA01#				±0.5pF	GRM0335C1H8R1DA01#		
				±0.25pF	GRM0335C1H6R8CA01#				8.2pF	±0.05pF	GRM0335C1H8R2WA01#	
				±0.5pF	GRM0335C1H6R8DA01#					±0.1pF	GRM0335C1H8R2BA01#	
			6.9pF	±0.05pF	GRM0335C1H6R9WA01#				±0.25pF	GRM0335C1H8R2CA01#		
				±0.1pF	GRM0335C1H6R9BA01#				±0.5pF	GRM0335C1H8R2DA01#		
				±0.25pF	GRM0335C1H6R9CA01#				8.3pF	±0.05pF	GRM0335C1H8R3WA01#	
				±0.5pF	GRM0335C1H6R9DA01#					±0.1pF	GRM0335C1H8R3BA01#	
			7.0pF	±0.05pF	GRM0335C1H7R0WA01#				±0.25pF	GRM0335C1H8R3CA01#		
				±0.1pF	GRM0335C1H7R0BA01#				±0.5pF	GRM0335C1H8R3DA01#		
				±0.25pF	GRM0335C1H7R0CA01#				8.4pF	±0.05pF	GRM0335C1H8R4WA01#	
				±0.5pF	GRM0335C1H7R0DA01#					±0.1pF	GRM0335C1H8R4BA01#	
			7.1pF	±0.05pF	GRM0335C1H7R1WA01#				±0.25pF	GRM0335C1H8R4CA01#		
				±0.1pF	GRM0335C1H7R1BA01#				±0.5pF	GRM0335C1H8R4DA01#		
				±0.25pF	GRM0335C1H7R1CA01#				8.5pF	±0.05pF	GRM0335C1H8R5WA01#	
				±0.5pF	GRM0335C1H7R1DA01#					±0.1pF	GRM0335C1H8R5BA01#	
			7.2pF	±0.05pF	GRM0335C1H7R2WA01#				±0.25pF	GRM0335C1H8R5CA01#		
				±0.1pF	GRM0335C1H7R2BA01#				±0.5pF	GRM0335C1H8R5DA01#		
				±0.25pF	GRM0335C1H7R2CA01#				8.6pF	±0.05pF	GRM0335C1H8R6WA01#	
				±0.5pF	GRM0335C1H7R2DA01#					±0.1pF	GRM0335C1H8R6BA01#	
			7.3pF	±0.05pF	GRM0335C1H7R3WA01#				±0.25pF	GRM0335C1H8R6CA01#		
				±0.1pF	GRM0335C1H7R3BA01#				±0.5pF	GRM0335C1H8R6DA01#		
				±0.25pF	GRM0335C1H7R3CA01#				8.7pF	±0.05pF	GRM0335C1H8R7WA01#	
				±0.5pF	GRM0335C1H7R3DA01#					±0.1pF	GRM0335C1H8R7BA01#	
			7.4pF	±0.05pF	GRM0335C1H7R4WA01#				±0.25pF	GRM0335C1H8R7CA01#		
				±0.1pF	GRM0335C1H7R4BA01#				±0.5pF	GRM0335C1H8R7DA01#		
				±0.25pF	GRM0335C1H7R4CA01#				8.8pF	±0.05pF	GRM0335C1H8R8WA01#	
				±0.5pF	GRM0335C1H7R4DA01#					±0.1pF	GRM0335C1H8R8BA01#	
			7.5pF	±0.05pF	GRM0335C1H7R5WA01#				±0.25pF	GRM0335C1H8R8CA01#		
				±0.1pF	GRM0335C1H7R5BA01#				±0.5pF	GRM0335C1H8R8DA01#		
				±0.25pF	GRM0335C1H7R5CA01#				8.9pF	±0.05pF	GRM0335C1H8R9WA01#	
				±0.5pF	GRM0335C1H7R5DA01#					±0.1pF	GRM0335C1H8R9BA01#	
			7.6pF	±0.05pF	GRM0335C1H7R6WA01#				±0.25pF	GRM0335C1H8R9CA01#		
				±0.1pF	GRM0335C1H7R6BA01#				±0.5pF	GRM0335C1H8R9DA01#		
				±0.25pF	GRM0335C1H7R6CA01#				9.0pF	±0.05pF	GRM0335C1H9R0WA01#	
				±0.5pF	GRM0335C1H7R6DA01#					±0.1pF	GRM0335C1H9R0BA01#	
			7.7pF	±0.05pF	GRM0335C1H7R7WA01#				±0.25pF	GRM0335C1H9R0CA01#		
				±0.1pF	GRM0335C1H7R7BA01#				±0.5pF	GRM0335C1H9R0DA01#		
				±0.25pF	GRM0335C1H7R7CA01#				9.1pF	±0.05pF	GRM0335C1H9R1WA01#	
				±0.5pF	GRM0335C1H7R7DA01#					±0.1pF	GRM0335C1H9R1BA01#	
			7.8pF	±0.05pF	GRM0335C1H7R8WA01#				±0.25pF	GRM0335C1H9R1CA01#		
				±0.1pF	GRM0335C1H7R8BA01#				±0.5pF	GRM0335C1H9R1DA01#		
				±0.25pF	GRM0335C1H7R8CA01#				9.2pF	±0.05pF	GRM0335C1H9R2WA01#	
				±0.5pF	GRM0335C1H7R8DA01#					±0.1pF	GRM0335C1H9R2BA01#	
			7.9pF	±0.05pF	GRM0335C1H7R9WA01#				±0.25pF	GRM0335C1H9R2CA01#		
				±0.1pF	GRM0335C1H7R9BA01#				±0.5pF	GRM0335C1H9R2DA01#		
				±0.25pF	GRM0335C1H7R9CA01#				9.3pF	±0.05pF	GRM0335C1H9R3WA01#	
				±0.5pF	GRM0335C1H7R9DA01#					±0.1pF	GRM0335C1H9R3BA01#	
			8.0pF	±0.05pF	GRM0335C1H8R0WA01#				±0.25pF	GRM0335C1H9R3CA01#		
				±0.1pF	GRM0335C1H8R0BA01#				±0.5pF	GRM0335C1H9R3DA01#		

GRM
 GR3
 GRJ
 GRU
 GR4
 GR7
 GJM
 GQM
 GA2
 GA3 GB
 GA3 GD
 GA3 GF
 LLL
 LLA
 LLM
 LLR
 NFM
 KRM
 KR3
 GMA
 GMD
 ⚠Caution /Notice

Part number # indicates the package specification code.

GRM Series Temperature Compensating Type Part Number List

(→ 0.6×0.3mm)

T max.	Rated Voltage	TC Code	Cap.	Tol.	Part Number
0.33mm	50Vdc	COG	9.4pF	±0.05pF	GRM0335C1H9R4WA01#
				±0.1pF	GRM0335C1H9R4BA01#
				±0.25pF	GRM0335C1H9R4CA01#
				±0.5pF	GRM0335C1H9R4DA01#
			9.5pF	±0.05pF	GRM0335C1H9R5WA01#
				±0.1pF	GRM0335C1H9R5BA01#
				±0.25pF	GRM0335C1H9R5CA01#
				±0.5pF	GRM0335C1H9R5DA01#
			9.6pF	±0.05pF	GRM0335C1H9R6WA01#
				±0.1pF	GRM0335C1H9R6BA01#
				±0.25pF	GRM0335C1H9R6CA01#
				±0.5pF	GRM0335C1H9R6DA01#
			9.7pF	±0.05pF	GRM0335C1H9R7WA01#
				±0.1pF	GRM0335C1H9R7BA01#
				±0.25pF	GRM0335C1H9R7CA01#
				±0.5pF	GRM0335C1H9R7DA01#
			9.8pF	±0.05pF	GRM0335C1H9R8WA01#
				±0.1pF	GRM0335C1H9R8BA01#
				±0.25pF	GRM0335C1H9R8CA01#
				±0.5pF	GRM0335C1H9R8DA01#
			9.9pF	±0.05pF	GRM0335C1H9R9WA01#
				±0.1pF	GRM0335C1H9R9BA01#
				±0.25pF	GRM0335C1H9R9CA01#
				±0.5pF	GRM0335C1H9R9DA01#
			10pF	±2%	GRM0335C1H100GA01#
				±5%	GRM0335C1H100JA01#
			12pF	±2%	GRM0335C1H120GA01#
				±5%	GRM0335C1H120JA01#
			15pF	±2%	GRM0335C1H150GA01#
				±5%	GRM0335C1H150JA01#
			18pF	±2%	GRM0335C1H180GA01#
				±5%	GRM0335C1H180JA01#
			22pF	±2%	GRM0335C1H220GA01#
				±5%	GRM0335C1H220JA01#
			27pF	±2%	GRM0335C1H270GA01#
				±5%	GRM0335C1H270JA01#
			33pF	±2%	GRM0335C1H330GA01#
				±5%	GRM0335C1H330JA01#
			39pF	±2%	GRM0335C1H390GA01#
				±5%	GRM0335C1H390JA01#
			47pF	±2%	GRM0335C1H470GA01#
				±5%	GRM0335C1H470JA01#
			56pF	±2%	GRM0335C1H560GA01#
				±5%	GRM0335C1H560JA01#
			68pF	±2%	GRM0335C1H680GA01#
				±5%	GRM0335C1H680JA01#
			82pF	±2%	GRM0335C1H820GA01#
				±5%	GRM0335C1H820JA01#
			100pF	±2%	GRM0335C1H101GA01#
				±5%	GRM0335C1H101JA01#
			120pF	±2%	GRM0335C1H121GA01#
				±5%	GRM0335C1H121JA01#
			150pF	±2%	GRM0335C1H151GA01#
				±5%	GRM0335C1H151JA01#

T max.	Rated Voltage	TC Code	Cap.	Tol.	Part Number		
0.33mm	50Vdc	COG	180pF	±2%	GRM0335C1H181GA01#		
				±5%	GRM0335C1H181JA01#		
				220pF	±2%	GRM0335C1H221GA01#	
					±5%	GRM0335C1H221JA01#	
			CK	0.10pF	±0.05pF	GRM0334C1HR10WA01#	
					0.20pF	±0.05pF	GRM0334C1HR20WA01#
						±0.1pF	GRM0334C1HR20BA01#
					0.30pF	±0.05pF	GRM0334C1HR30WA01#
						±0.1pF	GRM0334C1HR30BA01#
					0.40pF	±0.05pF	GRM0334C1HR40WA01#
						±0.1pF	GRM0334C1HR40BA01#
					0.50pF	±0.05pF	GRM0334C1HR50WA01#
						±0.1pF	GRM0334C1HR50BA01#
					0.60pF	±0.05pF	GRM0334C1HR60WA01#
						±0.1pF	GRM0334C1HR60BA01#
					0.70pF	±0.05pF	GRM0334C1HR70WA01#
						±0.1pF	GRM0334C1HR70BA01#
					0.80pF	±0.05pF	GRM0334C1HR80WA01#
						±0.1pF	GRM0334C1HR80BA01#
					0.90pF	±0.05pF	GRM0334C1HR90WA01#
						±0.1pF	GRM0334C1HR90BA01#
					1.0pF	±0.05pF	GRM0334C1H1R0WA01#
						±0.1pF	GRM0334C1H1R0BA01#
						±0.25pF	GRM0334C1H1R0CA01#
					1.1pF	±0.05pF	GRM0334C1H1R1WA01#
						±0.1pF	GRM0334C1H1R1BA01#
						±0.25pF	GRM0334C1H1R1CA01#
					1.2pF	±0.05pF	GRM0334C1H1R2WA01#
						±0.1pF	GRM0334C1H1R2BA01#
						±0.25pF	GRM0334C1H1R2CA01#
					1.3pF	±0.05pF	GRM0334C1H1R3WA01#
						±0.1pF	GRM0334C1H1R3BA01#
						±0.25pF	GRM0334C1H1R3CA01#
					1.4pF	±0.05pF	GRM0334C1H1R4WA01#
						±0.1pF	GRM0334C1H1R4BA01#
						±0.25pF	GRM0334C1H1R4CA01#
					1.5pF	±0.05pF	GRM0334C1H1R5WA01#
						±0.1pF	GRM0334C1H1R5BA01#
						±0.25pF	GRM0334C1H1R5CA01#
					1.6pF	±0.05pF	GRM0334C1H1R6WA01#
						±0.1pF	GRM0334C1H1R6BA01#
						±0.25pF	GRM0334C1H1R6CA01#
					1.7pF	±0.05pF	GRM0334C1H1R7WA01#
						±0.1pF	GRM0334C1H1R7BA01#
						±0.25pF	GRM0334C1H1R7CA01#
					1.8pF	±0.05pF	GRM0334C1H1R8WA01#
						±0.1pF	GRM0334C1H1R8BA01#
						±0.25pF	GRM0334C1H1R8CA01#
					1.9pF	±0.05pF	GRM0334C1H1R9WA01#
						±0.1pF	GRM0334C1H1R9BA01#
						±0.25pF	GRM0334C1H1R9CA01#
					2.0pF	±0.05pF	GRM0334C1H2R0WA01#
						±0.1pF	GRM0334C1H2R0BA01#
						±0.25pF	GRM0334C1H2R0CA01#

Part number # indicates the package specification code.

GRM
 GR3
 GRJ
 GR4
 GR7
 GJM
 GQM
 GA2
 GA3 GB
 GA3 GD
 GA3 GF
 LLL
 LLA
 LLM
 LLR
 NFM
 KRM
 KR3
 GMA
 GMD
 ⚠Caution /Notice

GRM Series Temperature Compensating Type Part Number List

(→ 0.6×0.3mm)

T max.	Rated Voltage	TC Code	Cap.	Tol.	Part Number	T max.	Rated Voltage	TC Code	Cap.	Tol.	Part Number	
0.33mm	50Vdc	CJ	2.1pF	±0.05pF	GRM0333C1H2R1WA01#	0.33mm	50Vdc	CJ	3.9pF	±0.05pF	GRM0333C1H3R9WA01#	
				±0.1pF	GRM0333C1H2R1BA01#					±0.1pF	GRM0333C1H3R9BA01#	
				±0.25pF	GRM0333C1H2R1CA01#					±0.25pF	GRM0333C1H3R9CA01#	
			2.2pF	±0.05pF	GRM0333C1H2R2WA01#				CH	4.0pF	±0.05pF	GRM0332C1H4R0WA01#
				±0.1pF	GRM0333C1H2R2BA01#						±0.1pF	GRM0332C1H4R0BA01#
				±0.25pF	GRM0333C1H2R2CA01#						±0.25pF	GRM0332C1H4R0CA01#
			2.3pF	±0.05pF	GRM0333C1H2R3WA01#				4.1pF	±0.05pF	GRM0332C1H4R1WA01#	
				±0.1pF	GRM0333C1H2R3BA01#					±0.1pF	GRM0332C1H4R1BA01#	
				±0.25pF	GRM0333C1H2R3CA01#					±0.25pF	GRM0332C1H4R1CA01#	
			2.4pF	±0.05pF	GRM0333C1H2R4WA01#				4.2pF	±0.05pF	GRM0332C1H4R2WA01#	
				±0.1pF	GRM0333C1H2R4BA01#					±0.1pF	GRM0332C1H4R2BA01#	
				±0.25pF	GRM0333C1H2R4CA01#					±0.25pF	GRM0332C1H4R2CA01#	
			2.5pF	±0.05pF	GRM0333C1H2R5WA01#				4.3pF	±0.05pF	GRM0332C1H4R3WA01#	
				±0.1pF	GRM0333C1H2R5BA01#					±0.1pF	GRM0332C1H4R3BA01#	
				±0.25pF	GRM0333C1H2R5CA01#					±0.25pF	GRM0332C1H4R3CA01#	
			2.6pF	±0.05pF	GRM0333C1H2R6WA01#				4.4pF	±0.05pF	GRM0332C1H4R4WA01#	
				±0.1pF	GRM0333C1H2R6BA01#					±0.1pF	GRM0332C1H4R4BA01#	
				±0.25pF	GRM0333C1H2R6CA01#					±0.25pF	GRM0332C1H4R4CA01#	
			2.7pF	±0.05pF	GRM0333C1H2R7WA01#				4.5pF	±0.05pF	GRM0332C1H4R5WA01#	
				±0.1pF	GRM0333C1H2R7BA01#					±0.1pF	GRM0332C1H4R5BA01#	
				±0.25pF	GRM0333C1H2R7CA01#					±0.25pF	GRM0332C1H4R5CA01#	
			2.8pF	±0.05pF	GRM0333C1H2R8WA01#				4.6pF	±0.05pF	GRM0332C1H4R6WA01#	
				±0.1pF	GRM0333C1H2R8BA01#					±0.1pF	GRM0332C1H4R6BA01#	
				±0.25pF	GRM0333C1H2R8CA01#					±0.25pF	GRM0332C1H4R6CA01#	
			2.9pF	±0.05pF	GRM0333C1H2R9WA01#				4.7pF	±0.05pF	GRM0332C1H4R7WA01#	
				±0.1pF	GRM0333C1H2R9BA01#					±0.1pF	GRM0332C1H4R7BA01#	
				±0.25pF	GRM0333C1H2R9CA01#					±0.25pF	GRM0332C1H4R7CA01#	
			3.0pF	±0.05pF	GRM0333C1H3R0WA01#				4.8pF	±0.05pF	GRM0332C1H4R8WA01#	
				±0.1pF	GRM0333C1H3R0BA01#					±0.1pF	GRM0332C1H4R8BA01#	
				±0.25pF	GRM0333C1H3R0CA01#					±0.25pF	GRM0332C1H4R8CA01#	
			3.1pF	±0.05pF	GRM0333C1H3R1WA01#				4.9pF	±0.05pF	GRM0332C1H4R9WA01#	
				±0.1pF	GRM0333C1H3R1BA01#					±0.1pF	GRM0332C1H4R9BA01#	
				±0.25pF	GRM0333C1H3R1CA01#					±0.25pF	GRM0332C1H4R9CA01#	
			3.2pF	±0.05pF	GRM0333C1H3R2WA01#				5.0pF	±0.05pF	GRM0332C1H5R0WA01#	
				±0.1pF	GRM0333C1H3R2BA01#					±0.1pF	GRM0332C1H5R0BA01#	
				±0.25pF	GRM0333C1H3R2CA01#					±0.25pF	GRM0332C1H5R0CA01#	
			3.3pF	±0.05pF	GRM0333C1H3R3WA01#				5.1pF	±0.05pF	GRM0332C1H5R1WA01#	
				±0.1pF	GRM0333C1H3R3BA01#					±0.1pF	GRM0332C1H5R1BA01#	
				±0.25pF	GRM0333C1H3R3CA01#					±0.25pF	GRM0332C1H5R1CA01#	
			3.4pF	±0.05pF	GRM0333C1H3R4WA01#				5.2pF	±0.05pF	GRM0332C1H5R2WA01#	
				±0.1pF	GRM0333C1H3R4BA01#					±0.1pF	GRM0332C1H5R2BA01#	
				±0.25pF	GRM0333C1H3R4CA01#					±0.25pF	GRM0332C1H5R2CA01#	
			3.5pF	±0.05pF	GRM0333C1H3R5WA01#				5.3pF	±0.05pF	GRM0332C1H5R3WA01#	
				±0.1pF	GRM0333C1H3R5BA01#					±0.1pF	GRM0332C1H5R3BA01#	
				±0.25pF	GRM0333C1H3R5CA01#					±0.25pF	GRM0332C1H5R3CA01#	
			3.6pF	±0.05pF	GRM0333C1H3R6WA01#				5.4pF	±0.05pF	GRM0332C1H5R4WA01#	
				±0.1pF	GRM0333C1H3R6BA01#					±0.1pF	GRM0332C1H5R4BA01#	
				±0.25pF	GRM0333C1H3R6CA01#					±0.25pF	GRM0332C1H5R4CA01#	
			3.7pF	±0.05pF	GRM0333C1H3R7WA01#				5.5pF	±0.05pF	GRM0332C1H5R5WA01#	
				±0.1pF	GRM0333C1H3R7BA01#					±0.1pF	GRM0332C1H5R5BA01#	
				±0.25pF	GRM0333C1H3R7CA01#					±0.25pF	GRM0332C1H5R5CA01#	
			3.8pF	±0.05pF	GRM0333C1H3R8WA01#					±0.05pF	GRM0332C1H5R5WA01#	
				±0.1pF	GRM0333C1H3R8BA01#					±0.1pF	GRM0332C1H5R5BA01#	
				±0.25pF	GRM0333C1H3R8CA01#					±0.25pF	GRM0332C1H5R5CA01#	

Part number # indicates the package specification code.

GRM
 GR3
 GRJ
 GR4
 GR7
 GJM
 GQM
 GA2
 GA3 GB
 GA3 GD
 GA3 GF
 LLL
 LLA
 LLM
 LLR
 NFM
 KRM
 KR3
 GMA
 GMD
 ⚠Caution /Notice

GRM Series Temperature Compensating Type Part Number List

(→ 0.6×0.3mm)

T max.	Rated Voltage	TC Code	Cap.	Tol.	Part Number	T max.	Rated Voltage	TC Code	Cap.	Tol.	Part Number
0.33mm	50Vdc	CH	5.5pF	±0.25pF	GRM0332C1H5R5CA01#	0.33mm	50Vdc	CH	6.9pF	±0.05pF	GRM0332C1H6R9WA01#
				±0.5pF	GRM0332C1H5R5DA01#					±0.1pF	GRM0332C1H6R9BA01#
			5.6pF	±0.05pF	GRM0332C1H5R6WA01#				±0.25pF	GRM0332C1H6R9CA01#	
				±0.1pF	GRM0332C1H5R6BA01#				±0.5pF	GRM0332C1H6R9DA01#	
				±0.25pF	GRM0332C1H5R6CA01#				7.0pF	±0.05pF	GRM0332C1H7R0WA01#
				±0.5pF	GRM0332C1H5R6DA01#					±0.1pF	GRM0332C1H7R0BA01#
			5.7pF	±0.05pF	GRM0332C1H5R7WA01#					±0.25pF	GRM0332C1H7R0CA01#
				±0.1pF	GRM0332C1H5R7BA01#				±0.5pF	GRM0332C1H7R0DA01#	
				±0.25pF	GRM0332C1H5R7CA01#				7.1pF	±0.05pF	GRM0332C1H7R1WA01#
			±0.5pF	GRM0332C1H5R7DA01#	±0.1pF					GRM0332C1H7R1BA01#	
			5.8pF	±0.05pF	GRM0332C1H5R8WA01#					±0.25pF	GRM0332C1H7R1CA01#
				±0.1pF	GRM0332C1H5R8BA01#				±0.5pF	GRM0332C1H7R1DA01#	
				±0.25pF	GRM0332C1H5R8CA01#				7.2pF	±0.05pF	GRM0332C1H7R2WA01#
				±0.5pF	GRM0332C1H5R8DA01#					±0.1pF	GRM0332C1H7R2BA01#
			5.9pF	±0.05pF	GRM0332C1H5R9WA01#					±0.25pF	GRM0332C1H7R2CA01#
				±0.1pF	GRM0332C1H5R9BA01#				±0.5pF	GRM0332C1H7R2DA01#	
				±0.25pF	GRM0332C1H5R9CA01#				7.3pF	±0.05pF	GRM0332C1H7R3WA01#
				±0.5pF	GRM0332C1H5R9DA01#					±0.1pF	GRM0332C1H7R3BA01#
			6.0pF	±0.05pF	GRM0332C1H6R0WA01#					±0.25pF	GRM0332C1H7R3CA01#
				±0.1pF	GRM0332C1H6R0BA01#				±0.5pF	GRM0332C1H7R3DA01#	
				±0.25pF	GRM0332C1H6R0CA01#				7.4pF	±0.05pF	GRM0332C1H7R4WA01#
				±0.5pF	GRM0332C1H6R0DA01#					±0.1pF	GRM0332C1H7R4BA01#
			6.1pF	±0.05pF	GRM0332C1H6R1WA01#					±0.25pF	GRM0332C1H7R4CA01#
				±0.1pF	GRM0332C1H6R1BA01#				±0.5pF	GRM0332C1H7R4DA01#	
				±0.25pF	GRM0332C1H6R1CA01#				7.5pF	±0.05pF	GRM0332C1H7R5WA01#
				±0.5pF	GRM0332C1H6R1DA01#					±0.1pF	GRM0332C1H7R5BA01#
			6.2pF	±0.05pF	GRM0332C1H6R2WA01#					±0.25pF	GRM0332C1H7R5CA01#
				±0.1pF	GRM0332C1H6R2BA01#				±0.5pF	GRM0332C1H7R5DA01#	
				±0.25pF	GRM0332C1H6R2CA01#				7.6pF	±0.05pF	GRM0332C1H7R6WA01#
				±0.5pF	GRM0332C1H6R2DA01#					±0.1pF	GRM0332C1H7R6BA01#
			6.3pF	±0.05pF	GRM0332C1H6R3WA01#					±0.25pF	GRM0332C1H7R6CA01#
				±0.1pF	GRM0332C1H6R3BA01#				±0.5pF	GRM0332C1H7R6DA01#	
				±0.25pF	GRM0332C1H6R3CA01#				7.7pF	±0.05pF	GRM0332C1H7R7WA01#
				±0.5pF	GRM0332C1H6R3DA01#					±0.1pF	GRM0332C1H7R7BA01#
			6.4pF	±0.05pF	GRM0332C1H6R4WA01#					±0.25pF	GRM0332C1H7R7CA01#
				±0.1pF	GRM0332C1H6R4BA01#				±0.5pF	GRM0332C1H7R7DA01#	
				±0.25pF	GRM0332C1H6R4CA01#				7.8pF	±0.05pF	GRM0332C1H7R8WA01#
				±0.5pF	GRM0332C1H6R4DA01#					±0.1pF	GRM0332C1H7R8BA01#
			6.5pF	±0.05pF	GRM0332C1H6R5WA01#					±0.25pF	GRM0332C1H7R8CA01#
				±0.1pF	GRM0332C1H6R5BA01#				±0.5pF	GRM0332C1H7R8DA01#	
				±0.25pF	GRM0332C1H6R5CA01#				7.9pF	±0.05pF	GRM0332C1H7R9WA01#
				±0.5pF	GRM0332C1H6R5DA01#					±0.1pF	GRM0332C1H7R9BA01#
			6.6pF	±0.05pF	GRM0332C1H6R6WA01#					±0.25pF	GRM0332C1H7R9CA01#
				±0.1pF	GRM0332C1H6R6BA01#				±0.5pF	GRM0332C1H7R9DA01#	
				±0.25pF	GRM0332C1H6R6CA01#				8.0pF	±0.05pF	GRM0332C1H8R0WA01#
				±0.5pF	GRM0332C1H6R6DA01#					±0.1pF	GRM0332C1H8R0BA01#
			6.7pF	±0.05pF	GRM0332C1H6R7WA01#					±0.25pF	GRM0332C1H8R0CA01#
				±0.1pF	GRM0332C1H6R7BA01#				±0.5pF	GRM0332C1H8R0DA01#	
				±0.25pF	GRM0332C1H6R7CA01#				8.1pF	±0.05pF	GRM0332C1H8R1WA01#
				±0.5pF	GRM0332C1H6R7DA01#					±0.1pF	GRM0332C1H8R1BA01#
			6.8pF	±0.05pF	GRM0332C1H6R8WA01#					±0.25pF	GRM0332C1H8R1CA01#
				±0.1pF	GRM0332C1H6R8BA01#				±0.5pF	GRM0332C1H8R1DA01#	
				±0.25pF	GRM0332C1H6R8CA01#				8.2pF	±0.05pF	GRM0332C1H8R2WA01#
				±0.5pF	GRM0332C1H6R8DA01#					±0.1pF	GRM0332C1H8R2BA01#

Part number # indicates the package specification code.



GRM Series Temperature Compensating Type Part Number List

(→ 0.6×0.3mm)

T max.	Rated Voltage	TC Code	Cap.	Tol.	Part Number	T max.	Rated Voltage	TC Code	Cap.	Tol.	Part Number
0.33mm	50Vdc	CH	8.2pF	±0.25pF	GRM0332C1H8R2CA01#	0.33mm	50Vdc	CH	9.6pF	±0.05pF	GRM0332C1H9R6WA01#
				±0.5pF	GRM0332C1H8R2DA01#					±0.1pF	GRM0332C1H9R6BA01#
			8.3pF	±0.05pF	GRM0332C1H8R3WA01#	9.6pF			±0.25pF	GRM0332C1H9R6CA01#	
				±0.1pF	GRM0332C1H8R3BA01#				±0.5pF	GRM0332C1H9R6DA01#	
				±0.25pF	GRM0332C1H8R3CA01#				9.7pF	±0.05pF	GRM0332C1H9R7WA01#
				±0.5pF	GRM0332C1H8R3DA01#					±0.1pF	GRM0332C1H9R7BA01#
			8.4pF	±0.05pF	GRM0332C1H8R4WA01#	±0.25pF				GRM0332C1H9R7CA01#	
				±0.1pF	GRM0332C1H8R4BA01#	±0.5pF			GRM0332C1H9R7DA01#		
				±0.25pF	GRM0332C1H8R4CA01#	9.8pF			±0.05pF	GRM0332C1H9R8WA01#	
			±0.5pF	GRM0332C1H8R4DA01#	±0.1pF				GRM0332C1H9R8BA01#		
			8.5pF	±0.05pF	GRM0332C1H8R5WA01#				±0.25pF	GRM0332C1H9R8CA01#	
				±0.1pF	GRM0332C1H8R5BA01#	±0.5pF			GRM0332C1H9R8DA01#		
				±0.25pF	GRM0332C1H8R5CA01#	9.9pF			±0.05pF	GRM0332C1H9R9WA01#	
				±0.5pF	GRM0332C1H8R5DA01#				±0.1pF	GRM0332C1H9R9BA01#	
			8.6pF	±0.05pF	GRM0332C1H8R6WA01#				±0.25pF	GRM0332C1H9R9CA01#	
				±0.1pF	GRM0332C1H8R6BA01#	±0.5pF			GRM0332C1H9R9DA01#		
				±0.25pF	GRM0332C1H8R6CA01#	10pF			±2%	GRM0332C1H100GA01#	
				±0.5pF	GRM0332C1H8R6DA01#				±5%	GRM0332C1H100JA01#	
			8.7pF	±0.05pF	GRM0332C1H8R7WA01#	12pF			±2%	GRM0332C1H120GA01#	
				±0.1pF	GRM0332C1H8R7BA01#				±5%	GRM0332C1H120JA01#	
				±0.25pF	GRM0332C1H8R7CA01#	15pF			±2%	GRM0332C1H150GA01#	
				±0.5pF	GRM0332C1H8R7DA01#				±5%	GRM0332C1H150JA01#	
			8.8pF	±0.05pF	GRM0332C1H8R8WA01#	18pF			±2%	GRM0332C1H180GA01#	
				±0.1pF	GRM0332C1H8R8BA01#				±5%	GRM0332C1H180JA01#	
				±0.25pF	GRM0332C1H8R8CA01#	22pF			±2%	GRM0332C1H220GA01#	
				±0.5pF	GRM0332C1H8R8DA01#				±5%	GRM0332C1H220JA01#	
			8.9pF	±0.05pF	GRM0332C1H8R9WA01#	27pF			±2%	GRM0332C1H270GA01#	
				±0.1pF	GRM0332C1H8R9BA01#				±5%	GRM0332C1H270JA01#	
				±0.25pF	GRM0332C1H8R9CA01#	33pF			±2%	GRM0332C1H330GA01#	
				±0.5pF	GRM0332C1H8R9DA01#				±5%	GRM0332C1H330JA01#	
			9.0pF	±0.05pF	GRM0332C1H9R0WA01#	39pF			±2%	GRM0332C1H390GA01#	
				±0.1pF	GRM0332C1H9R0BA01#				±5%	GRM0332C1H390JA01#	
				±0.25pF	GRM0332C1H9R0CA01#	47pF			±2%	GRM0332C1H470GA01#	
				±0.5pF	GRM0332C1H9R0DA01#				±5%	GRM0332C1H470JA01#	
			9.1pF	±0.05pF	GRM0332C1H9R1WA01#	56pF			±2%	GRM0332C1H560GA01#	
				±0.1pF	GRM0332C1H9R1BA01#				±5%	GRM0332C1H560JA01#	
				±0.25pF	GRM0332C1H9R1CA01#	68pF			±2%	GRM0332C1H680GA01#	
				±0.5pF	GRM0332C1H9R1DA01#				±5%	GRM0332C1H680JA01#	
			9.2pF	±0.05pF	GRM0332C1H9R2WA01#	82pF			±2%	GRM0332C1H820GA01#	
				±0.1pF	GRM0332C1H9R2BA01#				±5%	GRM0332C1H820JA01#	
				±0.25pF	GRM0332C1H9R2CA01#	100pF			±2%	GRM0332C1H101GA01#	
				±0.5pF	GRM0332C1H9R2DA01#				±5%	GRM0332C1H101JA01#	
			9.3pF	±0.05pF	GRM0332C1H9R3WA01#	120pF			±2%	GRM0332C1H121GA01#	
				±0.1pF	GRM0332C1H9R3BA01#				±5%	GRM0332C1H121JA01#	
				±0.25pF	GRM0332C1H9R3CA01#	150pF			±2%	GRM0332C1H151GA01#	
				±0.5pF	GRM0332C1H9R3DA01#				±5%	GRM0332C1H151JA01#	
			9.4pF	±0.05pF	GRM0332C1H9R4WA01#	180pF			±2%	GRM0332C1H181GA01#	
				±0.1pF	GRM0332C1H9R4BA01#				±5%	GRM0332C1H181JA01#	
				±0.25pF	GRM0332C1H9R4CA01#	220pF			±2%	GRM0332C1H221GA01#	
				±0.5pF	GRM0332C1H9R4DA01#				±5%	GRM0332C1H221JA01#	
			9.5pF	±0.05pF	GRM0332C1H9R5WA01#	270pF			±2%	GRM0335C1E271GA01#	
				±0.1pF	GRM0332C1H9R5BA01#				±5%	GRM0335C1E271JA01#	
				±0.25pF	GRM0332C1H9R5CA01#				330pF	±2%	GRM0335C1E331GA01#
				±0.5pF	GRM0332C1H9R5DA01#					±5%	GRM0335C1E331JA01#

GRM
 GR3
 GRJ
 GR4
 GR7
 GJM
 GQM
 GA2
 GA3 GB
 GA3 GD
 GA3 GF
 LLL
 LLA
 LLM
 LLR
 NFM
 KRM
 KR3
 GMA
 GMD
 ⚠Caution /Notice

Part number # indicates the package specification code.

GRM Series Temperature Compensating Type Part Number List

(→ 0.6×0.3mm)

T max.	Rated Voltage	TC Code	Cap.	Tol.	Part Number	
0.33mm	25Vdc	COG	390pF	±2%	GRM0335C1E391GA01#	
				±5%	GRM0335C1E391JA01#	
			470pF	±2%	GRM0335C1E471GA01#	
				±5%	GRM0335C1E471JA01#	
			560pF	±2%	GRM0335C1E561GA01#	
				±5%	GRM0335C1E561JA01#	
			680pF	±2%	GRM0335C1E681GA01#	
				±5%	GRM0335C1E681JA01#	
			820pF	±2%	GRM0335C1E821GA01#	
				±5%	GRM0335C1E821JA01#	
			910pF	±2%	GRM0335C1E911GA01#	
				±5%	GRM0335C1E911JA01#	
			1000pF	±2%	GRM0335C1E102GA01#	
				±5%	GRM0335C1E102JA01#	
			CH	270pF	±2%	GRM0332C1E271GA01#
					±5%	GRM0332C1E271JA01#
				330pF	±2%	GRM0332C1E331GA01#
					±5%	GRM0332C1E331JA01#
		390pF		±2%	GRM0332C1E391GA01#	
				±5%	GRM0332C1E391JA01#	
		470pF		±2%	GRM0332C1E471GA01#	
				±5%	GRM0332C1E471JA01#	
		560pF		±2%	GRM0332C1E561GA01#	
				±5%	GRM0332C1E561JA01#	
		680pF		±2%	GRM0332C1E681GA01#	
				±5%	GRM0332C1E681JA01#	
		820pF		±2%	GRM0332C1E821GA01#	
				±5%	GRM0332C1E821JA01#	
		1000pF		±2%	GRM0332C1E102GA01#	
				±5%	GRM0332C1E102JA01#	

1.0×0.5mm

T max.	Rated Voltage	TC Code	Cap.	Tol.	Part Number
0.55mm	100Vdc	COG	0.10pF	±0.05pF	GRM1555C2AR10WA01#
				±0.1pF	GRM1555C2AR10BA01#
			0.20pF	±0.05pF	GRM1555C2AR20WA01#
				±0.1pF	GRM1555C2AR20BA01#
			0.30pF	±0.05pF	GRM1555C2AR30WA01#
				±0.1pF	GRM1555C2AR30BA01#
			0.40pF	±0.05pF	GRM1555C2AR40WA01#
				±0.1pF	GRM1555C2AR40BA01#
			0.50pF	±0.05pF	GRM1555C2AR50WA01#
				±0.1pF	GRM1555C2AR50BA01#
			0.60pF	±0.05pF	GRM1555C2AR60WA01#
				±0.1pF	GRM1555C2AR60BA01#
			0.70pF	±0.05pF	GRM1555C2AR70WA01#
				±0.1pF	GRM1555C2AR70BA01#
			0.80pF	±0.05pF	GRM1555C2AR80WA01#
				±0.1pF	GRM1555C2AR80BA01#
			0.90pF	±0.05pF	GRM1555C2AR90WA01#
				±0.1pF	GRM1555C2AR90BA01#
			1.0pF	±0.05pF	GRM1555C2A1R0WA01#
				±0.1pF	GRM1555C2A1R0BA01#

T max.	Rated Voltage	TC Code	Cap.	Tol.	Part Number
0.55mm	100Vdc	COG	1.0pF	±0.25pF	GRM1555C2A1R0CA01#
				±0.05pF	GRM1555C2A1R1WA01#
				±0.1pF	GRM1555C2A1R1BA01#
			1.1pF	±0.25pF	GRM1555C2A1R1CA01#
				±0.05pF	GRM1555C2A1R2WA01#
				±0.1pF	GRM1555C2A1R2BA01#
			1.2pF	±0.25pF	GRM1555C2A1R2CA01#
				±0.05pF	GRM1555C2A1R3WA01#
				±0.1pF	GRM1555C2A1R3BA01#
			1.3pF	±0.25pF	GRM1555C2A1R3CA01#
				±0.05pF	GRM1555C2A1R4WA01#
				±0.1pF	GRM1555C2A1R4BA01#
			1.4pF	±0.25pF	GRM1555C2A1R4CA01#
				±0.05pF	GRM1555C2A1R5WA01#
				±0.1pF	GRM1555C2A1R5BA01#
			1.5pF	±0.25pF	GRM1555C2A1R5CA01#
				±0.05pF	GRM1555C2A1R6WA01#
				±0.1pF	GRM1555C2A1R6BA01#
			1.6pF	±0.25pF	GRM1555C2A1R6CA01#
				±0.05pF	GRM1555C2A1R7WA01#
				±0.1pF	GRM1555C2A1R7BA01#
			1.7pF	±0.25pF	GRM1555C2A1R7CA01#
				±0.05pF	GRM1555C2A1R8WA01#
				±0.1pF	GRM1555C2A1R8BA01#
			1.8pF	±0.25pF	GRM1555C2A1R8CA01#
				±0.05pF	GRM1555C2A1R9WA01#
				±0.1pF	GRM1555C2A1R9BA01#
			1.9pF	±0.25pF	GRM1555C2A1R9CA01#
				±0.05pF	GRM1555C2A2R0WA01#
				±0.1pF	GRM1555C2A2R0BA01#
			2.0pF	±0.25pF	GRM1555C2A2R0CA01#
				±0.05pF	GRM1555C2A2R1WA01#
				±0.1pF	GRM1555C2A2R1BA01#
			2.1pF	±0.25pF	GRM1555C2A2R1CA01#
				±0.05pF	GRM1555C2A2R2WA01#
				±0.1pF	GRM1555C2A2R2BA01#
			2.2pF	±0.25pF	GRM1555C2A2R2CA01#
				±0.05pF	GRM1555C2A2R3WA01#
				±0.1pF	GRM1555C2A2R3BA01#
			2.3pF	±0.25pF	GRM1555C2A2R3CA01#
				±0.05pF	GRM1555C2A2R4WA01#
				±0.1pF	GRM1555C2A2R4BA01#
			2.4pF	±0.25pF	GRM1555C2A2R4CA01#
				±0.05pF	GRM1555C2A2R5WA01#
				±0.1pF	GRM1555C2A2R5BA01#
			2.5pF	±0.25pF	GRM1555C2A2R5CA01#
				±0.05pF	GRM1555C2A2R6WA01#
				±0.1pF	GRM1555C2A2R6BA01#
			2.6pF	±0.25pF	GRM1555C2A2R6CA01#
				±0.05pF	GRM1555C2A2R7WA01#
				±0.1pF	GRM1555C2A2R7BA01#
			2.7pF	±0.25pF	GRM1555C2A2R7CA01#
				±0.05pF	GRM1555C2A2R8WA01#
				±0.1pF	GRM1555C2A2R8BA01#
			2.8pF	±0.25pF	GRM1555C2A2R8CA01#

Part number # indicates the package specification code.

GRM
 GR3
 GRJ
 GR4
 GR7
 GJM
 GQM
 GA2
 GA3 GB
 GA3 GD
 GA3 GF
 LLL
 LLA
 LLM
 LLR
 NFM
 KRM
 KR3
 GMA
 GMD
 ⚠Caution /Notice

GRM Series Temperature Compensating Type Part Number List

(→ 1.0×0.5mm)

T max.	Rated Voltage	TC Code	Cap.	Tol.	Part Number
0.55mm	100Vdc	COG	2.8pF	±0.25pF	GRM1555C2A2R8CA01#
				±0.05pF	GRM1555C2A2R9WA01#
					±0.1pF
			±0.25pF		GRM1555C2A2R9CA01#
			3.0pF	±0.05pF	GRM1555C2A3R0WA01#
				±0.1pF	GRM1555C2A3R0BA01#
				±0.25pF	GRM1555C2A3R0CA01#
			3.1pF	±0.05pF	GRM1555C2A3R1WA01#
				±0.1pF	GRM1555C2A3R1BA01#
				±0.25pF	GRM1555C2A3R1CA01#
			3.2pF	±0.05pF	GRM1555C2A3R2WA01#
				±0.1pF	GRM1555C2A3R2BA01#
				±0.25pF	GRM1555C2A3R2CA01#
			3.3pF	±0.05pF	GRM1555C2A3R3WA01#
				±0.1pF	GRM1555C2A3R3BA01#
				±0.25pF	GRM1555C2A3R3CA01#
			3.4pF	±0.05pF	GRM1555C2A3R4WA01#
				±0.1pF	GRM1555C2A3R4BA01#
				±0.25pF	GRM1555C2A3R4CA01#
			3.5pF	±0.05pF	GRM1555C2A3R5WA01#
				±0.1pF	GRM1555C2A3R5BA01#
				±0.25pF	GRM1555C2A3R5CA01#
			3.6pF	±0.05pF	GRM1555C2A3R6WA01#
				±0.1pF	GRM1555C2A3R6BA01#
				±0.25pF	GRM1555C2A3R6CA01#
			3.7pF	±0.05pF	GRM1555C2A3R7WA01#
				±0.1pF	GRM1555C2A3R7BA01#
				±0.25pF	GRM1555C2A3R7CA01#
			3.8pF	±0.05pF	GRM1555C2A3R8WA01#
				±0.1pF	GRM1555C2A3R8BA01#
				±0.25pF	GRM1555C2A3R8CA01#
			3.9pF	±0.05pF	GRM1555C2A3R9WA01#
				±0.1pF	GRM1555C2A3R9BA01#
				±0.25pF	GRM1555C2A3R9CA01#
			4.0pF	±0.05pF	GRM1555C2A4R0WA01#
				±0.1pF	GRM1555C2A4R0BA01#
				±0.25pF	GRM1555C2A4R0CA01#
			4.1pF	±0.05pF	GRM1555C2A4R1WA01#
				±0.1pF	GRM1555C2A4R1BA01#
				±0.25pF	GRM1555C2A4R1CA01#
			4.2pF	±0.05pF	GRM1555C2A4R2WA01#
				±0.1pF	GRM1555C2A4R2BA01#
				±0.25pF	GRM1555C2A4R2CA01#
			4.3pF	±0.05pF	GRM1555C2A4R3WA01#
				±0.1pF	GRM1555C2A4R3BA01#
				±0.25pF	GRM1555C2A4R3CA01#
			4.4pF	±0.05pF	GRM1555C2A4R4WA01#
				±0.1pF	GRM1555C2A4R4BA01#
				±0.25pF	GRM1555C2A4R4CA01#
			4.5pF	±0.05pF	GRM1555C2A4R5WA01#
				±0.1pF	GRM1555C2A4R5BA01#
				±0.25pF	GRM1555C2A4R5CA01#
			4.6pF	±0.05pF	GRM1555C2A4R6WA01#
				±0.1pF	GRM1555C2A4R6BA01#

T max.	Rated Voltage	TC Code	Cap.	Tol.	Part Number
0.55mm	100Vdc	COG	4.6pF	±0.25pF	GRM1555C2A4R6CA01#
				±0.05pF	GRM1555C2A4R7WA01#
					±0.1pF
			±0.25pF		GRM1555C2A4R7CA01#
			4.8pF	±0.05pF	GRM1555C2A4R8WA01#
				±0.1pF	GRM1555C2A4R8BA01#
				±0.25pF	GRM1555C2A4R8CA01#
			4.9pF	±0.05pF	GRM1555C2A4R9WA01#
				±0.1pF	GRM1555C2A4R9BA01#
				±0.25pF	GRM1555C2A4R9CA01#
			5.0pF	±0.05pF	GRM1555C2A5R0WA01#
				±0.1pF	GRM1555C2A5R0BA01#
				±0.25pF	GRM1555C2A5R0CA01#
			5.1pF	±0.05pF	GRM1555C2A5R1WA01#
				±0.1pF	GRM1555C2A5R1BA01#
				±0.25pF	GRM1555C2A5R1CA01#
			5.2pF	±0.05pF	GRM1555C2A5R2WA01#
				±0.1pF	GRM1555C2A5R2BA01#
				±0.25pF	GRM1555C2A5R2CA01#
			5.3pF	±0.05pF	GRM1555C2A5R3WA01#
				±0.1pF	GRM1555C2A5R3BA01#
				±0.25pF	GRM1555C2A5R3CA01#
			5.4pF	±0.05pF	GRM1555C2A5R4WA01#
				±0.1pF	GRM1555C2A5R4BA01#
				±0.25pF	GRM1555C2A5R4CA01#
			5.5pF	±0.05pF	GRM1555C2A5R5WA01#
				±0.1pF	GRM1555C2A5R5BA01#
				±0.25pF	GRM1555C2A5R5CA01#
			5.6pF	±0.05pF	GRM1555C2A5R6WA01#
				±0.1pF	GRM1555C2A5R6BA01#
				±0.25pF	GRM1555C2A5R6CA01#
			5.7pF	±0.05pF	GRM1555C2A5R7WA01#
				±0.1pF	GRM1555C2A5R7BA01#
				±0.25pF	GRM1555C2A5R7CA01#
			5.8pF	±0.05pF	GRM1555C2A5R8WA01#
				±0.1pF	GRM1555C2A5R8BA01#
				±0.25pF	GRM1555C2A5R8CA01#
			5.9pF	±0.05pF	GRM1555C2A5R9WA01#
				±0.1pF	GRM1555C2A5R9BA01#
				±0.25pF	GRM1555C2A5R9CA01#
			6.0pF	±0.05pF	GRM1555C2A6R0WA01#
				±0.1pF	GRM1555C2A6R0BA01#
				±0.25pF	GRM1555C2A6R0CA01#
			6.1pF	±0.05pF	GRM1555C2A6R1WA01#

GRM
 GR3
 GRJ
 GR4
 GR7
 GJM
 GQM
 GA2
 GA3 GB
 GA3 GD
 GA3 GF
 LLL
 LLA
 LLM
 LLR
 NFM
 KRM
 KR3
 GMA
 GMD
 ⚠Caution / Notice

Part number # indicates the package specification code.

GRM Series Temperature Compensating Type Part Number List

(→ 1.0×0.5mm)

T max.	Rated Voltage	TC Code	Cap.	Tol.	Part Number
0.55mm	100Vdc	COG	6.1pF	±0.1pF	GRM1555C2A6R1BA01#
				±0.25pF	GRM1555C2A6R1CA01#
				±0.5pF	GRM1555C2A6R1DA01#
			6.2pF	±0.05pF	GRM1555C2A6R2WA01#
				±0.1pF	GRM1555C2A6R2BA01#
				±0.25pF	GRM1555C2A6R2CA01#
			6.3pF	±0.05pF	GRM1555C2A6R3WA01#
				±0.1pF	GRM1555C2A6R3BA01#
				±0.25pF	GRM1555C2A6R3CA01#
			6.4pF	±0.05pF	GRM1555C2A6R4WA01#
				±0.1pF	GRM1555C2A6R4BA01#
				±0.25pF	GRM1555C2A6R4CA01#
			6.5pF	±0.05pF	GRM1555C2A6R5WA01#
				±0.1pF	GRM1555C2A6R5BA01#
				±0.25pF	GRM1555C2A6R5CA01#
			6.6pF	±0.05pF	GRM1555C2A6R6WA01#
				±0.1pF	GRM1555C2A6R6BA01#
				±0.25pF	GRM1555C2A6R6CA01#
			6.7pF	±0.05pF	GRM1555C2A6R7WA01#
				±0.1pF	GRM1555C2A6R7BA01#
				±0.25pF	GRM1555C2A6R7CA01#
			6.8pF	±0.05pF	GRM1555C2A6R8WA01#
				±0.1pF	GRM1555C2A6R8BA01#
				±0.25pF	GRM1555C2A6R8CA01#
			6.9pF	±0.05pF	GRM1555C2A6R9WA01#
				±0.1pF	GRM1555C2A6R9BA01#
				±0.25pF	GRM1555C2A6R9CA01#
			7.0pF	±0.05pF	GRM1555C2A7R0WA01#
				±0.1pF	GRM1555C2A7R0BA01#
				±0.25pF	GRM1555C2A7R0CA01#
			7.1pF	±0.05pF	GRM1555C2A7R1WA01#
				±0.1pF	GRM1555C2A7R1BA01#
				±0.25pF	GRM1555C2A7R1CA01#
			7.2pF	±0.05pF	GRM1555C2A7R2WA01#
				±0.1pF	GRM1555C2A7R2BA01#
				±0.25pF	GRM1555C2A7R2CA01#
			7.3pF	±0.05pF	GRM1555C2A7R3WA01#
				±0.1pF	GRM1555C2A7R3BA01#
				±0.25pF	GRM1555C2A7R3CA01#
			7.4pF	±0.05pF	GRM1555C2A7R4WA01#
				±0.1pF	GRM1555C2A7R4BA01#
				±0.25pF	GRM1555C2A7R4CA01#

T max.	Rated Voltage	TC Code	Cap.	Tol.	Part Number
0.55mm	100Vdc	COG	7.4pF	±0.5pF	GRM1555C2A7R4DA01#
				±0.05pF	GRM1555C2A7R5WA01#
				±0.1pF	GRM1555C2A7R5BA01#
			7.5pF	±0.05pF	GRM1555C2A7R5CA01#
				±0.25pF	GRM1555C2A7R5DA01#
				±0.5pF	GRM1555C2A7R6WA01#
			7.6pF	±0.05pF	GRM1555C2A7R6BA01#
				±0.1pF	GRM1555C2A7R6CA01#
				±0.25pF	GRM1555C2A7R6DA01#
			7.7pF	±0.05pF	GRM1555C2A7R7WA01#
				±0.1pF	GRM1555C2A7R7BA01#
				±0.25pF	GRM1555C2A7R7CA01#
			7.8pF	±0.05pF	GRM1555C2A7R8WA01#
				±0.1pF	GRM1555C2A7R8BA01#
				±0.25pF	GRM1555C2A7R8CA01#
			7.9pF	±0.05pF	GRM1555C2A7R9WA01#
				±0.1pF	GRM1555C2A7R9BA01#
				±0.25pF	GRM1555C2A7R9CA01#
			8.0pF	±0.05pF	GRM1555C2A8R0WA01#
				±0.1pF	GRM1555C2A8R0BA01#
				±0.25pF	GRM1555C2A8R0CA01#
			8.1pF	±0.05pF	GRM1555C2A8R1WA01#
				±0.1pF	GRM1555C2A8R1BA01#
				±0.25pF	GRM1555C2A8R1CA01#
			8.2pF	±0.05pF	GRM1555C2A8R2WA01#
				±0.1pF	GRM1555C2A8R2BA01#
				±0.25pF	GRM1555C2A8R2CA01#
			8.3pF	±0.05pF	GRM1555C2A8R3WA01#
				±0.1pF	GRM1555C2A8R3BA01#
				±0.25pF	GRM1555C2A8R3CA01#
			8.4pF	±0.05pF	GRM1555C2A8R4WA01#
				±0.1pF	GRM1555C2A8R4BA01#
				±0.25pF	GRM1555C2A8R4CA01#
			8.5pF	±0.05pF	GRM1555C2A8R5WA01#
				±0.1pF	GRM1555C2A8R5BA01#
				±0.25pF	GRM1555C2A8R5CA01#
			8.6pF	±0.05pF	GRM1555C2A8R6WA01#
				±0.1pF	GRM1555C2A8R6BA01#
				±0.25pF	GRM1555C2A8R6CA01#
			8.7pF	±0.05pF	GRM1555C2A8R7WA01#
				±0.1pF	GRM1555C2A8R7BA01#
				±0.25pF	GRM1555C2A8R7CA01#
			8.8pF	±0.05pF	GRM1555C2A8R8WA01#
				±0.1pF	GRM1555C2A8R8BA01#
				±0.25pF	GRM1555C2A8R8CA01#

Part number # indicates the package specification code.

GRM
 GR3
 GRJ
 GR4
 GR7
 GJM
 GQM
 GA2
 GA3 GB
 GA3 GD
 GA3 GF
 LLL
 LLA
 LLM
 LLR
 NFM
 KRM
 KR3
 GMA
 GMD
 ⚠Caution /Notice

GRM Series Temperature Compensating Type Part Number List

(→ 1.0×0.5mm)

T max.	Rated Voltage	TC Code	Cap.	Tol.	Part Number	T max.	Rated Voltage	TC Code	Cap.	Tol.	Part Number		
0.55mm	100Vdc	COG	8.8pF	±0.1pF	GRM1555C2A8R8BA01#	0.55mm	100Vdc	COG	18pF	±5%	GRM1555C2A180JA01#		
				±0.25pF	GRM1555C2A8R8CA01#					22pF	±2%	GRM1555C2A220GA01#	
				±0.5pF	GRM1555C2A8R8DA01#						±5%	GRM1555C2A220JA01#	
			8.9pF	±0.05pF	GRM1555C2A8R9WA01#				27pF	±2%	GRM1555C2A270GA01#		
				±0.1pF	GRM1555C2A8R9BA01#					±5%	GRM1555C2A270JA01#		
				±0.25pF	GRM1555C2A8R9CA01#				33pF	±2%	GRM1555C2A330GA01#		
			±0.5pF	GRM1555C2A8R9DA01#	±5%					GRM1555C2A330JA01#			
			9.0pF	±0.05pF	GRM1555C2A9R0WA01#				39pF	±2%	GRM1555C2A390GA01#		
				±0.1pF	GRM1555C2A9R0BA01#					±5%	GRM1555C2A390JA01#		
				±0.25pF	GRM1555C2A9R0CA01#				47pF	±2%	GRM1555C2A470GA01#		
				±0.5pF	GRM1555C2A9R0DA01#					±5%	GRM1555C2A470JA01#		
			9.1pF	±0.05pF	GRM1555C2A9R1WA01#				56pF	±2%	GRM1555C2A560GA01#		
				±0.1pF	GRM1555C2A9R1BA01#					±5%	GRM1555C2A560JA01#		
				±0.25pF	GRM1555C2A9R1CA01#				68pF	±2%	GRM1555C2A680GA01#		
				±0.5pF	GRM1555C2A9R1DA01#					±5%	GRM1555C2A680JA01#		
			9.2pF	±0.05pF	GRM1555C2A9R2WA01#				82pF	±2%	GRM1555C2A820GA01#		
				±0.1pF	GRM1555C2A9R2BA01#					±5%	GRM1555C2A820JA01#		
				±0.25pF	GRM1555C2A9R2CA01#				100pF	±2%	GRM1555C2A101GA01#		
				±0.5pF	GRM1555C2A9R2DA01#					±5%	GRM1555C2A101JA01#		
			9.3pF	±0.05pF	GRM1555C2A9R3WA01#				CK	±0.05pF	GRM1554C2AR10WA01#		
				±0.1pF	GRM1555C2A9R3BA01#					±0.05pF	GRM1554C2AR20WA01#		
				±0.25pF	GRM1555C2A9R3CA01#					±0.1pF	GRM1554C2AR20BA01#		
				±0.5pF	GRM1555C2A9R3DA01#					0.30pF	±0.05pF	GRM1554C2AR30WA01#	
			9.4pF	±0.05pF	GRM1555C2A9R4WA01#						±0.1pF	GRM1554C2AR30BA01#	
				±0.1pF	GRM1555C2A9R4BA01#					0.40pF	±0.05pF	GRM1554C2AR40WA01#	
				±0.25pF	GRM1555C2A9R4CA01#						±0.1pF	GRM1554C2AR40BA01#	
			±0.5pF	GRM1555C2A9R4DA01#	0.50pF					±0.05pF	GRM1554C2AR50WA01#		
			9.5pF	±0.05pF						GRM1555C2A9R5WA01#	±0.1pF	GRM1554C2AR50BA01#	
				±0.1pF	GRM1555C2A9R5BA01#					0.60pF	±0.05pF	GRM1554C2AR60WA01#	
				±0.25pF	GRM1555C2A9R5CA01#						±0.1pF	GRM1554C2AR60BA01#	
			±0.5pF	GRM1555C2A9R5DA01#	0.70pF					±0.05pF	GRM1554C2AR70WA01#		
			9.6pF	±0.05pF						GRM1555C2A9R6WA01#	±0.1pF	GRM1554C2AR70BA01#	
				±0.1pF	GRM1555C2A9R6BA01#					0.80pF	±0.05pF	GRM1554C2AR80WA01#	
				±0.25pF	GRM1555C2A9R6CA01#						±0.1pF	GRM1554C2AR80BA01#	
			±0.5pF	GRM1555C2A9R6DA01#	0.90pF					±0.05pF	GRM1554C2AR90WA01#		
			9.7pF	±0.05pF						GRM1555C2A9R7WA01#	±0.1pF	GRM1554C2AR90BA01#	
				±0.1pF	GRM1555C2A9R7BA01#					1.0pF	±0.05pF	GRM1554C2A1R0WA01#	
				±0.25pF	GRM1555C2A9R7CA01#						±0.1pF	GRM1554C2A1R0BA01#	
			±0.5pF	GRM1555C2A9R7DA01#	±0.25pF					GRM1554C2A1R0CA01#	1.1pF	±0.05pF	GRM1554C2A1R1WA01#
			9.8pF	±0.05pF	GRM1555C2A9R8WA01#					±0.1pF		GRM1554C2A1R1BA01#	
				±0.1pF	GRM1555C2A9R8BA01#					±0.25pF		GRM1554C2A1R1CA01#	
				±0.25pF	GRM1555C2A9R8CA01#					1.2pF	±0.05pF	GRM1554C2A1R2WA01#	
			±0.5pF	GRM1555C2A9R8DA01#	±0.1pF						GRM1554C2A1R2BA01#		
			9.9pF	±0.05pF	GRM1555C2A9R9WA01#					±0.25pF	GRM1554C2A1R2CA01#		
				±0.1pF	GRM1555C2A9R9BA01#					1.3pF	±0.05pF	GRM1554C2A1R3WA01#	
				±0.25pF	GRM1555C2A9R9CA01#						±0.1pF	GRM1554C2A1R3BA01#	
			±0.5pF	GRM1555C2A9R9DA01#	1.4pF					±0.25pF	GRM1554C2A1R3CA01#		
			10pF	±2%						GRM1555C2A100GA01#	±0.05pF	GRM1554C2A1R4WA01#	
				±5%	GRM1555C2A100JA01#					±0.1pF	GRM1554C2A1R4BA01#		
			12pF	±2%	GRM1555C2A120GA01#					±0.25pF	GRM1554C2A1R4CA01#		
				±5%	GRM1555C2A120JA01#					1.5pF	±0.05pF	GRM1554C2A1R5WA01#	
			15pF	±2%	GRM1555C2A150GA01#						±0.1pF	GRM1554C2A1R5BA01#	
				±5%	GRM1555C2A150JA01#					±0.25pF	GRM1554C2A1R5CA01#		
			18pF	±2%	GRM1555C2A180GA01#								

- GRM
- GR3
- GRJ
- GR4
- GR7
- GJM
- GQM
- GA2
- GA3 GB
- GA3 GD
- GA3 GF
- LLL
- LLA
- LLM
- LLR
- NFM
- KRM
- KR3
- GMA
- GMD
- ⚠Caution /Notice

Part number # indicates the package specification code.

GRM Series Temperature Compensating Type Part Number List

(→ 1.0×0.5mm)

T max.	Rated Voltage	TC Code	Cap.	Tol.	Part Number	T max.	Rated Voltage	TC Code	Cap.	Tol.	Part Number			
0.55mm	100Vdc	CK	1.6pF	±0.05pF	GRM1554C2A1R6WA01#	0.55mm	100Vdc	CJ	3.4pF	±0.05pF	GRM1553C2A3R4WA01#			
				±0.1pF	GRM1554C2A1R6BA01#					±0.1pF	GRM1553C2A3R4BA01#			
				±0.25pF	GRM1554C2A1R6CA01#					±0.25pF	GRM1553C2A3R4CA01#			
			1.7pF	±0.05pF	GRM1554C2A1R7WA01#					3.5pF	±0.05pF	GRM1553C2A3R5WA01#		
				±0.1pF	GRM1554C2A1R7BA01#						±0.1pF	GRM1553C2A3R5BA01#		
				±0.25pF	GRM1554C2A1R7CA01#						±0.25pF	GRM1553C2A3R5CA01#		
			1.8pF	±0.05pF	GRM1554C2A1R8WA01#					3.6pF	±0.05pF	GRM1553C2A3R6WA01#		
				±0.1pF	GRM1554C2A1R8BA01#						±0.1pF	GRM1553C2A3R6BA01#		
				±0.25pF	GRM1554C2A1R8CA01#						±0.25pF	GRM1553C2A3R6CA01#		
			1.9pF	±0.05pF	GRM1554C2A1R9WA01#				3.7pF	±0.05pF	GRM1553C2A3R7WA01#			
				±0.1pF	GRM1554C2A1R9BA01#					±0.1pF	GRM1553C2A3R7BA01#			
				±0.25pF	GRM1554C2A1R9CA01#					±0.25pF	GRM1553C2A3R7CA01#			
			2.0pF	±0.05pF	GRM1554C2A2R0WA01#				3.8pF	±0.05pF	GRM1553C2A3R8WA01#			
				±0.1pF	GRM1554C2A2R0BA01#					±0.1pF	GRM1553C2A3R8BA01#			
				±0.25pF	GRM1554C2A2R0CA01#					±0.25pF	GRM1553C2A3R8CA01#			
			CJ	2.1pF	±0.05pF				GRM1553C2A2R1WA01#	CH	4.0pF	±0.05pF	GRM1552C2A4R0WA01#	
					±0.1pF				GRM1553C2A2R1BA01#			±0.1pF	GRM1552C2A4R0BA01#	
					±0.25pF				GRM1553C2A2R1CA01#			±0.25pF	GRM1552C2A4R0CA01#	
				2.2pF	±0.05pF				GRM1553C2A2R2WA01#			4.1pF	±0.05pF	GRM1552C2A4R1WA01#
					±0.1pF				GRM1553C2A2R2BA01#				±0.1pF	GRM1552C2A4R1BA01#
					±0.25pF				GRM1553C2A2R2CA01#				±0.25pF	GRM1552C2A4R1CA01#
				2.3pF	±0.05pF				GRM1553C2A2R3WA01#			4.2pF	±0.05pF	GRM1552C2A4R2WA01#
					±0.1pF				GRM1553C2A2R3BA01#				±0.1pF	GRM1552C2A4R2BA01#
					±0.25pF				GRM1553C2A2R3CA01#				±0.25pF	GRM1552C2A4R2CA01#
				2.4pF	±0.05pF				GRM1553C2A2R4WA01#		4.3pF	±0.05pF	GRM1552C2A4R3WA01#	
					±0.1pF				GRM1553C2A2R4BA01#			±0.1pF	GRM1552C2A4R3BA01#	
					±0.25pF				GRM1553C2A2R4CA01#			±0.25pF	GRM1552C2A4R3CA01#	
				2.5pF	±0.05pF				GRM1553C2A2R5WA01#		4.4pF	±0.05pF	GRM1552C2A4R4WA01#	
					±0.1pF				GRM1553C2A2R5BA01#			±0.1pF	GRM1552C2A4R4BA01#	
					±0.25pF				GRM1553C2A2R5CA01#			±0.25pF	GRM1552C2A4R4CA01#	
				2.6pF	±0.05pF				GRM1553C2A2R6WA01#		4.5pF	±0.05pF	GRM1552C2A4R5WA01#	
					±0.1pF				GRM1553C2A2R6BA01#			±0.1pF	GRM1552C2A4R5BA01#	
					±0.25pF				GRM1553C2A2R6CA01#			±0.25pF	GRM1552C2A4R5CA01#	
				2.7pF	±0.05pF				GRM1553C2A2R7WA01#		4.6pF	±0.05pF	GRM1552C2A4R6WA01#	
					±0.1pF				GRM1553C2A2R7BA01#			±0.1pF	GRM1552C2A4R6BA01#	
					±0.25pF				GRM1553C2A2R7CA01#			±0.25pF	GRM1552C2A4R6CA01#	
		2.8pF		±0.05pF	GRM1553C2A2R8WA01#	4.7pF	±0.05pF	GRM1552C2A4R7WA01#						
				±0.1pF	GRM1553C2A2R8BA01#		±0.1pF	GRM1552C2A4R7BA01#						
				±0.25pF	GRM1553C2A2R8CA01#		±0.25pF	GRM1552C2A4R7CA01#						
		2.9pF		±0.05pF	GRM1553C2A2R9WA01#	4.8pF	±0.05pF	GRM1552C2A4R8WA01#						
				±0.1pF	GRM1553C2A2R9BA01#		±0.1pF	GRM1552C2A4R8BA01#						
				±0.25pF	GRM1553C2A2R9CA01#		±0.25pF	GRM1552C2A4R8CA01#						
		3.0pF		±0.05pF	GRM1553C2A3R0WA01#	5.0pF	±0.05pF	GRM1552C2A5R0WA01#						
				±0.1pF	GRM1553C2A3R0BA01#		±0.1pF	GRM1552C2A5R0BA01#						
				±0.25pF	GRM1553C2A3R0CA01#		±0.25pF	GRM1552C2A5R0CA01#						
		3.1pF		±0.05pF	GRM1553C2A3R1WA01#		5.1pF	±0.05pF	GRM1552C2A5R1WA01#					
				±0.1pF	GRM1553C2A3R1BA01#			±0.1pF	GRM1552C2A5R1BA01#					
				±0.25pF	GRM1553C2A3R1CA01#			±0.25pF	GRM1552C2A5R1CA01#					
		3.2pF		±0.05pF	GRM1553C2A3R2WA01#									
				±0.1pF	GRM1553C2A3R2BA01#									
				±0.25pF	GRM1553C2A3R2CA01#									
		3.3pF	±0.05pF	GRM1553C2A3R3WA01#										
			±0.1pF	GRM1553C2A3R3BA01#										
			±0.25pF	GRM1553C2A3R3CA01#										

Part number # indicates the package specification code.



GRM Series Temperature Compensating Type Part Number List

(→ 1.0×0.5mm)

T max.	Rated Voltage	TC Code	Cap.	Tol.	Part Number	T max.	Rated Voltage	TC Code	Cap.	Tol.	Part Number	
0.55mm	100Vdc	CH	5.1pF	±0.5pF	GRM1552C2A5R1DA01#	0.55mm	100Vdc	CH	6.5pF	±0.1pF	GRM1552C2A6R5BA01#	
				±0.05pF	GRM1552C2A5R2WA01#					±0.25pF	GRM1552C2A6R5CA01#	
				±0.1pF	GRM1552C2A5R2BA01#					±0.5pF	GRM1552C2A6R5DA01#	
			5.2pF	±0.25pF	GRM1552C2A5R2CA01#				6.6pF	±0.05pF	GRM1552C2A6R6WA01#	
				±0.5pF	GRM1552C2A5R2DA01#					±0.1pF	GRM1552C2A6R6BA01#	
				5.3pF	±0.05pF					GRM1552C2A5R3WA01#	±0.25pF	GRM1552C2A6R6CA01#
					±0.1pF					GRM1552C2A5R3BA01#	±0.5pF	GRM1552C2A6R6DA01#
			±0.25pF		GRM1552C2A5R3CA01#				6.7pF	±0.05pF	GRM1552C2A6R7WA01#	
			±0.5pF	GRM1552C2A5R3DA01#	±0.1pF					GRM1552C2A6R7BA01#		
			5.4pF	±0.05pF	GRM1552C2A5R4WA01#					±0.25pF	GRM1552C2A6R7CA01#	
				±0.1pF	GRM1552C2A5R4BA01#				±0.5pF	GRM1552C2A6R7DA01#		
				±0.25pF	GRM1552C2A5R4CA01#				6.8pF	±0.05pF	GRM1552C2A6R8WA01#	
			±0.5pF	GRM1552C2A5R4DA01#	±0.1pF					GRM1552C2A6R8BA01#		
			5.5pF	±0.05pF	GRM1552C2A5R5WA01#					±0.25pF	GRM1552C2A6R8CA01#	
				±0.1pF	GRM1552C2A5R5BA01#				±0.5pF	GRM1552C2A6R8DA01#		
				±0.25pF	GRM1552C2A5R5CA01#				6.9pF	±0.05pF	GRM1552C2A6R9WA01#	
			±0.5pF	GRM1552C2A5R5DA01#	±0.1pF					GRM1552C2A6R9BA01#		
			5.6pF	±0.05pF	GRM1552C2A5R6WA01#					±0.25pF	GRM1552C2A6R9CA01#	
				±0.1pF	GRM1552C2A5R6BA01#				±0.5pF	GRM1552C2A6R9DA01#		
				±0.25pF	GRM1552C2A5R6CA01#				7.0pF	±0.05pF	GRM1552C2A7R0WA01#	
			±0.5pF	GRM1552C2A5R6DA01#	±0.1pF					GRM1552C2A7R0BA01#		
			5.7pF	±0.05pF	GRM1552C2A5R7WA01#					±0.25pF	GRM1552C2A7R0CA01#	
				±0.1pF	GRM1552C2A5R7BA01#				±0.5pF	GRM1552C2A7R0DA01#		
				±0.25pF	GRM1552C2A5R7CA01#				7.1pF	±0.05pF	GRM1552C2A7R1WA01#	
			±0.5pF	GRM1552C2A5R7DA01#	±0.1pF					GRM1552C2A7R1BA01#		
			5.8pF	±0.05pF	GRM1552C2A5R8WA01#					±0.25pF	GRM1552C2A7R1CA01#	
				±0.1pF	GRM1552C2A5R8BA01#				±0.5pF	GRM1552C2A7R1DA01#		
				±0.25pF	GRM1552C2A5R8CA01#				7.2pF	±0.05pF	GRM1552C2A7R2WA01#	
			±0.5pF	GRM1552C2A5R8DA01#	±0.1pF					GRM1552C2A7R2BA01#		
			5.9pF	±0.05pF	GRM1552C2A5R9WA01#					±0.25pF	GRM1552C2A7R2CA01#	
				±0.1pF	GRM1552C2A5R9BA01#				±0.5pF	GRM1552C2A7R2DA01#		
				±0.25pF	GRM1552C2A5R9CA01#				7.3pF	±0.05pF	GRM1552C2A7R3WA01#	
			±0.5pF	GRM1552C2A5R9DA01#	±0.1pF					GRM1552C2A7R3BA01#		
			6.0pF	±0.05pF	GRM1552C2A6R0WA01#					±0.25pF	GRM1552C2A7R3CA01#	
				±0.1pF	GRM1552C2A6R0BA01#				±0.5pF	GRM1552C2A7R3DA01#		
				±0.25pF	GRM1552C2A6R0CA01#				7.4pF	±0.05pF	GRM1552C2A7R4WA01#	
			±0.5pF	GRM1552C2A6R0DA01#	±0.1pF					GRM1552C2A7R4BA01#		
			6.1pF	±0.05pF	GRM1552C2A6R1WA01#					±0.25pF	GRM1552C2A7R4CA01#	
				±0.1pF	GRM1552C2A6R1BA01#				±0.5pF	GRM1552C2A7R4DA01#		
				±0.25pF	GRM1552C2A6R1CA01#				7.5pF	±0.05pF	GRM1552C2A7R5WA01#	
			±0.5pF	GRM1552C2A6R1DA01#	±0.1pF					GRM1552C2A7R5BA01#		
			6.2pF	±0.05pF	GRM1552C2A6R2WA01#					±0.25pF	GRM1552C2A7R5CA01#	
				±0.1pF	GRM1552C2A6R2BA01#				±0.5pF	GRM1552C2A7R5DA01#		
				±0.25pF	GRM1552C2A6R2CA01#				7.6pF	±0.05pF	GRM1552C2A7R6WA01#	
			±0.5pF	GRM1552C2A6R2DA01#	±0.1pF					GRM1552C2A7R6BA01#		
			6.3pF	±0.05pF	GRM1552C2A6R3WA01#					±0.25pF	GRM1552C2A7R6CA01#	
				±0.1pF	GRM1552C2A6R3BA01#				±0.5pF	GRM1552C2A7R6DA01#		
				±0.25pF	GRM1552C2A6R3CA01#				7.7pF	±0.05pF	GRM1552C2A7R7WA01#	
			±0.5pF	GRM1552C2A6R3DA01#	±0.1pF					GRM1552C2A7R7BA01#		
			6.4pF	±0.05pF	GRM1552C2A6R4WA01#					±0.25pF	GRM1552C2A7R7CA01#	
				±0.1pF	GRM1552C2A6R4BA01#				±0.5pF	GRM1552C2A7R7DA01#		
				±0.25pF	GRM1552C2A6R4CA01#				7.8pF	±0.05pF	GRM1552C2A7R8WA01#	
			±0.5pF	GRM1552C2A6R4DA01#	±0.1pF					GRM1552C2A7R8BA01#		
			6.5pF	±0.05pF	GRM1552C2A6R5WA01#					±0.25pF	GRM1552C2A7R8CA01#	

- GRM
- GR3
- GRJ
- GR4
- GR7
- GJM
- GQM
- GA2
- GA3 GB
- GA3 GD
- GA3 GF
- LLL
- LLA
- LLM
- LLR
- NFM
- KRM
- KR3
- GMA
- GMD
- ⚠Caution /Notice

Part number # indicates the package specification code.

GRM Series Temperature Compensating Type Part Number List

(→ 1.0×0.5mm)

T max.	Rated Voltage	TC Code	Cap.	Tol.	Part Number	
0.55mm	100Vdc	CH	7.8pF	±0.5pF	GRM1552C2A7R8DA01#	
				7.9pF	±0.05pF	GRM1552C2A7R9WA01#
					±0.1pF	GRM1552C2A7R9BA01#
					±0.25pF	GRM1552C2A7R9CA01#
			8.0pF	±0.5pF	GRM1552C2A7R9DA01#	
				±0.05pF	GRM1552C2A8R0WA01#	
				±0.1pF	GRM1552C2A8R0BA01#	
				±0.25pF	GRM1552C2A8R0CA01#	
			8.1pF	±0.5pF	GRM1552C2A8R0DA01#	
				±0.05pF	GRM1552C2A8R1WA01#	
				±0.1pF	GRM1552C2A8R1BA01#	
				±0.25pF	GRM1552C2A8R1CA01#	
			8.2pF	±0.5pF	GRM1552C2A8R1DA01#	
				±0.05pF	GRM1552C2A8R2WA01#	
				±0.1pF	GRM1552C2A8R2BA01#	
				±0.25pF	GRM1552C2A8R2CA01#	
			8.3pF	±0.5pF	GRM1552C2A8R2DA01#	
				±0.05pF	GRM1552C2A8R3WA01#	
				±0.1pF	GRM1552C2A8R3BA01#	
				±0.25pF	GRM1552C2A8R3CA01#	
			8.4pF	±0.5pF	GRM1552C2A8R3DA01#	
				±0.05pF	GRM1552C2A8R4WA01#	
				±0.1pF	GRM1552C2A8R4BA01#	
				±0.25pF	GRM1552C2A8R4CA01#	
			8.5pF	±0.5pF	GRM1552C2A8R4DA01#	
				±0.05pF	GRM1552C2A8R5WA01#	
				±0.1pF	GRM1552C2A8R5BA01#	
				±0.25pF	GRM1552C2A8R5CA01#	
			8.6pF	±0.5pF	GRM1552C2A8R5DA01#	
				±0.05pF	GRM1552C2A8R6WA01#	
				±0.1pF	GRM1552C2A8R6BA01#	
				±0.25pF	GRM1552C2A8R6CA01#	
			8.7pF	±0.5pF	GRM1552C2A8R6DA01#	
				±0.05pF	GRM1552C2A8R7WA01#	
				±0.1pF	GRM1552C2A8R7BA01#	
				±0.25pF	GRM1552C2A8R7CA01#	
			8.8pF	±0.5pF	GRM1552C2A8R7DA01#	
				±0.05pF	GRM1552C2A8R8WA01#	
				±0.1pF	GRM1552C2A8R8BA01#	
				±0.25pF	GRM1552C2A8R8CA01#	
			8.9pF	±0.5pF	GRM1552C2A8R8DA01#	
				±0.05pF	GRM1552C2A8R9WA01#	
				±0.1pF	GRM1552C2A8R9BA01#	
				±0.25pF	GRM1552C2A8R9CA01#	
			9.0pF	±0.5pF	GRM1552C2A8R9DA01#	
				±0.05pF	GRM1552C2A9R0WA01#	
				±0.1pF	GRM1552C2A9R0BA01#	
				±0.25pF	GRM1552C2A9R0CA01#	
			9.1pF	±0.5pF	GRM1552C2A9R0DA01#	
				±0.05pF	GRM1552C2A9R1WA01#	
				±0.1pF	GRM1552C2A9R1BA01#	
				±0.25pF	GRM1552C2A9R1CA01#	
			9.2pF	±0.5pF	GRM1552C2A9R1DA01#	
				±0.05pF	GRM1552C2A9R2WA01#	

T max.	Rated Voltage	TC Code	Cap.	Tol.	Part Number
0.55mm	100Vdc	CH	9.2pF	±0.1pF	GRM1552C2A9R2BA01#
				±0.25pF	GRM1552C2A9R2CA01#
				±0.5pF	GRM1552C2A9R2DA01#
			9.3pF	±0.05pF	GRM1552C2A9R3WA01#
				±0.1pF	GRM1552C2A9R3BA01#
				±0.25pF	GRM1552C2A9R3CA01#
			9.4pF	±0.5pF	GRM1552C2A9R3DA01#
				±0.05pF	GRM1552C2A9R4WA01#
				±0.1pF	GRM1552C2A9R4BA01#
			9.5pF	±0.25pF	GRM1552C2A9R4CA01#
				±0.5pF	GRM1552C2A9R4DA01#
				±0.05pF	GRM1552C2A9R5WA01#
			9.6pF	±0.1pF	GRM1552C2A9R5BA01#
				±0.25pF	GRM1552C2A9R5CA01#
				±0.5pF	GRM1552C2A9R5DA01#
			9.7pF	±0.05pF	GRM1552C2A9R6WA01#
				±0.1pF	GRM1552C2A9R6BA01#
				±0.25pF	GRM1552C2A9R6CA01#
			9.8pF	±0.5pF	GRM1552C2A9R6DA01#
				±0.05pF	GRM1552C2A9R7WA01#
				±0.1pF	GRM1552C2A9R7BA01#
			9.9pF	±0.25pF	GRM1552C2A9R7CA01#
				±0.5pF	GRM1552C2A9R7DA01#
				±0.05pF	GRM1552C2A9R8WA01#
			10pF	±0.1pF	GRM1552C2A9R8BA01#
				±0.25pF	GRM1552C2A9R8CA01#
				±0.5pF	GRM1552C2A9R8DA01#
			12pF	±2%	GRM1552C2A100GA01#
				±5%	GRM1552C2A100JA01#
				±2%	GRM1552C2A120GA01#
			15pF	±5%	GRM1552C2A120JA01#
				±2%	GRM1552C2A150GA01#
				±5%	GRM1552C2A150JA01#
			18pF	±2%	GRM1552C2A180GA01#
				±5%	GRM1552C2A180JA01#
				±2%	GRM1552C2A220GA01#
			22pF	±5%	GRM1552C2A220JA01#
				±2%	GRM1552C2A270GA01#
				±5%	GRM1552C2A270JA01#
			27pF	±2%	GRM1552C2A330GA01#
				±5%	GRM1552C2A330JA01#
				±2%	GRM1552C2A390GA01#
			33pF	±5%	GRM1552C2A390JA01#
				±2%	GRM1552C2A470GA01#
				±5%	GRM1552C2A470JA01#
			39pF	±2%	GRM1552C2A560GA01#
				±5%	GRM1552C2A560JA01#
				±2%	GRM1552C2A680GA01#
			47pF	±5%	GRM1552C2A680JA01#
				±2%	GRM1552C2A820GA01#
				±5%	GRM1552C2A820JA01#
			56pF	±2%	GRM1552C2A820GA01#
				±5%	GRM1552C2A820JA01#
				±2%	GRM1552C2A820GA01#
			68pF	±5%	GRM1552C2A820JA01#
				±2%	GRM1552C2A820GA01#
				±5%	GRM1552C2A820JA01#
			82pF	±2%	GRM1552C2A820GA01#

Part number # indicates the package specification code.

- GRM
- GR3
- GRJ
- GR4
- GR7
- GJM
- GQM
- GA2
- GA3 GB
- GA3 GD
- GA3 GF
- LLL
- LLA
- LLM
- LLR
- NFM
- KRM
- KR3
- GMA
- GMD
- ⚠Caution /Notice

GRM Series Temperature Compensating Type Part Number List

(→ 1.0×0.5mm)

T max.	Rated Voltage	TC Code	Cap.	Tol.	Part Number
0.55mm	100Vdc	CH	82pF	±5%	GRM1552C2A820JA01#
			100pF	±2%	GRM1552C2A101GA01#
±5%				GRM1552C2A101JA01#	
50Vdc	COG	0.10pF	±0.05pF	GRM1555C1HR10WA01#	
			±0.1pF	GRM1555C1HR20BA01#	
		0.20pF	±0.05pF	GRM1555C1HR20WA01#	
			±0.1pF	GRM1555C1HR20BA01#	
		0.30pF	±0.05pF	GRM1555C1HR30WA01#	
			±0.1pF	GRM1555C1HR30BA01#	
		0.40pF	±0.05pF	GRM1555C1HR40WA01#	
			±0.1pF	GRM1555C1HR40BA01#	
		0.50pF	±0.05pF	GRM1555C1HR50WA01#	
			±0.1pF	GRM1555C1HR50BA01#	
		0.60pF	±0.05pF	GRM1555C1HR60WA01#	
			±0.1pF	GRM1555C1HR60BA01#	
		0.70pF	±0.05pF	GRM1555C1HR70WA01#	
			±0.1pF	GRM1555C1HR70BA01#	
		0.80pF	±0.05pF	GRM1555C1HR80WA01#	
			±0.1pF	GRM1555C1HR80BA01#	
		0.90pF	±0.05pF	GRM1555C1HR90WA01#	
			±0.1pF	GRM1555C1HR90BA01#	
		1.0pF	±0.05pF	GRM1555C1H1R0WA01#	
			±0.1pF	GRM1555C1H1R0BA01#	
			±0.25pF	GRM1555C1H1R0CA01#	
		1.1pF	±0.05pF	GRM1555C1H1R1WA01#	
			±0.1pF	GRM1555C1H1R1BA01#	
			±0.25pF	GRM1555C1H1R1CA01#	
		1.2pF	±0.05pF	GRM1555C1H1R2WA01#	
			±0.1pF	GRM1555C1H1R2BA01#	
			±0.25pF	GRM1555C1H1R2CA01#	
		1.3pF	±0.05pF	GRM1555C1H1R3WA01#	
			±0.1pF	GRM1555C1H1R3BA01#	
			±0.25pF	GRM1555C1H1R3CA01#	
		1.4pF	±0.05pF	GRM1555C1H1R4WA01#	
			±0.1pF	GRM1555C1H1R4BA01#	
			±0.25pF	GRM1555C1H1R4CA01#	
		1.5pF	±0.05pF	GRM1555C1H1R5WA01#	
			±0.1pF	GRM1555C1H1R5BA01#	
			±0.25pF	GRM1555C1H1R5CA01#	
		1.6pF	±0.05pF	GRM1555C1H1R6WA01#	
			±0.1pF	GRM1555C1H1R6BA01#	
			±0.25pF	GRM1555C1H1R6CA01#	
		1.7pF	±0.05pF	GRM1555C1H1R7WA01#	
			±0.1pF	GRM1555C1H1R7BA01#	
			±0.25pF	GRM1555C1H1R7CA01#	
		1.8pF	±0.05pF	GRM1555C1H1R8WA01#	
			±0.1pF	GRM1555C1H1R8BA01#	
			±0.25pF	GRM1555C1H1R8CA01#	
		1.9pF	±0.05pF	GRM1555C1H1R9WA01#	
			±0.1pF	GRM1555C1H1R9BA01#	
			±0.25pF	GRM1555C1H1R9CA01#	
2.0pF	±0.05pF	GRM1555C1H2R0WA01#			
	±0.1pF	GRM1555C1H2R0BA01#			
	±0.25pF	GRM1555C1H2R0CA01#			
2.1pF	±0.05pF	GRM1555C1H2R1WA01#			

T max.	Rated Voltage	TC Code	Cap.	Tol.	Part Number
0.55mm	50Vdc	COG	2.1pF	±0.1pF	GRM1555C1H2R1BA01#
				±0.25pF	GRM1555C1H2R1CA01#
			2.2pF	±0.05pF	GRM1555C1H2R2WA01#
				±0.1pF	GRM1555C1H2R2BA01#
			2.3pF	±0.05pF	GRM1555C1H2R3WA01#
				±0.25pF	GRM1555C1H2R3CA01#
			2.4pF	±0.05pF	GRM1555C1H2R4WA01#
				±0.1pF	GRM1555C1H2R4BA01#
				±0.25pF	GRM1555C1H2R4CA01#
			2.5pF	±0.05pF	GRM1555C1H2R5WA01#
				±0.1pF	GRM1555C1H2R5BA01#
				±0.25pF	GRM1555C1H2R5CA01#
			2.6pF	±0.05pF	GRM1555C1H2R6WA01#
				±0.1pF	GRM1555C1H2R6BA01#
				±0.25pF	GRM1555C1H2R6CA01#
			2.7pF	±0.05pF	GRM1555C1H2R7WA01#
				±0.1pF	GRM1555C1H2R7BA01#
				±0.25pF	GRM1555C1H2R7CA01#
			2.8pF	±0.05pF	GRM1555C1H2R8WA01#
				±0.1pF	GRM1555C1H2R8BA01#
				±0.25pF	GRM1555C1H2R8CA01#
			2.9pF	±0.05pF	GRM1555C1H2R9WA01#
				±0.1pF	GRM1555C1H2R9BA01#
				±0.25pF	GRM1555C1H2R9CA01#
			3.0pF	±0.05pF	GRM1555C1H3R0WA01#
				±0.1pF	GRM1555C1H3R0BA01#
				±0.25pF	GRM1555C1H3R0CA01#
			3.1pF	±0.05pF	GRM1555C1H3R1WA01#
				±0.1pF	GRM1555C1H3R1BA01#
				±0.25pF	GRM1555C1H3R1CA01#
			3.2pF	±0.05pF	GRM1555C1H3R2WA01#
				±0.1pF	GRM1555C1H3R2BA01#
				±0.25pF	GRM1555C1H3R2CA01#
			3.3pF	±0.05pF	GRM1555C1H3R3WA01#
				±0.1pF	GRM1555C1H3R3BA01#
				±0.25pF	GRM1555C1H3R3CA01#
			3.4pF	±0.05pF	GRM1555C1H3R4WA01#
				±0.1pF	GRM1555C1H3R4BA01#
				±0.25pF	GRM1555C1H3R4CA01#
			3.5pF	±0.05pF	GRM1555C1H3R5WA01#
				±0.1pF	GRM1555C1H3R5BA01#
				±0.25pF	GRM1555C1H3R5CA01#
			3.6pF	±0.05pF	GRM1555C1H3R6WA01#
				±0.1pF	GRM1555C1H3R6BA01#
				±0.25pF	GRM1555C1H3R6CA01#
			3.7pF	±0.05pF	GRM1555C1H3R7WA01#
				±0.1pF	GRM1555C1H3R7BA01#
				±0.25pF	GRM1555C1H3R7CA01#
3.8pF	±0.05pF	GRM1555C1H3R8WA01#			
	±0.1pF	GRM1555C1H3R8BA01#			
	±0.25pF	GRM1555C1H3R8CA01#			
3.9pF	±0.05pF	GRM1555C1H3R9WA01#			

- GRM
- GR3
- GRJ
- GR4
- GR7
- GJM
- GQM
- GA2
- GA3 GB
- GA3 GD
- GA3 GF
- LLL
- LLA
- LLM
- LLR
- NFM
- KRM
- KR3
- GMA
- GMD
- ⚠Caution /Notice

Part number # indicates the package specification code.

GRM Series Temperature Compensating Type Part Number List

(→ 1.0×0.5mm)

T max.	Rated Voltage	TC Code	Cap.	Tol.	Part Number	T max.	Rated Voltage	TC Code	Cap.	Tol.	Part Number
0.55mm	50Vdc	COG	3.9pF	±0.1pF	GRM1555C1H3R9BA01#	0.55mm	50Vdc	COG	5.5pF	±0.5pF	GRM1555C1H5R5DA01#
				±0.25pF	GRM1555C1H3R9CA01#					5.6pF	±0.05pF
			4.0pF	±0.05pF	GRM1555C1H4ROWA01#				±0.1pF		GRM1555C1H5R6BA01#
				±0.1pF	GRM1555C1H4R0BA01#				±0.25pF	GRM1555C1H5R6CA01#	
				±0.25pF	GRM1555C1H4R0CA01#				±0.5pF	GRM1555C1H5R6DA01#	
				4.1pF	±0.05pF				GRM1555C1H4R1WA01#	5.7pF	±0.05pF
			±0.1pF		GRM1555C1H4R1BA01#				±0.1pF		GRM1555C1H5R7BA01#
			±0.25pF		GRM1555C1H4R1CA01#				±0.25pF		GRM1555C1H5R7CA01#
			4.2pF	±0.05pF	GRM1555C1H4R2WA01#				±0.5pF	GRM1555C1H5R7DA01#	
				±0.1pF	GRM1555C1H4R2BA01#				5.8pF	±0.05pF	GRM1555C1H5R8WA01#
				±0.25pF	GRM1555C1H4R2CA01#					±0.1pF	GRM1555C1H5R8BA01#
			4.3pF	±0.05pF	GRM1555C1H4R3WA01#					±0.25pF	GRM1555C1H5R8CA01#
				±0.1pF	GRM1555C1H4R3BA01#				±0.5pF	GRM1555C1H5R8DA01#	
				±0.25pF	GRM1555C1H4R3CA01#				5.9pF	±0.05pF	GRM1555C1H5R9WA01#
			4.4pF	±0.05pF	GRM1555C1H4R4WA01#					±0.1pF	GRM1555C1H5R9BA01#
				±0.1pF	GRM1555C1H4R4BA01#					±0.25pF	GRM1555C1H5R9CA01#
				±0.25pF	GRM1555C1H4R4CA01#				±0.5pF	GRM1555C1H5R9DA01#	
			4.5pF	±0.05pF	GRM1555C1H4R5WA01#				6.0pF	±0.05pF	GRM1555C1H6R0WA01#
				±0.1pF	GRM1555C1H4R5BA01#					±0.1pF	GRM1555C1H6R0BA01#
				±0.25pF	GRM1555C1H4R5CA01#					±0.25pF	GRM1555C1H6R0CA01#
			4.6pF	±0.05pF	GRM1555C1H4R6WA01#				±0.5pF	GRM1555C1H6R0DA01#	
				±0.1pF	GRM1555C1H4R6BA01#				6.1pF	±0.05pF	GRM1555C1H6R1WA01#
				±0.25pF	GRM1555C1H4R6CA01#					±0.1pF	GRM1555C1H6R1BA01#
			4.7pF	±0.05pF	GRM1555C1H4R7WA01#					±0.25pF	GRM1555C1H6R1CA01#
				±0.1pF	GRM1555C1H4R7BA01#				±0.5pF	GRM1555C1H6R1DA01#	
				±0.25pF	GRM1555C1H4R7CA01#				6.2pF	±0.05pF	GRM1555C1H6R2WA01#
			4.8pF	±0.05pF	GRM1555C1H4R8WA01#					±0.1pF	GRM1555C1H6R2BA01#
				±0.1pF	GRM1555C1H4R8BA01#					±0.25pF	GRM1555C1H6R2CA01#
				±0.25pF	GRM1555C1H4R8CA01#				±0.5pF	GRM1555C1H6R2DA01#	
			4.9pF	±0.05pF	GRM1555C1H4R9WA01#				6.3pF	±0.05pF	GRM1555C1H6R3WA01#
				±0.1pF	GRM1555C1H4R9BA01#					±0.1pF	GRM1555C1H6R3BA01#
				±0.25pF	GRM1555C1H4R9CA01#					±0.25pF	GRM1555C1H6R3CA01#
			5.0pF	±0.05pF	GRM1555C1H5R0WA01#				±0.5pF	GRM1555C1H6R3DA01#	
				±0.1pF	GRM1555C1H5R0BA01#				6.4pF	±0.05pF	GRM1555C1H6R4WA01#
				±0.25pF	GRM1555C1H5R0CA01#					±0.1pF	GRM1555C1H6R4BA01#
			5.1pF	±0.05pF	GRM1555C1H5R1WA01#					±0.25pF	GRM1555C1H6R4CA01#
				±0.1pF	GRM1555C1H5R1BA01#				±0.5pF	GRM1555C1H6R4DA01#	
				±0.25pF	GRM1555C1H5R1CA01#				6.5pF	±0.05pF	GRM1555C1H6R5WA01#
			±0.5pF	GRM1555C1H5R1DA01#	±0.1pF					GRM1555C1H6R5BA01#	
			5.2pF	±0.05pF	GRM1555C1H5R2WA01#					±0.25pF	GRM1555C1H6R5CA01#
				±0.1pF	GRM1555C1H5R2BA01#				±0.5pF	GRM1555C1H6R5DA01#	
				±0.25pF	GRM1555C1H5R2CA01#				6.6pF	±0.05pF	GRM1555C1H6R6WA01#
				±0.5pF	GRM1555C1H5R2DA01#					±0.1pF	GRM1555C1H6R6BA01#
			5.3pF	±0.05pF	GRM1555C1H5R3WA01#					±0.25pF	GRM1555C1H6R6CA01#
				±0.1pF	GRM1555C1H5R3BA01#				±0.5pF	GRM1555C1H6R6DA01#	
				±0.25pF	GRM1555C1H5R3CA01#				6.7pF	±0.05pF	GRM1555C1H6R7WA01#
			±0.5pF	GRM1555C1H5R3DA01#	±0.1pF					GRM1555C1H6R7BA01#	
			5.4pF	±0.05pF	GRM1555C1H5R4WA01#					±0.25pF	GRM1555C1H6R7CA01#
				±0.1pF	GRM1555C1H5R4BA01#				±0.5pF	GRM1555C1H6R7DA01#	
				±0.25pF	GRM1555C1H5R4CA01#				6.8pF	±0.05pF	GRM1555C1H6R8WA01#
				±0.5pF	GRM1555C1H5R4DA01#					±0.1pF	GRM1555C1H6R8BA01#
			5.5pF	±0.05pF	GRM1555C1H5R5WA01#					±0.25pF	GRM1555C1H6R8CA01#
				±0.1pF	GRM1555C1H5R5BA01#				±0.5pF	GRM1555C1H6R8DA01#	
				±0.25pF	GRM1555C1H5R5CA01#				6.9pF	±0.05pF	GRM1555C1H6R9WA01#

Part number # indicates the package specification code.



GRM Series Temperature Compensating Type Part Number List

(→ 1.0×0.5mm)

T max.	Rated Voltage	TC Code	Cap.	Tol.	Part Number	T max.	Rated Voltage	TC Code	Cap.	Tol.	Part Number	
0.55mm	50Vdc	COG	6.9pF	±0.1pF	GRM1555C1H6R9BA01#	0.55mm	50Vdc	COG	8.2pF	±0.5pF	GRM1555C1H8R2DA01#	
				±0.25pF	GRM1555C1H6R9CA01#					8.3pF	±0.05pF	GRM1555C1H8R3WA01#
				±0.5pF	GRM1555C1H6R9DA01#						±0.1pF	GRM1555C1H8R3BA01#
			7.0pF	±0.05pF	GRM1555C1H7R0WA01#				±0.25pF		GRM1555C1H8R3CA01#	
				±0.1pF	GRM1555C1H7R0BA01#				±0.5pF	GRM1555C1H8R3DA01#		
				±0.25pF	GRM1555C1H7R0CA01#				8.4pF	±0.05pF	GRM1555C1H8R4WA01#	
			±0.5pF	GRM1555C1H7R0DA01#	±0.1pF					GRM1555C1H8R4BA01#		
			7.1pF	±0.05pF	GRM1555C1H7R1WA01#					±0.25pF	GRM1555C1H8R4CA01#	
				±0.1pF	GRM1555C1H7R1BA01#				±0.5pF	GRM1555C1H8R4DA01#		
				±0.25pF	GRM1555C1H7R1CA01#				8.5pF	±0.05pF	GRM1555C1H8R5WA01#	
			±0.5pF	GRM1555C1H7R1DA01#	±0.1pF					GRM1555C1H8R5BA01#		
			7.2pF	±0.05pF	GRM1555C1H7R2WA01#					±0.25pF	GRM1555C1H8R5CA01#	
				±0.1pF	GRM1555C1H7R2BA01#				±0.5pF	GRM1555C1H8R5DA01#		
				±0.25pF	GRM1555C1H7R2CA01#				8.6pF	±0.05pF	GRM1555C1H8R6WA01#	
			±0.5pF	GRM1555C1H7R2DA01#	±0.1pF					GRM1555C1H8R6BA01#		
			7.3pF	±0.05pF	GRM1555C1H7R3WA01#					±0.25pF	GRM1555C1H8R6CA01#	
				±0.1pF	GRM1555C1H7R3BA01#				±0.5pF	GRM1555C1H8R6DA01#		
				±0.25pF	GRM1555C1H7R3CA01#				8.7pF	±0.05pF	GRM1555C1H8R7WA01#	
			±0.5pF	GRM1555C1H7R3DA01#	±0.1pF					GRM1555C1H8R7BA01#		
			7.4pF	±0.05pF	GRM1555C1H7R4WA01#					±0.25pF	GRM1555C1H8R7CA01#	
				±0.1pF	GRM1555C1H7R4BA01#				±0.5pF	GRM1555C1H8R7DA01#		
				±0.25pF	GRM1555C1H7R4CA01#				8.8pF	±0.05pF	GRM1555C1H8R8WA01#	
			±0.5pF	GRM1555C1H7R4DA01#	±0.1pF					GRM1555C1H8R8BA01#		
			7.5pF	±0.05pF	GRM1555C1H7R5WA01#					±0.25pF	GRM1555C1H8R8CA01#	
				±0.1pF	GRM1555C1H7R5BA01#				±0.5pF	GRM1555C1H8R8DA01#		
				±0.25pF	GRM1555C1H7R5CA01#				8.9pF	±0.05pF	GRM1555C1H8R9WA01#	
			±0.5pF	GRM1555C1H7R5DA01#	±0.1pF					GRM1555C1H8R9BA01#		
			7.6pF	±0.05pF	GRM1555C1H7R6WA01#					±0.25pF	GRM1555C1H8R9CA01#	
				±0.1pF	GRM1555C1H7R6BA01#				±0.5pF	GRM1555C1H8R9DA01#		
				±0.25pF	GRM1555C1H7R6CA01#				9.0pF	±0.05pF	GRM1555C1H9R0WA01#	
			±0.5pF	GRM1555C1H7R6DA01#	±0.1pF					GRM1555C1H9R0BA01#		
			7.7pF	±0.05pF	GRM1555C1H7R7WA01#					±0.25pF	GRM1555C1H9R0CA01#	
				±0.1pF	GRM1555C1H7R7BA01#				±0.5pF	GRM1555C1H9R0DA01#		
				±0.25pF	GRM1555C1H7R7CA01#				9.1pF	±0.05pF	GRM1555C1H9R1WA01#	
			±0.5pF	GRM1555C1H7R7DA01#	±0.1pF					GRM1555C1H9R1BA01#		
			7.8pF	±0.05pF	GRM1555C1H7R8WA01#					±0.25pF	GRM1555C1H9R1CA01#	
				±0.1pF	GRM1555C1H7R8BA01#				±0.5pF	GRM1555C1H9R1DA01#		
				±0.25pF	GRM1555C1H7R8CA01#				9.2pF	±0.05pF	GRM1555C1H9R2WA01#	
			±0.5pF	GRM1555C1H7R8DA01#	±0.1pF					GRM1555C1H9R2BA01#		
			7.9pF	±0.05pF	GRM1555C1H7R9WA01#					±0.25pF	GRM1555C1H9R2CA01#	
				±0.1pF	GRM1555C1H7R9BA01#				±0.5pF	GRM1555C1H9R2DA01#		
				±0.25pF	GRM1555C1H7R9CA01#				9.3pF	±0.05pF	GRM1555C1H9R3WA01#	
			±0.5pF	GRM1555C1H7R9DA01#	±0.1pF					GRM1555C1H9R3BA01#		
			8.0pF	±0.05pF	GRM1555C1H8R0WA01#					±0.25pF	GRM1555C1H9R3CA01#	
				±0.1pF	GRM1555C1H8R0BA01#				±0.5pF	GRM1555C1H9R3DA01#		
				±0.25pF	GRM1555C1H8R0CA01#				9.4pF	±0.05pF	GRM1555C1H9R4WA01#	
			±0.5pF	GRM1555C1H8R0DA01#	±0.1pF					GRM1555C1H9R4BA01#		
			8.1pF	±0.05pF	GRM1555C1H8R1WA01#					±0.25pF	GRM1555C1H9R4CA01#	
				±0.1pF	GRM1555C1H8R1BA01#				±0.5pF	GRM1555C1H9R4DA01#		
				±0.25pF	GRM1555C1H8R1CA01#				9.5pF	±0.05pF	GRM1555C1H9R5WA01#	
			±0.5pF	GRM1555C1H8R1DA01#	±0.1pF					GRM1555C1H9R5BA01#		
			8.2pF	±0.05pF	GRM1555C1H8R2WA01#					±0.25pF	GRM1555C1H9R5CA01#	
				±0.1pF	GRM1555C1H8R2BA01#				±0.5pF	GRM1555C1H9R5DA01#		
				±0.25pF	GRM1555C1H8R2CA01#				9.6pF	±0.05pF	GRM1555C1H9R6WA01#	

- GRM
- GR3
- GRJ
- GR4
- GR7
- GJM
- GQM
- GA2
- GA3 GB
- GA3 GD
- GA3 GF
- LLL
- LLA
- LLM
- LLR
- NFM
- KRM
- KR3
- GMA
- GMD
- ⚠Caution /Notice

Part number # indicates the package specification code.

GRM Series Temperature Compensating Type Part Number List

(→ 1.0×0.5mm)

T max.	Rated Voltage	TC Code	Cap.	Tol.	Part Number
0.55mm	50Vdc	COG	9.6pF	±0.1pF	GRM1555C1H9R6BA01#
				±0.25pF	GRM1555C1H9R6CA01#
				±0.5pF	GRM1555C1H9R6DA01#
			9.7pF	±0.05pF	GRM1555C1H9R7WA01#
				±0.1pF	GRM1555C1H9R7BA01#
				±0.25pF	GRM1555C1H9R7CA01#
				±0.5pF	GRM1555C1H9R7DA01#
			9.8pF	±0.05pF	GRM1555C1H9R8WA01#
				±0.1pF	GRM1555C1H9R8BA01#
				±0.25pF	GRM1555C1H9R8CA01#
				±0.5pF	GRM1555C1H9R8DA01#
			9.9pF	±0.05pF	GRM1555C1H9R9WA01#
				±0.1pF	GRM1555C1H9R9BA01#
				±0.25pF	GRM1555C1H9R9CA01#
				±0.5pF	GRM1555C1H9R9DA01#
			10pF	±2%	GRM1555C1H100GA01#
				±5%	GRM1555C1H100JA01#
			12pF	±2%	GRM1555C1H120GA01#
				±5%	GRM1555C1H120JA01#
			15pF	±2%	GRM1555C1H150GA01#
				±5%	GRM1555C1H150JA01#
			18pF	±2%	GRM1555C1H180GA01#
				±5%	GRM1555C1H180JA01#
			22pF	±2%	GRM1555C1H220GA01#
				±5%	GRM1555C1H220JA01#
			27pF	±2%	GRM1555C1H270GA01#
				±5%	GRM1555C1H270JA01#
			33pF	±2%	GRM1555C1H330GA01#
				±5%	GRM1555C1H330JA01#
			39pF	±2%	GRM1555C1H390GA01#
				±5%	GRM1555C1H390JA01#
			47pF	±2%	GRM1555C1H470GA01#
				±5%	GRM1555C1H470JA01#
			56pF	±2%	GRM1555C1H560GA01#
				±5%	GRM1555C1H560JA01#
			68pF	±2%	GRM1555C1H680GA01#
				±5%	GRM1555C1H680JA01#
			82pF	±2%	GRM1555C1H820GA01#
				±5%	GRM1555C1H820JA01#
			100pF	±2%	GRM1555C1H101GA01#
				±5%	GRM1555C1H101JA01#
			120pF	±2%	GRM1555C1H121GA01#
				±5%	GRM1555C1H121JA01#
			150pF	±2%	GRM1555C1H151GA01#
				±5%	GRM1555C1H151JA01#
			180pF	±2%	GRM1555C1H181GA01#
				±5%	GRM1555C1H181JA01#
			220pF	±2%	GRM1555C1H221GA01#
				±5%	GRM1555C1H221JA01#
			270pF	±2%	GRM1555C1H271GA01#
				±5%	GRM1555C1H271JA01#
			330pF	±2%	GRM1555C1H331GA01#
				±5%	GRM1555C1H331JA01#
			390pF	±2%	GRM1555C1H391GA01#

T max.	Rated Voltage	TC Code	Cap.	Tol.	Part Number	
0.55mm	50Vdc	COG	390pF	±5%	GRM1555C1H391JA01#	
				±2%	GRM1555C1H471GA01#	
				±5%	GRM1555C1H471JA01#	
			560pF	±2%	GRM1555C1H561GA01#	
				±5%	GRM1555C1H561JA01#	
				680pF	±2%	GRM1555C1H681GA01#
					±5%	GRM1555C1H681JA01#
			820pF	±2%	GRM1555C1H821GA01#	
				±5%	GRM1555C1H821JA01#	
			1000pF	±2%	GRM1555C1H102GA01#	
				±5%	GRM1555C1H102JA01#	
			CK	0.10pF	±0.05pF	GRM1554C1HR10WA01#
					±0.05pF	GRM1554C1HR20WA01#
					±0.1pF	GRM1554C1HR20BA01#
				0.30pF	±0.05pF	GRM1554C1HR30WA01#
					±0.1pF	GRM1554C1HR30BA01#
				0.40pF	±0.05pF	GRM1554C1HR40WA01#
					±0.1pF	GRM1554C1HR40BA01#
				0.50pF	±0.05pF	GRM1554C1HR50WA01#
					±0.1pF	GRM1554C1HR50BA01#
				0.60pF	±0.05pF	GRM1554C1HR60WA01#
					±0.1pF	GRM1554C1HR60BA01#
				0.70pF	±0.05pF	GRM1554C1HR70WA01#
					±0.1pF	GRM1554C1HR70BA01#
				0.80pF	±0.05pF	GRM1554C1HR80WA01#
					±0.1pF	GRM1554C1HR80BA01#
				0.90pF	±0.05pF	GRM1554C1HR90WA01#
		±0.1pF			GRM1554C1HR90BA01#	
		1.0pF		±0.05pF	GRM1554C1H1R0WA01#	
				±0.1pF	GRM1554C1H1R0BA01#	
				±0.25pF	GRM1554C1H1R0CA01#	
		1.1pF		±0.05pF	GRM1554C1H1R1WA01#	
				±0.1pF	GRM1554C1H1R1BA01#	
				±0.25pF	GRM1554C1H1R1CA01#	
		1.2pF		±0.05pF	GRM1554C1H1R2WA01#	
				±0.1pF	GRM1554C1H1R2BA01#	
				±0.25pF	GRM1554C1H1R2CA01#	
		1.3pF		±0.05pF	GRM1554C1H1R3WA01#	
			±0.1pF	GRM1554C1H1R3BA01#		
			±0.25pF	GRM1554C1H1R3CA01#		
		1.4pF	±0.05pF	GRM1554C1H1R4WA01#		
			±0.1pF	GRM1554C1H1R4BA01#		
			±0.25pF	GRM1554C1H1R4CA01#		
		1.5pF	±0.05pF	GRM1554C1H1R5WA01#		
			±0.1pF	GRM1554C1H1R5BA01#		
			±0.25pF	GRM1554C1H1R5CA01#		
		1.6pF	±0.05pF	GRM1554C1H1R6WA01#		
			±0.1pF	GRM1554C1H1R6BA01#		
			±0.25pF	GRM1554C1H1R6CA01#		
		1.7pF	±0.05pF	GRM1554C1H1R7WA01#		
			±0.1pF	GRM1554C1H1R7BA01#		
			±0.25pF	GRM1554C1H1R7CA01#		
		1.8pF	±0.05pF	GRM1554C1H1R8WA01#		
			±0.1pF	GRM1554C1H1R8BA01#		

Part number # indicates the package specification code.

GRM Series Temperature Compensating Type Part Number List

(→ 1.0×0.5mm)

T max.	Rated Voltage	TC Code	Cap.	Tol.	Part Number	T max.	Rated Voltage	TC Code	Cap.	Tol.	Part Number		
0.55mm	50Vdc	CK	1.8pF	±0.25pF	GRM1554C1H1R8CA01#	0.55mm	50Vdc	CJ	3.6pF	±0.25pF	GRM1553C1H3R6CA01#		
				±0.05pF	GRM1554C1H1R9WA01#					3.7pF	±0.05pF	GRM1553C1H3R7WA01#	
					±0.1pF						GRM1554C1H1R9BA01#	±0.1pF	GRM1553C1H3R7BA01#
			±0.25pF		GRM1554C1H1R9CA01#				±0.25pF		GRM1553C1H3R7CA01#		
			2.0pF	±0.05pF	GRM1554C1H2R0WA01#				3.8pF	±0.05pF	GRM1553C1H3R8WA01#		
				±0.1pF	GRM1554C1H2R0BA01#					±0.1pF	GRM1553C1H3R8BA01#		
				±0.25pF	GRM1554C1H2R0CA01#					±0.25pF	GRM1553C1H3R8CA01#		
			CJ	2.1pF	±0.05pF				GRM1553C1H2R1WA01#	CH	4.0pF	±0.05pF	GRM1552C1H4R0WA01#
					±0.1pF				GRM1553C1H2R1BA01#			±0.1pF	GRM1552C1H4R0BA01#
					±0.25pF				GRM1553C1H2R1CA01#			±0.25pF	GRM1552C1H4R0CA01#
				2.2pF	±0.05pF				GRM1553C1H2R2WA01#		4.1pF	±0.05pF	GRM1552C1H4R1WA01#
					±0.1pF				GRM1553C1H2R2BA01#			±0.1pF	GRM1552C1H4R1BA01#
					±0.25pF				GRM1553C1H2R2CA01#			±0.25pF	GRM1552C1H4R1CA01#
				2.3pF	±0.05pF				GRM1553C1H2R3WA01#		4.2pF	±0.05pF	GRM1552C1H4R2WA01#
					±0.1pF				GRM1553C1H2R3BA01#			±0.1pF	GRM1552C1H4R2BA01#
					±0.25pF				GRM1553C1H2R3CA01#			±0.25pF	GRM1552C1H4R2CA01#
			2.4pF	±0.05pF	GRM1553C1H2R4WA01#				4.3pF	±0.05pF	GRM1552C1H4R3WA01#		
				±0.1pF	GRM1553C1H2R4BA01#					±0.1pF	GRM1552C1H4R3BA01#		
		±0.25pF		GRM1553C1H2R4CA01#	±0.25pF	GRM1552C1H4R3CA01#							
		2.5pF	±0.05pF	GRM1553C1H2R5WA01#	4.4pF	±0.05pF	GRM1552C1H4R4WA01#						
			±0.1pF	GRM1553C1H2R5BA01#		±0.1pF	GRM1552C1H4R4BA01#						
			±0.25pF	GRM1553C1H2R5CA01#		±0.25pF	GRM1552C1H4R4CA01#						
		2.6pF	±0.05pF	GRM1553C1H2R6WA01#	4.5pF	±0.05pF	GRM1552C1H4R5WA01#						
			±0.1pF	GRM1553C1H2R6BA01#		±0.1pF	GRM1552C1H4R5BA01#						
			±0.25pF	GRM1553C1H2R6CA01#		±0.25pF	GRM1552C1H4R5CA01#						
		2.7pF	±0.05pF	GRM1553C1H2R7WA01#	4.6pF	±0.05pF	GRM1552C1H4R6WA01#						
			±0.1pF	GRM1553C1H2R7BA01#		±0.1pF	GRM1552C1H4R6BA01#						
			±0.25pF	GRM1553C1H2R7CA01#		±0.25pF	GRM1552C1H4R6CA01#						
		2.8pF	±0.05pF	GRM1553C1H2R8WA01#	4.7pF	±0.05pF	GRM1552C1H4R7WA01#						
			±0.1pF	GRM1553C1H2R8BA01#		±0.1pF	GRM1552C1H4R7BA01#						
			±0.25pF	GRM1553C1H2R8CA01#		±0.25pF	GRM1552C1H4R7CA01#						
		2.9pF	±0.05pF	GRM1553C1H2R9WA01#	4.8pF	±0.05pF	GRM1552C1H4R8WA01#						
			±0.1pF	GRM1553C1H2R9BA01#		±0.1pF	GRM1552C1H4R8BA01#						
			±0.25pF	GRM1553C1H2R9CA01#		±0.25pF	GRM1552C1H4R8CA01#						
		3.0pF	±0.05pF	GRM1553C1H3R0WA01#	4.9pF	±0.05pF	GRM1552C1H4R9WA01#						
			±0.1pF	GRM1553C1H3R0BA01#		±0.1pF	GRM1552C1H4R9BA01#						
			±0.25pF	GRM1553C1H3R0CA01#		±0.25pF	GRM1552C1H4R9CA01#						
		3.1pF	±0.05pF	GRM1553C1H3R1WA01#	5.0pF	±0.05pF	GRM1552C1H5R0WA01#						
			±0.1pF	GRM1553C1H3R1BA01#		±0.1pF	GRM1552C1H5R0BA01#						
			±0.25pF	GRM1553C1H3R1CA01#		±0.25pF	GRM1552C1H5R0CA01#						
		3.2pF	±0.05pF	GRM1553C1H3R2WA01#	5.1pF	±0.05pF	GRM1552C1H5R1WA01#						
			±0.1pF	GRM1553C1H3R2BA01#		±0.1pF	GRM1552C1H5R1BA01#						
			±0.25pF	GRM1553C1H3R2CA01#		±0.25pF	GRM1552C1H5R1CA01#						
		3.3pF	±0.05pF	GRM1553C1H3R3WA01#	5.2pF	±0.05pF	GRM1552C1H5R2WA01#						
			±0.1pF	GRM1553C1H3R3BA01#		±0.1pF	GRM1552C1H5R2BA01#						
			±0.25pF	GRM1553C1H3R3CA01#		±0.25pF	GRM1552C1H5R2CA01#						
		3.4pF	±0.05pF	GRM1553C1H3R4WA01#	5.3pF	±0.05pF	GRM1552C1H5R3WA01#						
			±0.1pF	GRM1553C1H3R4BA01#		±0.1pF	GRM1552C1H5R3BA01#						
			±0.25pF	GRM1553C1H3R4CA01#		±0.25pF	GRM1552C1H5R3CA01#						
		3.5pF	±0.05pF	GRM1553C1H3R5WA01#									
			±0.1pF	GRM1553C1H3R5BA01#									
			±0.25pF	GRM1553C1H3R5CA01#									
		3.6pF	±0.05pF	GRM1553C1H3R6WA01#									
			±0.1pF	GRM1553C1H3R6BA01#									

- GRM
- GR3
- GRJ
- GR4
- GR7
- GJM
- GJM
- GQM
- GA2
- GA3 GB
- GA3 GD
- GA3 GF
- LLL
- LLA
- LLM
- LLR
- NFM
- KRM
- KR3
- GMA
- GMD
- ⚠Caution /Notice

Part number # indicates the package specification code.

GRM Series Temperature Compensating Type Part Number List

(→ 1.0×0.5mm)

T max.	Rated Voltage	TC Code	Cap.	Tol.	Part Number
0.55mm	50Vdc	CH	5.3pF	±0.5pF	GRM1552C1H5R3DA01#
				±0.05pF	GRM1552C1H5R4WA01#
					±0.1pF
			±0.25pF		GRM1552C1H5R4CA01#
			5.4pF	±0.5pF	GRM1552C1H5R4DA01#
				±0.05pF	GRM1552C1H5R5WA01#
				±0.1pF	GRM1552C1H5R5BA01#
			5.5pF	±0.25pF	GRM1552C1H5R5CA01#
				±0.5pF	GRM1552C1H5R5DA01#
				±0.05pF	GRM1552C1H5R6WA01#
			5.6pF	±0.1pF	GRM1552C1H5R6BA01#
				±0.25pF	GRM1552C1H5R6CA01#
				±0.5pF	GRM1552C1H5R6DA01#
			5.7pF	±0.05pF	GRM1552C1H5R7WA01#
				±0.1pF	GRM1552C1H5R7BA01#
				±0.25pF	GRM1552C1H5R7CA01#
			5.8pF	±0.5pF	GRM1552C1H5R7DA01#
				±0.05pF	GRM1552C1H5R8WA01#
				±0.1pF	GRM1552C1H5R8BA01#
			5.9pF	±0.25pF	GRM1552C1H5R8CA01#
				±0.5pF	GRM1552C1H5R8DA01#
				±0.05pF	GRM1552C1H5R9WA01#
			6.0pF	±0.1pF	GRM1552C1H5R9BA01#
				±0.25pF	GRM1552C1H5R9CA01#
				±0.5pF	GRM1552C1H5R9DA01#
			6.1pF	±0.05pF	GRM1552C1H6R0WA01#
				±0.1pF	GRM1552C1H6R0BA01#
				±0.25pF	GRM1552C1H6R0CA01#
			6.2pF	±0.5pF	GRM1552C1H6R0DA01#
				±0.05pF	GRM1552C1H6R1WA01#
				±0.1pF	GRM1552C1H6R1BA01#
			6.3pF	±0.25pF	GRM1552C1H6R1CA01#
				±0.5pF	GRM1552C1H6R1DA01#
				±0.05pF	GRM1552C1H6R2WA01#
			6.4pF	±0.1pF	GRM1552C1H6R2BA01#
				±0.25pF	GRM1552C1H6R2CA01#
				±0.5pF	GRM1552C1H6R2DA01#
			6.5pF	±0.05pF	GRM1552C1H6R3WA01#
				±0.1pF	GRM1552C1H6R3BA01#
				±0.25pF	GRM1552C1H6R3CA01#
			6.6pF	±0.5pF	GRM1552C1H6R3DA01#
				±0.05pF	GRM1552C1H6R4WA01#
				±0.1pF	GRM1552C1H6R4BA01#
			6.7pF	±0.25pF	GRM1552C1H6R4CA01#
				±0.5pF	GRM1552C1H6R4DA01#
				±0.05pF	GRM1552C1H6R5WA01#
			6.8pF	±0.1pF	GRM1552C1H6R5BA01#
				±0.25pF	GRM1552C1H6R5CA01#
				±0.5pF	GRM1552C1H6R5DA01#
			6.9pF	±0.05pF	GRM1552C1H6R6WA01#
				±0.1pF	GRM1552C1H6R6BA01#
				±0.25pF	GRM1552C1H6R6CA01#
			7.0pF	±0.5pF	GRM1552C1H6R6DA01#
				±0.05pF	GRM1552C1H6R7WA01#
				±0.1pF	GRM1552C1H6R7BA01#
			7.1pF	±0.25pF	GRM1552C1H6R7CA01#
				±0.5pF	GRM1552C1H6R7DA01#
				±0.05pF	GRM1552C1H6R8WA01#
			7.2pF	±0.1pF	GRM1552C1H6R8BA01#
				±0.25pF	GRM1552C1H6R8CA01#
				±0.5pF	GRM1552C1H6R8DA01#
			7.3pF	±0.05pF	GRM1552C1H6R9WA01#
				±0.1pF	GRM1552C1H6R9BA01#
				±0.25pF	GRM1552C1H6R9CA01#
			7.4pF	±0.5pF	GRM1552C1H6R9DA01#
				±0.05pF	GRM1552C1H7R0WA01#
				±0.1pF	GRM1552C1H7R0BA01#
			7.5pF	±0.25pF	GRM1552C1H7R0CA01#
				±0.5pF	GRM1552C1H7R0DA01#
				±0.05pF	GRM1552C1H7R1WA01#
			7.6pF	±0.1pF	GRM1552C1H7R1BA01#
				±0.25pF	GRM1552C1H7R1CA01#
				±0.5pF	GRM1552C1H7R1DA01#
			7.7pF	±0.05pF	GRM1552C1H7R2WA01#
				±0.1pF	GRM1552C1H7R2BA01#
				±0.25pF	GRM1552C1H7R2CA01#
			7.8pF	±0.5pF	GRM1552C1H7R2DA01#
				±0.05pF	GRM1552C1H7R3WA01#
				±0.1pF	GRM1552C1H7R3BA01#
			7.9pF	±0.25pF	GRM1552C1H7R3CA01#
				±0.5pF	GRM1552C1H7R3DA01#
				±0.05pF	GRM1552C1H7R4WA01#
			8.0pF	±0.1pF	GRM1552C1H7R4BA01#
				±0.25pF	GRM1552C1H7R4CA01#
				±0.5pF	GRM1552C1H7R4DA01#

T max.	Rated Voltage	TC Code	Cap.	Tol.	Part Number
0.55mm	50Vdc	CH	6.7pF	±0.1pF	GRM1552C1H6R7BA01#
				±0.25pF	GRM1552C1H6R7CA01#
				±0.5pF	GRM1552C1H6R7DA01#
			6.8pF	±0.05pF	GRM1552C1H6R8WA01#
				±0.1pF	GRM1552C1H6R8BA01#
				±0.25pF	GRM1552C1H6R8CA01#
			6.9pF	±0.5pF	GRM1552C1H6R8DA01#
				±0.05pF	GRM1552C1H6R9WA01#
				±0.1pF	GRM1552C1H6R9BA01#
			7.0pF	±0.25pF	GRM1552C1H6R9CA01#
				±0.5pF	GRM1552C1H6R9DA01#
				±0.05pF	GRM1552C1H7R0WA01#
			7.1pF	±0.1pF	GRM1552C1H7R0BA01#
				±0.25pF	GRM1552C1H7R0CA01#
				±0.5pF	GRM1552C1H7R0DA01#
			7.2pF	±0.05pF	GRM1552C1H7R1WA01#
				±0.1pF	GRM1552C1H7R1BA01#
				±0.25pF	GRM1552C1H7R1CA01#
			7.3pF	±0.5pF	GRM1552C1H7R1DA01#
				±0.05pF	GRM1552C1H7R2WA01#
				±0.1pF	GRM1552C1H7R2BA01#
			7.4pF	±0.25pF	GRM1552C1H7R2CA01#
				±0.5pF	GRM1552C1H7R2DA01#
				±0.05pF	GRM1552C1H7R3WA01#
			7.5pF	±0.1pF	GRM1552C1H7R3BA01#
				±0.25pF	GRM1552C1H7R3CA01#
				±0.5pF	GRM1552C1H7R3DA01#
			7.6pF	±0.05pF	GRM1552C1H7R4WA01#
				±0.1pF	GRM1552C1H7R4BA01#
				±0.25pF	GRM1552C1H7R4CA01#
			7.7pF	±0.5pF	GRM1552C1H7R4DA01#
				±0.05pF	GRM1552C1H7R5WA01#
				±0.1pF	GRM1552C1H7R5BA01#
			7.8pF	±0.25pF	GRM1552C1H7R5CA01#
				±0.5pF	GRM1552C1H7R5DA01#
				±0.05pF	GRM1552C1H7R6WA01#
			7.9pF	±0.1pF	GRM1552C1H7R6BA01#
				±0.25pF	GRM1552C1H7R6CA01#
				±0.5pF	GRM1552C1H7R6DA01#
			8.0pF	±0.05pF	GRM1552C1H7R7WA01#
				±0.1pF	GRM1552C1H7R7BA01#
				±0.25pF	GRM1552C1H7R7CA01#
			8.0pF	±0.5pF	GRM1552C1H7R7DA01#
				±0.05pF	GRM1552C1H7R8WA01#
				±0.1pF	GRM1552C1H7R8BA01#
			8.0pF	±0.25pF	GRM1552C1H7R8CA01#
				±0.5pF	GRM1552C1H7R8DA01#
				±0.05pF	GRM1552C1H7R9WA01#
			8.0pF	±0.1pF	GRM1552C1H7R9BA01#
				±0.25pF	GRM1552C1H7R9CA01#
				±0.5pF	GRM1552C1H7R9DA01#
			8.0pF	±0.05pF	GRM1552C1H8R0WA01#
				±0.1pF	GRM1552C1H8R0BA01#
				±0.25pF	GRM1552C1H8R0CA01#

Part number # indicates the package specification code.

Caution / Notice

GRM
 GR3
 GRJ
 GR4
 GR7
 GJM
 GQM
 GA2
 GA3 GB
 GA3 GD
 GA3 GF
 LLL
 LLA
 LLM
 LLR
 NFM
 KRM
 KR3
 GMA
 GMD

GRM Series Temperature Compensating Type Part Number List

(→ 1.0×0.5mm)

T max.	Rated Voltage	TC Code	Cap.	Tol.	Part Number
0.55mm	50Vdc	CH	8.0pF	±0.5pF	GRM1552C1H8R0DA01#
				±0.05pF	GRM1552C1H8R1WA01#
			8.1pF	±0.1pF	GRM1552C1H8R1BA01#
				±0.25pF	GRM1552C1H8R1CA01#
				±0.5pF	GRM1552C1H8R1DA01#
				±0.05pF	GRM1552C1H8R2WA01#
			8.2pF	±0.1pF	GRM1552C1H8R2BA01#
				±0.25pF	GRM1552C1H8R2CA01#
				±0.5pF	GRM1552C1H8R2DA01#
				±0.05pF	GRM1552C1H8R3WA01#
			8.3pF	±0.1pF	GRM1552C1H8R3BA01#
				±0.25pF	GRM1552C1H8R3CA01#
				±0.5pF	GRM1552C1H8R3DA01#
				±0.05pF	GRM1552C1H8R4WA01#
			8.4pF	±0.1pF	GRM1552C1H8R4BA01#
				±0.25pF	GRM1552C1H8R4CA01#
				±0.5pF	GRM1552C1H8R4DA01#
				±0.05pF	GRM1552C1H8R5WA01#
			8.5pF	±0.1pF	GRM1552C1H8R5BA01#
				±0.25pF	GRM1552C1H8R5CA01#
				±0.5pF	GRM1552C1H8R5DA01#
				±0.05pF	GRM1552C1H8R6WA01#
			8.6pF	±0.1pF	GRM1552C1H8R6BA01#
				±0.25pF	GRM1552C1H8R6CA01#
				±0.5pF	GRM1552C1H8R6DA01#
				±0.05pF	GRM1552C1H8R7WA01#
			8.7pF	±0.1pF	GRM1552C1H8R7BA01#
				±0.25pF	GRM1552C1H8R7CA01#
				±0.5pF	GRM1552C1H8R7DA01#
				±0.05pF	GRM1552C1H8R8WA01#
			8.8pF	±0.1pF	GRM1552C1H8R8BA01#
				±0.25pF	GRM1552C1H8R8CA01#
				±0.5pF	GRM1552C1H8R8DA01#
				±0.05pF	GRM1552C1H8R9WA01#
			8.9pF	±0.1pF	GRM1552C1H8R9BA01#
				±0.25pF	GRM1552C1H8R9CA01#
				±0.5pF	GRM1552C1H8R9DA01#
				±0.05pF	GRM1552C1H9R0WA01#
			9.0pF	±0.1pF	GRM1552C1H9R0BA01#
				±0.25pF	GRM1552C1H9R0CA01#
				±0.5pF	GRM1552C1H9R0DA01#
				±0.05pF	GRM1552C1H9R1WA01#
			9.1pF	±0.1pF	GRM1552C1H9R1BA01#
				±0.25pF	GRM1552C1H9R1CA01#
				±0.5pF	GRM1552C1H9R1DA01#
				±0.05pF	GRM1552C1H9R2WA01#
			9.2pF	±0.1pF	GRM1552C1H9R2BA01#
				±0.25pF	GRM1552C1H9R2CA01#
				±0.5pF	GRM1552C1H9R2DA01#
				±0.05pF	GRM1552C1H9R3WA01#
			9.3pF	±0.1pF	GRM1552C1H9R3BA01#
				±0.25pF	GRM1552C1H9R3CA01#
				±0.5pF	GRM1552C1H9R3DA01#
				±0.05pF	GRM1552C1H9R4WA01#

T max.	Rated Voltage	TC Code	Cap.	Tol.	Part Number
0.55mm	50Vdc	CH	9.4pF	±0.1pF	GRM1552C1H9R4BA01#
				±0.25pF	GRM1552C1H9R4CA01#
				±0.5pF	GRM1552C1H9R4DA01#
			9.5pF	±0.05pF	GRM1552C1H9R5WA01#
				±0.1pF	GRM1552C1H9R5BA01#
				±0.25pF	GRM1552C1H9R5CA01#
			9.6pF	±0.5pF	GRM1552C1H9R5DA01#
				±0.05pF	GRM1552C1H9R6WA01#
				±0.1pF	GRM1552C1H9R6BA01#
			9.7pF	±0.25pF	GRM1552C1H9R6CA01#
				±0.5pF	GRM1552C1H9R6DA01#
				±0.05pF	GRM1552C1H9R7WA01#
			9.8pF	±0.1pF	GRM1552C1H9R7BA01#
				±0.25pF	GRM1552C1H9R7CA01#
				±0.5pF	GRM1552C1H9R7DA01#
			9.9pF	±0.05pF	GRM1552C1H9R8WA01#
				±0.1pF	GRM1552C1H9R8BA01#
				±0.25pF	GRM1552C1H9R8CA01#
			10pF	±0.5pF	GRM1552C1H9R8DA01#
				±0.05pF	GRM1552C1H9R9WA01#
				±0.1pF	GRM1552C1H9R9BA01#
			12pF	±0.25pF	GRM1552C1H9R9CA01#
				±0.5pF	GRM1552C1H9R9DA01#
				±2%	GRM1552C1H100GA01#
			15pF	±5%	GRM1552C1H100JA01#
				±2%	GRM1552C1H120GA01#
				±5%	GRM1552C1H120JA01#
			18pF	±2%	GRM1552C1H150GA01#
				±5%	GRM1552C1H150JA01#
				±2%	GRM1552C1H180GA01#
			22pF	±5%	GRM1552C1H180JA01#
				±2%	GRM1552C1H220GA01#
				±5%	GRM1552C1H220JA01#
			27pF	±2%	GRM1552C1H270GA01#
				±5%	GRM1552C1H270JA01#
				±2%	GRM1552C1H330GA01#
			33pF	±5%	GRM1552C1H330JA01#
				±2%	GRM1552C1H390GA01#
				±5%	GRM1552C1H390JA01#
			39pF	±2%	GRM1552C1H470GA01#
				±5%	GRM1552C1H470JA01#
				±2%	GRM1552C1H560GA01#
			47pF	±5%	GRM1552C1H560JA01#
				±2%	GRM1552C1H680GA01#
				±5%	GRM1552C1H680JA01#
			56pF	±2%	GRM1552C1H820GA01#
				±5%	GRM1552C1H820JA01#
				±2%	GRM1552C1H101GA01#
			68pF	±5%	GRM1552C1H101JA01#
				±2%	GRM1552C1H121GA01#
				±5%	GRM1552C1H121JA01#
			82pF	±2%	GRM1552C1H151GA01#
				±5%	GRM1552C1H151JA01#
				±2%	GRM1552C1H181GA01#
			100pF	±5%	GRM1552C1H181JA01#

- GRM
- GR3
- GRJ
- GR4
- GR7
- GJM
- GQM
- GA2
- GA3 GB
- GA3 GD
- GA3 GF
- LLL
- LLA
- LLM
- LLR
- NFM
- KRM
- KR3
- GMA
- GMD
- ⚠Caution /Notice

Part number # indicates the package specification code.

GRM Series Temperature Compensating Type Part Number List

(→ 1.0×0.5mm)

T max.	Rated Voltage	TC Code	Cap.	Tol.	Part Number		
0.55mm	50Vdc	CH	180pF	±5%	GRM1552C1H181JA01#		
				±2%	GRM1552C1H221GA01#		
			±5%	GRM1552C1H221JA01#			
			270pF	±2%	GRM1552C1H271GA01#		
				±5%	GRM1552C1H271JA01#		
			330pF	±2%	GRM1552C1H331GA01#		
				±5%	GRM1552C1H331JA01#		
			390pF	±2%	GRM1552C1H391GA01#		
				±5%	GRM1552C1H391JA01#		
			470pF	±2%	GRM1552C1H471GA01#		
				±5%	GRM1552C1H471JA01#		
			560pF	±2%	GRM1552C1H561GA01#		
				±5%	GRM1552C1H561JA01#		
			680pF	±2%	GRM1552C1H681GA01#		
				±5%	GRM1552C1H681JA01#		
			820pF	±2%	GRM1552C1H821GA01#		
				±5%	GRM1552C1H821JA01#		
			1000pF	±2%	GRM1552C1H102GA01#		
				±5%	GRM1552C1H102JA01#		
			10Vdc	SL	1200pF	±5%	GRM1551X1A122JA01#
					1500pF	±5%	GRM1551X1A152JA01#
					1800pF	±5%	GRM1551X1A182JA01#
					2200pF	±5%	GRM1551X1A222JA01#
					2700pF	±5%	GRM1551X1A272JA01#
	3300pF	±5%			GRM1551X1A332JA01#		
	3900pF	±5%			GRM1551X1A392JA01#		
	4700pF	±5%			GRM1551X1A472JA01#		
	U2J	1200pF			±5%	GRM1557U1A122JA01#	
		1500pF			±5%	GRM1557U1A152JA01#	
		1800pF			±5%	GRM1557U1A182JA01#	
		2200pF			±5%	GRM1557U1A222JA01#	
		2700pF		±5%	GRM1557U1A272JA01#		
		3300pF		±5%	GRM1557U1A332JA01#		
		3900pF		±5%	GRM1557U1A392JA01#		
		4700pF		±5%	GRM1557U1A472JA01#		
		UJ		1200pF	±5%	GRM1553U1A122JA01#	
				1500pF	±5%	GRM1553U1A152JA01#	
				1800pF	±5%	GRM1553U1A182JA01#	
				2200pF	±5%	GRM1553U1A222JA01#	
	2700pF			±5%	GRM1553U1A272JA01#		
	3300pF			±5%	GRM1553U1A332JA01#		
	3900pF			±5%	GRM1553U1A392JA01#		
	4700pF			±5%	GRM1553U1A472JA01#		

T max.	Rated Voltage	TC Code	Cap.	Tol.	Part Number	
0.5mm	50Vdc	U2J	2700pF	±5%	GRM1857U1H272JA44#	
				±5%	GRM1857U1H332JA44#	
			3900pF	±5%	GRM1857U1H392JA44#	
				±5%	GRM1857U1H472JA44#	
			UJ	2200pF	±5%	GRM1853U1H222JA44#
				2700pF	±5%	GRM1853U1H272JA44#
				3300pF	±5%	GRM1853U1H332JA44#
				3900pF	±5%	GRM1853U1H392JA44#
				4700pF	±5%	GRM1853U1H472JA44#
				5600pF	±5%	GRM1851X1A562JA44#
			SL	6800pF	±5%	GRM1851X1A682JA44#
				8200pF	±5%	GRM1851X1A822JA44#
		10000pF		±5%	GRM1851X1A103JA44#	
		U2J		5600pF	±5%	GRM1857U1A562JA44#
				6800pF	±5%	GRM1857U1A682JA44#
				8200pF	±5%	GRM1857U1A822JA44#
			10000pF	±5%	GRM1857U1A103JA44#	
		UJ	5600pF	±5%	GRM1853U1A562JA44#	
			6800pF	±5%	GRM1853U1A682JA44#	
			8200pF	±5%	GRM1853U1A822JA44#	
			10000pF	±5%	GRM1853U1A103JA44#	
		10Vdc	COG	0.50pF	±0.05pF	GRM1885C2AR50WA01#
					±0.1pF	GRM1885C2AR50BA01#
				0.60pF	±0.05pF	GRM1885C2AR60WA01#
	±0.1pF				GRM1885C2AR60BA01#	
	0.70pF			±0.05pF	GRM1885C2AR70WA01#	
				±0.1pF	GRM1885C2AR70BA01#	
	0.80pF			±0.05pF	GRM1885C2AR80WA01#	
				±0.1pF	GRM1885C2AR80BA01#	
	0.90pF			±0.05pF	GRM1885C2AR90WA01#	
				±0.1pF	GRM1885C2AR90BA01#	
	1.0pF			±0.05pF	GRM1885C2A1R0WA01#	
				±0.1pF	GRM1885C2A1R0BA01#	
				±0.25pF	GRM1885C2A1R0CA01#	
	1.1pF			±0.05pF	GRM1885C2A1R1WA01#	
				±0.1pF	GRM1885C2A1R1BA01#	
				±0.25pF	GRM1885C2A1R1CA01#	
	1.2pF			±0.05pF	GRM1885C2A1R2WA01#	
				±0.1pF	GRM1885C2A1R2BA01#	
				±0.25pF	GRM1885C2A1R2CA01#	
	1.3pF			±0.05pF	GRM1885C2A1R3WA01#	
				±0.1pF	GRM1885C2A1R3BA01#	
				±0.25pF	GRM1885C2A1R3CA01#	
	1.4pF			±0.05pF	GRM1885C2A1R4WA01#	
				±0.1pF	GRM1885C2A1R4BA01#	
		±0.25pF	GRM1885C2A1R4CA01#			
	1.5pF	±0.05pF	GRM1885C2A1R5WA01#			
		±0.1pF	GRM1885C2A1R5BA01#			
±0.25pF		GRM1885C2A1R5CA01#				
1.6pF	±0.05pF	GRM1885C2A1R6WA01#				
	±0.1pF	GRM1885C2A1R6BA01#				
	±0.25pF	GRM1885C2A1R6CA01#				
1.7pF	±0.05pF	GRM1885C2A1R7WA01#				
	±0.1pF	GRM1885C2A1R7BA01#				

1.6×0.8mm

T max.	Rated Voltage	TC Code	Cap.	Tol.	Part Number
0.5mm	50Vdc	SL	2200pF	±5%	GRM1851X1H222JA44#
			2700pF	±5%	GRM1851X1H272JA44#
			3300pF	±5%	GRM1851X1H332JA44#
			3900pF	±5%	GRM1851X1H392JA44#
			4700pF	±5%	GRM1851X1H472JA44#
		U2J	2200pF	±5%	GRM1857U1H222JA44#

Part number # indicates the package specification code.

GRM
 GR3
 GRJ
 GR4
 GR7
 GJM
 GQM
 GA2
 GA3 GB
 GA3 GD
 GA3 GF
 LLL
 LLA
 LLM
 LLR
 NFM
 KRM
 KR3
 GMA
 GMD
 ⚠Caution /Notice

GRM Series Temperature Compensating Type Part Number List

(→ 1.6×0.8mm)

T max.	Rated Voltage	TC Code	Cap.	Tol.	Part Number	T max.	Rated Voltage	TC Code	Cap.	Tol.	Part Number		
0.9mm	100Vdc	COG	1.7pF	±0.25pF	GRM1885C2A1R7CA01#	0.9mm	100Vdc	COG	3.5pF	±0.25pF	GRM1885C2A3R5CA01#		
				1.8pF	±0.05pF					GRM1885C2A1R8WA01#	3.6pF	±0.05pF	GRM1885C2A3R6WA01#
					±0.1pF					GRM1885C2A1R8BA01#		±0.1pF	GRM1885C2A3R6BA01#
			±0.25pF		GRM1885C2A1R8CA01#				±0.25pF	GRM1885C2A3R6CA01#			
			1.9pF	±0.05pF	GRM1885C2A1R9WA01#				3.7pF	±0.05pF	GRM1885C2A3R7WA01#		
				±0.1pF	GRM1885C2A1R9BA01#					±0.1pF	GRM1885C2A3R7BA01#		
				±0.25pF	GRM1885C2A1R9CA01#					±0.25pF	GRM1885C2A3R7CA01#		
			2.0pF	±0.05pF	GRM1885C2A2R0WA01#				3.8pF	±0.05pF	GRM1885C2A3R8WA01#		
				±0.1pF	GRM1885C2A2R0BA01#					±0.1pF	GRM1885C2A3R8BA01#		
				±0.25pF	GRM1885C2A2R0CA01#					±0.25pF	GRM1885C2A3R8CA01#		
			2.1pF	±0.05pF	GRM1885C2A2R1WA01#				3.9pF	±0.05pF	GRM1885C2A3R9WA01#		
				±0.1pF	GRM1885C2A2R1BA01#					±0.1pF	GRM1885C2A3R9BA01#		
				±0.25pF	GRM1885C2A2R1CA01#					±0.25pF	GRM1885C2A3R9CA01#		
			2.2pF	±0.05pF	GRM1885C2A2R2WA01#				4.0pF	±0.05pF	GRM1885C2A4R0WA01#		
				±0.1pF	GRM1885C2A2R2BA01#					±0.1pF	GRM1885C2A4R0BA01#		
				±0.25pF	GRM1885C2A2R2CA01#					±0.25pF	GRM1885C2A4R0CA01#		
			2.3pF	±0.05pF	GRM1885C2A2R3WA01#				4.1pF	±0.05pF	GRM1885C2A4R1WA01#		
				±0.1pF	GRM1885C2A2R3BA01#					±0.1pF	GRM1885C2A4R1BA01#		
				±0.25pF	GRM1885C2A2R3CA01#					±0.25pF	GRM1885C2A4R1CA01#		
			2.4pF	±0.05pF	GRM1885C2A2R4WA01#				4.2pF	±0.05pF	GRM1885C2A4R2WA01#		
				±0.1pF	GRM1885C2A2R4BA01#					±0.1pF	GRM1885C2A4R2BA01#		
				±0.25pF	GRM1885C2A2R4CA01#					±0.25pF	GRM1885C2A4R2CA01#		
			2.5pF	±0.05pF	GRM1885C2A2R5WA01#				4.3pF	±0.05pF	GRM1885C2A4R3WA01#		
				±0.1pF	GRM1885C2A2R5BA01#					±0.1pF	GRM1885C2A4R3BA01#		
				±0.25pF	GRM1885C2A2R5CA01#					±0.25pF	GRM1885C2A4R3CA01#		
			2.6pF	±0.05pF	GRM1885C2A2R6WA01#				4.4pF	±0.05pF	GRM1885C2A4R4WA01#		
				±0.1pF	GRM1885C2A2R6BA01#					±0.1pF	GRM1885C2A4R4BA01#		
				±0.25pF	GRM1885C2A2R6CA01#					±0.25pF	GRM1885C2A4R4CA01#		
			2.7pF	±0.05pF	GRM1885C2A2R7WA01#				4.5pF	±0.05pF	GRM1885C2A4R5WA01#		
				±0.1pF	GRM1885C2A2R7BA01#					±0.1pF	GRM1885C2A4R5BA01#		
				±0.25pF	GRM1885C2A2R7CA01#					±0.25pF	GRM1885C2A4R5CA01#		
			2.8pF	±0.05pF	GRM1885C2A2R8WA01#				4.6pF	±0.05pF	GRM1885C2A4R6WA01#		
				±0.1pF	GRM1885C2A2R8BA01#					±0.1pF	GRM1885C2A4R6BA01#		
				±0.25pF	GRM1885C2A2R8CA01#					±0.25pF	GRM1885C2A4R6CA01#		
			2.9pF	±0.05pF	GRM1885C2A2R9WA01#				4.7pF	±0.05pF	GRM1885C2A4R7WA01#		
				±0.1pF	GRM1885C2A2R9BA01#					±0.1pF	GRM1885C2A4R7BA01#		
				±0.25pF	GRM1885C2A2R9CA01#					±0.25pF	GRM1885C2A4R7CA01#		
			3.0pF	±0.05pF	GRM1885C2A3R0WA01#				4.8pF	±0.05pF	GRM1885C2A4R8WA01#		
				±0.1pF	GRM1885C2A3R0BA01#					±0.1pF	GRM1885C2A4R8BA01#		
				±0.25pF	GRM1885C2A3R0CA01#					±0.25pF	GRM1885C2A4R8CA01#		
			3.1pF	±0.05pF	GRM1885C2A3R1WA01#				4.9pF	±0.05pF	GRM1885C2A4R9WA01#		
				±0.1pF	GRM1885C2A3R1BA01#					±0.1pF	GRM1885C2A4R9BA01#		
				±0.25pF	GRM1885C2A3R1CA01#					±0.25pF	GRM1885C2A4R9CA01#		
			3.2pF	±0.05pF	GRM1885C2A3R2WA01#				5.0pF	±0.05pF	GRM1885C2A5R0WA01#		
				±0.1pF	GRM1885C2A3R2BA01#					±0.1pF	GRM1885C2A5R0BA01#		
				±0.25pF	GRM1885C2A3R2CA01#					±0.25pF	GRM1885C2A5R0CA01#		
			3.3pF	±0.05pF	GRM1885C2A3R3WA01#				5.1pF	±0.05pF	GRM1885C2A5R1WA01#		
				±0.1pF	GRM1885C2A3R3BA01#					±0.1pF	GRM1885C2A5R1BA01#		
				±0.25pF	GRM1885C2A3R3CA01#					±0.25pF	GRM1885C2A5R1CA01#		
			3.4pF	±0.05pF	GRM1885C2A3R4WA01#				5.2pF	±0.5pF	GRM1885C2A5R1DA01#		
				±0.1pF	GRM1885C2A3R4BA01#					±0.05pF	±0.05pF	GRM1885C2A5R2WA01#	
				±0.25pF	GRM1885C2A3R4CA01#						±0.1pF	GRM1885C2A5R2BA01#	
			3.5pF	±0.05pF	GRM1885C2A3R5WA01#				±0.25pF		±0.25pF	GRM1885C2A5R2CA01#	
				±0.1pF	GRM1885C2A3R5BA01#					±0.5pF	GRM1885C2A5R2DA01#		

GRM
 GR3
 GRJ
 GR4
 GR7
 GJM
 GQM
 GA2
 GA3 GB
 GA3 GD
 GA3 GF
 LLL
 LLA
 LLM
 LLR
 NFM
 KRM
 KR3
 GMA
 GMD
 ⚠Caution /Notice

Part number # indicates the package specification code.

GRM Series Temperature Compensating Type Part Number List

(→ 1.6×0.8mm)

T max.	Rated Voltage	TC Code	Cap.	Tol.	Part Number
0.9mm	100Vdc	COG	5.3pF	±0.05pF	GRM1885C2A5R3WA01#
				±0.1pF	GRM1885C2A5R3BA01#
				±0.25pF	GRM1885C2A5R3CA01#
				±0.5pF	GRM1885C2A5R3DA01#
			5.4pF	±0.05pF	GRM1885C2A5R4WA01#
				±0.1pF	GRM1885C2A5R4BA01#
				±0.25pF	GRM1885C2A5R4CA01#
				±0.5pF	GRM1885C2A5R4DA01#
			5.5pF	±0.05pF	GRM1885C2A5R5WA01#
				±0.1pF	GRM1885C2A5R5BA01#
				±0.25pF	GRM1885C2A5R5CA01#
				±0.5pF	GRM1885C2A5R5DA01#
			5.6pF	±0.05pF	GRM1885C2A5R6WA01#
				±0.1pF	GRM1885C2A5R6BA01#
				±0.25pF	GRM1885C2A5R6CA01#
				±0.5pF	GRM1885C2A5R6DA01#
			5.7pF	±0.05pF	GRM1885C2A5R7WA01#
				±0.1pF	GRM1885C2A5R7BA01#
				±0.25pF	GRM1885C2A5R7CA01#
				±0.5pF	GRM1885C2A5R7DA01#
			5.8pF	±0.05pF	GRM1885C2A5R8WA01#
				±0.1pF	GRM1885C2A5R8BA01#
				±0.25pF	GRM1885C2A5R8CA01#
				±0.5pF	GRM1885C2A5R8DA01#
			5.9pF	±0.05pF	GRM1885C2A5R9WA01#
				±0.1pF	GRM1885C2A5R9BA01#
				±0.25pF	GRM1885C2A5R9CA01#
				±0.5pF	GRM1885C2A5R9DA01#
			6.0pF	±0.05pF	GRM1885C2A6R0WA01#
				±0.1pF	GRM1885C2A6R0BA01#
				±0.25pF	GRM1885C2A6R0CA01#
				±0.5pF	GRM1885C2A6R0DA01#
			6.1pF	±0.05pF	GRM1885C2A6R1WA01#
				±0.1pF	GRM1885C2A6R1BA01#
				±0.25pF	GRM1885C2A6R1CA01#
				±0.5pF	GRM1885C2A6R1DA01#
			6.2pF	±0.05pF	GRM1885C2A6R2WA01#
				±0.1pF	GRM1885C2A6R2BA01#
				±0.25pF	GRM1885C2A6R2CA01#
				±0.5pF	GRM1885C2A6R2DA01#
			6.3pF	±0.05pF	GRM1885C2A6R3WA01#
				±0.1pF	GRM1885C2A6R3BA01#
				±0.25pF	GRM1885C2A6R3CA01#
				±0.5pF	GRM1885C2A6R3DA01#
			6.4pF	±0.05pF	GRM1885C2A6R4WA01#
				±0.1pF	GRM1885C2A6R4BA01#
				±0.25pF	GRM1885C2A6R4CA01#
				±0.5pF	GRM1885C2A6R4DA01#
			6.5pF	±0.05pF	GRM1885C2A6R5WA01#
				±0.1pF	GRM1885C2A6R5BA01#
				±0.25pF	GRM1885C2A6R5CA01#
				±0.5pF	GRM1885C2A6R5DA01#
			6.6pF	±0.05pF	GRM1885C2A6R6WA01#
				±0.1pF	GRM1885C2A6R6BA01#

T max.	Rated Voltage	TC Code	Cap.	Tol.	Part Number
0.9mm	100Vdc	COG	6.6pF	±0.25pF	GRM1885C2A6R6CA01#
				±0.5pF	GRM1885C2A6R6DA01#
			6.7pF	±0.05pF	GRM1885C2A6R7WA01#
				±0.1pF	GRM1885C2A6R7BA01#
				±0.25pF	GRM1885C2A6R7CA01#
			6.8pF	±0.05pF	GRM1885C2A6R8WA01#
				±0.1pF	GRM1885C2A6R8BA01#
				±0.25pF	GRM1885C2A6R8CA01#
			6.9pF	±0.05pF	GRM1885C2A6R9WA01#
				±0.1pF	GRM1885C2A6R9BA01#
				±0.25pF	GRM1885C2A6R9CA01#
			7.0pF	±0.05pF	GRM1885C2A7R0WA01#
				±0.1pF	GRM1885C2A7R0BA01#
				±0.25pF	GRM1885C2A7R0CA01#
			7.1pF	±0.05pF	GRM1885C2A7R1WA01#
				±0.1pF	GRM1885C2A7R1BA01#
				±0.25pF	GRM1885C2A7R1CA01#
			7.2pF	±0.05pF	GRM1885C2A7R2WA01#
				±0.1pF	GRM1885C2A7R2BA01#
				±0.25pF	GRM1885C2A7R2CA01#
			7.3pF	±0.05pF	GRM1885C2A7R3WA01#
				±0.1pF	GRM1885C2A7R3BA01#
				±0.25pF	GRM1885C2A7R3CA01#
			7.4pF	±0.05pF	GRM1885C2A7R4WA01#
				±0.1pF	GRM1885C2A7R4BA01#
				±0.25pF	GRM1885C2A7R4CA01#
			7.5pF	±0.05pF	GRM1885C2A7R5WA01#
				±0.1pF	GRM1885C2A7R5BA01#
				±0.25pF	GRM1885C2A7R5CA01#
			7.6pF	±0.05pF	GRM1885C2A7R6WA01#
				±0.1pF	GRM1885C2A7R6BA01#
				±0.25pF	GRM1885C2A7R6CA01#
			7.7pF	±0.05pF	GRM1885C2A7R7WA01#
				±0.1pF	GRM1885C2A7R7BA01#
				±0.25pF	GRM1885C2A7R7CA01#
			7.8pF	±0.05pF	GRM1885C2A7R8WA01#
				±0.1pF	GRM1885C2A7R8BA01#
				±0.25pF	GRM1885C2A7R8CA01#
			7.9pF	±0.05pF	GRM1885C2A7R9WA01#
				±0.1pF	GRM1885C2A7R9BA01#
				±0.25pF	GRM1885C2A7R9CA01#

Part number # indicates the package specification code.

GRM
 GR3
 GRJ
 GR4
 GR7
 GJM
 GQM
 GA2
 GA3 GB
 GA3 GD
 GA3 GF
 LLL
 LLA
 LLM
 LLR
 NFM
 KRM
 KR3
 GMA
 GMD
 ⚠Caution /Notice

GRM Series Temperature Compensating Type Part Number List

(→ 1.6×0.8mm)

T max.	Rated Voltage	TC Code	Cap.	Tol.	Part Number	T max.	Rated Voltage	TC Code	Cap.	Tol.	Part Number	
0.9mm	100Vdc	COG	8.0pF	±0.05pF	GRM1885C2A8R0WA01#	0.9mm	100Vdc	COG	9.3pF	±0.25pF	GRM1885C2A9R3CA01#	
				±0.1pF	GRM1885C2A8R0BA01#					±0.5pF	GRM1885C2A9R3DA01#	
				±0.25pF	GRM1885C2A8R0CA01#					9.4pF	±0.05pF	GRM1885C2A9R4WA01#
				±0.5pF	GRM1885C2A8R0DA01#						±0.1pF	GRM1885C2A9R4BA01#
			8.1pF	±0.05pF	GRM1885C2A8R1WA01#				±0.25pF		GRM1885C2A9R4CA01#	
				±0.1pF	GRM1885C2A8R1BA01#				±0.5pF		GRM1885C2A9R4DA01#	
				±0.25pF	GRM1885C2A8R1CA01#				9.5pF	±0.05pF	GRM1885C2A9R5WA01#	
				±0.5pF	GRM1885C2A8R1DA01#					±0.1pF	GRM1885C2A9R5BA01#	
			8.2pF	±0.05pF	GRM1885C2A8R2WA01#					±0.25pF	GRM1885C2A9R5CA01#	
				±0.1pF	GRM1885C2A8R2BA01#					±0.5pF	GRM1885C2A9R5DA01#	
				±0.25pF	GRM1885C2A8R2CA01#				9.6pF	±0.05pF	GRM1885C2A9R6WA01#	
				±0.5pF	GRM1885C2A8R2DA01#					±0.1pF	GRM1885C2A9R6BA01#	
			8.3pF	±0.05pF	GRM1885C2A8R3WA01#					±0.25pF	GRM1885C2A9R6CA01#	
				±0.1pF	GRM1885C2A8R3BA01#					±0.5pF	GRM1885C2A9R6DA01#	
				±0.25pF	GRM1885C2A8R3CA01#				9.7pF	±0.05pF	GRM1885C2A9R7WA01#	
				±0.5pF	GRM1885C2A8R3DA01#					±0.1pF	GRM1885C2A9R7BA01#	
			8.4pF	±0.05pF	GRM1885C2A8R4WA01#					±0.25pF	GRM1885C2A9R7CA01#	
				±0.1pF	GRM1885C2A8R4BA01#					±0.5pF	GRM1885C2A9R7DA01#	
				±0.25pF	GRM1885C2A8R4CA01#				9.8pF	±0.05pF	GRM1885C2A9R8WA01#	
				±0.5pF	GRM1885C2A8R4DA01#					±0.1pF	GRM1885C2A9R8BA01#	
			8.5pF	±0.05pF	GRM1885C2A8R5WA01#					±0.25pF	GRM1885C2A9R8CA01#	
				±0.1pF	GRM1885C2A8R5BA01#					±0.5pF	GRM1885C2A9R8DA01#	
				±0.25pF	GRM1885C2A8R5CA01#				9.9pF	±0.05pF	GRM1885C2A9R9WA01#	
				±0.5pF	GRM1885C2A8R5DA01#					±0.1pF	GRM1885C2A9R9BA01#	
			8.6pF	±0.05pF	GRM1885C2A8R6WA01#					±0.25pF	GRM1885C2A9R9CA01#	
				±0.1pF	GRM1885C2A8R6BA01#					±0.5pF	GRM1885C2A9R9DA01#	
				±0.25pF	GRM1885C2A8R6CA01#				10pF	±5%	GRM1885C2A100JA01#	
				±0.5pF	GRM1885C2A8R6DA01#				12pF	±5%	GRM1885C2A120JA01#	
			8.7pF	±0.05pF	GRM1885C2A8R7WA01#				15pF	±5%	GRM1885C2A150JA01#	
				±0.1pF	GRM1885C2A8R7BA01#				18pF	±5%	GRM1885C2A180JA01#	
				±0.25pF	GRM1885C2A8R7CA01#				22pF	±5%	GRM1885C2A220JA01#	
				±0.5pF	GRM1885C2A8R7DA01#				27pF	±5%	GRM1885C2A270JA01#	
			8.8pF	±0.05pF	GRM1885C2A8R8WA01#				33pF	±5%	GRM1885C2A330JA01#	
				±0.1pF	GRM1885C2A8R8BA01#				39pF	±5%	GRM1885C2A390JA01#	
				±0.25pF	GRM1885C2A8R8CA01#				47pF	±5%	GRM1885C2A470JA01#	
				±0.5pF	GRM1885C2A8R8DA01#				56pF	±5%	GRM1885C2A560JA01#	
			8.9pF	±0.05pF	GRM1885C2A8R9WA01#				68pF	±5%	GRM1885C2A680JA01#	
				±0.1pF	GRM1885C2A8R9BA01#				82pF	±5%	GRM1885C2A820JA01#	
				±0.25pF	GRM1885C2A8R9CA01#				100pF	±5%	GRM1885C2A101JA01#	
				±0.5pF	GRM1885C2A8R9DA01#				120pF	±5%	GRM1885C2A121JA01#	
			9.0pF	±0.05pF	GRM1885C2A9R0WA01#				150pF	±5%	GRM1885C2A151JA01#	
				±0.1pF	GRM1885C2A9R0BA01#				180pF	±5%	GRM1885C2A181JA01#	
				±0.25pF	GRM1885C2A9R0CA01#				220pF	±5%	GRM1885C2A221JA01#	
				±0.5pF	GRM1885C2A9R0DA01#				270pF	±5%	GRM1885C2A271JA01#	
			9.1pF	±0.05pF	GRM1885C2A9R1WA01#				330pF	±5%	GRM1885C2A331JA01#	
				±0.1pF	GRM1885C2A9R1BA01#				390pF	±5%	GRM1885C2A391JA01#	
				±0.25pF	GRM1885C2A9R1CA01#				470pF	±5%	GRM1885C2A471JA01#	
				±0.5pF	GRM1885C2A9R1DA01#				560pF	±5%	GRM1885C2A561JA01#	
			9.2pF	±0.05pF	GRM1885C2A9R2WA01#				680pF	±5%	GRM1885C2A681JA01#	
				±0.1pF	GRM1885C2A9R2BA01#				820pF	±5%	GRM1885C2A821JA01#	
				±0.25pF	GRM1885C2A9R2CA01#				1000pF	±5%	GRM1885C2A102JA01#	
				±0.5pF	GRM1885C2A9R2DA01#				1200pF	±5%	GRM1885C2A122JA01#	
			9.3pF	±0.05pF	GRM1885C2A9R3WA01#				1500pF	±5%	GRM1885C2A152JA01#	
				±0.1pF	GRM1885C2A9R3BA01#				CK	±0.05pF	GRM1884C2AR50WA01#	

Part number # indicates the package specification code.

GRM Series Temperature Compensating Type Part Number List

(→ 1.6×0.8mm)

T max.	Rated Voltage	TC Code	Cap.	Tol.	Part Number	T max.	Rated Voltage	TC Code	Cap.	Tol.	Part Number
0.9mm	100Vdc	CK	0.50pF	±0.1pF	GRM1884C2AR50BA01#	0.9mm	100Vdc	CJ	2.5pF	±0.05pF	GRM1883C2A2R5WA01#
				±0.05pF	GRM1884C2AR60WA01#					±0.1pF	GRM1883C2A2R5BA01#
				±0.1pF	GRM1884C2AR60BA01#					±0.25pF	GRM1883C2A2R5CA01#
			0.70pF	±0.05pF	GRM1884C2AR70WA01#				2.6pF	±0.05pF	GRM1883C2A2R6WA01#
				±0.1pF	GRM1884C2AR70BA01#					±0.1pF	GRM1883C2A2R6BA01#
				±0.25pF	GRM1884C2AR80WA01#					±0.25pF	GRM1883C2A2R6CA01#
			0.80pF	±0.05pF	GRM1884C2AR80WA01#				2.7pF	±0.05pF	GRM1883C2A2R7WA01#
				±0.1pF	GRM1884C2AR80BA01#					±0.1pF	GRM1883C2A2R7BA01#
				±0.25pF	GRM1884C2AR90WA01#					±0.25pF	GRM1883C2A2R7CA01#
			0.90pF	±0.05pF	GRM1884C2AR90WA01#				2.8pF	±0.05pF	GRM1883C2A2R8WA01#
				±0.1pF	GRM1884C2AR90BA01#					±0.1pF	GRM1883C2A2R8BA01#
				±0.25pF	GRM1884C2A1R0WA01#					±0.25pF	GRM1883C2A2R8CA01#
			1.0pF	±0.05pF	GRM1884C2A1R0WA01#				2.9pF	±0.05pF	GRM1883C2A2R9WA01#
				±0.1pF	GRM1884C2A1R0BA01#					±0.1pF	GRM1883C2A2R9BA01#
				±0.25pF	GRM1884C2A1R0CA01#					±0.25pF	GRM1883C2A2R9CA01#
			1.1pF	±0.05pF	GRM1884C2A1R1WA01#				3.0pF	±0.05pF	GRM1883C2A3R0WA01#
				±0.1pF	GRM1884C2A1R1BA01#					±0.1pF	GRM1883C2A3R0BA01#
				±0.25pF	GRM1884C2A1R1CA01#					±0.25pF	GRM1883C2A3R0CA01#
			1.2pF	±0.05pF	GRM1884C2A1R2WA01#				3.1pF	±0.05pF	GRM1883C2A3R1WA01#
				±0.1pF	GRM1884C2A1R2BA01#					±0.1pF	GRM1883C2A3R1BA01#
				±0.25pF	GRM1884C2A1R2CA01#					±0.25pF	GRM1883C2A3R1CA01#
			1.3pF	±0.05pF	GRM1884C2A1R3WA01#				3.2pF	±0.05pF	GRM1883C2A3R2WA01#
				±0.1pF	GRM1884C2A1R3BA01#					±0.1pF	GRM1883C2A3R2BA01#
				±0.25pF	GRM1884C2A1R3CA01#					±0.25pF	GRM1883C2A3R2CA01#
		1.4pF	±0.05pF	GRM1884C2A1R4WA01#	3.3pF	±0.05pF	GRM1883C2A3R3WA01#				
			±0.1pF	GRM1884C2A1R4BA01#		±0.1pF	GRM1883C2A3R3BA01#				
			±0.25pF	GRM1884C2A1R4CA01#		±0.25pF	GRM1883C2A3R3CA01#				
		1.5pF	±0.05pF	GRM1884C2A1R5WA01#	3.4pF	±0.05pF	GRM1883C2A3R4WA01#				
			±0.1pF	GRM1884C2A1R5BA01#		±0.1pF	GRM1883C2A3R4BA01#				
			±0.25pF	GRM1884C2A1R5CA01#		±0.25pF	GRM1883C2A3R4CA01#				
		1.6pF	±0.05pF	GRM1884C2A1R6WA01#	3.5pF	±0.05pF	GRM1883C2A3R5WA01#				
			±0.1pF	GRM1884C2A1R6BA01#		±0.1pF	GRM1883C2A3R5BA01#				
			±0.25pF	GRM1884C2A1R6CA01#		±0.25pF	GRM1883C2A3R5CA01#				
		1.7pF	±0.05pF	GRM1884C2A1R7WA01#	3.6pF	±0.05pF	GRM1883C2A3R6WA01#				
			±0.1pF	GRM1884C2A1R7BA01#		±0.1pF	GRM1883C2A3R6BA01#				
			±0.25pF	GRM1884C2A1R7CA01#		±0.25pF	GRM1883C2A3R6CA01#				
		1.8pF	±0.05pF	GRM1884C2A1R8WA01#	3.7pF	±0.05pF	GRM1883C2A3R7WA01#				
			±0.1pF	GRM1884C2A1R8BA01#		±0.1pF	GRM1883C2A3R7BA01#				
			±0.25pF	GRM1884C2A1R8CA01#		±0.25pF	GRM1883C2A3R7CA01#				
		1.9pF	±0.05pF	GRM1884C2A1R9WA01#	3.8pF	±0.05pF	GRM1883C2A3R8WA01#				
			±0.1pF	GRM1884C2A1R9BA01#		±0.1pF	GRM1883C2A3R8BA01#				
			±0.25pF	GRM1884C2A1R9CA01#		±0.25pF	GRM1883C2A3R8CA01#				
		2.0pF	±0.05pF	GRM1884C2A2R0WA01#	3.9pF	±0.05pF	GRM1883C2A3R9WA01#				
			±0.1pF	GRM1884C2A2R0BA01#		±0.1pF	GRM1883C2A3R9BA01#				
			±0.25pF	GRM1884C2A2R0CA01#		±0.25pF	GRM1883C2A3R9CA01#				
		CJ	100Vdc	CJ	2.1pF	±0.05pF	GRM1883C2A2R1WA01#	CH	4.0pF	±0.05pF	GRM1882C2A4R0WA01#
						±0.1pF	GRM1883C2A2R1BA01#			±0.1pF	GRM1882C2A4R0BA01#
						±0.25pF	GRM1883C2A2R1CA01#			±0.25pF	GRM1882C2A4R0CA01#
2.2pF	±0.05pF				GRM1883C2A2R2WA01#	4.1pF	±0.05pF		GRM1882C2A4R1WA01#		
	±0.1pF				GRM1883C2A2R2BA01#		±0.1pF		GRM1882C2A4R1BA01#		
	±0.25pF				GRM1883C2A2R2CA01#		±0.25pF		GRM1882C2A4R1CA01#		
2.3pF	±0.05pF				GRM1883C2A2R3WA01#	4.2pF	±0.05pF		GRM1882C2A4R2WA01#		
	±0.1pF				GRM1883C2A2R3BA01#		±0.1pF		GRM1882C2A4R2BA01#		
	±0.25pF				GRM1883C2A2R3CA01#		±0.25pF		GRM1882C2A4R2CA01#		
2.4pF	±0.05pF				GRM1883C2A2R4WA01#						
	±0.1pF				GRM1883C2A2R4BA01#						
	±0.25pF				GRM1883C2A2R4CA01#						

Part number # indicates the package specification code.



GRM Series Temperature Compensating Type Part Number List

(→ 1.6×0.8mm)

T max.	Rated Voltage	TC Code	Cap.	Tol.	Part Number
0.9mm	100Vdc	CH	4.3pF	±0.05pF	GRM1882C2A4R3WA01#
				±0.1pF	GRM1882C2A4R3BA01#
				±0.25pF	GRM1882C2A4R3CA01#
			4.4pF	±0.05pF	GRM1882C2A4R4WA01#
				±0.1pF	GRM1882C2A4R4BA01#
				±0.25pF	GRM1882C2A4R4CA01#
			4.5pF	±0.05pF	GRM1882C2A4R5WA01#
				±0.1pF	GRM1882C2A4R5BA01#
				±0.25pF	GRM1882C2A4R5CA01#
			4.6pF	±0.05pF	GRM1882C2A4R6WA01#
				±0.1pF	GRM1882C2A4R6BA01#
				±0.25pF	GRM1882C2A4R6CA01#
			4.7pF	±0.05pF	GRM1882C2A4R7WA01#
				±0.1pF	GRM1882C2A4R7BA01#
				±0.25pF	GRM1882C2A4R7CA01#
			4.8pF	±0.05pF	GRM1882C2A4R8WA01#
				±0.1pF	GRM1882C2A4R8BA01#
				±0.25pF	GRM1882C2A4R8CA01#
			4.9pF	±0.05pF	GRM1882C2A4R9WA01#
				±0.1pF	GRM1882C2A4R9BA01#
				±0.25pF	GRM1882C2A4R9CA01#
			5.0pF	±0.05pF	GRM1882C2A5R0WA01#
				±0.1pF	GRM1882C2A5R0BA01#
				±0.25pF	GRM1882C2A5R0CA01#
			5.1pF	±0.05pF	GRM1882C2A5R1WA01#
				±0.1pF	GRM1882C2A5R1BA01#
				±0.25pF	GRM1882C2A5R1CA01#
				±0.5pF	GRM1882C2A5R1DA01#
			5.2pF	±0.05pF	GRM1882C2A5R2WA01#
				±0.1pF	GRM1882C2A5R2BA01#
				±0.25pF	GRM1882C2A5R2CA01#
				±0.5pF	GRM1882C2A5R2DA01#
			5.3pF	±0.05pF	GRM1882C2A5R3WA01#
				±0.1pF	GRM1882C2A5R3BA01#
				±0.25pF	GRM1882C2A5R3CA01#
				±0.5pF	GRM1882C2A5R3DA01#
			5.4pF	±0.05pF	GRM1882C2A5R4WA01#
				±0.1pF	GRM1882C2A5R4BA01#
				±0.25pF	GRM1882C2A5R4CA01#
				±0.5pF	GRM1882C2A5R4DA01#
			5.5pF	±0.05pF	GRM1882C2A5R5WA01#
				±0.1pF	GRM1882C2A5R5BA01#
				±0.25pF	GRM1882C2A5R5CA01#
				±0.5pF	GRM1882C2A5R5DA01#
			5.6pF	±0.05pF	GRM1882C2A5R6WA01#
				±0.1pF	GRM1882C2A5R6BA01#
				±0.25pF	GRM1882C2A5R6CA01#
				±0.5pF	GRM1882C2A5R6DA01#
			5.7pF	±0.05pF	GRM1882C2A5R7WA01#
				±0.1pF	GRM1882C2A5R7BA01#
				±0.25pF	GRM1882C2A5R7CA01#
				±0.5pF	GRM1882C2A5R7DA01#
			5.8pF	±0.05pF	GRM1882C2A5R8WA01#
				±0.1pF	GRM1882C2A5R8BA01#

T max.	Rated Voltage	TC Code	Cap.	Tol.	Part Number		
0.9mm	100Vdc	CH	5.8pF	±0.25pF	GRM1882C2A5R8CA01#		
				±0.5pF	GRM1882C2A5R8DA01#		
			5.9pF	±0.05pF	GRM1882C2A5R9WA01#		
				±0.1pF	GRM1882C2A5R9BA01#		
				±0.25pF	GRM1882C2A5R9CA01#		
			6.0pF	±0.05pF	GRM1882C2A6R0WA01#		
				±0.1pF	GRM1882C2A6R0BA01#		
				±0.25pF	GRM1882C2A6R0CA01#		
			6.1pF	±0.05pF	GRM1882C2A6R1WA01#		
				±0.1pF	GRM1882C2A6R1BA01#		
				±0.25pF	GRM1882C2A6R1CA01#		
			6.2pF	±0.05pF	GRM1882C2A6R2WA01#		
				±0.1pF	GRM1882C2A6R2BA01#		
				±0.25pF	GRM1882C2A6R2CA01#		
				±0.5pF	GRM1882C2A6R2DA01#		
			6.3pF	±0.05pF	GRM1882C2A6R3WA01#		
				±0.1pF	GRM1882C2A6R3BA01#		
				±0.25pF	GRM1882C2A6R3CA01#		
				±0.5pF	GRM1882C2A6R3DA01#		
			6.4pF	±0.05pF	GRM1882C2A6R4WA01#		
				±0.1pF	GRM1882C2A6R4BA01#		
				±0.25pF	GRM1882C2A6R4CA01#		
				±0.5pF	GRM1882C2A6R4DA01#		
			6.5pF	±0.05pF	GRM1882C2A6R5WA01#		
				±0.1pF	GRM1882C2A6R5BA01#		
				±0.25pF	GRM1882C2A6R5CA01#		
				±0.5pF	GRM1882C2A6R5DA01#		
			6.6pF	±0.05pF	GRM1882C2A6R6WA01#		
				±0.1pF	GRM1882C2A6R6BA01#		
				±0.25pF	GRM1882C2A6R6CA01#		
				±0.5pF	GRM1882C2A6R6DA01#		
			6.7pF	±0.05pF	GRM1882C2A6R7WA01#		
				±0.1pF	GRM1882C2A6R7BA01#		
				±0.25pF	GRM1882C2A6R7CA01#		
				±0.5pF	GRM1882C2A6R7DA01#		
			6.8pF	±0.05pF	GRM1882C2A6R8WA01#		
				±0.1pF	GRM1882C2A6R8BA01#		
				±0.25pF	GRM1882C2A6R8CA01#		
				±0.5pF	GRM1882C2A6R8DA01#		
			6.9pF	±0.05pF	GRM1882C2A6R9WA01#		
				±0.1pF	GRM1882C2A6R9BA01#		
				±0.25pF	GRM1882C2A6R9CA01#		
			7.0pF	±0.05pF	GRM1882C2A7R0WA01#		
				±0.1pF	GRM1882C2A7R0BA01#		
				±0.25pF	GRM1882C2A7R0CA01#		
			7.1pF	±0.05pF	GRM1882C2A7R1WA01#		
				±0.1pF	GRM1882C2A7R1BA01#		
				±0.25pF	GRM1882C2A7R1CA01#		
						±0.5pF	GRM1882C2A7R1DA01#

- GRM
- GR3
- GRJ
- GR4
- GR7
- GJM
- GQM
- GA2
- GA3 GB
- GA3 GD
- GA3 GF
- LLL
- LLA
- LLM
- LLR
- NFM
- KRM
- KR3
- GMA
- GMD
- ⚠Caution /Notice

Part number # indicates the package specification code.

GRM Series Temperature Compensating Type Part Number List

(→ 1.6×0.8mm)

T max.	Rated Voltage	TC Code	Cap.	Tol.	Part Number
0.9mm	100Vdc	CH	7.2pF	±0.05pF	GRM1882C2A7R2WA01#
				±0.1pF	GRM1882C2A7R2BA01#
				±0.25pF	GRM1882C2A7R2CA01#
				±0.5pF	GRM1882C2A7R2DA01#
			7.3pF	±0.05pF	GRM1882C2A7R3WA01#
				±0.1pF	GRM1882C2A7R3BA01#
				±0.25pF	GRM1882C2A7R3CA01#
				±0.5pF	GRM1882C2A7R3DA01#
			7.4pF	±0.05pF	GRM1882C2A7R4WA01#
				±0.1pF	GRM1882C2A7R4BA01#
				±0.25pF	GRM1882C2A7R4CA01#
				±0.5pF	GRM1882C2A7R4DA01#
			7.5pF	±0.05pF	GRM1882C2A7R5WA01#
				±0.1pF	GRM1882C2A7R5BA01#
				±0.25pF	GRM1882C2A7R5CA01#
				±0.5pF	GRM1882C2A7R5DA01#
			7.6pF	±0.05pF	GRM1882C2A7R6WA01#
				±0.1pF	GRM1882C2A7R6BA01#
				±0.25pF	GRM1882C2A7R6CA01#
				±0.5pF	GRM1882C2A7R6DA01#
			7.7pF	±0.05pF	GRM1882C2A7R7WA01#
				±0.1pF	GRM1882C2A7R7BA01#
				±0.25pF	GRM1882C2A7R7CA01#
				±0.5pF	GRM1882C2A7R7DA01#
			7.8pF	±0.05pF	GRM1882C2A7R8WA01#
				±0.1pF	GRM1882C2A7R8BA01#
				±0.25pF	GRM1882C2A7R8CA01#
				±0.5pF	GRM1882C2A7R8DA01#
			7.9pF	±0.05pF	GRM1882C2A7R9WA01#
				±0.1pF	GRM1882C2A7R9BA01#
				±0.25pF	GRM1882C2A7R9CA01#
				±0.5pF	GRM1882C2A7R9DA01#
			8.0pF	±0.05pF	GRM1882C2A8R0WA01#
				±0.1pF	GRM1882C2A8R0BA01#
				±0.25pF	GRM1882C2A8R0CA01#
				±0.5pF	GRM1882C2A8R0DA01#
			8.1pF	±0.05pF	GRM1882C2A8R1WA01#
				±0.1pF	GRM1882C2A8R1BA01#
				±0.25pF	GRM1882C2A8R1CA01#
				±0.5pF	GRM1882C2A8R1DA01#
			8.2pF	±0.05pF	GRM1882C2A8R2WA01#
				±0.1pF	GRM1882C2A8R2BA01#
				±0.25pF	GRM1882C2A8R2CA01#
				±0.5pF	GRM1882C2A8R2DA01#
			8.3pF	±0.05pF	GRM1882C2A8R3WA01#
				±0.1pF	GRM1882C2A8R3BA01#
				±0.25pF	GRM1882C2A8R3CA01#
				±0.5pF	GRM1882C2A8R3DA01#
			8.4pF	±0.05pF	GRM1882C2A8R4WA01#
				±0.1pF	GRM1882C2A8R4BA01#
				±0.25pF	GRM1882C2A8R4CA01#
				±0.5pF	GRM1882C2A8R4DA01#
			8.5pF	±0.05pF	GRM1882C2A8R5WA01#
				±0.1pF	GRM1882C2A8R5BA01#

T max.	Rated Voltage	TC Code	Cap.	Tol.	Part Number
0.9mm	100Vdc	CH	8.5pF	±0.25pF	GRM1882C2A8R5CA01#
				±0.5pF	GRM1882C2A8R5DA01#
			8.6pF	±0.05pF	GRM1882C2A8R6WA01#
				±0.1pF	GRM1882C2A8R6BA01#
				±0.25pF	GRM1882C2A8R6CA01#
			8.7pF	±0.05pF	GRM1882C2A8R7WA01#
				±0.1pF	GRM1882C2A8R7BA01#
				±0.25pF	GRM1882C2A8R7CA01#
			8.8pF	±0.05pF	GRM1882C2A8R8WA01#
				±0.1pF	GRM1882C2A8R8BA01#
				±0.25pF	GRM1882C2A8R8CA01#
			8.9pF	±0.05pF	GRM1882C2A8R9WA01#
				±0.1pF	GRM1882C2A8R9BA01#
				±0.25pF	GRM1882C2A8R9CA01#
			9.0pF	±0.05pF	GRM1882C2A9R0WA01#
				±0.1pF	GRM1882C2A9R0BA01#
				±0.25pF	GRM1882C2A9R0CA01#
			9.1pF	±0.05pF	GRM1882C2A9R1WA01#
				±0.1pF	GRM1882C2A9R1BA01#
				±0.25pF	GRM1882C2A9R1CA01#
			9.2pF	±0.05pF	GRM1882C2A9R2WA01#
				±0.1pF	GRM1882C2A9R2BA01#
				±0.25pF	GRM1882C2A9R2CA01#
			9.3pF	±0.05pF	GRM1882C2A9R3WA01#
				±0.1pF	GRM1882C2A9R3BA01#
				±0.25pF	GRM1882C2A9R3CA01#
			9.4pF	±0.05pF	GRM1882C2A9R4WA01#
				±0.1pF	GRM1882C2A9R4BA01#
				±0.25pF	GRM1882C2A9R4CA01#
			9.5pF	±0.05pF	GRM1882C2A9R5WA01#
				±0.1pF	GRM1882C2A9R5BA01#
				±0.25pF	GRM1882C2A9R5CA01#
			9.6pF	±0.05pF	GRM1882C2A9R6WA01#
				±0.1pF	GRM1882C2A9R6BA01#
				±0.25pF	GRM1882C2A9R6CA01#
			9.7pF	±0.05pF	GRM1882C2A9R7WA01#
				±0.1pF	GRM1882C2A9R7BA01#
				±0.25pF	GRM1882C2A9R7CA01#
			9.8pF	±0.05pF	GRM1882C2A9R8WA01#
				±0.1pF	GRM1882C2A9R8BA01#
				±0.25pF	GRM1882C2A9R8CA01#

Part number # indicates the package specification code.

GRM
 GR3
 GRJ
 GR4
 GR7
 GJM
 GQM
 GA2
 GA3 GB
 GA3 GD
 GA3 GF
 LLL
 LLA
 LLM
 LLR
 NFM
 KRM
 KR3
 GMA
 GMD
 ⚠Caution /Notice

GRM Series Temperature Compensating Type Part Number List

(→ 1.6×0.8mm)

T max.	Rated Voltage	TC Code	Cap.	Tol.	Part Number	T max.	Rated Voltage	TC Code	Cap.	Tol.	Part Number			
0.9mm	100Vdc	CH	9.9pF	±0.05pF	GRM1882C2A9R9WA01#	0.9mm	50Vdc	COG	1.4pF	±0.1pF	GRM1885C1H1R4BA01#			
				±0.1pF	GRM1882C2A9R9BA01#					±0.25pF	GRM1885C1H1R4CA01#			
				±0.25pF	GRM1882C2A9R9CA01#					1.5pF	±0.05pF	GRM1885C1H1R5WA01#		
				±0.5pF	GRM1882C2A9R9DA01#						±0.1pF	GRM1885C1H1R5BA01#		
			10pF	±5%	GRM1882C2A100JA01#				1.6pF	±0.05pF	GRM1885C1H1R6WA01#			
				±5%	GRM1882C2A120JA01#					±0.1pF	GRM1885C1H1R6BA01#			
			15pF	±5%	GRM1882C2A150JA01#				1.7pF	±0.25pF	GRM1885C1H1R6CA01#			
			18pF	±5%	GRM1882C2A180JA01#					±0.05pF	GRM1885C1H1R7WA01#			
			22pF	±5%	GRM1882C2A220JA01#				±0.1pF	GRM1885C1H1R7BA01#				
			27pF	±5%	GRM1882C2A270JA01#				±0.25pF	GRM1885C1H1R7CA01#				
			33pF	±5%	GRM1882C2A330JA01#				1.8pF	±0.05pF	GRM1885C1H1R8WA01#			
			39pF	±5%	GRM1882C2A390JA01#					±0.1pF	GRM1885C1H1R8BA01#			
			47pF	±5%	GRM1882C2A470JA01#				±0.25pF	GRM1885C1H1R8CA01#				
			56pF	±5%	GRM1882C2A560JA01#				1.9pF	±0.05pF	GRM1885C1H1R9WA01#			
			68pF	±5%	GRM1882C2A680JA01#					±0.1pF	GRM1885C1H1R9BA01#			
			82pF	±5%	GRM1882C2A820JA01#				±0.25pF	GRM1885C1H1R9CA01#				
			100pF	±5%	GRM1882C2A101JA01#				2.0pF	±0.05pF	GRM1885C1H2R0WA01#			
			120pF	±5%	GRM1882C2A121JA01#					±0.1pF	GRM1885C1H2R0BA01#			
			150pF	±5%	GRM1882C2A151JA01#				±0.25pF	GRM1885C1H2R0CA01#				
			180pF	±5%	GRM1882C2A181JA01#				2.1pF	±0.05pF	GRM1885C1H2R1WA01#			
			220pF	±5%	GRM1882C2A221JA01#					±0.1pF	GRM1885C1H2R1BA01#			
			270pF	±5%	GRM1882C2A271JA01#				±0.25pF	GRM1885C1H2R1CA01#				
			330pF	±5%	GRM1882C2A331JA01#				2.2pF	±0.05pF	GRM1885C1H2R2WA01#			
			390pF	±5%	GRM1882C2A391JA01#					±0.1pF	GRM1885C1H2R2BA01#			
			470pF	±5%	GRM1882C2A471JA01#				±0.25pF	GRM1885C1H2R2CA01#				
			560pF	±5%	GRM1882C2A561JA01#				2.3pF	±0.05pF	GRM1885C1H2R3WA01#			
			680pF	±5%	GRM1882C2A681JA01#					±0.1pF	GRM1885C1H2R3BA01#			
			820pF	±5%	GRM1882C2A821JA01#				±0.25pF	GRM1885C1H2R3CA01#				
			1000pF	±5%	GRM1882C2A102JA01#				2.4pF	±0.05pF	GRM1885C1H2R4WA01#			
			1200pF	±5%	GRM1882C2A122JA01#					±0.1pF	GRM1885C1H2R4BA01#			
			1500pF	±5%	GRM1882C2A152JA01#				±0.25pF	GRM1885C1H2R4CA01#				
			50Vdc	COG	0.50pF				±0.05pF	GRM1885C1HR50WA01#	2.5pF	±0.05pF	GRM1885C1H2R5WA01#	
									±0.1pF	GRM1885C1HR50BA01#		±0.1pF	GRM1885C1H2R5BA01#	
									±0.25pF	GRM1885C1HR60WA01#		±0.25pF	GRM1885C1H2R5CA01#	
									±0.5pF	GRM1885C1HR60BA01#		2.6pF	±0.05pF	GRM1885C1H2R6WA01#
					±0.1pF				GRM1885C1HR70WA01#	±0.1pF			GRM1885C1H2R6BA01#	
					±0.25pF				GRM1885C1HR70BA01#	±0.25pF		GRM1885C1H2R6CA01#		
					0.80pF				±0.05pF	GRM1885C1HR80WA01#		2.7pF	±0.05pF	GRM1885C1H2R7WA01#
					±0.1pF				GRM1885C1HR80BA01#	±0.1pF			GRM1885C1H2R7BA01#	
					±0.25pF				GRM1885C1HR90WA01#	±0.25pF		GRM1885C1H2R7CA01#		
					0.90pF				±0.05pF	GRM1885C1HR90WA01#		2.8pF	±0.05pF	GRM1885C1H2R8WA01#
					±0.1pF				GRM1885C1HR90BA01#	±0.1pF			GRM1885C1H2R8BA01#	
					±0.25pF				GRM1885C1H1R0WA01#	±0.25pF		GRM1885C1H2R8CA01#		
					1.0pF				±0.05pF	GRM1885C1H1R0WA01#		2.9pF	±0.05pF	GRM1885C1H2R9WA01#
									±0.1pF	GRM1885C1H1R0BA01#			±0.1pF	GRM1885C1H2R9BA01#
±0.25pF	GRM1885C1H1R0CA01#	±0.25pF				GRM1885C1H2R9CA01#								
1.1pF	±0.05pF	GRM1885C1H1R1WA01#			3.0pF	±0.05pF	GRM1885C1H3R0WA01#							
	±0.1pF	GRM1885C1H1R1BA01#				±0.1pF	GRM1885C1H3R0BA01#							
	±0.25pF	GRM1885C1H1R1CA01#				±0.25pF	GRM1885C1H3R0CA01#							
1.2pF	±0.05pF	GRM1885C1H1R2WA01#			3.1pF	±0.05pF	GRM1885C1H3R1WA01#							
	±0.1pF	GRM1885C1H1R2BA01#				±0.1pF	GRM1885C1H3R1BA01#							
	±0.25pF	GRM1885C1H1R2CA01#				±0.25pF	GRM1885C1H3R1CA01#							
1.3pF	±0.05pF	GRM1885C1H1R3WA01#			3.2pF	±0.05pF	GRM1885C1H3R2WA01#							
	±0.1pF	GRM1885C1H1R3BA01#												
	±0.25pF	GRM1885C1H1R3CA01#												
1.4pF	±0.05pF	GRM1885C1H1R4WA01#												

GRM
 GR3
 GRJ
 GRU
 GR4
 GR7
 GJM
 GQM
 GA2
 GA3 GB
 GA3 GD
 GA3 GF
 LLL
 LLA
 LLM
 LLR
 NFM
 KRM
 KR3
 GMA
 GMD
 ⚠Caution / Notice

Part number # indicates the package specification code.

GRM Series Temperature Compensating Type Part Number List

(→ 1.6×0.8mm)

T max.	Rated Voltage	TC Code	Cap.	Tol.	Part Number	T max.	Rated Voltage	TC Code	Cap.	Tol.	Part Number
0.9mm	50Vdc	COG	3.2pF	±0.1pF	GRM1885C1H3R2BA01#	0.9mm	50Vdc	COG	5.0pF	±0.1pF	GRM1885C1H5R0BA01#
				±0.25pF	GRM1885C1H3R2CA01#					±0.25pF	GRM1885C1H5R0CA01#
			3.3pF	±0.05pF	GRM1885C1H3R3WA01#	5.1pF			±0.05pF	GRM1885C1H5R1WA01#	
				±0.1pF	GRM1885C1H3R3BA01#				±0.1pF	GRM1885C1H5R1BA01#	
				±0.25pF	GRM1885C1H3R3CA01#				±0.25pF	GRM1885C1H5R1CA01#	
			3.4pF	±0.05pF	GRM1885C1H3R4WA01#	5.2pF			±0.05pF	GRM1885C1H5R2WA01#	
				±0.1pF	GRM1885C1H3R4BA01#				±0.1pF	GRM1885C1H5R2BA01#	
				±0.25pF	GRM1885C1H3R4CA01#				±0.25pF	GRM1885C1H5R2CA01#	
			3.5pF	±0.05pF	GRM1885C1H3R5WA01#	5.3pF			±0.05pF	GRM1885C1H5R3WA01#	
				±0.1pF	GRM1885C1H3R5BA01#				±0.1pF	GRM1885C1H5R3BA01#	
				±0.25pF	GRM1885C1H3R5CA01#				±0.25pF	GRM1885C1H5R3CA01#	
			3.6pF	±0.05pF	GRM1885C1H3R6WA01#	5.4pF			±0.05pF	GRM1885C1H5R4WA01#	
				±0.1pF	GRM1885C1H3R6BA01#				±0.1pF	GRM1885C1H5R4BA01#	
				±0.25pF	GRM1885C1H3R6CA01#				±0.25pF	GRM1885C1H5R4CA01#	
			3.7pF	±0.05pF	GRM1885C1H3R7WA01#	5.5pF			±0.05pF	GRM1885C1H5R5WA01#	
				±0.1pF	GRM1885C1H3R7BA01#				±0.1pF	GRM1885C1H5R5BA01#	
				±0.25pF	GRM1885C1H3R7CA01#				±0.25pF	GRM1885C1H5R5CA01#	
			3.8pF	±0.05pF	GRM1885C1H3R8WA01#	5.6pF			±0.05pF	GRM1885C1H5R6WA01#	
				±0.1pF	GRM1885C1H3R8BA01#				±0.1pF	GRM1885C1H5R6BA01#	
				±0.25pF	GRM1885C1H3R8CA01#				±0.25pF	GRM1885C1H5R6CA01#	
			3.9pF	±0.05pF	GRM1885C1H3R9WA01#	5.7pF			±0.05pF	GRM1885C1H5R7WA01#	
				±0.1pF	GRM1885C1H3R9BA01#				±0.1pF	GRM1885C1H5R7BA01#	
				±0.25pF	GRM1885C1H3R9CA01#				±0.25pF	GRM1885C1H5R7CA01#	
			4.0pF	±0.05pF	GRM1885C1H4R0WA01#	5.8pF			±0.05pF	GRM1885C1H5R8WA01#	
				±0.1pF	GRM1885C1H4R0BA01#				±0.1pF	GRM1885C1H5R8BA01#	
				±0.25pF	GRM1885C1H4R0CA01#				±0.25pF	GRM1885C1H5R8CA01#	
			4.1pF	±0.05pF	GRM1885C1H4R1WA01#	5.9pF			±0.05pF	GRM1885C1H5R9WA01#	
				±0.1pF	GRM1885C1H4R1BA01#				±0.1pF	GRM1885C1H5R9BA01#	
				±0.25pF	GRM1885C1H4R1CA01#				±0.25pF	GRM1885C1H5R9CA01#	
			4.2pF	±0.05pF	GRM1885C1H4R2WA01#	6.0pF			±0.05pF	GRM1885C1H6R0WA01#	
				±0.1pF	GRM1885C1H4R2BA01#				±0.1pF	GRM1885C1H6R0BA01#	
				±0.25pF	GRM1885C1H4R2CA01#				±0.25pF	GRM1885C1H6R0CA01#	
			4.3pF	±0.05pF	GRM1885C1H4R3WA01#	6.1pF			±0.05pF	GRM1885C1H6R1WA01#	
				±0.1pF	GRM1885C1H4R3BA01#				±0.1pF	GRM1885C1H6R1BA01#	
				±0.25pF	GRM1885C1H4R3CA01#				±0.25pF	GRM1885C1H6R1CA01#	
			4.4pF	±0.05pF	GRM1885C1H4R4WA01#	6.2pF			±0.05pF	GRM1885C1H6R2WA01#	
				±0.1pF	GRM1885C1H4R4BA01#				±0.1pF	GRM1885C1H6R2BA01#	
				±0.25pF	GRM1885C1H4R4CA01#				±0.25pF	GRM1885C1H6R2CA01#	
			4.5pF	±0.05pF	GRM1885C1H4R5WA01#	6.3pF			±0.05pF	GRM1885C1H6R3WA01#	
				±0.1pF	GRM1885C1H4R5BA01#				±0.1pF	GRM1885C1H6R3BA01#	
				±0.25pF	GRM1885C1H4R5CA01#				±0.25pF	GRM1885C1H6R3CA01#	
			4.6pF	±0.05pF	GRM1885C1H4R6WA01#	5.0pF			±0.05pF	GRM1885C1H5R0WA01#	
				±0.1pF	GRM1885C1H4R6BA01#				±0.1pF	GRM1885C1H5R0BA01#	
				±0.25pF	GRM1885C1H4R6CA01#				±0.25pF	GRM1885C1H5R0CA01#	
			4.7pF	±0.05pF	GRM1885C1H4R7WA01#						
				±0.1pF	GRM1885C1H4R7BA01#						
				±0.25pF	GRM1885C1H4R7CA01#						
			4.8pF	±0.05pF	GRM1885C1H4R8WA01#						
				±0.1pF	GRM1885C1H4R8BA01#						
				±0.25pF	GRM1885C1H4R8CA01#						
4.9pF	±0.05pF	GRM1885C1H4R9WA01#									
	±0.1pF	GRM1885C1H4R9BA01#									
	±0.25pF	GRM1885C1H4R9CA01#									

Part number # indicates the package specification code.

GRM Series Temperature Compensating Type Part Number List

(→ 1.6×0.8mm)

T max.	Rated Voltage	TC Code	Cap.	Tol.	Part Number	T max.	Rated Voltage	TC Code	Cap.	Tol.	Part Number	
0.9mm	50Vdc	COG	6.4pF	±0.05pF	GRM1885C1H6R4WA01#	0.9mm	50Vdc	COG	7.7pF	±0.25pF	GRM1885C1H7R7CA01#	
				±0.1pF	GRM1885C1H6R4BA01#					±0.5pF	GRM1885C1H7R7DA01#	
				±0.25pF	GRM1885C1H6R4CA01#					7.8pF	±0.05pF	GRM1885C1H7R8WA01#
				±0.5pF	GRM1885C1H6R4DA01#						±0.1pF	GRM1885C1H7R8BA01#
			6.5pF	±0.05pF	GRM1885C1H6R5WA01#				±0.25pF	GRM1885C1H7R8CA01#		
				±0.1pF	GRM1885C1H6R5BA01#				±0.5pF	GRM1885C1H7R8DA01#		
				±0.25pF	GRM1885C1H6R5CA01#				7.9pF	±0.05pF	GRM1885C1H7R9WA01#	
				±0.5pF	GRM1885C1H6R5DA01#					±0.1pF	GRM1885C1H7R9BA01#	
			6.6pF	±0.05pF	GRM1885C1H6R6WA01#				±0.25pF	GRM1885C1H7R9CA01#		
				±0.1pF	GRM1885C1H6R6BA01#				±0.5pF	GRM1885C1H7R9DA01#		
				±0.25pF	GRM1885C1H6R6CA01#				8.0pF	±0.05pF	GRM1885C1H8R0WA01#	
				±0.5pF	GRM1885C1H6R6DA01#					±0.1pF	GRM1885C1H8R0BA01#	
			6.7pF	±0.05pF	GRM1885C1H6R7WA01#				±0.25pF	GRM1885C1H8R0CA01#		
				±0.1pF	GRM1885C1H6R7BA01#				±0.5pF	GRM1885C1H8R0DA01#		
				±0.25pF	GRM1885C1H6R7CA01#				8.1pF	±0.05pF	GRM1885C1H8R1WA01#	
				±0.5pF	GRM1885C1H6R7DA01#					±0.1pF	GRM1885C1H8R1BA01#	
			6.8pF	±0.05pF	GRM1885C1H6R8WA01#				±0.25pF	GRM1885C1H8R1CA01#		
				±0.1pF	GRM1885C1H6R8BA01#				±0.5pF	GRM1885C1H8R1DA01#		
				±0.25pF	GRM1885C1H6R8CA01#				8.2pF	±0.05pF	GRM1885C1H8R2WA01#	
				±0.5pF	GRM1885C1H6R8DA01#					±0.1pF	GRM1885C1H8R2BA01#	
			6.9pF	±0.05pF	GRM1885C1H6R9WA01#				±0.25pF	GRM1885C1H8R2CA01#		
				±0.1pF	GRM1885C1H6R9BA01#				±0.5pF	GRM1885C1H8R2DA01#		
				±0.25pF	GRM1885C1H6R9CA01#				8.3pF	±0.05pF	GRM1885C1H8R3WA01#	
				±0.5pF	GRM1885C1H6R9DA01#					±0.1pF	GRM1885C1H8R3BA01#	
			7.0pF	±0.05pF	GRM1885C1H7R0WA01#				±0.25pF	GRM1885C1H8R3CA01#		
				±0.1pF	GRM1885C1H7R0BA01#				±0.5pF	GRM1885C1H8R3DA01#		
				±0.25pF	GRM1885C1H7R0CA01#				8.4pF	±0.05pF	GRM1885C1H8R4WA01#	
				±0.5pF	GRM1885C1H7R0DA01#					±0.1pF	GRM1885C1H8R4BA01#	
			7.1pF	±0.05pF	GRM1885C1H7R1WA01#				±0.25pF	GRM1885C1H8R4CA01#		
				±0.1pF	GRM1885C1H7R1BA01#				±0.5pF	GRM1885C1H8R4DA01#		
				±0.25pF	GRM1885C1H7R1CA01#				8.5pF	±0.05pF	GRM1885C1H8R5WA01#	
				±0.5pF	GRM1885C1H7R1DA01#					±0.1pF	GRM1885C1H8R5BA01#	
			7.2pF	±0.05pF	GRM1885C1H7R2WA01#				±0.25pF	GRM1885C1H8R5CA01#		
				±0.1pF	GRM1885C1H7R2BA01#				±0.5pF	GRM1885C1H8R5DA01#		
				±0.25pF	GRM1885C1H7R2CA01#				8.6pF	±0.05pF	GRM1885C1H8R6WA01#	
				±0.5pF	GRM1885C1H7R2DA01#					±0.1pF	GRM1885C1H8R6BA01#	
			7.3pF	±0.05pF	GRM1885C1H7R3WA01#				±0.25pF	GRM1885C1H8R6CA01#		
				±0.1pF	GRM1885C1H7R3BA01#				±0.5pF	GRM1885C1H8R6DA01#		
				±0.25pF	GRM1885C1H7R3CA01#				8.7pF	±0.05pF	GRM1885C1H8R7WA01#	
				±0.5pF	GRM1885C1H7R3DA01#					±0.1pF	GRM1885C1H8R7BA01#	
			7.4pF	±0.05pF	GRM1885C1H7R4WA01#				±0.25pF	GRM1885C1H8R7CA01#		
				±0.1pF	GRM1885C1H7R4BA01#				±0.5pF	GRM1885C1H8R7DA01#		
				±0.25pF	GRM1885C1H7R4CA01#				8.8pF	±0.05pF	GRM1885C1H8R8WA01#	
				±0.5pF	GRM1885C1H7R4DA01#					±0.1pF	GRM1885C1H8R8BA01#	
			7.5pF	±0.05pF	GRM1885C1H7R5WA01#				±0.25pF	GRM1885C1H8R8CA01#		
				±0.1pF	GRM1885C1H7R5BA01#				±0.5pF	GRM1885C1H8R8DA01#		
				±0.25pF	GRM1885C1H7R5CA01#				8.9pF	±0.05pF	GRM1885C1H8R9WA01#	
				±0.5pF	GRM1885C1H7R5DA01#					±0.1pF	GRM1885C1H8R9BA01#	
			7.6pF	±0.05pF	GRM1885C1H7R6WA01#				±0.25pF	GRM1885C1H8R9CA01#		
				±0.1pF	GRM1885C1H7R6BA01#				±0.5pF	GRM1885C1H8R9DA01#		
				±0.25pF	GRM1885C1H7R6CA01#				9.0pF	±0.05pF	GRM1885C1H9R0WA01#	
				±0.5pF	GRM1885C1H7R6DA01#					±0.1pF	GRM1885C1H9R0BA01#	
			7.7pF	±0.05pF	GRM1885C1H7R7WA01#				±0.25pF	GRM1885C1H9R0CA01#		
				±0.1pF	GRM1885C1H7R7BA01#				±0.5pF	GRM1885C1H9R0DA01#		

GRM
 GR3
 GRJ
 GRU
 GR4
 GR7
 GJM
 GQM
 GA2
 GA3 GB
 GA3 GD
 GA3 GF
 LLL
 LLA
 LLM
 LLR
 NFM
 KRM
 KR3
 GMA
 GMD
 ⚠Caution /Notice

Part number # indicates the package specification code.

GRM Series Temperature Compensating Type Part Number List

(→ 1.6×0.8mm)

T max.	Rated Voltage	TC Code	Cap.	Tol.	Part Number	T max.	Rated Voltage	TC Code	Cap.	Tol.	Part Number	
0.9mm	50Vdc	COG	9.1pF	±0.05pF	GRM1885C1H9R1WA01#	0.9mm	50Vdc	COG	330pF	±5%	GRM1885C1H331JA01#	
				±0.1pF	GRM1885C1H9R1BA01#					390pF	±5%	GRM1885C1H391JA01#
				±0.25pF	GRM1885C1H9R1CA01#					470pF	±5%	GRM1885C1H471JA01#
				±0.5pF	GRM1885C1H9R1DA01#					560pF	±5%	GRM1885C1H561JA01#
			9.2pF	±0.05pF	GRM1885C1H9R2WA01#				680pF	±5%	GRM1885C1H681JA01#	
				±0.1pF	GRM1885C1H9R2BA01#				820pF	±5%	GRM1885C1H821JA01#	
				±0.25pF	GRM1885C1H9R2CA01#				1000pF	±5%	GRM1885C1H102JA01#	
				±0.5pF	GRM1885C1H9R2DA01#				1200pF	±5%	GRM1885C1H122JA01#	
			9.3pF	±0.05pF	GRM1885C1H9R3WA01#				1500pF	±5%	GRM1885C1H152JA01#	
				±0.1pF	GRM1885C1H9R3BA01#				1800pF	±5%	GRM1885C1H182JA01#	
				±0.25pF	GRM1885C1H9R3CA01#				2200pF	±5%	GRM1885C1H222JA01#	
				±0.5pF	GRM1885C1H9R3DA01#				2700pF	±5%	GRM1885C1H272JA01#	
			9.4pF	±0.05pF	GRM1885C1H9R4WA01#				3300pF	±5%	GRM1885C1H332JA01#	
				±0.1pF	GRM1885C1H9R4BA01#				3900pF	±5%	GRM1885C1H392JA01#	
				±0.25pF	GRM1885C1H9R4CA01#				4700pF	±5%	GRM1885C1H472JA01#	
				±0.5pF	GRM1885C1H9R4DA01#				5600pF	±5%	GRM1885C1H562JA01#	
			9.5pF	±0.05pF	GRM1885C1H9R5WA01#				6800pF	±5%	GRM1885C1H682JA01#	
				±0.1pF	GRM1885C1H9R5BA01#				8200pF	±5%	GRM1885C1H822JA01#	
				±0.25pF	GRM1885C1H9R5CA01#				10000pF	±5%	GRM1885C1H103JA01#	
				±0.5pF	GRM1885C1H9R5DA01#				CK	0.50pF	±0.05pF	GRM1884C1HR50WA01#
			9.6pF	±0.05pF	GRM1885C1H9R6WA01#					±0.1pF	GRM1884C1HR50BA01#	
				±0.1pF	GRM1885C1H9R6BA01#					0.60pF	±0.05pF	GRM1884C1HR60WA01#
				±0.25pF	GRM1885C1H9R6CA01#					±0.1pF	GRM1884C1HR60BA01#	
				±0.5pF	GRM1885C1H9R6DA01#				0.70pF	±0.05pF	GRM1884C1HR70WA01#	
			9.7pF	±0.05pF	GRM1885C1H9R7WA01#				±0.1pF	GRM1884C1HR70BA01#		
				±0.1pF	GRM1885C1H9R7BA01#				0.80pF	±0.05pF	GRM1884C1HR80WA01#	
				±0.25pF	GRM1885C1H9R7CA01#				±0.1pF	GRM1884C1HR80BA01#		
				±0.5pF	GRM1885C1H9R7DA01#				0.90pF	±0.05pF	GRM1884C1HR90WA01#	
			9.8pF	±0.05pF	GRM1885C1H9R8WA01#				±0.1pF	GRM1884C1HR90BA01#		
				±0.1pF	GRM1885C1H9R8BA01#				1.0pF	±0.05pF	GRM1884C1H1R0WA01#	
				±0.25pF	GRM1885C1H9R8CA01#				±0.1pF	GRM1884C1H1R0BA01#		
				±0.5pF	GRM1885C1H9R8DA01#				±0.25pF	GRM1884C1H1R0CA01#		
			9.9pF	±0.05pF	GRM1885C1H9R9WA01#				1.1pF	±0.05pF	GRM1884C1H1R1WA01#	
				±0.1pF	GRM1885C1H9R9BA01#				±0.1pF	GRM1884C1H1R1BA01#		
				±0.25pF	GRM1885C1H9R9CA01#				±0.25pF	GRM1884C1H1R1CA01#		
				±0.5pF	GRM1885C1H9R9DA01#				1.2pF	±0.05pF	GRM1884C1H1R2WA01#	
			10pF	±5%	GRM1885C1H100JA01#				±0.1pF	GRM1884C1H1R2BA01#		
			12pF	±5%	GRM1885C1H120JA01#				±0.25pF	GRM1884C1H1R2CA01#		
			15pF	±5%	GRM1885C1H150JA01#				1.3pF	±0.05pF	GRM1884C1H1R3WA01#	
			18pF	±5%	GRM1885C1H180JA01#					±0.1pF	GRM1884C1H1R3BA01#	
			22pF	±5%	GRM1885C1H220JA01#					±0.25pF	GRM1884C1H1R3CA01#	
			27pF	±5%	GRM1885C1H270JA01#					1.4pF	±0.05pF	GRM1884C1H1R4WA01#
			33pF	±5%	GRM1885C1H330JA01#				±0.1pF	GRM1884C1H1R4BA01#		
			39pF	±5%	GRM1885C1H390JA01#				±0.25pF	GRM1884C1H1R4CA01#		
			47pF	±5%	GRM1885C1H470JA01#				1.5pF	±0.05pF	GRM1884C1H1R5WA01#	
			56pF	±5%	GRM1885C1H560JA01#					±0.1pF	GRM1884C1H1R5BA01#	
			68pF	±5%	GRM1885C1H680JA01#					±0.25pF	GRM1884C1H1R5CA01#	
			82pF	±5%	GRM1885C1H820JA01#				1.6pF	±0.05pF	GRM1884C1H1R6WA01#	
			100pF	±5%	GRM1885C1H101JA01#					±0.1pF	GRM1884C1H1R6BA01#	
			120pF	±5%	GRM1885C1H121JA01#					±0.25pF	GRM1884C1H1R6CA01#	
			150pF	±5%	GRM1885C1H151JA01#				1.7pF	±0.05pF	GRM1884C1H1R7WA01#	
			180pF	±5%	GRM1885C1H181JA01#					±0.1pF	GRM1884C1H1R7BA01#	
220pF	±5%	GRM1885C1H221JA01#	±0.25pF	GRM1884C1H1R7CA01#								
270pF	±5%	GRM1885C1H271JA01#	1.8pF	±0.05pF	GRM1884C1H1R8WA01#							

Part number # indicates the package specification code.



GRM Series Temperature Compensating Type Part Number List

(→ 1.6×0.8mm)

T max.	Rated Voltage	TC Code	Cap.	Tol.	Part Number	T max.	Rated Voltage	TC Code	Cap.	Tol.	Part Number			
0.9mm	50Vdc	CK	1.8pF	±0.1pF	GRM1884C1H1R8BA01#	0.9mm	50Vdc	CJ	3.6pF	±0.1pF	GRM1883C1H3R6BA01#			
				±0.25pF	GRM1884C1H1R8CA01#					±0.25pF	GRM1883C1H3R6CA01#			
				±0.05pF	GRM1884C1H1R9WA01#					±0.05pF	GRM1883C1H3R7WA01#			
			1.9pF	±0.1pF	GRM1884C1H1R9BA01#				3.7pF	±0.1pF	GRM1883C1H3R7BA01#			
				±0.25pF	GRM1884C1H1R9CA01#					±0.25pF	GRM1883C1H3R7CA01#			
				±0.05pF	GRM1884C1H2R0WA01#					3.8pF	±0.05pF	GRM1883C1H3R8WA01#		
			±0.1pF	GRM1884C1H2R0BA01#	±0.1pF				GRM1883C1H3R8BA01#					
			±0.25pF	GRM1884C1H2R0CA01#	±0.25pF				GRM1883C1H3R8CA01#					
			CJ	2.1pF	±0.05pF				GRM1883C1H2R1WA01#	3.9pF	±0.05pF	GRM1883C1H3R9WA01#		
					±0.1pF				GRM1883C1H2R1BA01#		±0.1pF	GRM1883C1H3R9BA01#		
					±0.25pF				GRM1883C1H2R1CA01#		±0.25pF	GRM1883C1H3R9CA01#		
				2.2pF	±0.05pF				GRM1883C1H2R2WA01#		CH	4.0pF	±0.05pF	GRM1882C1H4R0WA01#
					±0.1pF				GRM1883C1H2R2BA01#				±0.1pF	GRM1882C1H4R0BA01#
					±0.25pF				GRM1883C1H2R2CA01#				±0.25pF	GRM1882C1H4R0CA01#
				2.3pF	±0.05pF				GRM1883C1H2R3WA01#			4.1pF	±0.05pF	GRM1882C1H4R1WA01#
					±0.1pF				GRM1883C1H2R3BA01#				±0.1pF	GRM1882C1H4R1BA01#
					±0.25pF				GRM1883C1H2R3CA01#				±0.25pF	GRM1882C1H4R1CA01#
				2.4pF	±0.05pF				GRM1883C1H2R4WA01#			4.2pF	±0.05pF	GRM1882C1H4R2WA01#
		±0.1pF			GRM1883C1H2R4BA01#	±0.1pF	GRM1882C1H4R2BA01#							
		±0.25pF			GRM1883C1H2R4CA01#	±0.25pF	GRM1882C1H4R2CA01#							
		2.5pF		±0.05pF	GRM1883C1H2R5WA01#	4.3pF	±0.05pF	GRM1882C1H4R3WA01#						
				±0.1pF	GRM1883C1H2R5BA01#		±0.1pF	GRM1882C1H4R3BA01#						
				±0.25pF	GRM1883C1H2R5CA01#		±0.25pF	GRM1882C1H4R3CA01#						
		2.6pF		±0.05pF	GRM1883C1H2R6WA01#	4.4pF	±0.05pF	GRM1882C1H4R4WA01#						
				±0.1pF	GRM1883C1H2R6BA01#		±0.1pF	GRM1882C1H4R4BA01#						
				±0.25pF	GRM1883C1H2R6CA01#		±0.25pF	GRM1882C1H4R4CA01#						
		2.7pF	±0.05pF	GRM1883C1H2R7WA01#	4.5pF	±0.05pF	GRM1882C1H4R5WA01#							
			±0.1pF	GRM1883C1H2R7BA01#		±0.1pF	GRM1882C1H4R5BA01#							
			±0.25pF	GRM1883C1H2R7CA01#		±0.25pF	GRM1882C1H4R5CA01#							
		2.8pF	±0.05pF	GRM1883C1H2R8WA01#	4.6pF	±0.05pF	GRM1882C1H4R6WA01#							
			±0.1pF	GRM1883C1H2R8BA01#		±0.1pF	GRM1882C1H4R6BA01#							
			±0.25pF	GRM1883C1H2R8CA01#		±0.25pF	GRM1882C1H4R6CA01#							
		2.9pF	±0.05pF	GRM1883C1H2R9WA01#	4.7pF	±0.05pF	GRM1882C1H4R7WA01#							
			±0.1pF	GRM1883C1H2R9BA01#		±0.1pF	GRM1882C1H4R7BA01#							
			±0.25pF	GRM1883C1H2R9CA01#		±0.25pF	GRM1882C1H4R7CA01#							
		3.0pF	±0.05pF	GRM1883C1H3R0WA01#	4.8pF	±0.05pF	GRM1882C1H4R8WA01#							
			±0.1pF	GRM1883C1H3R0BA01#		±0.1pF	GRM1882C1H4R8BA01#							
			±0.25pF	GRM1883C1H3R0CA01#		±0.25pF	GRM1882C1H4R8CA01#							
		3.1pF	±0.05pF	GRM1883C1H3R1WA01#	4.9pF	±0.05pF	GRM1882C1H4R9WA01#							
			±0.1pF	GRM1883C1H3R1BA01#		±0.1pF	GRM1882C1H4R9BA01#							
			±0.25pF	GRM1883C1H3R1CA01#		±0.25pF	GRM1882C1H4R9CA01#							
		3.2pF	±0.05pF	GRM1883C1H3R2WA01#	5.0pF	±0.05pF	GRM1882C1H5R0WA01#							
			±0.1pF	GRM1883C1H3R2BA01#		±0.1pF	GRM1882C1H5R0BA01#							
			±0.25pF	GRM1883C1H3R2CA01#		±0.25pF	GRM1882C1H5R0CA01#							
		3.3pF	±0.05pF	GRM1883C1H3R3WA01#	5.1pF	±0.05pF	GRM1882C1H5R1WA01#							
			±0.1pF	GRM1883C1H3R3BA01#		±0.1pF	GRM1882C1H5R1BA01#							
			±0.25pF	GRM1883C1H3R3CA01#		±0.25pF	GRM1882C1H5R1CA01#							
		3.4pF	±0.05pF	GRM1883C1H3R4WA01#	5.2pF	±0.05pF	GRM1882C1H5R2WA01#							
			±0.1pF	GRM1883C1H3R4BA01#		±0.1pF	GRM1882C1H5R2BA01#							
			±0.25pF	GRM1883C1H3R4CA01#		±0.25pF	GRM1882C1H5R2CA01#							
		3.5pF	±0.05pF	GRM1883C1H3R5WA01#	5.3pF	±0.05pF	GRM1882C1H5R3WA01#							
			±0.1pF	GRM1883C1H3R5BA01#		±0.1pF	GRM1882C1H5R3BA01#							
			±0.25pF	GRM1883C1H3R5CA01#		±0.25pF	GRM1882C1H5R3CA01#							

Part number # indicates the package specification code.

GRM
 GR3
 GRJ
 GR4
 GR7
 GJM
 GQM
 GA2
 GA3 GB
 GA3 GD
 GA3 GF
 LLL
 LLA
 LLM
 LLR
 NFM
 KRM
 KR3
 GMA
 GMD
 ⚠Caution /Notice

GRM Series Temperature Compensating Type Part Number List

(→ 1.6×0.8mm)

T max.	Rated Voltage	TC Code	Cap.	Tol.	Part Number	T max.	Rated Voltage	TC Code	Cap.	Tol.	Part Number
0.9mm	50Vdc	CH	5.3pF	±0.25pF	GRM1882C1H5R3CA01#	0.9mm	50Vdc	CH	6.7pF	±0.05pF	GRM1882C1H6R7WA01#
				±0.5pF	GRM1882C1H5R3DA01#					±0.1pF	GRM1882C1H6R7BA01#
			5.4pF	±0.05pF	GRM1882C1H5R4WA01#	±0.25pF			GRM1882C1H6R7CA01#		
				±0.1pF	GRM1882C1H5R4BA01#	±0.5pF			GRM1882C1H6R7DA01#		
				±0.25pF	GRM1882C1H5R4CA01#	6.8pF			±0.05pF	GRM1882C1H6R8WA01#	
				±0.5pF	GRM1882C1H5R4DA01#				±0.1pF	GRM1882C1H6R8BA01#	
			5.5pF	±0.05pF	GRM1882C1H5R5WA01#				±0.25pF	GRM1882C1H6R8CA01#	
				±0.1pF	GRM1882C1H5R5BA01#	±0.5pF			GRM1882C1H6R8DA01#		
				±0.25pF	GRM1882C1H5R5CA01#	6.9pF			±0.05pF	GRM1882C1H6R9WA01#	
			±0.5pF	GRM1882C1H5R5DA01#	±0.1pF				GRM1882C1H6R9BA01#		
			5.6pF	±0.05pF	GRM1882C1H5R6WA01#				±0.25pF	GRM1882C1H6R9CA01#	
				±0.1pF	GRM1882C1H5R6BA01#	±0.5pF			GRM1882C1H6R9DA01#		
				±0.25pF	GRM1882C1H5R6CA01#	7.0pF			±0.05pF	GRM1882C1H7R0WA01#	
				±0.5pF	GRM1882C1H5R6DA01#				±0.1pF	GRM1882C1H7R0BA01#	
			5.7pF	±0.05pF	GRM1882C1H5R7WA01#				±0.25pF	GRM1882C1H7R0CA01#	
				±0.1pF	GRM1882C1H5R7BA01#	±0.5pF			GRM1882C1H7R0DA01#		
				±0.25pF	GRM1882C1H5R7CA01#	7.1pF			±0.05pF	GRM1882C1H7R1WA01#	
				±0.5pF	GRM1882C1H5R7DA01#				±0.1pF	GRM1882C1H7R1BA01#	
			5.8pF	±0.05pF	GRM1882C1H5R8WA01#				±0.25pF	GRM1882C1H7R1CA01#	
				±0.1pF	GRM1882C1H5R8BA01#	±0.5pF			GRM1882C1H7R1DA01#		
				±0.25pF	GRM1882C1H5R8CA01#	7.2pF			±0.05pF	GRM1882C1H7R2WA01#	
				±0.5pF	GRM1882C1H5R8DA01#				±0.1pF	GRM1882C1H7R2BA01#	
			5.9pF	±0.05pF	GRM1882C1H5R9WA01#				±0.25pF	GRM1882C1H7R2CA01#	
				±0.1pF	GRM1882C1H5R9BA01#	±0.5pF			GRM1882C1H7R2DA01#		
				±0.25pF	GRM1882C1H5R9CA01#	7.3pF			±0.05pF	GRM1882C1H7R3WA01#	
				±0.5pF	GRM1882C1H5R9DA01#				±0.1pF	GRM1882C1H7R3BA01#	
			6.0pF	±0.05pF	GRM1882C1H6R0WA01#				±0.25pF	GRM1882C1H7R3CA01#	
				±0.1pF	GRM1882C1H6R0BA01#	±0.5pF			GRM1882C1H7R3DA01#		
				±0.25pF	GRM1882C1H6R0CA01#	7.4pF			±0.05pF	GRM1882C1H7R4WA01#	
				±0.5pF	GRM1882C1H6R0DA01#				±0.1pF	GRM1882C1H7R4BA01#	
			6.1pF	±0.05pF	GRM1882C1H6R1WA01#				±0.25pF	GRM1882C1H7R4CA01#	
				±0.1pF	GRM1882C1H6R1BA01#	±0.5pF			GRM1882C1H7R4DA01#		
				±0.25pF	GRM1882C1H6R1CA01#	7.5pF			±0.05pF	GRM1882C1H7R5WA01#	
				±0.5pF	GRM1882C1H6R1DA01#				±0.1pF	GRM1882C1H7R5BA01#	
			6.2pF	±0.05pF	GRM1882C1H6R2WA01#				±0.25pF	GRM1882C1H7R5CA01#	
				±0.1pF	GRM1882C1H6R2BA01#	±0.5pF			GRM1882C1H7R5DA01#		
				±0.25pF	GRM1882C1H6R2CA01#	7.6pF			±0.05pF	GRM1882C1H7R6WA01#	
				±0.5pF	GRM1882C1H6R2DA01#				±0.1pF	GRM1882C1H7R6BA01#	
			6.3pF	±0.05pF	GRM1882C1H6R3WA01#				±0.25pF	GRM1882C1H7R6CA01#	
				±0.1pF	GRM1882C1H6R3BA01#	±0.5pF			GRM1882C1H7R6DA01#		
				±0.25pF	GRM1882C1H6R3CA01#	7.7pF			±0.05pF	GRM1882C1H7R7WA01#	
				±0.5pF	GRM1882C1H6R3DA01#				±0.1pF	GRM1882C1H7R7BA01#	
			6.4pF	±0.05pF	GRM1882C1H6R4WA01#				±0.25pF	GRM1882C1H7R7CA01#	
				±0.1pF	GRM1882C1H6R4BA01#	±0.5pF			GRM1882C1H7R7DA01#		
				±0.25pF	GRM1882C1H6R4CA01#	7.8pF			±0.05pF	GRM1882C1H7R8WA01#	
				±0.5pF	GRM1882C1H6R4DA01#				±0.1pF	GRM1882C1H7R8BA01#	
			6.5pF	±0.05pF	GRM1882C1H6R5WA01#				±0.25pF	GRM1882C1H7R8CA01#	
				±0.1pF	GRM1882C1H6R5BA01#	±0.5pF			GRM1882C1H7R8DA01#		
				±0.25pF	GRM1882C1H6R5CA01#	7.9pF			±0.05pF	GRM1882C1H7R9WA01#	
				±0.5pF	GRM1882C1H6R5DA01#				±0.1pF	GRM1882C1H7R9BA01#	
			6.6pF	±0.05pF	GRM1882C1H6R6WA01#				±0.25pF	GRM1882C1H7R9CA01#	
				±0.1pF	GRM1882C1H6R6BA01#	±0.5pF			GRM1882C1H7R9DA01#		
				±0.25pF	GRM1882C1H6R6CA01#	8.0pF			±0.05pF	GRM1882C1H8R0WA01#	
				±0.5pF	GRM1882C1H6R6DA01#				±0.1pF	GRM1882C1H8R0BA01#	

Part number # indicates the package specification code.



GRM Series Temperature Compensating Type Part Number List

(→ 1.6×0.8mm)

T max.	Rated Voltage	TC Code	Cap.	Tol.	Part Number	T max.	Rated Voltage	TC Code	Cap.	Tol.	Part Number
0.9mm	50Vdc	CH	8.0pF	±0.25pF	GRM1882C1H8ROCA01#	0.9mm	50Vdc	CH	9.4pF	±0.05pF	GRM1882C1H9R4WA01#
				±0.5pF	GRM1882C1H8RODA01#					±0.1pF	GRM1882C1H9R4BA01#
			8.1pF	±0.05pF	GRM1882C1H8R1WA01#	±0.25pF	GRM1882C1H9R4CA01#				
				±0.1pF	GRM1882C1H8R1BA01#	±0.5pF	GRM1882C1H9R4DA01#				
				±0.25pF	GRM1882C1H8R1CA01#	9.5pF	±0.05pF	GRM1882C1H9R5WA01#			
				±0.5pF	GRM1882C1H8R1DA01#		±0.1pF	GRM1882C1H9R5BA01#			
			8.2pF	±0.05pF	GRM1882C1H8R2WA01#	±0.25pF	GRM1882C1H9R5CA01#				
				±0.1pF	GRM1882C1H8R2BA01#	±0.5pF	GRM1882C1H9R5DA01#				
				±0.25pF	GRM1882C1H8R2CA01#	9.6pF	±0.05pF	GRM1882C1H9R6WA01#			
				±0.5pF	GRM1882C1H8R2DA01#		±0.1pF	GRM1882C1H9R6BA01#			
			8.3pF	±0.05pF	GRM1882C1H8R3WA01#	±0.25pF	GRM1882C1H9R6CA01#				
				±0.1pF	GRM1882C1H8R3BA01#	±0.5pF	GRM1882C1H9R6DA01#				
				±0.25pF	GRM1882C1H8R3CA01#	9.7pF	±0.05pF	GRM1882C1H9R7WA01#			
				±0.5pF	GRM1882C1H8R3DA01#		±0.1pF	GRM1882C1H9R7BA01#			
			8.4pF	±0.05pF	GRM1882C1H8R4WA01#	±0.25pF	GRM1882C1H9R7CA01#				
				±0.1pF	GRM1882C1H8R4BA01#	±0.5pF	GRM1882C1H9R7DA01#				
				±0.25pF	GRM1882C1H8R4CA01#	9.8pF	±0.05pF	GRM1882C1H9R8WA01#			
				±0.5pF	GRM1882C1H8R4DA01#		±0.1pF	GRM1882C1H9R8BA01#			
			8.5pF	±0.05pF	GRM1882C1H8R5WA01#	±0.25pF	GRM1882C1H9R8CA01#				
				±0.1pF	GRM1882C1H8R5BA01#	±0.5pF	GRM1882C1H9R8DA01#				
				±0.25pF	GRM1882C1H8R5CA01#	9.9pF	±0.05pF	GRM1882C1H9R9WA01#			
				±0.5pF	GRM1882C1H8R5DA01#		±0.1pF	GRM1882C1H9R9BA01#			
			8.6pF	±0.05pF	GRM1882C1H8R6WA01#	±0.25pF	GRM1882C1H9R9CA01#				
				±0.1pF	GRM1882C1H8R6BA01#	±0.5pF	GRM1882C1H9R9DA01#				
				±0.25pF	GRM1882C1H8R6CA01#	10pF	±5%	GRM1882C1H100JA01#			
				±0.5pF	GRM1882C1H8R6DA01#		12pF	±5%	GRM1882C1H120JA01#		
			8.7pF	±0.05pF	GRM1882C1H8R7WA01#	15pF	±5%	GRM1882C1H150JA01#			
				±0.1pF	GRM1882C1H8R7BA01#	18pF	±5%	GRM1882C1H180JA01#			
				±0.25pF	GRM1882C1H8R7CA01#	22pF	±5%	GRM1882C1H220JA01#			
				±0.5pF	GRM1882C1H8R7DA01#	27pF	±5%	GRM1882C1H270JA01#			
			8.8pF	±0.05pF	GRM1882C1H8R8WA01#	33pF	±5%	GRM1882C1H330JA01#			
				±0.1pF	GRM1882C1H8R8BA01#	39pF	±5%	GRM1882C1H390JA01#			
				±0.25pF	GRM1882C1H8R8CA01#	47pF	±5%	GRM1882C1H470JA01#			
				±0.5pF	GRM1882C1H8R8DA01#	56pF	±5%	GRM1882C1H560JA01#			
			8.9pF	±0.05pF	GRM1882C1H8R9WA01#	68pF	±5%	GRM1882C1H680JA01#			
				±0.1pF	GRM1882C1H8R9BA01#	82pF	±5%	GRM1882C1H820JA01#			
				±0.25pF	GRM1882C1H8R9CA01#	100pF	±5%	GRM1882C1H101JA01#			
				±0.5pF	GRM1882C1H8R9DA01#	120pF	±5%	GRM1882C1H121JA01#			
			9.0pF	±0.05pF	GRM1882C1H9R0WA01#	150pF	±5%	GRM1882C1H151JA01#			
				±0.1pF	GRM1882C1H9R0BA01#	180pF	±5%	GRM1882C1H181JA01#			
				±0.25pF	GRM1882C1H9R0CA01#	220pF	±5%	GRM1882C1H221JA01#			
				±0.5pF	GRM1882C1H9R0DA01#	270pF	±5%	GRM1882C1H271JA01#			
			9.1pF	±0.05pF	GRM1882C1H9R1WA01#	330pF	±5%	GRM1882C1H331JA01#			
				±0.1pF	GRM1882C1H9R1BA01#	390pF	±5%	GRM1882C1H391JA01#			
				±0.25pF	GRM1882C1H9R1CA01#	470pF	±5%	GRM1882C1H471JA01#			
				±0.5pF	GRM1882C1H9R1DA01#	560pF	±5%	GRM1882C1H561JA01#			
			9.2pF	±0.05pF	GRM1882C1H9R2WA01#	680pF	±5%	GRM1882C1H681JA01#			
				±0.1pF	GRM1882C1H9R2BA01#	820pF	±5%	GRM1882C1H821JA01#			
				±0.25pF	GRM1882C1H9R2CA01#	1000pF	±5%	GRM1882C1H102JA01#			
				±0.5pF	GRM1882C1H9R2DA01#	1200pF	±5%	GRM1882C1H122JA01#			
			9.3pF	±0.05pF	GRM1882C1H9R3WA01#	1500pF	±5%	GRM1882C1H152JA01#			
				±0.1pF	GRM1882C1H9R3BA01#	1800pF	±5%	GRM1882C1H182JA01#			
				±0.25pF	GRM1882C1H9R3CA01#	2200pF	±5%	GRM1882C1H222JA01#			
				±0.5pF	GRM1882C1H9R3DA01#	2700pF	±5%	GRM1882C1H272JA01#			

GRM
 GR3
 GRJ
 GR4
 GR7
 GJM
 GQM
 GA2
 GA3 GB
 GA3 GD
 GA3 GF
 LLL
 LLA
 LLM
 LLR
 NFM
 KRM
 KR3
 GMA
 GMD
 ⚠Caution /Notice

Part number # indicates the package specification code.

GRM Series Temperature Compensating Type Part Number List

(→ 1.6×0.8mm)

T max.	Rated Voltage	TC Code	Cap.	Tol.	Part Number
0.9mm	50Vdc	CH	3300pF	±5%	GRM1882C1H332JA01#
			3900pF	±5%	GRM1882C1H392JA01#
			4700pF	±5%	GRM1882C1H472JA01#
			5600pF	±5%	GRM1882C1H562JA01#
			6800pF	±5%	GRM1882C1H682JA01#
			8200pF	±5%	GRM1882C1H822JA01#
			10000pF	±5%	GRM1882C1H103JA01#
		SL	1200pF	±5%	GRM1881X1H122JA01#
			1500pF	±5%	GRM1881X1H152JA01#
			1800pF	±5%	GRM1881X1H182JA01#
			2200pF	±5%	GRM1881X1H222JA01#
			2700pF	±5%	GRM1881X1H272JA01#
			3300pF	±5%	GRM1881X1H332JA01#
			3900pF	±5%	GRM1881X1H392JA01#
			4700pF	±5%	GRM1881X1H472JA01#
			5600pF	±5%	GRM1881X1H562JA01#
			6800pF	±5%	GRM1881X1H682JA01#
		U2J	1200pF	±5%	GRM1887U1H122JA01#
			1500pF	±5%	GRM1887U1H152JA01#
			1800pF	±5%	GRM1887U1H182JA01#
			2200pF	±5%	GRM1887U1H222JA01#
			2700pF	±5%	GRM1887U1H272JA01#
			3300pF	±5%	GRM1887U1H332JA01#
			3900pF	±5%	GRM1887U1H392JA01#
			4700pF	±5%	GRM1887U1H472JA01#
			5600pF	±5%	GRM1887U1H562JA01#
			6800pF	±5%	GRM1887U1H682JA01#
UJ	1000pF	±5%	GRM1883U1H102JA01#		
	1200pF	±5%	GRM1883U1H122JA01#		
	1500pF	±5%	GRM1883U1H152JA01#		
	1800pF	±5%	GRM1883U1H182JA01#		
	2200pF	±5%	GRM1883U1H222JA01#		
	2700pF	±5%	GRM1883U1H272JA01#		
	3300pF	±5%	GRM1883U1H332JA01#		
	3900pF	±5%	GRM1883U1H392JA01#		
	4700pF	±5%	GRM1883U1H472JA01#		
	5600pF	±5%	GRM1883U1H562JA01#		
10Vdc	SL	12000pF	±5%	GRM1881X1A123JA01#	
		15000pF	±5%	GRM1881X1A153JA01#	
		18000pF	±5%	GRM1881X1A183JA01#	
		22000pF	±5%	GRM1881X1A223JA01#	
	U2J	12000pF	±5%	GRM1887U1A123JA01#	
		15000pF	±5%	GRM1887U1A153JA01#	
		18000pF	±5%	GRM1887U1A183JA01#	
		22000pF	±5%	GRM1887U1A223JA01#	
		UJ	12000pF	±5%	GRM1883U1A123JA01#
			15000pF	±5%	GRM1883U1A153JA01#

T max.	Rated Voltage	TC Code	Cap.	Tol.	Part Number
0.9mm	10Vdc	UJ	18000pF	±5%	GRM1883U1A183JA01#
			22000pF	±5%	GRM1883U1A223JA01#

2.0×1.25mm

T max.	Rated Voltage	TC Code	Cap.	Tol.	Part Number
0.7mm	100Vdc	COG	100pF	±5%	GRM2165C2A101JA01#
			120pF	±5%	GRM2165C2A121JA01#
			150pF	±5%	GRM2165C2A151JA01#
			180pF	±5%	GRM2165C2A181JA01#
			220pF	±5%	GRM2165C2A221JA01#
			270pF	±5%	GRM2165C2A271JA01#
			330pF	±5%	GRM2165C2A331JA01#
			390pF	±5%	GRM2165C2A391JA01#
			470pF	±5%	GRM2165C2A471JA01#
			560pF	±5%	GRM2165C2A561JA01#
			680pF	±5%	GRM2165C2A681JA01#
			820pF	±5%	GRM2165C2A821JA01#
			1000pF	±5%	GRM2165C2A102JA01#
			1200pF	±5%	GRM2165C2A122JA01#
			1500pF	±5%	GRM2165C2A152JA01#
			1800pF	±5%	GRM2165C2A182JA01#
			2200pF	±5%	GRM2165C2A222JA01#
			2700pF	±5%	GRM2165C2A272JA01#
			3300pF	±5%	GRM2165C2A332JA01#
			CH	100pF	±5%
		120pF		±5%	GRM2162C2A121JA01#
		150pF		±5%	GRM2162C2A151JA01#
		180pF		±5%	GRM2162C2A181JA01#
		220pF		±5%	GRM2162C2A221JA01#
		270pF		±5%	GRM2162C2A271JA01#
		330pF		±5%	GRM2162C2A331JA01#
		390pF		±5%	GRM2162C2A391JA01#
		470pF		±5%	GRM2162C2A471JA01#
		560pF		±5%	GRM2162C2A561JA01#
		680pF		±5%	GRM2162C2A681JA01#
		820pF		±5%	GRM2162C2A821JA01#
		1000pF		±5%	GRM2162C2A102JA01#
		50Vdc	COG	1200pF	±5%
1500pF	±5%			GRM2165C1H152JA01#	
1800pF	±5%			GRM2165C1H182JA01#	
2200pF	±5%			GRM2165C1H222JA01#	
2700pF	±5%			GRM2165C1H272JA01#	
3300pF	±5%			GRM2165C1H332JA01#	
3900pF	±5%			GRM2165C1H392JA01#	
4700pF	±5%			GRM2165C1H472JA01#	
CH	1200pF			±5%	GRM2162C1H122JA01#

Part number # indicates the package specification code.



GRM Series Temperature Compensating Type Part Number List

(→ 2.0×1.25mm)

T max.	Rated Voltage	TC Code	Cap.	Tol.	Part Number	T max.	Rated Voltage	TC Code	Cap.	Tol.	Part Number		
0.7mm	50Vdc	CH	1500pF	±5%	GRM2162C1H152JA01#	1.0mm	630Vdc	COG	220pF	±5%	GRM21A5C2J221JWA1#		
			1800pF	±5%	GRM2162C1H182JA01#				270pF	±5%	GRM21A5C2J271JWA1#		
			2200pF	±5%	GRM2162C1H222JA01#				330pF	±5%	GRM21A5C2J331JWA1#		
			2700pF	±5%	GRM2162C1H272JA01#				390pF	±5%	GRM21A5C2J391JWA1#		
			3300pF	±5%	GRM2162C1H332JA01#				470pF	±5%	GRM21A5C2J471JWA1#		
			3900pF	±5%	GRM2162C1H392JA01#				560pF	±5%	GRM21A5C2J561JWA1#		
			4700pF	±5%	GRM2162C1H472JA01#				250Vdc	COG	10pF	±5%	GRM21A5C2E100JW01#
		SL	12000pF	±5%	GRM2161X1H123JA01#						12pF	±5%	GRM21A5C2E120JW01#
			15000pF	±5%	GRM2161X1H153JA01#						15pF	±5%	GRM21A5C2E150JW01#
			18000pF	±5%	GRM2161X1H183JA01#						18pF	±5%	GRM21A5C2E180JW01#
		U2J	12000pF	±5%	GRM2167U1H123JA01#						22pF	±5%	GRM21A5C2E220JW01#
			15000pF	±5%	GRM2167U1H153JA01#						27pF	±5%	GRM21A5C2E270JW01#
			18000pF	±5%	GRM2167U1H183JA01#						33pF	±5%	GRM21A5C2E330JW01#
		UJ	10000pF	±5%	GRM2163U1H103JA01#				39pF	±5%	GRM21A5C2E390JW01#		
			12000pF	±5%	GRM2163U1H123JA01#			47pF	±5%	GRM21A5C2E470JW01#			
			15000pF	±5%	GRM2163U1H153JA01#			56pF	±5%	GRM21A5C2E560JW01#			
			18000pF	±5%	GRM2163U1H183JA01#			68pF	±5%	GRM21A5C2E680JW01#			
		0.95mm	50Vdc	COG	5600pF			±5%	GRM2195C1H562JA01#	82pF	±5%	GRM21A5C2E820JW01#	
					6800pF			±5%	GRM2195C1H682JA01#	100pF	±5%	GRM21A5C2E101JW01#	
					8200pF			±5%	GRM2195C1H822JA01#	120pF	±5%	GRM21A5C2E121JW01#	
					10000pF			±5%	GRM2195C1H103JA01#	150pF	±5%	GRM21A5C2E151JW01#	
12000pF	±5%				GRM2195C1H123JA01#	180pF	±5%	GRM21A5C2E181JW01#					
15000pF	±5%				GRM2195C1H153JA01#	220pF	±5%	GRM21A5C2E221JW01#					
CH	5600pF			±5%	GRM2192C1H562JA01#	270pF	±5%	GRM21A5C2E271JW01#					
	6800pF			±5%	GRM2192C1H682JA01#	330pF	±5%	GRM21A5C2E331JW01#					
	8200pF			±5%	GRM2192C1H822JA01#	390pF	±5%	GRM21A5C2E391JWA1#					
	10000pF			±5%	GRM2192C1H103JA01#	470pF	±5%	GRM21A5C2E471JWA1#					
	12000pF			±5%	GRM2192C1H123JA01#	560pF	±5%	GRM21A5C2E561JWA1#					
SL	22000pF			±5%	GRM2191X1H223JA01#	680pF	±5%	GRM21A5C2E681JWA1#					
	27000pF			±5%	GRM2191X1H273JA01#	820pF	±5%	GRM21A5C2E821JWA1#					
	U2J			22000pF	±5%	GRM2197U1H223JA01#	1000pF	±5%	GRM21A5C2E102JWA1#				
27000pF			±5%	GRM2197U1H273JA01#	1200pF	±5%	GRM21A5C2E122JWA1#						
UJ	22000pF		±5%	GRM2193U1H223JA01#	1500pF	±5%	GRM21A5C2E152JWA1#						
	27000pF		±5%	GRM2193U1H273JA01#	1800pF	±5%	GRM21A5C2E182JWA1#						
10Vdc	SL		56000pF	±5%	GRM2191X1A563JA01#	2200pF	±5%	GRM21A5C2E222JWA1#					
			56000pF	±5%	GRM2197U1A563JA01#	2700pF	±5%	GRM21A5C2E272JWA1#					
	U2J		56000pF	±5%	GRM2193U1A563JA01#	U2J	100pF	±5%	GRM21A7U2E101JW31#				
			56000pF	±5%	GRM2193U1A563JA01#		120pF	±5%	GRM21A7U2E121JW31#				
		10pF	±5%	GRM21A5C2J100JWA1#	150pF		±5%	GRM21A7U2E151JW31#					
12pF	±5%	GRM21A5C2J120JWA1#	180pF	±5%	GRM21A7U2E181JW31#								
15pF	±5%	GRM21A5C2J150JWA1#	220pF	±5%	GRM21A7U2E221JW31#								
18pF	±5%	GRM21A5C2J180JWA1#	270pF	±5%	GRM21A7U2E271JW31#								
22pF	±5%	GRM21A5C2J220JWA1#	330pF	±5%	GRM21A7U2E331JW31#								
27pF	±5%	GRM21A5C2J270JWA1#	390pF	±5%	GRM21A7U2E391JW31#								
33pF	±5%	GRM21A5C2J330JWA1#	470pF	±5%	GRM21A7U2E471JW31#								
39pF	±5%	GRM21A5C2J390JWA1#	560pF	±5%	GRM21A7U2E561JW31#								
47pF	±5%	GRM21A5C2J470JWA1#	680pF	±5%	GRM21A7U2E681JW31#								
56pF	±5%	GRM21A5C2J560JWA1#	820pF	±5%	GRM21A7U2E821JW31#								
68pF	±5%	GRM21A5C2J680JWA1#	1000pF	±5%	GRM21A7U2E102JW31#								
82pF	±5%	GRM21A5C2J820JWA1#	1200pF	±5%	GRM21A7U2E122JW31#								
100pF	±5%	GRM21A5C2J101JWA1#	1500pF	±5%	GRM21A7U2E152JW31#								
120pF	±5%	GRM21A5C2J121JWA1#	1800pF	±5%	GRM21A7U2E182JW31#								
150pF	±5%	GRM21A5C2J151JWA1#	2200pF	±5%	GRM21A7U2E222JW31#								
180pF	±5%	GRM21A5C2J181JWA1#	200Vdc	COG	10pF	±5%	GRM21A5C2D100JW01#						

Part number # indicates the package specification code.

GRM Series Temperature Compensating Type Part Number List

(→ 2.0×1.25mm)

T max.	Rated Voltage	TC Code	Cap.	Tol.	Part Number			
1.0mm	200Vdc	COG	12pF	±5%	GRM21A5C2D120JW01#			
			15pF	±5%	GRM21A5C2D150JW01#			
			18pF	±5%	GRM21A5C2D180JW01#			
						22pF	±5%	GRM21A5C2D220JW01#
						27pF	±5%	GRM21A5C2D270JW01#
						33pF	±5%	GRM21A5C2D330JW01#
						39pF	±5%	GRM21A5C2D390JW01#
						47pF	±5%	GRM21A5C2D470JW01#
						56pF	±5%	GRM21A5C2D560JW01#
						68pF	±5%	GRM21A5C2D680JW01#
						82pF	±5%	GRM21A5C2D820JW01#
						100pF	±5%	GRM21A5C2D101JW01#
						120pF	±5%	GRM21A5C2D121JW01#
						150pF	±5%	GRM21A5C2D151JW01#
						180pF	±5%	GRM21A5C2D181JW01#
						220pF	±5%	GRM21A5C2D221JW01#
						270pF	±5%	GRM21A5C2D271JW01#
						330pF	±5%	GRM21A5C2D331JW01#
					U2J	100pF	±5%	GRM21A7U2D101JW31#
						120pF	±5%	GRM21A7U2D121JW31#
						150pF	±5%	GRM21A7U2D151JW31#
						180pF	±5%	GRM21A7U2D181JW31#
						220pF	±5%	GRM21A7U2D221JW31#
						270pF	±5%	GRM21A7U2D271JW31#
						330pF	±5%	GRM21A7U2D331JW31#
						390pF	±5%	GRM21A7U2D391JW31#
						470pF	±5%	GRM21A7U2D471JW31#
						560pF	±5%	GRM21A7U2D561JW31#
						680pF	±5%	GRM21A7U2D681JW31#
						820pF	±5%	GRM21A7U2D821JW31#
					1000pF	±5%	GRM21A7U2D102JW31#	
					1200pF	±5%	GRM21A7U2D122JW31#	
					1500pF	±5%	GRM21A7U2D152JW31#	
			1800pF	±5%	GRM21A7U2D182JW31#			
			2200pF	±5%	GRM21A7U2D222JW31#			
		50Vdc	SL	33000pF	±5%	GRM21A1X1H333JA39#		
			U2J	33000pF	±5%	GRM21A7U1H333JA39#		
			UJ	33000pF	±5%	GRM21A3U1H333JA39#		
	1.35mm	50Vdc	COG	18000pF	±5%	GRM21B5C1H183JA01#		
				22000pF	±5%	GRM21B5C1H223JA01#		
				CH	18000pF	±5%	GRM21B2C1H183JA01#	
					22000pF	±5%	GRM21B2C1H223JA01#	
				SL	39000pF	±5%	GRM21B1X1H393JA01#	
					47000pF	±5%	GRM21B1X1H473JA01#	
			U2J	39000pF	±5%	GRM21B7U1H393JA01#		
47000pF				±5%	GRM21B7U1H473JA01#			
UJ			39000pF	±5%	GRM21B3U1H393JA01#			
			47000pF	±5%	GRM21B3U1H473JA01#			
10Vdc			SL	68000pF	±5%	GRM21B1X1A683JA01#		
				82000pF	±5%	GRM21B1X1A823JA01#		
		0.10μF		±5%	GRM21B1X1A104JA01#			
		U2J	68000pF	±5%	GRM21B7U1A683JA01#			
			82000pF	±5%	GRM21B7U1A823JA01#			
			0.10μF	±5%	GRM21B7U1A104JA01#			

T max.	Rated Voltage	TC Code	Cap.	Tol.	Part Number		
1.35mm	10Vdc	UJ	68000pF	±5%	GRM21B3U1A683JA01#		
			82000pF	±5%	GRM21B3U1A823JA01#		
			0.10μF	±5%	GRM21B3U1A104JA01#		
1.45mm	630Vdc	COG	680pF	±5%	GRM21B5C2J681JWA3#		
			820pF	±5%	GRM21B5C2J821JWA3#		
			1000pF	±5%	GRM21B5C2J102JWA3#		
			1200pF	±5%	GRM21B5C2J122JWA3#		
			250Vdc	COG	3300pF	±5%	GRM21B5C2E332JWA1#
					3900pF	±5%	GRM21B5C2E392JWA1#
	4700pF	±5%			GRM21B5C2E472JWA1#		
	U2J	2700pF			±5%	GRM21B7U2E272JW32#	
		3300pF			±5%	GRM21B7U2E332JW32#	
		3900pF			±5%	GRM21B7U2E392JW32#	
	200Vdc	U2J	4700pF	±5%	GRM21B7U2E472JW32#		
			5600pF	±5%	GRM21B7U2E562JW32#		
2700pF			±5%	GRM21B7U2D272JW32#			
3300pF			±5%	GRM21B7U2D332JW32#			
3900pF			±5%	GRM21B7U2D392JW32#			
4700pF			±5%	GRM21B7U2D472JW32#			
			5600pF	±5%	GRM21B7U2D562JW32#		

3.2×1.6mm

T max.	Rated Voltage	TC Code	Cap.	Tol.	Part Number		
0.95mm	100Vdc	COG	1800pF	±5%	GRM3195C2A182JA01#		
			2200pF	±5%	GRM3195C2A222JA01#		
			2700pF	±5%	GRM3195C2A272JA01#		
			3300pF	±5%	GRM3195C2A332JA01#		
			3900pF	±5%	GRM3195C2A392JA01#		
			4700pF	±5%	GRM3195C2A472JA01#		
			5600pF	±5%	GRM3195C2A562JA01#		
			6800pF	±5%	GRM3195C2A682JA01#		
			8200pF	±5%	GRM3195C2A822JA01#		
			10000pF	±5%	GRM3195C2A103JA01#		
			12000pF	±5%	GRM3195C2A123JA01#		
			15000pF	±5%	GRM3195C2A153JA01#		
			18000pF	±5%	GRM3195C2A183JA01#		
			22000pF	±5%	GRM3195C2A223JA01#		
			27000pF	±5%	GRM3195C2A273JA01#		
			33000pF	±5%	GRM3195C2A333JA01#		
			39000pF	±5%	GRM3195C2A393JA01#		
			CH	CH	1800pF	±5%	GRM3192C2A182JA01#
					2200pF	±5%	GRM3192C2A222JA01#
					2700pF	±5%	GRM3192C2A272JA01#
					3300pF	±5%	GRM3192C2A332JA01#
					3900pF	±5%	GRM3192C2A392JA01#
					4700pF	±5%	GRM3192C2A472JA01#
					5600pF	±5%	GRM3192C2A562JA01#
					6800pF	±5%	GRM3192C2A682JA01#
					8200pF	±5%	GRM3192C2A822JA01#
					10000pF	±5%	GRM3192C2A103JA01#
					12000pF	±5%	GRM3192C2A123JA01#
					15000pF	±5%	GRM3192C2A153JA01#

Part number # indicates the package specification code.



GRM Series Temperature Compensating Type Part Number List

(→ 3.2×1.6mm)

T max.	Rated Voltage	TC Code	Cap.	Tol.	Part Number	T max.	Rated Voltage	TC Code	Cap.	Tol.	Part Number				
0.95mm	100Vdc	CH	1800pF	±5%	GRM3192C2A183JA01#	1.0mm	1000Vdc	U2J	10pF	±5%	GRM31A7U3A100JW31#				
			2200pF	±5%	GRM3192C2A223JA01#				12pF	±5%	GRM31A7U3A120JW31#				
			2700pF	±5%	GRM3192C2A273JA01#				15pF	±5%	GRM31A7U3A150JW31#				
			3300pF	±5%	GRM3192C2A333JA01#				18pF	±5%	GRM31A7U3A180JW31#				
			3900pF	±5%	GRM3192C2A393JA01#				22pF	±5%	GRM31A7U3A220JW31#				
	50Vdc	COG	12000pF	±5%	GRM3195C1H123JA01#				27pF	±5%	GRM31A7U3A270JW31#				
			15000pF	±5%	GRM3195C1H153JA01#				33pF	±5%	GRM31A7U3A330JW31#				
			18000pF	±5%	GRM3195C1H183JA01#				39pF	±5%	GRM31A7U3A390JW31#				
			22000pF	±5%	GRM3195C1H223JA01#				47pF	±5%	GRM31A7U3A470JW31#				
			27000pF	±5%	GRM3195C1H273JA01#				56pF	±5%	GRM31A7U3A560JW31#				
			33000pF	±5%	GRM3195C1H333JA01#				68pF	±5%	GRM31A7U3A680JW31#				
			39000pF	±5%	GRM3195C1H393JA01#				82pF	±5%	GRM31A7U3A820JW31#				
			CH	12000pF	±5%				GRM3192C1H123JA01#	100pF	±5%	GRM31A7U3A101JW31#			
				15000pF	±5%				GRM3192C1H153JA01#	120pF	±5%	GRM31A7U3A121JW31#			
				18000pF	±5%				GRM3192C1H183JA01#	150pF	±5%	GRM31A7U3A151JW31#			
		22000pF		±5%	GRM3192C1H223JA01#				180pF	±5%	GRM31A7U3A181JW31#				
		27000pF		±5%	GRM3192C1H273JA01#				220pF	±5%	GRM31A7U3A221JW31#				
		33000pF		±5%	GRM3192C1H333JA01#				270pF	±5%	GRM31A7U3A271JW31#				
		39000pF		±5%	GRM3192C1H393JA01#				330pF	±5%	GRM31A7U3A331JW31#				
		SL		56000pF	±5%				GRM3191X1H563JA01#	630Vdc	COG	10pF	±5%	GRM31A5C2J100JW01#	
				U2J	56000pF				±5%			GRM3197U1H563JA01#	12pF	±5%	GRM31A5C2J120JW01#
		UJ			56000pF				±5%			GRM3193U1H563JA01#	15pF	±5%	GRM31A5C2J150JW01#
			1.0mm	2000Vdc	U2J				10pF			±5%	GRM31A7U3D100JW31#	18pF	±5%
		12pF							±5%			GRM31A7U3D120JW31#	22pF	±5%	GRM31A5C2J220JW01#
		15pF							±5%			GRM31A7U3D150JW31#	27pF	±5%	GRM31A5C2J270JW01#
	18pF	±5%							GRM31A7U3D180JW31#			33pF	±5%	GRM31A5C2J330JW01#	
	22pF	±5%							GRM31A7U3D220JW31#			39pF	±5%	GRM31A5C2J390JW01#	
	27pF	±5%							GRM31A7U3D270JW31#			47pF	±5%	GRM31A5C2J470JW01#	
	33pF	±5%							GRM31A7U3D330JW31#			56pF	±5%	GRM31A5C2J560JW01#	
	39pF	±5%							GRM31A7U3D390JW31#			68pF	±5%	GRM31A5C2J680JW01#	
	47pF	±5%							GRM31A7U3D470JW31#			82pF	±5%	GRM31A5C2J820JW01#	
	56pF	±5%							GRM31A7U3D560JW31#			100pF	±5%	GRM31A5C2J101JW01#	
	68pF	±5%							GRM31A7U3D680JW31#			120pF	±5%	GRM31A5C2J121JW01#	
1000Vdc	COG	10pF				±5%	GRM31A5C3A100JW01#	150pF	±5%			GRM31A5C2J151JW01#			
		12pF				±5%	GRM31A5C3A120JW01#	180pF	±5%			GRM31A5C2J181JW01#			
		15pF				±5%	GRM31A5C3A150JW01#	220pF	±5%			GRM31A5C2J221JW01#			
		18pF		±5%	GRM31A5C3A180JW01#	270pF	±5%	GRM31A5C2J271JW01#							
		22pF		±5%	GRM31A5C3A220JW01#	330pF	±5%	GRM31A5C2J331JW01#							
		27pF		±5%	GRM31A5C3A270JW01#	390pF	±5%	GRM31A5C2J391JW01#							
		33pF		±5%	GRM31A5C3A330JW01#	470pF	±5%	GRM31A5C2J471JW01#							
		39pF		±5%	GRM31A5C3A390JW01#	560pF	±5%	GRM31A5C2J561JW01#							
		47pF		±5%	GRM31A5C3A470JW01#	1200pF	±5%	GRM31A5C2J122JWA1#							
		56pF		±5%	GRM31A5C3A560JW01#	1500pF	±5%	GRM31A5C2J152JWA1#							
U2J	68pF	±5%		GRM31A5C3A680JW01#	1800pF	±5%	GRM31A5C2J182JWA1#								
	82pF	±5%		GRM31A5C3A820JW01#	U2J	10pF	±5%	GRM31A7U2J100JW31#							
	100pF	±5%		GRM31A5C3A101JW01#		12pF	±5%	GRM31A7U2J120JW31#							
	120pF	±5%	GRM31A5C3A121JW01#	15pF		±5%	GRM31A7U2J150JW31#								
	150pF	±5%	GRM31A5C3A151JW01#	18pF		±5%	GRM31A7U2J180JW31#								
	180pF	±5%	GRM31A5C3A181JW01#	22pF		±5%	GRM31A7U2J220JW31#								
	220pF	±5%	GRM31A5C3A221JW01#	27pF		±5%	GRM31A7U2J270JW31#								
	270pF	±5%	GRM31A5C3A271JWA1#	33pF		±5%	GRM31A7U2J330JW31#								
	330pF	±5%	GRM31A5C3A331JWA1#	39pF		±5%	GRM31A7U2J390JW31#								
	390pF	±5%	GRM31A5C3A391JWA1#	47pF		±5%	GRM31A7U2J470JW31#								
470pF	±5%	GRM31A5C3A471JWA1#	56pF	±5%		GRM31A7U2J560JW31#									

Part number # indicates the package specification code.

⚠Caution / Notice

GRM
 GR3
 GRJ
 GR4
 GR7
 GJM
 GQM
 GA2
 GA3 GB
 GA3 GD
 GA3 GF
 LLL
 LLA
 LLM
 LLR
 NFM
 KRM
 KR3
 GMA
 GMD

GRM Series Temperature Compensating Type Part Number List

(→ 3.2×1.6mm)

T max.	Rated Voltage	TC Code	Cap.	Tol.	Part Number	T max.	Rated Voltage	TC Code	Cap.	Tol.	Part Number				
1.0mm	630Vdc	U2J	68pF	±5%	GRM31A7U2J680JW31#	1.0mm	500Vdc	U2J	120pF	±5%	GRM31A7U2H121JW31#				
			82pF	±5%	GRM31A7U2J820JW31#				150pF	±5%	GRM31A7U2H151JW31#				
			100pF	±5%	GRM31A7U2J101JW31#				180pF	±5%	GRM31A7U2H181JW31#				
			120pF	±5%	GRM31A7U2J121JW31#				220pF	±5%	GRM31A7U2H221JW31#				
			150pF	±5%	GRM31A7U2J151JW31#				270pF	±5%	GRM31A7U2H271JW31#				
			180pF	±5%	GRM31A7U2J181JW31#				330pF	±5%	GRM31A7U2H331JW31#				
			220pF	±5%	GRM31A7U2J221JW31#				390pF	±5%	GRM31A7U2H391JW31#				
			270pF	±5%	GRM31A7U2J271JW31#				470pF	±5%	GRM31A7U2H471JW31#				
			330pF	±5%	GRM31A7U2J331JW31#				560pF	±5%	GRM31A7U2H561JW31#				
			390pF	±5%	GRM31A7U2J391JW31#				680pF	±5%	GRM31A7U2H681JW31#				
			470pF	±5%	GRM31A7U2J471JW31#				820pF	±5%	GRM31A7U2H821JW31#				
			560pF	±5%	GRM31A7U2J561JW31#				1000pF	±5%	GRM31A7U2H102JW31#				
			680pF	±5%	GRM31A7U2J681JW31#				1200pF	±5%	GRM31A7U2H122JW31#				
			820pF	±5%	GRM31A7U2J821JW31#				1500pF	±5%	GRM31A7U2H152JW31#				
			1000pF	±5%	GRM31A7U2J102JW31#				1800pF	±5%	GRM31A7U2H182JW31#				
			1200pF	±5%	GRM31A7U2J122JW31#				2200pF	±5%	GRM31A7U2H222JW31#				
			1500pF	±5%	GRM31A7U2J152JW31#				250Vdc	COG	390pF	±5%	GRM31A5C2E391JWA1#		
			1800pF	±5%	GRM31A7U2J182JW31#						470pF	±5%	GRM31A5C2E471JWA1#		
			2200pF	±5%	GRM31A7U2J222JW31#						560pF	±5%	GRM31A5C2E561JWA1#		
			500Vdc	COG	10pF						±5%	GRM31A5C2H100JW01#	680pF	±5%	GRM31A5C2E681JWA1#
					12pF						±5%	GRM31A5C2H120JW01#	820pF	±5%	GRM31A5C2E821JWA1#
					15pF						±5%	GRM31A5C2H150JW01#	1000pF	±5%	GRM31A5C2E102JWA1#
18pF	±5%	GRM31A5C2H180JW01#			1200pF	±5%	GRM31A5C2E122JWA1#								
22pF	±5%	GRM31A5C2H220JW01#			1500pF	±5%	GRM31A5C2E152JWA1#								
27pF	±5%	GRM31A5C2H270JW01#			1800pF	±5%	GRM31A5C2E182JWA1#								
33pF	±5%	GRM31A5C2H330JW01#			2200pF	±5%	GRM31A5C2E222JWA1#								
39pF	±5%	GRM31A5C2H390JW01#			2700pF	±5%	GRM31A5C2E272JWA1#								
47pF	±5%	GRM31A5C2H470JW01#			3300pF	±5%	GRM31A5C2E332JWA1#								
56pF	±5%	GRM31A5C2H560JW01#			3900pF	±5%	GRM31A5C2E392JWA1#								
68pF	±5%	GRM31A5C2H680JW01#			4700pF	±5%	GRM31A5C2E472JWA1#								
82pF	±5%	GRM31A5C2H820JW01#			5600pF	±5%	GRM31A5C2E562JWA1#								
100pF	±5%	GRM31A5C2H101JW01#			6800pF	±5%	GRM31A5C2E682JWA1#								
120pF	±5%	GRM31A5C2H121JW01#			U2J	2700pF	±5%	GRM31A7U2E272JW31#							
150pF	±5%	GRM31A5C2H151JW01#				3300pF	±5%	GRM31A7U2E332JW31#							
180pF	±5%	GRM31A5C2H181JW01#				3900pF	±5%	GRM31A7U2E392JW31#							
220pF	±5%	GRM31A5C2H221JW01#				4700pF	±5%	GRM31A7U2E472JW31#							
270pF	±5%	GRM31A5C2H271JW01#				5600pF	±5%	GRM31A7U2E562JW31#							
330pF	±5%	GRM31A5C2H331JW01#				200Vdc	U2J	2700pF			±5%	GRM31A7U2D272JW31#			
390pF	±5%	GRM31A5C2H391JW01#			3300pF			±5%	GRM31A7U2D332JW31#						
470pF	±5%	GRM31A5C2H471JW01#			3900pF			±5%	GRM31A7U2D392JW31#						
560pF	±5%	GRM31A5C2H561JW01#			4700pF			±5%	GRM31A7U2D472JW31#						
U2J	U2J	10pF	±5%	GRM31A7U2H100JW31#	5600pF			±5%	GRM31A7U2D562JW31#						
		12pF	±5%	GRM31A7U2H120JW31#	1.25mm			1000Vdc	COG	560pF	±5%	GRM31B5C3A561JWA1#			
		15pF	±5%	GRM31A7U2H150JW31#		680pF	±5%			GRM31B5C3A681JWA1#					
		18pF	±5%	GRM31A7U2H180JW31#		U2J	390pF			±5%	GRM31B7U3A391JW31#				
		22pF	±5%	GRM31A7U2H220JW31#			470pF			±5%	GRM31B7U3A471JW31#				
		27pF	±5%	GRM31A7U2H270JW31#			560pF			±5%	GRM31B7U3A561JW31#				
		33pF	±5%	GRM31A7U2H330JW31#			680pF			±5%	GRM31B7U3A681JW31#				
		39pF	±5%	GRM31A7U2H390JW31#	630Vdc		COG	680pF	±5%	GRM31B5C2J681JW01#					
		47pF	±5%	GRM31A7U2H470JW31#				820pF	±5%	GRM31B5C2J821JW01#					
		56pF	±5%	GRM31A7U2H560JW31#		1000pF		±5%	GRM31B5C2J102JW01#						
68pF	±5%	GRM31A7U2H680JW31#	2200pF	±5%		GRM31B5C2J222JWA1#									
82pF	±5%	GRM31A7U2H820JW31#	2700pF	±5%		GRM31B5C2J272JWA1#									
100pF	±5%	GRM31A7U2H101JW31#	U2J	2700pF		±5%		GRM31B7U2J272JW31#							

Part number # indicates the package specification code.



GRM Series Temperature Compensating Type Part Number List

(→ 3.2×1.6mm)

T max.	Rated Voltage	TC Code	Cap.	Tol.	Part Number		
1.25mm	630Vdc	U2J	3300pF	±5%	GRM31B7U2J332JW31#		
		500Vdc	COG	680pF	±5%	GRM31B5C2H681JW01#	
	820pF			±5%	GRM31B5C2H821JW01#		
	1000pF			±5%	GRM31B5C2H102JW01#		
	250Vdc	COG	8200pF	±5%	GRM31B5C2E822JWA1#		
			10000pF	±5%	GRM31B5C2E103JWA1#		
			12000pF	±5%	GRM31B5C2E123JWA1#		
	200Vdc	U2J	6800pF	±5%	GRM31B7U2D682JW31#		
			8200pF	±5%	GRM31B7U2D822JW31#		
			10000pF	±5%	GRM31B7U2D103JW31#		
		100Vdc	COG	47000pF	±5%	GRM31M5C2A473JA01#	D1
				56000pF	±5%	GRM31M5C2A563JA01#	D1
			CH	47000pF	±5%	GRM31M2C2A473JA01#	D1
	50Vdc	COG	47000pF	±5%	GRM31M5C1H473JA01#		
			56000pF	±5%	GRM31M5C1H563JA01#		
		CH	47000pF	±5%	GRM31M2C1H473JA01#		
			56000pF	±5%	GRM31M2C1H563JA01#		
		SL	68000pF	±5%	GRM31M1X1H683JA01#		
			82000pF	±5%	GRM31M1X1H823JA01#		
		U2J	0.10μF	±5%	GRM31M1X1H104JA01#		
			68000pF	±5%	GRM31M7U1H683JA01#		
			82000pF	±5%	GRM31M7U1H823JA01#		
		UJ	0.10μF	±5%	GRM31M7U1H104JA01#		
			68000pF	±5%	GRM31M3U1H683JA01#		
82000pF			±5%	GRM31M3U1H823JA01#			
1.8mm	1000Vdc	COG	820pF	±5%	GRM31C5C3A821JWA3#		
			1000pF	±5%	GRM31C5C3A102JWA3#		
		U2J	820pF	±5%	GRM31C7U3A821JW32#		
			1000pF	±5%	GRM31C7U3A102JW32#		
	630Vdc	COG	3300pF	±5%	GRM31C5C2J332JWA3#		
			U2J	3900pF	±5%	GRM31C7U2J392JW32#	
	500Vdc	U2J	4700pF	±5%	GRM31C7U2J472JW32#		
			3900pF	±5%	GRM31C7U2H392JW32#		
	250Vdc	COG	4700pF	±5%	GRM31C7U2H472JW32#		
			15000pF	±5%	GRM31C5C2E153JWA3#		
	100Vdc	U2J	15000pF	±5%	GRM31C7U2E153JW32#		
			18000pF	±5%	GRM31C7U2E183JW32#		
			22000pF	±5%	GRM31C7U2E223JW32#		
	50Vdc	COG	68000pF	±5%	GRM31C5C2A683JA01#	D1	
			82000pF	±5%	GRM31C5C2A823JA01#	D1	
		CH	0.10μF	±5%	GRM31C5C2A104JA01#	D1	
			68000pF	±5%	GRM31C2C2A683JA01#	D1	
		COG	82000pF	±5%	GRM31C2C2A823JA01#	D1	
0.10μF			±5%	GRM31C2C2A104JA01#	D1		

T max.	Rated Voltage	TC Code	Cap.	Tol.	Part Number		
1.8mm	50Vdc	COG	0.10μF	±5%	GRM31C5C1H104JA01#		
			CH	68000pF	±5%	GRM31C2C1H683JA01#	
				82000pF	±5%	GRM31C2C1H823JA01#	
	25Vdc	COG	0.10μF	±5%	GRM31C2C1H104JA01#		
			CH	0.12μF	±5%	GRM31C5C1E124JA01#	
				0.12μF	±5%	GRM31C2C1E124JA01#	
	16Vdc	COG	0.12μF	±5%	GRM31C5C1C124JA01#		
			CH	0.12μF	±5%	GRM31C2C1C124JA01#	
				0.12μF	±5%	GRM31C2C1C124JA01#	

3.2×2.5mm

T max.	Rated Voltage	TC Code	Cap.	Tol.	Part Number		
1.0mm	2000Vdc	U2J	82pF	±5%	GRM32A7U3D820JW31#		
			100pF	±5%	GRM32A7U3D101JW31#		
			120pF	±5%	GRM32A7U3D121JW31#		
			150pF	±5%	GRM32A7U3D151JW31#		
	630Vdc	U2J	1200pF	±5%	GRM32A7U2J122JW31#		
			1500pF	±5%	GRM32A7U2J152JW31#		
			1800pF	±5%	GRM32A7U2J182JW31#		
			2200pF	±5%	GRM32A7U2J222JW31#		
	500Vdc	U2J	1200pF	±5%	GRM32A7U2H122JW31#		
			1500pF	±5%	GRM32A7U2H152JW31#		
			1800pF	±5%	GRM32A7U2H182JW31#		
			2200pF	±5%	GRM32A7U2H222JW31#		
	1.25mm	2000Vdc	U2J	180pF	±5%	GRM32B7U3D181JW31#	
				220pF	±5%	GRM32B7U3D221JW31#	
		1000Vdc	U2J	1200pF	±5%	GRM32B7U3A122JW31#	
				630Vdc	U2J	5600pF	±5%
	500Vdc	U2J	5600pF	±5%	GRM32B7U2H562JW31#		
			1000Vdc	U2J	1500pF	±5%	GRM32Q7U3A152JW31#
630Vdc	U2J	6800pF	±5%	GRM32Q7U2J682JW31#			
		500Vdc	U2J	6800pF	±5%	GRM32Q7U2H682JW31#	
250Vdc	U2J	27000pF	±5%	GRM32Q7U2E273JW31#			
		1000Vdc	U2J	1800pF	±5%	GRM32D7U3A182JW31#	
630Vdc	U2J	2200pF	±5%	GRM32D7U3A222JW31#			
		8200pF	±5%	GRM32D7U2J822JW31#			
500Vdc	U2J	10000pF	±5%	GRM32D7U2J103JW31#			
		8200pF	±5%	GRM32D7U2H822JW31#			
250Vdc	U2J	10000pF	±5%	GRM32D7U2H103JW31#			
		33000pF	±5%	GRM32D7U2E333JW31#			
47000pF	±5%	GRM32D7U2E393JW31#	±5%	GRM32D7U2E393JW31#			
						47000pF	±5%

4.5×2.0mm

T max.	Rated Voltage	TC Code	Cap.	Tol.	Part Number	
1.0mm	3150Vdc	U2J	10pF	±5%	GRM42A7U3F100JW31#	
			12pF	±5%	GRM42A7U3F120JW31#	
			15pF	±5%	GRM42A7U3F150JW31#	
			18pF	±5%	GRM42A7U3F180JW31#	
			22pF	±5%	GRM42A7U3F220JW31#	
			27pF	±5%	GRM42A7U3F270JW31#	
			27pF	±5%	GRM42A7U3F270JW31#	

Part number # indicates the package specification code.

GRM Series Temperature Compensating Type Part Number List

(→ 4.5×2.0mm)

T max.	Rated Voltage	TC Code	Cap.	Tol.	Part Number
1.0mm	3150Vdc	U2J	33pF	±5%	GRM42A7U3F330JW31#
			39pF	±5%	GRM42A7U3F390JW31#
			47pF	±5%	GRM42A7U3F470JW31#
			56pF	±5%	GRM42A7U3F560JW31#
			68pF	±5%	GRM42A7U3F680JW31#
			82pF	±5%	GRM42A7U3F820JW31#
			100pF	±5%	GRM42A7U3F101JW31#

4.5×3.2mm

T max.	Rated Voltage	TC Code	Cap.	Tol.	Part Number
1.5mm	1000Vdc	U2J	2700pF	±5%	GRM43Q7U3A272JW31#
			3300pF	±5%	GRM43Q7U3A332JW31#
	630Vdc	U2J	12000pF	±5%	GRM43Q7U2J123JW31#
			500Vdc	U2J	12000pF
2.0mm	1000Vdc	U2J	3900pF	±5%	GRM43D7U3A392JW31#
			4700pF	±5%	GRM43D7U3A472JW31#
	630Vdc	U2J	15000pF	±5%	GRM43D7U2J153JW31#
			18000pF	±5%	GRM43D7U2J183JW31#
			22000pF	±5%	GRM43D7U2J223JW31#
	500Vdc	U2J	15000pF	±5%	GRM43D7U2H153JW31#
			18000pF	±5%	GRM43D7U2H183JW31#
			22000pF	±5%	GRM43D7U2H223JW31#

5.7×5.0mm

T max.	Rated Voltage	TC Code	Cap.	Tol.	Part Number
1.5mm	1000Vdc	U2J	5600pF	±5%	GRM55Q7U3A562JW31#
			6800pF	±5%	GRM55Q7U3A682JW31#
	630Vdc	U2J	27000pF	±5%	GRM55Q7U2J273JW31#
			500Vdc	U2J	27000pF
2.0mm	1000Vdc	U2J	8200pF	±5%	GRM55D7U3A822JW31#
			10000pF	±5%	GRM55D7U3A103JW31#
	630Vdc	U2J	33000pF	±5%	GRM55D7U2J333JW31#
			39000pF	±5%	GRM55D7U2J393JW31#
			47000pF	±5%	GRM55D7U2J473JW31#
	500Vdc	U2J	33000pF	±5%	GRM55D7U2H333JW31#
			39000pF	±5%	GRM55D7U2H393JW31#
			47000pF	±5%	GRM55D7U2H473JW31#

GRM
 GR3
 GRJ
 GR4
 GR7
 GJM
 GQM
 GA2
 GA3 GB
 GA3 GD
 GA3 GF
 LLL
 LLA
 LLM
 LLR
 NFM
 KRM
 KR3
 GMA
 GMD
 ⚠Caution /Notice

GRM Series High Dielectric Constant Type Part Number List

0.4×0.2mm

T max.	Rated Voltage	TC Code	Cap.	Tol.	Part Number		
0.22mm	16Vdc	X7R	100pF	±10%	GRM022R71C101KE14#		
				±20%	GRM022R71C101ME14#		
			150pF	±10%	GRM022R71C151KE14#		
				±20%	GRM022R71C151ME14#		
			220pF	±10%	GRM022R71C221KE14#		
				±20%	GRM022R71C221ME14#		
			330pF	±10%	GRM022R71C331KE14#		
				±20%	GRM022R71C331ME14#		
			470pF	±10%	GRM022R71C471KE14#		
				±20%	GRM022R71C471ME14#		
			1000pF	±10%	GRM022R71C102KE14#		
				±20%	GRM022R71C102ME14#		
			10Vdc	X7R	100pF	±10%	GRM022R71A101KA01#
						±20%	GRM022R71A101MA01#
					150pF	±10%	GRM022R71A151KA01#
						±20%	GRM022R71A151MA01#
					220pF	±10%	GRM022R71A221KA01#
						±20%	GRM022R71A221MA01#
	330pF	±10%			GRM022R71A331KA01#		
		±20%			GRM022R71A331MA01#		
	470pF	±10%			GRM022R71A471KA01#		
		±20%			GRM022R71A471MA01#		
	680pF	±10%			GRM022R71A681KA12#		
		±20%			GRM022R71A681MA12#		
	820pF	±10%			GRM022R71A821KA12#		
		±20%			GRM022R71A821MA12#		
	1000pF	±10%			GRM022R71A102KA12#		
		±20%			GRM022R71A102MA12#		
	X5R	X5R			100pF	±10%	GRM022R61A101KA01#
						±20%	GRM022R61A101MA01#
			150pF	±10%	GRM022R61A151KA01#		
				±20%	GRM022R61A151MA01#		
			220pF	±10%	GRM022R61A221KA01#		
				±20%	GRM022R61A221MA01#		
			330pF	±10%	GRM022R61A331KA01#		
				±20%	GRM022R61A331MA01#		
470pF			±10%	GRM022R61A471KA01#			
			±20%	GRM022R61A471MA01#			
680pF			±10%	GRM022R61A681KE19#			
			±20%	GRM022R61A681ME19#			
1000pF			±10%	GRM022R61A102KE19#			
			±20%	GRM022R61A102ME19#			
1500pF			±10%	GRM022R61A152KE19#			
			±20%	GRM022R61A152ME19#			
2200pF			±10%	GRM022R61A222KE19#			
			±20%	GRM022R61A222ME19#			
3300pF	±10%	GRM022R61A332KE19#					
	±20%	GRM022R61A332ME19#					
4700pF	±10%	GRM022R61A472KE19#					
	±20%	GRM022R61A472ME19#					
6800pF	±10%	GRM022R61A682KE19#					
	±20%	GRM022R61A682ME19#					

T max.	Rated Voltage	TC Code	Cap.	Tol.	Part Number			
0.22mm	10Vdc	X5R	1000pF	±10%	GRM022R61A103KE19#			
				±20%	GRM022R61A103ME19#			
			B	100pF	±10%	GRM022B11A101KA01#		
					±20%	GRM022B11A101MA01#		
			150pF	±10%	GRM022B11A151KA01#			
				±20%	GRM022B11A151MA01#			
			220pF	±10%	GRM022B11A221KA01#			
				±20%	GRM022B11A221MA01#			
			330pF	±10%	GRM022B11A331KA01#			
				±20%	GRM022B11A331MA01#			
			470pF	±10%	GRM022B11A471KA01#			
				±20%	GRM022B11A471MA01#			
			680pF	±10%	GRM022B31A681KE19#			
				±20%	GRM022B31A681ME19#			
			1000pF	±10%	GRM022B31A102KE19#			
				±20%	GRM022B31A102ME19#			
			1500pF	±10%	GRM022B31A152KE19#			
				±20%	GRM022B31A152ME19#			
		2200pF	±10%	GRM022B31A222KE19#				
			±20%	GRM022B31A222ME19#				
		3300pF	±10%	GRM022B31A332KE19#				
			±20%	GRM022B31A332ME19#				
		4700pF	±10%	GRM022B31A472KE19#				
			±20%	GRM022B31A472ME19#				
		6800pF	±10%	GRM022B31A682KE19#				
			±20%	GRM022B31A682ME19#				
		10000pF	±10%	GRM022B31A103KE19#				
			±20%	GRM022B31A103ME19#				
		6.3Vdc	X5R	1000pF	±20%	GRM022R60J102ME19#		
					±20%	GRM022R60J152ME19#		
				2200pF	±20%	GRM022R60J222ME19#		
					±20%	GRM022R60J332ME19#		
				4700pF	±20%	GRM022R60J472ME19#		
					±20%	GRM022R60J682ME19#		
				10000pF	±20%	GRM022R60J103ME19#		
					±20%	GRM022R60J153ME15# D1		
				22000pF	±10%	GRM022R60J223KE15# D1		
					±20%	GRM022R60J223ME15# D1		
				33000pF	±20%	GRM022R60J333ME15# D1		
					±20%	GRM022R60J473ME15# D1		
				68000pF	±20%	GRM022R60J683ME15# D1		
					±20%	GRM022R60J104ME15# D1		
				B	B	1000pF	±20%	GRM022B30J102ME19#
							±20%	GRM022B30J152ME19#
						2200pF	±20%	GRM022B30J222ME19#
							±20%	GRM022B30J332ME19#
		4700pF	±20%			GRM022B30J472ME19#		
			±20%			GRM022B30J682ME19#		
		6800pF	±20%			GRM022B30J103ME19#		
			±20%			GRM022B30J103ME19#		
		4Vdc	X6T			0.10µF	±20%	GRM022D80G104ME15# D1
							±20%	GRM022R60G153KE15#
						X5R	15000pF	±10%
			±20%					GRM022R60G153ME15#
22000pF	±10%		GRM022R60G223KE15#					
	±20%		GRM022R60G223ME15#					

- GRM
- GR3
- GRJ
- GR4
- GR7
- GJM
- GQM
- GA2
- GA3 GB
- GA3 GD
- GA3 GF
- LLL
- LLA
- LLM
- LLR
- NFM
- KRM
- KR3
- GMA
- GMD
- ⚠Caution /Notice

Part number # indicates the package specification code.

GRM Series High Dielectric Constant Type Part Number List

(→ 0.4×0.2mm)

T max.	Rated Voltage	TC Code	Cap.	Tol.	Part Number
0.22mm	4Vdc	X5R	33000pF	±10%	GRM022R60G333KE15#
				±20%	GRM022R60G333ME15#
			47000pF	±10%	GRM022R60G473KE15#
				±20%	GRM022R60G473ME15#
			68000pF	±20%	GRM022R60G683ME15#
				0.10μF	±20%
2.5Vdc	X6T	0.10μF	±20%	GRM022D80E104ME15#	

T max.	Rated Voltage	TC Code	Cap.	Tol.	Part Number
0.33mm	25Vdc	X7R	4700pF	±20%	GRM033R71E472ME14# D1
				±10%	GRM033R71E682KE14# D1
			6800pF	±20%	GRM033R71E682ME14# D1
				±10%	GRM033R71E103KE14# D1
			10000pF	±20%	GRM033R71E103ME14# D1
				±10%	GRM033R71E103ME14# D1
		R	100pF	±10%	GRM033R11E101KA01#
			150pF	±10%	GRM033R11E151KA01#
			220pF	±10%	GRM033R11E221KA01#
			330pF	±10%	GRM033R11E331KA01#
			470pF	±10%	GRM033R11E471KA01#
			680pF	±10%	GRM033R11E681KA01#
	1000pF	±10%	GRM033R11E102KA01#		
	1500pF	±10%	GRM033R11E152KA01#		
	X6S	0.10μF	±10%	GRM033C81E104KE14# D1	
			±20%	GRM033C81E104ME14# D1	
		X5R	4700pF	±10%	GRM033R61E472KA12# D1
				±20%	GRM033R61E472MA12# D1
			6800pF	±10%	GRM033R61E682KA12# D1
				±20%	GRM033R61E682MA12# D1
	10000pF	±10%	GRM033R61E103KA12# D1		
		±20%	GRM033R61E103MA12# D1		
	0.10μF	±10%	GRM033R61E104KE14#		
	±20%	GRM033R61E104ME14#			
B	1000pF	±10%	GRM033B11E102KA01#		
		±20%	GRM033B11E102MA01#		
	1500pF	±10%	GRM033B11E152KA01#		
		±20%	GRM033B11E152MA01#		
	2200pF	±10%	GRM033B31E222KA12#		
		±20%	GRM033B31E222MA12#		
	3300pF	±10%	GRM033B31E332KA12#		
		±20%	GRM033B31E332MA12#		
	10000pF	±10%	GRM033B31E103KA12# D1		
		±20%	GRM033B31E103MA12# D1		
	16Vdc	X7R	2200pF	±10%	GRM033R71C222KA88#
				±10%	GRM033R71C332KA88#
4700pF			±10%	GRM033R71C472KE14#	
			±20%	GRM033R71C472ME14#	
6800pF			±10%	GRM033R71C682KE14#	
			±20%	GRM033R71C682ME14#	
10000pF		±10%	GRM033R71C103KE14#		
		±20%	GRM033R71C103ME14#		
X7S		0.10μF	±10%	GRM033C71C104KE14# D1	
			±20%	GRM033C71C104ME14# D1	
R		2200pF	±10%	GRM033R11C222KA88#	
			±10%	GRM033R11C332KA88#	
X6S	0.10μF	±10%	GRM033C81C104KE14#		
		±20%	GRM033C81C104ME14#		
X5R	10000pF	±10%	GRM033R61C103KA12#		
		±20%	GRM033R61C103MA12#		
	15000pF	±10%	GRM033R61C153KE84# D1		
		±20%	GRM033R61C153ME84# D1		
	22000pF	±10%	GRM033R61C223KE84# D1		
		±20%	GRM033R61C223ME84# D1		
33000pF	±10%	GRM033R61C333KE84# D1			

0.6×0.3mm

T max.	Rated Voltage	TC Code	Cap.	Tol.	Part Number					
0.33mm	50Vdc	X7R	100pF	±10%	GRM033R71H101KA12#					
				±20%	GRM033R71H101MA12#					
			150pF	±10%	GRM033R71H151KA12#					
				±20%	GRM033R71H151MA12#					
			220pF	±10%	GRM033R71H221KA12#					
				±20%	GRM033R71H221MA12#					
			330pF	±10%	GRM033R71H331KA12#					
				±20%	GRM033R71H331MA12#					
			470pF	±10%	GRM033R71H471KA12#					
				±20%	GRM033R71H471MA12#					
			680pF	±10%	GRM033R71H681KA12#					
				±20%	GRM033R71H681MA12#					
			1000pF	±10%	GRM033R71H102KA12#					
				±20%	GRM033R71H102MA12#					
			1500pF	±10%	GRM033R71H152KA12#					
				±20%	GRM033R71H152MA12#					
			X5R	470pF	X5R	470pF	±10%	GRM033R61H471KA12#		
							B	100pF	±10%	GRM033B31H101KA12#
									±20%	GRM033B31H101MA12#
								150pF	±10%	GRM033B31H151KA12#
									±20%	GRM033B31H151MA12#
								220pF	±10%	GRM033B31H221KA12#
									±20%	GRM033B31H221MA12#
							330pF	±10%	GRM033B31H331KA12#	
								±20%	GRM033B31H331MA12#	
							470pF	±10%	GRM033B31H471KA12#	
								±20%	GRM033B31H471MA12#	
							680pF	±10%	GRM033B31H681KA12#	
								±20%	GRM033B31H681MA12#	
							1000pF	±10%	GRM033B31H102KA12#	
								±20%	GRM033B31H102MA12#	
							1500pF	±10%	GRM033B31H152KA12#	
								±20%	GRM033B31H152MA12#	
							35Vdc	X5R	0.10μF	±10%
			±20%	GRM033R6YA104ME14# D1						
			25Vdc	X7R	1000pF	±10%				GRM033R71E102KA01#
						±10%				GRM033R71E152KA01#
					2200pF	±10%				GRM033R71E222KA12#
						±20%				GRM033R71E222MA12#
			3300pF	±10%	GRM033R71E332KA12#					
				±20%	GRM033R71E332MA12#					
			4700pF	±10%	GRM033R71E472KE14# D1					

Part number # indicates the package specification code.



GRM Series High Dielectric Constant Type Part Number List

(→ 0.6×0.3mm)

T max.	Rated Voltage	TC Code	Cap.	Tol.	Part Number		
0.33mm	16Vdc	X5R	3300pF	±20%	GRM033R61C333ME84#	D1	
			4700pF	±10%	GRM033R61C473KE84#	D1	
				±20%	GRM033R61C473ME84#	D1	
			6800pF	±10%	GRM033R61C683KE84#	D1	
				±20%	GRM033R61C683ME84#	D1	
			0.10μF	±10%	GRM033R61C104KE14#		
				±20%	GRM033R61C104ME14#		
			B	2200pF	±10%	GRM033B31C222KA87#	
					±20%	GRM033B31C222MA87#	
				3300pF	±10%	GRM033B31C332KA87#	
		±20%			GRM033B31C332MA87#		
		10000pF		±10%	GRM033B31C103KA12#		
				±20%	GRM033B31C103MA12#		
		15000pF		±10%	GRM033B31C153KE84#	D1	
				±20%	GRM033B31C153ME84#	D1	
		22000pF		±10%	GRM033B31C223KE84#	D1	
				±20%	GRM033B31C223ME84#	D1	
		33000pF	±10%	GRM033B31C333KE84#	D1		
			±20%	GRM033B31C333ME84#	D1		
		47000pF	±10%	GRM033B31C473KE84#	D1		
	±20%		GRM033B31C473ME84#	D1			
	68000pF	±10%	GRM033B31C683KE84#	D1			
		±20%	GRM033B31C683ME84#	D1			
	0.10μF	±10%	GRM033B31C104KE84#	D1			
		±20%	GRM033B31C104ME84#	D1			
	10Vdc	X7R	4700pF	±10%	GRM033R71A472KA01#		
				±20%	GRM033R71A472MA01#		
			6800pF	±10%	GRM033R71A682KA01#		
				±20%	GRM033R71A682MA01#		
			10000pF	±10%	GRM033R71A103KA01#		
				±20%	GRM033R71A103MA01#		
			X7S	0.10μF	±10%	GRM033C71A104KE14#	
					±20%	GRM033C71A104ME14#	
			R	4700pF	±10%	GRM033R11A472KA01#	
					±20%	GRM033R11A472MA01#	
		6800pF		±10%	GRM033R11A682KA01#		
				±20%	GRM033R11A682MA01#		
		10000pF	±10%	GRM033R11A103KA01#			
			±20%	GRM033R11A103MA01#			
		X5R	4700pF	±10%	GRM033R61A472KA01#		
				±20%	GRM033R61A472MA01#		
			6800pF	±10%	GRM033R61A682KA01#		
				±20%	GRM033R61A682MA01#		
			15000pF	±10%	GRM033R61A153KE84#		
				±20%	GRM033R61A153ME84#		
	22000pF		±10%	GRM033R61A223KE84#			
			±20%	GRM033R61A223ME84#			
	33000pF		±10%	GRM033R61A333KE84#			
			±20%	GRM033R61A333ME84#			
	47000pF	±10%	GRM033R61A473KE84#				
±20%		GRM033R61A473ME84#					
68000pF	±10%	GRM033R61A683KE84#					
	±20%	GRM033R61A683ME84#					
0.10μF	±10%	GRM033R61A104KE84#					
	±20%	GRM033R61A104ME84#					

T max.	Rated Voltage	TC Code	Cap.	Tol.	Part Number		
0.33mm	10Vdc	X5R	0.10μF	±20%	GRM033R61A104ME84#		
			0.22μF	±20%	GRM033R61A224ME90#	D1	
				B	4700pF	±10%	GRM033B11A472KA01#
			±20%			GRM033B11A472MA01#	
			6800pF	±10%	GRM033B11A682KA01#		
				±20%	GRM033B11A682MA01#		
			15000pF	±10%	GRM033B31A153KE84#		
				±20%	GRM033B31A153ME84#		
			22000pF	±10%	GRM033B31A223KE84#		
				±20%	GRM033B31A223ME84#		
		33000pF	±10%	GRM033B31A333KE84#			
			±20%	GRM033B31A333ME84#			
		47000pF	±10%	GRM033B31A473KE84#			
			±20%	GRM033B31A473ME84#			
		68000pF	±10%	GRM033B31A683KE84#			
			±20%	GRM033B31A683ME84#			
		0.10μF	±10%	GRM033B31A104KE84#			
			±20%	GRM033B31A104ME84#			
		6.3Vdc	X7R	4700pF	±10%	GRM033R70J472KA01#	
					±10%	GRM033R70J682KA01#	
	±10%				GRM033R70J103KA01#		
	R		4700pF	±10%	GRM033R10J472KA01#		
				±10%	GRM033R10J682KA01#		
				±10%	GRM033R10J103KA01#		
	X6S		15000pF	±10%	GRM033C80J153KE01#		
				±20%	GRM033C80J153ME01#		
			22000pF	±10%	GRM033C80J223KE01#		
				±20%	GRM033C80J223ME01#		
	33000pF	±10%	GRM033C80J333KE01#				
		±20%	GRM033C80J333ME01#				
	47000pF	±10%	GRM033C80J473KE19#				
		±20%	GRM033C80J473ME19#				
	68000pF	±10%	GRM033C80J683KE84#	D1			
		±20%	GRM033C80J683ME84#	D1			
	0.10μF	±10%	GRM033C80J104KE84#	D1			
		±20%	GRM033C80J104ME84#	D1			
	0.22μF	±20%	GRM033C80J224ME90#	D1			
		X5R	0.22μF	±20%	GRM033R60J224ME90#		
	B	4700pF	±10%	GRM033B10J472KA01#			
			±10%	GRM033B10J682KA01#			
		15000pF	±10%	GRM033B10J153KE01#			
			±20%	GRM033B10J153ME01#			
		22000pF	±10%	GRM033B10J223KE01#			
	±20%		GRM033B10J223ME01#				
	33000pF	±10%	GRM033B10J333KE01#				
		±20%	GRM033B10J333ME01#				
	4Vdc	X6S	0.22μF	±20%	GRM033C80G224ME90#		

1.0×0.5mm

T max.	Rated Voltage	TC Code	Cap.	Tol.	Part Number	
0.22mm	10Vdc	X5R	0.10μF	±10%	GRM152R61A104KE19#	D1
				±20%	GRM152R61A104ME19#	D1

Part number # indicates the package specification code.

GRM Series High Dielectric Constant Type Part Number List

(→ 1.0×0.5mm)

T max.	Rated Voltage	TC Code	Cap.	Tol.	Part Number		
0.22mm	10Vdc	X5R	0.22µF	±10%	GRM152R61A224KE19#	D1	
				±20%	GRM152R61A224ME19#	D1	
			B	0.10µF	±10%	GRM152B31A104KE19#	D1
					±20%	GRM152B31A104ME19#	D1
				0.22µF	±10%	GRM152B31A224KE19#	D1
					±20%	GRM152B31A224ME19#	D1
		6.3Vdc	X6S	0.10µF	±10%	GRM152C80J104KE19#	D1
					±20%	GRM152C80J104ME19#	D1
				0.22µF	±10%	GRM152C80J224KE19#	D1
					±20%	GRM152C80J224ME19#	D1
			X5R	0.10µF	±10%	GRM152R60J104KE19#	
					±20%	GRM152R60J104ME19#	
	0.22µF	±10%	GRM152R60J224KE19#				
		±20%	GRM152R60J224ME19#				
	4Vdc	X7T	0.10µF	±10%	GRM152D70G104KE15#	D1	
				±20%	GRM152D70G104ME15#	D1	
			0.22µF	±10%	GRM152D70G224KE15#	D1	
				±20%	GRM152D70G224ME15#	D1	
		X6S	0.10µF	±10%	GRM152C80G104KE19#		
				±20%	GRM152C80G104ME19#		
	0.22µF	±10%	GRM152C80G224KE19#				
		±20%	GRM152C80G224ME19#				
	2.5Vdc	X6T	0.47µF	±20%	GRM152D80G474ME15#		
				±20%	GRM152D80G105ME15#	D1	
		X5R	1.0µF	±20%	GRM152R60G105ME15#		
				±20%	GRM152R60G105ME15#	D1	
		X7T	0.10µF	±10%	GRM152D70E104KE19#		
				±20%	GRM152D70E104ME19#		
	0.22µF	±10%	GRM152D70E224KE19#				
		±20%	GRM152D70E224ME19#				
	0.3mm	50Vdc	X7R	220pF	±10%	GRM15XR71H221KA86#	
					±10%	GRM15XR71H331KA86#	
				330pF	±10%	GRM15XR71H331KA86#	
					±10%	GRM15XR71H331KA86#	
				470pF	±10%	GRM15XR71H471KA86#	
					±10%	GRM15XR71H471KA86#	
				680pF	±10%	GRM15XR71H681KA86#	
					±10%	GRM15XR71H681KA86#	
				1000pF	±10%	GRM15XR71H102KA86#	
					±10%	GRM15XR71H102KA86#	
				1500pF	±10%	GRM15XR71H152KA86#	
					±10%	GRM15XR71H152KA86#	
			R	220pF	±10%	GRM15XR11H221KA86#	
					±10%	GRM15XR11H331KA86#	
				330pF	±10%	GRM15XR11H331KA86#	
					±10%	GRM15XR11H331KA86#	
				470pF	±10%	GRM15XR11H471KA86#	
					±10%	GRM15XR11H471KA86#	
680pF			±10%	GRM15XR11H681KA86#			
			±10%	GRM15XR11H681KA86#			
B			1000pF	±10%	GRM15XR11H102KA86#		
				±10%	GRM15XR11H102KA86#		
			1500pF	±10%	GRM15XR11H152KA86#		
				±10%	GRM15XR11H152KA86#		
		220pF	±10%	GRM15XB11H221KA86#			
			±20%	GRM15XB11H221MA86#			
330pF		±10%	GRM15XB11H331KA86#				
		±20%	GRM15XB11H331MA86#				
470pF		±10%	GRM15XB11H471KA86#				
		±20%	GRM15XB11H471MA86#				
0.3mm		50Vdc	X7R	220pF	±10%	GRM15XR71H221KA01#	
					±10%	GRM15XR71H331KA01#	
				330pF	±10%	GRM15XR71H331KA01#	
					±10%	GRM15XR71H331KA01#	
				470pF	±10%	GRM15XR71H471KA01#	
					±10%	GRM15XR71H471KA01#	
			R	220pF	±10%	GRM15XR11H221KA01#	
					±10%	GRM15XR11H331KA01#	
				330pF	±10%	GRM15XR11H331KA01#	
					±10%	GRM15XR11H331KA01#	
				470pF	±10%	GRM15XR11H471KA01#	
					±10%	GRM15XR11H471KA01#	
		B	220pF	±10%	GRM15XB11H221KA01#		
				±20%	GRM15XB11H221MA01#		
			330pF	±10%	GRM15XB11H331KA01#		
				±20%	GRM15XB11H331MA01#		
			470pF	±10%	GRM15XB11H471KA01#		
				±20%	GRM15XB11H471MA01#		
	100Vdc	X7R	220pF	±10%	GRM155R72A221KA01#		
				±10%	GRM155R72A331KA01#		
			330pF	±10%	GRM155R72A331KA01#		
				±10%	GRM155R72A471KA01#		
			470pF	±10%	GRM155R72A471KA01#		
				±10%	GRM155R72A681KA01#		
50Vdc		X7R	220pF	±10%	GRM155R71H221KA01#		
				±10%	GRM155R71H331KA01#		
		330pF	±10%	GRM155R71H331KA01#			
			±10%	GRM155R71H471KA01#			
		470pF	±10%	GRM155R71H471KA01#			
			±10%	GRM155R71H681KA01#			

T max.	Rated Voltage	TC Code	Cap.	Tol.	Part Number			
0.3mm	50Vdc	B	680pF	±10%	GRM15XB11H681KA86#			
				±20%	GRM15XB11H681MA86#			
			1000pF	±10%	GRM15XB11H102KA86#			
				±20%	GRM15XB11H102MA86#			
				1500pF	±10%	GRM15XB11H152KA86#		
					±20%	GRM15XB11H152MA86#		
		25Vdc	X7R	2200pF	±10%	GRM15XR71E222KA86#		
					±20%	GRM15XR71E222MA86#		
				B	2200pF	±10%	GRM15XB11E222KA86#	
			±20%			GRM15XB11E222MA86#		
			X7R		3300pF	±10%	GRM15XR71C332KA86#	
				±20%		GRM15XR71C332MA86#		
	4700pF	±10%		GRM15XR71C472KA86#				
		±20%	GRM15XR71C472MA86#					
	16Vdc	X7R	6800pF	±10%	GRM15XR71C682KA86#			
				±20%	GRM15XR71C682MA86#			
			10000pF	±10%	GRM15XR71C103KA86#			
				±20%	GRM15XR71C103MA86#			
			B	3300pF	±10%	GRM15XB11C332KA86#		
					±20%	GRM15XB11C332MA86#		
	4700pF	±10%	GRM15XB11C472KA86#					
		±20%	GRM15XB11C472MA86#					
	10Vdc	X5R	15000pF	±10%	GRM15XR61A153KA86#			
				±20%	GRM15XR61A153MA86#			
			22000pF	±10%	GRM15XR61A223KA86#			
				±20%	GRM15XR61A223MA86#			
			33000pF	±10%	GRM15XR61A333KA86#			
				±20%	GRM15XR61A333MA86#			
	0.33mm	10Vdc	X5R	1.0µF	±20%	GRM153R61A105ME95#	D1	
					±20%	GRM153B31A105ME95#	D1	
			6.3Vdc	X6T	1.0µF	±20%	GRM153D80J105ME95#	D1
						±20%	GRM153R60J105ME95#	
		4Vdc	X6T	1.0µF	±20%	GRM153D80G105ME95#		
					±20%	GRM153B30J105ME95#		
			X5R	1.0µF	±20%	GRM153R60J105ME95#		
					±20%	GRM153B30J105ME95#		
		100Vdc	X7R	220pF	±10%	GRM155R72A221KA01#		
					±10%	GRM155R72A331KA01#		
				330pF	±10%	GRM155R72A331KA01#		
					±10%	GRM155R72A471KA01#		
	470pF			±10%	GRM155R72A471KA01#			
				±10%	GRM155R72A681KA01#			
	50Vdc		X7R	220pF	±10%	GRM155R71H221KA01#		
					±10%	GRM155R71H331KA01#		
			330pF	±10%	GRM155R71H331KA01#			
				±10%	GRM155R71H471KA01#			
			470pF	±10%	GRM155R71H471KA01#			
				±10%	GRM155R71H681KA01#			

Part number # indicates the package specification code.

- GRM
- GR3
- GRJ
- GR4
- GR7
- GJM
- GQM
- GA2
- GA3 GB
- GA3 GD
- GA3 GF
- LLL
- LLA
- LLM
- LLR
- NFM
- KRM
- KR3
- GMA
- GMD

GRM Series High Dielectric Constant Type Part Number List

(→ 1.0×0.5mm)

T max.	Rated Voltage	TC Code	Cap.	Tol.	Part Number	T max.	Rated Voltage	TC Code	Cap.	Tol.	Part Number				
0.55mm	50Vdc	X7R	3300pF	±10%	GRM155R71H332KA01#	0.55mm	50Vdc	B	3300pF	±20%	GRM155B11H332MA01#				
			4700pF	±10%	GRM155R71H472KA01#				4700pF	±10%	GRM155B11H472KA01#				
			6800pF	±10%	GRM155R71H682KA88#					±20%	GRM155B11H472MA01#				
			10000pF	±10%	GRM155R71H103KA88#				6800pF	±10%	GRM155B31H682KA88#				
			15000pF	±10%	GRM155R71H153KA12#					±20%	GRM155B31H682MA88#				
			22000pF	±10%	GRM155R71H223KA12#				10000pF	±10%	GRM155B31H103KA88#				
			33000pF	±10%	GRM155R71H333KE14#					±20%	GRM155B31H103MA88#				
				±20%	GRM155R71H333ME14#				15000pF	±10%	GRM155B31H153KA12#				
			47000pF	±10%	GRM155R71H473KE14#					±20%	GRM155B31H153MA12#				
				±20%	GRM155R71H473ME14#				22000pF	±10%	GRM155B31H223KA12#				
			68000pF	±10%	GRM155R71H683KE14#					±20%	GRM155B31H223MA12#				
				±20%	GRM155R71H683ME14#				0.10μF	±10%	GRM155B31H104KE14#				
			0.10μF	±10%	GRM155R71H104KE14#					±20%	GRM155B31H104ME14#				
				±20%	GRM155R71H104ME14#				35Vdc	X6S	0.22μF	±10%	GRM155C8YA224KE01#	D1	
				±20%	GRM155C8YA224ME01#						D1				
			220pF	±10%	GRM155R11H221KA01#						X5R	0.22μF	±10%	GRM155R6YA224KE01#	D1
			330pF	±10%	GRM155R11H331KA01#								±20%	GRM155R6YA224ME01#	D1
			470pF	±10%	GRM155R11H471KA01#							0.47μF	±10%	GRM155R6YA474KE01#	D1
		680pF	±10%	GRM155R11H681KA01#				±20%				GRM155R6YA474ME01#	D1		
		1000pF	±10%	GRM155R11H102KA01#	25Vdc			X7R		2200pF		±10%	GRM155R71E222KA01#		
		1500pF	±10%	GRM155R11H152KA01#						10000pF		±10%	GRM155R71E103KA01#		
		2200pF	±10%	GRM155R11H222KA01#						15000pF	±10%	GRM155R71E153KA61#			
		3300pF	±10%	GRM155R11H332KA01#						22000pF	±10%	GRM155R71E223KA61#			
		4700pF	±10%	GRM155R11H472KA01#						33000pF	±10%	GRM155R71E333KA88#			
		6800pF	±10%	GRM155R11H682KA88#						47000pF	±10%	GRM155R71E473KA88#			
		10000pF	±10%	GRM155R11H103KA88#				68000pF		±10%	GRM155R71E683KE14#				
			±20%	GRM155C81H333KE14#						±20%	GRM155R71E683ME14#				
			±20%	GRM155C81H473KE14#				0.10μF		±10%	GRM155R71E104KE14#				
			±20%	GRM155C81H473ME14#						±20%	GRM155R71E104ME14#				
			±10%	GRM155C81H683KE14#				R		6800pF	±10%	GRM155R11E682KA01#			
			±20%	GRM155C81H683ME14#						10000pF	±10%	GRM155R11E103KA01#			
		33000pF	±10%	GRM155R61H333KE14#	15000pF				±10%	GRM155R11E153KA61#					
			±20%	GRM155R61H333ME14#	22000pF				±10%	GRM155R11E223KA61#					
		47000pF	±10%	GRM155R61H473KE14#	33000pF				±10%	GRM155R11E333KA88#					
			±20%	GRM155R61H473ME14#	47000pF				±10%	GRM155R11E473KA88#					
		68000pF	±10%	GRM155R61H683KE14#	X6S				0.22μF	±10%	GRM155C81E224KE01#				
			±20%	GRM155R61H683ME14#						±20%	GRM155C81E224ME01#				
		0.10μF	±10%	GRM155R61H104KE14#					X5R	68000pF	±10%	GRM155R61E683KA87#			
			±20%	GRM155R61H104ME14#							±20%	GRM155R61E683MA87#			
		220pF	±10%	GRM155B11H221KA01#						0.10μF	±10%	GRM155R61E104KA87#			
			±20%	GRM155B11H221MA01#							±20%	GRM155R61E104MA87#			
		330pF	±10%	GRM155B11H331KA01#	0.22μF					±10%	GRM155R61E224KE01#				
			±20%	GRM155B11H331MA01#						±20%	GRM155R61E224ME01#				
		470pF	±10%	GRM155B11H471KA01#					±20%	GRM155R61E224ME01#					
			±20%	GRM155B11H471MA01#	0.47μF				±10%	GRM155R61E474KE01#					
		680pF	±10%	GRM155B11H681KA01#					±20%	GRM155R61E105KA12#					
			±20%	GRM155B11H681MA01#					±20%	GRM155R61E105MA12#					
		1000pF	±10%	GRM155B11H102KA01#	B			2200pF	±10%	GRM155B11E222KA01#					
			±20%	GRM155B11H102MA01#				10000pF	±10%	GRM155B11E103KA01#					
		1500pF	±10%	GRM155B11H152KA01#					±20%	GRM155B11E103MA01#					
			±20%	GRM155B11H152MA01#				15000pF	±10%	GRM155B11E153KA61#					
		2200pF	±10%	GRM155B11H222KA01#					±20%	GRM155B11E153MA61#					
			±20%	GRM155B11H222MA01#				22000pF	±10%	GRM155B11E223KA61#					
		3300pF	±10%	GRM155B11H332KA01#					±20%	GRM155B11E223MA61#					
	±20%	GRM155B11H332MA01#	33000pF	±10%		GRM155B31E333KA87#									
	±10%	GRM155B11H333KA01#		±20%		GRM155B31E333MA87#									

Part number # indicates the package specification code.

GRM Series High Dielectric Constant Type Part Number List

(→ 1.0×0.5mm)

T max.	Rated Voltage	TC Code	Cap.	Tol.	Part Number	
0.55mm	25Vdc	B	3300pF	±20%	GRM155B31E333MA87#	
			4700pF	±10%	GRM155B31E473KA87#	
				±20%	GRM155B31E473MA87#	
				±10%	GRM155B31E683KA87#	
			6800pF	±10%	GRM155B31E683MA87#	
				±20%	GRM155B31E683MA87#	
		0.10μF		±10%	GRM155B31E104KA87#	
			±20%	GRM155B31E104MA87#		
		1.0μF	±10%	GRM155B31E105KA12#		
			±20%	GRM155B31E105MA12#		
		16Vdc	X7R	4700pF	±10%	GRM155R71C472KA01#
				10000pF	±10%	GRM155R71C103KA01#
					±20%	GRM155R71C103MA01#
					±10%	GRM155R71C683KA88#
				0.15μF	±10%	GRM155R71C154KA12#
					±10%	GRM155R71C224KA12#
			R	6800pF	±10%	GRM155R11C683KA88#
			X6S	0.47μF	±10%	GRM155C81C474KE01#
	±20%			GRM155C81C474ME01#		
	X5R		0.22μF	±10%	GRM155R61C224KA12#	
			±20%	GRM155R61C224MA12#		
			1.0μF	±10%	GRM155R61C105KA12#	
	±20%		GRM155R61C105MA12#			
	B		10000pF	±10%	GRM155B11C103KA01#	
			±20%	GRM155B11C103MA01#		
			1.0μF	±10%	GRM155B31C105KA12#	
				±20%	GRM155B31C105MA12#	
	10Vdc		X7R	0.22μF	±10%	GRM155R71A224KE01#
		±20%		GRM155R71A224ME01#		
		0.47μF		±10%	GRM155R71A474KE01#	
				±20%	GRM155R71A474ME01#	
		X6S	1.0μF	±10%	GRM155C81A105KA12#	
			±20%	GRM155C81A105MA12#		
		X5R	3300pF	±10%	GRM155R61A333KA01#	
			0.10μF	±10%	GRM155R61A104KA01#	
				±20%	GRM155R61A104MA01#	
			0.15μF	±10%	GRM155R61A154KE19#	
				±20%	GRM155R61A154ME19#	
			0.22μF	±10%	GRM155R61A224KE19#	
	±20%			GRM155R61A224ME19#		
	0.33μF		±10%	GRM155R61A334KE15#		
		±20%	GRM155R61A334ME15#			
	0.47μF	±10%	GRM155R61A474KE15#			
		±20%	GRM155R61A474ME15#			
	0.68μF	±10%	GRM155R61A684KE15#			
		±20%	GRM155R61A684ME15#			
	1.0μF	±20%	GRM155R61A105ME01#			
		B	0.15μF	±10%	GRM155B31A154KE18#	
±20%	GRM155B31A154ME18#					
0.22μF	±10%		GRM155B31A224KE18#			
	±20%		GRM155B31A224ME18#			
0.33μF	±10%		GRM155B31A334KE14#			
	±20%		GRM155B31A334ME14#			
0.47μF	±10%		GRM155B31A474KE14#			
	±20%		GRM155B31A474ME14#			

T max.	Rated Voltage	TC Code	Cap.	Tol.	Part Number	
0.55mm	10Vdc	B	0.68μF	±10%	GRM155B31A684KE15#	
			±20%	GRM155B31A684ME15#		
			1.0μF	±20%	GRM155B31A105ME01#	
			2.2μF	±10%	GRM155B31A225KE95#	
				±20%	GRM155B31A225ME95#	
			6.3Vdc	X7R	1.0μF	±10%
		±20%			GRM155R70J105MA12#	
		X6S	0.22μF	±10%	GRM155C80J224KE01#	
				±20%	GRM155C80J224ME01#	
			2.2μF	±10%	GRM155C80J225KE95#	
				±20%	GRM155C80J225ME95#	
			X5R	0.10μF	±10%	GRM155R60J104KA01#
	±20%			GRM155R60J104MA01#		
	0.15μF	±10%	GRM155R60J154KE01#			
		±20%	GRM155R60J154ME01#			
	0.22μF	±10%	GRM155R60J224KE01#			
		±20%	GRM155R60J224ME01#			
	0.33μF	±10%	GRM155R60J334KE01#			
		±20%	GRM155R60J334ME01#			
	0.47μF	±10%	GRM155R60J474KE19#			
		±20%	GRM155R60J474ME19#			
	0.68μF	±10%	GRM155R60J684KE19#			
		±20%	GRM155R60J684ME19#			
	1.0μF	±20%	GRM155R60J105ME19#			
		B	0.15μF	±10%	GRM155B10J154KE01#	
	±20%			GRM155B10J154ME01#		
	0.22μF		±10%	GRM155B10J224KE01#		
			±20%	GRM155B10J224ME01#		
	0.33μF		±10%	GRM155B10J334KE01#		
			±20%	GRM155B10J334ME01#		
	0.47μF	±10%	GRM155B30J474KE18#			
		±20%	GRM155B30J474ME18#			
	0.68μF	±10%	GRM155B30J684KE18#			
		±20%	GRM155B30J684ME18#			
	1.0μF	±20%	GRM155B30J105ME18#			
		±20%	GRM155B30J225ME95#			
	2.2μF	±10%	GRM155B30J225KE95#			
		±20%	GRM155B30J225ME95#			
	4Vdc	X7R	1.0μF	±10%	GRM155R70G105KA12#	
			±20%	GRM155R70G105MA12#		
		X6S	0.22μF	±10%	GRM155C80G224KE01#	
			±20%	GRM155C80G224ME01#		
		X5R	1.0μF	±20%	GRM155R60G105ME01#	
			0.6mm	50Vdc	X5R	0.47μF
	±10%	GRM155R61H474ME11#				
	35Vdc	X5R		1.0μF	±10%	GRM155R61A105KE11#
				±10%	GRM155R61A105ME11#	
	25Vdc	X6S		1.0μF	±10%	GRM155C81E105KE11#
±20%				GRM155C81E105ME11#		
16Vdc	X6S	1.0μF	±10%	GRM155C81C105KE11#		
		±20%	GRM155C81C105ME11#			
6.3Vdc	X5R	4.7μF	±20%	GRM155R60J475ME47#		
		B	4.7μF	±20%	GRM155B30J475ME47#	
4Vdc	X5R	4.7μF	±20%	GRM155R60G475ME47#		
		B	4.7μF	±20%	GRM155B30G475ME47#	
2.5Vdc	X6T	4.7μF	±20%	GRM155D80E475ME47#		
		±20%	GRM155D80E475ME47#			
0.65mm	25Vdc	X6T	2.2μF	±20%	GRM155D81E225ME11#	
			±20%	GRM155D81E225ME11#		

Part number # indicates the package specification code.

GRM Series High Dielectric Constant Type Part Number List

(→ 1.0×0.5mm)

T max.	Rated Voltage	TC Code	Cap.	Tol.	Part Number	
0.65mm	16Vdc	X7T	2.2μF	±20%	GRM155D71C225ME11#	D1
		X6T	2.2μF	±20%	GRM155D81C225ME11#	
	10Vdc	X7T	2.2μF	±20%	GRM155D71A225ME11#	
		X5R	4.7μF	±20%	GRM155R61A475MEAA#	D1
	6.3Vdc	X6S	4.7μF	±20%	GRM155C80J475MEAA#	D1
0.7mm	25Vdc	X5R	2.2μF	±10%	GRM155R61E225KE11#	
				±20%	GRM155R61E225ME11#	
	16Vdc	X6S	2.2μF	±10%	GRM155C81C225KE11#	
				±20%	GRM155C81C225ME11#	
		X5R	2.2μF	±10%	GRM155R61C225KE11#	
				±20%	GRM155R61C225ME11#	
	10Vdc	X7S	2.2μF	±10%	GRM155C71A225KE11#	
				±20%	GRM155C71A225ME11#	
		X6S	2.2μF	±10%	GRM155C81A225KE11#	
				±20%	GRM155C81A225ME11#	
	6.3Vdc	X7S	2.2μF	±10%	GRM155C70J225KE11#	
				±20%	GRM155C70J225ME11#	
	4Vdc	X5R	10μF	±20%	GRM155R60G106ME44#	
	2.5Vdc	X5R	10μF	±20%	GRM155R60E106ME16#	

1.6×0.8mm

T max.	Rated Voltage	TC Code	Cap.	Tol.	Part Number	
0.5mm	25Vdc	X5R	1.0μF	±10%	GRM185R61E105KA12#	D1
				±20%	GRM185R61E105MA12#	D1
		B	1.0μF	±10%	GRM185B31E105KA12#	D1
				±20%	GRM185B31E105MA12#	D1
	16Vdc	X5R	1.0μF	±10%	GRM185R61C105KE44#	
				±20%	GRM185R61C105ME44#	
		B	1.0μF	±10%	GRM185B31C105KE43#	
				±20%	GRM185B31C105ME43#	
	6.3Vdc	X5R	10μF	±20%	GRM185R60J106ME15#	D1
	4Vdc	X5R	10μF	±20%	GRM185R60G106ME15#	
0.55mm	16Vdc	X5R	4.7μF	±10%	GRM185R61C475KE11#	
				±20%	GRM185R61C475ME11#	
	10Vdc	X6S	4.7μF	±10%	GRM185C81A475KE11#	D1
				±20%	GRM185C81A475ME11#	D1
		X5R	4.7μF	±10%	GRM185R61A475KE11#	
				±20%	GRM185R61A475ME11#	
6.3Vdc	X7T	4.7μF	±20%	GRM185D70J475ME11#	D1	
	X6S	4.7μF	±20%	GRM185C80J475ME11#		
0.9mm	250Vdc	X7R	220pF	±10%	GRM188R72E221KW07#	
			330pF	±10%	GRM188R72E331KW07#	
			470pF	±10%	GRM188R72E471KW07#	
			680pF	±10%	GRM188R72E681KW07#	
			1000pF	±10%	GRM188R72E102KW07#	
			1500pF	±10%	GRM188R72E152KW07#	
			2200pF	±10%	GRM188R72E222KW07#	
			200Vdc	X7R	220pF	±10%
	330pF	±10%	GRM188R72D331KW07#			
	470pF	±10%	GRM188R72D471KW07#			
680pF	±10%	GRM188R72D681KW07#				
			1000pF	±10%	GRM188R72D102KW07#	

T max.	Rated Voltage	TC Code	Cap.	Tol.	Part Number		
0.9mm	200Vdc	X7R	1500pF	±10%	GRM188R72D152KW07#		
			2200pF	±10%	GRM188R72D222KW07#		
	25Vdc	X7R	1.0μF	±10%	GRM188R71E105KA12#		
				±20%	GRM188R71E105MA12#		
		X5R	2.2μF	±10%	GRM188R61E225KA12#		
				±20%	GRM188R61E225MA12#		
		B	2.2μF	±10%	GRM188B31E225KA12#		
				±20%	GRM188B31E225MA12#		
	16Vdc	X6S	2.2μF	±10%	GRM188C81C225KA12#		
				±20%	GRM188C81C225MA12#		
		X5R	2.2μF	±10%	GRM188R61C225KE15#		
				±20%	GRM188R61C225ME15#		
	10Vdc	X7R	2.2μF	±10%	GRM188R71A225KE15#		
				±20%	GRM188R71A225ME15#		
	6.3Vdc	X5R	4.7μF	±10%	GRM188R61A475KE15#	D1	
				±20%	GRM188R61A475ME15#	D1	
		X6S	4.7μF	±20%	GRM188C80J475ME15#	D1	
				X5R	10μF	±20%	GRM188R60J106ME47#
	4Vdc	X5R	10μF	±20%	GRM188B30J106ME47#		
				B	10μF	±20%	GRM188B30J106ME47#
0.95mm	25Vdc	X5R	4.7μF	±10%	GRM188R61E475KE11#		
				±20%	GRM188R61E475ME11#		
	16Vdc	X6S	4.7μF	±10%	GRM188C81C475KE11#		
				±20%	GRM188C81C475ME11#		
		X5R	4.7μF	±10%	GRM188R61C475KE11#		
				±20%	GRM188R61C475ME11#		
	10Vdc	X7S	4.7μF	±10%	GRM188C71A475KE11#		
				±20%	GRM188C71A475ME11#		
		X5R	10μF	±10%	GRM188R61A106KAAL#		
				±20%	GRM188R61A106MAAL#		
1.0mm	50Vdc	X5R	2.2μF	±10%	GRM188R61H225KE11#		
				±20%	GRM188R61H225ME11#		
	35Vdc	X6S	2.2μF	±10%	GRM188C8YA225KE11#		
				±20%	GRM188C8YA225ME11#		
X5R		4.7μF	±10%	GRM188R6YA475KE15#			
			±20%	GRM188R6YA475ME15#			
25Vdc	X7S	2.2μF	±10%	GRM188C71E225KE11#			
			±20%	GRM188C71E225ME11#			
			X6S	2.2μF	±10%	GRM188C81E225KE11#	
					±20%	GRM188C81E225ME11#	
	16Vdc	X7S	2.2μF	±10%	GRM188C71C225KE11#		
				±20%	GRM188C71C225ME11#		
		X5R	10μF	±20%	GRM188R61E106MA73#		
				4.7μF	±10%	GRM188C81E475KE11#	D1
			±20%	GRM188C81E475ME11#	D1		
10Vdc	X7T	10μF	±20%	GRM188D71A106MA73#			
			6.3Vdc	X7T	10μF	±20%	GRM188D70J106MA73#

Part number # indicates the package specification code.

GRM Series High Dielectric Constant Type Part Number List

(→ 1.6×0.8mm)

T max.	Rated Voltage	TC Code	Cap.	Tol.	Part Number	
1.0mm	6.3Vdc	X5R	22μF	±20%	GRM188R60J226MEA0#	D1
		B	22μF	±20%	GRM188B30J226MEA0#	D1
	4Vdc	X6S	22μF	±20%	GRM188C80G226MEA0#	D1
		X5R	22μF	±20%	GRM188R60G226MEA0#	
		B	22μF	±20%	GRM188B30G226MEA0#	
			22μF	±20%	GRM188B30G226MEA0#	

2.0×1.25mm

T max.	Rated Voltage	TC Code	Cap.	Tol.	Part Number			
0.7mm	16Vdc	X6S	1.0μF	±10%	GRM216C81C105KA12#			
0.95mm	50Vdc	X5R	1.0μF	±10%	GRM219R61H105KA73#			
				±20%	GRM219R61H105MA73#			
			2.2μF	±10%	GRM219R61H225KE15#			
				±20%	GRM219R61H225ME15#			
				B	1.0μF	±10%	GRM219B31H105KA73#	
		±20%	GRM219B31H105MA73#					
		2.2μF	±10%	GRM219B31H225KE15#				
			±20%	GRM219B31H225ME15#				
			35Vdc	X6S	2.2μF	±10%	GRM219C8YA225KE15#	
		±20%				GRM219C8YA225ME15#		
	X5R	4.7μF	±10%	GRM219R6YA475KA73#	D1			
			±20%	GRM219R6YA475MA73#	D1			
	25Vdc	X7R	1.0μF	±10%	GRM219R71E105KA88#			
				±20%	GRM219R71E105MA88#			
			X6S	2.2μF	±10%	GRM219C81E225KE15#		
					±20%	GRM219C81E225ME15#		
			X5R	2.2μF	±10%	GRM219R61E225KA12#		
					±20%	GRM219R61E225MA12#		
		4.7μF		±10%	GRM219R61E475KA73#			
				±20%	GRM219R61E475MA73#			
		10μF	±10%	GRM219R61E106KA12#	D1			
			±20%	GRM219R61E106MA12#	D1			
		B	2.2μF	±10%	GRM219B31E225KA75#			
				±20%	GRM219B31E225MA75#			
		10μF	±10%	GRM219B31E106KA12#	D1			
			±20%	GRM219B31E106MA12#	D1			
		16Vdc	X7R	2.2μF	±10%	GRM219R71C225KE15#		
					±20%	GRM219R71C225ME15#		
				X5R	4.7μF	±10%	GRM219R61C475KE15#	
						±20%	GRM219R61C106MA73#	
	10μF		±10%	GRM219R61C106KA73#				
			±20%	GRM219R61C106MA73#				
	B		4.7μF	±10%	GRM219B31C475KE15#			
				±20%	GRM219B31C106KA73#			
	10μF		±10%	GRM219B31C106MA73#				
			±20%	GRM219B31C106MA73#				
	10Vdc	X7R	2.2μF	±10%	GRM219R71A225KE15#			
				±20%	GRM219R71A225ME15#			
		X7T	4.7μF	±10%	GRM219D71A475KE15#	D1		
				±20%	GRM219D71A475ME15#	D1		
		X5R	22μF	±20%	GRM219R61A226MEA0#	D1		
				±20%	GRM219B31A226MEA0#	D1		
		6.3Vdc	X6S	10μF	±10%	GRM219C80J106KE39#		
					±20%	GRM219C80J106ME39#		
	X5R		22μF	±20%	GRM219R60J226MEA0#			
				±20%	GRM219B30J226ME47#	D1		

T max.	Rated Voltage	TC Code	Cap.	Tol.	Part Number	
0.95mm	4Vdc	X6S	10μF	±10%	GRM219C80G106KE19#	
				±20%	GRM219C80G106ME19#	
	X5R	47μF	±20%	GRM219R60G476ME44#	D1	
			±20%	GRM219D80E476ME44#		
1.0mm	500Vdc	X7R	1000pF	±10%	GRM21AR72H102KW10#	
				±10%	GRM21AR72H152KW10#	
				±10%	GRM21AR72H222KW10#	
				±10%	GRM21AR72H332KW10#	
				±10%	GRM21AR72H472KW10#	
				±10%	GRM21AR72H682KW10#	
	250Vdc	X7R	1000pF	±10%	GRM21AR72E102KW01#	
				±10%	GRM21AR72E152KW01#	
				±10%	GRM21AR72E222KW01#	
				±10%	GRM21AR72E332KW01#	
				±10%	GRM21AR72E472KW01#	
				±10%	GRM21AR72E682KW01#	
	200Vdc	X7R	1000pF	±10%	GRM21AR72D102KW01#	
				±10%	GRM21AR72D152KW01#	
				±10%	GRM21AR72D222KW01#	
				±10%	GRM21AR72D332KW01#	
				±10%	GRM21AR72D472KW01#	
				±10%	GRM21AR72D682KW01#	
	35Vdc	X6S	4.7μF	±10%	GRM219C8YA475KE21#	D1
				±20%	GRM219C8YA475ME21#	D1
	25Vdc	X7S	4.7μF	±10%	GRM219C71E475KE21#	D1
				±20%	GRM219C71E475ME21#	D1
		X6S	4.7μF	±10%	GRM219C81E475KE21#	D1
±20%				GRM219C81E475ME21#	D1	
16Vdc	X7S	4.7μF	±10%	GRM219C71C475KE21#		
			±20%	GRM219C71C475ME21#		
	X5R	22μF	±20%	GRM219R61C226ME15#	D1	
			±20%	GRM219R61C226ME15#		
1.35mm	25Vdc	X6S	4.7μF	±10%	GRM21BC81E475KA12#	
				±20%	GRM21BC81E475MA12#	
		X5R	4.7μF	±10%	GRM21BR61E475KA12#	
				±20%	GRM21BR61E475MA12#	
		B	2.2μF	±10%	GRM21BB31E225KA75#	
				±20%	GRM21BB31E225MA75#	
	4.7μF	±10%	GRM21BB31E475KA75#			
		±20%	GRM21BB31E475MA75#			
	16Vdc	X7R	2.2μF	±10%	GRM21BR71C225KA12#	
				±20%	GRM21BR71C225MA12#	
X5R		10μF	±10%	GRM21BR61C106KE15#		
			±20%	GRM21BR61C106ME15#		
B	10μF	±10%	GRM21BB31C106KE15#			
		±20%	GRM21BB31C106ME15#			
1.4mm	50Vdc	X5R	2.2μF	±10%	GRM21BR61H225KA73#	
				±20%	GRM21BR61H225MA73#	
				±20%	GRM21BR61H475KE51#	
		B	2.2μF	±10%	GRM21BB31H225KA73#	
				±20%	GRM21BB31H225MA73#	
				±20%	GRM21BB31H475KE51#	
	25Vdc	X7R	2.2μF	±10%	GRM21BR71E225KE11#	
				±10%	GRM21BR71E225ME11#	
				±10%	GRM21BR71E475KE11#	
				±10%	GRM21BR71E475ME11#	

Part number # indicates the package specification code.

GRM Series High Dielectric Constant Type Part Number List

(→ 2.0×1.25mm)

T max.	Rated Voltage	TC Code	Cap.	Tol.	Part Number			
1.4mm	25Vdc	X7R	2.2μF	±20%	GRM21BR71E225ME11#			
			10μF	±10%	GRM21BR61E106KA73#			
		B	10μF	±10%	GRM21BB31E106KA73#			
			10μF	±20%	GRM21BB31E106MA73#			
		16Vdc	X6S	10μF	±10%	GRM21BC81C106KA73#		
				10μF	±20%	GRM21BC81C106MA73#		
	10Vdc	B	22μF	±20%	GRM21BB31A226ME51#	D1		
	6.3Vdc	X7R	10μF	±10%	GRM21BR70J106KE76#			
		X6S	22μF	±20%	GRM21BC80J226ME51#	D1		
	4Vdc	X7U	22μF	±20%	GRM21BE70G226ME51#			
			X6S	22μF	±20%	GRM21BC80G226ME39#		
	1.45mm	500Vdc	X7R	10000pF	±10%	GRM21BR72H103KW09#		
				250Vdc	10000pF	±10%	GRM21BR72E103KW03#	
15000pF					±10%	GRM21BR72E153KW03#		
200Vdc		X7R	10000pF	±10%	GRM21BR72D103KW03#			
			15000pF	±10%	GRM21BR72D153KW03#			
			22000pF	±10%	GRM21BR72D223KW03#			
50Vdc		X7S	4.7μF	±10%	GRM21BC71H475KE11#			
			4.7μF	±20%	GRM21BC71H475ME11#			
			X6S	4.7μF	±10%	GRM21BC81H475KE11#		
		35Vdc	X7S	4.7μF	±10%	GRM21BC7YA475KE11#		
				4.7μF	±20%	GRM21BC7YA475ME11#		
				X6S	10μF	±10%	GRM21BC8YA106KE11#	D1
		X6S	10μF	±10%	GRM21BC8YA106ME11#	D1		
			X5R	10μF	±10%	GRM21BR6YA106KE43#	D1	
			X5R	10μF	±20%	GRM21BR6YA106ME43#	D1	
25Vdc		X7S	4.7μF	±10%	GRM21BC71E475KE11#			
			4.7μF	±20%	GRM21BC71E475ME11#			
			10μF	±10%	GRM21BC71E106KE11#	D1		
		X6S	10μF	±10%	GRM21BC81E106KE11#	D1		
			10μF	±20%	GRM21BC81E106ME11#	D1		
			X5R	22μF	±20%	GRM21BR61E226ME44#		
16Vdc		X7S	10μF	±10%	GRM21BC71C106KE11#			
			10μF	±20%	GRM21BC71C106ME11#			
			X6S	22μF	±20%	GRM21BC81C226ME44#	D1	
		X5R	22μF	±20%	GRM21BR61C226ME44#			
			10Vdc	X7T	22μF	±20%	GRM21BD71A226ME44#	D1
				X6S	22μF	±20%	GRM21BC81A226ME44#	
X5R		22μF		±20%	GRM21BR61A226ME44#			
		X5R	47μF	±20%	GRM21BR61A476ME15#	D1		
			6.3Vdc	X7T	22μF	±20%	GRM21BD70J226ME44#	
				X5R	47μF	±20%	GRM21BR60J476ME15#	D1
X5R		100μF		±20%	GRM21BR60J107ME15#	D1		
		B	47μF	±20%	GRM21BB30J476ME15#	D1		
			4Vdc	X6S	47μF	±20%	GRM21BC80G476ME15#	D1
				X6S	100μF	±20%	GRM21BC80G107ME15#	D1
X5R		47μF		±20%	GRM21BR60G476ME15#			
	B	47μF	±20%	GRM21BB30G476ME15#				
		2.5Vdc	X6S	100μF	±20%	GRM21BC80E107ME15#		

3.2×1.6mm

T max.	Rated Voltage	TC Code	Cap.	Tol.	Part Number				
0.95mm	35Vdc	X5R	10μF	±10%	GRM319R6YA106KA12#	D1			
				±20%	GRM319R6YA106MA12#	D1			
			16Vdc	X5R	10μF	±10%	GRM319R61C106KE15#		
						±20%	GRM319R61C106ME15#		
				22μF	±20%	GRM319R61C226ME15#	D1		
				B	10μF	±10%	GRM319B31C106KE15#		
						±20%	GRM319B31C106ME15#	D1	
	10Vdc	X5R	22μF	±20%	GRM319R61A226ME15#				
				B	22μF	±20%	GRM319B31A226ME15#		
	6.3Vdc	X6S	22μF	±20%	GRM319C80J226ME15#				
				X5R	22μF	±20%	GRM319R60J226ME15#		
						B	22μF	±20%	GRM319B30J226ME15#
1.0mm	630Vdc	X7R	1000pF	±10%	GRM31AR72J102KW01#				
			1500pF	±10%	GRM31AR72J152KW01#				
			2200pF	±10%	GRM31AR72J222KW01#				
			3300pF	±10%	GRM31AR72J332KW01#				
			4700pF	±10%	GRM31AR72J472KW01#				
			6800pF	±10%	GRM31AR72J682KW01#				
			10000pF	±10%	GRM31AR72J103KW01#				
			1.25mm	1000Vdc	X7R	470pF	±10%	GRM31BR73A471KW01#	
						680pF	±10%	GRM31BR73A681KW01#	
						1000pF	±10%	GRM31BR73A102KW01#	
1500pF	±10%	GRM31BR73A152KW01#							
			2200pF	±10%	GRM31BR73A222KW01#				
			3300pF	±10%	GRM31BR73A332KW01#				
			4700pF	±10%	GRM31BR73A472KW01#				
			630Vdc	X7R	6800pF	±10%	GRM31BR72J682KW01#		
500Vdc	X7R		15000pF	±10%	GRM31BR72H153KW10#				
			22000pF	±10%	GRM31BR72H223KW10#				
250Vdc	X7R		15000pF	±10%	GRM31BR72E153KW01#				
			22000pF	±10%	GRM31BR72E223KW01#				
			68000pF	±10%	GRM31BR72E683KW01#				
200Vdc	X7R		15000pF	±10%	GRM31BR72D153KW01#				
			22000pF	±10%	GRM31BR72D223KW01#				
			68000pF	±10%	GRM31BR72D683KW01#				
50Vdc	B	1.0μF	±10%	GRM31MB31H105KA87#					
25Vdc	X5R	10μF	±20%	GRM31MR61E106MA12#					
1.8mm	1000Vdc	X7R	6800pF	±10%	GRM31CR73A682KW03#				
			10000pF	±10%	GRM31CR73A103KW03#				
	630Vdc	X7R		15000pF	±10%	GRM31CR72J153KW03#			
				22000pF	±10%	GRM31CR72J223KW03#			
	500Vdc	X7R		33000pF	±10%	GRM31CR72H333KW09#			
				47000pF	±10%	GRM31CR72H473KW09#			
	250Vdc	X7R		33000pF	±10%	GRM31CR72E333KW03#			
				47000pF	±10%	GRM31CR72E473KW03#			
				0.10μF	±10%	GRM31CR72E104KW03#			
	200Vdc	X7R		33000pF	±10%	GRM31CR72D333KW03#			
				47000pF	±10%	GRM31CR72D473KW03#			
				0.10μF	±10%	GRM31CR72D104KW03#			
100Vdc	X7R	1.0μF	±10%	GRM31CR72A105KA01#					
50Vdc	X7R	4.7μF	±10%	GRM31CR71H475KA12#					

Part number # indicates the package specification code.

GRM Series High Dielectric Constant Type Part Number List

(→ 3.2×1.6mm)

T max.	Rated Voltage	TC Code	Cap.	Tol.	Part Number	
1.8mm	50Vdc	X7R	4.7μF	±20%	GRM31CR71H475MA12#	
			10μF	±10%	GRM31CR61H106KA12#	
				±20%	GRM31CR61H106MA12#	
		B	4.7μF	±10%	GRM31CB31H475KA12#	
				±20%	GRM31CB31H475MA12#	
			10μF	±10%	GRM31CB31H106KA12#	
		25Vdc	X7R	10μF	±10%	GRM31CR71E106KA12#
					±20%	GRM31CR71E106MA12#
				X5R	22μF	±20%
			B			10μF
			22μF	±20%	GRM31CB31E226ME15#	
			16Vdc	X6S	22μF	±20%
	X5R	22μF				±20%
	B	22μF		±20%	GRM31CB31C226ME15#	
	10Vdc	X7R	22μF	±20%	GRM31CR71A226ME15#	
				X5R	47μF	±20%
		B	47μF	±20%	GRM31CB31A476ME15#	
	6.3Vdc	X7R	22μF	±20%	GRM31CR70J226ME19#	
				X7U	47μF	±20%
		X6S	47μF	±20%	GRM31CC80J476ME18#	
				X5R	47μF	±20%
	B	47μF	±20%	GRM31CB30J476ME18#		
			4Vdc	X7U	47μF	±20%
	X6S	47μF	±20%		GRM31CC80G476ME19#	
	1.9mm	25Vdc	X6S	22μF	±20%	GRM31CC81E226ME11#
					X7S	22μF
		16Vdc	X5R	47μF	±20%	GRM31CR61C476ME44#
					X6S	47μF
		10Vdc	X5R	100μF	±20%	GRM31CR61A107ME05# D1
					X6T	100μF
		6.3Vdc	X5R	100μF	±20%	GRM31CR60J107ME39#
					150μF	±20%
			4Vdc	X7U	100μF	±20%
		X6S				150μF
		X6T		100μF	±20%	GRM31CD80G107ME39#
					X5R	100μF
150μF		±20%	GRM31CR60G157ME11#			
220μF		±20%	GRM31CR60G227ME11#			
2.5Vdc		X6S	150μF	±20%	GRM31CC80E157ME11#	
				X5R	220μF	±20%

3.2×2.5mm

T max.	Rated Voltage	TC Code	Cap.	Tol.	Part Number
1.5mm	1000Vdc	X7R	6800pF	±10%	GRM32QR73A682KW01#
			10000pF	±10%	GRM32QR73A103KW01#
	630Vdc	X7R	22000pF	±10%	GRM32QR72J223KW01#
				500Vdc	X7R
	250Vdc	X7R	68000pF	±10%	
				0.15μF	±10%
	200Vdc	X7R	68000pF	±10%	GRM32QR72D683KW01#
				0.15μF	±10%

T max.	Rated Voltage	TC Code	Cap.	Tol.	Part Number	
1.8mm	100Vdc	X7R	1.0μF	±10%	GRM32CR72A105KA35#	
				±20%	GRM32CR72A105MA35#	
2.0mm	1000Vdc	X7R	15000pF	±10%	GRM32DR73A153KW01#	
				22000pF	±10%	GRM32DR73A223KW01#
	630Vdc	X7R	33000pF	±10%	GRM32DR72J333KW01#	
				47000pF	±10%	GRM32DR72J473KW01#
	500Vdc	X7R	0.10μF	±10%	GRM32DR72H104KW10#	
				250Vdc	X7R	0.10μF
200Vdc	X7R	0.10μF	±10%	GRM32DR72D104KW01#		
			0.22μF	±10%	GRM32DR72E224KW01#	
2.2mm	100Vdc	X7S	4.7μF	±10%	GRM32DC72A475KE01#	
				±20%	GRM32DC72A475ME01#	
2.7mm	100Vdc	X7R	2.2μF	±10%	GRM32ER72A225KA35#	
				±20%	GRM32ER72A225MA35#	
80Vdc	X7R	4.7μF	±10%	GRM32ER71K475KE14# D1		
			±20%	GRM32ER71K475ME14# D1		
63Vdc	X7R	10μF	±10%	GRM32ER71J106KA12# D1		
			±20%	GRM32ER71J106MA12# D1		
50Vdc	X7R	4.7μF	±10%	GRM32ER71H475KA88#		
			10μF	±10%	GRM32ER71H106KA12#	
			±20%	GRM32ER71H106MA12#		
	X5R	10μF	±10%	GRM32ER61H106KA12#		
			±20%	GRM32ER61H106MA12#		
			B	10μF	±10%	GRM32EB31H106KA12#
±20%	GRM32EB31H106MA12#					
35Vdc	X7R	10μF	±10%	GRM32ER7YA106KA12#		
			±20%	GRM32ER7YA106MA12#		
	X5R	10μF	±10%	GRM32ER6YA106KA12#		
			±20%	GRM32ER6YA106MA12#		
25Vdc	X7R	22μF	±20%	GRM32ER71E226ME15#		
			X5R	22μF	±20%	GRM32ER61E226ME15#
			B	22μF	±20%	GRM32EB31E226ME15#
16Vdc	X7R	22μF	±20%	GRM32ER71C226ME15#		
			X6S	47μF	±20%	GRM32EC81C476ME15# D1
	X5R	47μF	±20%	GRM32ER61C476ME15#		
			B	47μF	±20%	GRM32EB31C476ME15#
10Vdc	X7R	47μF	±20%	GRM32ER71A476ME15#		
			X5R	47μF	±20%	GRM32ER61A476ME20#
	100μF	±20%	GRM32ER61A107ME20# D1			
6.3Vdc	X7R	47μF	±20%	GRM32ER70J476ME20#		
			X7U	100μF	±20%	GRM32EE70J107ME15# D1
4Vdc	X7U	100μF	±20%	GRM32ER60J107ME20#		
			B	100μF	±20%	GRM32EB30J107ME16#
4Vdc	X7U	100μF	±20%	GRM32EE70G107ME19#		

Part number # indicates the package specification code.

GRM Series High Dielectric Constant Type Part Number List

4.5×3.2mm

T max.	Rated Voltage	TC Code	Cap.	Tol.	Part Number
1.5mm	630Vdc	X7R	68000pF	±10%	GRM43QR72J683KW01#
	500Vdc	X7R	0.15μF	±10%	GRM43QR72H154KW10#
	250Vdc	X7R	0.15μF	±10%	GRM43QR72E154KW01#
	200Vdc	X7R	0.15μF	±10%	GRM43QR72D154KW01#
2.0mm	1000Vdc	X7R	33000pF	±10%	GRM43DR73A333KW01#
			47000pF	±10%	GRM43DR73A473KW01#
	630Vdc	X7R	0.10μF	±10%	GRM43DR72J104KW01#
	500Vdc	X7R	0.22μF	±10%	GRM43DR72H224KW10#
	250Vdc	X7R	0.22μF	±10%	GRM43DR72E224KW01#
			0.33μF	±10%	GRM43DR72E334KW01#
			0.47μF	±10%	GRM43DR72E474KW01#
	200Vdc	X7R	0.22μF	±10%	GRM43DR72D224KW01#
			0.33μF	±10%	GRM43DR72D334KW01#
			0.47μF	±10%	GRM43DR72D474KW01#

5.7×5.0mm

T max.	Rated Voltage	TC Code	Cap.	Tol.	Part Number
2.0mm	1000Vdc	X7R	68000pF	±10%	GRM55DR73A683KW01#
			0.10μF	±10%	GRM55DR73A104KW01#
	630Vdc	X7R	0.15μF	±10%	GRM55DR72J154KW01#
			0.22μF	±10%	GRM55DR72J224KW01#
	500Vdc	X7R	0.33μF	±10%	GRM55DR72H334KW10#
			0.47μF	±10%	GRM55DR72H474KW10#
	250Vdc	X7R	0.33μF	±10%	GRM55DR72E334KW01#
			0.47μF	±10%	GRM55DR72E474KW01#
			0.68μF	±10%	GRM55DR72E684KW01#
			1.0μF	±10%	GRM55DR72E105KW01#
	200Vdc	X7R	0.33μF	±10%	GRM55DR72D334KW01#
			0.47μF	±10%	GRM55DR72D474KW01#
			0.68μF	±10%	GRM55DR72D684KW01#
			1.0μF	±10%	GRM55DR72D105KW01#

GRM
 GR3
 GRJ
 GR4
 GR7
 GJM
 GQM
 GA2
 GA3 GB
 GA3 GD
 GA3 GF
 LLL
 LLA
 LLM
 LLR
 NFM
 KPM
 KR3
 GMA
 GMD
 ⚠Caution /Notice

GRM Series Specifications and Test Methods

Specifications and Test Methods, please refer to the search web page.
<https://www.murata.com/en-global/products/capacitor>

GRM Series Temperature Compensating

0.4×0.2mm

T max.	Rated Voltage	TC Code	Cap.	Tol.	Part Number
0.22mm	50Vdc	COG	0.20pF	±0.05pF	GRM0225C1HR20WA03#
				±0.1pF	GRM0225C1HR20BA03#
			0.30pF	±0.05pF	GRM0225C1HR30WA03#
				±0.1pF	GRM0225C1HR30BA03#
			0.40pF	±0.05pF	GRM0225C1HR40WA03#
				±0.1pF	GRM0225C1HR40BA03#
0.50pF	±0.05pF	GRM0225C1HR50WA03#			
	±0.1pF	GRM0225C1HR50BA03#			

Links are provided to the product detail pages on the web, and are shown below in the product number table from the PDF version of the catalog which is available on the web.



Detailed Specifications Sheet

- Rated value
- Specifications and Test Methods
- Package
- Caution, Notice

Specifications and Test Methods

No	Item	Specification	Test Method (Ref. Standard: JIS C 5101, IEC60384)												
1	Rated Voltage	Shown in Rated value.	The rated voltage is defined as the maximum voltage which may be applied continuously to the capacitor. When AC voltage is superimposed on DC voltage, V^{P-P} or V^{2-P} , whichever is larger, should be maintained within the rated voltage range.												
2	Appearance	No defects or abnormalities.	Visual inspection.												
3	Dimension	Within the specified dimensions.	Using calipers. (GRM02 size is based on Microscope)												
4	Voltage proof	No defects or abnormalities.	Measurement Point : Between the terminations Test Voltage : 300% of the rated voltage (Temperature compensating type) Applied Time : 1s to 5 s Charge/discharge current : 50mA max.												
5	Insulation Resistance(I.R.)	$C \leq 0.047\mu\text{F}$: More than 1000MΩ $C > 0.047\mu\text{F}$: More than 500Ω·F C: Nominal Capacitance	Measurement Point : Between the terminations Measurement Voltage : DC Rated Voltage Charging Time : 1 min Charge/discharge current : 50mA max. Measurement Temperature : Room Temperature												
6	Capacitance	Shown in Rated value.	Measurement Temperature : Room Temperature												
7	Q or Dissipation Factor (D.F.)	30pF and over: $Q \geq 1000$ 30pF and below: $Q \geq 400+20C$ C: Nominal Capacitance(pF)	(1) Temperature Compensating Type <table border="1"> <thead> <tr> <th>Capacitance</th> <th>Frequency</th> <th>Voltage</th> </tr> </thead> <tbody> <tr> <td>$C \leq 1000\text{pF}$</td> <td>1.0Hz-0.1MHz</td> <td>0.5 to 5.0Vrms</td> </tr> <tr> <td>$C > 1000\text{pF}$</td> <td>1.0Hz-0.1kHz</td> <td>1.0Hz-0.2Vrms</td> </tr> </tbody> </table>	Capacitance	Frequency	Voltage	$C \leq 1000\text{pF}$	1.0Hz-0.1MHz	0.5 to 5.0Vrms	$C > 1000\text{pF}$	1.0Hz-0.1kHz	1.0Hz-0.2Vrms			
Capacitance	Frequency	Voltage													
$C \leq 1000\text{pF}$	1.0Hz-0.1MHz	0.5 to 5.0Vrms													
$C > 1000\text{pF}$	1.0Hz-0.1kHz	1.0Hz-0.2Vrms													
8	Temperature Characteristics of Capacitance	Nominal values of the temperature coefficient is shown in Rated value. But, the Capacitance Change under 20°C is shown in Table A. Capacitance Drift Within $\pm 0.2\%$ or $\pm 0.05\text{pF}$ (Whichever is larger.)	The capacitance change should be measured after 5 min at each specified temp. stage. In case of applying voltage, the capacitance change should be measured after 1 min with applying voltage in equilibration of each temp. stage. Capacitance value as a reference is the value in step 3. The capacitance drift is calculated by dividing the differences between the maximum and minimum measured values in the step 1,3 and 5 by the cap. value in step 3. <table border="1"> <thead> <tr> <th>Step</th> <th>Temperature(°C)</th> </tr> </thead> <tbody> <tr> <td>1</td> <td>Reference Temp. ± 2</td> </tr> <tr> <td>2</td> <td>Min. Operating Temp. ± 3</td> </tr> <tr> <td>3</td> <td>Reference Temp. ± 2</td> </tr> <tr> <td>4</td> <td>Max. Operating Temp. ± 3</td> </tr> <tr> <td>5</td> <td>Reference Temp. ± 2</td> </tr> </tbody> </table>	Step	Temperature(°C)	1	Reference Temp. ± 2	2	Min. Operating Temp. ± 3	3	Reference Temp. ± 2	4	Max. Operating Temp. ± 3	5	Reference Temp. ± 2
Step	Temperature(°C)														
1	Reference Temp. ± 2														
2	Min. Operating Temp. ± 3														
3	Reference Temp. ± 2														
4	Max. Operating Temp. ± 3														
5	Reference Temp. ± 2														

GRM
 GR3
 GRJ
 GR4
 GR7
 GJM
 GQM
 GA2
 GA3 GB
 GA3 GD
 GA3 GF
 LLL
 LLA
 LLM
 LLR
 NFM
 KRM
 KR3
 GMA
 GMD
 ⚠Caution /Notice

High Effective Capacitance & High Ripple Current Chip Multilayer Ceramic Capacitors for General Purpose

GR3 Series



This is a general purpose high ripple resistance product excellent in DC bias characteristics.

Features

- ① When a DC bias is applied, a capacitance higher than conventional products (X7R characteristics) can be acquired.

About twice the capacitance can be secured when DC200V is applied.

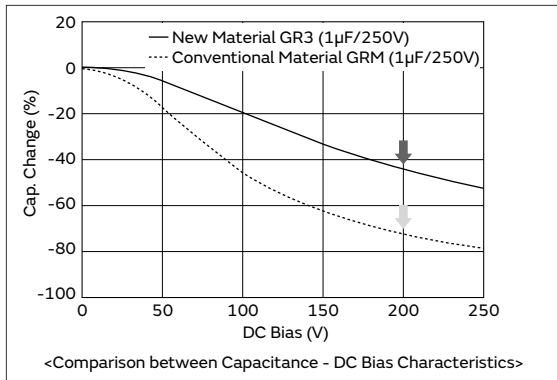

- ② Improved ripple resistance performance compared to conventional products (X7R characteristics).

In the case of a product with a capacitance of 1µF, when the exothermic temperature reaches 20°C at frequency f=300kHz, the amount of resistance of a product with conventional material is 2.9Arms; however, the new material is 4.7Arms.

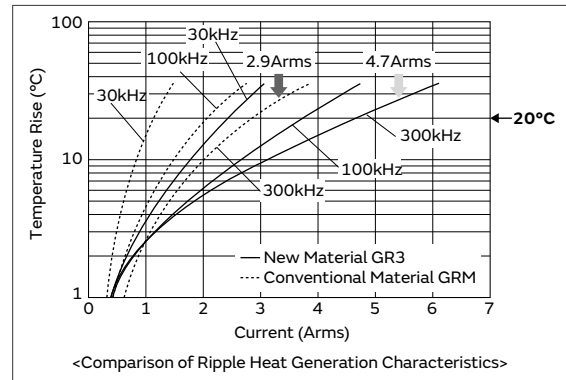

- ③ This product has a noise reduction effect.

Since dielectric materials which enable a reduction of noise are used, this product is more effective for reducing noise compared to the general purpose GRM series.

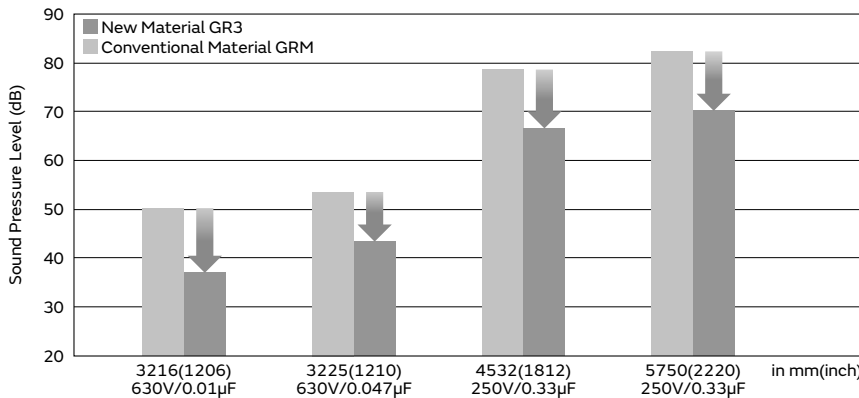

Specifications

Size (mm)	2.0×1.25mm to 5.7×5.0mm
Rated Voltage	250Vdc to 630Vdc
Capacitance	10000pF to 1.0µF
Main Applications	For PFC (Power Factor Correction) Circuits of Power Supplies, EMI Suppression and Smoothing Circuits

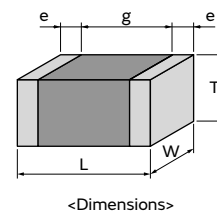

This catalog contains only a portion of the product lineup. Please refer to the capacitor search tool on the Murata Web site for details.

GR3 Series High Dielectric Constant Type Anti-noise Part Number List

2.0×1.25mm

T max.	Rated Voltage	TC Code	Cap.	Tol.	Part Number	p*
1.0mm	250Vdc	X7T	10000pF	±10%	GR321AD72E103KW01#	p111
			15000pF	±10%	GR321AD72E153KW01#	p111
1.45mm	250Vdc	X7T	22000pF	±10%	GR321BD72E223KW03#	p111

T max.	Rated Voltage	TC Code	Cap.	Tol.	Part Number	p*
2.7mm	250Vdc	X7T	1.0μF	±10%	GR355XD72E105KW05#	p111

3.2×1.6mm

T max.	Rated Voltage	TC Code	Cap.	Tol.	Part Number	p*
1.0mm	450Vdc	X7T	10000pF	±10%	GR331AD72W103KW01#	p114
			15000pF	±10%	GR331AD72W153KW01#	p114
	250Vdc	X7T	33000pF	±10%	GR331AD72E333KW01#	p111
1.25mm	630Vdc	X7T	10000pF	±10%	GR331BD72J103KW01#	p117
	450Vdc	X7T	22000pF	±10%	GR331BD72W223KW01#	p114
			33000pF	±10%	GR331BD72W333KW01#	p114
	250Vdc	X7T	47000pF	±10%	GR331BD72E473KW01#	p111
1.8mm	630Vdc	X7T	15000pF	±10%	GR331CD72J153KW03#	p117
	450Vdc	X7T	47000pF	±10%	GR331CD72W473KW03#	p114
	250Vdc	X7T	68000pF	±10%	GR331CD72E683KW03#	p111

3.2×2.5mm

T max.	Rated Voltage	TC Code	Cap.	Tol.	Part Number	p*
1.5mm	630Vdc	X7T	22000pF	±10%	GR332QD72J223KW01#	p117
	250Vdc	X7T	0.10μF	±10%	GR332QD72E104KW01#	p111
2.0mm	630Vdc	X7T	33000pF	±10%	GR332DD72J333KW01#	p117
			47000pF	±10%	GR332DD72J473KW01#	p117
	450Vdc	X7T	68000pF	±10%	GR332DD72W683KW01#	p114
			0.10μF	±10%	GR332DD72W104KW01#	p114
	250Vdc	X7T	0.15μF	±10%	GR332DD72E154KW01#	p111

4.5×3.2mm

T max.	Rated Voltage	TC Code	Cap.	Tol.	Part Number	p*
1.5mm	250Vdc	X7T	0.22μF	±10%	GR343QD72E224KW01#	p111
2.0mm	630Vdc	X7T	68000pF	±10%	GR343DD72J683KW01#	p117
	450Vdc	X7T	0.15μF	±10%	GR343DD72W154KW01#	p114
	250Vdc	X7T	0.33μF	±10%	GR343DD72E334KW01#	p111

5.7×5.0mm

T max.	Rated Voltage	TC Code	Cap.	Tol.	Part Number	p*
2.0mm	630Vdc	X7T	0.10μF	±10%	GR355DD72J104KW01#	p117
			0.15μF	±10%	GR355DD72J154KW01#	p117
	450Vdc	X7T	0.22μF	±10%	GR355DD72W224KW01#	p114
			0.33μF	±10%	GR355DD72W334KW01#	p114
			0.47μF	±10%	GR355DD72W474KW01#	p114
	250Vdc	X7T	0.47μF	±10%	GR355DD72E474KW01#	p111
0.68μF			±10%	GR355DD72E684KW01#	p111	
2.7mm	630Vdc	X7T	0.22μF	±10%	GR355XD72J224KW05#	p117

*: Refers to the page of the "Specifications and Test Methods".

Part number # indicates the package specification code.

GRM
 GR3
 GRJ
 GR4
 GR7
 GJM
 GQM
 GA2
 GA3 GB
 GA3 GD
 GA3 GF
 LLL
 LLA
 LLM
 LLR
 NFM
 KRM
 KR3
 GMA
 GMD
 ⚠Caution /Notice

1

GR3 Series Specifications and Test Methods (1)

No	Item	Specification	Test Method (Ref. Standard: JIS C 5101, IEC60384)												
1	Appearance	No defects or abnormalities.	Visual inspection.												
2	Dimension	Within the specified dimensions.	Using calipers and micrometers.												
3	Voltage Proof	No defects or abnormalities.	Measurement Point: Between the terminations Test Voltage: DC500V (200% of the rated voltage) Applied Time: 1 to 5s Charge/discharge current: 50mA max.												
4	Insulation Resistance (I.R.)	More than 10000MΩ or 100MΩ · μF (Whichever is smaller)	Measurement Point: Between the terminations Measurement Voltage: DC250±25V Charging Time: 60±5s Measurement Temperature: Room Temperature												
5	Capacitance	Shown in Rated value.	Measurement Temperature: Room Temperature												
6	Dissipation Factor (D.F.)	0.01 max.	Measurement Frequency: 1.0±0.1kHz Measurement Voltage: AC1.0±0.2V (r.m.s.)												
7	Temperature Characteristics of Capacitance	D7: Within +22/-33% (-55 to +125°C)	The capacitance change should be measured after 5 minutes at each specified temp. stage. Capacitance value as a reference is the value in step 3. <table border="1"> <thead> <tr> <th>Step</th> <th>Temperature (°C)</th> </tr> </thead> <tbody> <tr> <td>1</td> <td>Reference Temp. ±2</td> </tr> <tr> <td>2</td> <td>Min. Operating Temp. ±3</td> </tr> <tr> <td>3</td> <td>Reference Temp. ±2</td> </tr> <tr> <td>4</td> <td>Max. Operating Temp. ±3</td> </tr> <tr> <td>5</td> <td>Reference Temp. ±2</td> </tr> </tbody> </table> <ul style="list-style-type: none"> • Pretreatment Perform a heat treatment at 150+0/-10°C for 1h±5min and then let sit for 24±2h at room condition*. 	Step	Temperature (°C)	1	Reference Temp. ±2	2	Min. Operating Temp. ±3	3	Reference Temp. ±2	4	Max. Operating Temp. ±3	5	Reference Temp. ±2
Step	Temperature (°C)														
1	Reference Temp. ±2														
2	Min. Operating Temp. ±3														
3	Reference Temp. ±2														
4	Max. Operating Temp. ±3														
5	Reference Temp. ±2														
8	Appearance	No defects or abnormalities.	Solder the capacitor on the test substrate A shown in "Complement of Test Method". Kind of Vibration: A simple harmonic motion 10Hz to 55Hz to 10Hz (1min) Total amplitude: 1.5mm This motion should be applied for a period of 2h in each 3 mutually perpendicular directions (total of 6h).												
	Capacitance	Within the specified initial value.													
	D.F.	Within the specified initial value.													
9	Solderability	95% of the terminations is to be soldered evenly and continuously.	Test Method: Solder bath method Flux: Solution of rosin ethanol 25 (wt)% Preheat: 80 to 120°C for 10 to 30s Solder: Sn-3.0Ag-0.5Cu (Lead Free Solder) Solder Temp.: 245±5°C Immersion time: 2±0.5s Immersing in speed: 25±2.5mm/s.												
10	Appearance	No defects or abnormalities.	Test Method: Solder bath method Solder: Sn-3.0Ag-0.5Cu (Lead Free Solder) Solder Temp.: 260±5°C Immersion time: 10±1s Immersing in speed: 25±2.5mm/s. Exposure Time: 24±2h at room condition*. Preheat: GR331 size max.: 120 to 150°C for 1min GR332 size min.: 100 to 120°C for 1min and 170 to 200°C for 1min <ul style="list-style-type: none"> • Pretreatment Perform a heat treatment at 150+0/-10°C for 1h±5min and then let sit for 24±2h at room condition*. 												
	Capacitance Change	Within ±10%													
	D.F.	Within the specified initial value.													
	I.R.	Within the specified initial value.													
	Voltage Proof	No defects.													
11	Adhesive Strength of Termination	No removal of the terminations or other defect should occur.	Solder the capacitor on the test substrate A shown in "Complement of Test Method".  Applied Direction: In parallel with the test substrate and vertical with the capacitor side.												
12	Substrate Bending Test	No defects or abnormalities.	Solder the capacitor on the test substrate B shown in "Complement of Test Method". Then apply the force in the direction shown in "Test Method of Substrate Bending Test" of "Complement of Test Method". Flexure: 2mm (GR321 size: 1mm) Holding Time: 5±1s Soldering Method: Reflow soldering												

* Room Condition: Temperature: 15 to 35°C, Relative humidity: 45 to 75%, Atmosphere pressure: 86 to 106kPa

Continued on the following page. ↗

GRM
 GR3
 GRJ
 GR4
 GR7
 GJM
 GQM
 GA2
 GA3 GB
 GA3 GD
 GA3 GF
 LLL
 LLA
 LLM
 LLR
 NFM
 KPM
 KR3
 GMA
 GMD
 △Caution / Notice

GR3 Series Specifications and Test Methods (1)

Continued from the preceding page. ↘

No	Item	Specification	Test Method (Ref. Standard: JIS C 5101, IEC60384)															
13	Temperature Sudden Change	Appearance	Fix the capacitor to the supporting Test substrate A (glass epoxy board) shown in "Complement of Test Method". Perform the 5 cycles according to the four heat treatments shown in the following table. <table border="1" style="margin: 10px 0;"> <thead> <tr> <th>Step</th> <th>Temp. (°C)</th> <th>Time (min)</th> </tr> </thead> <tbody> <tr> <td>1</td> <td>Min. Operating Temp. +0/-3</td> <td>30±3</td> </tr> <tr> <td>2</td> <td>Room Temp.</td> <td>2 to 3</td> </tr> <tr> <td>3</td> <td>Max. Operating Temp. +3/-0</td> <td>30±3</td> </tr> <tr> <td>4</td> <td>Room Temp.</td> <td>2 to 3</td> </tr> </tbody> </table> Exposure Time: 24±2h at room condition*. • Pretreatment Perform a heat treatment at 150+0/-10°C for 1h±5min and then let sit for 24±2h. at room condition *.	Step	Temp. (°C)	Time (min)	1	Min. Operating Temp. +0/-3	30±3	2	Room Temp.	2 to 3	3	Max. Operating Temp. +3/-0	30±3	4	Room Temp.	2 to 3
	Step	Temp. (°C)		Time (min)														
	1	Min. Operating Temp. +0/-3		30±3														
	2	Room Temp.		2 to 3														
	3	Max. Operating Temp. +3/-0		30±3														
4	Room Temp.	2 to 3																
Capacitance Change	Within ±7.5%																	
D.F.	Within the specified initial value.																	
I.R.	Within the specified initial value.																	
Voltage Proof	No defects.																	
14	High Temperature High Humidity (Steady)	Appearance	Fix the capacitor to the supporting Test substrate A (glass epoxy board) shown in "Complement of Test Method". Test Temperature: 40±2°C Test Humidity: 90 to 95%RH Test Time: 500+24/-0h Applied Voltage: DC250V(DC Rated Voltage) Exposure Time: 24±2h at room condition*. • Pretreatment Apply test voltage for 1h±5min at test temperature. Remove and let sit for 24±2h at room condition*.															
	Capacitance Change	Within ±12.5%																
	D.F.	0.02 max.																
	I.R.	More than 1000MΩ or 10MΩ • μF (Whichever is smaller)																
	Voltage Proof	No defects.																
15	Durability	Appearance	Fix the capacitor to the supporting Test substrate A (glass epoxy board) shown in "Complement of Test Method". Test Temperature: Max. Operating Temp. ±3°C Test Time: 1000+48/-0h Applied Voltage: DC375V (150% of the rated voltage) Charge/discharge current: 50mA max. Exposure Time: 24±2h at room condition*. • Pretreatment Apply test voltage for 1h±5min at test temperature. Remove and let sit for 24±2h at room condition*.															
	Capacitance Change	Within ±12.5%																
	D.F.	0.02 max.																
	I.R.	More than 1000MΩ or 10MΩ • μF (Whichever is smaller)																
	Voltage Proof	No defects.																

* Room Condition: Temperature: 15 to 35°C, Relative humidity: 45 to 75%, Atmosphere pressure: 86 to 106kPa

Continued on the following page. ↗

GRM
 GR3
 GRJ
 GR4
 GR7
 GJM
 GQM
 GA2
 GA3 GB
 GA3 GD
 GA3 GF
 LLL
 LLA
 LLM
 LLR
 NFM
 KRM
 KR3
 GMA
 GMD
 ⚠Caution /Notice

GR3 Series Specifications and Test Methods (1)

Continued from the preceding page. ↘

Complement of Test Method

1. Test Substrate

The test substrate should be Substrate A or Substrate B as described in "Specifications and Test Methods".
 The specimen should be soldered by the conditions as described below.

Soldering Method: Reflow soldering
 Solder: Sn-3.0Ag-0.5Cu

(1) Test Substrate A

• Land Dimensions



- Material: Glass Epoxy Board
- Thickness: 1.6mm
- Thickness of Copper Foil: 0.035mm

Part Number	Dimension (mm)		
	a	b	c
GR321	1.2	4.0	1.65
GR331	2.2	5.0	2.0
GR332	2.2	5.0	2.9
GR342	3.5	7.0	2.4
GR343	3.5	7.0	3.7
GR352	4.5	8.0	3.2
GR355	4.5	8.0	5.6

(2) Test Substrate B



- Material: Glass Epoxy Board
- Thickness of Copper Foil: 0.035mm

Part Number	Dimension (mm)			
	a	b	c	d
GR321	1.2	4.0	1.65	1.0
GR331	2.2	5.0	2.0	1.0
GR332	2.2	5.0	2.9	1.0
GR342	3.5	7.0	2.4	1.0
GR343	3.5	7.0	3.7	1.0
GR352	4.5	8.0	3.2	1.0
GR355	4.5	8.0	5.6	1.0

2. Test Method of Substrate Bending Test

(a) Support State

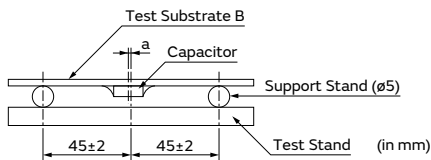

a: ±2 gap between support stand center and test stand

- Material of Test Stand and Pressure Stick
 The material should be a metal where a remarkable transformation and the distortion are not caused even if it is pressurized.
- Pressurizing Speed
 The pressurizing speed is pressurized at the speed of about 1mm/s until the flexure reaches a regulated value.



(b) Test State

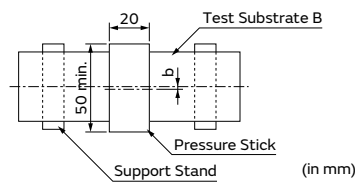

b: ±5 gap between support stand center and test stand center

GRM
 GR3
 GRJ
 GR4
 GR7
 GJM
 GQM
 GA2
 GA3 GB
 GA3 GD
 GA3 GF
 LLL
 LLA
 LLM
 LLR
 NFM
 KPM
 KR3
 GMA
 GMD
 ⚠Caution / Notice

2

GR3 Series Specifications and Test Methods (2)

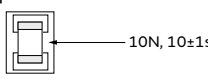
No	Item	Specification	Test Method (Ref. Standard: JIS C 5101, IEC60384)									
1	Appearance	No defects or abnormalities.	Visual inspection.									
2	Dimension	Within the specified dimensions.	Using calipers and micrometers.									
3	Voltage Proof	No defects or abnormalities.	Measurement Point: Between the terminations Test Voltage: DC675V (150% of the rated voltage) Applied Time: 1 to 5s Charge/discharge current: 50mA max.									
4	Insulation Resistance (I.R.)	More than 10000MΩ or 100MΩ • μF (Whichever is smaller)	Measurement Point: Between the terminations Measurement Voltage: DC250±25V Charging Time: 60±5s Measurement Temperature: Room Temperature									
5	Capacitance	Shown in Rated value.	Measurement Temperature: Room Temperature									
6	Dissipation Factor (D.F.)	0.01 max.	Measurement Frequency: 1.0±0.1kHz Measurement Voltage: AC1.0±0.2V (r.m.s.)									
7	Temperature Characteristics of Capacitance	D7: Within +22/-33% (-55 to +125°C)	The capacitance change should be measured after 5 minutes at each specified temp. stage. Capacitance value as a reference is the value in step 3.									
			<table border="1"> <thead> <tr> <th>Step</th> <th>Temperature (°C)</th> </tr> </thead> <tbody> <tr> <td>1</td> <td>Reference Temp. ±2</td> </tr> <tr> <td>2</td> <td>Min. Operating Temp. ±3</td> </tr> <tr> <td>3</td> <td>Reference Temp. ±2</td> </tr> <tr> <td>4</td> <td>Max. Operating Temp. ±3</td> </tr> <tr> <td>5</td> <td>Reference Temp. ±2</td> </tr> </tbody> </table> <p>• Pretreatment Perform a heat treatment at 150+0/-10°C for 1h±5min and then let sit for 24±2h at room condition*.</p>	Step	Temperature (°C)	1	Reference Temp. ±2	2	Min. Operating Temp. ±3	3	Reference Temp. ±2	4
Step	Temperature (°C)											
1	Reference Temp. ±2											
2	Min. Operating Temp. ±3											
3	Reference Temp. ±2											
4	Max. Operating Temp. ±3											
5	Reference Temp. ±2											
8	Vibration	Appearance	No defects or abnormalities.									
		Capacitance	Within the specified initial value.									
		D.F.	Within the specified initial value.									
9	Solderability	95% of the terminations is to be soldered evenly and continuously.	Test Method: Solder bath method Flux: Solution of rosin ethanol 25 (wt)% Preheat: 80 to 120°C for 10 to 30s Solder: Sn-3.0Ag-0.5Cu (Lead Free Solder) Solder Temp.: 245±5°C Immersion time: 2±0.5s Immersing in speed: 25±2.5mm/s.									
10	Resistance to Soldering Heat	Appearance	No defects or abnormalities.									
		Capacitance Change	Within ±10%									
		D.F.	Within the specified initial value.									
		I.R.	Within the specified initial value.									
		Voltage Proof	No defects.									
11	Adhesive Strength of Termination	No removal of the terminations or other defect should occur.	Test Method: Solder bath method Solder: Sn-3.0Ag-0.5Cu (Lead Free Solder) Solder Temp.: 260±5°C Immersion time: 10±1s Immersing in speed: 25±2.5mm/s. Exposure Time: 24±2h at room condition*. Preheat: GR331 size max.: 120 to 150°C for 1min GR332 size min.: 100 to 120°C for 1min and 170 to 200°C for 1min • Pretreatment Perform a heat treatment at 150+0/-10°C for 1h±5min and then let sit for 24±2h at room condition*.  Applied Direction: In parallel with the test substrate and vertical with the capacitor side.									
12	Substrate Bending Test	No defects or abnormalities.	Solder the capacitor on the test substrate B shown in "Complement of Test Method". Then apply the force in the direction shown in "Test Method of Substrate Bending Test" of "Complement of Test Method". Flexure: 2mm Holding Time: 5±1s Soldering Method: Reflow soldering									

* Room Condition: Temperature: 15 to 35°C, Relative humidity: 45 to 75%, Atmosphere pressure: 86 to 106kPa

Continued on the following page. ↗

GRM
GR3
GRJ
GR4
GR7
GJM
GQM
GA2
GA3 GB
GA3 GD
GA3 GF
LLL
LLA
LLM
LLR
NFM
KRM
KR3
GMA
GMD
⚠Caution /Notice

GR3 Series Specifications and Test Methods (2)

Continued from the preceding page. ↘

No	Item	Specification	Test Method (Ref. Standard: JIS C 5101, IEC60384)
13	Temperature Sudden Change	Appearance	No defects or abnormalities.
		Capacitance Change	Within $\pm 7.5\%$
		D.F.	Within the specified initial value.
		I.R.	Within the specified initial value.
		Voltage Proof	No defects.
14	High Temperature High Humidity (Steady)	Appearance	No defects or abnormalities.
		Capacitance Change	Within $\pm 12.5\%$
		D.F.	0.02 max.
		I.R.	More than $1000M\Omega$ or $10M\Omega \cdot \mu F$ (Whichever is smaller)
		Voltage Proof	No defects.
15	Durability	Appearance	No defects or abnormalities.
		Capacitance Change	Within $\pm 12.5\%$
		D.F.	0.02 max.
		I.R.	More than $1000M\Omega$ or $10M\Omega \cdot \mu F$ (Whichever is smaller)
		Voltage Proof	No defects.

Step	Temp. (°C)	Time (min)
1	Min. Operating Temp. +0/-3	30±3
2	Room Temp.	2 to 3
3	Max. Operating Temp. +3/-0	30±3
4	Room Temp.	2 to 3

Exposure Time: 24±2h at room condition*.
 • Pretreatment
 Perform a heat treatment at 150+0/-10°C for 1h±5min and then let sit for 24±2h. at room condition*.

Fix the capacitor to the supporting Test substrate A (glass epoxy board) shown in "Complement of Test Method".
 Test Temperature: 40±2°C
 Test Humidity: 90 to 95%RH
 Test Time: 500+24/-0h
 Applied Voltage: DC450V (DC Rated Voltage)
 Exposure Time: 24±2h at room condition*.
 • Pretreatment
 Apply test voltage for 1h±5min at test temperature.
 Remove and let sit for 24±2h at room condition*.

Fix the capacitor to the supporting Test substrate A (glass epoxy board) shown in "Complement of Test Method".
 Test Temperature: Max. Operating Temp. ±3°C
 Test Time: 1000+48/-0h
 Applied Voltage: DC585V (130% of the rated voltage)
 Charge/discharge current: 50mA max.
 Exposure Time: 24±2h at room condition*.
 • Pretreatment
 Apply test voltage for 1h±5min at test temperature.
 Remove and let sit for 24±2h at room condition*.

* Room Condition: Temperature: 15 to 35°C, Relative humidity: 45 to 75%, Atmosphere pressure: 86 to 106kPa

Continued on the following page. ↗

GRM
 GR3
 GRJ
 GR4
 GR7
 GJM
 GQM
 GA2
 GA3 GB
 GA3 GD
 GA3 GF
 LLL
 LLA
 LLM
 LLR
 NFM
 KPM
 KR3
 GMA
 GMD
 ⚠Caution / Notice

GR3 Series Specifications and Test Methods (2)

Continued from the preceding page. ↘

Complement of Test Method

1. Test Substrate

The test substrate should be Substrate A or Substrate B as described in "Specifications and Test Methods".
 The specimen should be soldered by the conditions as described below.

Soldering Method: Reflow soldering
 Solder: Sn-3.0Ag-0.5Cu

(1) Test Substrate A

- Land Dimensions

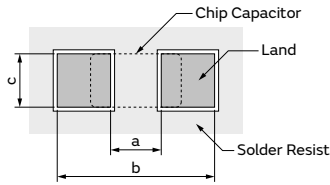

- Material: Glass Epoxy Board
- Thickness: 1.6mm
- Thickness of Copper Foil: 0.035mm

Part Number	Dimension (mm)		
	a	b	c
GR318	1.0	3.0	1.2
GR321	1.2	4.0	1.65
GR331	2.2	5.0	2.0
GR332	2.2	5.0	2.9
GR342	3.5	7.0	2.4
GR343	3.5	7.0	3.7
GR352	4.5	8.0	3.2
GR355	4.5	8.0	5.6

(2) Test Substrate B

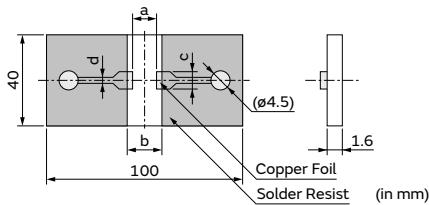

- Material: Glass Epoxy Board
- Thickness of Copper Foil: 0.035mm

Part Number	Dimension (mm)			
	a	b	c	d
GR318	1.0	3.0	1.2	1.0
GR321	1.2	4.0	1.65	1.0
GR331	2.2	5.0	2.0	1.0
GR332	2.2	5.0	2.9	1.0
GR342	3.5	7.0	2.4	1.0
GR343	3.5	7.0	3.7	1.0
GR352	4.5	8.0	3.2	1.0
GR355	4.5	8.0	5.6	1.0

2. Test Method of Substrate Bending Test

(a) Support State

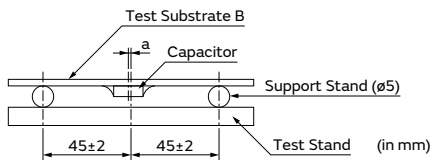

a: ±2 gap between support stand center and test stand

(b) Test State

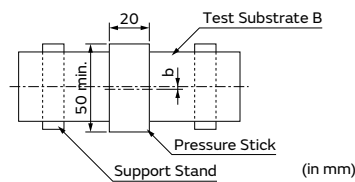

b: ±5 gap between support stand center and test stand center

- Material of Test Stand and Pressure Stick
 The material should be a metal where a remarkable transformation and the distortion are not caused even if it is pressurized.
- Pressurizing Speed
 The pressurizing speed is pressurized at the speed of about 1mm/s until the flexure reaches a regulated value.

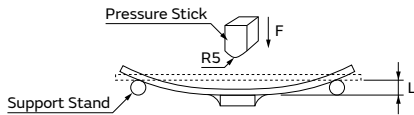

3

GR3 Series Specifications and Test Methods (3)

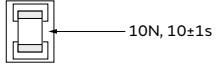
No	Item	Specification	Test Method (Ref. Standard: JIS C 5101, IEC60384)												
1	Appearance	No defects or abnormalities.	Visual inspection.												
2	Dimension	Within the specified dimensions.	Using calipers and micrometers.												
3	Voltage Proof	No defects or abnormalities.	Measurement Point: Between the terminations Test Voltage: DC756V (120% of the rated voltage) Applied Time: 1 to 5s Charge/discharge current: 50mA max.												
4	Insulation Resistance (I.R.)	More than 10000MΩ or 100MΩ · μF (Whichever is smaller)	Measurement Point: Between the terminations Measurement Voltage: DC500±50V Charging Time: 60±5s Measurement Temperature: Room Temperature												
5	Capacitance	Shown in Rated value.	Measurement Temperature: Room Temperature												
6	Dissipation Factor (D.F.)	0.01 max.	Measurement Frequency: 1.0±0.1kHz Measurement Voltage: AC1.0±0.2V (r.m.s.)												
7	Temperature Characteristics of Capacitance	D7: Within +22/-33% (-55 to +125°C)	The capacitance change should be measured after 5 minutes at each specified temp. stage. Capacitance value as a reference is the value in step 3. <table border="1"> <thead> <tr> <th>Step</th> <th>Temperature (°C)</th> </tr> </thead> <tbody> <tr> <td>1</td> <td>Reference Temp. ±2</td> </tr> <tr> <td>2</td> <td>Min. Operating Temp. ±3</td> </tr> <tr> <td>3</td> <td>Reference Temp. ±2</td> </tr> <tr> <td>4</td> <td>Max. Operating Temp. ±3</td> </tr> <tr> <td>5</td> <td>Reference Temp. ±2</td> </tr> </tbody> </table> <ul style="list-style-type: none"> • Pretreatment Perform a heat treatment at 150+0/-10°C for 1h±5min and then let sit for 24±2h at room condition*. 	Step	Temperature (°C)	1	Reference Temp. ±2	2	Min. Operating Temp. ±3	3	Reference Temp. ±2	4	Max. Operating Temp. ±3	5	Reference Temp. ±2
Step	Temperature (°C)														
1	Reference Temp. ±2														
2	Min. Operating Temp. ±3														
3	Reference Temp. ±2														
4	Max. Operating Temp. ±3														
5	Reference Temp. ±2														
8	Vibration	Appearance	Solder the capacitor on the test substrate A shown in "Complement of Test Method". Kind of Vibration: A simple harmonic motion 10Hz to 55Hz to 10Hz (1min) Total amplitude: 1.5mm This motion should be applied for a period of 2h. in each 3 mutually perpendicular directions (total of 6h).												
		Capacitance													
		D.F.													
9	Solderability	95% of the terminations is to be soldered evenly and continuously.	Test Method: Solder bath method Flux: Solution of rosin ethanol 25 (wt)% Preheat: 80 to 120°C for 10 to 30s Solder: Sn-3.0Ag-0.5Cu (Lead Free Solder) Solder Temp.: 245±5°C Immersion time: 2±0.5s Immersing in speed: 25±2.5mm/s.												
10	Resistance to Soldering Heat	Appearance	Test Method: Solder bath method Solder: Sn-3.0Ag-0.5Cu (Lead Free Solder) Solder Temp.: 260±5°C Immersion time: 10±1s Immersing in speed: 25±2.5mm/s. Exposure Time: 24±2h at room condition*. Preheat: GR331 size max.: 120 to 150°C for 1min GR332 size min.: 100 to 120°C for 1min and 170 to 200°C for 1min <ul style="list-style-type: none"> • Pretreatment Perform a heat treatment at 150+0/-10°C for 1h±5min and then let sit for 24±2h at room condition*. 												
		Capacitance Change													
		D.F.													
		I.R.													
		Voltage Proof													
11	Adhesive Strength of Termination	No removal of the terminations or other defect should occur.	Solder the capacitor on the test substrate A shown in "Complement of Test Method".  Applied Direction: In parallel with the test substrate and vertical with the capacitor side.												

* Room Condition: Temperature: 15 to 35°C, Relative humidity: 45 to 75%, Atmosphere pressure: 86 to 106kPa

Continued on the following page.➤

GRM
 GR3
 GRJ
 GR4
 GR7
 GJM
 GQM
 GA2
 GA3 GB
 GA3 GD
 GA3 GF
 LLL
 LLA
 LLM
 LLR
 NFM
 KRM
 KR3
 GMA
 GMD
 △Caution / Notice

GR3 Series Specifications and Test Methods (3)

Continued from the preceding page. ↘

No	Item	Specification	Test Method (Ref. Standard: JIS C 5101, IEC60384)															
12	Substrate Bending Test	No defects or abnormalities.	Solder the capacitor on the test substrate B shown in "Complement of Test Method". Then apply the force in the direction shown in "Test Method of Substrate Bending Test" of "Complement of Test Method". Flexure: 2mm Holding Time: 5±1s Soldering Method: Reflow soldering															
13	Temperature Sudden Change	Appearance	Fix the capacitor to the supporting Test substrate A (glass epoxy board) shown in "Complement of Test Method". Perform the 5 cycles according to the four heat treatments shown in the following table. <table border="1" style="margin: 5px 0;"> <thead> <tr> <th>Step</th> <th>Temp. (°C)</th> <th>Time (min)</th> </tr> </thead> <tbody> <tr> <td>1</td> <td>Min. Operating Temp. +0/-3</td> <td>30±3</td> </tr> <tr> <td>2</td> <td>Room Temp.</td> <td>2 to 3</td> </tr> <tr> <td>3</td> <td>Max. Operating Temp. +3/-0</td> <td>30±3</td> </tr> <tr> <td>4</td> <td>Room Temp.</td> <td>2 to 3</td> </tr> </tbody> </table> Exposure Time: 24±2h at room condition*. • Pretreatment Perform a heat treatment at 150+0/-10°C for 1h±5min and then let sit for 24±2h. at room condition*.	Step	Temp. (°C)	Time (min)	1	Min. Operating Temp. +0/-3	30±3	2	Room Temp.	2 to 3	3	Max. Operating Temp. +3/-0	30±3	4	Room Temp.	2 to 3
		Step		Temp. (°C)	Time (min)													
		1		Min. Operating Temp. +0/-3	30±3													
		2		Room Temp.	2 to 3													
		3		Max. Operating Temp. +3/-0	30±3													
4	Room Temp.	2 to 3																
Capacitance Change	Within ±7.5%																	
D.F.	Within the specified initial value.																	
I.R.	Within the specified initial value.																	
Voltage Proof	No defects.																	
14	High Temperature High Humidity (Steady)	Appearance	Fix the capacitor to the supporting Test substrate A (glass epoxy board) shown in "Complement of Test Method". Test Temperature: 40±2°C Test Humidity: 90 to 95%RH Test Time: 500+24/-0h Applied Voltage: DC630V (DC Rated Voltage) Exposure Time: 24±2h at room condition*. • Pretreatment Apply test voltage for 1h±5min at test temperature. Remove and let sit for 24±2h at room condition*.															
		Capacitance Change		Within ±12.5%														
		D.F.		0.02 max.														
		I.R.		More than 1000MΩ or 10MΩ • μF (Whichever is smaller)														
		Voltage Proof		No defects.														
15	Durability	Appearance	Fix the capacitor to the supporting Test substrate A (glass epoxy board) shown in "Complement of Test Method". Test Temperature: Max. Operating Temp. ±3°C Test Time: 1000+48/-0h Applied Voltage: DC756V (120% of the rated voltage) Charge/discharge current: 50mA max. Exposure Time: 24±2h at room condition*. • Pretreatment Apply test voltage for 1h±5min at test temperature. Remove and let sit for 24±2h at room condition*.															
		Capacitance Change		Within ±12.5%														
		D.F.		0.02 max.														
		I.R.		More than 1000MΩ or 10MΩ • μF (Whichever is smaller)														
		Voltage Proof		No defects.														

* Room Condition: Temperature: 15 to 35°C, Relative humidity: 45 to 75%, Atmosphere pressure: 86 to 106kPa

Continued on the following page. ↗

GRM
 GR3
 GRJ
 GR4
 GR7
 GJM
 GQM
 GA2
 GA3 GB
 GA3 GD
 GA3 GF
 LLL
 LLA
 LLM
 LLR
 NFM
 KRM
 KR3
 GMA
 GMD
 ⚠Caution /Notice

GR3 Series Specifications and Test Methods (3)

Continued from the preceding page. ↘

Complement of Test Method

1. Test Substrate

The test substrate should be Substrate A or Substrate B as described in "Specifications and Test Methods".
 The specimen should be soldered by the conditions as described below.

Soldering Method: Reflow soldering
 Solder: Sn-3.0Ag-0.5Cu

(1) Test Substrate A

• Land Dimensions

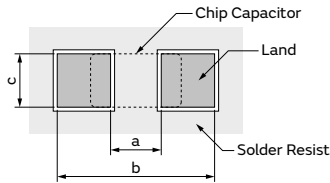

- Material: Glass Epoxy Board
- Thickness: 1.6mm
- Thickness of Copper Foil: 0.035mm

Part Number	Dimension (mm)		
	a	b	c
GR318	1.0	3.0	1.2
GR321	1.2	4.0	1.65
GR331	2.2	5.0	2.0
GR332	2.2	5.0	2.9
GR342	3.5	7.0	2.4
GR343	3.5	7.0	3.7
GR352	4.5	8.0	3.2
GR355	4.5	8.0	5.6

(2) Test Substrate B

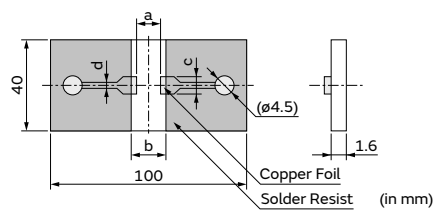

- Material: Glass Epoxy Board
- Thickness of Copper Foil: 0.035mm

Part Number	Dimension (mm)			
	a	b	c	d
GR318	1.0	3.0	1.2	1.0
GR321	1.2	4.0	1.65	1.0
GR331	2.2	5.0	2.0	1.0
GR332	2.2	5.0	2.9	1.0
GR342	3.5	7.0	2.4	1.0
GR343	3.5	7.0	3.7	1.0
GR352	4.5	8.0	3.2	1.0
GR355	4.5	8.0	5.6	1.0

2. Test Method of Substrate Bending Test

(a) Support State

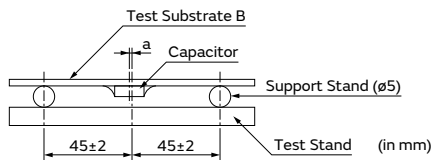

a: ±2 gap between support stand center and test stand

- Material of Test Stand and Pressure Stick
 The material should be a metal where a remarkable transformation and the distortion are not caused even if it is pressurized.
- Pressurizing Speed
 The pressurizing speed is pressurized at the speed of about 1mm/s until the flexure reaches a regulated value.

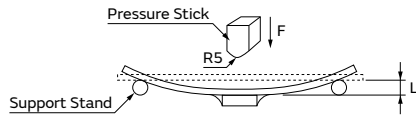

(b) Test State

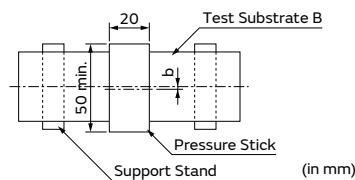

b: ±5 gap between support stand center and test stand center

GRM
 GR3
 GRJ
 GR4
 GR7
 GJM
 GQM
 GA2
 GA3 GB
 GA3 GD
 GA3 GF
 LLL
 LLA
 LLM
 LLR
 NFM
 KPM
 KR3
 GMA
 GMD
 ⚠Caution / Notice

Soft Termination Chip Multilayer Ceramic Capacitors for General Purpose

GRJ Series



Cracking caused by flexing stress after board mounting is minimized due to resin external electrodes!

Features

1 The resin external electrodes suppress cracks by board deflection.

Cracking of the ceramic element is suppressed by the resin of the external electrodes, which releases the stress.

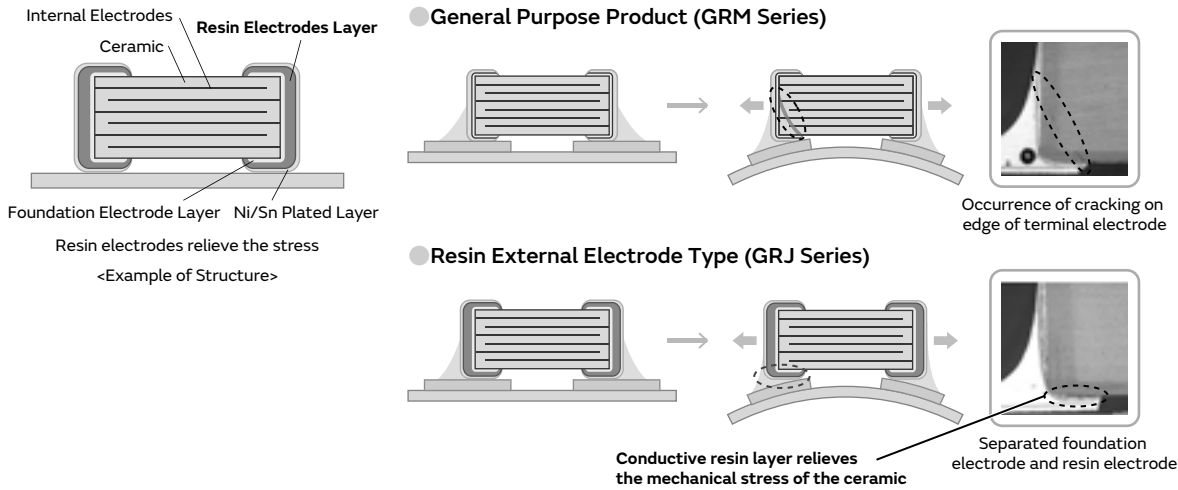

Note: Cracks may occur in the capacitor body if excessive stress beyond the "guaranteed range of board bending strength (*)" provided in the specifications is applied. Capacitors with cracks in them may cause a drop in insulation resistance, which could lead to a short circuit.
 (*) For details on the guaranteed range of board bending strength, check the "Detailed Specification Sheet" on the Product Details Page.

2 Suppresses the occurrence of cracking caused by deflection stress at the time of board mounting, etc.

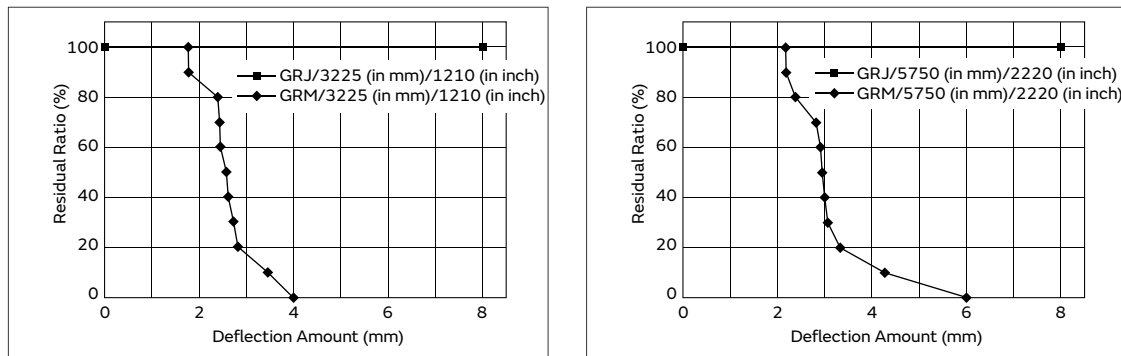

Due to the specification of the measuring instrument, measurements can be performed up to 8mm.

3 Ideal for consumer and industrial electronic equipment, etc. where there heat stress, vibration and impact are applied.

Specifications

Size (mm)	0.6×0.3mm to 5.7×5.0mm
Rated Voltage	6.3Vdc to 1000Vdc
Capacitance	220pF to 47μF
Main Applications	Consumer & Industrial Electronic Equipment

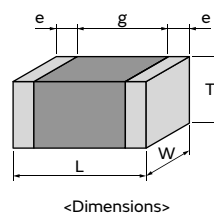

This catalog contains only a portion of the product lineup. Please refer to the capacitor search tool on the Murata Web site for details.

GRJ Series High Dielectric Constant Type Part Number List

1.6×0.8mm

T max.	Rated Voltage	TC Code	Cap.	Tol.	Part Number
0.9mm	100Vdc	X7R	1000pF	±10%	GRJ188R72A102KE11#
				±20%	GRJ188R72A102ME11#
			2200pF	±10%	GRJ188R72A222KE11#
				±20%	GRJ188R72A222ME11#
			4700pF	±10%	GRJ188R72A472KE11#
				±20%	GRJ188R72A472ME11#
			10000pF	±10%	GRJ188R72A103KE11#
				±20%	GRJ188R72A103ME11#
			22000pF	±10%	GRJ188R72A223KE11#
				±20%	GRJ188R72A223ME11#
			0.10μF	±10%	GRJ188R72A104KE11#
				±20%	GRJ188R72A104ME11#
	50Vdc	X7R	1000pF	±10%	GRJ188R71H102KE11#
				±20%	GRJ188R71H102ME11#
			2200pF	±10%	GRJ188R71H222KE11#
				±20%	GRJ188R71H222ME11#
			4700pF	±10%	GRJ188R71H472KE11#
				±20%	GRJ188R71H472ME11#
			10000pF	±10%	GRJ188R71H103KE11#
				±20%	GRJ188R71H103ME11#
			22000pF	±10%	GRJ188R71H223KE11#
				±20%	GRJ188R71H223ME11#
			47000pF	±10%	GRJ188R71H473KE11#
				±20%	GRJ188R71H473ME11#
0.10μF	±10%	GRJ188R71H104KE11#			
	±20%	GRJ188R71H104ME11#			
0.22μF	±10%	GRJ188R71H224KE11#			
	±20%	GRJ188R71H224ME11#			
35Vdc	X5R	1.0μF	±10%	GRJ188R6VA105KE11#	
25Vdc	X7R	47000pF	±10%	GRJ188R71E473KE11#	
			±20%	GRJ188R71E473ME11#	
		0.22μF	±10%	GRJ188R71E224KE11#	
			±20%	GRJ188R71E224ME11#	
1.0μF	±10%	GRJ188R71E105KE11#			
	±20%	GRJ188R71E105ME11#			
16Vdc	X7R	0.47μF	±10%	GRJ188R71C474KE11#	
			±20%	GRJ188R71C474ME11#	
6.3Vdc	X7R	2.2μF	±10%	GRJ188R70J225KE11#	
			±20%	GRJ188R70J225ME11#	
1.0mm	6.3Vdc	X7S	4.7μF	±10%	GRJ188C70J475KE11#
				±20%	GRJ188C70J475ME11#

2.0×1.25mm

T max.	Rated Voltage	TC Code	Cap.	Tol.	Part Number
0.7mm	100Vdc	X7R	1000pF	±10%	GRJ216R72A102KE01#
				±20%	GRJ216R72A102ME01#
			2200pF	±10%	GRJ216R72A222KE01#
				±20%	GRJ216R72A222ME01#
			4700pF	±10%	GRJ216R72A472KE01#
				±20%	GRJ216R72A472ME01#

T max.	Rated Voltage	TC Code	Cap.	Tol.	Part Number				
0.7mm	100Vdc	X7R	10000pF	±10%	GRJ216R72A103KE01#				
				±20%	GRJ216R72A103ME01#				
			22000pF	±10%	GRJ216R72A223KE01#				
				±20%	GRJ216R72A223ME01#				
			50Vdc	X7R	470pF	±10%	GRJ216R71H471KE01#		
						±20%	GRJ216R71H471ME01#		
	1000pF	±10%			GRJ216R71H102KE01#				
		±20%			GRJ216R71H102ME01#				
	2200pF	±10%			GRJ216R71H222KE01#				
		±20%			GRJ216R71H222ME01#				
	4700pF	±10%	GRJ216R71H472KE01#	±20%	GRJ216R71H472ME01#				
						10000pF	±10%	GRJ216R71H103KE01#	
±20%							GRJ216R71H103ME01#		
22000pF						±10%	GRJ216R71H223KE01#		
						±20%	GRJ216R71H223ME01#		
0.95mm						100Vdc	X7R	220pF	±10%
	±20%	GRJ219R72A221ME01#							
	470pF	±10%	GRJ219R72A471KE01#						
		±20%	GRJ219R72A471ME01#						
	1.0mm	250Vdc	X7R	1000pF	±10%			GRJ21AR72E102KWJ1#	
					±10%			GRJ21AR72E152KWJ1#	
2200pF				±10%	GRJ21AR72E222KWJ1#				
				±10%	GRJ21AR72E332KWJ1#				
4700pF				±10%	GRJ21AR72E472KWJ1#				
				±10%	GRJ21AR72E682KWJ1#				
1.45mm	250Vdc	X7R	10000pF	±10%	GRJ21BR72E103KWJ3#				
				±10%	GRJ21BR72E153KWJ3#				
			22000pF	±10%	GRJ21BR72E223KWJ3#				
				±10%	GRJ21BR72E223KWJ3#				
			100Vdc	X7R	47000pF	±10%	GRJ21BR72A473KE01#		
						±20%	GRJ21BR72A473ME01#		
	0.10μF	±10%			GRJ21BR72A104KE01#				
		±20%			GRJ21BR72A104ME01#				
	50Vdc	X7R			47000pF	±10%	GRJ21BR71H473KE01#		
						±20%	GRJ21BR71H473ME01#		
			0.10μF	±10%	GRJ21BR71H104KE01#				
				±20%	GRJ21BR71H104ME01#				
0.22μF			±10%	GRJ21BR71H224KE01#					
			±20%	GRJ21BR71H224ME01#					
0.47μF	±10%	GRJ21BR71H474KE01#	±20%	GRJ21BR71H474ME01#					
					1.0μF	±10%	GRJ21BR71H105KE01#		
						±20%	GRJ21BR71H105ME01#		
					25Vdc	X7R	1.0μF	±10%	GRJ21BR71E105KE11#
								±20%	GRJ21BR71E105ME11#
							2.2μF	±10%	GRJ21BR71E225KE01#
±20%	GRJ21BR71E225ME01#								
16Vdc	X7R	4.7μF	±10%	GRJ21BR71C475KE01#					
			±20%	GRJ21BR71C475ME01#					
10Vdc	X7R	10μF	±10%	GRJ21BR71A106KE01#					
			±20%	GRJ21BR71A106ME01#					
1.5mm	100Vdc	X7S	1.0μF	±10%	GRJ21BC72A105KE11#				
				±20%	GRJ21BC72A105ME11#				

Part number # indicates the package specification code.

- GRM
- GR3
- GRJ
- GR4
- GR7
- GJM
- GQM
- GA2
- GA3 GB
- GA3 GD
- GA3 GF
- LLL
- LLA
- LLM
- LLR
- NFM
- KRM
- KR3
- GMA
- GMD
- ⚠Caution /Notice

GRJ Series High Dielectric Constant Type Part Number List

3.2×1.6mm

T max.	Rated Voltage	TC Code	Cap.	Tol.	Part Number				
0.95mm	100Vdc	X7R	0.10μF	±10%	GRJ319R72A104KE11#				
				±20%	GRJ319R72A104ME11#				
	50Vdc		0.10μF	±10%	GRJ319R71H104KE11#				
				±20%	GRJ319R71H104ME11#				
1.25mm	1000Vdc	X7R	470pF	±10%	GRJ31BR73A471KWJ1#				
				±10%	GRJ31BR73A681KWJ1#				
				±10%	GRJ31BR73A102KWJ1#				
				±10%	GRJ31BR73A152KWJ1#				
				±10%	GRJ31BR73A222KWJ1#				
				±10%	GRJ31BR73A332KWJ1#				
				±10%	GRJ31BR73A472KWJ1#				
				630Vdc	X7R	1000pF	±10%	GRJ31BR72J102KWJ1#	
	±10%	GRJ31BR72J152KWJ1#							
	±10%	GRJ31BR72J222KWJ1#							
	±10%	GRJ31BR72J332KWJ1#							
	±10%	GRJ31BR72J472KWJ1#							
	±10%	GRJ31BR72J682KWJ1#							
	250Vdc	X7R	15000pF	±10%	GRJ31BR72E153KWJ1#				
±10%				GRJ31BR72E223KWJ1#					
±10%				GRJ31BR72E683KWJ1#					
1.35mm				100Vdc	X7R	0.22μF	±10%	GRJ31MR72A224KE01#	
							±20%	GRJ31MR72A224ME01#	
							50Vdc	X7R	0.10μF
	±20%	GRJ31MR71H104ME01#							
0.22μF	±10%	GRJ31MR71H224KE01#							
	±20%	GRJ31MR71H224ME01#							
0.47μF	±10%	GRJ31MR71H474KE01#							
	±20%	GRJ31MR71H474ME01#							
1.0μF	±10%	GRJ31MR71H105KE01#							
	±20%	GRJ31MR71H105ME01#							
25Vdc	X7R	2.2μF	±10%	GRJ31MR71E225KE11#					
			±20%	GRJ31MR71E225ME11#					
			16Vdc	X7R	2.2μF	±10%	GRJ31MR71C225KE11#		
						±20%	GRJ31MR71C225ME11#		
1.8mm	1000Vdc	X7R	6800pF	±10%	GRJ31CR73A682KWJ3#				
				±10%	GRJ31CR73A103KWJ3#				
	630Vdc		X7R	15000pF	±10%	GRJ31CR72J153KWJ3#			
					±10%	GRJ31CR72J223KWJ3#			
	250Vdc		X7R	33000pF	±10%	GRJ31CR72E333KWJ3#			
					±10%	GRJ31CR72E473KWJ3#			
	0.10μF		±10%	GRJ31CR72E104KWJ3#					
			1.9mm	100Vdc	X7R	1.0μF	±10%	GRJ31CR72A105KE11#	
±20%	GRJ31CR72A105ME11#								
50Vdc	X7R	1.0μF				±10%	GRJ31CR71H105KE11#		
						±20%	GRJ31CR71H105ME11#		
2.2μF	±10%	GRJ31CR71H225KE11#							
	±20%	GRJ31CR71H225ME11#							
4.7μF	±10%	GRJ31CR71H475KE11#							
	±20%	GRJ31CR71H475ME11#							
35Vdc	X6S	10μF	±10%	GRJ31CC8YA106KE01#	D1				
			±20%	GRJ31CC8YA106ME01#	D1				

T max.	Rated Voltage	TC Code	Cap.	Tol.	Part Number	
1.9mm	25Vdc	X7R	10μF	±10%	GRJ31CR71E106KE11#	
				±20%	GRJ31CR71E106ME11#	
	16Vdc	X7R	4.7μF	±10%	GRJ31CR71C475KE11#	
				±20%	GRJ31CR71C475ME11#	
			10μF	±10%	GRJ31CR71C106KE11#	
				±20%	GRJ31CR71C106ME11#	
	10Vdc	X7R	10μF	±10%	GRJ31CR71A106KE11#	
				±20%	GRJ31CR71A106ME11#	
			22μF	±10%	GRJ31CR71A226KE12#	
				±20%	GRJ31CR71A226ME12#	
6.3Vdc	X7R	22μF	±10%	GRJ31CR70J226KE12#		
			±20%	GRJ31CR70J226ME12#		

3.2×2.5mm

T max.	Rated Voltage	TC Code	Cap.	Tol.	Part Number			
1.5mm	1000Vdc	X7R	6800pF	±10%	GRJ32QR73A682KWJ1#			
				±10%	GRJ32QR73A103KWJ1#			
	630Vdc		X7R	22000pF	±10%	GRJ32QR72J223KWJ1#		
					±10%	GRJ32QR72E154KWJ1#		
2.0mm	1000Vdc	X7R	15000pF	±10%	GRJ32DR73A153KWJ1#			
				±10%	GRJ32DR73A223KWJ1#			
	630Vdc		X7R	33000pF	±10%	GRJ32DR72J333KWJ1#		
					±10%	GRJ32DR72J473KWJ1#		
	250Vdc		X7R	0.10μF	±10%	GRJ32DR72E104KWJ1#		
					±10%	GRJ32DR72E224KWJ1#		
	2.3mm		100Vdc	X7R	2.2μF	±10%	GRJ32DR72A225KE11#	
						±20%	GRJ32DR72A225ME11#	
X7S		4.7μF	±10%		GRJ32DC72A475KE11#			
			±20%		GRJ32DC72A475ME11#			
2.8mm	50Vdc	X7R	4.7μF	±10%	GRJ32ER71H475KE11#			
				±20%	GRJ32ER71H475ME11#			
			10μF	±10%	GRJ32ER71H106KE11#			
				±20%	GRJ32ER71H106ME11#			
	X7S	10μF	±10%	GRJ32EC71H106KE11#				
			±20%	GRJ32EC71H106ME11#				
	25Vdc	X7R	10μF	±10%	GRJ32ER71E106KE11#			
				±20%	GRJ32ER71E106ME11#			
	16Vdc	X7R	22μF	±10%	GRJ32ER71C226KE11#			
				±20%	GRJ32ER71C226ME11#			
10Vdc	X7R	22μF	±10%	GRJ32ER71A226KE11#				
			±20%	GRJ32ER71A226ME11#				
		47μF	±10%	GRJ32ER71A476KE11#				
			±20%	GRJ32ER71A476ME11#				
6.3Vdc	X7R	47μF	±10%	GRJ32ER70J476KE11#				
			±20%	GRJ32ER70J476ME11#				
2.85mm	25Vdc	X7S	22μF	±10%	GRJ32EC71E226KE11#			

Part number # indicates the package specification code.

GRJ Series High Dielectric Constant Type Part Number List

4.5×3.2mm

T max.	Rated Voltage	TC Code	Cap.	Tol.	Part Number
1.5mm	630Vdc	X7R	68000pF	±10%	GRJ43QR72J683KWJ1#
	250Vdc	X7R	0.15μF	±10%	GRJ43QR72E154KWJ1#
2.0mm	1000Vdc	X7R	33000pF	±10%	GRJ43DR73A333KWJ1#
			47000pF	±10%	GRJ43DR73A473KWJ1#
	630Vdc	X7R	0.10μF	±10%	GRJ43DR72J104KWJ1#
	250Vdc	X7R	0.22μF	±10%	GRJ43DR72E224KWJ1#
			0.33μF	±10%	GRJ43DR72E334KWJ1#
			0.47μF	±10%	GRJ43DR72E474KWJ1#

5.7×5.0mm

T max.	Rated Voltage	TC Code	Cap.	Tol.	Part Number
2.0mm	1000Vdc	X7R	68000pF	±10%	GRJ55DR73A683KWJ1#
			0.10μF	±10%	GRJ55DR73A104KWJ1#
	630Vdc	X7R	0.15μF	±10%	GRJ55DR72J154KWJ1#
			0.22μF	±10%	GRJ55DR72J224KWJ1#
	250Vdc	X7R	0.33μF	±10%	GRJ55DR72E334KWJ1#
			0.47μF	±10%	GRJ55DR72E474KWJ1#
			0.68μF	±10%	GRJ55DR72E684KWJ1#
			1.0μF	±10%	GRJ55DR72E105KWJ1#

- GRM
- GR3
- GRJ
- GR4
- GR7
- GJM
- GQM
- GA2
- GA3 GB
- GA3 GD
- GA3 GF
- LLL
- LLA
- LLM
- LLR
- NFM
- KRM
- KR3
- GMA
- GMD
- ⚠Caution /Notice

Part number # indicates the package specification code.

GRJ Series Specifications and Test Methods

Specifications and Test Methods, please refer to the search web page.
<https://www.murata.com/en-global/products/capacitor>

GRJ Series High Dielectric Constant Type

1.6×0.8mm

T max.	Rated Voltage	TC Code	Cap.	Tol.	Part Number
0.9mm	100Vdc	X7R	1000pF	±10%	GRJ188R72A102KE11#
				±20%	GRJ188R72A102ME11#
			2200pF	±10%	GRJ188R72A222KE11#
				±20%	GRJ188R72A222ME11#
			4700pF	±10%	GRJ188R72A472KE11#
				±20%	GRJ188R72A472ME11#
			10000pF	±10%	GRJ188R72A103KE11#
				±20%	GRJ188R72A103ME11#

Links are provided to the product detail pages on the web, and are shown below in the product number table from the PDF version of the catalog which is available on the web.



Detailed Specifications Sheet

- Rated value
- Specifications and Test Methods
- Package
- Caution, Notice

Specifications and Test Methods

No	Item	Specification	Test Method (Ref. Standard: JIS C 5101, IEC60384)												
1	Rated Voltage	Shown in Rated value.	The rated voltage is defined as the maximum voltage which may be applied continuously to the capacitor. When AC voltage is superimposed on DC voltage, $\sqrt{V^{2P}} + \sqrt{V^{2D}}$, whichever is larger, should be maintained within the rated voltage range.												
2	Appearance	No defects or abnormalities.	Visual inspection.												
3	Dimension	Within the specified dimensions.	Using Measuring instrument of dimension.												
4	Voltage proof	No defects or abnormalities.	Measurement Point : Between the terminations Test Voltage : 250% of the rated voltage Applied Time : 1 to 5 s Charge/discharge current : 50mA max.												
5	Insulation Resistance(I.R.)	More than 2000MΩ or 50Ω · F (Whichever is smaller)	Measurement Point : Between the terminations Measurement Voltage : DC Rated Voltage Charging Time : 1 min Charge/discharge current : 50mA max. Measurement Temperature: Room Temperature												
6	Capacitance	Shown in Rated value.	Measurement Temperature: Room Temperature												
7	Dissipation Factor (D.F.)	B1,R1,B3,R6,R7,C6,C7,C8,D7 : 0.1 max. D8 : 0.15 max	<table border="1"> <thead> <tr> <th>Capacitance</th> <th>Frequency</th> <th>Voltage</th> </tr> </thead> <tbody> <tr> <td>C ≤ 10μF (10V min.)</td> <td>1.0+/-0.1kHz</td> <td>1.0+/-0.2Vrms</td> </tr> <tr> <td>C ≤ 10μF (6.3V max.)</td> <td>1.0+/-0.1kHz</td> <td>0.5+/-0.1Vrms*</td> </tr> <tr> <td>C > 10μF</td> <td>120+/-24Hz</td> <td>0.5+/-0.1Vrms</td> </tr> </tbody> </table> <p>* For item GRJ188C70J475, the capacitance should be measured using a voltage of 1.0+/-0.2Vrms instead of 0.5+/-0.1Vrms.</p>	Capacitance	Frequency	Voltage	C ≤ 10μF (10V min.)	1.0+/-0.1kHz	1.0+/-0.2Vrms	C ≤ 10μF (6.3V max.)	1.0+/-0.1kHz	0.5+/-0.1Vrms*	C > 10μF	120+/-24Hz	0.5+/-0.1Vrms
Capacitance	Frequency	Voltage													
C ≤ 10μF (10V min.)	1.0+/-0.1kHz	1.0+/-0.2Vrms													
C ≤ 10μF (6.3V max.)	1.0+/-0.1kHz	0.5+/-0.1Vrms*													
C > 10μF	120+/-24Hz	0.5+/-0.1Vrms													
8	Temperature Characteristics of Capacitance	No bias B1,B3 : Within +/-10% (-25°C to +85°C) R1,R7 : Within +/-15% (-55°C to +125°C) R6 : Within +/-15% (-55°C to +85°C) C6 : Within +/-22% (-55°C to +85°C) C7 : Within +/-22% (-55°C to +125°C) C8 : Within +/-22% (-55°C to +105°C) D7 : Within +22/-33% (-55°C to +125°C) D8 : Within +22/-33% (-55°C to +105°C)	The capacitance change should be measured after 5 min. at each specified temp. stage. In case of applying voltage, the capacitance change should be measured after 1 min. with applying voltage in equilibration of each temp. stage. Capacitance value as a reference is the value in step 3. Measurement Voltage : 0.20+/-0.05Vrms												

Step	Temperature(°C)	Applying Voltage(VDC)
1	Reference Temp. +/-2	

GRM
 GR3
 GRJ
 GR4
 GR7
 GJM
 GQM
 GA2
 GA3 GB
 GA3 GD
 GA3 GF
 LLL
 LLA
 LLM
 LLR
 NFM
 KRM
 KR3
 GMA
 GMD
 ⚠Caution /Notice

Chip Multilayer Ceramic Capacitors for Ethernet LAN and Primary-secondary Coupling of DC-DC Converters

GR4 Series



Size (L*W) : 4.5x2.0mm - 5.7x5.0mm / X7R Char. / DC2kV
Realized large capacity and small size while maintaining high withstand voltages by the multilayer structure.

Features

- 1 For information devices of Ethernet LAN (IEEE802.3.) and primary - secondary couplings of DC-DC converters.

ex) DC-DC Converter

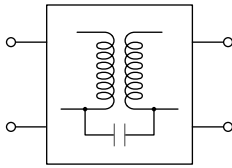

ex) LAN Connector

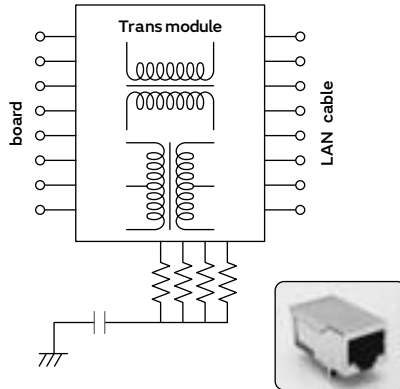

- 2 Realized large capacity and small size while maintaining high withstand voltages by the multilayer structure.

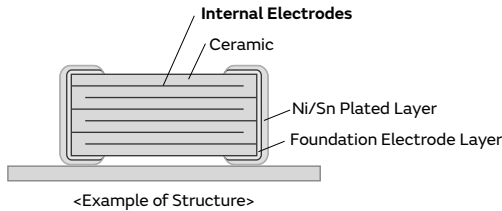

- 3 Dedicated for reflow soldering.

Specifications

Size (mm)	4.5×2.0mm to 5.7×5.0mm
Rated Voltage	2000Vdc
Capacitance	100pF to 10000pF
Main Applications	For Ethernet LAN, Primary-secondary coupling for DC-DC converters

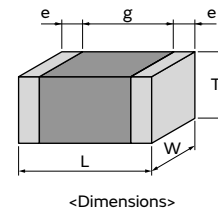

This catalog contains only a portion of the product lineup.
 Please refer to the capacitor search tool on the Murata Web site for details.

GR4 Series High Dielectric Constant Type Part Number List

4.5×2.0mm

T max.	Rated Voltage	TC Code	Cap.	Tol.	Part Number	p*
1.5mm	2000Vdc	X7R	100pF	±10%	GR442QR73D101KW01#	p127
			120pF	±10%	GR442QR73D121KW01#	p127
			150pF	±10%	GR442QR73D151KW01#	p127
			180pF	±10%	GR442QR73D181KW01#	p127
			220pF	±10%	GR442QR73D221KW01#	p127
			270pF	±10%	GR442QR73D271KW01#	p127
			330pF	±10%	GR442QR73D331KW01#	p127
			390pF	±10%	GR442QR73D391KW01#	p127
			470pF	±10%	GR442QR73D471KW01#	p127
			560pF	±10%	GR442QR73D561KW01#	p127
			680pF	±10%	GR442QR73D681KW01#	p127
			820pF	±10%	GR442QR73D821KW01#	p127
			1000pF	±10%	GR442QR73D102KW01#	p127
			1200pF	±10%	GR442QR73D122KW01#	p127
1500pF	±10%	GR442QR73D152KW01#	p127			

4.5×3.2mm

T max.	Rated Voltage	TC Code	Cap.	Tol.	Part Number	p*
1.5mm	2000Vdc	X7R	1800pF	±10%	GR443QR73D182KW01#	p127
			2200pF	±10%	GR443QR73D222KW01#	p127
			2700pF	±10%	GR443QR73D272KW01#	p127
			3300pF	±10%	GR443QR73D332KW01#	p127
			3900pF	±10%	GR443QR73D392KW01#	p127
2.0mm	2000Vdc	X7R	4700pF	±10%	GR443DR73D472KW01#	p127

5.7×5.0mm

T max.	Rated Voltage	TC Code	Cap.	Tol.	Part Number	p*
2.0mm	2000Vdc	X7R	10000pF	±10%	GR455DR73D103KW01#	p127

*: Refers to the page of the "Specifications and Test Methods".

Part number # indicates the package specification code.

GRM
 GR3
 GRJ
GR4
 GR7
 GJM
 GQM
 GA2
 GA3 GB
 GA3 GD
 GA3 GF
 LLL
 LLA
 LLM
 LLR
 NFM
 KRM
 KR3
 GMA
 GMD
 ⚠Caution /Notice

1

GR4 Series Specifications and Test Methods (1)

No	Item	Specification	Test Method (Ref. Standard: JIS C 5101, IEC60384)												
1	Appearance	No defects or abnormalities.	Visual inspection.												
2	Dimension	Within the specified dimensions.	Using calipers and micrometers.												
3	Voltage Proof	No defects or abnormalities.	Measurement Point: Between the terminations <table border="1"> <thead> <tr> <th>Test Voltage</th> <th>Time</th> </tr> </thead> <tbody> <tr> <td>DC2400V</td> <td>60s</td> </tr> <tr> <td>AC1.5kV (r.m.s)</td> <td>60s</td> </tr> </tbody> </table> Charge/discharge current: 50mA max.	Test Voltage	Time	DC2400V	60s	AC1.5kV (r.m.s)	60s						
Test Voltage	Time														
DC2400V	60s														
AC1.5kV (r.m.s)	60s														
4	Impulse Voltage	No self healing break downs or flash-overs have taken place in the capacitor.	10 impulse of alternating polarity is subjected. (5 impulse for each polarity) The interval between impulse is 60s. Applied Pulse: 1.2/50µs Applied Voltage: 2.5kVo-p												
5	Insulation Resistance (I.R.)	6000MΩ or more	Measurement Point: Between the terminations Measurement Voltage: DC500±50V Charging Time: 60±5s Measurement Temperature: Room Temperature												
6	Capacitance	Shown in Rated value.	Measurement Temperature: Room Temperature Measurement Frequency: 1.0±0.1kHz Measurement Voltage: AC1.0±0.2V (r.m.s.)												
7	Dissipation Factor (D.F.)	0.025 max.													
8	Temperature Characteristics of Capacitance	R7: Within ±15% (-55 to +125°C)	The capacitance change should be measured after 5 minutes at each specified temp. stage. Capacitance value as a reference is the value in step 3. <table border="1"> <thead> <tr> <th>Step</th> <th>Temperature (°C)</th> </tr> </thead> <tbody> <tr> <td>1</td> <td>Reference Temp. ±2</td> </tr> <tr> <td>2</td> <td>Min. Operating Temp. ±3</td> </tr> <tr> <td>3</td> <td>Reference Temp. ±2</td> </tr> <tr> <td>4</td> <td>Max. Operating Temp. ±3</td> </tr> <tr> <td>5</td> <td>Reference Temp. ±2</td> </tr> </tbody> </table> • Pretreatment Perform a heat treatment at 150+0/-10°C for 1h±5min and then let sit for 24±2h at room condition*.	Step	Temperature (°C)	1	Reference Temp. ±2	2	Min. Operating Temp. ±3	3	Reference Temp. ±2	4	Max. Operating Temp. ±3	5	Reference Temp. ±2
Step	Temperature (°C)														
1	Reference Temp. ±2														
2	Min. Operating Temp. ±3														
3	Reference Temp. ±2														
4	Max. Operating Temp. ±3														
5	Reference Temp. ±2														
9	Appearance	No defects or abnormalities.	Solder the capacitor on the test substrate A shown in "Complement of Test Method". Kind of Vibration: A simple harmonic motion 10Hz to 55Hz to 10Hz (1min) Total amplitude: 1.5mm This motion should be applied for a period of 2h in each 3 mutually perpendicular directions (total of 6h).												
	Capacitance	Within the specified initial value.													
	D.F.	Within the specified initial value.													
10	Solderability	95% of the terminations is to be soldered evenly and continuously.	Test Method: Solder bath method Flux: Solution of rosin ethanol 25 (wt) % Preheat: 80 to 120°C for 10 to 30s Solder: Sn-3.0Ag-0.5Cu (Lead Free Solder) Solder Temp.: 245±5°C Immersion time: 2±0.5s Immersing in speed: 25±2.5mm/s.												
11	Appearance	No defects or abnormalities.	Test Method: Solder bath method Solder: Sn-3.0Ag-0.5Cu (Lead Free Solder) Solder Temp.: 260±5°C Immersion time: 10±1s Immersing in speed: 25±2.5mm/s. Exposure Time: 24±2h. at room condition *. Preheat: GR442 size min.: 100 to 120°C for 1min and 170 to 200°C for 1min • Pretreatment Perform a heat treatment at 150+0/-10°C for 1h±5min and then let sit for 24±2h. at room condition *.												
	Capacitance Change	Within ±10%													
	D.F.	Within the specified initial value.													
	I.R.	1000MΩ or more													
	Voltage Proof	No defects.													

* Room Condition: Temperature: 15 to 35°C, Relative humidity: 45 to 75%, Atmosphere pressure: 86 to 106kPa

Continued on the following page. ↗

GRM
 GR3
 GRJ
 GR4
 GR7
 GJM
 GQM
 GA2
 GA3 GB
 GA3 GD
 GA3 GF
 LLL
 LLA
 LLM
 LLR
 NFM
 KPM
 KR3
 GMA
 GMD
 ⚠Caution / Notice

GR4 Series Specifications and Test Methods (1)

Continued from the preceding page. ↘

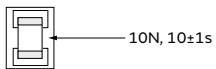
No	Item	Specification	Test Method (Ref. Standard: JIS C 5101, IEC60384)															
12	Adhesive Strength of Termination	No removal of the terminations or other defect should occur.	<p>Solder the capacitor on the test substrate A shown in "Complement of Test Method".</p>  <p>Applied Direction: In parallel with the test substrate and vertical with the capacitor side.</p>															
13	Substrate Bending Test	No defects or abnormalities.	<p>Solder the capacitor on the test substrate B shown in "Complement of Test Method". Then apply the force in the direction shown in "Test Method of Substrate Bending Test" of "Complement of Test Method". Flexure: 1mm Holding Time: 5±1s Soldering Method: Reflow soldering</p>															
14	Temperature Sudden Change	Appearance	No defects or abnormalities.															
		Capacitance Change	Within ±15%															
		D.F.	0.05 max.															
		I.R.	3000MΩ or more															
		Voltage Proof	No defects.															
			<p>Fix the capacitor to the supporting Test substrate A (glass epoxy board) shown in "Complement of Test Method". Perform the 5 cycles according to the four heat treatments shown in the following table.</p> <table border="1"> <thead> <tr> <th>Step</th> <th>Temp. (°C)</th> <th>Time (min)</th> </tr> </thead> <tbody> <tr> <td>1</td> <td>Min. Operating Temp. +0/-3</td> <td>30±3</td> </tr> <tr> <td>2</td> <td>Room Temp</td> <td>2 to 3</td> </tr> <tr> <td>3</td> <td>Max. Operating Temp. +3/-0</td> <td>30±3</td> </tr> <tr> <td>4</td> <td>Room Temp</td> <td>2 to 3</td> </tr> </tbody> </table> <p>Exposure Time: 24±2h at room condition*. • Pretreatment Perform a heat treatment at 150+0/-10°C for 1h±5min and then let sit for 24±2h. at room condition*.</p>	Step	Temp. (°C)	Time (min)	1	Min. Operating Temp. +0/-3	30±3	2	Room Temp	2 to 3	3	Max. Operating Temp. +3/-0	30±3	4	Room Temp	2 to 3
Step	Temp. (°C)	Time (min)																
1	Min. Operating Temp. +0/-3	30±3																
2	Room Temp	2 to 3																
3	Max. Operating Temp. +3/-0	30±3																
4	Room Temp	2 to 3																
15	Humidity (Steady State)	Appearance	No defects or abnormalities.															
		Capacitance Change	Within ±15%															
		D.F.	0.05 max.															
		I.R.	1000MΩ or more															
		Voltage Proof	No defects.															
			<p>Fix the capacitor to the supporting Test substrate A (glass epoxy board) shown in "Complement of Test Method". Test Temperature: 40±2°C Test Humidity: 90 to 95%RH Test Time: 500+24/-0h. Exposure Time: 24±2h. at room condition*. • Pretreatment Perform a heat treatment at 150+0/-10°C for 1h±5min and then let sit for 24±2h at room condition*.</p>															
16	Durability	Appearance	No defects or abnormalities.															
		Capacitance Change	Within ±20%															
		D.F.	0.05 max.															
		I.R.	2000MΩ or more															
		Voltage Proof	No defects.															
			<p>Fix the capacitor to the supporting Test substrate A (glass epoxy board) shown in "Complement of Test Method". Test Temperature: Max. Operating Temp. ±3°C Test Time: 1000+48/-0h Applied Voltage: DC2.2kV (110% of the rated voltage) Charge/discharge current: 50mA max. Exposure Time: 24±2h at room condition*. • Pretreatment Apply test voltage for 1h±5min at test temperature. Remove and let sit for 24±2h at room condition*.</p>															

* Room Condition: Temperature: 15 to 35°C, Relative humidity: 45 to 75%, Atmosphere pressure: 86 to 106kPa

Continued on the following page. ↗

GRM
 GR3
 GRJ
 GR4
 GR7
 GJM
 GQM
 GA2
 GA3 GB
 GA3 GD
 GA3 GF
 LLL
 LLA
 LLM
 LLR
 NFM
 KRM
 KR3
 GMA
 GMD
 ⚠Caution /Notice

GR4 Series Specifications and Test Methods (1)

Continued from the preceding page. ↘

Complement of Test Method

1. Test Substrate

The test substrate should be Substrate A or Substrate B as described in “Specifications and Test Methods”.
 The specimen should be soldered by the conditions as described below.

Soldering Method: Reflow soldering
 Solder: Sn-3.0Ag-0.5Cu

(1) Test Substrate A

• Land Dimensions



- Material: Glass Epoxy Board
- Thickness: 1.6mm
- Thickness of Copper Foil: 0.035mm

Part Number	Dimension (mm)		
	a	b	c
GR442	3.5	7.0	2.4
GR443	3.5	7.0	3.7
GR455	4.5	8.0	5.6

(2) Test Substrate B

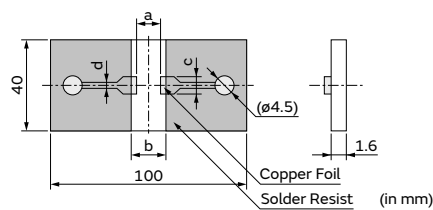

- Material: Glass Epoxy Board
- Thickness of Copper Foil: 0.035mm

Part Number	Dimension (mm)			
	a	b	c	d
GR442	3.5	7.0	2.4	1.0
GR443	3.5	7.0	3.7	1.0
GR455	4.5	8.0	5.6	1.0

2. Test Method of Substrate Bending Test

(a) Support State

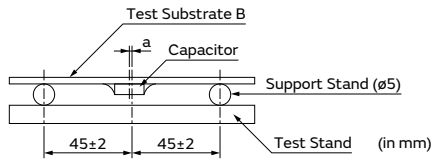

a: ±2 gap between support stand center and test stand

- Material of Test Stand and Pressure Stick
 The material should be a metal where a remarkable transformation and the distortion are not caused even if it is pressurized.
- Pressurizing Speed
 The pressurizing speed is pressurized at the speed of about 1mm/s until the flexure reaches a regulated value.

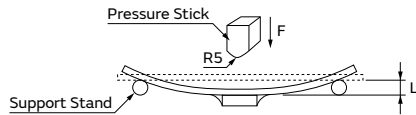

(b) Test State

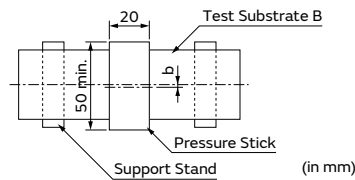

b: ±5 gap between support stand center and test stand center

GRM
 GR3
 GRJ
GR4
 GR7
 GJM
 GQM
 GA2
 GA3 GB
 GA3 GD
 GA3 GF
 LLL
 LLA
 LLM
 LLR
 NFM
 KPM
 KR3
 GMA
 GMD
 ⚠Caution / Notice

Chip Multilayer Ceramic Capacitors for Camera Flash circuit only

GR7 Series



Limited to camera flashes. Ideal for trigger capacitors and voltage doubler capacitors!

Features

- 1 Ideal for the trigger of flash circuits, as a higher capacitance can be acquired compared to conventional products (X7R characteristics) when a DC bias is applied.

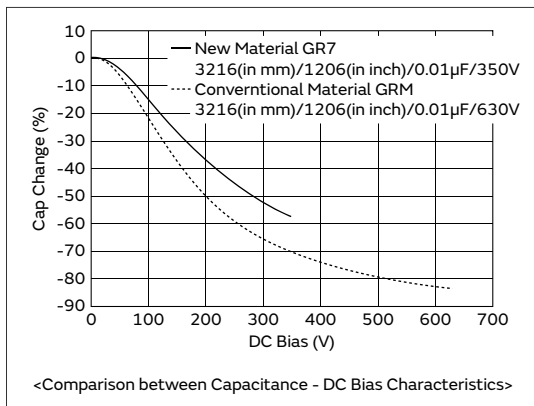

◆Standard current control circuit

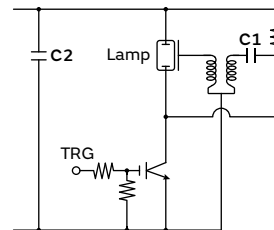

◆Boost current control circuit

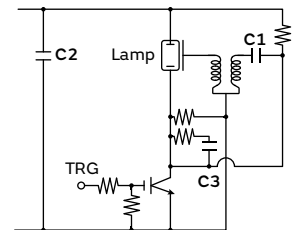

C1: Trigger capacitor
 C3: Voltage doubler capacitor

- 2 Contributes to the miniaturization of cameras with the low profile.

Specifications

Size (mm)	2.0×1.25mm to 3.2×1.6mm
Rated Voltage	350Vdc
Capacitance	10000pF to 47000pF
Main Applications	For camera flash

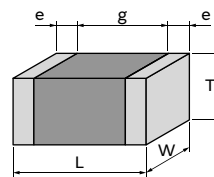

<Dimensions>

This catalog contains only a portion of the product lineup.
 Please refer to the capacitor search tool on the Murata Web site for details.

GRM
 GR3
 GRJ
 GR4
 GR7
 GJM
 GQM
 GA2
 GA3 GB
 GA3 GD
 GA3 GF
 LLL
 LLA
 LLM
 LLR
 NFM
 KRM
 KR3
 GMA
 GMD
 ⚠Caution /Notice

GR7 Series High Dielectric Constant Type Part Number List

2.0×1.25mm

T max.	Rated Voltage	TC Code	Cap.	Tol.	Part Number	p*
1.0mm	350Vdc	X7T	10000pF	±10%	GR721AWOBB103KW01#	p132
			15000pF	±10%	GR721AWOBB153KW01#	p132
1.45mm	350Vdc	X7T	22000pF	±10%	GR721BWOBB223KW03#	p132
			27000pF	±10%	GR721BWOBB273KW03#	p132

3.2×1.6mm

T max.	Rated Voltage	TC Code	Cap.	Tol.	Part Number	p*
1.0mm	350Vdc	X7T	10000pF	±10%	GR731AWOBB103KW01#	p132
			15000pF	±10%	GR731AWOBB153KW01#	p132
			22000pF	±10%	GR731AWOBB223KW01#	p132
			27000pF	±10%	GR731AWOBB273KW01#	p132
			33000pF	±10%	GR731AWOBB333KW01#	p132
1.25mm	350Vdc	X7T	22000pF	±10%	GR731BWOBB223KW01#	p132
			33000pF	±10%	GR731BWOBB333KW01#	p132
1.8mm	350Vdc	X7T	47000pF	±10%	GR731CWOBB473KW03#	p132

*: Refers to the page of the "Specifications and Test Methods".

Part number # indicates the package specification code.

1

GR7 Series Specifications and Test Methods (1)

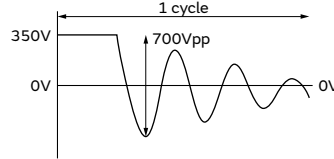
No	Item	Specification	Test Method (Ref. Standard: JIS C 5101, IEC60384)												
1	Appearance	No defects or abnormalities.	Visual inspection.												
2	Dimension	Within the specified dimensions.	Using calipers and micrometers.												
3	Voltage Proof	No defects or abnormalities.	Measurement Point: Between the terminations Test Voltage: DC500V Applied Time: 1 to 5s Charge/discharge current: 50mA max.												
4	Charge and Discharge Cycle	Appearance	Test temperature: 25°C Discharge voltage: below figure Discharge cycle: 100k cycle Discharge frequency: 100Hz Exposure Time: 24±2h at room condition*. 												
		Capacitance Change													
		D.F.													
		I.R.													
	Voltage Proof	No defects.													
5	Insulation Resistance (I.R.)	C ≥ 0.01μF: 100MΩ • μF or more C < 0.01μF: 10000MΩ or more	Measurement Point: Between the terminations Measurement Voltage: DC250±25V Charging Time: 60±5s Measurement Temperature: Room Temperature												
6	Capacitance	Shown in Rated value.	Measurement Temperature: Room Temperature Measurement Frequency: 1.0±0.1kHz Measurement Voltage: AC1.0±0.2V (r.m.s.)												
7	Dissipation Factor (D.F.)	0.025 max.													
8	Temperature Characteristics of Capacitance	No Bias	The capacitance change should be measured after 5 minutes at each specified temp. stage. Capacitance value as a reference is the value in step 3. <table border="1" data-bbox="925 1142 1244 1288"> <thead> <tr> <th>Step</th> <th>Temperature (°C)</th> </tr> </thead> <tbody> <tr> <td>1</td> <td>Reference Temp. ±2</td> </tr> <tr> <td>2</td> <td>Min. Operating Temp. ±3</td> </tr> <tr> <td>3</td> <td>Reference Temp. ±2</td> </tr> <tr> <td>4</td> <td>Max. Operating Temp. ±3</td> </tr> <tr> <td>5</td> <td>Reference Temp. ±2</td> </tr> </tbody> </table>	Step	Temperature (°C)	1	Reference Temp. ±2	2	Min. Operating Temp. ±3	3	Reference Temp. ±2	4	Max. Operating Temp. ±3	5	Reference Temp. ±2
		Step		Temperature (°C)											
1	Reference Temp. ±2														
2	Min. Operating Temp. ±3														
3	Reference Temp. ±2														
4	Max. Operating Temp. ±3														
5	Reference Temp. ±2														
Apply DC350V Bias	W0: Within ±10% (-55 to +125°C)														
9	Vibration	Appearance	Solder the capacitor on the test substrate A shown in "Complement of Test Method". Kind of Vibration: A simple harmonic motion 10Hz to 55Hz to 10Hz (1min) Total amplitude: 1.5mm This motion should be applied for a period of 2h in each 3 mutually perpendicular directions (total of 6h).												
		Capacitance													
		D.F.													
10	Solderability	95% of the terminations is to be soldered evenly and continuously.	Test Method: Solder bath method Flux: Solution of rosin ethanol 25 (wt)% Preheat: 80 to 120°C for 10 to 30s Solder: Sn-3.0Ag-0.5Cu (Lead Free Solder) Solder Temp.: 245±5°C Immersion time: 2±0.5s Immersing in speed: 25±2.5mm/s.												
11	Resistance to Soldering Heat	Appearance	Test Method: Solder bath method Solder: Sn-3.0Ag-0.5Cu (Lead Free Solder) Solder Temp.: 260±5°C Immersion time: 10±1s Immersing in speed: 25±2.5mm/s. Exposure Time: 24±2h at room condition*. Preheat: GR731 size max.: 120 to 150°C for 1min • Pretreatment Perform a heat treatment at 150+0/-10°C for 1h±5min and then let sit for 24±2h at room condition*.												
		Capacitance Change													
		D.F.													
		I.R.													
		Voltage Proof													

* Room Condition: Temperature: 15 to 35°C, Relative humidity: 45 to 75%, Atmosphere pressure: 86 to 106kPa

Continued on the following page. ↗

GRM
 GR3
 GRJ
 GR4
 GR7
 GJM
 GQM
 GA2
 GA3 GB
 GA3 GD
 GA3 GF
 LLL
 LLA
 LLM
 LLR
 NFM
 KRM
 KR3
 GMA
 GMD
 ⚠Caution / Notice

GR7 Series Specifications and Test Methods (1)

Continued from the preceding page. ↘

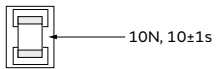
No	Item	Specification	Test Method (Ref. Standard: JIS C 5101, IEC60384)															
12	Adhesive Strength of Termination	No removal of the terminations or other defect should occur.	<p>Solder the capacitor on the test substrate A shown in "Complement of Test Method".</p>  <p>Applied Direction: In parallel with the test substrate and vertical with the capacitor side.</p>															
13	Substrate Bending Test	No defects or abnormalities.	<p>Solder the capacitor on the test substrate B shown in "Complement of Test Method". Then apply the force in the direction shown in "Test Method of Substrate Bending Test" of "Complement of Test Method". Flexure: 1mm Holding Time: 5±1s Soldering Method: Reflow soldering</p>															
14	Temperature Sudden Change	Appearance	<p>Fix the capacitor to the supporting Test substrate A (glass epoxy board) shown in "Complement of Test Method". Perform the 5 cycles according to the four heat treatments shown in the following table.</p> <table border="1" data-bbox="933 750 1380 873"> <thead> <tr> <th>Step</th> <th>Temp. (°C)</th> <th>Time (min)</th> </tr> </thead> <tbody> <tr> <td>1</td> <td>Min. Operating Temp. +0/-3</td> <td>30±3</td> </tr> <tr> <td>2</td> <td>Room Temp.</td> <td>2 to 3</td> </tr> <tr> <td>3</td> <td>Max. Operating Temp. +3/-0</td> <td>30±3</td> </tr> <tr> <td>4</td> <td>Room Temp.</td> <td>2 to 3</td> </tr> </tbody> </table> <p>Exposure Time: 24±2h at room condition*. • Pretreatment Perform a heat treatment at 150+0/-10°C for 1h±5min and then let sit for 24±2h at room condition*.</p>	Step	Temp. (°C)	Time (min)	1	Min. Operating Temp. +0/-3	30±3	2	Room Temp.	2 to 3	3	Max. Operating Temp. +3/-0	30±3	4	Room Temp.	2 to 3
		Step		Temp. (°C)	Time (min)													
		1		Min. Operating Temp. +0/-3	30±3													
		2		Room Temp.	2 to 3													
		3		Max. Operating Temp. +3/-0	30±3													
4	Room Temp.	2 to 3																
Capacitance Change	Within ±7.5%																	
D.F.	Within the specified initial value.																	
I.R.	Within the specified initial value.																	
Voltage Proof	No defects.																	
15	High Temperature High Humidity (Steady)	Appearance	<p>Fix the capacitor to the supporting Test substrate A (glass epoxy board) shown in "Complement of Test Method". Test Temperature: 40±2°C Test Humidity: 90 to 95%RH Test Time: 500+24/-0h Applied Voltage: DC Rated Voltage Exposure Time: 24±2h at room condition*. • Pretreatment Apply test voltage for 1h±5min at test temperature. Remove and let sit for 24±2h at room condition*.</p>															
		Capacitance Change		Within ±15%														
		D.F.		0.05 max.														
		I.R.		C ≥ 0.01μF: 10MΩ • μF or more C < 0.01μF: 1000MΩ or more														
		Voltage Proof		No defects.														
16	Durability	Appearance	<p>Fix the capacitor to the supporting Test substrate A (glass epoxy board) shown in "Complement of Test Method". Test Temperature: Max. Operating Temp. ±3°C Test Time: 1000+48/-0h Applied Voltage: DC350V Charge/discharge current: 50mA max. Exposure Time: 24±2h at room condition*. • Pretreatment Apply test voltage for 1h±5min at test temperature. Remove and let sit for 24±2h at room condition*.</p>															
		Capacitance Change		Within ±15%														
		D.F.		0.05 max.														
		I.R.		C ≥ 0.01μF: 10MΩ • μF or more C < 0.01μF: 1000MΩ or more														
		Voltage Proof		No defects.														

* Room Condition: Temperature: 15 to 35°C, Relative humidity: 45 to 75%, Atmosphere pressure: 86 to 106kPa

Continued on the following page. ↗

GR7 Series Specifications and Test Methods (1)

Continued from the preceding page. ↘

Complement of Test Method

1. Test Substrate

The test substrate should be Substrate A or Substrate B as described in "Specifications and Test Methods".
 The specimen should be soldered by the conditions as described below.

Soldering Method: Reflow soldering
 Solder: Sn-3.0Ag-0.5Cu

(1) Test Substrate A

• Land Dimensions

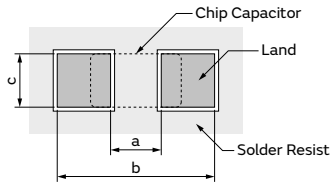

- Material: Glass Epoxy Board
- Thickness: 1.6mm
- Thickness of Copper Foil: 0.035mm

Part Number	Dimension (mm)		
	a	b	c
GR721	1.2	4.0	1.65
GR731	2.2	5.0	2.0

(2) Test Substrate B

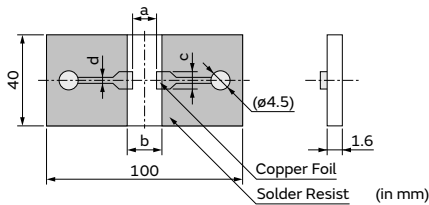

- Material: Glass Epoxy Board
- Thickness of Copper Foil: 0.035mm

Part Number	Dimension (mm)			
	a	b	c	d
GR721	1.2	4.0	1.65	1.0
GR731	2.2	5.0	2.0	1.0

2. Test Method of Substrate Bending Test

(a) Support State

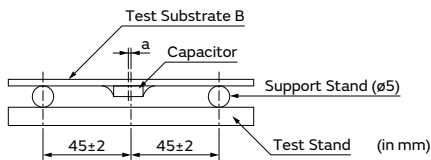

a: ±2 gap between support stand center and test stand

- Material of Test Stand and Pressure Stick
 The material should be a metal where a remarkable transformation and the distortion are not caused even if it is pressurized.
- Pressurizing Speed
 The pressurizing speed is pressurized at the speed of about 1mm/s until the flexure reaches a regulated value.

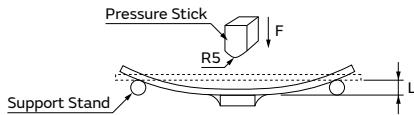

(b) Test State

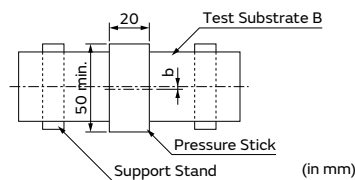

b: ±5 gap between support stand center and test stand center

GRM
 GR3
 GRJ
 GR4
 GR7
 GJM
 GQM
 GA2
 GA3 GB
 GA3 GD
 GA3 GF
 LLL
 LLA
 LLM
 LLR
 NFM
 KRM
 KR3
 GMA
 GMD
 Caution / Notice

High Q Chip Multilayer Ceramic Capacitors for General Purpose

GJM Series  **High Q** 

This product improves the high frequency characteristics and contributes to a reduction of power consumption by the High Q and low ESR.

Features

① **Mainly ideal for mobile communication devices and temperature compensation of related modules.**

This product is ideal for temperature compensation of high frequency circuits, such as resonant circuits, tuning circuits, and impedance matching circuits where the operating characteristics of the device are greatly affected by the capacitance fluctuation.

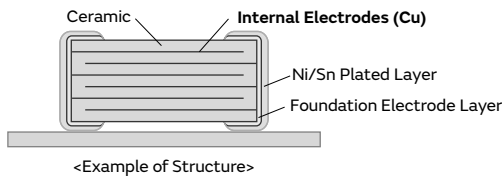

② **High Q and low ESR in VHF, UHF and microwave frequency bands.**

High Q and low ESR were achieved at a high frequency by adopting ceramic material as the dielectric material which enables an extremely low loss at high frequency, and base metal electrodes as the internal electrodes.

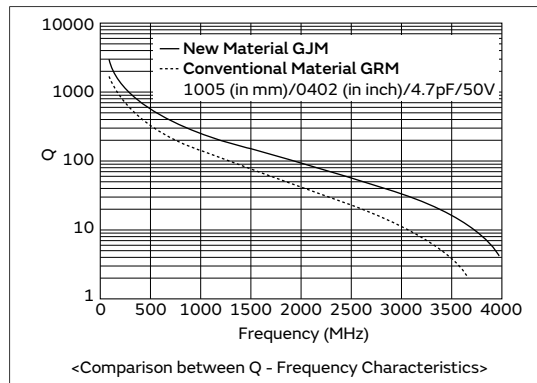
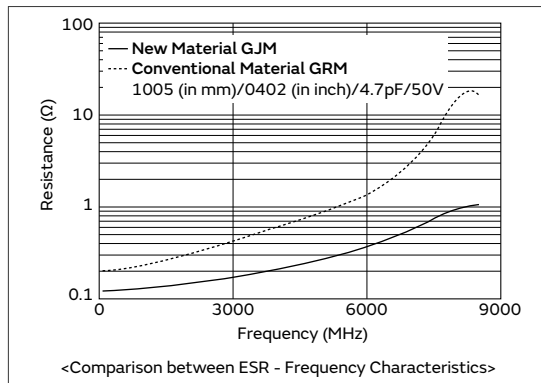

③ **Can be used for tight tolerance.**

In addition to standard tolerance, the allowable range of this product is also suitable for the following tight tolerance.

Capacitance Range	Standard Capacitance Tolerance (Capacitance Tolerance Symbol)	Narrow Capacitance Tolerance (Capacitance Tolerance Symbol)
to 0.9pF	±0.1pF (B)	±0.05pF (W)
1.0 to 5.0pF	±0.25pF (C)	±0.05pF (W), ±0.1pF (B)
5.1 to 9.9pF	±0.5pF (D)	±0.05pF (W), ±0.1pF (B), ±0.25pF (C)
10pF to	±5% (J)	±2% (G)

Specifications

Size (mm)	0.4×0.2mm to 1.0×0.5mm
Rated Voltage	6.3Vdc to 50Vdc
Capacitance	0.10pF to 47pF
Main Applications	Small communication devices, such as mobile phones and high frequency communication modules

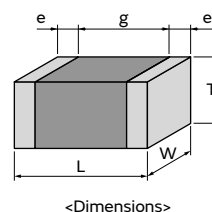

This catalog contains only a portion of the product lineup. Please refer to the capacitor search tool on the Murata Web site for details.

GJM Series Temperature Compensating Type Part Number List

0.4×0.2mm

T max.	Rated Voltage	TC Code	Cap.	Tol.	Part Number	p*
0.22mm	25Vdc	COG	0.20pF	±0.05pF	GJM0225C1ER20WB01#	p157
				±0.1pF	GJM0225C1ER20BB01#	p157
			0.30pF	±0.05pF	GJM0225C1ER30WB01#	p157
				±0.1pF	GJM0225C1ER30BB01#	p157
			0.40pF	±0.05pF	GJM0225C1ER40WB01#	p157
				±0.1pF	GJM0225C1ER40BB01#	p157
			0.50pF	±0.05pF	GJM0225C1ER50WB01#	p157
				±0.1pF	GJM0225C1ER50BB01#	p157
			0.60pF	±0.05pF	GJM0225C1ER60WB01#	p157
				±0.1pF	GJM0225C1ER60BB01#	p157
			0.70pF	±0.05pF	GJM0225C1ER70WB01#	p157
				±0.1pF	GJM0225C1ER70BB01#	p157
			0.80pF	±0.05pF	GJM0225C1ER80WB01#	p157
				±0.1pF	GJM0225C1ER80BB01#	p157
			0.90pF	±0.05pF	GJM0225C1ER90WB01#	p157
				±0.1pF	GJM0225C1ER90BB01#	p157
			1.0pF	±0.05pF	GJM0225C1E1R0WB01#	p157
				±0.1pF	GJM0225C1E1R0BB01#	p157
				±0.25pF	GJM0225C1E1R0CB01#	p157
			1.1pF	±0.05pF	GJM0225C1E1R1WB01#	p157
				±0.1pF	GJM0225C1E1R1BB01#	p157
				±0.25pF	GJM0225C1E1R1CB01#	p157
			1.2pF	±0.05pF	GJM0225C1E1R2WB01#	p157
				±0.1pF	GJM0225C1E1R2BB01#	p157
				±0.25pF	GJM0225C1E1R2CB01#	p157
			1.3pF	±0.05pF	GJM0225C1E1R3WB01#	p157
				±0.1pF	GJM0225C1E1R3BB01#	p157
				±0.25pF	GJM0225C1E1R3CB01#	p157
			1.4pF	±0.05pF	GJM0225C1E1R4WB01#	p157
				±0.1pF	GJM0225C1E1R4BB01#	p157
				±0.25pF	GJM0225C1E1R4CB01#	p157
			1.5pF	±0.05pF	GJM0225C1E1R5WB01#	p157
				±0.1pF	GJM0225C1E1R5BB01#	p157
				±0.25pF	GJM0225C1E1R5CB01#	p157
			1.6pF	±0.05pF	GJM0225C1E1R6WB01#	p157
				±0.1pF	GJM0225C1E1R6BB01#	p157
				±0.25pF	GJM0225C1E1R6CB01#	p157
			1.7pF	±0.05pF	GJM0225C1E1R7WB01#	p157
				±0.1pF	GJM0225C1E1R7BB01#	p157
				±0.25pF	GJM0225C1E1R7CB01#	p157
			1.8pF	±0.05pF	GJM0225C1E1R8WB01#	p157
				±0.1pF	GJM0225C1E1R8BB01#	p157
				±0.25pF	GJM0225C1E1R8CB01#	p157
			1.9pF	±0.05pF	GJM0225C1E1R9WB01#	p157
				±0.1pF	GJM0225C1E1R9BB01#	p157
				±0.25pF	GJM0225C1E1R9CB01#	p157
			2.0pF	±0.05pF	GJM0225C1E2R0WB01#	p157
				±0.1pF	GJM0225C1E2R0BB01#	p157
				±0.25pF	GJM0225C1E2R0CB01#	p157
			2.1pF	±0.05pF	GJM0225C1E2R1WB01#	p157
				±0.1pF	GJM0225C1E2R1BB01#	p157
				±0.25pF	GJM0225C1E2R1CB01#	p157

T max.	Rated Voltage	TC Code	Cap.	Tol.	Part Number	p*
0.22mm	25Vdc	COG	2.2pF	±0.05pF	GJM0225C1E2R2WB01#	p157
				±0.1pF	GJM0225C1E2R2BB01#	p157
				±0.25pF	GJM0225C1E2R2CB01#	p157
			2.3pF	±0.05pF	GJM0225C1E2R3WB01#	p157
				±0.1pF	GJM0225C1E2R3BB01#	p157
				±0.25pF	GJM0225C1E2R3CB01#	p157
			2.4pF	±0.05pF	GJM0225C1E2R4WB01#	p157
				±0.1pF	GJM0225C1E2R4BB01#	p157
				±0.25pF	GJM0225C1E2R4CB01#	p157
			2.5pF	±0.05pF	GJM0225C1E2R5WB01#	p157
				±0.1pF	GJM0225C1E2R5BB01#	p157
				±0.25pF	GJM0225C1E2R5CB01#	p157
			2.6pF	±0.05pF	GJM0225C1E2R6WB01#	p157
				±0.1pF	GJM0225C1E2R6BB01#	p157
				±0.25pF	GJM0225C1E2R6CB01#	p157
			2.7pF	±0.05pF	GJM0225C1E2R7WB01#	p157
				±0.1pF	GJM0225C1E2R7BB01#	p157
				±0.25pF	GJM0225C1E2R7CB01#	p157
			2.8pF	±0.05pF	GJM0225C1E2R8WB01#	p157
				±0.1pF	GJM0225C1E2R8BB01#	p157
				±0.25pF	GJM0225C1E2R8CB01#	p157
			2.9pF	±0.05pF	GJM0225C1E2R9WB01#	p157
				±0.1pF	GJM0225C1E2R9BB01#	p157
				±0.25pF	GJM0225C1E2R9CB01#	p157
			3.0pF	±0.05pF	GJM0225C1E3R0WB01#	p157
				±0.1pF	GJM0225C1E3R0BB01#	p157
				±0.25pF	GJM0225C1E3R0CB01#	p157
			3.1pF	±0.05pF	GJM0225C1E3R1WB01#	p157
				±0.1pF	GJM0225C1E3R1BB01#	p157
				±0.25pF	GJM0225C1E3R1CB01#	p157
			3.2pF	±0.05pF	GJM0225C1E3R2WB01#	p157
				±0.1pF	GJM0225C1E3R2BB01#	p157
				±0.25pF	GJM0225C1E3R2CB01#	p157
			3.3pF	±0.05pF	GJM0225C1E3R3WB01#	p157
				±0.1pF	GJM0225C1E3R3BB01#	p157
				±0.25pF	GJM0225C1E3R3CB01#	p157
			3.4pF	±0.05pF	GJM0225C1E3R4WB01#	p157
				±0.1pF	GJM0225C1E3R4BB01#	p157
				±0.25pF	GJM0225C1E3R4CB01#	p157
			3.5pF	±0.05pF	GJM0225C1E3R5WB01#	p157
				±0.1pF	GJM0225C1E3R5BB01#	p157
				±0.25pF	GJM0225C1E3R5CB01#	p157
			3.6pF	±0.05pF	GJM0225C1E3R6WB01#	p157
				±0.1pF	GJM0225C1E3R6BB01#	p157
				±0.25pF	GJM0225C1E3R6CB01#	p157
			3.7pF	±0.05pF	GJM0225C1E3R7WB01#	p157
				±0.1pF	GJM0225C1E3R7BB01#	p157
				±0.25pF	GJM0225C1E3R7CB01#	p157
			3.8pF	±0.05pF	GJM0225C1E3R8WB01#	p157
				±0.1pF	GJM0225C1E3R8BB01#	p157
				±0.25pF	GJM0225C1E3R8CB01#	p157
			3.9pF	±0.05pF	GJM0225C1E3R9WB01#	p157
				±0.1pF	GJM0225C1E3R9BB01#	p157
				±0.25pF	GJM0225C1E3R9CB01#	p157

*: Refers to the page of the "Specifications and Test Methods".

Part number # indicates the package specification code.



GJM Series Temperature Compensating Type Part Number List

(→ 0.4×0.2mm)

T max.	Rated Voltage	TC Code	Cap.	Tol.	Part Number	p*
0.22mm	25Vdc	COG	4.0pF	±0.05pF	GJM0225C1E4ROWB01#	p157
				±0.1pF	GJM0225C1E4ROBB01#	p157
				±0.25pF	GJM0225C1E4ROCB01#	p157
			4.1pF	±0.05pF	GJM0225C1E4R1WB01#	p157
				±0.1pF	GJM0225C1E4R1BB01#	p157
				±0.25pF	GJM0225C1E4R1CB01#	p157
			4.2pF	±0.05pF	GJM0225C1E4R2WB01#	p157
				±0.1pF	GJM0225C1E4R2BB01#	p157
				±0.25pF	GJM0225C1E4R2CB01#	p157
			4.3pF	±0.05pF	GJM0225C1E4R3WB01#	p157
				±0.1pF	GJM0225C1E4R3BB01#	p157
				±0.25pF	GJM0225C1E4R3CB01#	p157
			4.4pF	±0.05pF	GJM0225C1E4R4WB01#	p157
				±0.1pF	GJM0225C1E4R4BB01#	p157
				±0.25pF	GJM0225C1E4R4CB01#	p157
			4.5pF	±0.05pF	GJM0225C1E4R5WB01#	p157
				±0.1pF	GJM0225C1E4R5BB01#	p157
				±0.25pF	GJM0225C1E4R5CB01#	p157
			4.6pF	±0.05pF	GJM0225C1E4R6WB01#	p157
				±0.1pF	GJM0225C1E4R6BB01#	p157
				±0.25pF	GJM0225C1E4R6CB01#	p157
			4.7pF	±0.05pF	GJM0225C1E4R7WB01#	p157
				±0.1pF	GJM0225C1E4R7BB01#	p157
				±0.25pF	GJM0225C1E4R7CB01#	p157
			4.8pF	±0.05pF	GJM0225C1E4R8WB01#	p157
				±0.1pF	GJM0225C1E4R8BB01#	p157
				±0.25pF	GJM0225C1E4R8CB01#	p157
			4.9pF	±0.05pF	GJM0225C1E4R9WB01#	p157
				±0.1pF	GJM0225C1E4R9BB01#	p157
				±0.25pF	GJM0225C1E4R9CB01#	p157
			5.0pF	±0.05pF	GJM0225C1E5R0WB01#	p157
				±0.1pF	GJM0225C1E5R0BB01#	p157
				±0.25pF	GJM0225C1E5R0CB01#	p157
			5.1pF	±0.05pF	GJM0225C1E5R1WB01#	p157
				±0.1pF	GJM0225C1E5R1BB01#	p157
				±0.25pF	GJM0225C1E5R1CB01#	p157
			5.2pF	±0.05pF	GJM0225C1E5R2WB01#	p157
				±0.1pF	GJM0225C1E5R2BB01#	p157
				±0.25pF	GJM0225C1E5R2CB01#	p157
			5.3pF	±0.05pF	GJM0225C1E5R3WB01#	p157
				±0.1pF	GJM0225C1E5R3BB01#	p157
				±0.25pF	GJM0225C1E5R3CB01#	p157
			5.4pF	±0.05pF	GJM0225C1E5R4WB01#	p157
				±0.1pF	GJM0225C1E5R4BB01#	p157
				±0.25pF	GJM0225C1E5R4CB01#	p157
			5.5pF	±0.05pF	GJM0225C1E5R5WB01#	p157
				±0.1pF	GJM0225C1E5R5BB01#	p157
				±0.25pF	GJM0225C1E5R5CB01#	p157
			5.6pF	±0.05pF	GJM0225C1E5R6WB01#	p157
				±0.5pF	GJM0225C1E5R6DB01#	p157

T max.	Rated Voltage	TC Code	Cap.	Tol.	Part Number	p*
0.22mm	25Vdc	COG	5.6pF	±0.1pF	GJM0225C1E5R6BB01#	p157
				±0.25pF	GJM0225C1E5R6CB01#	p157
				±0.5pF	GJM0225C1E5R6DB01#	p157
			5.7pF	±0.05pF	GJM0225C1E5R7WB01#	p157
				±0.1pF	GJM0225C1E5R7BB01#	p157
				±0.25pF	GJM0225C1E5R7CB01#	p157
			5.8pF	±0.05pF	GJM0225C1E5R8WB01#	p157
				±0.1pF	GJM0225C1E5R8BB01#	p157
				±0.25pF	GJM0225C1E5R8CB01#	p157
			5.9pF	±0.05pF	GJM0225C1E5R9WB01#	p157
				±0.1pF	GJM0225C1E5R9BB01#	p157
				±0.25pF	GJM0225C1E5R9CB01#	p157
			6.0pF	±0.05pF	GJM0225C1E6R0WB01#	p157
				±0.1pF	GJM0225C1E6R0BB01#	p157
				±0.25pF	GJM0225C1E6R0CB01#	p157
			6.1pF	±0.05pF	GJM0225C1E6R1WB01#	p157
				±0.1pF	GJM0225C1E6R1BB01#	p157
				±0.25pF	GJM0225C1E6R1CB01#	p157
			6.2pF	±0.05pF	GJM0225C1E6R2WB01#	p157
				±0.1pF	GJM0225C1E6R2BB01#	p157
				±0.25pF	GJM0225C1E6R2CB01#	p157
			6.3pF	±0.05pF	GJM0225C1E6R3WB01#	p157
				±0.1pF	GJM0225C1E6R3BB01#	p157
				±0.25pF	GJM0225C1E6R3CB01#	p157
			6.4pF	±0.05pF	GJM0225C1E6R4WB01#	p157
				±0.1pF	GJM0225C1E6R4BB01#	p157
				±0.25pF	GJM0225C1E6R4CB01#	p157
			6.5pF	±0.05pF	GJM0225C1E6R5WB01#	p157
				±0.1pF	GJM0225C1E6R5BB01#	p157
				±0.25pF	GJM0225C1E6R5CB01#	p157
			6.6pF	±0.05pF	GJM0225C1E6R6WB01#	p157
				±0.1pF	GJM0225C1E6R6BB01#	p157
				±0.25pF	GJM0225C1E6R6CB01#	p157
			6.7pF	±0.05pF	GJM0225C1E6R7WB01#	p157
				±0.1pF	GJM0225C1E6R7BB01#	p157
				±0.25pF	GJM0225C1E6R7CB01#	p157
			6.8pF	±0.05pF	GJM0225C1E6R8WB01#	p157
				±0.1pF	GJM0225C1E6R8BB01#	p157
				±0.25pF	GJM0225C1E6R8CB01#	p157
			6.9pF	±0.05pF	GJM0225C1E6R9WB01#	p157
				±0.1pF	GJM0225C1E6R9BB01#	p157
				±0.25pF	GJM0225C1E6R9CB01#	p157

*: Refers to the page of the "Specifications and Test Methods".

Part number # indicates the package specification code.

GJM Series Temperature Compensating Type Part Number List

(→ 0.4×0.2mm)

T max.	Rated Voltage	TC Code	Cap.	Tol.	Part Number	p*	T max.	Rated Voltage	TC Code	Cap.	Tol.	Part Number	p*	
0.22mm	25Vdc	COG	6.9pF	±0.5pF	GJM0225C1E6R9DB01#	p157	0.22mm	25Vdc	COG	8.3pF	±0.1pF	GJM0225C1E8R3BB01#	p157	
				±0.05pF	GJM0225C1E7R0WB01#	p157					±0.25pF	GJM0225C1E8R3CB01#	p157	
				±0.1pF	GJM0225C1E7R0BB01#	p157					±0.5pF	GJM0225C1E8R3DB01#	p157	
			7.0pF	±0.25pF	GJM0225C1E7R0CB01#	p157				8.4pF	±0.05pF	GJM0225C1E8R4WB01#	p157	
				±0.5pF	GJM0225C1E7R0DB01#	p157					±0.1pF	GJM0225C1E8R4BB01#	p157	
				7.1pF	±0.05pF	GJM0225C1E7R1WB01#					p157	±0.25pF	GJM0225C1E8R4CB01#	p157
					±0.1pF	GJM0225C1E7R1BB01#					p157	±0.5pF	GJM0225C1E8R4DB01#	p157
					±0.25pF	GJM0225C1E7R1CB01#					p157	8.5pF	±0.05pF	GJM0225C1E8R5WB01#
			±0.5pF	GJM0225C1E7R1DB01#	p157	±0.1pF				GJM0225C1E8R5BB01#	p157			
			7.2pF	±0.05pF	GJM0225C1E7R2WB01#	p157				±0.25pF	GJM0225C1E8R5CB01#		p157	
				±0.1pF	GJM0225C1E7R2BB01#	p157				±0.5pF	GJM0225C1E8R5DB01#	p157		
				±0.25pF	GJM0225C1E7R2CB01#	p157				8.6pF	±0.05pF	GJM0225C1E8R6WB01#	p157	
				±0.5pF	GJM0225C1E7R2DB01#	p157					±0.1pF	GJM0225C1E8R6BB01#	p157	
			7.3pF	±0.05pF	GJM0225C1E7R3WB01#	p157					±0.25pF	GJM0225C1E8R6CB01#	p157	
				±0.1pF	GJM0225C1E7R3BB01#	p157					±0.5pF	GJM0225C1E8R6DB01#	p157	
				±0.25pF	GJM0225C1E7R3CB01#	p157				8.7pF	±0.05pF	GJM0225C1E8R7WB01#	p157	
				±0.5pF	GJM0225C1E7R3DB01#	p157					±0.1pF	GJM0225C1E8R7BB01#	p157	
			7.4pF	±0.05pF	GJM0225C1E7R4WB01#	p157					±0.25pF	GJM0225C1E8R7CB01#	p157	
				±0.1pF	GJM0225C1E7R4BB01#	p157					±0.5pF	GJM0225C1E8R7DB01#	p157	
				±0.25pF	GJM0225C1E7R4CB01#	p157				8.8pF	±0.05pF	GJM0225C1E8R8WB01#	p157	
				±0.5pF	GJM0225C1E7R4DB01#	p157					±0.1pF	GJM0225C1E8R8BB01#	p157	
			7.5pF	±0.05pF	GJM0225C1E7R5WB01#	p157					±0.25pF	GJM0225C1E8R8CB01#	p157	
				±0.1pF	GJM0225C1E7R5BB01#	p157					±0.5pF	GJM0225C1E8R8DB01#	p157	
				±0.25pF	GJM0225C1E7R5CB01#	p157				8.9pF	±0.05pF	GJM0225C1E8R9WB01#	p157	
				±0.5pF	GJM0225C1E7R5DB01#	p157					±0.1pF	GJM0225C1E8R9BB01#	p157	
			7.6pF	±0.05pF	GJM0225C1E7R6WB01#	p157					±0.25pF	GJM0225C1E8R9CB01#	p157	
				±0.1pF	GJM0225C1E7R6BB01#	p157					±0.5pF	GJM0225C1E8R9DB01#	p157	
				±0.25pF	GJM0225C1E7R6CB01#	p157				9.0pF	±0.05pF	GJM0225C1E9R0WB01#	p157	
				±0.5pF	GJM0225C1E7R6DB01#	p157					±0.1pF	GJM0225C1E9R0BB01#	p157	
			7.7pF	±0.05pF	GJM0225C1E7R7WB01#	p157					±0.25pF	GJM0225C1E9R0CB01#	p157	
				±0.1pF	GJM0225C1E7R7BB01#	p157					±0.5pF	GJM0225C1E9R0DB01#	p157	
				±0.25pF	GJM0225C1E7R7CB01#	p157				9.1pF	±0.05pF	GJM0225C1E9R1WB01#	p157	
				±0.5pF	GJM0225C1E7R7DB01#	p157					±0.1pF	GJM0225C1E9R1BB01#	p157	
			7.8pF	±0.05pF	GJM0225C1E7R8WB01#	p157					±0.25pF	GJM0225C1E9R1CB01#	p157	
				±0.1pF	GJM0225C1E7R8BB01#	p157					±0.5pF	GJM0225C1E9R1DB01#	p157	
				±0.25pF	GJM0225C1E7R8CB01#	p157				9.2pF	±0.05pF	GJM0225C1E9R2WB01#	p157	
				±0.5pF	GJM0225C1E7R8DB01#	p157					±0.1pF	GJM0225C1E9R2BB01#	p157	
			7.9pF	±0.05pF	GJM0225C1E7R9WB01#	p157					±0.25pF	GJM0225C1E9R2CB01#	p157	
				±0.1pF	GJM0225C1E7R9BB01#	p157					±0.5pF	GJM0225C1E9R2DB01#	p157	
				±0.25pF	GJM0225C1E7R9CB01#	p157				9.3pF	±0.05pF	GJM0225C1E9R3WB01#	p157	
				±0.5pF	GJM0225C1E7R9DB01#	p157					±0.1pF	GJM0225C1E9R3BB01#	p157	
			8.0pF	±0.05pF	GJM0225C1E8ROWB01#	p157					±0.25pF	GJM0225C1E9R3CB01#	p157	
				±0.1pF	GJM0225C1E8R0BB01#	p157					±0.5pF	GJM0225C1E9R3DB01#	p157	
				±0.25pF	GJM0225C1E8R0CB01#	p157				9.4pF	±0.05pF	GJM0225C1E9R4WB01#	p157	
				±0.5pF	GJM0225C1E8R0DB01#	p157					±0.1pF	GJM0225C1E9R4BB01#	p157	
			8.1pF	±0.05pF	GJM0225C1E8R1WB01#	p157					±0.25pF	GJM0225C1E9R4CB01#	p157	
				±0.1pF	GJM0225C1E8R1BB01#	p157					±0.5pF	GJM0225C1E9R4DB01#	p157	
				±0.25pF	GJM0225C1E8R1CB01#	p157				9.5pF	±0.05pF	GJM0225C1E9R5WB01#	p157	
				±0.5pF	GJM0225C1E8R1DB01#	p157					±0.1pF	GJM0225C1E9R5BB01#	p157	
			8.2pF	±0.05pF	GJM0225C1E8R2WB01#	p157					±0.25pF	GJM0225C1E9R5CB01#	p157	
				±0.1pF	GJM0225C1E8R2BB01#	p157					±0.5pF	GJM0225C1E9R5DB01#	p157	
				±0.25pF	GJM0225C1E8R2CB01#	p157				9.6pF	±0.05pF	GJM0225C1E9R6WB01#	p157	
				±0.5pF	GJM0225C1E8R2DB01#	p157					±0.1pF	GJM0225C1E9R6BB01#	p157	
			8.3pF	±0.05pF	GJM0225C1E8R3WB01#	p157					±0.25pF	GJM0225C1E9R6CB01#	p157	

*: Refers to the page of the "Specifications and Test Methods".

Part number # indicates the package specification code.



GJM Series Temperature Compensating Type Part Number List

(→ 0.4×0.2mm)

T max.	Rated Voltage	TC Code	Cap.	Tol.	Part Number	p*	T max.	Rated Voltage	TC Code	Cap.	Tol.	Part Number	p*
0.22mm	25Vdc	COG	9.6pF	±0.5pF	GJM0225C1E9R6DB01#	p157	0.22mm	25Vdc	CK	1.2pF	±0.1pF	GJM0224C1E1R2BB01#	p157
				±0.05pF	GJM0225C1E9R7WB01#	p157					±0.25pF	GJM0224C1E1R2CB01#	p157
			9.7pF	±0.1pF	GJM0225C1E9R7BB01#	p157				1.3pF	±0.05pF	GJM0224C1E1R3WB01#	p157
				±0.25pF	GJM0225C1E9R7CB01#	p157					±0.1pF	GJM0224C1E1R3BB01#	p157
				±0.5pF	GJM0225C1E9R7DB01#	p157					±0.25pF	GJM0224C1E1R3CB01#	p157
			9.8pF	±0.05pF	GJM0225C1E9R8WB01#	p157				1.4pF	±0.05pF	GJM0224C1E1R4WB01#	p157
				±0.1pF	GJM0225C1E9R8BB01#	p157					±0.1pF	GJM0224C1E1R4BB01#	p157
				±0.25pF	GJM0225C1E9R8CB01#	p157					±0.25pF	GJM0224C1E1R4CB01#	p157
				±0.5pF	GJM0225C1E9R8DB01#	p157					1.5pF	±0.05pF	GJM0224C1E1R5WB01#
			9.9pF	±0.05pF	GJM0225C1E9R9WB01#	p157				±0.1pF		GJM0224C1E1R5BB01#	p157
				±0.1pF	GJM0225C1E9R9BB01#	p157				±0.25pF		GJM0224C1E1R5CB01#	p157
			10pF	±0.25pF	GJM0225C1E9R9CB01#	p157				1.6pF	±0.05pF	GJM0224C1E1R6WB01#	p157
				±0.5pF	GJM0225C1E9R9DB01#	p157					±0.1pF	GJM0224C1E1R6BB01#	p157
				±2%	GJM0225C1E100GB01#	p157					±0.25pF	GJM0224C1E1R6CB01#	p157
			11pF	±5%	GJM0225C1E100JB01#	p157				1.7pF	±0.05pF	GJM0224C1E1R7WB01#	p157
				±2%	GJM0225C1E110GB01#	p157					±0.1pF	GJM0224C1E1R7BB01#	p157
			12pF	±5%	GJM0225C1E110JB01#	p157				1.8pF	±0.05pF	GJM0224C1E1R8WB01#	p157
				±2%	GJM0225C1E120GB01#	p157					±0.1pF	GJM0224C1E1R8BB01#	p157
			13pF	±5%	GJM0225C1E120JB01#	p157				1.9pF	±0.05pF	GJM0224C1E1R9WB01#	p157
				±2%	GJM0225C1E130GB01#	p157					±0.1pF	GJM0224C1E1R9BB01#	p157
			15pF	±5%	GJM0225C1E130JB01#	p157				2.0pF	±0.05pF	GJM0224C1E1R9CB01#	p157
				±2%	GJM0225C1E150GB01#	p157					±0.1pF	GJM0224C1E2R0WB01#	p157
			16pF	±5%	GJM0225C1E150JB01#	p157				2.1pF	±0.05pF	GJM0224C1E2R0BB01#	p157
				±2%	GJM0225C1E160GB01#	p157					±0.1pF	GJM0224C1E2R0CB01#	p157
			18pF	±5%	GJM0225C1E160JB01#	p157				2.2pF	±0.05pF	GJM0223C1E2R1WB01#	p157
		±2%		GJM0225C1E180GB01#	p157	±0.1pF	GJM0223C1E2R1BB01#	p157					
		20pF	±5%	GJM0225C1E180JB01#	p157	2.3pF	±0.25pF	GJM0223C1E2R1CB01#	p157				
			±2%	GJM0225C1E200GB01#	p157		±0.05pF	GJM0223C1E2R2WB01#	p157				
		22pF	±5%	GJM0225C1E200JB01#	p157	2.4pF	±0.1pF	GJM0223C1E2R2BB01#	p157				
			±2%	GJM0225C1E220GB01#	p157		±0.25pF	GJM0223C1E2R2CB01#	p157				
		0.20pF	±0.05pF	GJM0224C1ER20WB01#	p157	2.5pF	±0.05pF	GJM0223C1E2R3WB01#	p157				
			±0.1pF	GJM0224C1ER20BB01#	p157		±0.1pF	GJM0223C1E2R3BB01#	p157				
		0.30pF	±0.05pF	GJM0224C1ER30WB01#	p157	2.6pF	±0.25pF	GJM0223C1E2R3CB01#	p157				
			±0.1pF	GJM0224C1ER30BB01#	p157		±0.05pF	GJM0223C1E2R4WB01#	p157				
		0.40pF	±0.05pF	GJM0224C1ER40WB01#	p157	2.7pF	±0.1pF	GJM0223C1E2R4BB01#	p157				
			±0.1pF	GJM0224C1ER40BB01#	p157		±0.25pF	GJM0223C1E2R4CB01#	p157				
		0.50pF	±0.05pF	GJM0224C1ER50WB01#	p157	2.8pF	±0.05pF	GJM0223C1E2R5WB01#	p157				
			±0.1pF	GJM0224C1ER50BB01#	p157		±0.1pF	GJM0223C1E2R5BB01#	p157				
		0.60pF	±0.05pF	GJM0224C1ER60WB01#	p157	2.9pF	±0.25pF	GJM0223C1E2R5CB01#	p157				
			±0.1pF	GJM0224C1ER60BB01#	p157		±0.05pF	GJM0223C1E2R6WB01#	p157				
		0.70pF	±0.05pF	GJM0224C1ER70WB01#	p157	3.0pF	±0.1pF	GJM0223C1E2R6BB01#	p157				
			±0.1pF	GJM0224C1ER70BB01#	p157		±0.25pF	GJM0223C1E2R6CB01#	p157				
		0.80pF	±0.05pF	GJM0224C1ER80WB01#	p157	2.7pF	±0.05pF	GJM0223C1E2R7WB01#	p157				
			±0.1pF	GJM0224C1ER80BB01#	p157		±0.1pF	GJM0223C1E2R7BB01#	p157				
		0.90pF	±0.05pF	GJM0224C1ER90WB01#	p157	2.8pF	±0.25pF	GJM0223C1E2R7CB01#	p157				
			±0.1pF	GJM0224C1ER90BB01#	p157		±0.05pF	GJM0223C1E2R8WB01#	p157				
		1.0pF	±0.05pF	GJM0224C1E1R0WB01#	p157	2.9pF	±0.1pF	GJM0223C1E2R8BB01#	p157				
			±0.1pF	GJM0224C1E1R0BB01#	p157		±0.25pF	GJM0223C1E2R8CB01#	p157				
			±0.25pF	GJM0224C1E1R0CB01#	p157		±0.05pF	GJM0223C1E2R9WB01#	p157				
		1.1pF	±0.05pF	GJM0224C1E1R1WB01#	p157	3.0pF	±0.1pF	GJM0223C1E2R9BB01#	p157				
±0.1pF	GJM0224C1E1R1BB01#		p157	±0.25pF	GJM0223C1E2R9CB01#		p157						
±0.25pF	GJM0224C1E1R1CB01#		p157	±0.05pF	GJM0223C1E3R0WB01#		p157						
1.2pF	±0.05pF	GJM0224C1E1R2WB01#	p157										

*: Refers to the page of the "Specifications and Test Methods".

Part number # indicates the package specification code.

GJM Series Temperature Compensating Type Part Number List

(→ 0.4×0.2mm)

T max.	Rated Voltage	TC Code	Cap.	Tol.	Part Number	p*	T max.	Rated Voltage	TC Code	Cap.	Tol.	Part Number	p*
0.22mm	25Vdc	CJ	3.0pF	±0.1pF	GJM0223C1E3R0BB01#	p157	0.22mm	25Vdc	CH	4.8pF	±0.1pF	GJM0222C1E4R8BB01#	p157
				±0.25pF	GJM0223C1E3R0CB01#	p157					±0.25pF	GJM0222C1E4R8CB01#	p157
			3.1pF	±0.05pF	GJM0223C1E3R1WB01#	p157				4.9pF	±0.05pF	GJM0222C1E4R9WB01#	p157
				±0.1pF	GJM0223C1E3R1BB01#	p157					±0.1pF	GJM0222C1E4R9BB01#	p157
				±0.25pF	GJM0223C1E3R1CB01#	p157					±0.25pF	GJM0222C1E4R9CB01#	p157
			3.2pF	±0.05pF	GJM0223C1E3R2WB01#	p157				5.0pF	±0.05pF	GJM0222C1E5R0WB01#	p157
				±0.1pF	GJM0223C1E3R2BB01#	p157					±0.1pF	GJM0222C1E5R0BB01#	p157
				±0.25pF	GJM0223C1E3R2CB01#	p157					±0.25pF	GJM0222C1E5R0CB01#	p157
			3.3pF	±0.05pF	GJM0223C1E3R3WB01#	p157				5.1pF	±0.05pF	GJM0222C1E5R1WB01#	p157
				±0.1pF	GJM0223C1E3R3BB01#	p157					±0.1pF	GJM0222C1E5R1BB01#	p157
				±0.25pF	GJM0223C1E3R3CB01#	p157					±0.25pF	GJM0222C1E5R1CB01#	p157
			3.4pF	±0.05pF	GJM0223C1E3R4WB01#	p157				5.2pF	±0.05pF	GJM0222C1E5R2WB01#	p157
				±0.1pF	GJM0223C1E3R4BB01#	p157					±0.1pF	GJM0222C1E5R2BB01#	p157
				±0.25pF	GJM0223C1E3R4CB01#	p157					±0.25pF	GJM0222C1E5R2CB01#	p157
			3.5pF	±0.05pF	GJM0223C1E3R5WB01#	p157				5.3pF	±0.05pF	GJM0222C1E5R3WB01#	p157
				±0.1pF	GJM0223C1E3R5BB01#	p157					±0.1pF	GJM0222C1E5R3BB01#	p157
				±0.25pF	GJM0223C1E3R5CB01#	p157					±0.25pF	GJM0222C1E5R3CB01#	p157
			3.6pF	±0.05pF	GJM0223C1E3R6WB01#	p157				5.4pF	±0.05pF	GJM0222C1E5R4WB01#	p157
				±0.1pF	GJM0223C1E3R6BB01#	p157					±0.1pF	GJM0222C1E5R4BB01#	p157
				±0.25pF	GJM0223C1E3R6CB01#	p157					±0.25pF	GJM0222C1E5R4CB01#	p157
			3.7pF	±0.05pF	GJM0223C1E3R7WB01#	p157				5.5pF	±0.05pF	GJM0222C1E5R5WB01#	p157
				±0.1pF	GJM0223C1E3R7BB01#	p157					±0.1pF	GJM0222C1E5R5BB01#	p157
				±0.25pF	GJM0223C1E3R7CB01#	p157					±0.25pF	GJM0222C1E5R5CB01#	p157
			3.8pF	±0.05pF	GJM0223C1E3R8WB01#	p157				5.6pF	±0.05pF	GJM0222C1E5R6WB01#	p157
				±0.1pF	GJM0223C1E3R8BB01#	p157					±0.1pF	GJM0222C1E5R6BB01#	p157
				±0.25pF	GJM0223C1E3R8CB01#	p157					±0.25pF	GJM0222C1E5R6CB01#	p157
			3.9pF	±0.05pF	GJM0223C1E3R9WB01#	p157				5.7pF	±0.05pF	GJM0222C1E5R7WB01#	p157
				±0.1pF	GJM0223C1E3R9BB01#	p157					±0.1pF	GJM0222C1E5R7BB01#	p157
				±0.25pF	GJM0223C1E3R9CB01#	p157					±0.25pF	GJM0222C1E5R7CB01#	p157
			4.0pF	±0.05pF	GJM0222C1E4R0WB01#	p157				5.8pF	±0.05pF	GJM0222C1E5R8WB01#	p157
				±0.1pF	GJM0222C1E4R0BB01#	p157					±0.1pF	GJM0222C1E5R8BB01#	p157
				±0.25pF	GJM0222C1E4R0CB01#	p157					±0.25pF	GJM0222C1E5R8CB01#	p157
			4.1pF	±0.05pF	GJM0222C1E4R1WB01#	p157				5.9pF	±0.05pF	GJM0222C1E5R9WB01#	p157
				±0.1pF	GJM0222C1E4R1BB01#	p157					±0.1pF	GJM0222C1E5R9BB01#	p157
				±0.25pF	GJM0222C1E4R1CB01#	p157					±0.25pF	GJM0222C1E5R9CB01#	p157
			4.2pF	±0.05pF	GJM0222C1E4R2WB01#	p157				6.0pF	±0.05pF	GJM0222C1E6R0WB01#	p157
				±0.1pF	GJM0222C1E4R2BB01#	p157					±0.1pF	GJM0222C1E6R0BB01#	p157
				±0.25pF	GJM0222C1E4R2CB01#	p157					±0.25pF	GJM0222C1E6R0CB01#	p157
			4.3pF	±0.05pF	GJM0222C1E4R3WB01#	p157				6.1pF	±0.05pF	GJM0222C1E6R1WB01#	p157
				±0.1pF	GJM0222C1E4R3BB01#	p157					±0.1pF	GJM0222C1E6R1BB01#	p157
				±0.25pF	GJM0222C1E4R3CB01#	p157					±0.25pF	GJM0222C1E6R1CB01#	p157
			4.4pF	±0.05pF	GJM0222C1E4R4WB01#	p157				6.2pF	±0.05pF	GJM0222C1E6R2WB01#	p157
				±0.1pF	GJM0222C1E4R4BB01#	p157					±0.1pF	GJM0222C1E6R2BB01#	p157
				±0.25pF	GJM0222C1E4R4CB01#	p157					±0.25pF	GJM0222C1E6R2CB01#	p157
			4.5pF	±0.05pF	GJM0222C1E4R5WB01#	p157							
				±0.1pF	GJM0222C1E4R5BB01#	p157							
				±0.25pF	GJM0222C1E4R5CB01#	p157							
			4.6pF	±0.05pF	GJM0222C1E4R6WB01#	p157							
				±0.1pF	GJM0222C1E4R6BB01#	p157							
				±0.25pF	GJM0222C1E4R6CB01#	p157							
		4.7pF	±0.05pF	GJM0222C1E4R7WB01#	p157								
			±0.1pF	GJM0222C1E4R7BB01#	p157								
			±0.25pF	GJM0222C1E4R7CB01#	p157								
		4.8pF	±0.05pF	GJM0222C1E4R8WB01#	p157								

*: Refers to the page of the "Specifications and Test Methods".

Part number # indicates the package specification code.



GJM Series Temperature Compensating Type Part Number List

(→ 0.4×0.2mm)

T max.	Rated Voltage	TC Code	Cap.	Tol.	Part Number	p*
0.22mm	25Vdc	CH	6.2pF	±0.25pF	GJM0222C1E6R2CB01#	p157
				±0.5pF	GJM0222C1E6R2DB01#	p157
			6.3pF	±0.05pF	GJM0222C1E6R3WB01#	p157
				±0.1pF	GJM0222C1E6R3BB01#	p157
				±0.25pF	GJM0222C1E6R3CB01#	p157
				±0.5pF	GJM0222C1E6R3DB01#	p157
			6.4pF	±0.05pF	GJM0222C1E6R4WB01#	p157
				±0.1pF	GJM0222C1E6R4BB01#	p157
				±0.25pF	GJM0222C1E6R4CB01#	p157
				±0.5pF	GJM0222C1E6R4DB01#	p157
			6.5pF	±0.05pF	GJM0222C1E6R5WB01#	p157
				±0.1pF	GJM0222C1E6R5BB01#	p157
				±0.25pF	GJM0222C1E6R5CB01#	p157
				±0.5pF	GJM0222C1E6R5DB01#	p157
			6.6pF	±0.05pF	GJM0222C1E6R6WB01#	p157
				±0.1pF	GJM0222C1E6R6BB01#	p157
				±0.25pF	GJM0222C1E6R6CB01#	p157
				±0.5pF	GJM0222C1E6R6DB01#	p157
			6.7pF	±0.05pF	GJM0222C1E6R7WB01#	p157
				±0.1pF	GJM0222C1E6R7BB01#	p157
				±0.25pF	GJM0222C1E6R7CB01#	p157
				±0.5pF	GJM0222C1E6R7DB01#	p157
			6.8pF	±0.05pF	GJM0222C1E6R8WB01#	p157
				±0.1pF	GJM0222C1E6R8BB01#	p157
				±0.25pF	GJM0222C1E6R8CB01#	p157
				±0.5pF	GJM0222C1E6R8DB01#	p157
			6.9pF	±0.05pF	GJM0222C1E6R9WB01#	p157
				±0.1pF	GJM0222C1E6R9BB01#	p157
				±0.25pF	GJM0222C1E6R9CB01#	p157
				±0.5pF	GJM0222C1E6R9DB01#	p157
			7.0pF	±0.05pF	GJM0222C1E7R0WB01#	p157
				±0.1pF	GJM0222C1E7R0BB01#	p157
				±0.25pF	GJM0222C1E7R0CB01#	p157
				±0.5pF	GJM0222C1E7R0DB01#	p157
			7.1pF	±0.05pF	GJM0222C1E7R1WB01#	p157
				±0.1pF	GJM0222C1E7R1BB01#	p157
				±0.25pF	GJM0222C1E7R1CB01#	p157
				±0.5pF	GJM0222C1E7R1DB01#	p157
			7.2pF	±0.05pF	GJM0222C1E7R2WB01#	p157
				±0.1pF	GJM0222C1E7R2BB01#	p157
				±0.25pF	GJM0222C1E7R2CB01#	p157
				±0.5pF	GJM0222C1E7R2DB01#	p157
			7.3pF	±0.05pF	GJM0222C1E7R3WB01#	p157
				±0.1pF	GJM0222C1E7R3BB01#	p157
				±0.25pF	GJM0222C1E7R3CB01#	p157
				±0.5pF	GJM0222C1E7R3DB01#	p157
			7.4pF	±0.05pF	GJM0222C1E7R4WB01#	p157
				±0.1pF	GJM0222C1E7R4BB01#	p157
				±0.25pF	GJM0222C1E7R4CB01#	p157
				±0.5pF	GJM0222C1E7R4DB01#	p157
			7.5pF	±0.05pF	GJM0222C1E7R5WB01#	p157
				±0.1pF	GJM0222C1E7R5BB01#	p157
				±0.25pF	GJM0222C1E7R5CB01#	p157
				±0.5pF	GJM0222C1E7R5DB01#	p157

T max.	Rated Voltage	TC Code	Cap.	Tol.	Part Number	p*
0.22mm	25Vdc	CH	7.6pF	±0.05pF	GJM0222C1E7R6WB01#	p157
				±0.1pF	GJM0222C1E7R6BB01#	p157
				±0.25pF	GJM0222C1E7R6CB01#	p157
				±0.5pF	GJM0222C1E7R6DB01#	p157
			7.7pF	±0.05pF	GJM0222C1E7R7WB01#	p157
				±0.1pF	GJM0222C1E7R7BB01#	p157
				±0.25pF	GJM0222C1E7R7CB01#	p157
			7.8pF	±0.05pF	GJM0222C1E7R8WB01#	p157
				±0.1pF	GJM0222C1E7R8BB01#	p157
				±0.25pF	GJM0222C1E7R8CB01#	p157
			7.9pF	±0.05pF	GJM0222C1E7R9WB01#	p157
				±0.1pF	GJM0222C1E7R9BB01#	p157
				±0.25pF	GJM0222C1E7R9CB01#	p157
			8.0pF	±0.05pF	GJM0222C1E8R0WB01#	p157
				±0.1pF	GJM0222C1E8R0BB01#	p157
				±0.25pF	GJM0222C1E8R0CB01#	p157
			8.1pF	±0.05pF	GJM0222C1E8R1WB01#	p157
				±0.1pF	GJM0222C1E8R1BB01#	p157
				±0.25pF	GJM0222C1E8R1CB01#	p157
			8.2pF	±0.05pF	GJM0222C1E8R2WB01#	p157
				±0.1pF	GJM0222C1E8R2BB01#	p157
				±0.25pF	GJM0222C1E8R2CB01#	p157
			8.3pF	±0.05pF	GJM0222C1E8R3WB01#	p157
				±0.1pF	GJM0222C1E8R3BB01#	p157
				±0.25pF	GJM0222C1E8R3CB01#	p157
			8.4pF	±0.05pF	GJM0222C1E8R4WB01#	p157
				±0.1pF	GJM0222C1E8R4BB01#	p157
				±0.25pF	GJM0222C1E8R4CB01#	p157
			8.5pF	±0.05pF	GJM0222C1E8R5WB01#	p157
				±0.1pF	GJM0222C1E8R5BB01#	p157
				±0.25pF	GJM0222C1E8R5CB01#	p157
			8.6pF	±0.05pF	GJM0222C1E8R6WB01#	p157
				±0.1pF	GJM0222C1E8R6BB01#	p157
				±0.25pF	GJM0222C1E8R6CB01#	p157
			8.7pF	±0.05pF	GJM0222C1E8R7WB01#	p157
				±0.1pF	GJM0222C1E8R7BB01#	p157
				±0.25pF	GJM0222C1E8R7CB01#	p157
			8.8pF	±0.05pF	GJM0222C1E8R8WB01#	p157
				±0.1pF	GJM0222C1E8R8BB01#	p157
				±0.25pF	GJM0222C1E8R8CB01#	p157
			8.9pF	±0.05pF	GJM0222C1E8R9WB01#	p157
				±0.1pF	GJM0222C1E8R9BB01#	p157

*: Refers to the page of the "Specifications and Test Methods".

Part number # indicates the package specification code.

GJM Series Temperature Compensating Type Part Number List

(→ 0.4×0.2mm)

T max.	Rated Voltage	TC Code	Cap.	Tol.	Part Number	p*
0.22mm	25Vdc	CH	8.9pF	±0.25pF	GJM0222C1E8R9CB01#	p157
				±0.5pF	GJM0222C1E8R9DB01#	p157
			9.0pF	±0.05pF	GJM0222C1E9R0WB01#	p157
				±0.1pF	GJM0222C1E9R0BB01#	p157
				±0.25pF	GJM0222C1E9R0CB01#	p157
				±0.5pF	GJM0222C1E9R0DB01#	p157
			9.1pF	±0.05pF	GJM0222C1E9R1WB01#	p157
				±0.1pF	GJM0222C1E9R1BB01#	p157
				±0.25pF	GJM0222C1E9R1CB01#	p157
				±0.5pF	GJM0222C1E9R1DB01#	p157
			9.2pF	±0.05pF	GJM0222C1E9R2WB01#	p157
				±0.1pF	GJM0222C1E9R2BB01#	p157
				±0.25pF	GJM0222C1E9R2CB01#	p157
				±0.5pF	GJM0222C1E9R2DB01#	p157
			9.3pF	±0.05pF	GJM0222C1E9R3WB01#	p157
				±0.1pF	GJM0222C1E9R3BB01#	p157
				±0.25pF	GJM0222C1E9R3CB01#	p157
				±0.5pF	GJM0222C1E9R3DB01#	p157
			9.4pF	±0.05pF	GJM0222C1E9R4WB01#	p157
				±0.1pF	GJM0222C1E9R4BB01#	p157
				±0.25pF	GJM0222C1E9R4CB01#	p157
				±0.5pF	GJM0222C1E9R4DB01#	p157
			9.5pF	±0.05pF	GJM0222C1E9R5WB01#	p157
				±0.1pF	GJM0222C1E9R5BB01#	p157
				±0.25pF	GJM0222C1E9R5CB01#	p157
				±0.5pF	GJM0222C1E9R5DB01#	p157
			9.6pF	±0.05pF	GJM0222C1E9R6WB01#	p157
				±0.1pF	GJM0222C1E9R6BB01#	p157
				±0.25pF	GJM0222C1E9R6CB01#	p157
				±0.5pF	GJM0222C1E9R6DB01#	p157
			9.7pF	±0.05pF	GJM0222C1E9R7WB01#	p157
				±0.1pF	GJM0222C1E9R7BB01#	p157
				±0.25pF	GJM0222C1E9R7CB01#	p157
				±0.5pF	GJM0222C1E9R7DB01#	p157
			9.8pF	±0.05pF	GJM0222C1E9R8WB01#	p157
				±0.1pF	GJM0222C1E9R8BB01#	p157
				±0.25pF	GJM0222C1E9R8CB01#	p157
				±0.5pF	GJM0222C1E9R8DB01#	p157
			9.9pF	±0.05pF	GJM0222C1E9R9WB01#	p157
				±0.1pF	GJM0222C1E9R9BB01#	p157
				±0.25pF	GJM0222C1E9R9CB01#	p157
				±0.5pF	GJM0222C1E9R9DB01#	p157
			10pF	±2%	GJM0222C1E100GB01#	p157
				±5%	GJM0222C1E100JB01#	p157
			11pF	±2%	GJM0222C1E110GB01#	p157
				±5%	GJM0222C1E110JB01#	p157
			12pF	±2%	GJM0222C1E120GB01#	p157
				±5%	GJM0222C1E120JB01#	p157
			13pF	±2%	GJM0222C1E130GB01#	p157
				±5%	GJM0222C1E130JB01#	p157
			15pF	±2%	GJM0222C1E150GB01#	p157
				±5%	GJM0222C1E150JB01#	p157
			16pF	±2%	GJM0222C1E160GB01#	p157
				±5%	GJM0222C1E160JB01#	p157

T max.	Rated Voltage	TC Code	Cap.	Tol.	Part Number	p*
0.22mm	25Vdc	CH	18pF	±2%	GJM0222C1E180GB01#	p157
				±5%	GJM0222C1E180JB01#	p157
			20pF	±2%	GJM0222C1E200GB01#	p157
				±5%	GJM0222C1E200JB01#	p157
			22pF	±2%	GJM0222C1E220GB01#	p157
				±5%	GJM0222C1E220JB01#	p157

0.6×0.3mm

T max.	Rated Voltage	TC Code	Cap.	Tol.	Part Number	p*			
0.33mm	50Vdc	COG	0.20pF	±0.05pF	GJM0335C1HR20WB01#	p160			
				±0.1pF	GJM0335C1HR20BB01#	p160			
			0.30pF	±0.05pF	GJM0335C1HR30WB01#	p160			
				±0.1pF	GJM0335C1HR30BB01#	p160			
			0.40pF	±0.05pF	GJM0335C1HR40WB01#	p160			
				±0.1pF	GJM0335C1HR40BB01#	p160			
			0.50pF	±0.05pF	GJM0335C1HR50WB01#	p160			
				±0.1pF	GJM0335C1HR50BB01#	p160			
			0.60pF	±0.05pF	GJM0335C1HR60WB01#	p160			
				±0.1pF	GJM0335C1HR60BB01#	p160			
			0.70pF	±0.05pF	GJM0335C1HR70WB01#	p160			
				±0.1pF	GJM0335C1HR70BB01#	p160			
			0.80pF	±0.05pF	GJM0335C1HR80WB01#	p160			
				±0.1pF	GJM0335C1HR80BB01#	p160			
			0.90pF	±0.05pF	GJM0335C1HR90WB01#	p160			
				±0.1pF	GJM0335C1HR90BB01#	p160			
			CK	0.20pF	±0.05pF	GJM0334C1HR20WB01#	p160		
					±0.05pF	GJM0334C1HR30WB01#	p160		
					±0.05pF	GJM0334C1HR40WB01#	p160		
					±0.05pF	GJM0334C1HR50WB01#	p160		
					±0.05pF	GJM0334C1HR60WB01#	p160		
					±0.05pF	GJM0334C1HR70WB01#	p160		
					±0.05pF	GJM0334C1HR80WB01#	p160		
					±0.05pF	GJM0334C1HR90WB01#	p160		
					±0.1pF	GJM0334C1H1R0BB01#	p160		
					±0.1pF	GJM0334C1H1R1BB01#	p160		
			CJ	2.2pF	±0.1pF	GJM0333C1H2R2BB01#	p160		
					±0.1pF	GJM0333C1H2R4BB01#	p160		
					±0.1pF	GJM0333C1H2R7BB01#	p160		
					±0.1pF	GJM0333C1H3R0BB01#	p160		
					±0.1pF	GJM0333C1H3R3BB01#	p160		
					±0.1pF	GJM0333C1H3R6BB01#	p160		
					±0.1pF	GJM0333C1H3R9BB01#	p160		
					CH	0.20pF	±0.05pF	GJM0332C1HR20WB01#	p160
							±0.1pF	GJM0332C1HR20BB01#	p160
							±0.05pF	GJM0332C1HR30WB01#	p160
			0.30pF	±0.05pF	GJM0332C1HR30BB01#	p160			
				±0.1pF	GJM0332C1HR30BB01#	p160			

*: Refers to the page of the "Specifications and Test Methods".

Part number # indicates the package specification code.

Caution / Notice

GRM
 GR3
 GRJ
 GR4
 GR7
GJM
 GQM
 GA2
 GA3 GB
 GA3 GD
 GA3 GF
 LLL
 LLA
 LLM
 LLR
 NFM
 KRM
 KR3
 GMA
 GMD

GJM Series Temperature Compensating Type Part Number List

(→ 0.6×0.3mm)

T max.	Rated Voltage	TC Code	Cap.	Tol.	Part Number	p*		
0.33mm	50Vdc	CH	0.40pF	±0.05pF	GJM0332C1HR40WB01#	p160		
				±0.1pF	GJM0332C1HR40BB01#	p160		
			0.50pF	±0.05pF	GJM0332C1HR50WB01#	p160		
				±0.1pF	GJM0332C1HR50BB01#	p160		
			0.60pF	±0.05pF	GJM0332C1HR60WB01#	p160		
				±0.1pF	GJM0332C1HR60BB01#	p160		
			0.70pF	±0.05pF	GJM0332C1HR70WB01#	p160		
				±0.1pF	GJM0332C1HR70BB01#	p160		
			0.80pF	±0.05pF	GJM0332C1HR80WB01#	p160		
				±0.1pF	GJM0332C1HR80BB01#	p160		
			0.90pF	±0.05pF	GJM0332C1HR90WB01#	p160		
				±0.1pF	GJM0332C1HR90BB01#	p160		
			25Vdc	COG	1.0pF	±0.05pF	GJM0335C1E1R0WB01#	p157
						±0.1pF	GJM0335C1E1R0BB01#	p157
						±0.25pF	GJM0335C1E1R0CB01#	p157
					1.1pF	±0.05pF	GJM0335C1E1R1WB01#	p157
						±0.1pF	GJM0335C1E1R1BB01#	p157
						±0.25pF	GJM0335C1E1R1CB01#	p157
	1.2pF	±0.05pF			GJM0335C1E1R2WB01#	p157		
		±0.1pF			GJM0335C1E1R2BB01#	p157		
		±0.25pF			GJM0335C1E1R2CB01#	p157		
	1.3pF	±0.05pF			GJM0335C1E1R3WB01#	p157		
		±0.1pF			GJM0335C1E1R3BB01#	p157		
		±0.25pF			GJM0335C1E1R3CB01#	p157		
	1.4pF	±0.05pF			GJM0335C1E1R4WB01#	p157		
		±0.1pF			GJM0335C1E1R4BB01#	p157		
		±0.25pF			GJM0335C1E1R4CB01#	p157		
	1.5pF	±0.05pF			GJM0335C1E1R5WB01#	p157		
		±0.1pF			GJM0335C1E1R5BB01#	p157		
		±0.25pF			GJM0335C1E1R5CB01#	p157		
	1.6pF	±0.05pF			GJM0335C1E1R6WB01#	p157		
		±0.1pF			GJM0335C1E1R6BB01#	p157		
		±0.25pF			GJM0335C1E1R6CB01#	p157		
	1.7pF	±0.05pF			GJM0335C1E1R7WB01#	p157		
		±0.1pF			GJM0335C1E1R7BB01#	p157		
		±0.25pF			GJM0335C1E1R7CB01#	p157		
1.8pF	±0.05pF	GJM0335C1E1R8WB01#			p157			
	±0.1pF	GJM0335C1E1R8BB01#			p157			
	±0.25pF	GJM0335C1E1R8CB01#			p157			
1.9pF	±0.05pF	GJM0335C1E1R9WB01#			p157			
	±0.1pF	GJM0335C1E1R9BB01#			p157			
	±0.25pF	GJM0335C1E1R9CB01#			p157			
2.0pF	±0.05pF	GJM0335C1E2R0WB01#			p157			
	±0.1pF	GJM0335C1E2R0BB01#			p157			
	±0.25pF	GJM0335C1E2R0CB01#			p157			
2.1pF	±0.05pF	GJM0335C1E2R1WB01#			p157			
	±0.1pF	GJM0335C1E2R1BB01#			p157			
	±0.25pF	GJM0335C1E2R1CB01#			p157			
2.2pF	±0.05pF	GJM0335C1E2R2WB01#	p157					
	±0.1pF	GJM0335C1E2R2BB01#	p157					
	±0.25pF	GJM0335C1E2R2CB01#	p157					
2.3pF	±0.05pF	GJM0335C1E2R3WB01#	p157					
	±0.1pF	GJM0335C1E2R3BB01#	p157					
	±0.25pF	GJM0335C1E2R3CB01#	p157					

T max.	Rated Voltage	TC Code	Cap.	Tol.	Part Number	p*
0.33mm	25Vdc	COG	2.4pF	±0.05pF	GJM0335C1E2R4WB01#	p157
				±0.1pF	GJM0335C1E2R4BB01#	p157
				±0.25pF	GJM0335C1E2R4CB01#	p157
			2.5pF	±0.05pF	GJM0335C1E2R5WB01#	p157
				±0.1pF	GJM0335C1E2R5BB01#	p157
				±0.25pF	GJM0335C1E2R5CB01#	p157
			2.6pF	±0.05pF	GJM0335C1E2R6WB01#	p157
				±0.1pF	GJM0335C1E2R6BB01#	p157
				±0.25pF	GJM0335C1E2R6CB01#	p157
			2.7pF	±0.05pF	GJM0335C1E2R7WB01#	p157
				±0.1pF	GJM0335C1E2R7BB01#	p157
				±0.25pF	GJM0335C1E2R7CB01#	p157
			2.8pF	±0.05pF	GJM0335C1E2R8WB01#	p157
				±0.1pF	GJM0335C1E2R8BB01#	p157
				±0.25pF	GJM0335C1E2R8CB01#	p157
			2.9pF	±0.05pF	GJM0335C1E2R9WB01#	p157
				±0.1pF	GJM0335C1E2R9BB01#	p157
				±0.25pF	GJM0335C1E2R9CB01#	p157
			3.0pF	±0.05pF	GJM0335C1E3R0WB01#	p157
				±0.1pF	GJM0335C1E3R0BB01#	p157
				±0.25pF	GJM0335C1E3R0CB01#	p157
			3.1pF	±0.05pF	GJM0335C1E3R1WB01#	p157
				±0.1pF	GJM0335C1E3R1BB01#	p157
				±0.25pF	GJM0335C1E3R1CB01#	p157
			3.2pF	±0.05pF	GJM0335C1E3R2WB01#	p157
				±0.1pF	GJM0335C1E3R2BB01#	p157
				±0.25pF	GJM0335C1E3R2CB01#	p157
			3.3pF	±0.05pF	GJM0335C1E3R3WB01#	p157
				±0.1pF	GJM0335C1E3R3BB01#	p157
				±0.25pF	GJM0335C1E3R3CB01#	p157
			3.4pF	±0.05pF	GJM0335C1E3R4WB01#	p157
				±0.1pF	GJM0335C1E3R4BB01#	p157
				±0.25pF	GJM0335C1E3R4CB01#	p157
			3.5pF	±0.05pF	GJM0335C1E3R5WB01#	p157
				±0.1pF	GJM0335C1E3R5BB01#	p157
				±0.25pF	GJM0335C1E3R5CB01#	p157
			3.6pF	±0.05pF	GJM0335C1E3R6WB01#	p157
				±0.1pF	GJM0335C1E3R6BB01#	p157
				±0.25pF	GJM0335C1E3R6CB01#	p157
			3.7pF	±0.05pF	GJM0335C1E3R7WB01#	p157
				±0.1pF	GJM0335C1E3R7BB01#	p157
				±0.25pF	GJM0335C1E3R7CB01#	p157
			3.8pF	±0.05pF	GJM0335C1E3R8WB01#	p157
				±0.1pF	GJM0335C1E3R8BB01#	p157
				±0.25pF	GJM0335C1E3R8CB01#	p157
			3.9pF	±0.05pF	GJM0335C1E3R9WB01#	p157
				±0.1pF	GJM0335C1E3R9BB01#	p157
				±0.25pF	GJM0335C1E3R9CB01#	p157
4.0pF	±0.05pF	GJM0335C1E4R0WB01#	p157			
	±0.1pF	GJM0335C1E4R0BB01#	p157			
	±0.25pF	GJM0335C1E4R0CB01#	p157			
4.1pF	±0.05pF	GJM0335C1E4R1WB01#	p157			
	±0.1pF	GJM0335C1E4R1BB01#	p157			
	±0.25pF	GJM0335C1E4R1CB01#	p157			

*: Refers to the page of the "Specifications and Test Methods".

Part number # indicates the package specification code.

GJM Series Temperature Compensating Type Part Number List

(→ 0.6×0.3mm)

T max.	Rated Voltage	TC Code	Cap.	Tol.	Part Number	p*
0.33mm	25Vdc	COG	4.2pF	±0.05pF	GJM0335C1E4R2WB01#	p157
				±0.1pF	GJM0335C1E4R2BB01#	p157
				±0.25pF	GJM0335C1E4R2CB01#	p157
			4.3pF	±0.05pF	GJM0335C1E4R3WB01#	p157
				±0.1pF	GJM0335C1E4R3BB01#	p157
				±0.25pF	GJM0335C1E4R3CB01#	p157
			4.4pF	±0.05pF	GJM0335C1E4R4WB01#	p157
				±0.1pF	GJM0335C1E4R4BB01#	p157
				±0.25pF	GJM0335C1E4R4CB01#	p157
			4.5pF	±0.05pF	GJM0335C1E4R5WB01#	p157
				±0.1pF	GJM0335C1E4R5BB01#	p157
				±0.25pF	GJM0335C1E4R5CB01#	p157
			4.6pF	±0.05pF	GJM0335C1E4R6WB01#	p157
				±0.1pF	GJM0335C1E4R6BB01#	p157
				±0.25pF	GJM0335C1E4R6CB01#	p157
			4.7pF	±0.05pF	GJM0335C1E4R7WB01#	p157
				±0.1pF	GJM0335C1E4R7BB01#	p157
				±0.25pF	GJM0335C1E4R7CB01#	p157
			4.8pF	±0.05pF	GJM0335C1E4R8WB01#	p157
				±0.1pF	GJM0335C1E4R8BB01#	p157
				±0.25pF	GJM0335C1E4R8CB01#	p157
			4.9pF	±0.05pF	GJM0335C1E4R9WB01#	p157
				±0.1pF	GJM0335C1E4R9BB01#	p157
				±0.25pF	GJM0335C1E4R9CB01#	p157
			5.0pF	±0.05pF	GJM0335C1E5R0WB01#	p157
				±0.1pF	GJM0335C1E5R0BB01#	p157
				±0.25pF	GJM0335C1E5R0CB01#	p157
			5.1pF	±0.05pF	GJM0335C1E5R1WB01#	p157
				±0.1pF	GJM0335C1E5R1BB01#	p157
				±0.25pF	GJM0335C1E5R1CB01#	p157
			5.2pF	±0.05pF	GJM0335C1E5R2WB01#	p157
				±0.1pF	GJM0335C1E5R2BB01#	p157
				±0.25pF	GJM0335C1E5R2CB01#	p157
			5.3pF	±0.05pF	GJM0335C1E5R3WB01#	p157
				±0.1pF	GJM0335C1E5R3BB01#	p157
				±0.25pF	GJM0335C1E5R3CB01#	p157
			5.4pF	±0.05pF	GJM0335C1E5R4WB01#	p157
				±0.1pF	GJM0335C1E5R4BB01#	p157
				±0.25pF	GJM0335C1E5R4CB01#	p157
			5.5pF	±0.05pF	GJM0335C1E5R5WB01#	p157
				±0.1pF	GJM0335C1E5R5BB01#	p157
				±0.25pF	GJM0335C1E5R5CB01#	p157
			5.6pF	±0.05pF	GJM0335C1E5R6WB01#	p157
				±0.1pF	GJM0335C1E5R6BB01#	p157
				±0.25pF	GJM0335C1E5R6CB01#	p157
			5.7pF	±0.05pF	GJM0335C1E5R7WB01#	p157
				±0.1pF	GJM0335C1E5R7BB01#	p157
				±0.25pF	GJM0335C1E5R7CB01#	p157

T max.	Rated Voltage	TC Code	Cap.	Tol.	Part Number	p*
0.33mm	25Vdc	COG	5.7pF	±0.5pF	GJM0335C1E5R7DB01#	p157
				±0.05pF	GJM0335C1E5R8WB01#	p157
				±0.1pF	GJM0335C1E5R8BB01#	p157
			5.8pF	±0.05pF	GJM0335C1E5R8WB01#	p157
				±0.1pF	GJM0335C1E5R8BB01#	p157
				±0.25pF	GJM0335C1E5R8CB01#	p157
			5.9pF	±0.05pF	GJM0335C1E5R9WB01#	p157
				±0.1pF	GJM0335C1E5R9BB01#	p157
				±0.25pF	GJM0335C1E5R9CB01#	p157
			6.0pF	±0.05pF	GJM0335C1E6R0WB01#	p157
				±0.1pF	GJM0335C1E6R0BB01#	p157
				±0.25pF	GJM0335C1E6R0CB01#	p157
			6.1pF	±0.05pF	GJM0335C1E6R1WB01#	p157
				±0.1pF	GJM0335C1E6R1BB01#	p157
				±0.25pF	GJM0335C1E6R1CB01#	p157
			6.2pF	±0.05pF	GJM0335C1E6R2WB01#	p157
				±0.1pF	GJM0335C1E6R2BB01#	p157
				±0.25pF	GJM0335C1E6R2CB01#	p157
			6.3pF	±0.05pF	GJM0335C1E6R3WB01#	p157
				±0.1pF	GJM0335C1E6R3BB01#	p157
				±0.25pF	GJM0335C1E6R3CB01#	p157
			6.4pF	±0.05pF	GJM0335C1E6R4WB01#	p157
				±0.1pF	GJM0335C1E6R4BB01#	p157
				±0.25pF	GJM0335C1E6R4CB01#	p157
			6.5pF	±0.05pF	GJM0335C1E6R5WB01#	p157
				±0.1pF	GJM0335C1E6R5BB01#	p157
				±0.25pF	GJM0335C1E6R5CB01#	p157
			6.6pF	±0.05pF	GJM0335C1E6R6WB01#	p157
				±0.1pF	GJM0335C1E6R6BB01#	p157
				±0.25pF	GJM0335C1E6R6CB01#	p157
			6.7pF	±0.05pF	GJM0335C1E6R7WB01#	p157
				±0.1pF	GJM0335C1E6R7BB01#	p157
				±0.25pF	GJM0335C1E6R7CB01#	p157
			6.8pF	±0.05pF	GJM0335C1E6R8WB01#	p157
				±0.1pF	GJM0335C1E6R8BB01#	p157
				±0.25pF	GJM0335C1E6R8CB01#	p157
			6.9pF	±0.05pF	GJM0335C1E6R9WB01#	p157
				±0.1pF	GJM0335C1E6R9BB01#	p157
				±0.25pF	GJM0335C1E6R9CB01#	p157
			7.0pF	±0.05pF	GJM0335C1E7R0WB01#	p157
				±0.1pF	GJM0335C1E7R0BB01#	p157
				±0.25pF	GJM0335C1E7R0CB01#	p157
			7.1pF	±0.05pF	GJM0335C1E7R1WB01#	p157
				±0.1pF	GJM0335C1E7R1BB01#	p157
				±0.25pF	GJM0335C1E7R1CB01#	p157

*: Refers to the page of the "Specifications and Test Methods".

Part number # indicates the package specification code.



GJM Series Temperature Compensating Type Part Number List

(→ 0.6×0.3mm)

T max.	Rated Voltage	TC Code	Cap.	Tol.	Part Number	p*
0.33mm	25Vdc	COG	7.1pF	±0.1pF	GJM0335C1E7R1BB01#	p157
				±0.25pF	GJM0335C1E7R1CB01#	p157
				±0.5pF	GJM0335C1E7R1DB01#	p157
			7.2pF	±0.05pF	GJM0335C1E7R2WB01#	p157
				±0.1pF	GJM0335C1E7R2BB01#	p157
				±0.25pF	GJM0335C1E7R2CB01#	p157
			7.3pF	±0.05pF	GJM0335C1E7R3WB01#	p157
				±0.1pF	GJM0335C1E7R3BB01#	p157
				±0.25pF	GJM0335C1E7R3CB01#	p157
			7.4pF	±0.05pF	GJM0335C1E7R4WB01#	p157
				±0.1pF	GJM0335C1E7R4BB01#	p157
				±0.25pF	GJM0335C1E7R4CB01#	p157
			7.5pF	±0.05pF	GJM0335C1E7R5WB01#	p157
				±0.1pF	GJM0335C1E7R5BB01#	p157
				±0.25pF	GJM0335C1E7R5CB01#	p157
			7.6pF	±0.05pF	GJM0335C1E7R6WB01#	p157
				±0.1pF	GJM0335C1E7R6BB01#	p157
				±0.25pF	GJM0335C1E7R6CB01#	p157
			7.7pF	±0.05pF	GJM0335C1E7R7WB01#	p157
				±0.1pF	GJM0335C1E7R7BB01#	p157
				±0.25pF	GJM0335C1E7R7CB01#	p157
			7.8pF	±0.05pF	GJM0335C1E7R8WB01#	p157
				±0.1pF	GJM0335C1E7R8BB01#	p157
				±0.25pF	GJM0335C1E7R8CB01#	p157
			7.9pF	±0.05pF	GJM0335C1E7R9WB01#	p157
				±0.1pF	GJM0335C1E7R9BB01#	p157
				±0.25pF	GJM0335C1E7R9CB01#	p157
			8.0pF	±0.05pF	GJM0335C1E8R0WB01#	p157
				±0.1pF	GJM0335C1E8R0BB01#	p157
				±0.25pF	GJM0335C1E8R0CB01#	p157
			8.1pF	±0.05pF	GJM0335C1E8R1WB01#	p157
				±0.1pF	GJM0335C1E8R1BB01#	p157
				±0.25pF	GJM0335C1E8R1CB01#	p157
			8.2pF	±0.05pF	GJM0335C1E8R2WB01#	p157
				±0.1pF	GJM0335C1E8R2BB01#	p157
				±0.25pF	GJM0335C1E8R2CB01#	p157
			8.3pF	±0.05pF	GJM0335C1E8R3WB01#	p157
				±0.1pF	GJM0335C1E8R3BB01#	p157
				±0.25pF	GJM0335C1E8R3CB01#	p157
			8.4pF	±0.05pF	GJM0335C1E8R4WB01#	p157
				±0.1pF	GJM0335C1E8R4BB01#	p157
				±0.25pF	GJM0335C1E8R4CB01#	p157

T max.	Rated Voltage	TC Code	Cap.	Tol.	Part Number	p*
0.33mm	25Vdc	COG	8.4pF	±0.5pF	GJM0335C1E8R4DB01#	p157
				±0.05pF	GJM0335C1E8R5WB01#	p157
				±0.1pF	GJM0335C1E8R5BB01#	p157
			8.5pF	±0.25pF	GJM0335C1E8R5CB01#	p157
				±0.5pF	GJM0335C1E8R5DB01#	p157
				±0.05pF	GJM0335C1E8R6WB01#	p157
			8.6pF	±0.1pF	GJM0335C1E8R6BB01#	p157
				±0.25pF	GJM0335C1E8R6CB01#	p157
				±0.5pF	GJM0335C1E8R6DB01#	p157
			8.7pF	±0.05pF	GJM0335C1E8R7WB01#	p157
				±0.1pF	GJM0335C1E8R7BB01#	p157
				±0.25pF	GJM0335C1E8R7CB01#	p157
			8.8pF	±0.05pF	GJM0335C1E8R8WB01#	p157
				±0.1pF	GJM0335C1E8R8BB01#	p157
				±0.25pF	GJM0335C1E8R8CB01#	p157
			8.9pF	±0.05pF	GJM0335C1E8R9WB01#	p157
				±0.1pF	GJM0335C1E8R9BB01#	p157
				±0.25pF	GJM0335C1E8R9CB01#	p157
			9.0pF	±0.05pF	GJM0335C1E9R0WB01#	p157
				±0.1pF	GJM0335C1E9R0BB01#	p157
				±0.25pF	GJM0335C1E9R0CB01#	p157
			9.1pF	±0.05pF	GJM0335C1E9R1WB01#	p157
				±0.1pF	GJM0335C1E9R1BB01#	p157
				±0.25pF	GJM0335C1E9R1CB01#	p157
			9.2pF	±0.05pF	GJM0335C1E9R2WB01#	p157
				±0.1pF	GJM0335C1E9R2BB01#	p157
				±0.25pF	GJM0335C1E9R2CB01#	p157
			9.3pF	±0.05pF	GJM0335C1E9R3WB01#	p157
				±0.1pF	GJM0335C1E9R3BB01#	p157
				±0.25pF	GJM0335C1E9R3CB01#	p157
			9.4pF	±0.05pF	GJM0335C1E9R4WB01#	p157
				±0.1pF	GJM0335C1E9R4BB01#	p157
				±0.25pF	GJM0335C1E9R4CB01#	p157
			9.5pF	±0.05pF	GJM0335C1E9R5WB01#	p157
				±0.1pF	GJM0335C1E9R5BB01#	p157
				±0.25pF	GJM0335C1E9R5CB01#	p157
			9.6pF	±0.05pF	GJM0335C1E9R6WB01#	p157
				±0.1pF	GJM0335C1E9R6BB01#	p157
				±0.25pF	GJM0335C1E9R6CB01#	p157
			9.7pF	±0.05pF	GJM0335C1E9R7WB01#	p157
				±0.1pF	GJM0335C1E9R7BB01#	p157
				±0.25pF	GJM0335C1E9R7CB01#	p157
			9.8pF	±0.05pF	GJM0335C1E9R8WB01#	p157
				±0.5pF	GJM0335C1E9R8DB01#	p157

*: Refers to the page of the "Specifications and Test Methods".

Part number # indicates the package specification code.

GJM Series Temperature Compensating Type Part Number List

(→ 0.6×0.3mm)

T max.	Rated Voltage	TC Code	Cap.	Tol.	Part Number	p*	T max.	Rated Voltage	TC Code	Cap.	Tol.	Part Number	p*
0.33mm	25Vdc	COG	9.8pF	±0.1pF	GJM0335C1E9R8BB01#	p157	0.33mm	25Vdc	CK	1.7pF	±0.05pF	GJM0334C1E1R7WB01#	p157
				±0.25pF	GJM0335C1E9R8CB01#	p157					±0.1pF	GJM0334C1E1R7BB01#	p157
				±0.5pF	GJM0335C1E9R8DB01#	p157					±0.25pF	GJM0334C1E1R7CB01#	p157
			9.9pF	±0.05pF	GJM0335C1E9R9WB01#	p157				1.8pF	±0.05pF	GJM0334C1E1R8WB01#	p157
				±0.1pF	GJM0335C1E9R9BB01#	p157					±0.1pF	GJM0334C1E1R8BB01#	p157
				±0.25pF	GJM0335C1E9R9CB01#	p157					±0.25pF	GJM0334C1E1R8CB01#	p157
			10pF	±2%	GJM0335C1E100GB01#	p157				1.9pF	±0.05pF	GJM0334C1E1R9WB01#	p157
				±5%	GJM0335C1E100JB01#	p157					±0.1pF	GJM0334C1E1R9BB01#	p157
				±5%	GJM0335C1E110JB01#	p157					±0.25pF	GJM0334C1E1R9CB01#	p157
			11pF	±2%	GJM0335C1E110GB01#	p157				2.0pF	±0.05pF	GJM0334C1E2R0WB01#	p157
				±5%	GJM0335C1E110JB01#	p157					±0.1pF	GJM0334C1E2R0BB01#	p157
			12pF	±2%	GJM0335C1E120GB01#	p157				2.1pF	±0.05pF	GJM0333C1E2R1WB01#	p157
				±5%	GJM0335C1E120JB01#	p157					±0.1pF	GJM0333C1E2R1BB01#	p157
			13pF	±2%	GJM0335C1E130GB01#	p157				2.2pF	±0.05pF	GJM0333C1E2R2WB01#	p157
				±5%	GJM0335C1E130JB01#	p157					±0.1pF	GJM0333C1E2R2BB01#	p157
			15pF	±2%	GJM0335C1E150GB01#	p157				2.3pF	±0.05pF	GJM0333C1E2R3WB01#	p157
				±5%	GJM0335C1E150JB01#	p157					±0.1pF	GJM0333C1E2R3BB01#	p157
			16pF	±2%	GJM0335C1E160GB01#	p157				2.4pF	±0.05pF	GJM0333C1E2R4WB01#	p157
				±5%	GJM0335C1E160JB01#	p157					±0.1pF	GJM0333C1E2R4BB01#	p157
			18pF	±2%	GJM0335C1E180GB01#	p157				2.5pF	±0.05pF	GJM0333C1E2R5WB01#	p157
				±5%	GJM0335C1E180JB01#	p157					±0.1pF	GJM0333C1E2R5BB01#	p157
			20pF	±2%	GJM0335C1E200GB01#	p157				2.6pF	±0.05pF	GJM0333C1E2R6WB01#	p157
				±5%	GJM0335C1E200JB01#	p157					±0.1pF	GJM0333C1E2R6BB01#	p157
			22pF	±2%	GJM0335C1E220GB01#	p157				2.7pF	±0.05pF	GJM0333C1E2R7WB01#	p157
				±5%	GJM0335C1E220JB01#	p157					±0.1pF	GJM0333C1E2R7BB01#	p157
			24pF	±2%	GJM0335C1E240GB01#	p157				2.8pF	±0.05pF	GJM0333C1E2R8WB01#	p157
				±5%	GJM0335C1E240JB01#	p157					±0.1pF	GJM0333C1E2R8BB01#	p157
			27pF	±2%	GJM0335C1E270GB01#	p157				2.9pF	±0.05pF	GJM0333C1E2R9WB01#	p157
				±5%	GJM0335C1E270JB01#	p157					±0.1pF	GJM0333C1E2R9BB01#	p157
			30pF	±2%	GJM0335C1E300GB01#	p157				3.0pF	±0.05pF	GJM0333C1E3R0WB01#	p157
				±5%	GJM0335C1E300JB01#	p157					±0.1pF	GJM0333C1E3R0BB01#	p157
			33pF	±2%	GJM0335C1E330GB01#	p157				3.1pF	±0.05pF	GJM0333C1E3R1WB01#	p157
				±5%	GJM0335C1E330JB01#	p157					±0.1pF	GJM0333C1E3R1BB01#	p157
			1.0pF	±0.05pF	GJM0334C1E1R0WB01#	p157				3.2pF	±0.05pF	GJM0333C1E3R2WB01#	p157
				±0.1pF	GJM0334C1E1R0BB01#	p157					±0.1pF	GJM0333C1E3R2BB01#	p157
				±0.25pF	GJM0334C1E1R0CB01#	p157					±0.25pF	GJM0333C1E3R2CB01#	p157
			1.1pF	±0.05pF	GJM0334C1E1R1WB01#	p157				3.3pF	±0.05pF	GJM0333C1E3R3WB01#	p157
				±0.1pF	GJM0334C1E1R1BB01#	p157					±0.1pF	GJM0333C1E3R3BB01#	p157
				±0.25pF	GJM0334C1E1R1CB01#	p157					±0.25pF	GJM0333C1E3R3CB01#	p157
			1.2pF	±0.05pF	GJM0334C1E1R2WB01#	p157				3.4pF	±0.05pF	GJM0333C1E3R4WB01#	p157
				±0.1pF	GJM0334C1E1R2BB01#	p157					±0.1pF	GJM0333C1E3R4BB01#	p157
				±0.25pF	GJM0334C1E1R2CB01#	p157					±0.25pF	GJM0333C1E3R4CB01#	p157
			1.3pF	±0.05pF	GJM0334C1E1R3WB01#	p157				3.1pF	±0.05pF	GJM0333C1E3R1WB01#	p157
				±0.1pF	GJM0334C1E1R3BB01#	p157					±0.1pF	GJM0333C1E3R1BB01#	p157
				±0.25pF	GJM0334C1E1R3CB01#	p157					±0.25pF	GJM0333C1E3R1CB01#	p157
			1.4pF	±0.05pF	GJM0334C1E1R4WB01#	p157				3.2pF	±0.05pF	GJM0333C1E3R2WB01#	p157
				±0.1pF	GJM0334C1E1R4BB01#	p157					±0.1pF	GJM0333C1E3R2BB01#	p157
				±0.25pF	GJM0334C1E1R4CB01#	p157					±0.25pF	GJM0333C1E3R2CB01#	p157
			1.5pF	±0.05pF	GJM0334C1E1R5WB01#	p157				3.3pF	±0.05pF	GJM0333C1E3R3WB01#	p157
				±0.1pF	GJM0334C1E1R5BB01#	p157					±0.1pF	GJM0333C1E3R3BB01#	p157
				±0.25pF	GJM0334C1E1R5CB01#	p157					±0.25pF	GJM0333C1E3R3CB01#	p157
			1.6pF	±0.05pF	GJM0334C1E1R6WB01#	p157				3.4pF	±0.05pF	GJM0333C1E3R4WB01#	p157
				±0.1pF	GJM0334C1E1R6BB01#	p157					±0.1pF	GJM0333C1E3R4BB01#	p157
				±0.25pF	GJM0334C1E1R6CB01#	p157					±0.25pF	GJM0333C1E3R4CB01#	p157

*: Refers to the page of the "Specifications and Test Methods".

Part number # indicates the package specification code.



GJM Series Temperature Compensating Type Part Number List

(→ 0.6×0.3mm)

T max.	Rated Voltage	TC Code	Cap.	Tol.	Part Number	p*	T max.	Rated Voltage	TC Code	Cap.	Tol.	Part Number	p*
0.33mm	25Vdc	CJ	3.5pF	±0.05pF	GJM0333C1E3R5WB01#	p157	0.33mm	25Vdc	CH	5.2pF	±0.25pF	GJM0332C1E5R2CB01#	p157
				±0.1pF	GJM0333C1E3R5BB01#	p157					±0.5pF	GJM0332C1E5R2DB01#	p157
				±0.25pF	GJM0333C1E3R5CB01#	p157					5.3pF	±0.05pF	GJM0332C1E5R3WB01#
			±0.05pF	GJM0333C1E3R6WB01#	p157	±0.1pF				GJM0332C1E5R3BB01#		p157	
			±0.1pF	GJM0333C1E3R6BB01#	p157	±0.25pF				GJM0332C1E5R3CB01#		p157	
			±0.25pF	GJM0333C1E3R6CB01#	p157	5.4pF				±0.05pF	GJM0332C1E5R4WB01#	p157	
			±0.05pF	GJM0333C1E3R7WB01#	p157					±0.1pF	GJM0332C1E5R4BB01#	p157	
			±0.1pF	GJM0333C1E3R7BB01#	p157					±0.25pF	GJM0332C1E5R4CB01#	p157	
			±0.25pF	GJM0333C1E3R7CB01#	p157	5.5pF				±0.05pF	GJM0332C1E5R4DB01#	p157	
			±0.05pF	GJM0333C1E3R8WB01#	p157					±0.1pF	GJM0332C1E5R5WB01#	p157	
			±0.1pF	GJM0333C1E3R8BB01#	p157					±0.25pF	GJM0332C1E5R5BB01#	p157	
			±0.25pF	GJM0333C1E3R8CB01#	p157	5.6pF				±0.05pF	GJM0332C1E5R5CB01#	p157	
			±0.05pF	GJM0333C1E3R9WB01#	p157					±0.1pF	GJM0332C1E5R5DB01#	p157	
			±0.1pF	GJM0333C1E3R9BB01#	p157					5.7pF	±0.25pF	GJM0332C1E5R6WB01#	p157
			±0.25pF	GJM0333C1E3R9CB01#	p157	±0.1pF					GJM0332C1E5R6BB01#	p157	
			±0.05pF	GJM0332C1E4R0WB01#	p157	±0.25pF					GJM0332C1E5R6CB01#	p157	
			±0.1pF	GJM0332C1E4R0BB01#	p157	4.1pF				±0.5pF	GJM0332C1E5R6DB01#	p157	
			±0.25pF	GJM0332C1E4R0CB01#	p157					5.8pF	±0.05pF	GJM0332C1E5R7WB01#	p157
			±0.05pF	GJM0332C1E4R1WB01#	p157						±0.1pF	GJM0332C1E5R7BB01#	p157
			±0.1pF	GJM0332C1E4R1BB01#	p157	±0.25pF					GJM0332C1E5R7CB01#	p157	
			±0.25pF	GJM0332C1E4R1CB01#	p157	4.2pF				±0.5pF	GJM0332C1E5R7DB01#	p157	
			±0.05pF	GJM0332C1E4R2WB01#	p157					5.9pF	±0.05pF	GJM0332C1E5R8WB01#	p157
			±0.1pF	GJM0332C1E4R2BB01#	p157						±0.1pF	GJM0332C1E5R8BB01#	p157
			±0.25pF	GJM0332C1E4R2CB01#	p157	±0.25pF					GJM0332C1E5R8CB01#	p157	
			±0.25pF	GJM0332C1E4R2CB01#	p157	4.3pF				±0.5pF	GJM0332C1E5R8DB01#	p157	
			±0.05pF	GJM0332C1E4R3WB01#	p157					6.0pF	±0.05pF	GJM0332C1E6R0WB01#	p157
			±0.1pF	GJM0332C1E4R3BB01#	p157						±0.1pF	GJM0332C1E6R0BB01#	p157
			±0.25pF	GJM0332C1E4R3CB01#	p157	±0.25pF					GJM0332C1E6R0CB01#	p157	
			±0.25pF	GJM0332C1E4R3CB01#	p157	4.4pF				±0.5pF	GJM0332C1E6R0DB01#	p157	
			±0.05pF	GJM0332C1E4R4WB01#	p157					6.1pF	±0.05pF	GJM0332C1E6R1WB01#	p157
		±0.1pF	GJM0332C1E4R4BB01#	p157	±0.1pF						GJM0332C1E6R1BB01#	p157	
		±0.25pF	GJM0332C1E4R4CB01#	p157	±0.25pF	GJM0332C1E6R1CB01#					p157		
		±0.25pF	GJM0332C1E4R4CB01#	p157	4.5pF	±0.5pF				GJM0332C1E6R1DB01#	p157		
		±0.05pF	GJM0332C1E4R5WB01#	p157		6.2pF				±0.05pF	GJM0332C1E6R2WB01#	p157	
		±0.1pF	GJM0332C1E4R5BB01#	p157						±0.1pF	GJM0332C1E6R2BB01#	p157	
		±0.25pF	GJM0332C1E4R5CB01#	p157	±0.25pF					GJM0332C1E6R2CB01#	p157		
		±0.25pF	GJM0332C1E4R5CB01#	p157	4.6pF	±0.5pF				GJM0332C1E6R2DB01#	p157		
		±0.05pF	GJM0332C1E4R6WB01#	p157		6.3pF				±0.05pF	GJM0332C1E6R3WB01#	p157	
		±0.1pF	GJM0332C1E4R6BB01#	p157						±0.1pF	GJM0332C1E6R3BB01#	p157	
		±0.25pF	GJM0332C1E4R6CB01#	p157	±0.25pF					GJM0332C1E6R3CB01#	p157		
		±0.25pF	GJM0332C1E4R6CB01#	p157	4.7pF	±0.5pF				GJM0332C1E6R3DB01#	p157		
		±0.05pF	GJM0332C1E4R7WB01#	p157		6.4pF				±0.05pF	GJM0332C1E6R4WB01#	p157	
		±0.1pF	GJM0332C1E4R7BB01#	p157						±0.1pF	GJM0332C1E6R4BB01#	p157	
		±0.25pF	GJM0332C1E4R7CB01#	p157	±0.25pF					GJM0332C1E6R4CB01#	p157		
		±0.25pF	GJM0332C1E4R7CB01#	p157	4.8pF	±0.5pF				GJM0332C1E6R4DB01#	p157		
		±0.05pF	GJM0332C1E4R8WB01#	p157		6.5pF				±0.05pF	GJM0332C1E6R5WB01#	p157	
		±0.1pF	GJM0332C1E4R8BB01#	p157						±0.1pF	GJM0332C1E6R5BB01#	p157	
		±0.25pF	GJM0332C1E4R8CB01#	p157	±0.25pF					GJM0332C1E6R5CB01#	p157		
		±0.25pF	GJM0332C1E4R8CB01#	p157	4.9pF	±0.5pF				GJM0332C1E6R5DB01#	p157		
		±0.05pF	GJM0332C1E4R9WB01#	p157		5.2pF				±0.05pF	GJM0332C1E5R2WB01#	p157	
		±0.1pF	GJM0332C1E4R9BB01#	p157						±0.1pF	GJM0332C1E5R2BB01#	p157	
		±0.25pF	GJM0332C1E4R9CB01#	p157	±0.25pF					GJM0332C1E5R2CB01#	p157		
		±0.25pF	GJM0332C1E4R9CB01#	p157	5.0pF	±0.05pF				GJM0332C1E5R0WB01#	p157		
		±0.05pF	GJM0332C1E5R0WB01#	p157		±0.1pF				GJM0332C1E5R0BB01#	p157		
		±0.1pF	GJM0332C1E5R0BB01#	p157		±0.25pF				GJM0332C1E5R0CB01#	p157		
		±0.25pF	GJM0332C1E5R0CB01#	p157	5.1pF	±0.05pF				GJM0332C1E5R1WB01#	p157		
		±0.05pF	GJM0332C1E5R1WB01#	p157		±0.1pF				GJM0332C1E5R1BB01#	p157		
		±0.1pF	GJM0332C1E5R1BB01#	p157		±0.25pF				GJM0332C1E5R1CB01#	p157		
		±0.25pF	GJM0332C1E5R1CB01#	p157	5.2pF	±0.5pF				GJM0332C1E5R1DB01#	p157		
		±0.05pF	GJM0332C1E5R2WB01#	p157		±0.1pF				GJM0332C1E5R2BB01#	p157		
		±0.1pF	GJM0332C1E5R2BB01#	p157		±0.25pF				GJM0332C1E5R2CB01#	p157		
		±0.25pF	GJM0332C1E5R2CB01#	p157	±0.5pF	GJM0332C1E5R2DB01#				p157			

*: Refers to the page of the "Specifications and Test Methods".

Part number # indicates the package specification code.



GJM Series Temperature Compensating Type Part Number List

(→ 0.6×0.3mm)

T max.	Rated Voltage	TC Code	Cap.	Tol.	Part Number	p*
0.33mm	25Vdc	CH	6.6pF	±0.05pF	GJM0332C1E6R6WB01#	p157
				±0.1pF	GJM0332C1E6R6BB01#	p157
				±0.25pF	GJM0332C1E6R6CB01#	p157
				±0.5pF	GJM0332C1E6R6DB01#	p157
			6.7pF	±0.05pF	GJM0332C1E6R7WB01#	p157
				±0.1pF	GJM0332C1E6R7BB01#	p157
				±0.25pF	GJM0332C1E6R7CB01#	p157
				±0.5pF	GJM0332C1E6R7DB01#	p157
			6.8pF	±0.05pF	GJM0332C1E6R8WB01#	p157
				±0.1pF	GJM0332C1E6R8BB01#	p157
				±0.25pF	GJM0332C1E6R8CB01#	p157
				±0.5pF	GJM0332C1E6R8DB01#	p157
			6.9pF	±0.05pF	GJM0332C1E6R9WB01#	p157
				±0.1pF	GJM0332C1E6R9BB01#	p157
				±0.25pF	GJM0332C1E6R9CB01#	p157
				±0.5pF	GJM0332C1E6R9DB01#	p157
			7.0pF	±0.05pF	GJM0332C1E7ROWB01#	p157
				±0.1pF	GJM0332C1E7ROBB01#	p157
				±0.25pF	GJM0332C1E7ROCB01#	p157
				±0.5pF	GJM0332C1E7RODB01#	p157
			7.1pF	±0.05pF	GJM0332C1E7R1WB01#	p157
				±0.1pF	GJM0332C1E7R1BB01#	p157
				±0.25pF	GJM0332C1E7R1CB01#	p157
				±0.5pF	GJM0332C1E7R1DB01#	p157
			7.2pF	±0.05pF	GJM0332C1E7R2WB01#	p157
				±0.1pF	GJM0332C1E7R2BB01#	p157
				±0.25pF	GJM0332C1E7R2CB01#	p157
				±0.5pF	GJM0332C1E7R2DB01#	p157
			7.3pF	±0.05pF	GJM0332C1E7R3WB01#	p157
				±0.1pF	GJM0332C1E7R3BB01#	p157
				±0.25pF	GJM0332C1E7R3CB01#	p157
				±0.5pF	GJM0332C1E7R3DB01#	p157
			7.4pF	±0.05pF	GJM0332C1E7R4WB01#	p157
				±0.1pF	GJM0332C1E7R4BB01#	p157
				±0.25pF	GJM0332C1E7R4CB01#	p157
				±0.5pF	GJM0332C1E7R4DB01#	p157
			7.5pF	±0.05pF	GJM0332C1E7R5WB01#	p157
				±0.1pF	GJM0332C1E7R5BB01#	p157
				±0.25pF	GJM0332C1E7R5CB01#	p157
				±0.5pF	GJM0332C1E7R5DB01#	p157
			7.6pF	±0.05pF	GJM0332C1E7R6WB01#	p157
				±0.1pF	GJM0332C1E7R6BB01#	p157
				±0.25pF	GJM0332C1E7R6CB01#	p157
				±0.5pF	GJM0332C1E7R6DB01#	p157
			7.7pF	±0.05pF	GJM0332C1E7R7WB01#	p157
				±0.1pF	GJM0332C1E7R7BB01#	p157
				±0.25pF	GJM0332C1E7R7CB01#	p157
				±0.5pF	GJM0332C1E7R7DB01#	p157
			7.8pF	±0.05pF	GJM0332C1E7R8WB01#	p157
				±0.1pF	GJM0332C1E7R8BB01#	p157
				±0.25pF	GJM0332C1E7R8CB01#	p157
				±0.5pF	GJM0332C1E7R8DB01#	p157
			7.9pF	±0.05pF	GJM0332C1E7R9WB01#	p157
				±0.1pF	GJM0332C1E7R9BB01#	p157

T max.	Rated Voltage	TC Code	Cap.	Tol.	Part Number	p*
0.33mm	25Vdc	CH	7.9pF	±0.25pF	GJM0332C1E7R9CB01#	p157
				±0.5pF	GJM0332C1E7R9DB01#	p157
			8.0pF	±0.05pF	GJM0332C1E8ROWB01#	p157
				±0.1pF	GJM0332C1E8ROBB01#	p157
				±0.25pF	GJM0332C1E8ROCB01#	p157
				±0.5pF	GJM0332C1E8RODB01#	p157
			8.1pF	±0.05pF	GJM0332C1E8R1WB01#	p157
				±0.1pF	GJM0332C1E8R1BB01#	p157
				±0.25pF	GJM0332C1E8R1CB01#	p157
				±0.5pF	GJM0332C1E8R1DB01#	p157
			8.2pF	±0.05pF	GJM0332C1E8R2WB01#	p157
				±0.1pF	GJM0332C1E8R2BB01#	p157
				±0.25pF	GJM0332C1E8R2CB01#	p157
				±0.5pF	GJM0332C1E8R2DB01#	p157
			8.3pF	±0.05pF	GJM0332C1E8R3WB01#	p157
				±0.1pF	GJM0332C1E8R3BB01#	p157
				±0.25pF	GJM0332C1E8R3CB01#	p157
				±0.5pF	GJM0332C1E8R3DB01#	p157
			8.4pF	±0.05pF	GJM0332C1E8R4WB01#	p157
				±0.1pF	GJM0332C1E8R4BB01#	p157
				±0.25pF	GJM0332C1E8R4CB01#	p157
				±0.5pF	GJM0332C1E8R4DB01#	p157
			8.5pF	±0.05pF	GJM0332C1E8R5WB01#	p157
				±0.1pF	GJM0332C1E8R5BB01#	p157
				±0.25pF	GJM0332C1E8R5CB01#	p157
				±0.5pF	GJM0332C1E8R5DB01#	p157
			8.6pF	±0.05pF	GJM0332C1E8R6WB01#	p157
				±0.1pF	GJM0332C1E8R6BB01#	p157
				±0.25pF	GJM0332C1E8R6CB01#	p157
				±0.5pF	GJM0332C1E8R6DB01#	p157
			8.7pF	±0.05pF	GJM0332C1E8R7WB01#	p157
				±0.1pF	GJM0332C1E8R7BB01#	p157
				±0.25pF	GJM0332C1E8R7CB01#	p157
				±0.5pF	GJM0332C1E8R7DB01#	p157
			8.8pF	±0.05pF	GJM0332C1E8R8WB01#	p157
				±0.1pF	GJM0332C1E8R8BB01#	p157
				±0.25pF	GJM0332C1E8R8CB01#	p157
				±0.5pF	GJM0332C1E8R8DB01#	p157
			8.9pF	±0.05pF	GJM0332C1E8R9WB01#	p157
				±0.1pF	GJM0332C1E8R9BB01#	p157
				±0.25pF	GJM0332C1E8R9CB01#	p157
				±0.5pF	GJM0332C1E8R9DB01#	p157
			9.0pF	±0.05pF	GJM0332C1E9ROWB01#	p157
				±0.1pF	GJM0332C1E9ROBB01#	p157
				±0.25pF	GJM0332C1E9ROCB01#	p157
				±0.5pF	GJM0332C1E9RODB01#	p157
			9.1pF	±0.05pF	GJM0332C1E9R1WB01#	p157
				±0.1pF	GJM0332C1E9R1BB01#	p157
				±0.25pF	GJM0332C1E9R1CB01#	p157
				±0.5pF	GJM0332C1E9R1DB01#	p157
			9.2pF	±0.05pF	GJM0332C1E9R2WB01#	p157
				±0.1pF	GJM0332C1E9R2BB01#	p157
				±0.25pF	GJM0332C1E9R2CB01#	p157
				±0.5pF	GJM0332C1E9R2DB01#	p157

*: Refers to the page of the "Specifications and Test Methods".

Part number # indicates the package specification code.



GJM Series Temperature Compensating Type Part Number List

(→ 0.6×0.3mm)

T max.	Rated Voltage	TC Code	Cap.	Tol.	Part Number	p*
0.33mm	25Vdc	CH	9.3pF	±0.05pF	GJM0332C1E9R3WB01#	p157
				±0.1pF	GJM0332C1E9R3BB01#	p157
				±0.25pF	GJM0332C1E9R3CB01#	p157
				±0.5pF	GJM0332C1E9R3DB01#	p157
			9.4pF	±0.05pF	GJM0332C1E9R4WB01#	p157
				±0.1pF	GJM0332C1E9R4BB01#	p157
				±0.25pF	GJM0332C1E9R4CB01#	p157
				±0.5pF	GJM0332C1E9R4DB01#	p157
			9.5pF	±0.05pF	GJM0332C1E9R5WB01#	p157
				±0.1pF	GJM0332C1E9R5BB01#	p157
				±0.25pF	GJM0332C1E9R5CB01#	p157
				±0.5pF	GJM0332C1E9R5DB01#	p157
			9.6pF	±0.05pF	GJM0332C1E9R6WB01#	p157
				±0.1pF	GJM0332C1E9R6BB01#	p157
				±0.25pF	GJM0332C1E9R6CB01#	p157
				±0.5pF	GJM0332C1E9R6DB01#	p157
			9.7pF	±0.05pF	GJM0332C1E9R7WB01#	p157
				±0.1pF	GJM0332C1E9R7BB01#	p157
				±0.25pF	GJM0332C1E9R7CB01#	p157
				±0.5pF	GJM0332C1E9R7DB01#	p157
			9.8pF	±0.05pF	GJM0332C1E9R8WB01#	p157
				±0.1pF	GJM0332C1E9R8BB01#	p157
				±0.25pF	GJM0332C1E9R8CB01#	p157
				±0.5pF	GJM0332C1E9R8DB01#	p157
			9.9pF	±0.05pF	GJM0332C1E9R9WB01#	p157
				±0.1pF	GJM0332C1E9R9BB01#	p157
				±0.25pF	GJM0332C1E9R9CB01#	p157
				±0.5pF	GJM0332C1E9R9DB01#	p157
			10pF	±2%	GJM0332C1E100GB01#	p157
				±5%	GJM0332C1E100JB01#	p157
			11pF	±2%	GJM0332C1E110GB01#	p157
				±5%	GJM0332C1E110JB01#	p157
			12pF	±2%	GJM0332C1E120GB01#	p157
				±5%	GJM0332C1E120JB01#	p157
			13pF	±2%	GJM0332C1E130GB01#	p157
				±5%	GJM0332C1E130JB01#	p157
			15pF	±2%	GJM0332C1E150GB01#	p157
				±5%	GJM0332C1E150JB01#	p157
			16pF	±2%	GJM0332C1E160GB01#	p157
				±5%	GJM0332C1E160JB01#	p157
			18pF	±2%	GJM0332C1E180GB01#	p157
				±5%	GJM0332C1E180JB01#	p157
			20pF	±2%	GJM0332C1E200GB01#	p157
				±5%	GJM0332C1E200JB01#	p157
			22pF	±2%	GJM0332C1E220GB01#	p157
				±5%	GJM0332C1E220JB01#	p157
			24pF	±2%	GJM0332C1E240GB01#	p157
				±5%	GJM0332C1E240JB01#	p157
			27pF	±2%	GJM0332C1E270GB01#	p157
				±5%	GJM0332C1E270JB01#	p157
			30pF	±2%	GJM0332C1E300GB01#	p157
				±5%	GJM0332C1E300JB01#	p157
			33pF	±2%	GJM0332C1E330GB01#	p157
				±5%	GJM0332C1E330JB01#	p157

1.0×0.5mm

T max.	Rated Voltage	TC Code	Cap.	Tol.	Part Number	p*
0.55mm	50Vdc	COG	0.10pF	±0.05pF	GJM1555C1HR10WB01#	p157
				±0.1pF	GJM1555C1HR10BB01#	p157
			0.20pF	±0.05pF	GJM1555C1HR20WB01#	p157
				±0.1pF	GJM1555C1HR20BB01#	p157
			0.30pF	±0.05pF	GJM1555C1HR30WB01#	p157
				±0.1pF	GJM1555C1HR30BB01#	p157
			0.40pF	±0.05pF	GJM1555C1HR40WB01#	p157
				±0.1pF	GJM1555C1HR40BB01#	p157
			0.50pF	±0.05pF	GJM1555C1HR50WB01#	p157
				±0.1pF	GJM1555C1HR50BB01#	p157
			0.60pF	±0.05pF	GJM1555C1HR60WB01#	p157
				±0.1pF	GJM1555C1HR60BB01#	p157
			0.70pF	±0.05pF	GJM1555C1HR70WB01#	p157
				±0.1pF	GJM1555C1HR70BB01#	p157
			0.80pF	±0.05pF	GJM1555C1HR80WB01#	p157
				±0.1pF	GJM1555C1HR80BB01#	p157
			0.90pF	±0.05pF	GJM1555C1HR90WB01#	p157
				±0.1pF	GJM1555C1HR90BB01#	p157
			1.0pF	±0.05pF	GJM1555C1H1R0WB01#	p157
				±0.1pF	GJM1555C1H1R0BB01#	p157
				±0.25pF	GJM1555C1H1R0CB01#	p157
			1.1pF	±0.05pF	GJM1555C1H1R1WB01#	p157
				±0.1pF	GJM1555C1H1R1BB01#	p157
				±0.25pF	GJM1555C1H1R1CB01#	p157
			1.2pF	±0.05pF	GJM1555C1H1R2WB01#	p157
				±0.1pF	GJM1555C1H1R2BB01#	p157
				±0.25pF	GJM1555C1H1R2CB01#	p157
			1.3pF	±0.05pF	GJM1555C1H1R3WB01#	p157
				±0.1pF	GJM1555C1H1R3BB01#	p157
				±0.25pF	GJM1555C1H1R3CB01#	p157
			1.4pF	±0.05pF	GJM1555C1H1R4WB01#	p157
				±0.1pF	GJM1555C1H1R4BB01#	p157
				±0.25pF	GJM1555C1H1R4CB01#	p157
			1.5pF	±0.05pF	GJM1555C1H1R5WB01#	p157
				±0.1pF	GJM1555C1H1R5BB01#	p157
				±0.25pF	GJM1555C1H1R5CB01#	p157
			1.6pF	±0.05pF	GJM1555C1H1R6WB01#	p157
				±0.1pF	GJM1555C1H1R6BB01#	p157
				±0.25pF	GJM1555C1H1R6CB01#	p157
			1.7pF	±0.05pF	GJM1555C1H1R7WB01#	p157
±0.1pF	GJM1555C1H1R7BB01#	p157				
±0.25pF	GJM1555C1H1R7CB01#	p157				
1.8pF	±0.05pF	GJM1555C1H1R8WB01#	p157			
	±0.1pF	GJM1555C1H1R8BB01#	p157			
	±0.25pF	GJM1555C1H1R8CB01#	p157			
1.9pF	±0.05pF	GJM1555C1H1R9WB01#	p157			
	±0.1pF	GJM1555C1H1R9BB01#	p157			
	±0.25pF	GJM1555C1H1R9CB01#	p157			
2.0pF	±0.05pF	GJM1555C1H2R0WB01#	p157			
	±0.1pF	GJM1555C1H2R0BB01#	p157			
	±0.25pF	GJM1555C1H2R0CB01#	p157			
2.1pF	±0.05pF	GJM1555C1H2R1WB01#	p157			

*: Refers to the page of the "Specifications and Test Methods".

Part number # indicates the package specification code.

GJM Series Temperature Compensating Type Part Number List

(→ 1.0×0.5mm)

T max.	Rated Voltage	TC Code	Cap.	Tol.	Part Number	p*	T max.	Rated Voltage	TC Code	Cap.	Tol.	Part Number	p*
0.55mm	50Vdc	COG	2.1pF	±0.1pF	GJM1555C1H2R1BB01#	p157	0.55mm	50Vdc	COG	3.9pF	±0.1pF	GJM1555C1H3R9BB01#	p157
				±0.25pF	GJM1555C1H2R1CB01#	p157					±0.25pF	GJM1555C1H3R9CB01#	p157
			2.2pF	±0.05pF	GJM1555C1H2R2WB01#	p157				4.0pF	±0.05pF	GJM1555C1H4ROWB01#	p157
				±0.1pF	GJM1555C1H2R2BB01#	p157					±0.1pF	GJM1555C1H4R0BB01#	p157
				±0.25pF	GJM1555C1H2R2CB01#	p157					±0.25pF	GJM1555C1H4R0CB01#	p157
			2.3pF	±0.05pF	GJM1555C1H2R3WB01#	p157				4.1pF	±0.05pF	GJM1555C1H4R1WB01#	p157
				±0.1pF	GJM1555C1H2R3BB01#	p157					±0.1pF	GJM1555C1H4R1BB01#	p157
				±0.25pF	GJM1555C1H2R3CB01#	p157					±0.25pF	GJM1555C1H4R1CB01#	p157
			2.4pF	±0.05pF	GJM1555C1H2R4WB01#	p157				4.2pF	±0.05pF	GJM1555C1H4R2WB01#	p157
				±0.1pF	GJM1555C1H2R4BB01#	p157					±0.1pF	GJM1555C1H4R2BB01#	p157
				±0.25pF	GJM1555C1H2R4CB01#	p157					±0.25pF	GJM1555C1H4R2CB01#	p157
			2.5pF	±0.05pF	GJM1555C1H2R5WB01#	p157				4.3pF	±0.05pF	GJM1555C1H4R3WB01#	p157
				±0.1pF	GJM1555C1H2R5BB01#	p157					±0.1pF	GJM1555C1H4R3BB01#	p157
				±0.25pF	GJM1555C1H2R5CB01#	p157					±0.25pF	GJM1555C1H4R3CB01#	p157
			2.6pF	±0.05pF	GJM1555C1H2R6WB01#	p157				4.4pF	±0.05pF	GJM1555C1H4R4WB01#	p157
				±0.1pF	GJM1555C1H2R6BB01#	p157					±0.1pF	GJM1555C1H4R4BB01#	p157
				±0.25pF	GJM1555C1H2R6CB01#	p157					±0.25pF	GJM1555C1H4R4CB01#	p157
			2.7pF	±0.05pF	GJM1555C1H2R7WB01#	p157				4.5pF	±0.05pF	GJM1555C1H4R5WB01#	p157
				±0.1pF	GJM1555C1H2R7BB01#	p157					±0.1pF	GJM1555C1H4R5BB01#	p157
				±0.25pF	GJM1555C1H2R7CB01#	p157					±0.25pF	GJM1555C1H4R5CB01#	p157
			2.8pF	±0.05pF	GJM1555C1H2R8WB01#	p157	4.6pF	±0.05pF	GJM1555C1H4R6WB01#	p157			
				±0.1pF	GJM1555C1H2R8BB01#	p157		±0.1pF	GJM1555C1H4R6BB01#	p157			
				±0.25pF	GJM1555C1H2R8CB01#	p157		±0.25pF	GJM1555C1H4R6CB01#	p157			
			2.9pF	±0.05pF	GJM1555C1H2R9WB01#	p157	4.7pF	±0.05pF	GJM1555C1H4R7WB01#	p157			
				±0.1pF	GJM1555C1H2R9BB01#	p157		±0.1pF	GJM1555C1H4R7BB01#	p157			
				±0.25pF	GJM1555C1H2R9CB01#	p157		±0.25pF	GJM1555C1H4R7CB01#	p157			
			3.0pF	±0.05pF	GJM1555C1H3R0WB01#	p157	4.8pF	±0.05pF	GJM1555C1H4R8WB01#	p157			
				±0.1pF	GJM1555C1H3R0BB01#	p157		±0.1pF	GJM1555C1H4R8BB01#	p157			
				±0.25pF	GJM1555C1H3R0CB01#	p157		±0.25pF	GJM1555C1H4R8CB01#	p157			
			3.1pF	±0.05pF	GJM1555C1H3R1WB01#	p157	4.9pF	±0.05pF	GJM1555C1H4R9WB01#	p157			
				±0.1pF	GJM1555C1H3R1BB01#	p157		±0.1pF	GJM1555C1H4R9BB01#	p157			
				±0.25pF	GJM1555C1H3R1CB01#	p157		±0.25pF	GJM1555C1H4R9CB01#	p157			
			3.2pF	±0.05pF	GJM1555C1H3R2WB01#	p157	5.0pF	±0.05pF	GJM1555C1H5R0WB01#	p157			
				±0.1pF	GJM1555C1H3R2BB01#	p157		±0.1pF	GJM1555C1H5R0BB01#	p157			
				±0.25pF	GJM1555C1H3R2CB01#	p157		±0.25pF	GJM1555C1H5R0CB01#	p157			
			3.3pF	±0.05pF	GJM1555C1H3R3WB01#	p157	5.1pF	±0.05pF	GJM1555C1H5R1WB01#	p157			
				±0.1pF	GJM1555C1H3R3BB01#	p157		±0.1pF	GJM1555C1H5R1BB01#	p157			
				±0.25pF	GJM1555C1H3R3CB01#	p157		±0.25pF	GJM1555C1H5R1CB01#	p157			
			3.4pF	±0.05pF	GJM1555C1H3R4WB01#	p157	5.2pF	±0.05pF	GJM1555C1H5R2WB01#	p157			
				±0.1pF	GJM1555C1H3R4BB01#	p157		±0.1pF	GJM1555C1H5R2BB01#	p157			
				±0.25pF	GJM1555C1H3R4CB01#	p157		±0.25pF	GJM1555C1H5R2CB01#	p157			
			3.5pF	±0.05pF	GJM1555C1H3R5WB01#	p157	5.3pF	±0.05pF	GJM1555C1H5R3WB01#	p157			
				±0.1pF	GJM1555C1H3R5BB01#	p157		±0.1pF	GJM1555C1H5R3BB01#	p157			
				±0.25pF	GJM1555C1H3R5CB01#	p157		±0.25pF	GJM1555C1H5R3CB01#	p157			
			3.6pF	±0.05pF	GJM1555C1H3R6WB01#	p157	5.4pF	±0.05pF	GJM1555C1H5R4WB01#	p157			
				±0.1pF	GJM1555C1H3R6BB01#	p157		±0.1pF	GJM1555C1H5R4BB01#	p157			
				±0.25pF	GJM1555C1H3R6CB01#	p157		±0.25pF	GJM1555C1H5R4CB01#	p157			
			3.7pF	±0.05pF	GJM1555C1H3R7WB01#	p157	5.5pF	±0.05pF	GJM1555C1H5R5WB01#	p157			
				±0.1pF	GJM1555C1H3R7BB01#	p157		±0.1pF	GJM1555C1H5R5BB01#	p157			
				±0.25pF	GJM1555C1H3R7CB01#	p157		±0.25pF	GJM1555C1H5R5CB01#	p157			
			3.8pF	±0.05pF	GJM1555C1H3R8WB01#	p157	5.5pF	±0.05pF	GJM1555C1H5R5WB01#	p157			
				±0.1pF	GJM1555C1H3R8BB01#	p157		±0.1pF	GJM1555C1H5R5BB01#	p157			
				±0.25pF	GJM1555C1H3R8CB01#	p157		±0.25pF	GJM1555C1H5R5CB01#	p157			
			3.9pF	±0.05pF	GJM1555C1H3R9WB01#	p157	5.5pF	±0.05pF	GJM1555C1H5R5WB01#	p157			

*: Refers to the page of the "Specifications and Test Methods".

Part number # indicates the package specification code.



GJM Series Temperature Compensating Type Part Number List

(→ 1.0×0.5mm)

T max.	Rated Voltage	TC Code	Cap.	Tol.	Part Number	p*	T max.	Rated Voltage	TC Code	Cap.	Tol.	Part Number	p*
0.55mm	50Vdc	COG	5.5pF	±0.5pF	GJM1555C1H5R5DB01#	p157	0.55mm	50Vdc	COG	6.9pF	±0.1pF	GJM1555C1H6R9BB01#	p157
				±0.05pF	GJM1555C1H5R6WB01#	p157					±0.25pF	GJM1555C1H6R9CB01#	p157
			±0.1pF	GJM1555C1H5R6BB01#	p157	±0.5pF					GJM1555C1H6R9DB01#	p157	
			5.6pF	±0.25pF	GJM1555C1H5R6CB01#	p157				7.0pF	±0.05pF	GJM1555C1H7R0WB01#	p157
				±0.5pF	GJM1555C1H5R6DB01#	p157					±0.1pF	GJM1555C1H7R0BB01#	p157
				±0.05pF	GJM1555C1H5R7WB01#	p157					±0.25pF	GJM1555C1H7R0CB01#	p157
				±0.1pF	GJM1555C1H5R7BB01#	p157					±0.5pF	GJM1555C1H7R0DB01#	p157
			5.7pF	±0.25pF	GJM1555C1H5R7CB01#	p157				7.1pF	±0.05pF	GJM1555C1H7R1WB01#	p157
				±0.5pF	GJM1555C1H5R7DB01#	p157					±0.1pF	GJM1555C1H7R1BB01#	p157
				±0.05pF	GJM1555C1H5R8WB01#	p157					±0.25pF	GJM1555C1H7R1CB01#	p157
			5.8pF	±0.1pF	GJM1555C1H5R8BB01#	p157				7.2pF	±0.05pF	GJM1555C1H7R2WB01#	p157
				±0.25pF	GJM1555C1H5R8CB01#	p157					±0.1pF	GJM1555C1H7R2BB01#	p157
				±0.5pF	GJM1555C1H5R8DB01#	p157					±0.25pF	GJM1555C1H7R2CB01#	p157
				±0.05pF	GJM1555C1H5R9WB01#	p157					±0.5pF	GJM1555C1H7R2DB01#	p157
			5.9pF	±0.1pF	GJM1555C1H5R9BB01#	p157				7.3pF	±0.05pF	GJM1555C1H7R3WB01#	p157
				±0.25pF	GJM1555C1H5R9CB01#	p157					±0.1pF	GJM1555C1H7R3BB01#	p157
				±0.5pF	GJM1555C1H5R9DB01#	p157					±0.25pF	GJM1555C1H7R3CB01#	p157
				±0.05pF	GJM1555C1H6R0WB01#	p157					±0.5pF	GJM1555C1H7R3DB01#	p157
			6.0pF	±0.1pF	GJM1555C1H6R0BB01#	p157				7.4pF	±0.05pF	GJM1555C1H7R4WB01#	p157
				±0.25pF	GJM1555C1H6R0CB01#	p157					±0.1pF	GJM1555C1H7R4BB01#	p157
				±0.5pF	GJM1555C1H6R0DB01#	p157					±0.25pF	GJM1555C1H7R4CB01#	p157
				±0.05pF	GJM1555C1H6R1WB01#	p157					±0.5pF	GJM1555C1H7R4DB01#	p157
			6.1pF	±0.1pF	GJM1555C1H6R1BB01#	p157				7.5pF	±0.05pF	GJM1555C1H7R5WB01#	p157
				±0.25pF	GJM1555C1H6R1CB01#	p157					±0.1pF	GJM1555C1H7R5BB01#	p157
				±0.5pF	GJM1555C1H6R1DB01#	p157					±0.25pF	GJM1555C1H7R5CB01#	p157
				±0.05pF	GJM1555C1H6R2WB01#	p157					±0.5pF	GJM1555C1H7R5DB01#	p157
			6.2pF	±0.1pF	GJM1555C1H6R2BB01#	p157				7.6pF	±0.05pF	GJM1555C1H7R6WB01#	p157
				±0.25pF	GJM1555C1H6R2CB01#	p157					±0.1pF	GJM1555C1H7R6BB01#	p157
				±0.5pF	GJM1555C1H6R2DB01#	p157					±0.25pF	GJM1555C1H7R6CB01#	p157
				±0.05pF	GJM1555C1H6R3WB01#	p157					±0.5pF	GJM1555C1H7R6DB01#	p157
			6.3pF	±0.1pF	GJM1555C1H6R3BB01#	p157				7.7pF	±0.05pF	GJM1555C1H7R7WB01#	p157
				±0.25pF	GJM1555C1H6R3CB01#	p157					±0.1pF	GJM1555C1H7R7BB01#	p157
				±0.5pF	GJM1555C1H6R3DB01#	p157					±0.25pF	GJM1555C1H7R7CB01#	p157
				±0.05pF	GJM1555C1H6R4WB01#	p157					±0.5pF	GJM1555C1H7R7DB01#	p157
			6.4pF	±0.1pF	GJM1555C1H6R4BB01#	p157				7.8pF	±0.05pF	GJM1555C1H7R8WB01#	p157
				±0.25pF	GJM1555C1H6R4CB01#	p157					±0.1pF	GJM1555C1H7R8BB01#	p157
				±0.5pF	GJM1555C1H6R4DB01#	p157					±0.25pF	GJM1555C1H7R8CB01#	p157
				±0.05pF	GJM1555C1H6R5WB01#	p157					±0.5pF	GJM1555C1H7R8DB01#	p157
			6.5pF	±0.1pF	GJM1555C1H6R5BB01#	p157				7.9pF	±0.05pF	GJM1555C1H7R9WB01#	p157
				±0.25pF	GJM1555C1H6R5CB01#	p157					±0.1pF	GJM1555C1H7R9BB01#	p157
				±0.5pF	GJM1555C1H6R5DB01#	p157					±0.25pF	GJM1555C1H7R9CB01#	p157
				±0.05pF	GJM1555C1H6R6WB01#	p157					±0.5pF	GJM1555C1H7R9DB01#	p157
			6.6pF	±0.1pF	GJM1555C1H6R6BB01#	p157				8.0pF	±0.05pF	GJM1555C1H8R0WB01#	p157
				±0.25pF	GJM1555C1H6R6CB01#	p157					±0.1pF	GJM1555C1H8R0BB01#	p157
				±0.5pF	GJM1555C1H6R6DB01#	p157					±0.25pF	GJM1555C1H8R0CB01#	p157
				±0.05pF	GJM1555C1H6R7WB01#	p157					±0.5pF	GJM1555C1H8R0DB01#	p157
			6.7pF	±0.1pF	GJM1555C1H6R7BB01#	p157				8.1pF	±0.05pF	GJM1555C1H8R1WB01#	p157
				±0.25pF	GJM1555C1H6R7CB01#	p157					±0.1pF	GJM1555C1H8R1BB01#	p157
				±0.5pF	GJM1555C1H6R7DB01#	p157					±0.25pF	GJM1555C1H8R1CB01#	p157
				±0.05pF	GJM1555C1H6R8WB01#	p157					±0.5pF	GJM1555C1H8R1DB01#	p157
			6.8pF	±0.1pF	GJM1555C1H6R8BB01#	p157				8.2pF	±0.05pF	GJM1555C1H8R2WB01#	p157
				±0.25pF	GJM1555C1H6R8CB01#	p157					±0.1pF	GJM1555C1H8R2BB01#	p157
				±0.5pF	GJM1555C1H6R8DB01#	p157					±0.25pF	GJM1555C1H8R2CB01#	p157
				±0.05pF	GJM1555C1H6R9WB01#	p157							

*: Refers to the page of the "Specifications and Test Methods".

Part number # indicates the package specification code.

GRM
 GR3
 GRJ
 GR4
 GR7
 GJM
 GQM
 GA2
 GA3 GB
 GA3 GD
 GA3 GF
 LLL
 LLA
 LLM
 LLR
 NFM
 KRM
 KR3
 GMA
 GMD
 ⚠Caution /Notice

GJM Series Temperature Compensating Type Part Number List

(→ 1.0×0.5mm)

T max.	Rated Voltage	TC Code	Cap.	Tol.	Part Number	p*	T max.	Rated Voltage	TC Code	Cap.	Tol.	Part Number	p*	
0.55mm	50Vdc	COG	8.2pF	±0.5pF	GJM1555C1H8R2DB01#	p157	0.55mm	50Vdc	COG	9.6pF	±0.1pF	GJM1555C1H9R6BB01#	p157	
				±0.05pF	GJM1555C1H8R3WB01#	p157					±0.25pF	GJM1555C1H9R6CB01#	p157	
			8.3pF	±0.1pF	GJM1555C1H8R3BB01#	p157				9.7pF	±0.05pF	GJM1555C1H9R7WB01#	p157	
				±0.25pF	GJM1555C1H8R3CB01#	p157					±0.1pF	GJM1555C1H9R7BB01#	p157	
				±0.5pF	GJM1555C1H8R3DB01#	p157					±0.25pF	GJM1555C1H9R7CB01#	p157	
				±0.05pF	GJM1555C1H8R4WB01#	p157					±0.5pF	GJM1555C1H9R7DB01#	p157	
			8.4pF	±0.1pF	GJM1555C1H8R4BB01#	p157				9.8pF	±0.05pF	GJM1555C1H9R8WB01#	p157	
				±0.25pF	GJM1555C1H8R4CB01#	p157					±0.1pF	GJM1555C1H9R8BB01#	p157	
				±0.5pF	GJM1555C1H8R4DB01#	p157					±0.25pF	GJM1555C1H9R8CB01#	p157	
				±0.05pF	GJM1555C1H8R5WB01#	p157					±0.5pF	GJM1555C1H9R8DB01#	p157	
			8.5pF	±0.1pF	GJM1555C1H8R5BB01#	p157				9.9pF	±0.05pF	GJM1555C1H9R9WB01#	p157	
				±0.25pF	GJM1555C1H8R5CB01#	p157					±0.1pF	GJM1555C1H9R9BB01#	p157	
				±0.5pF	GJM1555C1H8R5DB01#	p157					±0.25pF	GJM1555C1H9R9CB01#	p157	
				±0.05pF	GJM1555C1H8R6WB01#	p157					±0.5pF	GJM1555C1H9R9DB01#	p157	
			8.6pF	±0.1pF	GJM1555C1H8R6BB01#	p157				10pF	±2%	GJM1555C1H100GB01#	p157	
				±0.25pF	GJM1555C1H8R6CB01#	p157					±5%	GJM1555C1H100JB01#	p157	
				±0.5pF	GJM1555C1H8R6DB01#	p157					11pF	±2%	GJM1555C1H110GB01#	p157
				±0.05pF	GJM1555C1H8R7WB01#	p157						±5%	GJM1555C1H110JB01#	p157
			±0.1pF	GJM1555C1H8R7BB01#	p157	12pF				±2%		GJM1555C1H120GB01#	p157	
			±0.25pF	GJM1555C1H8R7CB01#	p157					±5%		GJM1555C1H120JB01#	p157	
			±0.5pF	GJM1555C1H8R7DB01#	p157					13pF	±2%	GJM1555C1H130GB01#	p157	
			±0.05pF	GJM1555C1H8R8WB01#	p157						±5%	GJM1555C1H130JB01#	p157	
			±0.1pF	GJM1555C1H8R8BB01#	p157	15pF					±2%	GJM1555C1H150GB01#	p157	
			±0.25pF	GJM1555C1H8R8CB01#	p157						±5%	GJM1555C1H150JB01#	p157	
			±0.5pF	GJM1555C1H8R8DB01#	p157					16pF	±2%	GJM1555C1H160GB01#	p157	
			±0.05pF	GJM1555C1H8R9WB01#	p157						±5%	GJM1555C1H160JB01#	p157	
			±0.1pF	GJM1555C1H8R9BB01#	p157	18pF					±2%	GJM1555C1H180GB01#	p157	
			±0.25pF	GJM1555C1H8R9CB01#	p157						±5%	GJM1555C1H180JB01#	p157	
			±0.5pF	GJM1555C1H8R9DB01#	p157					20pF	±2%	GJM1555C1H200GB01#	p157	
			±0.05pF	GJM1555C1H9R0WB01#	p157						±5%	GJM1555C1H200JB01#	p157	
			±0.1pF	GJM1555C1H9R0BB01#	p157	22pF					±1%	GJM1555C1H220FB01#	p157	
			±0.25pF	GJM1555C1H9R0CB01#	p157						±2%	GJM1555C1H220GB01#	p157	
			±0.5pF	GJM1555C1H9R0DB01#	p157					±5%	GJM1555C1H220JB01#	p157		
			±0.05pF	GJM1555C1H9R1WB01#	p157					24pF	±1%	GJM1555C1H240FB01#	p157	
			±0.1pF	GJM1555C1H9R1BB01#	p157	±2%					GJM1555C1H240GB01#	p157		
			±0.25pF	GJM1555C1H9R1CB01#	p157	±5%					GJM1555C1H240JB01#	p157		
			±0.5pF	GJM1555C1H9R1DB01#	p157	27pF					±1%	GJM1555C1H270FB01#	p157	
			±0.05pF	GJM1555C1H9R2WB01#	p157					±2%	GJM1555C1H270GB01#	p157		
			±0.1pF	GJM1555C1H9R2BB01#	p157					±5%	GJM1555C1H270JB01#	p157		
			±0.25pF	GJM1555C1H9R2CB01#	p157					30pF	±1%	GJM1555C1H300FB01#	p157	
			±0.5pF	GJM1555C1H9R2DB01#	p157	±2%					GJM1555C1H300GB01#	p157		
			±0.05pF	GJM1555C1H9R3WB01#	p157	±5%					GJM1555C1H300JB01#	p157		
			±0.1pF	GJM1555C1H9R3BB01#	p157	33pF					±1%	GJM1555C1H330FB01#	p157	
			±0.25pF	GJM1555C1H9R3CB01#	p157					±2%	GJM1555C1H330GB01#	p157		
			±0.5pF	GJM1555C1H9R3DB01#	p157					±5%	GJM1555C1H330JB01#	p157		
			±0.05pF	GJM1555C1H9R4WB01#	p157					36pF	±1%	GJM1555C1H360FB01#	p157	
			±0.1pF	GJM1555C1H9R4BB01#	p157	±2%					GJM1555C1H360GB01#	p157		
			±0.25pF	GJM1555C1H9R4CB01#	p157	±5%					GJM1555C1H360JB01#	p157		
			±0.5pF	GJM1555C1H9R4DB01#	p157	39pF					±1%	GJM1555C1H390FB01#	p157	
			±0.05pF	GJM1555C1H9R5WB01#	p157					±2%	GJM1555C1H390GB01#	p157		
			±0.1pF	GJM1555C1H9R5BB01#	p157					±5%	GJM1555C1H390JB01#	p157		
			±0.25pF	GJM1555C1H9R5CB01#	p157					43pF	±1%	GJM1555C1H430FB01#	p157	
			±0.5pF	GJM1555C1H9R5DB01#	p157	±2%					GJM1555C1H430GB01#	p157		
			±0.05pF	GJM1555C1H9R6WB01#	p157									
			±0.1pF	GJM1555C1H9R6BB01#	p157									

*: Refers to the page of the "Specifications and Test Methods".

Part number # indicates the package specification code.



GJM Series Temperature Compensating Type Part Number List

(→ 1.0×0.5mm)

T max.	Rated Voltage	TC Code	Cap.	Tol.	Part Number	p*
0.55mm	50Vdc	COG	43pF	±5%	GJM1555C1H430JB01#	p157
				±1%	GJM1555C1H470FB01#	p157
					GJM1555C1H470GB01#	p157
					GJM1555C1H470JB01#	p157
		CK	0.10pF	±0.05pF	GJM1554C1HR10WB01#	p157
				±0.1pF	GJM1554C1HR10BB01#	p157
			0.20pF	±0.05pF	GJM1554C1HR20WB01#	p157
				±0.1pF	GJM1554C1HR20BB01#	p157
		0.30pF	±0.05pF	GJM1554C1HR30WB01#	p157	
			±0.1pF	GJM1554C1HR30BB01#	p157	
		0.40pF	±0.05pF	GJM1554C1HR40WB01#	p157	
			±0.1pF	GJM1554C1HR40BB01#	p157	
		0.50pF	±0.05pF	GJM1554C1HR50WB01#	p157	
			±0.1pF	GJM1554C1HR50BB01#	p157	
		0.60pF	±0.05pF	GJM1554C1HR60WB01#	p157	
			±0.1pF	GJM1554C1HR60BB01#	p157	
		0.70pF	±0.05pF	GJM1554C1HR70WB01#	p157	
			±0.1pF	GJM1554C1HR70BB01#	p157	
		0.80pF	±0.05pF	GJM1554C1HR80WB01#	p157	
			±0.1pF	GJM1554C1HR80BB01#	p157	
		0.90pF	±0.05pF	GJM1554C1HR90WB01#	p157	
			±0.1pF	GJM1554C1HR90BB01#	p157	
		1.0pF	±0.05pF	GJM1554C1H1R0WB01#	p157	
			±0.1pF	GJM1554C1H1R0BB01#	p157	
			±0.25pF	GJM1554C1H1R0CB01#	p157	
		1.1pF	±0.05pF	GJM1554C1H1R1WB01#	p157	
			±0.1pF	GJM1554C1H1R1BB01#	p157	
			±0.25pF	GJM1554C1H1R1CB01#	p157	
		1.2pF	±0.05pF	GJM1554C1H1R2WB01#	p157	
			±0.1pF	GJM1554C1H1R2BB01#	p157	
			±0.25pF	GJM1554C1H1R2CB01#	p157	
		1.3pF	±0.05pF	GJM1554C1H1R3WB01#	p157	
			±0.1pF	GJM1554C1H1R3BB01#	p157	
			±0.25pF	GJM1554C1H1R3CB01#	p157	
		1.4pF	±0.05pF	GJM1554C1H1R4WB01#	p157	
			±0.1pF	GJM1554C1H1R4BB01#	p157	
			±0.25pF	GJM1554C1H1R4CB01#	p157	
		1.5pF	±0.05pF	GJM1554C1H1R5WB01#	p157	
			±0.1pF	GJM1554C1H1R5BB01#	p157	
			±0.25pF	GJM1554C1H1R5CB01#	p157	
		1.6pF	±0.05pF	GJM1554C1H1R6WB01#	p157	
			±0.1pF	GJM1554C1H1R6BB01#	p157	
			±0.25pF	GJM1554C1H1R6CB01#	p157	
		1.7pF	±0.05pF	GJM1554C1H1R7WB01#	p157	
			±0.1pF	GJM1554C1H1R7BB01#	p157	
			±0.25pF	GJM1554C1H1R7CB01#	p157	
		1.8pF	±0.05pF	GJM1554C1H1R8WB01#	p157	
			±0.1pF	GJM1554C1H1R8BB01#	p157	
			±0.25pF	GJM1554C1H1R8CB01#	p157	
		1.9pF	±0.05pF	GJM1554C1H1R9WB01#	p157	
			±0.1pF	GJM1554C1H1R9BB01#	p157	
			±0.25pF	GJM1554C1H1R9CB01#	p157	
		2.0pF	±0.05pF	GJM1554C1H2R0WB01#	p157	
			±0.1pF	GJM1554C1H2R0BB01#	p157	

T max.	Rated Voltage	TC Code	Cap.	Tol.	Part Number	p*
0.55mm	50Vdc	CK	2.0pF	±0.25pF	GJM1554C1H2ROCB01#	p157
				CJ	2.1pF	±0.05pF
		±0.1pF	GJM1553C1H2R1BB01#	p157		
		2.2pF	±0.25pF	GJM1553C1H2R1CB01#	p157	
			±0.05pF	GJM1553C1H2R2WB01#	p157	
			±0.1pF	GJM1553C1H2R2BB01#	p157	
		±0.25pF	GJM1553C1H2R2CB01#	p157		
			2.3pF	±0.05pF	GJM1553C1H2R3WB01#	p157
		±0.1pF		GJM1553C1H2R3BB01#	p157	
		±0.25pF		GJM1553C1H2R3CB01#	p157	
		2.4pF	±0.05pF	GJM1553C1H2R4WB01#	p157	
			±0.1pF	GJM1553C1H2R4BB01#	p157	
			±0.25pF	GJM1553C1H2R4CB01#	p157	
		2.5pF	±0.05pF	GJM1553C1H2R5WB01#	p157	
			±0.1pF	GJM1553C1H2R5BB01#	p157	
			±0.25pF	GJM1553C1H2R5CB01#	p157	
		2.6pF	±0.05pF	GJM1553C1H2R6WB01#	p157	
			±0.1pF	GJM1553C1H2R6BB01#	p157	
			±0.25pF	GJM1553C1H2R6CB01#	p157	
		2.7pF	±0.05pF	GJM1553C1H2R7WB01#	p157	
			±0.1pF	GJM1553C1H2R7BB01#	p157	
			±0.25pF	GJM1553C1H2R7CB01#	p157	
		2.8pF	±0.05pF	GJM1553C1H2R8WB01#	p157	
			±0.1pF	GJM1553C1H2R8BB01#	p157	
			±0.25pF	GJM1553C1H2R8CB01#	p157	
		2.9pF	±0.05pF	GJM1553C1H2R9WB01#	p157	
			±0.1pF	GJM1553C1H2R9BB01#	p157	
			±0.25pF	GJM1553C1H2R9CB01#	p157	
		3.0pF	±0.05pF	GJM1553C1H3R0WB01#	p157	
			±0.1pF	GJM1553C1H3R0BB01#	p157	
			±0.25pF	GJM1553C1H3R0CB01#	p157	
		3.1pF	±0.05pF	GJM1553C1H3R1WB01#	p157	
			±0.1pF	GJM1553C1H3R1BB01#	p157	
			±0.25pF	GJM1553C1H3R1CB01#	p157	
		3.2pF	±0.05pF	GJM1553C1H3R2WB01#	p157	
			±0.1pF	GJM1553C1H3R2BB01#	p157	
			±0.25pF	GJM1553C1H3R2CB01#	p157	
		3.3pF	±0.05pF	GJM1553C1H3R3WB01#	p157	
			±0.1pF	GJM1553C1H3R3BB01#	p157	
			±0.25pF	GJM1553C1H3R3CB01#	p157	
		3.4pF	±0.05pF	GJM1553C1H3R4WB01#	p157	
			±0.1pF	GJM1553C1H3R4BB01#	p157	
			±0.25pF	GJM1553C1H3R4CB01#	p157	
		3.5pF	±0.05pF	GJM1553C1H3R5WB01#	p157	
			±0.1pF	GJM1553C1H3R5BB01#	p157	
			±0.25pF	GJM1553C1H3R5CB01#	p157	
		3.6pF	±0.05pF	GJM1553C1H3R6WB01#	p157	
			±0.1pF	GJM1553C1H3R6BB01#	p157	
			±0.25pF	GJM1553C1H3R6CB01#	p157	
		3.7pF	±0.05pF	GJM1553C1H3R7WB01#	p157	
			±0.1pF	GJM1553C1H3R7BB01#	p157	
			±0.25pF	GJM1553C1H3R7CB01#	p157	
		3.8pF	±0.05pF	GJM1553C1H3R8WB01#	p157	
			±0.1pF	GJM1553C1H3R8BB01#	p157	

*: Refers to the page of the "Specifications and Test Methods".

Part number # indicates the package specification code.

GJM Series Temperature Compensating Type Part Number List

(→ 1.0×0.5mm)

T max.	Rated Voltage	TC Code	Cap.	Tol.	Part Number	p*	T max.	Rated Voltage	TC Code	Cap.	Tol.	Part Number	p*
0.55mm	50Vdc	CJ	3.8pF	±0.25pF	GJM1553C1H3R8CB01#	p157	0.55mm	50Vdc	CH	5.5pF	±0.1pF	GJM1552C1H5R5BB01#	p157
				±0.05pF	GJM1553C1H3R9WB01#	p157					±0.25pF	GJM1552C1H5R5CB01#	p157
				±0.1pF	GJM1553C1H3R9BB01#	p157					±0.5pF	GJM1552C1H5R5DB01#	p157
				±0.25pF	GJM1553C1H3R9CB01#	p157					5.6pF	±0.05pF	GJM1552C1H5R6WB01#
		4.0pF	±0.05pF	GJM1552C1H4R0WB01#	p157	±0.1pF				GJM1552C1H5R6BB01#		p157	
			±0.1pF	GJM1552C1H4R0BB01#	p157	±0.25pF				GJM1552C1H5R6CB01#		p157	
			±0.25pF	GJM1552C1H4R0CB01#	p157	±0.5pF				GJM1552C1H5R6DB01#		p157	
		4.1pF	±0.05pF	GJM1552C1H4R1WB01#	p157	5.7pF				±0.05pF	GJM1552C1H5R7WB01#	p157	
			±0.1pF	GJM1552C1H4R1BB01#	p157					±0.1pF	GJM1552C1H5R7BB01#	p157	
			±0.25pF	GJM1552C1H4R1CB01#	p157					±0.25pF	GJM1552C1H5R7CB01#	p157	
		±0.5pF	GJM1552C1H5R7DB01#	p157	5.8pF					±0.05pF	GJM1552C1H5R8WB01#	p157	
		4.2pF	±0.05pF	GJM1552C1H4R2WB01#		p157				±0.1pF	GJM1552C1H5R8BB01#	p157	
			±0.1pF	GJM1552C1H4R2BB01#		p157				±0.25pF	GJM1552C1H5R8CB01#	p157	
			±0.25pF	GJM1552C1H4R2CB01#		p157				±0.5pF	GJM1552C1H5R8DB01#	p157	
		4.3pF	±0.05pF	GJM1552C1H4R3WB01#	p157	5.9pF				±0.05pF	GJM1552C1H5R9WB01#	p157	
			±0.1pF	GJM1552C1H4R3BB01#	p157					±0.1pF	GJM1552C1H5R9BB01#	p157	
			±0.25pF	GJM1552C1H4R3CB01#	p157					±0.25pF	GJM1552C1H5R9CB01#	p157	
		±0.5pF	GJM1552C1H5R9DB01#	p157	6.0pF					±0.05pF	GJM1552C1H6R0WB01#	p157	
		4.4pF	±0.05pF	GJM1552C1H4R4WB01#		p157				±0.1pF	GJM1552C1H6R0BB01#	p157	
			±0.1pF	GJM1552C1H4R4BB01#		p157				±0.25pF	GJM1552C1H6R0CB01#	p157	
			±0.25pF	GJM1552C1H4R4CB01#		p157				±0.5pF	GJM1552C1H6R0DB01#	p157	
		4.5pF	±0.05pF	GJM1552C1H4R5WB01#	p157	6.1pF				±0.05pF	GJM1552C1H6R1WB01#	p157	
			±0.1pF	GJM1552C1H4R5BB01#	p157					±0.1pF	GJM1552C1H6R1BB01#	p157	
			±0.25pF	GJM1552C1H4R5CB01#	p157					±0.25pF	GJM1552C1H6R1CB01#	p157	
		±0.5pF	GJM1552C1H6R1DB01#	p157	6.2pF					±0.05pF	GJM1552C1H6R2WB01#	p157	
		4.6pF	±0.05pF	GJM1552C1H4R6WB01#		p157				±0.1pF	GJM1552C1H6R2BB01#	p157	
			±0.1pF	GJM1552C1H4R6BB01#		p157				±0.25pF	GJM1552C1H6R2CB01#	p157	
			±0.25pF	GJM1552C1H4R6CB01#		p157				±0.5pF	GJM1552C1H6R2DB01#	p157	
		4.7pF	±0.05pF	GJM1552C1H4R7WB01#	p157	6.3pF				±0.05pF	GJM1552C1H6R3WB01#	p157	
			±0.1pF	GJM1552C1H4R7BB01#	p157					±0.1pF	GJM1552C1H6R3BB01#	p157	
			±0.25pF	GJM1552C1H4R7CB01#	p157					±0.25pF	GJM1552C1H6R3CB01#	p157	
		±0.5pF	GJM1552C1H6R3DB01#	p157	6.4pF					±0.05pF	GJM1552C1H6R4WB01#	p157	
		4.8pF	±0.05pF	GJM1552C1H4R8WB01#		p157				±0.1pF	GJM1552C1H6R4BB01#	p157	
			±0.1pF	GJM1552C1H4R8BB01#		p157				±0.25pF	GJM1552C1H6R4CB01#	p157	
			±0.25pF	GJM1552C1H4R8CB01#		p157				±0.5pF	GJM1552C1H6R4DB01#	p157	
		4.9pF	±0.05pF	GJM1552C1H4R9WB01#	p157	6.5pF				±0.05pF	GJM1552C1H6R5WB01#	p157	
			±0.1pF	GJM1552C1H4R9BB01#	p157					±0.1pF	GJM1552C1H6R5BB01#	p157	
			±0.25pF	GJM1552C1H4R9CB01#	p157					±0.25pF	GJM1552C1H6R5CB01#	p157	
		±0.5pF	GJM1552C1H6R5DB01#	p157	6.6pF					±0.05pF	GJM1552C1H6R6WB01#	p157	
		5.0pF	±0.05pF	GJM1552C1H5R0WB01#		p157				±0.1pF	GJM1552C1H6R6BB01#	p157	
			±0.1pF	GJM1552C1H5R0BB01#		p157				±0.25pF	GJM1552C1H6R6CB01#	p157	
			±0.25pF	GJM1552C1H5R0CB01#		p157				±0.5pF	GJM1552C1H6R6DB01#	p157	
		5.1pF	±0.05pF	GJM1552C1H5R1WB01#	p157	6.7pF				±0.05pF	GJM1552C1H6R7WB01#	p157	
			±0.1pF	GJM1552C1H5R1BB01#	p157					±0.1pF	GJM1552C1H6R7BB01#	p157	
			±0.25pF	GJM1552C1H5R1CB01#	p157					±0.25pF	GJM1552C1H6R7CB01#	p157	
		±0.5pF	GJM1552C1H6R7DB01#	p157	6.8pF					±0.05pF	GJM1552C1H6R8WB01#	p157	
		5.2pF	±0.05pF	GJM1552C1H5R2WB01#		p157				±0.1pF	GJM1552C1H6R8BB01#	p157	
			±0.1pF	GJM1552C1H5R2BB01#		p157				±0.25pF	GJM1552C1H6R8CB01#	p157	
			±0.25pF	GJM1552C1H5R2CB01#		p157				±0.5pF	GJM1552C1H6R8DB01#	p157	
		5.3pF	±0.05pF	GJM1552C1H5R3WB01#	p157	5.5pF				±0.05pF	GJM1552C1H5R5WB01#	p157	
			±0.1pF	GJM1552C1H5R3BB01#	p157					5.5pF	±0.05pF	GJM1552C1H5R5WB01#	p157
			±0.25pF	GJM1552C1H5R3CB01#	p157						±0.1pF	GJM1552C1H5R5BB01#	p157
		±0.5pF	GJM1552C1H5R3DB01#	p157	±0.25pF						GJM1552C1H5R5CB01#	p157	
		5.4pF	±0.05pF	GJM1552C1H5R4WB01#	p157	±0.5pF				GJM1552C1H5R5DB01#	p157		
			±0.1pF	GJM1552C1H5R4BB01#	p157	5.5pF				±0.05pF	GJM1552C1H5R5WB01#	p157	
			±0.25pF	GJM1552C1H5R4CB01#	p157					±0.1pF	GJM1552C1H5R5BB01#	p157	
		±0.5pF	GJM1552C1H5R4DB01#	p157	±0.25pF					GJM1552C1H5R5CB01#	p157		

*: Refers to the page of the "Specifications and Test Methods".

Part number # indicates the package specification code.

GJM Series Temperature Compensating Type Part Number List

(→ 1.0×0.5mm)

T max.	Rated Voltage	TC Code	Cap.	Tol.	Part Number	p*
0.55mm	50Vdc	CH	6.8pF	±0.5pF	GJM1552C1H6R8DB01#	p157
				±0.05pF	GJM1552C1H6R9WB01#	p157
			6.9pF	±0.1pF	GJM1552C1H6R9BB01#	p157
				±0.25pF	GJM1552C1H6R9CB01#	p157
				±0.5pF	GJM1552C1H6R9DB01#	p157
				7.0pF	±0.05pF	GJM1552C1H7R0WB01#
			±0.1pF		GJM1552C1H7R0BB01#	p157
			±0.25pF		GJM1552C1H7R0CB01#	p157
			±0.5pF		GJM1552C1H7R0DB01#	p157
			7.1pF	±0.05pF	GJM1552C1H7R1WB01#	p157
				±0.1pF	GJM1552C1H7R1BB01#	p157
				±0.25pF	GJM1552C1H7R1CB01#	p157
				±0.5pF	GJM1552C1H7R1DB01#	p157
			7.2pF	±0.05pF	GJM1552C1H7R2WB01#	p157
				±0.1pF	GJM1552C1H7R2BB01#	p157
				±0.25pF	GJM1552C1H7R2CB01#	p157
				±0.5pF	GJM1552C1H7R2DB01#	p157
			7.3pF	±0.05pF	GJM1552C1H7R3WB01#	p157
				±0.1pF	GJM1552C1H7R3BB01#	p157
				±0.25pF	GJM1552C1H7R3CB01#	p157
				±0.5pF	GJM1552C1H7R3DB01#	p157
			7.4pF	±0.05pF	GJM1552C1H7R4WB01#	p157
				±0.1pF	GJM1552C1H7R4BB01#	p157
				±0.25pF	GJM1552C1H7R4CB01#	p157
				±0.5pF	GJM1552C1H7R4DB01#	p157
			7.5pF	±0.05pF	GJM1552C1H7R5WB01#	p157
				±0.1pF	GJM1552C1H7R5BB01#	p157
				±0.25pF	GJM1552C1H7R5CB01#	p157
				±0.5pF	GJM1552C1H7R5DB01#	p157
			7.6pF	±0.05pF	GJM1552C1H7R6WB01#	p157
				±0.1pF	GJM1552C1H7R6BB01#	p157
				±0.25pF	GJM1552C1H7R6CB01#	p157
				±0.5pF	GJM1552C1H7R6DB01#	p157
			7.7pF	±0.05pF	GJM1552C1H7R7WB01#	p157
				±0.1pF	GJM1552C1H7R7BB01#	p157
				±0.25pF	GJM1552C1H7R7CB01#	p157
				±0.5pF	GJM1552C1H7R7DB01#	p157
			7.8pF	±0.05pF	GJM1552C1H7R8WB01#	p157
				±0.1pF	GJM1552C1H7R8BB01#	p157
				±0.25pF	GJM1552C1H7R8CB01#	p157
				±0.5pF	GJM1552C1H7R8DB01#	p157
			7.9pF	±0.05pF	GJM1552C1H7R9WB01#	p157
				±0.1pF	GJM1552C1H7R9BB01#	p157
				±0.25pF	GJM1552C1H7R9CB01#	p157
				±0.5pF	GJM1552C1H7R9DB01#	p157
			8.0pF	±0.05pF	GJM1552C1H8R0WB01#	p157
				±0.1pF	GJM1552C1H8R0BB01#	p157
				±0.25pF	GJM1552C1H8R0CB01#	p157
				±0.5pF	GJM1552C1H8R0DB01#	p157
			8.1pF	±0.05pF	GJM1552C1H8R1WB01#	p157
				±0.1pF	GJM1552C1H8R1BB01#	p157
				±0.25pF	GJM1552C1H8R1CB01#	p157
				±0.5pF	GJM1552C1H8R1DB01#	p157
			8.2pF	±0.05pF	GJM1552C1H8R2WB01#	p157

T max.	Rated Voltage	TC Code	Cap.	Tol.	Part Number	p*
0.55mm	50Vdc	CH	8.2pF	±0.1pF	GJM1552C1H8R2BB01#	p157
				±0.25pF	GJM1552C1H8R2CB01#	p157
				±0.5pF	GJM1552C1H8R2DB01#	p157
			8.3pF	±0.05pF	GJM1552C1H8R3WB01#	p157
				±0.1pF	GJM1552C1H8R3BB01#	p157
				±0.25pF	GJM1552C1H8R3CB01#	p157
			8.4pF	±0.05pF	GJM1552C1H8R4WB01#	p157
				±0.1pF	GJM1552C1H8R4BB01#	p157
				±0.25pF	GJM1552C1H8R4CB01#	p157
			8.5pF	±0.05pF	GJM1552C1H8R5WB01#	p157
				±0.1pF	GJM1552C1H8R5BB01#	p157
				±0.25pF	GJM1552C1H8R5CB01#	p157
			8.6pF	±0.05pF	GJM1552C1H8R6WB01#	p157
				±0.1pF	GJM1552C1H8R6BB01#	p157
				±0.25pF	GJM1552C1H8R6CB01#	p157
			8.7pF	±0.05pF	GJM1552C1H8R7WB01#	p157
				±0.1pF	GJM1552C1H8R7BB01#	p157
				±0.25pF	GJM1552C1H8R7CB01#	p157
			8.8pF	±0.05pF	GJM1552C1H8R8WB01#	p157
				±0.1pF	GJM1552C1H8R8BB01#	p157
				±0.25pF	GJM1552C1H8R8CB01#	p157
			8.9pF	±0.05pF	GJM1552C1H8R9WB01#	p157
				±0.1pF	GJM1552C1H8R9BB01#	p157
				±0.25pF	GJM1552C1H8R9CB01#	p157
			9.0pF	±0.05pF	GJM1552C1H9R0WB01#	p157
				±0.1pF	GJM1552C1H9R0BB01#	p157
				±0.25pF	GJM1552C1H9R0CB01#	p157
			9.1pF	±0.05pF	GJM1552C1H9R1WB01#	p157
				±0.1pF	GJM1552C1H9R1BB01#	p157
				±0.25pF	GJM1552C1H9R1CB01#	p157
			9.2pF	±0.05pF	GJM1552C1H9R2WB01#	p157
				±0.1pF	GJM1552C1H9R2BB01#	p157
				±0.25pF	GJM1552C1H9R2CB01#	p157
			9.3pF	±0.05pF	GJM1552C1H9R3WB01#	p157
				±0.1pF	GJM1552C1H9R3BB01#	p157
				±0.25pF	GJM1552C1H9R3CB01#	p157
			9.4pF	±0.05pF	GJM1552C1H9R4WB01#	p157
				±0.1pF	GJM1552C1H9R4BB01#	p157
				±0.25pF	GJM1552C1H9R4CB01#	p157
			9.5pF	±0.05pF	GJM1552C1H9R5WB01#	p157
				±0.1pF	GJM1552C1H9R5BB01#	p157
				±0.25pF	GJM1552C1H9R5CB01#	p157

*: Refers to the page of the "Specifications and Test Methods".

Part number # indicates the package specification code.

GJM Series Temperature Compensating Type Part Number List

(→ 1.0×0.5mm)

T max.	Rated Voltage	TC Code	Cap.	Tol.	Part Number	p*
0.55mm	50Vdc	CH	9.5pF	±0.5pF	GJM1552C1H9R5DB01#	p157
				±0.05pF	GJM1552C1H9R6WB01#	p157
			9.6pF	±0.1pF	GJM1552C1H9R6BB01#	p157
				±0.25pF	GJM1552C1H9R6CB01#	p157
				±0.5pF	GJM1552C1H9R6DB01#	p157
				9.7pF	±0.05pF	GJM1552C1H9R7WB01#
			±0.1pF		GJM1552C1H9R7BB01#	p157
			±0.25pF		GJM1552C1H9R7CB01#	p157
			9.8pF	±0.5pF	GJM1552C1H9R7DB01#	p157
				±0.05pF	GJM1552C1H9R8WB01#	p157
				±0.1pF	GJM1552C1H9R8BB01#	p157
			9.9pF	±0.25pF	GJM1552C1H9R8CB01#	p157
				±0.5pF	GJM1552C1H9R8DB01#	p157
				±0.05pF	GJM1552C1H9R9WB01#	p157
				±0.1pF	GJM1552C1H9R9BB01#	p157
			10pF	±0.25pF	GJM1552C1H9R9CB01#	p157
				±0.5pF	GJM1552C1H9R9DB01#	p157
				±2%	GJM1552C1H100GB01#	p157
			11pF	±5%	GJM1552C1H100JB01#	p157
				±2%	GJM1552C1H110GB01#	p157
			12pF	±5%	GJM1552C1H110JB01#	p157
				±2%	GJM1552C1H120GB01#	p157
			13pF	±5%	GJM1552C1H120JB01#	p157
				±2%	GJM1552C1H130GB01#	p157
			15pF	±5%	GJM1552C1H130JB01#	p157
				±2%	GJM1552C1H150GB01#	p157
			16pF	±5%	GJM1552C1H150JB01#	p157
				±2%	GJM1552C1H160GB01#	p157
			18pF	±5%	GJM1552C1H160JB01#	p157
				±2%	GJM1552C1H180GB01#	p157
			20pF	±5%	GJM1552C1H180JB01#	p157
				±2%	GJM1552C1H200GB01#	p157
			22pF	±5%	GJM1552C1H200JB01#	p157
				±1%	GJM1552C1H220FB01#	p157
				±2%	GJM1552C1H220GB01#	p157
			24pF	±5%	GJM1552C1H220JB01#	p157
				±1%	GJM1552C1H240FB01#	p157
				±2%	GJM1552C1H240GB01#	p157
			27pF	±5%	GJM1552C1H240JB01#	p157
				±1%	GJM1552C1H270FB01#	p157
				±2%	GJM1552C1H270GB01#	p157
			30pF	±5%	GJM1552C1H270JB01#	p157
				±1%	GJM1552C1H300FB01#	p157
				±2%	GJM1552C1H300GB01#	p157
			33pF	±5%	GJM1552C1H300JB01#	p157
				±1%	GJM1552C1H330FB01#	p157
				±2%	GJM1552C1H330GB01#	p157
			36pF	±5%	GJM1552C1H330JB01#	p157
				±1%	GJM1552C1H360FB01#	p157
				±2%	GJM1552C1H360GB01#	p157
			39pF	±5%	GJM1552C1H360JB01#	p157
				±1%	GJM1552C1H390FB01#	p157
±2%	GJM1552C1H390GB01#	p157				
			±5%	GJM1552C1H390JB01#	p157	

T max.	Rated Voltage	TC Code	Cap.	Tol.	Part Number	p*
0.55mm	50Vdc	CH	43pF	±1%	GJM1552C1H430FB01#	p157
				±2%	GJM1552C1H430GB01#	p157
				±5%	GJM1552C1H430JB01#	p157
			47pF	±1%	GJM1552C1H470FB01#	p157
				±2%	GJM1552C1H470GB01#	p157
				±5%	GJM1552C1H470JB01#	p157

*: Refers to the page of the "Specifications and Test Methods".

Part number # indicates the package specification code.



1

GJM Series Specifications and Test Methods (1)

No	Item	Specification	Test Method (Ref. Standard: JIS C 5101, IEC60384)												
1	Rated Voltage	Shown in Rated value.	The rated voltage is defined as the maximum voltage which may be applied continuously to the capacitor. When AC voltage is superimposed on DC voltage, V^P -P or V^O -P, whichever is larger, should be maintained within the rated voltage range.												
2	Appearance	No defects or abnormalities.	Visual inspection.												
3	Dimension	Within the specified dimensions.	Using Measuring instrument of dimension.												
4	Impulse Voltage	No defects or abnormalities.	Measurement Point: Between the terminations Test Voltage: 300% of the rated voltage Applied Time: 1 to 5s Charge/discharge current: 50mA max.												
5	Insulation Resistance (I.R.)	$C \leq 0.047\mu\text{F}$: More than 10000MΩ $C > 0.047\mu\text{F}$: More than $500\Omega \cdot \text{F}$ C: Nominal Capacitance	Measurement Point: Between the terminations Measurement Voltage: DC Rated Voltage Charging Time: 2min Charge/discharge current: 50mA max. Measurement Temperature: Room Temperature												
6	Capacitance	Shown in Rated value.	Measurement Temperature: Room Temperature												
7	Q	30pF and over: $Q \geq 1000$ 30pF and below: $Q \geq 400+20C$ C: Nominal Capacitance (pF)	<table border="1"> <thead> <tr> <th>Capacitance</th> <th>Frequency</th> <th>Voltage</th> </tr> </thead> <tbody> <tr> <td>$C \leq 1000\text{pF}$</td> <td>1.0±0.1MHz</td> <td>0.5 to 5.0Vrms</td> </tr> </tbody> </table>	Capacitance	Frequency	Voltage	$C \leq 1000\text{pF}$	1.0±0.1MHz	0.5 to 5.0Vrms						
Capacitance	Frequency	Voltage													
$C \leq 1000\text{pF}$	1.0±0.1MHz	0.5 to 5.0Vrms													
8	Temperature Characteristics of Capacitance	Nominal values of the temperature coefficient is shown in Rated value. But, the Capacitance Change under 20°C is shown in Table A. Capacitance Drift Within ±0.2% or ±0.05pF (Whichever is larger.)	The capacitance change should be measured after 5 minutes at each specified temp. stage. Capacitance value as a reference is the value in step 3. The capacitance drift is calculated by dividing the differences between the maximum and minimum measured values in the step 1, 3 and 5 by the cap. value in step 3. <table border="1"> <thead> <tr> <th>Step</th> <th>Temperature (°C)</th> </tr> </thead> <tbody> <tr> <td>1</td> <td>Reference Temp. ±2</td> </tr> <tr> <td>2</td> <td>Min. Operating Temp. ±3</td> </tr> <tr> <td>3</td> <td>Reference Temp. ±2</td> </tr> <tr> <td>4</td> <td>Max. Operating Temp. ±3</td> </tr> <tr> <td>5</td> <td>Reference Temp. ±2</td> </tr> </tbody> </table>	Step	Temperature (°C)	1	Reference Temp. ±2	2	Min. Operating Temp. ±3	3	Reference Temp. ±2	4	Max. Operating Temp. ±3	5	Reference Temp. ±2
Step	Temperature (°C)														
1	Reference Temp. ±2														
2	Min. Operating Temp. ±3														
3	Reference Temp. ±2														
4	Max. Operating Temp. ±3														
5	Reference Temp. ±2														
9	Adhesive Strength of Termination	No removal of the terminations or other defect should occur.	Solder the capacitor on the test substrate shown in Fig.3. <table border="1"> <thead> <tr> <th>Type</th> <th>Applied Force (N)</th> </tr> </thead> <tbody> <tr> <td>GJM02</td> <td>1</td> </tr> <tr> <td>GJM03</td> <td>2</td> </tr> <tr> <td>GJM15</td> <td>5</td> </tr> </tbody> </table> Holding Time: 10±1s Applied Direction: In parallel with the test substrate and vertical with the capacitor side.	Type	Applied Force (N)	GJM02	1	GJM03	2	GJM15	5				
Type	Applied Force (N)														
GJM02	1														
GJM03	2														
GJM15	5														
10	Vibration	Appearance	Solder the capacitor on the test substrate shown in Fig.3. Kind of Vibration: A simple harmonic motion 10Hz to 55Hz to 10Hz (1min) Total amplitude: 1.5mm This motion should be applied for a period of 2h in each 3 mutually perpendicular directions (total of 6h).												
		Capacitance													
		Q													
11	Substrate Bending Test	Appearance	Solder the capacitor on the test substrate shown in Fig.1. Pressurization method: Shown in Fig.2 Flexure: 1mm Holding Time: 5±1s Soldering Method: Reflow soldering												
		Capacitance Change													
12	Solderability	95% of the terminations is to be soldered evenly and continuously.	Test Method: Solder bath method Flux: Solution of rosin ethanol 25 (mass)% Preheat: 80 to 120°C for 10 to 30s Solder: Sn-3.0Ag-0.5Cu Solder Temp.: 245±5°C Immersion time: 2±0.5s												

Continued on the following page. ↗

GRM
GR3
GRJ
GR4
GR7
GJM
GQM
GA2
GA3 GB
GA3 GD
GA3 GF
LLL
LLA
LLM
LLR
NFM
KPM
KR3
GMA
GMD
⚠Caution / Notice

GJM Series Specifications and Test Methods (1)

Continued from the preceding page. ↘

No	Item	Specification	Test Method (Ref. Standard: JIS C 5101, IEC60384)															
13	Resistance to Soldering Heat	Appearance	No defects or abnormalities.															
		Capacitance Change	Within $\pm 2.5\%$ or $\pm 0.25\text{pF}$ (Whichever is larger)															
		Q	Within the specified initial value.															
		I.R.	Within the specified initial value.															
		Voltage Proof	No defects.															
14	Temperature Sudden Change	Appearance	No defects or abnormalities.															
		Capacitance Change	Within $\pm 2.5\%$ or $\pm 0.25\text{pF}$ (Whichever is larger)															
		Q	Within the specified initial value.															
		I.R.	Within the specified initial value.															
		Voltage Proof	No defects.															
			Solder the capacitor on the test substrate shown in Fig.3. Perform the five cycles according to the four heat treatments shown in the following table. <table border="1" style="margin-left: 20px;"> <thead> <tr> <th>Step</th> <th>Temp. (°C)</th> <th>Time (min)</th> </tr> </thead> <tbody> <tr> <td>1</td> <td>Min. Operating Temp. +0/-3</td> <td>30±3</td> </tr> <tr> <td>2</td> <td>Room Temp.</td> <td>2 to 3</td> </tr> <tr> <td>3</td> <td>Max. Operating Temp. +3/-0</td> <td>30±3</td> </tr> <tr> <td>4</td> <td>Room Temp.</td> <td>2 to 3</td> </tr> </tbody> </table> Exposure Time: 24±2h	Step	Temp. (°C)	Time (min)	1	Min. Operating Temp. +0/-3	30±3	2	Room Temp.	2 to 3	3	Max. Operating Temp. +3/-0	30±3	4	Room Temp.	2 to 3
Step	Temp. (°C)	Time (min)																
1	Min. Operating Temp. +0/-3	30±3																
2	Room Temp.	2 to 3																
3	Max. Operating Temp. +3/-0	30±3																
4	Room Temp.	2 to 3																
15	High Temperature High Humidity (Steady)	Appearance	No defects or abnormalities.															
		Capacitance Change	Within $\pm 7.5\%$ or $\pm 0.75\text{pF}$ (Whichever is larger)															
		Q	30pF and over: $Q \geq 200$ 30pF and below: $Q \geq 100+10C/3$ C: Nominal Capacitance (pF)															
		I.R.	More than 500MΩ or 25Ω · F (Whichever is smaller)															
16	Durability	Appearance	No defects or abnormalities.															
		Capacitance Change	Within $\pm 3\%$ or $\pm 0.3\text{pF}$ (Whichever is larger)															
		Q	30pF and over: $Q \geq 350$ 10pF and over, 30pF and below: $Q \geq 275+5C/2$ 10pF and below: $Q \geq 200+10C$ C: Nominal Capacitance (pF)															
		I.R.	More than 1000MΩ or 50Ω · F (Whichever is smaller)															
17	ESR (GJM02)	0.2pF < C ≤ 1pF: 700mΩ/C below 1pF < C ≤ 2pF: 600mΩ below 2pF < C ≤ 5pF: 500mΩ below 5pF < C ≤ 10pF: 300mΩ below 10pF < C ≤ 22pF: 350mΩ below C: Nominal Capacitance (pF)	Measurement Frequency: 1.0±0.1GHz Measurement Temperature: Room Temp. Measurement Instrument: Equivalent to E4991A															
		ESR (GJM03/GJM15)	0.1pF < C ≤ 1pF: 350mΩ/C below 1pF < C ≤ 5pF: 300mΩ below 5pF < C ≤ 10pF: 250mΩ below C: Nominal Capacitance (pF)	Measurement Frequency: 1.0±0.2GHz Measurement Temperature: Room Temp. Measurement Instrument: Equivalent to BOONTON Model 34A														
			10pF < C ≤ 47pF: 400mΩ below Measurement Frequency: 500±50MHz Measurement Temperature: Room Temp. Measurement Instrument: Equivalent to HP8753B															

Continued on the following page. ↗

GRM
 GR3
 GRJ
 GR4
 GR7
GJM
 GQM
 GA2
 GA3 GB
 GA3 GD
 GA3 GF
 LLL
 LLA
 LLM
 LLR
 NFM
 KRM
 KR3
 GMA
 GMD
 ⚠Caution /Notice

GJM Series Specifications and Test Methods (1)

Continued from the preceding page. ↘

Table A

Char.	Capacitance Change from Value at Reference Temp. (%)							
	-55°C		-30°C		-25°C		-10°C	
	Max.	Min.	Max.	Min.	Max.	Min.	Max.	Min.
1C	0.54	-0.23	-	-	0.33	-0.14	0.22	-0.09
2C	0.82	-0.45	-	-	0.49	-0.27	0.33	-0.18
3C	1.37	-0.90	-	-	0.82	-0.54	0.55	-0.36
4C	2.56	-1.88	-	-	1.54	-1.13	1.02	-0.75
5C	0.58	-0.24	0.40	-0.17	-	-	0.25	-0.11
6C	0.87	-0.48	0.59	-0.33	-	-	0.38	-0.21

Substrate Bending Test

• Test Substrate

Material: Copper-clad laminated sheets for PCBs
 (Glass fabric base, epoxy resin)

Thickness: 0.8mm

☐: Solder resist

(Coat with heat resistant resin for solder)

for GJM02

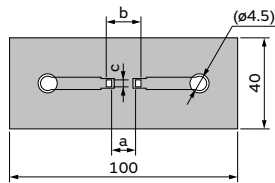

Copper foil thickness: 0.018mm

for GJM03/15

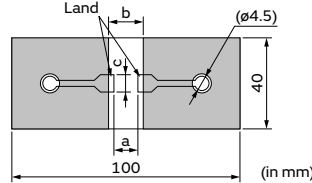

Copper foil thickness: 0.035mm

Part Number	Dimension (mm)		
	a	b	c
GJM02	0.2	0.56	0.23
GJM03	0.3	0.9	0.3
GJM15	0.4	1.5	0.5

Fig.1

• Kind of Solder: Sn-3.0Ag-0.5Cu

• Pressurization Method

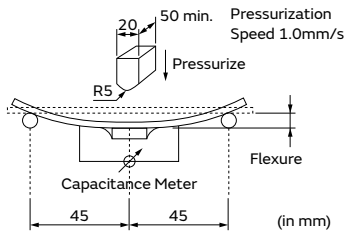

Fig.2

Adhesive Strength of Termination, Vibration, Temperature Sudden Change, Resistance to Soldering Heat (Reflow method) High Temperature High Humidity (Steady), Durability

• Test Substrate

Material: Copper-clad laminated sheets for PCBs
 (Glass fabric base, epoxy resin)

Thickness: 1.6mm or 0.8mm

Copper foil thickness: 0.035mm

• Kind of Solder: Sn-3.0Ag-0.5Cu

• Land Dimensions

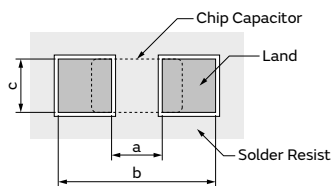

Part Number	Dimension (mm)		
	a	b	c
GJM02	0.2	0.56	0.23
GJM03	0.3	0.9	0.3
GJM15	0.4	1.5	0.5

Fig.3

2

GJM Series Specifications and Test Methods (2)

No	Item	Specification	Test Method (Ref. Standard: JIS C 5101, IEC60384)												
1	Rated Voltage	Shown in Rated value.	The rated voltage is defined as the maximum voltage which may be applied continuously to the capacitor. When AC voltage is superimposed on DC voltage, V^{P-P} or V^{O-P} , whichever is larger, should be maintained within the rated voltage range.												
2	Appearance	No defects or abnormalities.	Visual inspection.												
3	Dimension	Within the specified dimensions.	Using Measuring instrument of dimension.												
4	Voltage Proof	No defects or abnormalities.	Measurement Point: Between the terminations Test Voltage: 300% of the rated voltage Applied Time: 1 to 5s Charge/discharge current: 50mA max.												
5	Insulation Resistance (I.R.)	$C \leq 0.047\mu\text{F}$: More than 10000MΩ $C > 0.047\mu\text{F}$: More than $500\Omega \cdot \text{F}$ C: Nominal Capacitance	Measurement Point: Between the terminations Measurement Voltage: DC Rated Voltage Charging Time: 2min Charge/discharge current: 50mA max. Measurement Temperature: Room Temperature												
6	Capacitance	Shown in Rated value.	Measurement Temperature: Room Temperature												
7	Q	30pF and over: $Q \geq 1000$ 30pF and below: $Q \geq 400+20C$ C: Nominal Capacitance (pF)	<table border="1"> <thead> <tr> <th>Capacitance</th> <th>Frequency</th> <th>Voltage</th> </tr> </thead> <tbody> <tr> <td>$C \leq 1000\text{pF}$</td> <td>1.0±0.1MHz</td> <td>0.5 to 5.0Vrms</td> </tr> </tbody> </table>	Capacitance	Frequency	Voltage	$C \leq 1000\text{pF}$	1.0±0.1MHz	0.5 to 5.0Vrms						
Capacitance	Frequency	Voltage													
$C \leq 1000\text{pF}$	1.0±0.1MHz	0.5 to 5.0Vrms													
8	Temperature Characteristics of Capacitance	Nominal values of the temperature coefficient is shown in Rated value. But, the Capacitance Change under 20°C is shown in Table A. Capacitance Drift Within ±0.2% or ±0.05pF (Whichever is larger.)	<p>The capacitance change should be measured after 5 minutes at each specified temp. stage. Capacitance value as a reference is the value in step 3. The capacitance drift is calculated by dividing the differences between the maximum and minimum measured values in the step 1, 3 and 5 by the cap. value in step 3.</p> <table border="1"> <thead> <tr> <th>Step</th> <th>Temperature (°C)</th> </tr> </thead> <tbody> <tr> <td>1</td> <td>Reference Temp. ±2</td> </tr> <tr> <td>2</td> <td>Min. Operating Temp. ±3</td> </tr> <tr> <td>3</td> <td>Reference Temp. ±2</td> </tr> <tr> <td>4</td> <td>Max. Operating Temp. ±3</td> </tr> <tr> <td>5</td> <td>Reference Temp. ±2</td> </tr> </tbody> </table>	Step	Temperature (°C)	1	Reference Temp. ±2	2	Min. Operating Temp. ±3	3	Reference Temp. ±2	4	Max. Operating Temp. ±3	5	Reference Temp. ±2
Step	Temperature (°C)														
1	Reference Temp. ±2														
2	Min. Operating Temp. ±3														
3	Reference Temp. ±2														
4	Max. Operating Temp. ±3														
5	Reference Temp. ±2														
9	Adhesive Strength of Termination	No removal of the terminations or other defect should occur.	<p>Solder the capacitor on the test substrate shown in Fig.3.</p> <table border="1"> <thead> <tr> <th>Part Number</th> <th>Applied Force (N)</th> </tr> </thead> <tbody> <tr> <td>GJM02</td> <td>1</td> </tr> <tr> <td>GJM03</td> <td>2</td> </tr> <tr> <td>GJM15</td> <td>5</td> </tr> </tbody> </table> <p>Holding Time: 10±1s Applied Direction: In parallel with the test substrate and vertical with the capacitor side.</p>	Part Number	Applied Force (N)	GJM02	1	GJM03	2	GJM15	5				
Part Number	Applied Force (N)														
GJM02	1														
GJM03	2														
GJM15	5														
10	Vibration	<table border="1"> <tbody> <tr> <td>Appearance</td> <td>No defects or abnormalities.</td> </tr> <tr> <td>Capacitance</td> <td>Within the specified initial value.</td> </tr> <tr> <td>Q</td> <td>Within the specified initial value.</td> </tr> </tbody> </table>	Appearance	No defects or abnormalities.	Capacitance	Within the specified initial value.	Q	Within the specified initial value.	<p>Solder the capacitor on the test substrate shown in Fig.3. Kind of Vibration: A simple harmonic motion 10Hz to 55Hz to 10Hz (1min) Total amplitude: 1.5mm This motion should be applied for a period of 2h in each 3 mutually perpendicular directions (total of 6h).</p>						
Appearance	No defects or abnormalities.														
Capacitance	Within the specified initial value.														
Q	Within the specified initial value.														
11	Substrate Bending Test	<table border="1"> <tbody> <tr> <td>Appearance</td> <td>No defects or abnormalities.</td> </tr> <tr> <td>Capacitance Change</td> <td>Within ±5% or ±0.5pF (Whichever is larger)</td> </tr> </tbody> </table>	Appearance	No defects or abnormalities.	Capacitance Change	Within ±5% or ±0.5pF (Whichever is larger)	<p>Solder the capacitor on the test substrate shown in Fig.1. Pressurization method: Shown in Fig.2 Flexure: 1mm Holding Time: 5±1s Soldering Method: Reflow soldering</p>								
Appearance	No defects or abnormalities.														
Capacitance Change	Within ±5% or ±0.5pF (Whichever is larger)														
12	Solderability	95% of the terminations is to be soldered evenly and continuously.	<p>Test Method: Solder bath method Flux: Solution of rosin ethanol 25 (mass)% Preheat: 80 to 120°C for 10 to 30s Solder: Sn-3.0Ag-0.5Cu Solder Temp.: 245±5°C Immersion time: 2±0.5s</p>												

Continued on the following page. ↗

GRM
GR3
GRJ
GR4
GR7
GJM
GQM
GA2
GA3
GB
GA3
GD
GA3
GF
LLL
LLA
LLM
LLR
NFM
KRM
KR3
GMA
GMD
⚠Caution / Notice

GJM Series Specifications and Test Methods (2)

Continued from the preceding page. ↘

No	Item	Specification	Test Method (Ref. Standard: JIS C 5101, IEC60384)															
13	Resistance to Soldering Heat	Appearance	No defects or abnormalities.															
		Capacitance Change	Within $\pm 2.5\%$ or $\pm 0.25\text{pF}$ (Whichever is larger)															
		Q	Within the specified initial value.															
		I.R.	Within the specified initial value.															
		Voltage Proof	No defects.															
			<GJM02 size only> Test Method: Reflow soldering (hot plate) Solder: Sn-3.0Ag-0.5Cu Solder Temp.: $270\pm 5^\circ\text{C}$ Reflow Time: $10\pm 0.5\text{s}$ Test Substrate: Glass epoxy PCB Exposure Time: $24\pm 2\text{h}$ Preheat: 120 to 150°C for 1min <GJM03/GJM15 size> Test Method: Solder bath method Solder: Sn-3.0Ag-0.5Cu Solder Temp.: $270\pm 5^\circ\text{C}$ Immersion time: $10\pm 0.5\text{s}$ Exposure Time: $24\pm 2\text{h}$ Preheat: 120 to 150°C for 1min															
14	Temperature Sudden Change	Appearance	No defects or abnormalities.															
		Capacitance Change	Within $\pm 2.5\%$ or $\pm 0.25\text{pF}$ (Whichever is larger)															
		Q	Within the specified initial value.															
		I.R.	Within the specified initial value.															
		Voltage Proof	No defects.															
			Solder the capacitor on the test substrate shown in Fig.3. Perform the five cycles according to the four heat treatments shown in the following table.															
			<table border="1"> <thead> <tr> <th>Step</th> <th>Temp. ($^\circ\text{C}$)</th> <th>Time (min)</th> </tr> </thead> <tbody> <tr> <td>1</td> <td>Min. Operating Temp. $+0/-3$</td> <td>30 ± 3</td> </tr> <tr> <td>2</td> <td>Room Temp.</td> <td>2 to 3</td> </tr> <tr> <td>3</td> <td>Max. Operating Temp. $+3/-0$</td> <td>30 ± 3</td> </tr> <tr> <td>4</td> <td>Room Temp.</td> <td>2 to 3</td> </tr> </tbody> </table>	Step	Temp. ($^\circ\text{C}$)	Time (min)	1	Min. Operating Temp. $+0/-3$	30 ± 3	2	Room Temp.	2 to 3	3	Max. Operating Temp. $+3/-0$	30 ± 3	4	Room Temp.	2 to 3
Step	Temp. ($^\circ\text{C}$)	Time (min)																
1	Min. Operating Temp. $+0/-3$	30 ± 3																
2	Room Temp.	2 to 3																
3	Max. Operating Temp. $+3/-0$	30 ± 3																
4	Room Temp.	2 to 3																
			Exposure Time: $24\pm 2\text{h}$															
15	High Temperature High Humidity (Steady)	Appearance	No defects or abnormalities.															
		Capacitance Change	Within $\pm 7.5\%$ or $\pm 0.75\text{pF}$ (Whichever is larger)															
		Q	30pF and over: $Q \geq 200$ 30pF and below: $Q \geq 100+10\text{C}/3$ C: Nominal Capacitance (pF)															
		I.R.	More than $500\text{M}\Omega$ or $25\Omega \cdot \text{F}$ (Whichever is smaller)															
			Solder the capacitor on the test substrate shown in Fig.3. Test Temperature: $40\pm 2^\circ\text{C}$ Test Humidity: 90 to $95\%\text{RH}$ Test Time: $500\pm 12\text{h}$ Applied Voltage: DC Rated Voltage Charge/discharge current: 50mA max. Exposure Time: $24\pm 2\text{h}$															
16	Durability	Appearance	No defects or abnormalities.															
		Capacitance Change	Within $\pm 3\%$ or $\pm 0.3\text{pF}$ (Whichever is larger)															
		Q	30pF and over: $Q \geq 350$ 10pF and over, 30pF and below: $Q \geq 275+5\text{C}/2$ 10pF and below: $Q \geq 200+10\text{C}$ C: Nominal Capacitance (pF)															
		I.R.	More than $1000\text{M}\Omega$ or $50\Omega \cdot \text{F}$ (Whichever is smaller)															
			Solder the capacitor on the test substrate shown in Fig.3. Test Temperature: Max. Operating Temp. $\pm 3^\circ\text{C}$ Test Time: $1000\pm 12\text{h}$ Applied Voltage: 100% of the rated voltage Charge/discharge current: 50mA max. Exposure Time: $24\pm 2\text{h}$															
17	ESR (GJM02)	$0.2\text{pF} \leq \text{C} \leq 1\text{pF}$: $700\text{m}\Omega/\text{C}$ below $1\text{pF} < \text{C} \leq 2\text{pF}$: $600\text{m}\Omega$ below $2\text{pF} < \text{C} \leq 5\text{pF}$: $500\text{m}\Omega$ below $5\text{pF} < \text{C} \leq 10\text{pF}$: $300\text{m}\Omega$ below $10\text{pF} < \text{C} \leq 22\text{pF}$: $350\text{m}\Omega$ below C: Nominal Capacitance (pF)	Measurement Frequency: $1.0\pm 0.1\text{GHz}$ Measurement Temperature: Room Temp. Measurement Instrument: Equivalent to E4991A															
	ESR (GJM03/GJM15)	$0.1\text{pF} \leq \text{C} \leq 1\text{pF}$: $350\text{m}\Omega/\text{C}$ below $1\text{pF} < \text{C} \leq 5\text{pF}$: $300\text{m}\Omega$ below $5\text{pF} < \text{C} \leq 10\text{pF}$: $250\text{m}\Omega$ below C: Nominal Capacitance (pF)	Measurement Frequency: $1.0\pm 0.2\text{GHz}$ Measurement Temperature: Room Temp. Measurement Instrument: Equivalent to BOONTON Model 34A															
			$10\text{pF} < \text{C} \leq 47\text{pF}$: $400\text{m}\Omega$ below Measurement Frequency: $500\pm 50\text{MHz}$ Measurement Temperature: Room Temp. Measurement Instrument: Equivalent to HP8753B															

Continued on the following page. ↗

GRM
 GR3
 GRJ
 GR4
 GR7
 GJM
 GQM
 GA2
 GA3 GB
 GA3 GD
 GA3 GF
 LLL
 LLA
 LLM
 LLR
 NFM
 KRM
 KR3
 GMA
 GMD
 ⚠Caution / Notice

GJM Series Specifications and Test Methods (2)

Continued from the preceding page. ↘

Table A

Char.	Capacitance Change from Value at Reference Temp. (%)							
	-55°C		-30°C		-25°C		-10°C	
	Max.	Min.	Max.	Min.	Max.	Min.	Max.	Min.
1C	0.54	-0.23	-	-	0.33	-0.14	0.22	-0.09
2C	0.82	-0.45	-	-	0.49	-0.27	0.33	-0.18
3C	1.37	-0.90	-	-	0.82	-0.54	0.55	-0.36
4C	2.56	-1.88	-	-	1.54	-1.13	1.02	-0.75
5C	0.58	-0.24	0.40	-0.17	-	-	0.25	-0.11
6C	0.87	-0.48	0.59	-0.33	-	-	0.38	-0.21

Recommended derating conditions on voltage and temperature

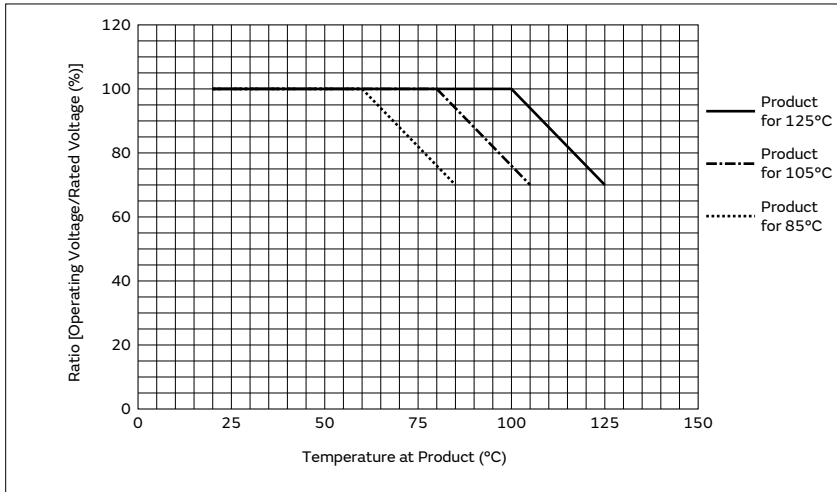

These Part Numbers are designed for use in the circuits where continuous applied voltage to the capacitor is derated than rated voltage, and guarantee Durability Test with 100% × rated voltage as testing voltage at the maximum operating temperature. The voltage and temperature derating conditions on the upside are recommended for use to ensure the same reliability level as normal specification.

Continued on the following page. ↗

GRM
 GR3
 GRJ
 GR4
 GR7
CJM
 GQM
 GA2
 GA3 GB
 GA3 GD
 GA3 GF
 LLL
 LLA
 LLM
 LLR
 NFM
 KRM
 KR3
 GMA
 GMD
 ⚠Caution /Notice

GJM Series Specifications and Test Methods (2)

Continued from the preceding page. ↘

Substrate Bending Test

• Test Substrate

Material: Copper-clad laminated sheets for PCBs
 (Glass fabric base, epoxy resin)

Thickness: 0.8mm

■: Solder resist

(Coat with heat resistant resin for solder)

for GJM02

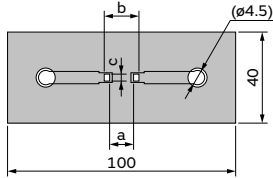

Copper foil thickness: 0.018mm

for GJM03/15

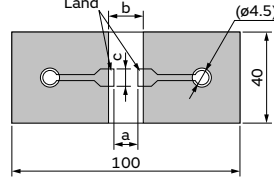

Copper foil thickness: 0.035mm

Fig.1 (in mm)

Part Number	Dimension (mm)		
	a	b	c
GJM02	0.2	0.56	0.23
GJM03	0.3	0.9	0.3
GJM15	0.4	1.5	0.5

• Kind of Solder: Sn-3.0Ag-0.5Cu

• Pressurization Method

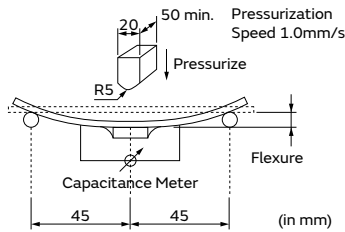

Fig.2

Adhesive Strength of Termination, Vibration, Temperature Sudden Change, Resistance to Soldering Heat (Reflow method) High Temperature High Humidity (Steady), Durability

• Test Substrate

Material: Copper-clad laminated sheets for PCBs
 (Glass fabric base, epoxy resin)

Thickness: 1.6mm or 0.8mm

Copper foil thickness: 0.035mm

• Kind of Solder: Sn-3.0Ag-0.5Cu

• Land Dimensions

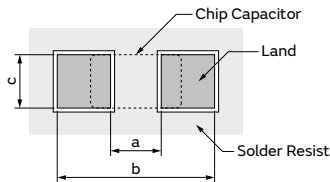

Part Number	Dimension (mm)		
	a	b	c
GJM02	0.2	0.56	0.23
GJM03	0.3	0.9	0.3
GJM15	0.4	1.5	0.5

Fig.3

GRM
 GR3
 GRJ
 GR4
 GR7
GJM
 GQM
 GA2
 GA3 GB
 GA3 GD
 GA3 GF
 LLL
 LLA
 LLM
 LLR
 NFM
 KPM
 KR3
 GMA
 GMD
 ⚠Caution / Notice

High Q and High Power Chip Multilayer Ceramic Capacitors for General Purpose

GQM Series  **High Q** 

High Frequency Capacitor Ideal for PA Design of Base Stations

Features

① **Mainly ideal for base stations of mobile communication devices and temperature compensation of related modules.**

This product is ideal for temperature compensation of high frequency circuits, such as resonant circuits, tuning circuits, and impedance matching circuits where the operating characteristics of the device are greatly affected by the capacitance fluctuation.

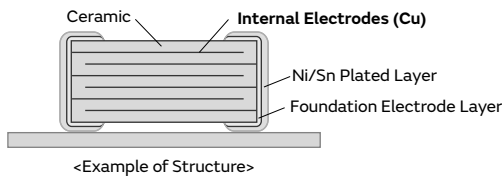

② **High Q and low ESR in VHF, UHF and microwave frequency bands.**

High Q and low ESR were achieved at a high frequency by adopting ceramic material as the dielectric material which enables an extremely low loss at high frequency, and base metal electrodes as the internal electrodes.

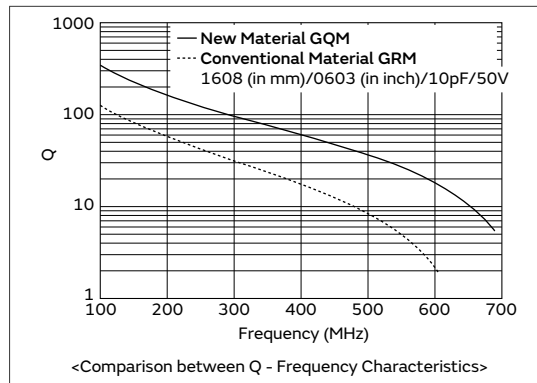
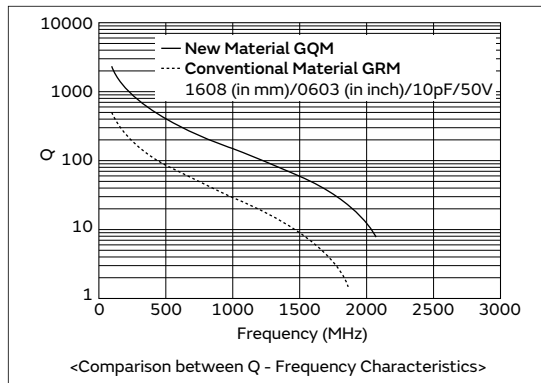

③ **Can be used for tight tolerance.**

In addition to standard tolerance, the allowable range of this product is also suitable for the following narrow tolerance.

Capacitance Range	Standard Capacitance Tolerance (Capacitance Tolerance Symbol)	Narrow Capacitance Tolerance (Capacitance Tolerance Symbol)
to 0.9pF	±0.1pF (B)	±0.05pF (W)
1.0 to 5.0pF	±0.25pF (C)	±0.05pF (W), ±0.1pF (B)
5.1 to 9.9pF	±0.5pF (D)	±0.05pF (W), ±0.1pF (B), ±0.25pF (C)
10pF to	±5% (J)	±2% (G)

Specifications

Size (mm)	1.0×0.5mm to 2.8×2.8mm
Rated Voltage	50Vdc to 500Vdc
Capacitance	0.10pF to 510pF
Main Applications	Measuring instruments, other ultra compact/thin devices

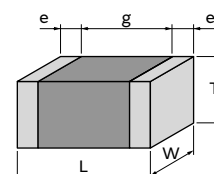

This catalog contains only a portion of the product lineup.
 Please refer to the capacitor search tool on the Murata Web site for details.

GQM Series Temperature Compensating Type Part Number List

1.0×0.5mm

T max.	Rated Voltage	TC Code	Cap.	Tol.	Part Number	p*
0.55mm	200Vdc	COG	0.10pF	±0.1pF	GQM1555C2DR10BB01#	p172
				±0.25pF	GQM1555C2DR10CB01#	p172
			0.20pF	±0.1pF	GQM1555C2DR20BB01#	p172
				±0.25pF	GQM1555C2DR20CB01#	p172
			0.30pF	±0.1pF	GQM1555C2DR30BB01#	p172
				±0.25pF	GQM1555C2DR30CB01#	p172
			0.40pF	±0.1pF	GQM1555C2DR40BB01#	p172
				±0.25pF	GQM1555C2DR40CB01#	p172
			0.50pF	±0.1pF	GQM1555C2DR50BB01#	p172
				±0.25pF	GQM1555C2DR50CB01#	p172
			0.60pF	±0.1pF	GQM1555C2DR60BB01#	p172
				±0.25pF	GQM1555C2DR60CB01#	p172
			0.70pF	±0.1pF	GQM1555C2DR70BB01#	p172
				±0.25pF	GQM1555C2DR70CB01#	p172
			0.75pF	±0.1pF	GQM1555C2DR75BB01#	p172
				±0.25pF	GQM1555C2DR75CB01#	p172
			0.80pF	±0.1pF	GQM1555C2DR80BB01#	p172
				±0.25pF	GQM1555C2DR80CB01#	p172
			0.90pF	±0.1pF	GQM1555C2DR90BB01#	p172
				±0.25pF	GQM1555C2DR90CB01#	p172
			1.0pF	±0.1pF	GQM1555C2D1R0BB01#	p172
				±0.25pF	GQM1555C2D1R0CB01#	p172
			1.1pF	±0.1pF	GQM1555C2D1R1BB01#	p172
				±0.25pF	GQM1555C2D1R1CB01#	p172
			1.2pF	±0.1pF	GQM1555C2D1R2BB01#	p172
				±0.25pF	GQM1555C2D1R2CB01#	p172
			1.3pF	±0.1pF	GQM1555C2D1R3BB01#	p172
				±0.25pF	GQM1555C2D1R3CB01#	p172
			1.5pF	±0.1pF	GQM1555C2D1R5BB01#	p172
				±0.25pF	GQM1555C2D1R5CB01#	p172
			1.6pF	±0.1pF	GQM1555C2D1R6BB01#	p172
				±0.25pF	GQM1555C2D1R6CB01#	p172
			1.8pF	±0.1pF	GQM1555C2D1R8BB01#	p172
				±0.25pF	GQM1555C2D1R8CB01#	p172
			2.0pF	±0.1pF	GQM1555C2D2R0BB01#	p172
				±0.25pF	GQM1555C2D2R0CB01#	p172
			2.2pF	±0.1pF	GQM1555C2D2R2BB01#	p172
				±0.25pF	GQM1555C2D2R2CB01#	p172
			2.4pF	±0.1pF	GQM1555C2D2R4BB01#	p172
				±0.25pF	GQM1555C2D2R4CB01#	p172
			2.7pF	±0.1pF	GQM1555C2D2R7BB01#	p172
				±0.25pF	GQM1555C2D2R7CB01#	p172
			3.0pF	±0.1pF	GQM1555C2D3R0BB01#	p172
				±0.25pF	GQM1555C2D3R0CB01#	p172
			3.3pF	±0.1pF	GQM1555C2D3R3BB01#	p172
				±0.25pF	GQM1555C2D3R3CB01#	p172
			3.6pF	±0.1pF	GQM1555C2D3R6BB01#	p172
				±0.25pF	GQM1555C2D3R6CB01#	p172
3.9pF	±0.1pF	GQM1555C2D3R9BB01#	p172			
	±0.25pF	GQM1555C2D3R9CB01#	p172			
4.0pF	±0.1pF	GQM1555C2D4R0BB01#	p172			
	±0.25pF	GQM1555C2D4R0CB01#	p172			
4.3pF	±0.1pF	GQM1555C2D4R3BB01#	p172			
	±0.25pF	GQM1555C2D4R3CB01#	p172			

T max.	Rated Voltage	TC Code	Cap.	Tol.	Part Number	p*
0.55mm	200Vdc	COG	4.7pF	±0.1pF	GQM1555C2D4R7BB01#	p172
				±0.25pF	GQM1555C2D4R7CB01#	p172
			5.0pF	±0.1pF	GQM1555C2D5R0BB01#	p172
				±0.25pF	GQM1555C2D5R0CB01#	p172
			5.1pF	±0.1pF	GQM1555C2D5R1BB01#	p172
				±0.25pF	GQM1555C2D5R1CB01#	p172
			5.6pF	±0.1pF	GQM1555C2D5R6BB01#	p172
				±0.25pF	GQM1555C2D5R6CB01#	p172
			6.0pF	±0.1pF	GQM1555C2D6R0BB01#	p172
				±0.25pF	GQM1555C2D6R0CB01#	p172
			6.2pF	±0.1pF	GQM1555C2D6R2BB01#	p172
				±0.25pF	GQM1555C2D6R2CB01#	p172
			6.8pF	±0.1pF	GQM1555C2D6R8BB01#	p172
				±0.25pF	GQM1555C2D6R8CB01#	p172
			7.0pF	±0.1pF	GQM1555C2D7R0BB01#	p172
				±0.25pF	GQM1555C2D7R0CB01#	p172
			7.5pF	±0.1pF	GQM1555C2D7R5BB01#	p172
				±0.25pF	GQM1555C2D7R5CB01#	p172
			8.0pF	±0.1pF	GQM1555C2D8R0BB01#	p172
				±0.25pF	GQM1555C2D8R0CB01#	p172
			8.2pF	±0.1pF	GQM1555C2D8R2BB01#	p172
				±0.25pF	GQM1555C2D8R2CB01#	p172
			9.0pF	±0.1pF	GQM1555C2D9R0BB01#	p172
				±0.25pF	GQM1555C2D9R0CB01#	p172
			9.1pF	±0.1pF	GQM1555C2D9R1BB01#	p172
				±0.25pF	GQM1555C2D9R1CB01#	p172
			10pF	±2%	GQM1555C2D100GB01#	p172
				±5%	GQM1555C2D100JB01#	p172
			11pF	±2%	GQM1555C2D110GB01#	p172
				±5%	GQM1555C2D110JB01#	p172
			12pF	±2%	GQM1555C2D120GB01#	p172
				±5%	GQM1555C2D120JB01#	p172
			13pF	±2%	GQM1555C2D130GB01#	p172
				±5%	GQM1555C2D130JB01#	p172
			15pF	±2%	GQM1555C2D150GB01#	p172
				±5%	GQM1555C2D150JB01#	p172
			16pF	±2%	GQM1555C2D160GB01#	p172
				±5%	GQM1555C2D160JB01#	p172
			18pF	±2%	GQM1555C2D180GB01#	p172
				±5%	GQM1555C2D180JB01#	p172
			20pF	±2%	GQM1555C2D200GB01#	p172
±5%	GQM1555C2D200JB01#	p172				
22pF	±2%	GQM1555C2D220GB01#	p172			
	±5%	GQM1555C2D220JB01#	p172			
24pF	±2%	GQM1555C2D240GB01#	p172			
	±5%	GQM1555C2D240JB01#	p172			
27pF	±2%	GQM1555C2D270GB01#	p172			
	±5%	GQM1555C2D270JB01#	p172			
30pF	±2%	GQM1555C2D300GB01#	p172			
	±5%	GQM1555C2D300JB01#	p172			
33pF	±2%	GQM1555C2D330GB01#	p172			
	±5%	GQM1555C2D330JB01#	p172			
100Vdc	COG	36pF	±2%	GQM1555C2A360GB01#	p172	
			±5%	GQM1555C2A360JB01#	p172	

*: Refers to the page of the "Specifications and Test Methods".

Part number # indicates the package specification code.

GQM Series Temperature Compensating Type Part Number List

(→ 1.0×0.5mm)

T max.	Rated Voltage	TC Code	Cap.	Tol.	Part Number	p*
0.55mm	100Vdc	COG	39pF	±2%	GQM1555C2A390GB01#	p172
				±5%	GQM1555C2A390JB01#	p172
			43pF	±2%	GQM1555C2A430GB01#	p172
				±5%	GQM1555C2A430JB01#	p172
			47pF	±2%	GQM1555C2A470GB01#	p172
				±5%	GQM1555C2A470JB01#	p172

T max.	Rated Voltage	TC Code	Cap.	Tol.	Part Number	p*
0.8mm	250Vdc	COG	6.0pF	±0.5pF	GQM1875C2E6R0DB12#	p178
				±0.25pF	GQM1875C2E6R2CB12#	p178
			6.2pF	±0.5pF	GQM1875C2E6R2DB12#	p178
				±0.25pF	GQM1875C2E6R8CB12#	p178
			6.8pF	±0.25pF	GQM1875C2E6R8DB12#	p178
				±0.5pF	GQM1875C2E7R0CB12#	p178
			7.0pF	±0.25pF	GQM1875C2E7R0DB12#	p178
				±0.5pF	GQM1875C2E7R5CB12#	p178
			7.5pF	±0.25pF	GQM1875C2E7R5DB12#	p178
				±0.5pF	GQM1875C2E8R0CB12#	p178
			8.0pF	±0.25pF	GQM1875C2E8R0DB12#	p178
				±0.5pF	GQM1875C2E8R2CB12#	p178
			8.2pF	±0.25pF	GQM1875C2E8R2DB12#	p178
				±0.5pF	GQM1875C2E9R0CB12#	p178
			9.0pF	±0.25pF	GQM1875C2E9R0DB12#	p178
				±0.5pF	GQM1875C2E9R1CB12#	p178
			9.1pF	±0.25pF	GQM1875C2E9R1DB12#	p178
				±0.5pF	GQM1875C2E100GB12#	p178
			10pF	±2%	GQM1875C2E100JB12#	p178
				±5%	GQM1875C2E110GB12#	p178
			11pF	±2%	GQM1875C2E110JB12#	p178
				±5%	GQM1875C2E120GB12#	p178
			12pF	±2%	GQM1875C2E120JB12#	p178
				±5%	GQM1875C2E130GB12#	p178
			13pF	±2%	GQM1875C2E130JB12#	p178
				±5%	GQM1875C2E150GB12#	p178
			15pF	±2%	GQM1875C2E150JB12#	p178
				±5%	GQM1875C2E160GB12#	p178
			16pF	±2%	GQM1875C2E160JB12#	p178
				±5%	GQM1875C2E180GB12#	p178
			18pF	±2%	GQM1875C2E180JB12#	p178
				±5%	GQM1875C2E200GB12#	p178
			20pF	±2%	GQM1875C2E200JB12#	p178
				±5%	GQM1875C2E220GB12#	p178
			22pF	±2%	GQM1875C2E220JB12#	p178
				±5%	GQM1875C2E240GB12#	p178
			24pF	±2%	GQM1875C2E240JB12#	p178
				±5%	GQM1875C2E270GB12#	p178
			27pF	±2%	GQM1875C2E270JB12#	p178
				±5%	GQM1875C2E300GB12#	p178
			30pF	±2%	GQM1875C2E300JB12#	p178
				±5%	GQM1875C2E330GB12#	p178
33pF	±2%	GQM1875C2E330JB12#	p178			
	±5%	GQM1875C2E360GB12#	p178			
36pF	±2%	GQM1875C2E360JB12#	p178			
	±5%	GQM1875C2E390GB12#	p178			
39pF	±2%	GQM1875C2E390JB12#	p178			
	±5%	GQM1875C2E430GB12#	p178			
43pF	±2%	GQM1875C2E430JB12#	p178			
	±5%	GQM1875C2E470GB12#	p178			
47pF	±2%	GQM1875C2E470JB12#	p178			
	±5%	GQM1875G2E1R0BB12#	p175			
X8G	1.0pF	±0.1pF	GQM1875G2E1R0CB12#	p175		
		±0.25pF	GQM1875G2E1R1BB12#	p175		
1.1pF	±0.1pF	GQM1875G2E1R1DB12#	p175			

1.6×0.8mm

T max.	Rated Voltage	TC Code	Cap.	Tol.	Part Number	p*
0.8mm	250Vdc	COG	1.0pF	±0.1pF	GQM1875C2E1R0BB12#	p178
				±0.25pF	GQM1875C2E1R0CB12#	p178
			1.1pF	±0.1pF	GQM1875C2E1R1BB12#	p178
				±0.25pF	GQM1875C2E1R1CB12#	p178
			1.2pF	±0.1pF	GQM1875C2E1R2BB12#	p178
				±0.25pF	GQM1875C2E1R2CB12#	p178
			1.3pF	±0.1pF	GQM1875C2E1R3BB12#	p178
				±0.25pF	GQM1875C2E1R3CB12#	p178
			1.5pF	±0.1pF	GQM1875C2E1R5BB12#	p178
				±0.25pF	GQM1875C2E1R5CB12#	p178
			1.6pF	±0.1pF	GQM1875C2E1R6BB12#	p178
				±0.25pF	GQM1875C2E1R6CB12#	p178
			1.8pF	±0.1pF	GQM1875C2E1R8BB12#	p178
				±0.25pF	GQM1875C2E1R8CB12#	p178
			2.0pF	±0.1pF	GQM1875C2E2R0BB12#	p178
				±0.25pF	GQM1875C2E2R0CB12#	p178
			2.2pF	±0.1pF	GQM1875C2E2R2BB12#	p178
				±0.25pF	GQM1875C2E2R2CB12#	p178
			2.4pF	±0.1pF	GQM1875C2E2R4BB12#	p178
				±0.25pF	GQM1875C2E2R4CB12#	p178
			2.7pF	±0.1pF	GQM1875C2E2R7BB12#	p178
				±0.25pF	GQM1875C2E2R7CB12#	p178
			3.0pF	±0.1pF	GQM1875C2E3R0BB12#	p178
				±0.25pF	GQM1875C2E3R0CB12#	p178
			3.3pF	±0.1pF	GQM1875C2E3R3BB12#	p178
				±0.25pF	GQM1875C2E3R3CB12#	p178
			3.6pF	±0.1pF	GQM1875C2E3R6BB12#	p178
				±0.25pF	GQM1875C2E3R6CB12#	p178
			3.9pF	±0.1pF	GQM1875C2E3R9BB12#	p178
				±0.25pF	GQM1875C2E3R9CB12#	p178
			4.0pF	±0.1pF	GQM1875C2E4R0BB12#	p178
				±0.25pF	GQM1875C2E4R0CB12#	p178
			4.3pF	±0.1pF	GQM1875C2E4R3BB12#	p178
				±0.25pF	GQM1875C2E4R3CB12#	p178
			4.7pF	±0.1pF	GQM1875C2E4R7BB12#	p178
				±0.25pF	GQM1875C2E4R7CB12#	p178
			5.0pF	±0.1pF	GQM1875C2E5R0BB12#	p178
				±0.25pF	GQM1875C2E5R0CB12#	p178
			5.1pF	±0.25pF	GQM1875C2E5R1CB12#	p178
				±0.5pF	GQM1875C2E5R1DB12#	p178
			5.6pF	±0.25pF	GQM1875C2E5R6CB12#	p178
				±0.5pF	GQM1875C2E5R6DB12#	p178
			6.0pF	±0.25pF	GQM1875C2E6R0CB12#	p178

*: Refers to the page of the "Specifications and Test Methods".

Part number # indicates the package specification code.

GQM Series Temperature Compensating Type Part Number List

(→ 1.6×0.8mm)

T max.	Rated Voltage	TC Code	Cap.	Tol.	Part Number	p*
0.8mm	250Vdc	X8G	1.1pF	±0.25pF	GQM1875G2E1R1CB12#	p175
				±0.1pF	GQM1875G2E1R2BB12#	p175
			1.2pF	±0.25pF	GQM1875G2E1R2CB12#	p175
				±0.1pF	GQM1875G2E1R3BB12#	p175
			1.3pF	±0.25pF	GQM1875G2E1R3CB12#	p175
				±0.1pF	GQM1875G2E1R5BB12#	p175
			1.5pF	±0.25pF	GQM1875G2E1R5CB12#	p175
				±0.1pF	GQM1875G2E1R6BB12#	p175
			1.6pF	±0.25pF	GQM1875G2E1R6CB12#	p175
				±0.1pF	GQM1875G2E1R8BB12#	p175
			1.8pF	±0.25pF	GQM1875G2E1R8CB12#	p175
				±0.1pF	GQM1875G2E2R0BB12#	p175
			2.0pF	±0.25pF	GQM1875G2E2R0CB12#	p175
				±0.1pF	GQM1875G2E2R2BB12#	p175
			2.2pF	±0.25pF	GQM1875G2E2R2CB12#	p175
				±0.1pF	GQM1875G2E2R4BB12#	p175
			2.4pF	±0.25pF	GQM1875G2E2R4CB12#	p175
				±0.1pF	GQM1875G2E2R7BB12#	p175
			2.7pF	±0.25pF	GQM1875G2E2R7CB12#	p175
				±0.1pF	GQM1875G2E3R0BB12#	p175
			3.0pF	±0.25pF	GQM1875G2E3R0CB12#	p175
				±0.1pF	GQM1875G2E3R3BB12#	p175
			3.3pF	±0.25pF	GQM1875G2E3R3CB12#	p175
				±0.1pF	GQM1875G2E3R6BB12#	p175
			3.6pF	±0.25pF	GQM1875G2E3R6CB12#	p175
				±0.1pF	GQM1875G2E3R9BB12#	p175
			3.9pF	±0.25pF	GQM1875G2E3R9CB12#	p175
				±0.1pF	GQM1875G2E4R0BB12#	p175
			4.0pF	±0.25pF	GQM1875G2E4R0CB12#	p175
				±0.1pF	GQM1875G2E4R3BB12#	p175
			4.3pF	±0.25pF	GQM1875G2E4R3CB12#	p175
				±0.1pF	GQM1875G2E4R7BB12#	p175
			4.7pF	±0.25pF	GQM1875G2E4R7CB12#	p175
				±0.1pF	GQM1875G2E5R0BB12#	p175
			5.0pF	±0.25pF	GQM1875G2E5R0CB12#	p175
				±0.1pF	GQM1875G2E5R1CB12#	p175
			5.1pF	±0.5pF	GQM1875G2E5R1DB12#	p175
				±0.25pF	GQM1875G2E5R6CB12#	p175
			5.6pF	±0.5pF	GQM1875G2E5R6DB12#	p175
				±0.25pF	GQM1875G2E6R0CB12#	p175
			6.0pF	±0.5pF	GQM1875G2E6R0DB12#	p175
				±0.25pF	GQM1875G2E6R2CB12#	p175
			6.2pF	±0.5pF	GQM1875G2E6R2DB12#	p175
				±0.25pF	GQM1875G2E6R8CB12#	p175
			6.8pF	±0.5pF	GQM1875G2E6R8DB12#	p175
				±0.25pF	GQM1875G2E7R0CB12#	p175
			7.0pF	±0.5pF	GQM1875G2E7R0DB12#	p175
				±0.25pF	GQM1875G2E7R5CB12#	p175
			7.5pF	±0.5pF	GQM1875G2E7R5DB12#	p175
				±0.25pF	GQM1875G2E8R0CB12#	p175
			8.0pF	±0.5pF	GQM1875G2E8R0DB12#	p175
				±0.25pF	GQM1875G2E8R2CB12#	p175
			8.2pF	±0.5pF	GQM1875G2E8R2DB12#	p175
				±0.25pF	GQM1875G2E9R0CB12#	p175

T max.	Rated Voltage	TC Code	Cap.	Tol.	Part Number	p*
0.8mm	250Vdc	X8G	9.0pF	±0.5pF	GQM1875G2E9R0DB12#	p175
				±0.25pF	GQM1875G2E9R1CB12#	p175
			9.1pF	±0.5pF	GQM1875G2E9R1DB12#	p175
				±2%	GQM1875G2E100GB12#	p175
			10pF	±5%	GQM1875G2E100JB12#	p175
				±2%	GQM1875G2E110GB12#	p175
			11pF	±5%	GQM1875G2E110JB12#	p175
				±2%	GQM1875G2E120GB12#	p175
			12pF	±5%	GQM1875G2E120JB12#	p175
				±2%	GQM1875G2E130GB12#	p175
			13pF	±5%	GQM1875G2E130JB12#	p175
				±2%	GQM1875G2E150GB12#	p175
			15pF	±5%	GQM1875G2E150JB12#	p175
				±2%	GQM1875G2E160GB12#	p175
			16pF	±5%	GQM1875G2E160JB12#	p175
				±2%	GQM1875G2E180GB12#	p175
			18pF	±5%	GQM1875G2E180JB12#	p175
				±2%	GQM1875G2E200GB12#	p175
			20pF	±5%	GQM1875G2E200JB12#	p175
				±2%	GQM1875G2E220GB12#	p175
			22pF	±5%	GQM1875G2E220JB12#	p175
				±2%	GQM1875G2E240GB12#	p175
			24pF	±5%	GQM1875G2E240JB12#	p175
				±2%	GQM1875G2E270GB12#	p175
27pF	±5%	GQM1875G2E270JB12#	p175			
	±2%	GQM1875G2E300GB12#	p175			
30pF	±5%	GQM1875G2E300JB12#	p175			

2.0×1.25mm

T max.	Rated Voltage	TC Code	Cap.	Tol.	Part Number	p*
1.0mm	500Vdc	X8G	1.0pF	±0.1pF	GQM2195G2H1R0BB12#	p175
				±0.25pF	GQM2195G2H1R0CB12#	p175
			1.1pF	±0.1pF	GQM2195G2H1R1BB12#	p175
				±0.25pF	GQM2195G2H1R1CB12#	p175
			1.2pF	±0.1pF	GQM2195G2H1R2BB12#	p175
				±0.25pF	GQM2195G2H1R2CB12#	p175
			1.3pF	±0.1pF	GQM2195G2H1R3BB12#	p175
				±0.25pF	GQM2195G2H1R3CB12#	p175
			1.5pF	±0.1pF	GQM2195G2H1R5BB12#	p175
				±0.25pF	GQM2195G2H1R5CB12#	p175
			1.6pF	±0.1pF	GQM2195G2H1R6BB12#	p175
				±0.25pF	GQM2195G2H1R6CB12#	p175
			1.8pF	±0.1pF	GQM2195G2H1R8BB12#	p175
				±0.25pF	GQM2195G2H1R8CB12#	p175
			2.0pF	±0.1pF	GQM2195G2H2R0BB12#	p175
				±0.25pF	GQM2195G2H2R0CB12#	p175
			2.2pF	±0.1pF	GQM2195G2H2R2BB12#	p175
				±0.25pF	GQM2195G2H2R2CB12#	p175
			2.4pF	±0.1pF	GQM2195G2H2R4BB12#	p175
				±0.25pF	GQM2195G2H2R4CB12#	p175
			2.7pF	±0.1pF	GQM2195G2H2R7BB12#	p175
				±0.25pF	GQM2195G2H2R7CB12#	p175

*: Refers to the page of the "Specifications and Test Methods".

Part number # indicates the package specification code.

GRM
 GR3
 GRJ
 GR4
 GR7
 GJM
 GQM
 GA2
 GA3 GB
 GA3 GD
 GA3 GF
 LLL
 LLA
 LLM
 LLR
 NFM
 KRM
 KR3
 GMA
 GMD
 ⚠Caution /Notice

GQM Series Temperature Compensating Type Part Number List

(→ 2.0×1.25mm)

T max.	Rated Voltage	TC Code	Cap.	Tol.	Part Number	p*	T max.	Rated Voltage	TC Code	Cap.	Tol.	Part Number	p*		
1.0mm	500Vdc	X8G	3.0pF	±0.1pF	GQM2195G2H3R0BB12#	p175	1.0mm	500Vdc	X8G	22pF	±2%	GQM2195G2H220GB12#	p175		
				±0.25pF	GQM2195G2H3R0CB12#	p175					±5%	GQM2195G2H220JB12#	p175		
			3.3pF	±0.1pF	GQM2195G2H3R3BB12#	p175				250Vdc	COG	1.0pF	±0.1pF	GQM2195C2E1R0BB12#	p178
				±0.25pF	GQM2195G2H3R3CB12#	p175							±0.25pF	GQM2195C2E1R0CB12#	p178
			3.6pF	±0.1pF	GQM2195G2H3R6BB12#	p175						1.1pF	±0.1pF	GQM2195C2E1R1BB12#	p178
				±0.25pF	GQM2195G2H3R6CB12#	p175							±0.25pF	GQM2195C2E1R1CB12#	p178
			3.9pF	±0.1pF	GQM2195G2H3R9BB12#	p175						1.2pF	±0.1pF	GQM2195C2E1R2BB12#	p178
				±0.25pF	GQM2195G2H3R9CB12#	p175							±0.25pF	GQM2195C2E1R2CB12#	p178
			4.0pF	±0.1pF	GQM2195G2H4R0BB12#	p175						1.3pF	±0.1pF	GQM2195C2E1R3BB12#	p178
				±0.25pF	GQM2195G2H4R0CB12#	p175							±0.25pF	GQM2195C2E1R3CB12#	p178
			4.3pF	±0.1pF	GQM2195G2H4R3BB12#	p175						1.5pF	±0.1pF	GQM2195C2E1R5BB12#	p178
				±0.25pF	GQM2195G2H4R3CB12#	p175							±0.25pF	GQM2195C2E1R5CB12#	p178
			4.7pF	±0.1pF	GQM2195G2H4R7BB12#	p175						1.6pF	±0.1pF	GQM2195C2E1R6BB12#	p178
				±0.25pF	GQM2195G2H4R7CB12#	p175							±0.25pF	GQM2195C2E1R6CB12#	p178
			5.0pF	±0.1pF	GQM2195G2H5R0BB12#	p175						1.8pF	±0.1pF	GQM2195C2E1R8BB12#	p178
				±0.25pF	GQM2195G2H5R0CB12#	p175							±0.25pF	GQM2195C2E1R8CB12#	p178
			5.1pF	±0.25pF	GQM2195G2H5R1CB12#	p175						2.0pF	±0.1pF	GQM2195C2E2R0BB12#	p178
				±0.5pF	GQM2195G2H5R1DB12#	p175							±0.25pF	GQM2195C2E2R0CB12#	p178
			5.6pF	±0.25pF	GQM2195G2H5R6CB12#	p175						2.2pF	±0.1pF	GQM2195C2E2R2BB12#	p178
				±0.5pF	GQM2195G2H5R6DB12#	p175							±0.25pF	GQM2195C2E2R2CB12#	p178
			6.0pF	±0.25pF	GQM2195G2H6R0CB12#	p175						2.4pF	±0.1pF	GQM2195C2E2R4BB12#	p178
				±0.5pF	GQM2195G2H6R0DB12#	p175							±0.25pF	GQM2195C2E2R4CB12#	p178
			6.2pF	±0.25pF	GQM2195G2H6R2CB12#	p175						2.7pF	±0.1pF	GQM2195C2E2R7BB12#	p178
				±0.5pF	GQM2195G2H6R2DB12#	p175							±0.25pF	GQM2195C2E2R7CB12#	p178
			6.8pF	±0.25pF	GQM2195G2H6R8CB12#	p175		3.0pF	±0.1pF			GQM2195C2E3R0BB12#	p178		
				±0.5pF	GQM2195G2H6R8DB12#	p175			±0.25pF			GQM2195C2E3R0CB12#	p178		
			7.0pF	±0.25pF	GQM2195G2H7R0CB12#	p175		3.3pF	±0.1pF	GQM2195C2E3R3BB12#	p178				
				±0.5pF	GQM2195G2H7R0DB12#	p175			±0.25pF	GQM2195C2E3R3CB12#	p178				
			7.5pF	±0.25pF	GQM2195G2H7R5CB12#	p175		3.6pF	±0.1pF	GQM2195C2E3R6BB12#	p178				
				±0.5pF	GQM2195G2H7R5DB12#	p175			±0.25pF	GQM2195C2E3R6CB12#	p178				
			8.0pF	±0.25pF	GQM2195G2H8R0CB12#	p175		3.9pF	±0.1pF	GQM2195C2E3R9BB12#	p178				
				±0.5pF	GQM2195G2H8R0DB12#	p175			±0.25pF	GQM2195C2E3R9CB12#	p178				
			8.2pF	±0.25pF	GQM2195G2H8R2CB12#	p175		4.0pF	±0.1pF	GQM2195C2E4R0BB12#	p178				
				±0.5pF	GQM2195G2H8R2DB12#	p175			±0.25pF	GQM2195C2E4R0CB12#	p178				
			9.0pF	±0.25pF	GQM2195G2H9R0CB12#	p175		4.3pF	±0.1pF	GQM2195C2E4R3BB12#	p178				
				±0.5pF	GQM2195G2H9R0DB12#	p175			±0.25pF	GQM2195C2E4R3CB12#	p178				
			9.1pF	±0.25pF	GQM2195G2H9R1CB12#	p175		4.7pF	±0.1pF	GQM2195C2E4R7BB12#	p178				
				±0.5pF	GQM2195G2H9R1DB12#	p175			±0.25pF	GQM2195C2E4R7CB12#	p178				
			10pF	±2%	GQM2195G2H100GB12#	p175		5.0pF	±0.1pF	GQM2195C2E5R0BB12#	p178				
				±5%	GQM2195G2H100JB12#	p175			±0.25pF	GQM2195C2E5R0CB12#	p178				
			11pF	±2%	GQM2195G2H110GB12#	p175		5.1pF	±0.25pF	GQM2195C2E5R1CB12#	p178				
				±5%	GQM2195G2H110JB12#	p175			±0.5pF	GQM2195C2E5R1DB12#	p178				
			12pF	±2%	GQM2195G2H120GB12#	p175		5.6pF	±0.25pF	GQM2195C2E5R6CB12#	p178				
				±5%	GQM2195G2H120JB12#	p175			±0.5pF	GQM2195C2E5R6DB12#	p178				
			13pF	±2%	GQM2195G2H130GB12#	p175		6.0pF	±0.25pF	GQM2195C2E6R0CB12#	p178				
				±5%	GQM2195G2H130JB12#	p175			±0.5pF	GQM2195C2E6R0DB12#	p178				
			15pF	±2%	GQM2195G2H150GB12#	p175		6.2pF	±0.25pF	GQM2195C2E6R2CB12#	p178				
				±5%	GQM2195G2H150JB12#	p175			±0.5pF	GQM2195C2E6R2DB12#	p178				
16pF	±2%	GQM2195G2H160GB12#	p175	6.8pF	±0.25pF	GQM2195C2E6R8CB12#	p178								
	±5%	GQM2195G2H160JB12#	p175		±0.5pF	GQM2195C2E6R8DB12#	p178								
18pF	±2%	GQM2195G2H180GB12#	p175	7.0pF	±0.25pF	GQM2195C2E7R0CB12#	p178								
	±5%	GQM2195G2H180JB12#	p175		±0.5pF	GQM2195C2E7R0DB12#	p178								
20pF	±2%	GQM2195G2H200GB12#	p175	7.5pF	±0.25pF	GQM2195C2E7R5CB12#	p178								
	±5%	GQM2195G2H200JB12#	p175		±0.5pF	GQM2195C2E7R5DB12#	p178								

*: Refers to the page of the "Specifications and Test Methods".

Part number # indicates the package specification code.

GQM Series Temperature Compensating Type Part Number List

(→ 2.0×1.25mm)

T max.	Rated Voltage	TC Code	Cap.	Tol.	Part Number	p*
1.0mm	250Vdc	COG	8.0pF	±0.25pF	GQM2195C2E8R0CB12#	p178
				±0.5pF	GQM2195C2E8R0DB12#	p178
			8.2pF	±0.25pF	GQM2195C2E8R2CB12#	p178
				±0.5pF	GQM2195C2E8R2DB12#	p178
			9.0pF	±0.25pF	GQM2195C2E9R0CB12#	p178
				±0.5pF	GQM2195C2E9R0DB12#	p178
			9.1pF	±0.25pF	GQM2195C2E9R1CB12#	p178
				±0.5pF	GQM2195C2E9R1DB12#	p178
			10pF	±2%	GQM2195C2E100GB12#	p178
				±5%	GQM2195C2E100JB12#	p178
			11pF	±2%	GQM2195C2E110GB12#	p178
				±5%	GQM2195C2E110JB12#	p178
			12pF	±2%	GQM2195C2E120GB12#	p178
				±5%	GQM2195C2E120JB12#	p178
			13pF	±2%	GQM2195C2E130GB12#	p178
				±5%	GQM2195C2E130JB12#	p178
			15pF	±2%	GQM2195C2E150GB12#	p178
				±5%	GQM2195C2E150JB12#	p178
			16pF	±2%	GQM2195C2E160GB12#	p178
				±5%	GQM2195C2E160JB12#	p178
			18pF	±2%	GQM2195C2E180GB12#	p178
				±5%	GQM2195C2E180JB12#	p178
			20pF	±2%	GQM2195C2E200GB12#	p178
				±5%	GQM2195C2E200JB12#	p178
			22pF	±2%	GQM2195C2E220GB12#	p178
				±5%	GQM2195C2E220JB12#	p178
			24pF	±2%	GQM2195C2E240GB12#	p178
				±5%	GQM2195C2E240JB12#	p178
			27pF	±2%	GQM2195C2E270GB12#	p178
				±5%	GQM2195C2E270JB12#	p178
			30pF	±2%	GQM2195C2E300GB12#	p178
				±5%	GQM2195C2E300JB12#	p178
			33pF	±2%	GQM2195C2E330GB12#	p178
				±5%	GQM2195C2E330JB12#	p178
			36pF	±2%	GQM2195C2E360GB12#	p178
				±5%	GQM2195C2E360JB12#	p178
			39pF	±2%	GQM2195C2E390GB12#	p178
				±5%	GQM2195C2E390JB12#	p178
			43pF	±2%	GQM2195C2E430GB12#	p178
				±5%	GQM2195C2E430JB12#	p178
			47pF	±2%	GQM2195C2E470GB12#	p178
				±5%	GQM2195C2E470JB12#	p178
			51pF	±2%	GQM2195C2E510GB12#	p178
				±5%	GQM2195C2E510JB12#	p178
			56pF	±2%	GQM2195C2E560GB12#	p178
				±5%	GQM2195C2E560JB12#	p178
			62pF	±2%	GQM2195C2E620GB12#	p178
				±5%	GQM2195C2E620JB12#	p178
			68pF	±2%	GQM2195C2E680GB12#	p178
				±5%	GQM2195C2E680JB12#	p178
			75pF	±2%	GQM2195C2E750GB12#	p178
				±5%	GQM2195C2E750JB12#	p178
82pF	±2%	GQM2195C2E820GB12#	p178			
	±5%	GQM2195C2E820JB12#	p178			

T max.	Rated Voltage	TC Code	Cap.	Tol.	Part Number	p*	
1.0mm	250Vdc	COG	91pF	±2%	GQM2195C2E910GB12#	p178	
				±5%	GQM2195C2E910JB12#	p178	
			100pF	±2%	GQM2195C2E101GB12#	p178	
				±5%	GQM2195C2E101JB12#	p178	
			X8G	1.0pF	±0.1pF	GQM2195G2E1R0BB12#	p175
					±0.25pF	GQM2195G2E1R0CB12#	p175
				1.1pF	±0.1pF	GQM2195G2E1R1BB12#	p175
					±0.25pF	GQM2195G2E1R1CB12#	p175
				1.2pF	±0.1pF	GQM2195G2E1R2BB12#	p175
					±0.25pF	GQM2195G2E1R2CB12#	p175
				1.3pF	±0.1pF	GQM2195G2E1R3BB12#	p175
					±0.25pF	GQM2195G2E1R3CB12#	p175
				1.5pF	±0.1pF	GQM2195G2E1R5BB12#	p175
					±0.25pF	GQM2195G2E1R5CB12#	p175
				1.6pF	±0.1pF	GQM2195G2E1R6BB12#	p175
					±0.25pF	GQM2195G2E1R6CB12#	p175
				1.8pF	±0.1pF	GQM2195G2E1R8BB12#	p175
					±0.25pF	GQM2195G2E1R8CB12#	p175
				2.0pF	±0.1pF	GQM2195G2E2R0BB12#	p175
					±0.25pF	GQM2195G2E2R0CB12#	p175
				2.2pF	±0.1pF	GQM2195G2E2R2BB12#	p175
					±0.25pF	GQM2195G2E2R2CB12#	p175
				2.4pF	±0.1pF	GQM2195G2E2R4BB12#	p175
					±0.25pF	GQM2195G2E2R4CB12#	p175
		2.7pF		±0.1pF	GQM2195G2E2R7BB12#	p175	
				±0.25pF	GQM2195G2E2R7CB12#	p175	
		3.0pF		±0.1pF	GQM2195G2E3R0BB12#	p175	
				±0.25pF	GQM2195G2E3R0CB12#	p175	
		3.3pF		±0.1pF	GQM2195G2E3R3BB12#	p175	
				±0.25pF	GQM2195G2E3R3CB12#	p175	
		3.6pF		±0.1pF	GQM2195G2E3R6BB12#	p175	
				±0.25pF	GQM2195G2E3R6CB12#	p175	
		3.9pF	±0.1pF	GQM2195G2E3R9BB12#	p175		
			±0.25pF	GQM2195G2E3R9CB12#	p175		
		4.0pF	±0.1pF	GQM2195G2E4R0BB12#	p175		
			±0.25pF	GQM2195G2E4R0CB12#	p175		
		4.3pF	±0.1pF	GQM2195G2E4R3BB12#	p175		
			±0.25pF	GQM2195G2E4R3CB12#	p175		
		4.7pF	±0.1pF	GQM2195G2E4R7BB12#	p175		
			±0.25pF	GQM2195G2E4R7CB12#	p175		
		5.0pF	±0.1pF	GQM2195G2E5R0BB12#	p175		
			±0.25pF	GQM2195G2E5R0CB12#	p175		
		5.1pF	±0.25pF	GQM2195G2E5R1CB12#	p175		
			±0.5pF	GQM2195G2E5R1DB12#	p175		
		5.6pF	±0.25pF	GQM2195G2E5R6CB12#	p175		
			±0.5pF	GQM2195G2E5R6DB12#	p175		
		6.0pF	±0.25pF	GQM2195G2E6R0CB12#	p175		
			±0.5pF	GQM2195G2E6R0DB12#	p175		
		6.2pF	±0.25pF	GQM2195G2E6R2CB12#	p175		
			±0.5pF	GQM2195G2E6R2DB12#	p175		
		6.8pF	±0.25pF	GQM2195G2E6R8CB12#	p175		
			±0.5pF	GQM2195G2E6R8DB12#	p175		
7.0pF	±0.25pF	GQM2195G2E7R0CB12#	p175				
	±0.5pF	GQM2195G2E7R0DB12#	p175				

*: Refers to the page of the "Specifications and Test Methods".

Part number # indicates the package specification code.

GQM Series Temperature Compensating Type Part Number List

(→ 2.0×1.25mm)

T max.	Rated Voltage	TC Code	Cap.	Tol.	Part Number	p*
1.0mm	250Vdc	X8G	7.5pF	±0.25pF	GQM2195G2E7R5CB12#	p175
				±0.5pF	GQM2195G2E7R5DB12#	p175
			8.0pF	±0.25pF	GQM2195G2E8R0CB12#	p175
				±0.5pF	GQM2195G2E8R0DB12#	p175
			8.2pF	±0.25pF	GQM2195G2E8R2CB12#	p175
				±0.5pF	GQM2195G2E8R2DB12#	p175
			9.0pF	±0.25pF	GQM2195G2E9R0CB12#	p175
				±0.5pF	GQM2195G2E9R0DB12#	p175
			9.1pF	±0.25pF	GQM2195G2E9R1CB12#	p175
				±0.5pF	GQM2195G2E9R1DB12#	p175
			10pF	±2%	GQM2195G2E100GB12#	p175
				±5%	GQM2195G2E100JB12#	p175
			11pF	±2%	GQM2195G2E110GB12#	p175
				±5%	GQM2195G2E110JB12#	p175
			12pF	±2%	GQM2195G2E120GB12#	p175
				±5%	GQM2195G2E120JB12#	p175
			13pF	±2%	GQM2195G2E130GB12#	p175
				±5%	GQM2195G2E130JB12#	p175
			15pF	±2%	GQM2195G2E150GB12#	p175
				±5%	GQM2195G2E150JB12#	p175
			16pF	±2%	GQM2195G2E160GB12#	p175
				±5%	GQM2195G2E160JB12#	p175
			18pF	±2%	GQM2195G2E180GB12#	p175
				±5%	GQM2195G2E180JB12#	p175
			20pF	±2%	GQM2195G2E200GB12#	p175
				±5%	GQM2195G2E200JB12#	p175
			22pF	±2%	GQM2195G2E220GB12#	p175
				±5%	GQM2195G2E220JB12#	p175
			24pF	±2%	GQM2195G2E240GB12#	p175
				±5%	GQM2195G2E240JB12#	p175
			27pF	±2%	GQM2195G2E270GB12#	p175
				±5%	GQM2195G2E270JB12#	p175
			30pF	±2%	GQM2195G2E300GB12#	p175
				±5%	GQM2195G2E300JB12#	p175
			33pF	±2%	GQM2195G2E330GB12#	p175
				±5%	GQM2195G2E330JB12#	p175
			36pF	±2%	GQM2195G2E360GB12#	p175
				±5%	GQM2195G2E360JB12#	p175
			39pF	±2%	GQM2195G2E390GB12#	p175
				±5%	GQM2195G2E390JB12#	p175
			43pF	±2%	GQM2195G2E430GB12#	p175
				±5%	GQM2195G2E430JB12#	p175
			47pF	±2%	GQM2195G2E470GB12#	p175
				±5%	GQM2195G2E470JB12#	p175
			51pF	±2%	GQM2195G2E510GB12#	p175
				±5%	GQM2195G2E510JB12#	p175
			56pF	±2%	GQM2195G2E560GB12#	p175
				±5%	GQM2195G2E560JB12#	p175
			62pF	±2%	GQM2195G2E620GB12#	p175
				±5%	GQM2195G2E620JB12#	p175
			68pF	±2%	GQM2195G2E680GB12#	p175
				±5%	GQM2195G2E680JB12#	p175
			75pF	±2%	GQM2195G2E750GB12#	p175
				±5%	GQM2195G2E750JB12#	p175

T max.	Rated Voltage	TC Code	Cap.	Tol.	Part Number	p*
1.0mm	250Vdc	X8G	82pF	±2%	GQM2195G2E820GB12#	p175
				±5%	GQM2195G2E820JB12#	p175

2.8×2.8mm

T max.	Rated Voltage	TC Code	Cap.	Tol.	Part Number	p*
1.35mm	500Vdc	COG	1.0pF	±0.1pF	GQM22M5C2H1R0BB01#	p181
				±0.25pF	GQM22M5C2H1R0CB01#	p181
			1.1pF	±0.1pF	GQM22M5C2H1R1BB01#	p181
				±0.25pF	GQM22M5C2H1R1CB01#	p181
			1.2pF	±0.1pF	GQM22M5C2H1R2BB01#	p181
				±0.25pF	GQM22M5C2H1R2CB01#	p181
			1.3pF	±0.1pF	GQM22M5C2H1R3BB01#	p181
				±0.25pF	GQM22M5C2H1R3CB01#	p181
			1.5pF	±0.1pF	GQM22M5C2H1R5BB01#	p181
				±0.25pF	GQM22M5C2H1R5CB01#	p181
			1.6pF	±0.1pF	GQM22M5C2H1R6BB01#	p181
				±0.25pF	GQM22M5C2H1R6CB01#	p181
			1.8pF	±0.1pF	GQM22M5C2H1R8BB01#	p181
				±0.25pF	GQM22M5C2H1R8CB01#	p181
			2.0pF	±0.1pF	GQM22M5C2H2R0BB01#	p181
				±0.25pF	GQM22M5C2H2R0CB01#	p181
			2.2pF	±0.1pF	GQM22M5C2H2R2BB01#	p181
				±0.25pF	GQM22M5C2H2R2CB01#	p181
			2.4pF	±0.1pF	GQM22M5C2H2R4BB01#	p181
				±0.25pF	GQM22M5C2H2R4CB01#	p181
			2.7pF	±0.1pF	GQM22M5C2H2R7BB01#	p181
				±0.25pF	GQM22M5C2H2R7CB01#	p181
			3.0pF	±0.1pF	GQM22M5C2H3R0BB01#	p181
				±0.25pF	GQM22M5C2H3R0CB01#	p181
			3.3pF	±0.1pF	GQM22M5C2H3R3BB01#	p181
				±0.25pF	GQM22M5C2H3R3CB01#	p181
			3.6pF	±0.1pF	GQM22M5C2H3R6BB01#	p181
				±0.25pF	GQM22M5C2H3R6CB01#	p181
			3.9pF	±0.1pF	GQM22M5C2H3R9BB01#	p181
				±0.25pF	GQM22M5C2H3R9CB01#	p181
			4.0pF	±0.1pF	GQM22M5C2H4R0BB01#	p181
				±0.25pF	GQM22M5C2H4R0CB01#	p181
			4.3pF	±0.1pF	GQM22M5C2H4R3BB01#	p181
				±0.25pF	GQM22M5C2H4R3CB01#	p181
			4.7pF	±0.1pF	GQM22M5C2H4R7BB01#	p181
				±0.25pF	GQM22M5C2H4R7CB01#	p181
			5.0pF	±0.1pF	GQM22M5C2H5R0BB01#	p181
				±0.25pF	GQM22M5C2H5R0CB01#	p181
			5.1pF	±0.25pF	GQM22M5C2H5R1CB01#	p181
				±0.5pF	GQM22M5C2H5R1DB01#	p181
			5.6pF	±0.25pF	GQM22M5C2H5R6CB01#	p181
				±0.5pF	GQM22M5C2H5R6DB01#	p181
6.0pF	±0.25pF	GQM22M5C2H6R0CB01#	p181			
	±0.5pF	GQM22M5C2H6R0DB01#	p181			
6.2pF	±0.25pF	GQM22M5C2H6R2CB01#	p181			
	±0.5pF	GQM22M5C2H6R2DB01#	p181			
6.8pF	±0.25pF	GQM22M5C2H6R8CB01#	p181			

*: Refers to the page of the "Specifications and Test Methods".

Part number # indicates the package specification code.

GQM Series Temperature Compensating Type Part Number List

(→ 2.8×2.8mm)

T max.	Rated Voltage	TC Code	Cap.	Tol.	Part Number	p*
1.35mm	500Vdc	COG	6.8pF	±0.5pF	GQM22M5C2H6R8DB01#	p181
				±0.25pF	GQM22M5C2H7R0CB01#	p181
			7.0pF	±0.5pF	GQM22M5C2H7R0DB01#	p181
				±0.25pF	GQM22M5C2H7R5CB01#	p181
			7.5pF	±0.25pF	GQM22M5C2H7R5DB01#	p181
				±0.5pF	GQM22M5C2H8R0CB01#	p181
			8.0pF	±0.25pF	GQM22M5C2H8R0DB01#	p181
				±0.5pF	GQM22M5C2H8R2CB01#	p181
			8.2pF	±0.25pF	GQM22M5C2H8R2DB01#	p181
				±0.5pF	GQM22M5C2H9R0CB01#	p181
			9.0pF	±0.25pF	GQM22M5C2H9R0DB01#	p181
				±0.5pF	GQM22M5C2H9R1CB01#	p181
			9.1pF	±0.25pF	GQM22M5C2H9R1DB01#	p181
				±0.5pF	GQM22M5C2H100GB01#	p181
			10pF	±2%	GQM22M5C2H100JB01#	p181
				±5%	GQM22M5C2H110GB01#	p181
			11pF	±2%	GQM22M5C2H110JB01#	p181
				±5%	GQM22M5C2H120GB01#	p181
			12pF	±2%	GQM22M5C2H120JB01#	p181
				±5%	GQM22M5C2H130GB01#	p181
			13pF	±2%	GQM22M5C2H130JB01#	p181
				±5%	GQM22M5C2H150GB01#	p181
			15pF	±2%	GQM22M5C2H150JB01#	p181
				±5%	GQM22M5C2H160GB01#	p181
			16pF	±2%	GQM22M5C2H160JB01#	p181
				±5%	GQM22M5C2H180GB01#	p181
			18pF	±2%	GQM22M5C2H180JB01#	p181
				±5%	GQM22M5C2H200GB01#	p181
			20pF	±2%	GQM22M5C2H200JB01#	p181
				±5%	GQM22M5C2H220GB01#	p181
			22pF	±2%	GQM22M5C2H220JB01#	p181
				±5%	GQM22M5C2H240GB01#	p181
			24pF	±2%	GQM22M5C2H240JB01#	p181
				±5%	GQM22M5C2H270GB01#	p181
			27pF	±2%	GQM22M5C2H270JB01#	p181
				±5%	GQM22M5C2H300GB01#	p181
			30pF	±2%	GQM22M5C2H300JB01#	p181
				±5%	GQM22M5C2H330GB01#	p181
			33pF	±2%	GQM22M5C2H330JB01#	p181
				±5%	GQM22M5C2H360GB01#	p181
			36pF	±2%	GQM22M5C2H360JB01#	p181
				±5%	GQM22M5C2H390GB01#	p181
			39pF	±2%	GQM22M5C2H390JB01#	p181
				±5%	GQM22M5C2H430GB01#	p181
			43pF	±2%	GQM22M5C2H430JB01#	p181
				±5%	GQM22M5C2H470GB01#	p181
			47pF	±2%	GQM22M5C2H470JB01#	p181
				±5%	GQM22M5C2H510GB01#	p181
			51pF	±2%	GQM22M5C2H510JB01#	p181
				±5%	GQM22M5C2H560GB01#	p181
			56pF	±2%	GQM22M5C2H560JB01#	p181
				±5%	GQM22M5C2H620GB01#	p181
			62pF	±2%	GQM22M5C2H620JB01#	p181
				±5%	GQM22M5C2H680GB01#	p181
68pF	±2%	GQM22M5C2H680GB01#	p181			

T max.	Rated Voltage	TC Code	Cap.	Tol.	Part Number	p*
1.35mm	500Vdc	COG	68pF	±5%	GQM22M5C2H680JB01#	p181
				±2%	GQM22M5C2H750GB01#	p181
			75pF	±2%	GQM22M5C2H750JB01#	p181
				±5%	GQM22M5C2H820GB01#	p181
			82pF	±2%	GQM22M5C2H820JB01#	p181
				±5%	GQM22M5C2H910GB01#	p181
			91pF	±2%	GQM22M5C2H910JB01#	p181
				±5%	GQM22M5C2H101GB01#	p181
			100pF	±2%	GQM22M5C2H101JB01#	p181
				±5%	GQM22M5C2H101JB01#	p181

*: Refers to the page of the "Specifications and Test Methods".

Part number # indicates the package specification code.

GRM
 GR3
 GRJ
 GRU
 GR4
 GR7
 GJM
 GQM
 GA2
 GA3 GB
 GA3 GD
 GA3 GF
 LLL
 LLA
 LLM
 LLR
 NFM
 KRM
 KR3
 GMA
 GMD
 ⚠Caution / Notice

1

GQM Series Specifications and Test Methods (1)

No	Item	Specification	Test Method (Ref. Standard: JIS C 5101, IEC60384)												
1	Rated Voltage	Shown in Rated value.	The rated voltage is defined as the maximum voltage which may be applied continuously to the capacitor. When AC voltage is superimposed on DC voltage, V^{P-P} or V^{O-P} , whichever is larger, should be maintained within the rated voltage range.												
2	Appearance	No defects or abnormalities.	Visual inspection.												
3	Dimension	Within the specified dimensions.	Using Measuring instrument of dimension.												
4	Voltage Proof	No defects or abnormalities.	Measurement Point: Between the terminations Applied Time: 1 to 5s Charge/discharge current: 50mA max. Test Voltage: <table border="1" style="margin-left: 20px;"> <thead> <tr> <th>Rated Voltage</th> <th>Test Voltage</th> </tr> </thead> <tbody> <tr> <td>100V</td> <td>300% of Rated Voltage</td> </tr> <tr> <td>200V</td> <td>250% of Rated Voltage</td> </tr> </tbody> </table>	Rated Voltage	Test Voltage	100V	300% of Rated Voltage	200V	250% of Rated Voltage						
Rated Voltage	Test Voltage														
100V	300% of Rated Voltage														
200V	250% of Rated Voltage														
5	Insulation Resistance (I.R.)	More than 10000MΩ	Measurement Point: Between the terminations Measurement Voltage: DC Rated Voltage Charging Time: 2min Charge/discharge current: 50mA max. Measurement Temperature: Room Temperature												
6	Capacitance	Shown in Rated value.	Measurement Temperature: Room Temperature												
7	Q	30pF and over: $Q \geq 1400$ 30pF and below: $Q \geq 800+20C$ C: Nominal Capacitance(pF)	<table border="1" style="margin-left: 20px;"> <thead> <tr> <th>Capacitance</th> <th>Frequency</th> <th>Voltage</th> </tr> </thead> <tbody> <tr> <td>$C \leq 1000pF$</td> <td>1.0±0.1kHz</td> <td>0.5 to 5.0Vrms</td> </tr> </tbody> </table>	Capacitance	Frequency	Voltage	$C \leq 1000pF$	1.0±0.1kHz	0.5 to 5.0Vrms						
Capacitance	Frequency	Voltage													
$C \leq 1000pF$	1.0±0.1kHz	0.5 to 5.0Vrms													
8	Temperature Characteristics of Capacitance	Nominal values of the temperature coefficient is shown in Rated value. But, the Capacitance Change under 25°C is shown in Table A. Capacitance Drift Within ±0.2% or ±0.05pF (Whichever is larger.)	The capacitance change should be measured after 5 minutes at each specified temp. stage. Capacitance value as a reference is the value in step 3. The capacitance drift is calculated by dividing the differences between the maximum and minimum measured values in the step 1, 3 and 5 by the cap. value in step 3. <table border="1" style="margin-left: 20px;"> <thead> <tr> <th>Step</th> <th>Temperature (°C)</th> </tr> </thead> <tbody> <tr> <td>1</td> <td>Reference Temp. ±2</td> </tr> <tr> <td>2</td> <td>Min. Operating Temp. ±3</td> </tr> <tr> <td>3</td> <td>Reference Temp. ±2</td> </tr> <tr> <td>4</td> <td>Max. Operating Temp. ±3</td> </tr> <tr> <td>5</td> <td>Reference Temp. ±2</td> </tr> </tbody> </table>	Step	Temperature (°C)	1	Reference Temp. ±2	2	Min. Operating Temp. ±3	3	Reference Temp. ±2	4	Max. Operating Temp. ±3	5	Reference Temp. ±2
Step	Temperature (°C)														
1	Reference Temp. ±2														
2	Min. Operating Temp. ±3														
3	Reference Temp. ±2														
4	Max. Operating Temp. ±3														
5	Reference Temp. ±2														
9	Adhesive Strength of Termination	No removal of the terminations or other defect should occur.	Solder the capacitor on the test substrate shown in Fig.3. Applied Force: 5N Holding Time: 10±1s Applied Direction: In parallel with the test substrate and vertical with the capacitor side.												
10	Vibration	Appearance	No defects or abnormalities.												
		Capacitance	Within the specified initial value.												
		Q	Within the specified initial value.												
11	Substrate Bending Test	Appearance	No defects or abnormalities.												
		Capacitance Change	Within ±5% or ±0.5pF (Whichever is larger)												
12	Solderability	95% of the terminations is to be soldered evenly and continuously.	Test Method: Solder bath method Flux: Solution of rosin ethanol 25 (mass)% Preheat: 80 to 120°C for 10 to 30s Solder: Sn-3.0Ag-0.5Cu Solder Temp.: 245±5°C Immersion time: 2±0.5s												
13	Resistance to Soldering Heat	Appearance	No defects or abnormalities.												
		Capacitance Change	Within ±2.5% or ±0.25pF (Whichever is larger)												
		Q	Within the specified initial value.												
		I.R.	Within the specified initial value.												
		Voltage Proof	No defects.												

Continued on the following page. ↗

GRM
 GR3
 GRJ
 GR4
 GR7
 GJM
 GQM
 GA2
 GA3
 GB
 GA3
 GD
 GA3
 GF
 LLL
 LLA
 LLM
 LLR
 NFM
 KRM
 KR3
 GMA
 GMD
 ⚠Caution /Notice

GQM Series Specifications and Test Methods (1)

Continued from the preceding page. ↘

No	Item	Specification	Test Method (Ref. Standard: JIS C 5101, IEC60384)															
14	Temperature Sudden Change	Appearance	Solder the capacitor on the test substrate shown in Fig.3. Perform the 5 cycles according to the four heat treatments shown in the following table. <table border="1" style="margin: 5px 0;"><thead> <tr> <th>Step</th> <th>Temp. (°C)</th> <th>Time (min)</th> </tr> </thead> <tbody> <tr> <td>1</td> <td>Min. Operating Temp. +0/-3</td> <td>30±3</td> </tr> <tr> <td>2</td> <td>Room Temp.</td> <td>2 to 3</td> </tr> <tr> <td>3</td> <td>Max. Operating Temp. +3/-0</td> <td>30±3</td> </tr> <tr> <td>4</td> <td>Room Temp.</td> <td>2 to 3</td> </tr> </tbody> </table> Exposure Time: 24±2h	Step	Temp. (°C)	Time (min)	1	Min. Operating Temp. +0/-3	30±3	2	Room Temp.	2 to 3	3	Max. Operating Temp. +3/-0	30±3	4	Room Temp.	2 to 3
		Step		Temp. (°C)	Time (min)													
		1		Min. Operating Temp. +0/-3	30±3													
		2		Room Temp.	2 to 3													
		3		Max. Operating Temp. +3/-0	30±3													
4	Room Temp.	2 to 3																
Capacitance Change	Within ±2.5% or ±0.25pF (Whichever is larger)																	
Q	Within the specified initial value.																	
I.R.	Within the specified initial value.																	
Voltage Proof	No defects.																	
15	High Temperature High Humidity (Steady)	Appearance	Solder the capacitor on the test substrate shown in Fig.3. Test Temperature: 40±2°C Test Humidity: 90 to 95%RH Test Time: 500±12h Applied Voltage: DC Rated Voltage Charge/discharge current: 50mA max. Exposure Time: 24±2h															
		Capacitance Change		Within ±7.5% or ±0.75pF (Whichever is larger)														
		Q		30pF and over: $Q \geq 200$ 30pF and below: $Q \geq 100+10C/3$ C: Nominal Capacitance(pF)														
		I.R.		More than 500MΩ														
16	Durability	Appearance	Solder the capacitor on the test substrate shown in Fig.3. Test Temperature: Max. Operating Temp. ±3°C Test Time: 1000±12h Applied Voltage: 200% of the rated voltage Charge/discharge current: 50mA max. Exposure Time: 24±2h															
		Capacitance Change		Within ±3% or ±0.3pF (Whichever is larger)														
		Q		30pF and over: $Q \geq 350$ 10pF and over, 30pF and below: $Q \geq 275+5C/2$ 10pF and below: $Q \geq 200+10C$ C: Nominal Capacitance (pF)														
		I.R.		More than 1000MΩ														

Table A

Char.	Capacitance Change from 25°C(%)					
	-55°C		-30°C		-10°C	
	Max.	Min.	Max.	Min.	Max.	Min.
5C	0.58	-0.24	0.40	-0.17	0.25	-0.11

Continued on the following page. ↗

GRM
 GR3
 GRJ
 GR4
 GR7
 GJM
GQM
 GA2
 GA3 GB
 GA3 GD
 GA3 GF
 LLL
 LLA
 LLM
 LLR
 NFM
 KPM
 KR3
 GMA
 GMD
 ⚠Caution / Notice

GQM Series Specifications and Test Methods (1)

Continued from the preceding page. ↘

Substrate Bending Test

• Test Substrate

Material: Copper-clad laminated sheets for PCBs (Glass fabric base, epoxy resin)
 Thickness: 0.8mm
 Copper foil thickness: 0.035mm
 [Grey Box] : Solder resist (Coat with heat resistant resin for solder)

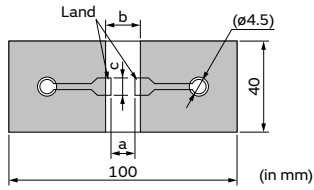

Part Number	Dimension (mm)		
	a	b	c
GQM15	0.4	1.5	0.5

Fig.1

- Kind of Solder: Sn-3.0Ag-0.5Cu
- Pressurization Method

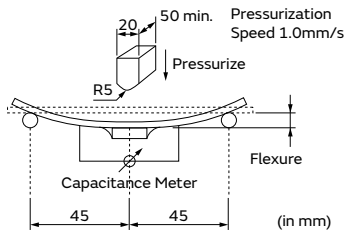

Fig.2

Adhesive Strength of Termination, Vibration, Temperature Sudden Change, High Temperature High Humidity (Steady) , Durability

• Test Substrate

Material: Copper-clad laminated sheets for PCBs (Glass fabric base, epoxy resin)
 Thickness: 1.6mm or 0.8mm
 Copper foil thickness: 0.035mm

- Kind of Solder: Sn-3.0Ag-0.5Cu
- Land Dimensions

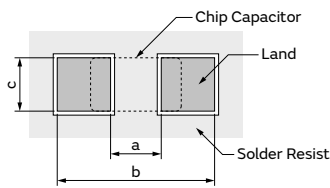

Part Number	Dimension (mm)		
	a	b	c
GQM15	0.4	1.5	0.5

Fig.3

GRM
 GR3
 GRJ
 GR4
 GR7
 GJM
GQM
 GA2
 GA3 GB
 GA3 GD
 GA3 GF
 LLL
 LLA
 LLM
 LLR
 NFM
 KRM
 KR3
 GMA
 GMD
 ⚠Caution /Notice

2

GQM Series Specifications and Test Methods (2)

No	Item	Specification	Test Method (Ref. Standard: JIS C 5101, IEC60384)												
1	Rated Voltage	Shown in Rated value.	The rated voltage is defined as the maximum voltage which may be applied continuously to the capacitor. When AC voltage is superimposed on DC voltage, V^{P-P} or V^{O-P} , whichever is larger, should be maintained within the rated voltage range.												
2	Appearance	No defects or abnormalities.	Visual inspection.												
3	Dimension	Within the specified dimensions.	Using Measuring instrument of dimension.												
4	Voltage Proof	No defects or abnormalities.	Measurement Point: Between the terminations Test Voltage : 250% of the rated voltage Applied Time: 1 to 5s Charge/discharge current: 50mA max.												
5	Insulation Resistance (I.R.)	More than 10000MΩ	Measurement Point: Between the terminations Measurement Voltage: DC Rated Voltage Charging Time: 1min Charge/discharge current: 50mA max. Measurement Temperature: Room Temperature												
6	Capacitance	Shown in Rated value.	Measurement Temperature :Room Temperature <table border="1"> <thead> <tr> <th>Capacitance</th> <th>Frequency</th> <th>Voltage</th> </tr> </thead> <tbody> <tr> <td>$C \leq 1000\text{pF}$</td> <td>1.0±0.1MHz</td> <td>0.5 to 5.0Vrms</td> </tr> </tbody> </table>	Capacitance	Frequency	Voltage	$C \leq 1000\text{pF}$	1.0±0.1MHz	0.5 to 5.0Vrms						
Capacitance	Frequency	Voltage													
$C \leq 1000\text{pF}$	1.0±0.1MHz	0.5 to 5.0Vrms													
7	Q	30pF and over: $Q \geq 1400$ 30pF and below: $Q \geq 800+20C$ C: Nominal Capacitance(pF)													
8	Temperature Characteristics of Capacitance	Nominal values of the temperature coefficient is shown in Rated value. But, the Capacitance Change under 20°C/25°C is shown in Table A. Capacitance Drift Within ±0.2% or ±0.05pF (Whichever is larger.)	The capacitance change should be measured after 5 minutes at each specified temp. stage. Capacitance value as a reference is the value in step 3. The capacitance drift is calculated by dividing the differences between the maximum and minimum measured values in the step 1, 3 and 5 by the cap. value in step 3. <table border="1"> <thead> <tr> <th>Step</th> <th>Temperature (°C)</th> </tr> </thead> <tbody> <tr> <td>1</td> <td>Reference Temp. ±2</td> </tr> <tr> <td>2</td> <td>Min. Operating Temp. ±3</td> </tr> <tr> <td>3</td> <td>Reference Temp. ±2</td> </tr> <tr> <td>4</td> <td>Max. Operating Temp. ±3</td> </tr> <tr> <td>5</td> <td>Reference Temp. ±2</td> </tr> </tbody> </table>	Step	Temperature (°C)	1	Reference Temp. ±2	2	Min. Operating Temp. ±3	3	Reference Temp. ±2	4	Max. Operating Temp. ±3	5	Reference Temp. ±2
Step	Temperature (°C)														
1	Reference Temp. ±2														
2	Min. Operating Temp. ±3														
3	Reference Temp. ±2														
4	Max. Operating Temp. ±3														
5	Reference Temp. ±2														
9	Adhesive Strength of Termination	No removal of the terminations or other defect should occur.	Solder the capacitor on the test substrate shown in Fig.3. <table border="1"> <thead> <tr> <th>Part Number</th> <th>Applied Force(N)</th> </tr> </thead> <tbody> <tr> <td>GQM18</td> <td>5</td> </tr> <tr> <td>GQM21</td> <td>10</td> </tr> </tbody> </table> Holding Time: 10±1s Applied Direction: In parallel with the test substrate and vertical with the capacitor side.	Part Number	Applied Force(N)	GQM18	5	GQM21	10						
Part Number	Applied Force(N)														
GQM18	5														
GQM21	10														
10	Vibration	Appearance	Solder the capacitor on the test substrate shown in Fig.3. Kind of Vibration: A simple harmonic motion 10Hz to 55Hz to 10Hz (1min) Total amplitude: 1.5mm This motion should be applied for a period of 2h in each 3 mutually perpendicular directions (total of 6h).												
		Capacitance													
		Q													
11	Substrate Bending Test	Appearance	Solder the capacitor on the test substrate shown in Fig.1. Pressurization method: Shown in Fig.2 Flexure: 1mm Holding Time: 5±1s Soldering Method: Reflow soldering												
		Capacitance Change													
12	Solderability	95% of the terminations is to be soldered evenly and continuously.	Test Method: Solder bath method Flux: Solution of rosin ethanol 25 (mass)% Preheat: 80 to 120°C for 10 to 30s Solder: Sn-3.0Ag-0.5Cu Solder Temp.: 245±5°C Immersion time: 2±0.5s												

Continued on the following page. ↗

GRM
 GR3
 GRJ
 GR4
 GR7
 GJM
GQM
 GA2
 GA3 GB
 GA3 GD
 GA3 GF
 LLL
 LLA
 LLM
 LLR
 NFM
 KPM
 KR3
 GMA
 GMD
 ⚠Caution / Notice

GQM Series Specifications and Test Methods (2)

Continued from the preceding page. ↘

No	Item	Specification	Test Method (Ref. Standard: JIS C 5101, IEC60384)															
13	Resistance to Soldering Heat	Appearance	No defects or abnormalities.															
		Capacitance Change	Within $\pm 2.5\%$ or $\pm 0.25\text{pF}$ (Whichever is larger)															
		Q	Within the specified initial value.															
		I.R.	Within the specified initial value.															
		Voltage Proof	No defects.															
14	Temperature Sudden Change	Appearance	No defects or abnormalities.															
		Capacitance Change	Within $\pm 2.5\%$ or $\pm 0.25\text{pF}$ (Whichever is larger)															
		Q	Within the specified initial value.															
		I.R.	Within the specified initial value.															
		Voltage Proof	No defects.															
			Solder the capacitor on the test substrate shown in Fig.3. Perform the 5 cycles according to the four heat treatments shown in the following table. <table border="1" style="margin-left: 20px;"> <thead> <tr> <th>Step</th> <th>Temp. (°C)</th> <th>Time (min)</th> </tr> </thead> <tbody> <tr> <td>1</td> <td>Min. Operating Temp. +0/-3</td> <td>30±3</td> </tr> <tr> <td>2</td> <td>Room Temp.</td> <td>2 to 3</td> </tr> <tr> <td>3</td> <td>Max. Operating Temp. +3/-0</td> <td>30±3</td> </tr> <tr> <td>4</td> <td>Room Temp.</td> <td>2 to 3</td> </tr> </tbody> </table> Exposure Time: 24±2h	Step	Temp. (°C)	Time (min)	1	Min. Operating Temp. +0/-3	30±3	2	Room Temp.	2 to 3	3	Max. Operating Temp. +3/-0	30±3	4	Room Temp.	2 to 3
Step	Temp. (°C)	Time (min)																
1	Min. Operating Temp. +0/-3	30±3																
2	Room Temp.	2 to 3																
3	Max. Operating Temp. +3/-0	30±3																
4	Room Temp.	2 to 3																
15	High Temperature High Humidity (Steady)	Appearance	No defects or abnormalities.															
		Capacitance Change	Within $\pm 7.5\%$ or $\pm 0.75\text{pF}$ (Whichever is larger)															
		Q	30pF and over: $Q \geq 200$ 30pF and below: $Q \geq 100+10C/3$ C: Nominal Capacitance(pF)															
		I.R.	More than 500MΩ															
			Solder the capacitor on the test substrate shown in Fig.3. Test Temperature: 40±2°C Test Humidity: 90 to 95%RH Test Time: 500±12h Applied Voltage: DC Rated Voltage Charge/discharge current: 50mA max. Exposure Time: 24±2h															
16	Durability	Appearance	No defects or abnormalities.															
		Capacitance Change	Within $\pm 3\%$ or $\pm 0.3\text{pF}$ (Whichever is larger)															
		Q	30pF and over: $Q \geq 350$ 10pF and over, 30pF and below: $Q \geq 275+5C/2$ 10pF and below: $Q \geq 200+10C$ C: Nominal Capacitance (pF)															
		I.R.	More than 1000MΩ															
			Solder the capacitor on the test substrate shown in Fig.3. Test Temperature: Max. Operating Temp. $\pm 3^\circ\text{C}$ Test Time: 1000±12h Applied Voltage: 200% of the rated voltage Charge/discharge current: 50mA max. Exposure Time: 24±2h															

Table A

Char.	Capacitance Change from 20°C/25°C (%)							
	-55°C		-30°C		-25°C		-10°C	
	Max.	Min.	Max.	Min.	Max.	Min.	Max.	Min.
2C	0.82	-0.45	-	-	0.49	-0.27	0.33	-0.18
5C/5G	0.58	-0.24	0.40	-0.17	-	-	0.25	-0.11

Continued on the following page. ↗

GQM Series Specifications and Test Methods (2)

Continued from the preceding page. ↘

Substrate Bending Test

• Test Substrate

Material: Copper-clad laminated sheets for PCBs (Glass fabric base, epoxy resin)
 Thickness: 1.6mm
 Copper foil thickness: 0.035mm
 [Shaded Area]: Solder resist (Coat with heat resistant resin for solder)

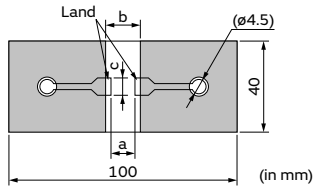

Part Number	Dimension (mm)		
	a	b	c
GQM18	1.0	3.0	1.2
GQM21	1.2	4.0	1.65

Fig.1

- Kind of Solder: Sn-3.0Ag-0.5Cu
- Pressurization Method

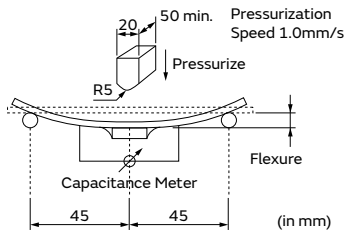

Fig.2

Adhesive Strength of Termination, Vibration, Temperature Sudden Change, High Temperature High Humidity (Steady) , Durability

• Test Substrate

Material: Copper-clad laminated sheets for PCBs (Glass fabric base, epoxy resin)
 Thickness: 1.6mm or 0.8mm
 Copper foil thickness: 0.035mm

- Kind of Solder: Sn-3.0Ag-0.5Cu
- Land Dimensions

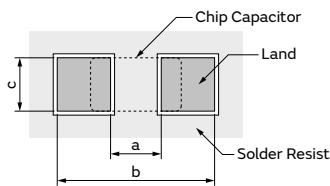

Part Number	Dimension (mm)		
	a	b	c
GQM18	1.0	3.0	1.2
GQM21	1.2	4.0	1.65

Fig.3

GRM
 GR3
 GRJ
 GR4
 GR7
 GJM
GQM
 GA2
 GA3 GB
 GA3 GD
 GA3 GF
 LLL
 LLA
 LLM
 LLR
 NFM
 KPM
 KR3
 GMA
 GMD
 ⚠Caution / Notice

3

GQM Series Specifications and Test Methods (3)

No	Item	Specification	Test Method (Ref. Standard: JIS C 5101, IEC60384)												
1	Rated Voltage	Shown in Rated value.	The rated voltage is defined as the maximum voltage which may be applied continuously to the capacitor. When AC voltage is superimposed on DC voltage, V^{P-P} or V^{O-P} , whichever is larger, should be maintained within the rated voltage range.												
2	Appearance	No defects or abnormalities.	Visual inspection.												
3	Dimension	Within the specified dimensions.	Using Measuring instrument of dimension.												
4	Voltage Proof	No defects or abnormalities.	Measurement Point: Between the terminations Test Voltage: 250% of the rated voltage Applied Time: 1 to 5s Charge/discharge current: 50mA max.												
5	Insulation Resistance (I.R.)	More than 10000MΩ	Measurement Point: Between the terminations Measurement Voltage: DC Rated Voltage Charging Time: 2min Charge/discharge current: 50mA max. Measurement Temperature: Room Temperature												
6	Capacitance	Shown in Rated value.	Measurement Temperature: Room Temperature												
7	Q	30pF and over: $Q \geq 1400$ 30pF and below: $Q \geq 800+20C$ C: Nominal Capacitance (pF)	<table border="1"> <thead> <tr> <th>Capacitance</th> <th>Frequency</th> <th>Voltage</th> </tr> </thead> <tbody> <tr> <td>$C \leq 1000pF$</td> <td>1.0±0.1kHz</td> <td>0.5 to 5.0Vrms</td> </tr> </tbody> </table>	Capacitance	Frequency	Voltage	$C \leq 1000pF$	1.0±0.1kHz	0.5 to 5.0Vrms						
Capacitance	Frequency	Voltage													
$C \leq 1000pF$	1.0±0.1kHz	0.5 to 5.0Vrms													
8	Temperature Characteristics of Capacitance	Nominal values of the temperature coefficient is shown in Rated value. But, the Capacitance Change under 20°C/25°C is shown in Table A. Capacitance Drift Within ±0.2% or ±0.05pF (Whichever is larger.)	The capacitance change should be measured after 5 minutes at each specified temp. stage. Capacitance value as a reference is the value in step 3. The capacitance drift is calculated by dividing the differences between the maximum and minimum measured values in the step 1, 3 and 5 by the cap. value in step 3. <table border="1"> <thead> <tr> <th>Step</th> <th>Temperature (°C)</th> </tr> </thead> <tbody> <tr> <td>1</td> <td>Reference Temp. ±2</td> </tr> <tr> <td>2</td> <td>Min. Operating Temp. ±3</td> </tr> <tr> <td>3</td> <td>Reference Temp. ±2</td> </tr> <tr> <td>4</td> <td>Max. Operating Temp. ±3</td> </tr> <tr> <td>5</td> <td>Reference Temp. ±2</td> </tr> </tbody> </table>	Step	Temperature (°C)	1	Reference Temp. ±2	2	Min. Operating Temp. ±3	3	Reference Temp. ±2	4	Max. Operating Temp. ±3	5	Reference Temp. ±2
Step	Temperature (°C)														
1	Reference Temp. ±2														
2	Min. Operating Temp. ±3														
3	Reference Temp. ±2														
4	Max. Operating Temp. ±3														
5	Reference Temp. ±2														
9	Adhesive Strength of Termination	No removal of the terminations or other defect should occur.	Solder the capacitor on the test substrate shown in Fig.3. <table border="1"> <thead> <tr> <th>Part Number</th> <th>Applied Force(N)</th> </tr> </thead> <tbody> <tr> <td>GQM18</td> <td>5</td> </tr> <tr> <td>GQM21</td> <td>10</td> </tr> </tbody> </table> Holding Time: 10±1s Applied Direction: In parallel with the test substrate and vertical with the capacitor side.	Part Number	Applied Force(N)	GQM18	5	GQM21	10						
Part Number	Applied Force(N)														
GQM18	5														
GQM21	10														
10	Vibration	<table border="1"> <tr> <td>Appearance</td> <td>No defects or abnormalities.</td> </tr> <tr> <td>Capacitance</td> <td>Within the specified initial value.</td> </tr> <tr> <td>Q</td> <td>Within the specified initial value.</td> </tr> </table>	Appearance	No defects or abnormalities.	Capacitance	Within the specified initial value.	Q	Within the specified initial value.	Solder the capacitor on the test substrate shown in Fig.3. Kind of Vibration: A simple harmonic motion 10Hz to 55Hz to 10Hz (1min) Total amplitude: 1.5mm This motion should be applied for a period of 2h in each 3 mutually perpendicular directions (total of 6h).						
Appearance	No defects or abnormalities.														
Capacitance	Within the specified initial value.														
Q	Within the specified initial value.														
11	Substrate Bending Test	<table border="1"> <tr> <td>Appearance</td> <td>No defects or abnormalities.</td> </tr> <tr> <td>Capacitance Change</td> <td>Within ±5% or ±0.5pF (Whichever is larger)</td> </tr> </table>	Appearance	No defects or abnormalities.	Capacitance Change	Within ±5% or ±0.5pF (Whichever is larger)	Solder the capacitor on the test substrate shown in Fig.1. Pressurization method: Shown in Fig.2 Flexure: 1mm Holding Time: 5±1s Soldering Method: Reflow soldering								
Appearance	No defects or abnormalities.														
Capacitance Change	Within ±5% or ±0.5pF (Whichever is larger)														
12	Solderability	95% of the terminations is to be soldered evenly and continuously.	Test Method: Solder bath method Flux: Solution of rosin ethanol 25 (mass)% Preheat: 80 to 120°C for 10 to 30s Solder: Sn-3.0Ag-0.5Cu Solder Temp.: 245±5°C Immersion time: 2±0.5s												
13	Resistance to Soldering Heat	<table border="1"> <tr> <td>Appearance</td> <td>No defects or abnormalities.</td> </tr> <tr> <td>Capacitance Change</td> <td>Within ±2.5% or ± 0.25pF (Whichever is larger)</td> </tr> <tr> <td>Q</td> <td>Within the specified initial value.</td> </tr> <tr> <td>I.R.</td> <td>Within the specified initial value.</td> </tr> <tr> <td>Voltage Proof</td> <td>No defects.</td> </tr> </table>	Appearance	No defects or abnormalities.	Capacitance Change	Within ±2.5% or ± 0.25pF (Whichever is larger)	Q	Within the specified initial value.	I.R.	Within the specified initial value.	Voltage Proof	No defects.	Test Method: Solder bath method Solder: Sn-3.0Ag-0.5Cu Solder Temp.: 270±5°C Immersion time: 10±0.5s Exposure Time: 24±2h Preheat: 120 to 150°C for 1min		
Appearance	No defects or abnormalities.														
Capacitance Change	Within ±2.5% or ± 0.25pF (Whichever is larger)														
Q	Within the specified initial value.														
I.R.	Within the specified initial value.														
Voltage Proof	No defects.														

Continued on the following page. ↗

GRM
 GR3
 GRJ
 GR4
 GR7
 GJM
GQM
 GA2
 GA3
 GB
 GA3
 GD
 GA3
 GF
 LLL
 LLA
 LLM
 LLR
 NFM
 KRM
 KR3
 GMA
 GMD
 ⚠Caution /Notice

GQM Series Specifications and Test Methods (3)

Continued from the preceding page. ↘

No	Item	Specification	Test Method (Ref. Standard: JIS C 5101, IEC60384)															
14	Temperature Sudden Change	Appearance	Solder the capacitor on the test substrate shown in Fig.3. Perform the 5 cycles according to the four heat treatments shown in the following table. <table border="1" style="margin: 5px 0;"><thead> <tr> <th>Step</th> <th>Temp. (°C)</th> <th>Time (min)</th> </tr> </thead> <tbody> <tr> <td>1</td> <td>Min. Operating Temp. +0/-3</td> <td>30±3</td> </tr> <tr> <td>2</td> <td>Room Temp.</td> <td>2 to 3</td> </tr> <tr> <td>3</td> <td>Max. Operating Temp. +3/-0</td> <td>30±3</td> </tr> <tr> <td>4</td> <td>Room Temp.</td> <td>2 to 3</td> </tr> </tbody> </table> Exposure Time: 24±2h	Step	Temp. (°C)	Time (min)	1	Min. Operating Temp. +0/-3	30±3	2	Room Temp.	2 to 3	3	Max. Operating Temp. +3/-0	30±3	4	Room Temp.	2 to 3
		Step		Temp. (°C)	Time (min)													
		1		Min. Operating Temp. +0/-3	30±3													
		2		Room Temp.	2 to 3													
		3		Max. Operating Temp. +3/-0	30±3													
4	Room Temp.	2 to 3																
Capacitance Change	Within ±2.5% or ±0.25pF (Whichever is larger)																	
Q	Within the specified initial value.																	
I.R.	Within the specified initial value.																	
Voltage Proof	No defects.																	
15	High Temperature High Humidity (Steady)	Appearance	Solder the capacitor on the test substrate shown in Fig.3. Test Temperature: 40±2°C Test Humidity: 90 to 95%RH Test Time: 500±12h Applied Voltage: DC Rated Voltage Charge/discharge current: 50mA max. Exposure Time: 24±2h															
		Capacitance Change		Within ±7.5% or ±0.75pF (Whichever is larger)														
		Q		30pF and over: Q ≥ 200 30pF and below: Q ≥ 100+10C/3 C: Nominal Capacitance(pF)														
		I.R.		More than 500MΩ														
16	Durability	Appearance	Solder the capacitor on the test substrate shown in Fig.3. Test Temperature: Max. Operating Temp. ±3°C Test Time: 1000±12h Applied Voltage: 200% of the rated voltage Charge/discharge current: 50mA max. Exposure Time: 24±2h															
		Capacitance Change		Within ±3% or ±0.3pF (Whichever is larger)														
		Q		30pF and over: Q ≥ 350 10pF and over, 30pF and below: Q ≥ 275+5C/2 10pF and below: Q ≥ 200+10C C: Nominal Capacitance (pF)														
		I.R.		More than 1000MΩ														

Table A

Char.	Capacitance Change from 20°C/25°C (%)							
	-55°C		-30°C		-25°C		-10°C	
	Max.	Min.	Max.	Min.	Max.	Min.	Max.	Min.
2C	0.82	-0.45	-	-	0.49	-0.27	0.33	-0.18
5C/5G	0.58	-0.24	0.40	-0.17	-	-	0.25	-0.11

Continued on the following page. ↗

GRM
GR3
GRJ
GR4
GR7
GJM
GQM
GA2
GA3 GB
GA3 GD
GA3 GF
LLL
LLA
LLM
LLR
NFM
KPM
KR3
GMA
GMD
⚠Caution / Notice

GQM Series Specifications and Test Methods (3)

Continued from the preceding page. ↘

Substrate Bending Test

• Test Substrate

Material: Copper-clad laminated sheets for PCBs (Glass fabric base, epoxy resin)
 Thickness: 1.6mm
 Copper foil thickness: 0.035mm
 : Solder resist (Coat with heat resistant resin for solder)

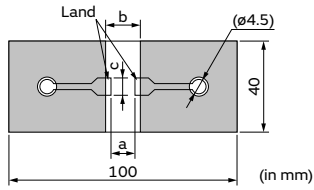

Part Number	Dimension (mm)		
	a	b	c
GQM18	1.0	3.0	1.2
GQM21	1.2	4.0	1.65

Fig.1

- Kind of Solder: Sn-3.0Ag-0.5Cu
- Pressurization Method

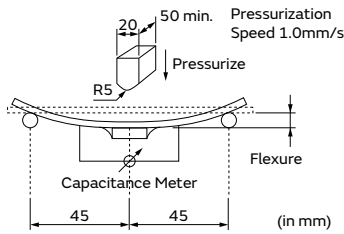

Fig.2

Adhesive Strength of Termination, Vibration, Temperature Sudden Change, High Temperature High Humidity (Steady) , Durability

• Test Substrate

Material: Copper-clad laminated sheets for PCBs (Glass fabric base, epoxy resin)
 Thickness: 1.6mm or 0.8mm
 Copper foil thickness: 0.035mm

- Kind of Solder: Sn-3.0Ag-0.5Cu
- Land Dimensions

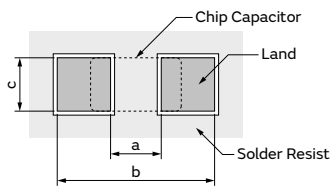

Part Number	Dimension (mm)		
	a	b	c
GQM18	1.0	3.0	1.2
GQM21	1.2	4.0	1.65

Fig.3

GRM
GR3
GRJ
GR4
GR7
GJM
GQM
GA2
GA3 GB
GA3 GD
GA3 GF
LLL
LLA
LLM
LLR
NFM
KRM
KR3
GMA
GMD
⚠Caution /Notice

4

GQM Series Specifications and Test Methods (4)

No	Item	Specification	Test Method (Ref. Standard: JIS C 5101, IEC60384)												
1	Rated Voltage	Shown in Rated value.	The rated voltage is defined as the maximum voltage which may be applied continuously to the capacitor. When AC voltage is superimposed on DC voltage, V^{P-P} or V^{O-P} , whichever is larger, should be maintained within the rated voltage range.												
2	Appearance	No defects or abnormalities.	Visual inspection.												
3	Dimension	Within the specified dimensions.	Using Measuring instrument of dimension.												
4	Voltage Proof	No defects or abnormalities.	Measurement Point: Between the terminations Test Voltage: 250% of the rated voltage Applied Time: 1 to 5s Charge/discharge current: 50mA max.												
5	Insulation Resistance (I.R.)	More than 10000MΩ	Measurement Point: Between the terminations Measurement Voltage: DC Rated Voltage Charging Time: 2min Charge/discharge current: 50mA max. Measurement Temperature: Room Temperature												
6	Capacitance	Shown in Rated value.	Measurement Temperature: Room Temperature <table border="1"> <thead> <tr> <th>Capacitance</th> <th>Frequency</th> <th>Voltage</th> </tr> </thead> <tbody> <tr> <td>$C \leq 1000\text{pF}$</td> <td>1.0±0.1kHz</td> <td>0.5 to 5.0Vrms</td> </tr> </tbody> </table>	Capacitance	Frequency	Voltage	$C \leq 1000\text{pF}$	1.0±0.1kHz	0.5 to 5.0Vrms						
Capacitance	Frequency	Voltage													
$C \leq 1000\text{pF}$	1.0±0.1kHz	0.5 to 5.0Vrms													
7	Q	30pF and over: $Q \geq 1400$ 30pF and below: $Q \geq 800+20C$ C: Nominal Capacitance(pF)													
8	Temperature Characteristics of Capacitance	Nominal values of the temperature coefficient is shown in Rated value. But, the Capacitance Change under 25°C is shown in Table A. Capacitance Drift Within ±0.2% or ±0.05pF (Whichever is larger.)	The capacitance change should be measured after 5 minutes at each specified temp. stage. Capacitance value as a reference is the value in step 3. The capacitance drift is calculated by dividing the differences between the maximum and minimum measured values in the step 1, 3 and 5 by the cap. value in step 3. <table border="1"> <thead> <tr> <th>Step</th> <th>Temperature (°C)</th> </tr> </thead> <tbody> <tr> <td>1</td> <td>Reference Temp. ±2</td> </tr> <tr> <td>2</td> <td>Min. Operating Temp. ±3</td> </tr> <tr> <td>3</td> <td>Reference Temp. ±2</td> </tr> <tr> <td>4</td> <td>Max. Operating Temp. ±3</td> </tr> <tr> <td>5</td> <td>Reference Temp. ±2</td> </tr> </tbody> </table>	Step	Temperature (°C)	1	Reference Temp. ±2	2	Min. Operating Temp. ±3	3	Reference Temp. ±2	4	Max. Operating Temp. ±3	5	Reference Temp. ±2
Step	Temperature (°C)														
1	Reference Temp. ±2														
2	Min. Operating Temp. ±3														
3	Reference Temp. ±2														
4	Max. Operating Temp. ±3														
5	Reference Temp. ±2														
9	Adhesive Strength of Termination	No removal of the terminations or other defect should occur.	Solder the capacitor on the test substrate shown in Fig.3. Applied Force: 10N Holding Time: 10±1s Applied Direction: In parallel with the test substrate and vertical with the capacitor side.												
10	Vibration	Appearance	Solder the capacitor on the test substrate shown in Fig.3. Kind of Vibration: A simple harmonic motion 10Hz to 55Hz to 10Hz (1min) Total amplitude: 1.5mm This motion should be applied for a period of 2h in each 3 mutually perpendicular directions (total of 6h).												
		Capacitance													
		Q													
11	Substrate Bending Test	Appearance	Solder the capacitor on the test substrate shown in Fig.1. Pressurization method: Shown in Fig.2 Flexure:1mm Holding Time: 5±1s Soldering Method: Reflow soldering												
		Capacitance Change													
12	Solderability	95% of the terminations is to be soldered evenly and continuously.	Test Method: Solder bath method Flux: Solution of rosin ethanol 25 (mass)% Preheat: 80 to 120°C for 10 to 30s Solder: Sn-3.0Ag-0.5Cu Solder Temp.: 245±5°C Immersion time: 2±0.5s												
13	Resistance to Soldering Heat	Appearance	Test Method: Solder bath method Solder: Sn-3.0Ag-0.5Cu Solder Temp.: 270±5°C Immersion time: 10±0.5s Exposure Time: 24±2h Preheat: 120 to 150°C for 1min												
		Capacitance Change													
		Q													
		I.R.													
		Voltage Proof													

Continued on the following page. ➤

GRM
GR3
GRJ
GR4
GR7
GJM
GQM
GA2
GA3 GB
GA3 GD
GA3 GF
LLL
LLA
LLM
LLR
NFM
KPM
KR3
GMA
GMD
⚠Caution / Notice

GQM Series Specifications and Test Methods (4)

Continued from the preceding page. ↘

No	Item	Specification	Test Method (Ref. Standard: JIS C 5101, IEC60384)															
14	Appearance	No defects or abnormalities.	Solder the capacitor on the test substrate shown in Fig.3. Perform the 5 cycles according to the four heat treatments shown in the following table. <table border="1" style="margin: 10px 0;"> <thead> <tr> <th>Step</th> <th>Temp. (°C)</th> <th>Time (min)</th> </tr> </thead> <tbody> <tr> <td>1</td> <td>Min. Operating Temp. +0/-3</td> <td>30±3</td> </tr> <tr> <td>2</td> <td>Room Temp.</td> <td>2 to 3</td> </tr> <tr> <td>3</td> <td>Max. Operating Temp. +3/-0</td> <td>30±3</td> </tr> <tr> <td>4</td> <td>Room Temp.</td> <td>2 to 3</td> </tr> </tbody> </table> Exposure Time: 24±2h	Step	Temp. (°C)	Time (min)	1	Min. Operating Temp. +0/-3	30±3	2	Room Temp.	2 to 3	3	Max. Operating Temp. +3/-0	30±3	4	Room Temp.	2 to 3
	Step	Temp. (°C)		Time (min)														
	1	Min. Operating Temp. +0/-3		30±3														
	2	Room Temp.		2 to 3														
	3	Max. Operating Temp. +3/-0		30±3														
4	Room Temp.	2 to 3																
Capacitance Change	Within ±2.5% or ±0.25pF (Whichever is larger)																	
Q	Within the specified initial value.																	
I.R.	Within the specified initial value.																	
Voltage Proof	No defects.																	
15	Appearance	No defects or abnormalities.	Solder the capacitor on the test substrate shown in Fig.3. Test Temperature: 40±2°C Test Humidity: 90 to 95%RH Test Time: 500±12h Applied Voltage: DC Rated Voltage Charge/discharge current: 50mA max. Exposure Time: 24±2h															
	Capacitance Change	Within ±7.5% or ±0.75pF (Whichever is larger)																
	Q	30pF and over: Q ≥ 200 30pF and below: Q ≥ 100+10C/3 C: Nominal Capacitance(pF)																
	I.R.	More than 500MΩ																
16	Appearance	No defects or abnormalities.	Solder the capacitor on the test substrate shown in Fig.3. Test Temperature: Max. Operating Temp. ±3°C Test Time: 1000±12h Applied Voltage: 150% of the rated voltage Charge/discharge current: 50mA max. Exposure Time: 24±2h															
	Capacitance Change	Within ±3% or ±0.3pF (Whichever is larger)																
	Q	30pF and over: Q ≥ 350 10pF and over, 30pF and below: Q ≥ 275+5C/2 10pF and below: Q ≥ 200+10C C: Nominal Capacitance (pF)																
	I.R.	More than 1000MΩ																

Table A

Char.	Capacitance Change from 25°C(%)					
	-55°C		-30°C		-10°C	
	Max.	Min.	Max.	Min.	Max.	Min.
5C	0.58	-0.24	0.40	-0.17	0.25	-0.11

Continued on the following page. ↗

GRM
 GR3
 GRJ
 GR4
 GR7
 GJM
GQM
 GA2
 GA3 GB
 GA3 GD
 GA3 GF
 LLL
 LLA
 LLM
 LLR
 NFM
 KRM
 KR3
 GMA
 GMD
 ⚠Caution /Notice

GQM Series Specifications and Test Methods (4)

Continued from the preceding page. ↘

Substrate Bending Test

• Test Substrate

Material: Copper-clad laminated sheets for PCBs (Glass fabric base, epoxy resin)
 Thickness: 1.6mm
 Copper foil thickness: 0.035mm
 [Shaded Area]: Solder resist (Coat with heat resistant resin for solder)

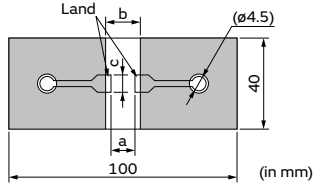

Part Number	Dimension (mm)		
	a	b	c
GQM22	2.2	5.0	2.9

Fig.1

- Kind of Solder: Sn-3.0Ag-0.5Cu
- Pressurization Method

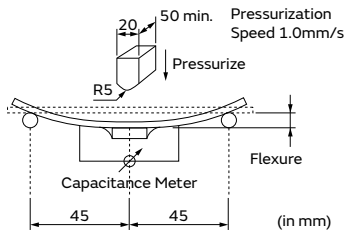

Fig.2

Adhesive Strength of Termination, Vibration, Temperature Sudden Change, High Temperature High Humidity (Steady) , Durability

• Test Substrate

Material: Copper-clad laminated sheets for PCBs (Glass fabric base, epoxy resin)
 Thickness: 1.6mm or 0.8mm
 Copper foil thickness: 0.035mm

- Kind of Solder: Sn-3.0Ag-0.5Cu
- Land Dimensions

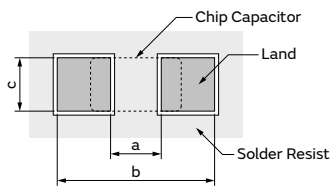

Part Number	Dimension (mm)		
	a	b	c
GQM22	2.2	5.0	2.9

Fig.3

GRM
 GR3
 GRJ
 GR4
 GR7
 GJM
GQM
 GA2
 GA3 GB
 GA3 GD
 GA3 GF
 LLL
 LLA
 LLM
 LLR
 NFM
 KPM
 KR3
 GMA
 GMD
 ⚠Caution / Notice

Based on the Electrical Appliance and Material Safety Law of Japan Chip Multilayer Ceramic Capacitors for General Purpose

GA2 Series



This product is for commercial power supplies, compliant with the Electrical Appliance and Material Safety Law of Japan.

Features

- 1 Sn plating is applied to the external electrodes, providing excellent solderability.

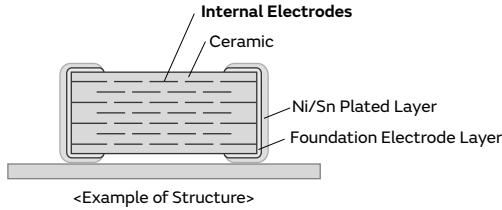

- 2 Realized large capacitance value and small size while maintaining high withstand voltages by the multilayer structure.
- 3 This product is only for reflow soldering.
- 4 There are types for connections between lines and connections between lines and ground.

Specifications

Size (mm)	4.5×2.0mm to 5.7×5.0mm
Rated Voltage	250Vac
Capacitance	470pF to 0.10μF
Main Applications	General purpose for Japan

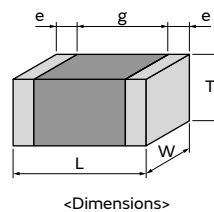

This catalog contains only a portion of the product lineup.
 Please refer to the capacitor search tool on the Murata Web site for details.

GRM
 GR3
 GRJ
 GR4
 GR7
 GJM
 GQM
 GA2
 GA3 GB
 GA3 GD
 GA3 GF
 LLL
 LLA
 LLM
 LLR
 NFM
 KRM
 KR3
 GMA
 GMD
 ⚠Caution /Notice

GA2 Series High Dielectric Constant Type Part Number List

4.5×2.0mm

T max.	Rated Voltage	TC Code	Cap.	Tol.	Part Number	p*
1.5mm	250Vac	X7R	470pF	±20%	GA242QR7E2471MW01#	p186
			1000pF	±20%	GA242QR7E2102MW01#	p186

4.5×3.2mm

T max.	Rated Voltage	TC Code	Cap.	Tol.	Part Number	p*
1.5mm	250Vac	X7R	2200pF	±20%	GA243QR7E2222MW01#	p186
			3300pF	±20%	GA243QR7E2332MW01#	p186
			10000pF	±20%	GA243QR7E2103MW01#	p186
			22000pF	±20%	GA243QR7E2223MW01#	p186
2.0mm	250Vac	X7R	4700pF	±20%	GA243DR7E2472MW01#	p186
			47000pF	±20%	GA243DR7E2473MW01#	p186

5.7×5.0mm

T max.	Rated Voltage	TC Code	Cap.	Tol.	Part Number	p*
2.0mm	250Vac	X7R	0.10μF	±20%	GA255DR7E2104MW01#	p186

*: Refers to the page of the "Specifications and Test Methods".

Part number # indicates the package specification code.

1

GA2 Series Specifications and Test Methods (1)

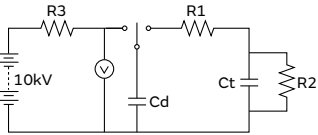
No	Item	Specification	Test Method (Ref. Standard: JIS C 5101, IEC60384)												
1	Appearance	No defects or abnormalities.	Visual inspection.												
2	Dimension	Within the specified dimensions.	Using calipers and micrometers.												
3	Voltage Proof	No defects or abnormalities.	Measurement Point: Between the terminations Test Voltage: 10000pF min.: AC575V (r.m.s.) less than 10000pF: AC1500V (r.m.s.) Applied Time: 60±1s Charge/discharge current: 50mA max.												
4	Insulation Resistance (I.R.)	2000MΩ or more	Measurement Point: Between the terminations Measurement Voltage: DC500±50V Charging Time: 60±5s Measurement Temperature: Room Temperature												
5	Capacitance	Shown in Rated value.	Measurement Temperature: Room Temperature Measurement Frequency: 1.0±0.1kHz												
6	Dissipation Factor (D.F.)	0.025 max.	Measurement Voltage: AC1.0±0.2V (r.m.s.)												
7	Temperature Characteristics of Capacitance	R7: Within ±15% (-55 to +125°C)	The capacitance change should be measured after 5 minutes at each specified temp. stage. Capacitance value as a reference is the value in step 3. <table border="1" style="margin-left: 20px;"> <thead> <tr> <th>Step</th> <th>Temperature (°C)</th> </tr> </thead> <tbody> <tr> <td>1</td> <td>Reference Temp. ±2</td> </tr> <tr> <td>2</td> <td>Min. Operating Temp. ±3</td> </tr> <tr> <td>3</td> <td>Reference Temp. ±2</td> </tr> <tr> <td>4</td> <td>Max. Operating Temp. ±3</td> </tr> <tr> <td>5</td> <td>Reference Temp. ±2</td> </tr> </tbody> </table> •Pretreatment Perform a heat treatment at 150+0/-10°C for 1h±5min and then let sit for 24±2h at room condition (*1).	Step	Temperature (°C)	1	Reference Temp. ±2	2	Min. Operating Temp. ±3	3	Reference Temp. ±2	4	Max. Operating Temp. ±3	5	Reference Temp. ±2
Step	Temperature (°C)														
1	Reference Temp. ±2														
2	Min. Operating Temp. ±3														
3	Reference Temp. ±2														
4	Max. Operating Temp. ±3														
5	Reference Temp. ±2														
8	Discharge Test (Application: C < 10000pF) C: Nominal Capacitance	No defects or abnormalities.	As in below figure, discharge is made 50 times at 5s intervals from the capacitor (Cd) charged at DC voltage of specified.  Ct: Capacitor under test, Cd: 0.001μF R1: 1000Ω, R2: 100MΩ, R3: Surge resistance												
9	Vibration	Appearance	No defects or abnormalities.												
		Capacitance	Within the specified initial value.												
		D.F.	Within the specified initial value.												
10	Solderability	95% of the terminations is to be soldered evenly and continuously.	Test Method: Solder bath method Flux: Solution of rosin ethanol 25 (wt) % Preheat: 80 to 120°C for 10 to 30s Solder: Sn-3.0Ag-0.5Cu (Lead Free Solder) Solder Temp.: 245±5°C Immersion time: 2±0.5s Immersing in speed: 25±2.5mm/s.												
11	Resistance to Soldering Heat	Appearance	No defects or abnormalities.												
		Capacitance Change	Within ±10%												
		D.F.	Within the specified initial value.												
		I.R.	Within the specified initial value.												
		Voltage Proof	No defects.												
			Test Method: Solder bath method Solder: Sn-3.0Ag-0.5Cu (Lead Free Solder) Solder Temp.: 260±5°C Immersion time: 10±1s Immersing in speed: 25±2.5mm/s. Exposure Time: 24±2h at room condition (*1). Preheat: GA242 size min.: 100 to 120°C for 1min and 170 to 200°C for 1min • Pretreatment Perform a heat treatment at 150+0/-10°C for 1h±5min and then let sit for 24±2h at room condition (*1).												

*1 Room Condition: Temperature: 15 to 35°C, Relative humidity: 45 to 75%, Atmosphere pressure: 86 to 106kPa

Continued on the following page. ↗

⚠Caution /Notice

GRM
 GR3
 GRJ
 GR4
 GR7
 GJM
 GQM
 GA2
 GA3 GB
 GA3 GD
 GA3 GF
 LLL
 LLA
 LLM
 LLR
 NFM
 KRM
 KR3
 GMA
 GMD

GA2 Series Specifications and Test Methods (1)

Continued from the preceding page. ↘

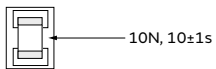
No	Item	Specification	Test Method (Ref. Standard: JIS C 5101, IEC60384)															
12	Adhesive Strength of Termination	No removal of the terminations or other defect should occur.	<p>Solder the capacitor on the test substrate A shown in "Complement of Test Method".</p>  <p>Applied Direction: In parallel with the test substrate and vertical with the capacitor side.</p>															
13	Substrate Bending Test	No defects or abnormalities.	<p>Solder the capacitor on the test substrate B shown in "Complement of Test Method". Then apply the force in the direction shown in "Test Method of Substrate Bending Test" of "Complement of Test Method". Flexure: 1mm Holding Time: 5±1s Soldering Method: Reflow soldering</p>															
14	Temperature Sudden Change	Appearance	<p>Fix the capacitor to the supporting test substrate A (glass epoxy board) shown in "Complement of Test Method". Perform the 5 cycles according to the four heat treatments shown in the following table.</p> <table border="1" data-bbox="933 750 1380 873"> <thead> <tr> <th>Step</th> <th>Temp. (°C)</th> <th>Time (min)</th> </tr> </thead> <tbody> <tr> <td>1</td> <td>Min. Operating Temp. +0/-3</td> <td>30±3</td> </tr> <tr> <td>2</td> <td>Room Temp.</td> <td>2 to 3</td> </tr> <tr> <td>3</td> <td>Max. Operating Temp. +3/-0</td> <td>30±3</td> </tr> <tr> <td>4</td> <td>Room Temp.</td> <td>2 to 3</td> </tr> </tbody> </table> <p>Exposure Time: 24±2h at room condition (*1). • Pretreatment Perform a heat treatment at 150+0/-10°C for 1h±5min and then let sit for 24±2h at room condition (*1).</p>	Step	Temp. (°C)	Time (min)	1	Min. Operating Temp. +0/-3	30±3	2	Room Temp.	2 to 3	3	Max. Operating Temp. +3/-0	30±3	4	Room Temp.	2 to 3
		Step		Temp. (°C)	Time (min)													
		1		Min. Operating Temp. +0/-3	30±3													
		2		Room Temp.	2 to 3													
		3		Max. Operating Temp. +3/-0	30±3													
4	Room Temp.	2 to 3																
Capacitance Change	Within ±15%																	
D.F.	0.05 max.																	
I.R.	Within the specified initial value.																	
Voltage Proof	No defects.																	
15	Humidity Insulation	Appearance	<p>The capacitor shall be subjected to 40±2°C, relative humidity of 90 to 95% for 8h, and then removed in room condition (*1) for 16h until 5 cycles.</p>															
		Capacitance Change		Within ±15%														
		D.F.		0.05 max.														
		I.R.		1000MΩ or more														
		Voltage Proof		No defects.														
16	High Temperature High Humidity (Steady)	Appearance	<p>Fix the capacitor to the supporting test substrate A (glass epoxy board) shown in "Complement of Test Method". Test Temperature: 40±2°C Test Humidity: 90 to 95%RH Test Time: 500+24/-0h. Applied Voltage: Rated voltage Exposure Time: 24±2h at room condition (*1). • Pretreatment Apply test voltage for 1h±5min at test temperature. Remove and let sit for 24±2h at room condition (*1).</p>															
		Capacitance Change		Within ±15%														
		D.F.		0.05 max.														
		I.R.		1000MΩ or more														
		Voltage Proof		No defects.														
17	Durability	Appearance	<p>Fix the capacitor to the supporting test substrate A (glass epoxy board) shown in "Complement of Test Method". Test Temperature: Max. Operating Temp. ±3°C Charge/discharge current: 50mA max.</p> <table border="1" data-bbox="933 1601 1452 1668"> <thead> <tr> <th>Nominal Capacitance</th> <th>Test Time</th> <th>Test Voltage</th> </tr> </thead> <tbody> <tr> <td>C ≥ 10000pF</td> <td>1000+48/-0h</td> <td>AC300V (r.m.s.)</td> </tr> <tr> <td>C < 10000pF</td> <td>1500+48/-0h (*2)</td> <td>AC500V (r.m.s.)</td> </tr> </tbody> </table> <p>*2 Except that once each hour the voltage is increased to AC1000V (r.m.s.) for 0.1s. Exposure Time: 24±2h at room condition (*1). • Pretreatment Apply test voltage for 1h±5min at test temperature. Remove and let sit for 24±2h at room condition (*1).</p>	Nominal Capacitance	Test Time	Test Voltage	C ≥ 10000pF	1000+48/-0h	AC300V (r.m.s.)	C < 10000pF	1500+48/-0h (*2)	AC500V (r.m.s.)						
		Nominal Capacitance		Test Time	Test Voltage													
		C ≥ 10000pF		1000+48/-0h	AC300V (r.m.s.)													
		C < 10000pF		1500+48/-0h (*2)	AC500V (r.m.s.)													
		Capacitance Change		Within ±20%														
D.F.	0.05 max.																	
I.R.	1000MΩ or more																	
Voltage Proof	No defects.																	

*1 Room Condition: Temperature: 15 to 35°C, Relative humidity: 45 to 75%, Atmosphere pressure: 86 to 106kPa

Continued on the following page. ↗

GRM
 GR3
 GRJ
 GR4
 GR7
 GJM
 GQM
 GA2
 GA3 GB
 GA3 GD
 GA3 GF
 LLL
 LLA
 LLM
 LLR
 NFM
 KPM
 KR3
 GMA
 GMD
 △Caution / Notice

GA2 Series Specifications and Test Methods (1)

Continued from the preceding page. ↘

Complement of Test Method

1. Test Substrate

The test substrate should be Substrate A or Substrate B as described in "Specifications and Test Methods".
 The specimen should be soldered by the conditions as described below.

Soldering Method: Reflow soldering
 Solder: Sn-3.0Ag-0.5Cu

(1) Test Substrate A

• Land Dimensions

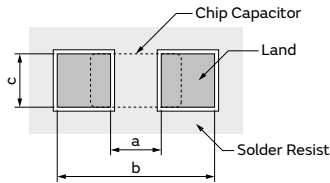

- Material: Glass Epoxy Board
- Thickness: 1.6mm
- Thickness of Copper Foil: 0.035mm

Part Number	Dimension (mm)		
	a	b	c
GRM42	3.5	7.0	2.4
GRM43	3.5	7.0	3.7
GRM52	4.5	8.0	3.2
GRM55	4.5	8.0	5.6

(2) Test Substrate B

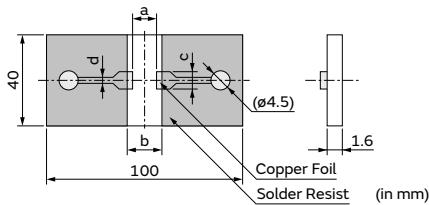

- Material: Glass Epoxy Board
- Thickness of Copper Foil: 0.035mm

Part Number	Dimension of Pattern (mm)			
	a	b	c	d
GRM42	3.5	7.0	2.4	1.0
GRM43	3.5	7.0	3.7	1.0
GRM52	4.5	8.0	3.2	1.0
GRM55	4.5	8.0	5.6	1.0

2. Test Method of Substrate Bending Test

(a) Support State

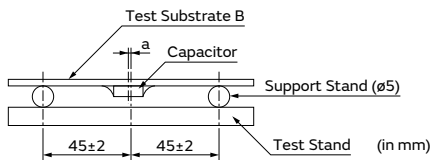

a: ±2 gap between support stand center and test stand

- Material of Test Stand and Pressure Stick
 The material should be a metal where a remarkable transformation and the distortion are not caused even if it is pressurized.
- Pressurizing Speed
 The pressurizing speed is pressurized at the speed of about 1mm/s until the flexure reaches a regulated value.

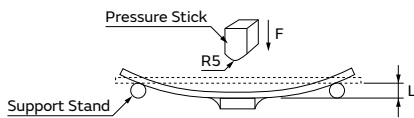

(b) Test State

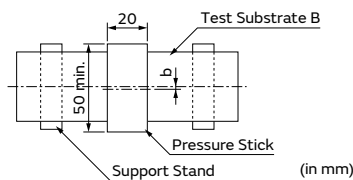

b: ±5 gap between support stand center and test stand center

GRM
 GR3
 GRJ
 GR4
 GR7
 GJM
 GQM
 GA2
 GA3 GB
 GA3 GD
 GA3 GF
 LLL
 LLA
 LLM
 LLR
 NFM
 KRM
 KR3
 GMA
 GMD
 Caution / Notice

Safety Standard Certified Chip Multilayer Ceramic Capacitors for General Purpose / IEC60384-14 Class X2

GA3 Series Type GB



IEC60384-14 X2 Class Certified Product

Features

- 1 International Standard (IEC60384-14) certified product.

Please down load Safety Standard Certification (Type GB: X2) from here.



- 2 Can be used as a Class X2 capacitor.

- Switching Power Supply - Class 1 Equipment

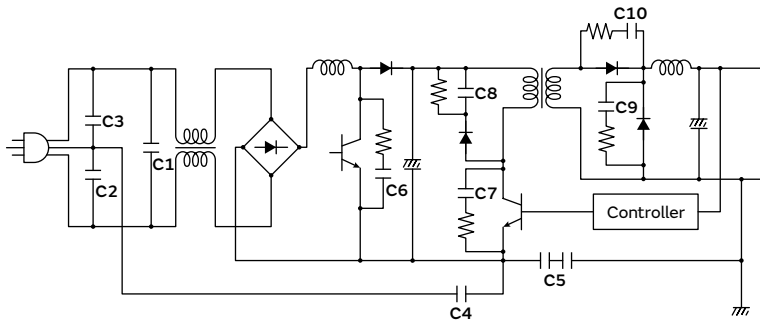

No.	Application	Recommend MLCC Type
C1	X Cap	Type: GB
C2	Y Cap	Type: GF
C3		
C4		
C5	Primary - Secondary Coupling	Type: GF×2

- Switching Power Supply - Class 2 Equipment

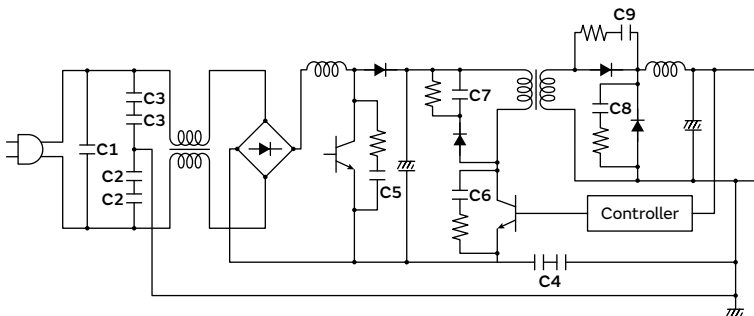

No.	Application	Recommend MLCC Type
C1	X Cap	Type: GB
C2	Y Cap	Type: GF×2
C3		
C4	Primary - Secondary Coupling	

- GRM
- GR3
- GRJ
- GR4
- GR7
- GJM
- GQM
- GA2
- GA3 GB
- GA3 GD
- GA3 GF
- LLL
- LLA
- LLM
- LLR
- NFM
- KPM
- KR3
- GMA
- GMD
- ⚠Caution / Notice

GRM
 GR3
 GRJ
 GR4
 GR7
 GJM
 GQM
 GA2
 GA3 GB
 GA3 GD
 GA3 GF
 LLL
 LLA
 LLM
 LLR
 NFM
 KRM
 KR3
 GMA
 GMD
 ⚠Caution /Notice

- 3 Realized large capacitance value and small size while maintaining high withstand voltages by the multilayer structure.

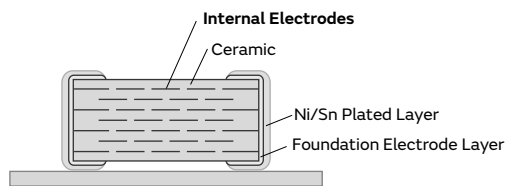

<Example of Structure>

- 4 Compared with conventional lead type capacitors, this product realized great reductions in size and height, with a volume of 1/10 or less, and height of 1/4 or less.
- 5 This product is only for reflow soldering.

Specifications

Size (mm)	5.7×5.0mm
Rated Voltage	250Vac
Capacitance	10000pF to 56000pF
Main Applications	AC-DC power supply

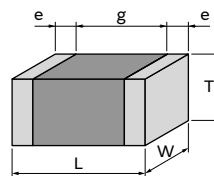

<Dimensions>

This catalog contains only a portion of the product lineup.
 Please refer to the capacitor search tool on the Murata Web site for details.

GA3 Series Type GB High Dielectric Constant Type Part Number List

5.7×5.0mm

T max.	Rated Voltage	TC Code	Cap.	Tol.	Part Number	p*
1.5mm	250Vac	X7R	10000pF	±10%	GA355QR7GB103KW01#	p192
			15000pF	±10%	GA355QR7GB153KW01#	p192
2.0mm	250Vac	X7R	22000pF	±10%	GA355DR7GB223KW01#	p192
2.5mm	250Vac	X7R	33000pF	±10%	GA355ER7GB333KW01#	p192
			47000pF	±10%	GA355ER7GB473KW01#	p192
2.9mm	250Vac	X7R	56000pF	±10%	GA355XR7GB563KW06#	p192

- GRM
- GR3
- GRJ
- GR4
- GR7
- GJM
- GQM
- GA2
- GA3 GB
- GA3 GD
- GA3 GF
- LLL
- LLA
- LLM
- LLR
- NFM
- KRM
- KR3
- GMA
- GMD
- ⚠Caution /Notice

*: Refers to the page of the "Specifications and Test Methods".

Part number # indicates the package specification code.

1

GA3 Series Type GB Specifications and Test Methods (1)

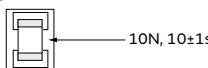
No	Item	Specification	Test Method (Ref. Standard: JIS C 5101, IEC60384)												
1	Appearance	No defects or abnormalities.	Visual inspection.												
2	Dimension	Within the specified dimensions.	Using calipers and micrometers.												
3	Voltage Proof	No defects or abnormalities.	Measurement Point: Between the terminations Test Voltage: DC1075V Applied Time: 60±1s Charge/discharge current: 50mA max.												
4	Insulation Resistance (I.R.)	6000MΩ or more	Measurement Point: Between the terminations Measurement Voltage: DC500±50V Charging Time: 60±5s Measurement Temperature: Room Temperature												
5	Capacitance	Shown in Rated value.	Measurement Temperature: Room Temperature												
6	Dissipation Factor (D.F.)	0.025 max.	Measurement Frequency: 1.0±0.1kHz Measurement Voltage: AC1.0±0.2V (r.m.s.)												
7	Temperature Characteristics of Capacitance	R7: Within ±15% (-55 to +125°C)	The capacitance change should be measured after 5 minutes at each specified temp. stage. Capacitance value as a reference is the value in step 3. <table border="1"> <thead> <tr> <th>Step</th> <th>Temperature (°C)</th> </tr> </thead> <tbody> <tr> <td>1</td> <td>Reference Temp. ±2</td> </tr> <tr> <td>2</td> <td>Min. Operating Temp. ±3</td> </tr> <tr> <td>3</td> <td>Reference Temp. ±2</td> </tr> <tr> <td>4</td> <td>Max. Operating Temp. ±3</td> </tr> <tr> <td>5</td> <td>Reference Temp. ±2</td> </tr> </tbody> </table> <ul style="list-style-type: none"> • Pretreatment Perform a heat treatment at 150+0/-10°C for 1h±5min and then let sit for 24±2h. at room condition*. 	Step	Temperature (°C)	1	Reference Temp. ±2	2	Min. Operating Temp. ±3	3	Reference Temp. ±2	4	Max. Operating Temp. ±3	5	Reference Temp. ±2
Step	Temperature (°C)														
1	Reference Temp. ±2														
2	Min. Operating Temp. ±3														
3	Reference Temp. ±2														
4	Max. Operating Temp. ±3														
5	Reference Temp. ±2														
8	Vibration	Appearance	No defects or abnormalities.												
		Capacitance	Within the specified initial value.												
		D.F.	Within the specified initial value.												
9	Solderability	95% of the terminations is to be soldered evenly and continuously.	Test Method: Solder bath method Flux: Solution of rosin ethanol 25 (wt)% Preheat: 80 to 120°C for 10 to 30s Solder: Sn-3.0Ag-0.5Cu (Lead Free Solder) Solder Temp.: 245±5°C Immersion time: 2±0.5s Immersing in speed: 25±2.5mm/s.												
10	Resistance to Soldering Heat	Appearance	No defects or abnormalities.												
		Capacitance Change	Within ±10%												
		I.R.	1000MΩ or more												
		Voltage Proof	No defects.												
11	Adhesive Strength of Termination	No removal of the terminations or other defect should occur.	Solder the capacitor on the test substrate A shown in "Complement of Test Method".  Applied Direction: In parallel with the test substrate and vertical with the capacitor side.												
12	Substrate Bending Test	No defects or abnormalities.	Solder the capacitor on the test substrate B shown in "Complement of Test Method". Then apply the force in the direction shown in "Test Method of Substrate Bending Test" of "Complement of Test Method". Flexure: 1mm Holding Time: 5±1s Soldering Method: Reflow soldering												

* Room Condition: Temperature: 15 to 35°C, Relative humidity: 45 to 75%, Atmosphere pressure: 86 to 106kPa

Continued on the following page. ↗

GRM
GR3
GRJ
GR4
GR7
GJM
GQM
GA2
GA3 GB
GA3 GD
GA3 GF
LLL
LLA
LLM
LLR
NFM
KRM
KR3
GMA
GMD
⚠Caution /Notice

GA3 Series Type GB Specifications and Test Methods (1)

Continued from the preceding page. ↘

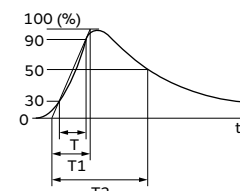
No	Item	Specification	Test Method (Ref. Standard: JIS C 5101, IEC60384)															
13	Temperature Sudden Change	Appearance	Fix the capacitor to the supporting test substrate A (glass epoxy board) shown in "Complement of Test Method". Perform the 5 cycles according to the four heat treatments shown in the following table. <table border="1" style="margin: 10px auto;"> <thead> <tr> <th>Step</th> <th>Temp. (°C)</th> <th>Time (min)</th> </tr> </thead> <tbody> <tr> <td>1</td> <td>Min. Operating Temp. +0/-3</td> <td>30±3</td> </tr> <tr> <td>2</td> <td>Room Temp.</td> <td>2 to 3</td> </tr> <tr> <td>3</td> <td>Max. Operating Temp. +3/-0</td> <td>30±3</td> </tr> <tr> <td>4</td> <td>Room Temp.</td> <td>2 to 3</td> </tr> </tbody> </table> Exposure Time: 24±2h at room condition*. • Pretreatment Perform a heat treatment at 150+0/-10°C for 1h±5min and then let sit for 24±2h at room condition*.	Step	Temp. (°C)	Time (min)	1	Min. Operating Temp. +0/-3	30±3	2	Room Temp.	2 to 3	3	Max. Operating Temp. +3/-0	30±3	4	Room Temp.	2 to 3
		Step		Temp. (°C)	Time (min)													
		1		Min. Operating Temp. +0/-3	30±3													
		2		Room Temp.	2 to 3													
		3		Max. Operating Temp. +3/-0	30±3													
4	Room Temp.	2 to 3																
Capacitance Change	Within±15%																	
D.F.	0.05 max.																	
I.R.	3000MΩ or more																	
Voltage Proof	No defects.																	
14	High Temperature High Humidity (Steady)	Appearance	Fix the capacitor to the supporting test substrate B (glass epoxy board) shown in "Complement of Test Method". Before this test, the test shown in the following is performed. • No.11 Adhesive Strength of Termination (apply force: 5N) • No.12 Substrate Bending Test Test Temperature: 40±2°C Test Humidity: 90 to 95%RH Test Time: 500+24/-0h Applied Voltage: Rated voltage Exposure Time: 24±2h at room condition*. • Pretreatment Perform a heat treatment at 150+0/-10°C for 1h±5min and then let sit for 24±2h at room condition*.															
		Capacitance Change		Within±15%														
		D.F.		0.05 max.														
		I.R.		3000MΩ or more														
		Voltage Proof		No defects.														
15	Durability	Appearance	Fix the capacitor to the supporting test substrate B (glass epoxy board) shown in "Complement of Test Method". Before this test, the test shown in the following is performed. • No.11 Adhesive Strength of Termination (apply force: 5N) • No.12 Substrate Bending Test Next, Impulse Voltage test is performed. Each individual capacitor shall be subjected to a 2.5kV Impulse (the voltage value means zero to peak) for 3 times. Then the capacitors are applied to life test.  <p style="text-align: right;">Front time (T1) = 1.2μs=1.67T Time to half-value (T2) = 50μs</p> Apply voltage as Table for 1000h at 125+2/-0°C, relative humidity 50% max. <table border="1" style="margin: 10px auto;"> <thead> <tr> <th colspan="2">Applied Voltage</th> </tr> </thead> <tbody> <tr> <td>AC312.5V (r.m.s.),</td> <td>except that once each hour the voltage is increased to AC1000V (r.m.s.) for 0.1s.</td> </tr> </tbody> </table> Exposure Time: 24±2h at room condition*. • Pretreatment Perform a heat treatment at 150+0/-10°C for 1h±5min and then let sit for 24±2h at room condition*.	Applied Voltage		AC312.5V (r.m.s.),	except that once each hour the voltage is increased to AC1000V (r.m.s.) for 0.1s.											
		Applied Voltage																
		AC312.5V (r.m.s.),		except that once each hour the voltage is increased to AC1000V (r.m.s.) for 0.1s.														
		Capacitance Change		Within ±20%														
		D.F.		0.05 max.														
I.R.	3000MΩ or more																	
Voltage Proof	No defects.																	

* Room Condition: Temperature: 15 to 35°C, Relative humidity: 45 to 75%, Atmosphere pressure: 86 to 106kPa

Continued on the following page. ↗

GRM
 GR3
 GRJ
 GR4
 GR7
 GJM
 GQM
 GA2
 GA3 GB
 GA3 GD
 GA3 GF
 LLL
 LLA
 LLM
 LLR
 NFM
 KPM
 KR3
 GMA
 GMD
 ⚠Caution / Notice

GA3 Series Type GB Specifications and Test Methods (1)

Continued from the preceding page. ↘

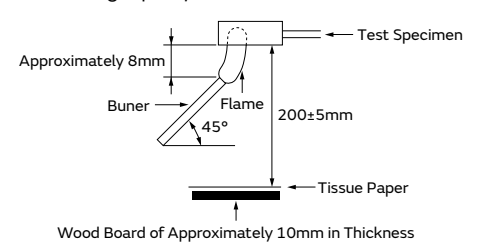
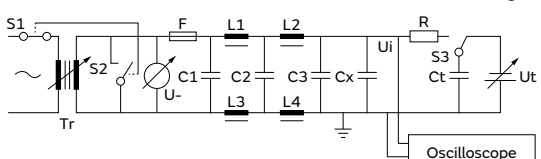
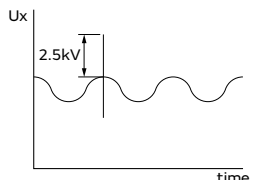
No	Item	Specification	Test Method (Ref. Standard: JIS C 5101, IEC60384)
16	Passive Flammability	The burning time shall not be exceeded the time 30s. The tissue paper shall not ignite.	<p>The capacitor under test shall be held in the flame in the position which best promotes burning. Each specimen shall only be exposed once to the flame. Time of exposure to flame: 30s Length of flame: 12±1mm Gas burner: Length 35mm min. Inside dia: 0.5±0.1mm Outside dia: 0.9mm max. Gas: Butane gas purity 95% min.</p> 
17	Active Flammability	The cheesecloth shall not be on fire.	<p>The specimens shall be individually wrapped in at least one but more than two complete layers of cheesecloth. The specimens shall be subjected to 20 discharges. The interval between successive discharges shall be 5s. The UAC shall be maintained for 2min after the last discharge.</p>  <p>C1,C2: Filter capacitor 1μF±10% C3: Capacitor 0.033μF±5% L1 to L4: Rod coa choke 1.5mH±20%, 16A R: Resistor 100Ω±2% Cx < 0.068μF Ct: Tank capacitor 3μF±5% 10kV Cx ≤ 1μF U-: UR±5% UR: Rated voltage Cx: Capacitor under test F: Slow-blow fuse, rated 16A Ut: Voltage to which the tank capacitor Ct is charged</p> 

GA3 Series Type GB Specifications and Test Methods (1)

Continued from the preceding page. ↘

Complement of Test Method

1. Test Substrate

The test substrate should be Substrate A or Substrate B as described in “Specifications and Test Methods”.
 The specimen should be soldered by the conditions as described below.

Soldering Method: Reflow soldering
 Solder: Sn-3.0Ag-0.5Cu

(1) Test Substrate A

• Land Dimensions

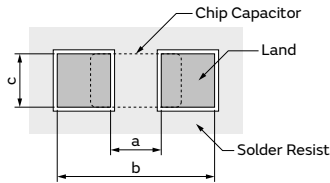

Part Number	Dimension (mm)		
	a	b	c
GA355	4.5	8.0	5.6

- Material: Glass Epoxy Board
- Thickness: 1.6mm
- Thickness of Copper Foil: 0.035mm

(2) Test Substrate B

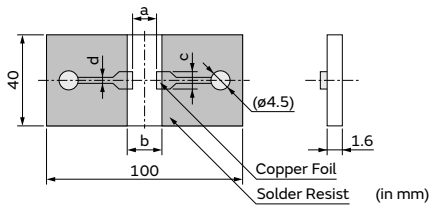

Part Number	Dimension of Pattern (mm)			
	a	b	c	d
GA355	4.5	8.0	5.6	1.0

- Material: Glass Epoxy Board
- Thickness of Copper Foil: 0.035mm

2. Test Method of Substrate Bending Test

(a) Support State

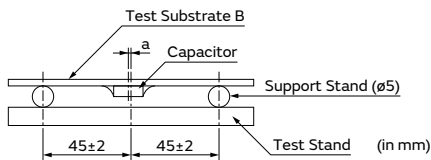

a: ±2 gap between support stand center and test stand

- Material of Test Stand and Pressure Stick
 The material should be a metal where a remarkable transformation and the distortion are not caused even if it is pressurized.
- Pressurizing Speed
 The pressurizing speed is pressurized at the speed of about 1mm/s until the flexure reaches a regulated value.

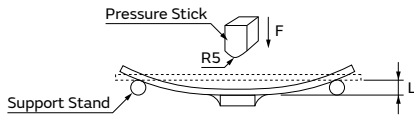

(b) Test State

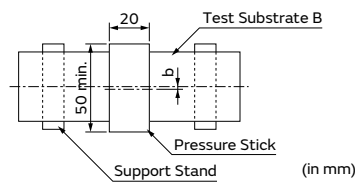

b: ±5 gap between support stand center and test stand center

GRM
 GR3
 GRJ
 GR4
 GR7
 GJM
 GQM
 GA2
 GA3 GB
 GA3 GD
 GA3 GF
 LLL
 LLA
 LLM
 LLR
 NFM
 KPM
 KR3
 GMA
 GMD
 ⚠Caution /Notice

Safety Standard Certified Chip Multilayer Ceramic Capacitors for General Purpose / Acquired certifications of UL60950-1

GA3 Series Type GD



UL60950-1 Certified Product

Features

- 1 International Standard (IEC60384-14) certified product.

Please download Safety Standard Certification (Type GD) from here.



- 2 Can be used for UL60950-1 devices.

● DAA Modem - Transformer Less

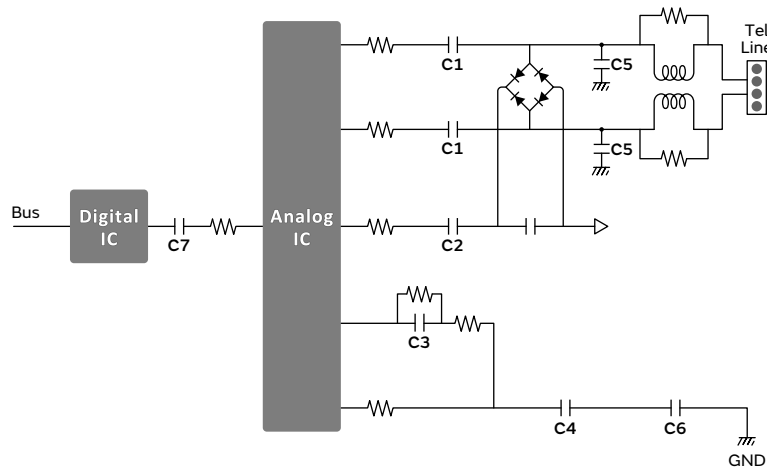

No.	Application	Recommend MLCC Type
C5	Lighting Surge Absorption	Type: GD / GF
C6	Noise Immunity	
C7	D/A Isolation Barrier	

- 3 Realized large capacitance value and small size while maintaining high withstand voltages by the multilayer structure.

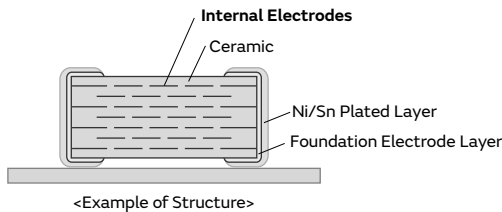

- 4 This product is only for reflow soldering.

Specifications

Size (mm)	4.5×2.0mm to 4.5×3.2mm
Rated Voltage	250Vac
Capacitance	10pF to 4700pF
Main Applications	Modem

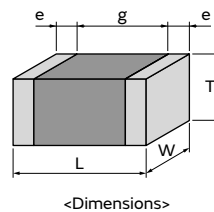

This catalog contains only a portion of the product lineup.
 Please refer to the capacitor search tool on the Murata Web site for details.

GRM
 GR3
 GRJ
 GR4
 GR7
 GJM
 GQM
 GA2
 GA3 GB
 GA3 GD
 GA3 GF
 LLL
 LLA
 LLM
 LLR
 NFM
 KRM
 KR3
 GMA
 GMD
 Caution / Notice

GA3 Series Type GD Temperature Compensating Type Part Number List

4.5×2.0mm

T max.	Rated Voltage	TC Code	Cap.	Tol.	Part Number	p*
1.0mm	250Vac	SL	10pF	±5%	GA342A1XGD100JW31#	p199
			12pF	±5%	GA342A1XGD120JW31#	p199
			15pF	±5%	GA342A1XGD150JW31#	p199
			18pF	±5%	GA342A1XGD180JW31#	p199
			22pF	±5%	GA342A1XGD220JW31#	p199
			27pF	±5%	GA342A1XGD270JW31#	p199
			33pF	±5%	GA342A1XGD330JW31#	p199
			39pF	±5%	GA342A1XGD390JW31#	p199
			47pF	±5%	GA342A1XGD470JW31#	p199
			56pF	±5%	GA342A1XGD560JW31#	p199
			68pF	±5%	GA342A1XGD680JW31#	p199
			82pF	±5%	GA342A1XGD820JW31#	p199

- GRM
- GR3
- GRJ
- GR4
- GR7
- GJM
- GQM
- GA2
- GA3 GB
- GA3 GD**
- GA3 GF
- LLL
- LLA
- LLM
- LLR
- NFM
- KRM
- KR3
- GMA
- GMD
- ⚠Caution /Notice

*: Refers to the page of the "Specifications and Test Methods".

Part number # indicates the package specification code.

GA3 Series Type GD High Dielectric Constant Type Part Number List

4.5×2.0mm

T max.	Rated Voltage	TC Code	Cap.	Tol.	Part Number	p*
1.5mm	250Vac	X7R	100pF	±10%	GA342QR7GD101KW01#	p203
			150pF	±10%	GA342QR7GD151KW01#	p203
			220pF	±10%	GA342QR7GD221KW01#	p203
			330pF	±10%	GA342QR7GD331KW01#	p203
			470pF	±10%	GA342QR7GD471KW01#	p203
			680pF	±10%	GA342QR7GD681KW01#	p203
			1000pF	±10%	GA342QR7GD102KW01#	p203
			1500pF	±10%	GA342QR7GD152KW01#	p203

4.5×3.2mm

T max.	Rated Voltage	TC Code	Cap.	Tol.	Part Number	p*
1.5mm	250Vac	X7R	1800pF	±10%	GA343QR7GD182KW01#	p203
			2200pF	±10%	GA343QR7GD222KW01#	p203
2.0mm	250Vac	X7R	4700pF	±10%	GA343DR7GD472KW01#	p203

- GRM
- GR3
- GRJ
- GR4
- GR7
- GJM
- GQM
- GA2
- GA3 GB
- GA3 GD**
- GA3 GF
- LLL
- LLA
- LLM
- LLR
- NFM
- KRM
- KR3
- GMA
- GMD
- ⚠Caution /Notice

*: Refers to the page of the "Specifications and Test Methods".

Part number # indicates the package specification code.

1

GA3 Series Type GD Specifications and Test Methods (1)

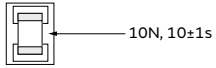
No	Item	Specification	Test Method (Ref. Standard: JIS C 5101, IEC60384)												
1	Appearance	No defects or abnormalities.	Visual inspection.												
2	Dimension	Within the specified dimensions.	Using calipers and micrometers.												
3	Voltage Proof	No defects or abnormalities.	Measurement Point: Between the terminations Test Voltage: AC1500V (r.m.s.) Applied Time: 60±1s Charge/discharge current: 50mA max.												
4	Impulse Voltage	No self healing break downs or flash-overs have taken place in the capacitor.	10 impulse of alternating polarity is subjected. (5 impulse for each polarity) The interval between impulse is 60s. Applied Voltage: 2.5kVo-p												
5	Insulation Resistance (I.R.)	6000MΩ or more	Measurement Point: Between the terminations Measurement Voltage: DC500±50V Charging Time: 60±5s Measurement Temperature: Room Temperature												
6	Capacitance	Shown in Rated value.	Measurement Temperature: Room Temperature Measurement Frequency: 1.0±0.1MHz Measurement Voltage: AC1.0±0.2V (r.m.s.)												
7	Q	C ≥ 30pF: 1000 or more C < 30pF: 400+20C or more C: Nominal Capacitance (pF)													
8	Temperature Characteristics of Capacitance	1X: +350 to -1000 ppm/°C (Temp.Range:+20 to +85°C)	The capacitance change should be measured after 5 minutes at each specified temp. stage. Capacitance value as a reference is the value in step 3. <table border="1"> <thead> <tr> <th>Step</th> <th>Temperature (°C)</th> </tr> </thead> <tbody> <tr> <td>1</td> <td>Reference Temp. ±2</td> </tr> <tr> <td>2</td> <td>Min. Operating Temp. ±3</td> </tr> <tr> <td>3</td> <td>Reference Temp. ±2</td> </tr> <tr> <td>4</td> <td>Max. Operating Temp. ±3</td> </tr> <tr> <td>5</td> <td>Reference Temp. ±2</td> </tr> </tbody> </table> <p>However, the capacitance shall be measured at even 85°C between step 3 and step 4.</p>	Step	Temperature (°C)	1	Reference Temp. ±2	2	Min. Operating Temp. ±3	3	Reference Temp. ±2	4	Max. Operating Temp. ±3	5	Reference Temp. ±2
Step	Temperature (°C)														
1	Reference Temp. ±2														
2	Min. Operating Temp. ±3														
3	Reference Temp. ±2														
4	Max. Operating Temp. ±3														
5	Reference Temp. ±2														
9	Vibration	Appearance	Solder the capacitor on the test substrate A shown in "Complement of Test Method". Kind of Vibration: A simple harmonic motion 10Hz to 55Hz to 10Hz (1min) Total amplitude: 1.5mm This motion should be applied for a period of 2h in each 3 mutually perpendicular directions (total of 6h).												
		Capacitance													
		Q													
10	Solderability	95% of the terminations is to be soldered evenly and continuously.	Test Method: Solder bath method Flux: Solution of rosin ethanol 25 (wt)% Preheat: 80 to 120°C for 10 to 30s Solder: Sn-3.0Ag-0.5Cu (Lead Free Solder) Solder Temp.: 245±5°C Immersion time: 2±0.5s Immersing in speed: 25±2.5mm/s.												
11	Resistance to Soldering Heat	Appearance	Test Method: Solder bath method Solder: Sn-3.0Ag-0.5Cu (Lead Free Solder) Solder Temp.: 260±5°C Immersion time: 10±1s Immersing in speed: 25±2.5mm/s. Exposure Time: 24±2h at room condition*. Preheat: GA342 size: 100 to 120°C for 1min and 170 to 200°C for 1min												
		Capacitance Change													
		I.R.													
		Voltage Proof													
12	Adhesive Strength of Termination	No removal of the terminations or other defect should occur.	Solder the capacitor on the test substrate A shown in "Complement of Test Method".  Applied Direction: In parallel with the test substrate and vertical with the capacitor side.												
13	Substrate Bending Test	No defects or abnormalities.	Solder the capacitor on the test substrate B shown in "Complement of Test Method". Then apply the force in the direction shown in "Test Method of Substrate Bending Test" of "Complement of Test Method". Flexure: 1mm Holding Time: 5±1s Soldering Method: Reflow soldering												

* Room Condition: Temperature: 15 to 35°C, Relative humidity: 45 to 75%, Atmosphere pressure: 86 to 106kPa

Continued on the following page. ↗

GRM
GR3
GRJ
GR4
GR7
GJM
GQM
GA2
GA3 GB
GA3 GD
GA3 GF
LLL
LLA
LLM
LLR
NFM
KRM
KR3
GMA
GMD
⚠Caution /Notice

GA3 Series Type GD Specifications and Test Methods (1)

Continued from the preceding page. ↘

No	Item	Specification	Test Method (Ref. Standard: JIS C 5101, IEC60384)															
14	Temperature Sudden Change	Appearance	Fix the capacitor to the supporting test substrate A (glass epoxy board) shown in "Complement of Test Method" Perform the 5 cycles according to the four heat treatments shown in the following table. <table border="1" style="margin: 10px 0;"> <thead> <tr> <th>Step</th> <th>Temp. (°C)</th> <th>Time (min)</th> </tr> </thead> <tbody> <tr> <td>1</td> <td>Min. Operating Temp. +0/-3</td> <td>30±3</td> </tr> <tr> <td>2</td> <td>Room Temp.</td> <td>2 to 3</td> </tr> <tr> <td>3</td> <td>Max. Operating Temp. +3/-0</td> <td>30±3</td> </tr> <tr> <td>4</td> <td>Room Temp.</td> <td>2 to 3</td> </tr> </tbody> </table> Exposure Time: 24±2h at room condition*.	Step	Temp. (°C)	Time (min)	1	Min. Operating Temp. +0/-3	30±3	2	Room Temp.	2 to 3	3	Max. Operating Temp. +3/-0	30±3	4	Room Temp.	2 to 3
		Step		Temp. (°C)	Time (min)													
		1		Min. Operating Temp. +0/-3	30±3													
		2		Room Temp.	2 to 3													
		3		Max. Operating Temp. +3/-0	30±3													
4	Room Temp.	2 to 3																
Capacitance Change	Within ±2.5% or ±0.25pF (Whichever is larger)																	
Q	Within the specified initial value.																	
I.R.	3000MΩ or more																	
Voltage Proof	No defects.																	
15	High Temperature High Humidity (Steady)	Appearance	Fix the capacitor to the supporting test substrate B (glass epoxy board) shown in "Complement of Test Method". Before this test, the test shown in the following is performed. • No.12 Adhesive Strength of Termination (apply force: 5N) • No.13 Substrate Bending Test Test Temperature: 40±2°C Test Humidity: 90 to 95%RH Test Time: 500+24/-0h. Applied Voltage: Rated voltage Exposure Time: 24±2h at room condition*.															
		Capacitance Change		Within ±5.0% or ±0.5pF (Whichever is larger)														
		Q		C ≥ 30pF: 350 or more C < 30pF: 275+5/2C or more C: Nominal Capacitance (pF)														
		I.R.		3000MΩ or more														
		Voltage Proof		No defects.														
16	Durability	Appearance	Fix the capacitor to the supporting test substrate B (glass epoxy board) shown in "Complement of Test Method". Before this test, the test shown in the following is performed. • No.12 Adhesive Strength of Termination (apply force: 5N) • No.13 Substrate Bending Test Next, Impulse Voltage test is performed. Each individual capacitor shall be subjected to a 2.5kV Impulse (the voltage value means zero to peak) for 3 times. Then the capacitors are applied to life test. <div style="text-align: center; margin: 10px 0;"> <p>100 (%) 90 50 30 0</p> <p>Front time (T1) = 1.2μs=1.67T Time to half-value (T2) = 50μs</p> </div>															
		Capacitance Change		Within ±3.0% or ±0.3pF (Whichever is larger)														
		Q		C ≥ 30pF: 350 or more C < 30pF: 275+5/2C or more C: Nominal Capacitance (pF)														
		I.R.		3000MΩ or more														
		Voltage Proof		No defects.														
17	Passive Flammability	The burning time shall not be exceeded the time 30s. The tissue paper shall not ignite.	The capacitor under test shall be held in the flame in the position which best promotes burning. Each specimen shall only be exposed once to the flame. Time of exposure to flame: 30s Length of flame: 12±1mm Gas burner: Length 35mm min. Inside dia: 0.5±0.1mm Outside dia: 0.9mm max. Gas: Butane gas purity 95% min. <div style="text-align: center; margin: 10px 0;"> <p>Approximately 8mm Buner Flame 45° 200±5mm Tissue Paper Wood Board of Approximately 10mm in Thickness</p> </div>															
				Capacitance Change	Within ±3.0% or ±0.3pF (Whichever is larger)													
				Q	C ≥ 30pF: 350 or more C < 30pF: 275+5/2C or more C: Nominal Capacitance (pF)													
				I.R.	3000MΩ or more													
				Voltage Proof	No defects.													

* Room Condition: Temperature: 15 to 35°C, Relative humidity: 45 to 75%, Atmosphere pressure: 86 to 106kPa

Continued on the following page. ↗

GA3 Series Type GD Specifications and Test Methods (1)

Continued from the preceding page. ↘

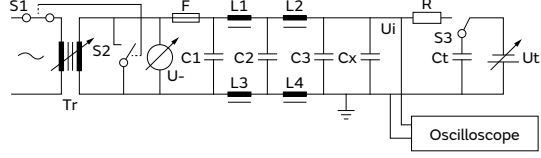
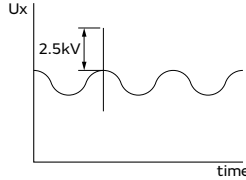
No	Item	Specification	Test Method (Ref. Standard: JIS C 5101, IEC60384)
18	Active Flammability	The cheesecloth shall not be on fire.	<p>The specimens shall be individually wrapped in at least one but more than two complete layers of cheesecloth. The specimens shall be subjected to 20 discharges. The interval between successive discharges shall be 5s. The UAC shall be maintained for 2min after the last discharge.</p>  <p>C1, C2: Filter capacitor $1\mu\text{F}\pm 10\%$ C3: Capacitor $0.033\mu\text{F}\pm 5\%$ L1 to L4: Rod coa choke $1.5\text{mH}\pm 20\%$, 16A R: Resistor $100\Omega\pm 2\%$ $C_x < 0.068\mu\text{F}$ Ct: Tank capacitor $3\mu\text{F}\pm 5\%$ 10kV $C_x \leq 1\mu\text{F}$ U-: $UR\pm 5\%$ UR: Rated voltage Cx: Capacitor under test F: Slow-blow fuse, rated 16A Ut: Voltage to which the tank capacitor Ct is charged</p> 

GRM
 GR3
 GRJ
 GR4
 GR7
 GJM
 GQM
 GA2
 GA3 GB
 GA3 GD
 GA3 GF
 LLL
 LLA
 LLM
 LLR
 NFM
 KPM
 KR3
 GMA
 GMD
 ⚠Caution / Notice

GA3 Series Type GD Specifications and Test Methods (1)

Continued from the preceding page. ↘

Complement of Test Method

1. Test Substrate

The test substrate should be Substrate A or Substrate B as described in "Specifications and Test Methods".
 The specimen should be soldered by the conditions as described below.

Soldering Method: Reflow soldering
 Solder: Sn-3.0Ag-0.5Cu

(1) Test Substrate A

• Land Dimensions

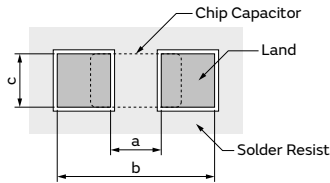

Part Number	Dimension (mm)		
	a	b	c
GA342	3.5	7.0	2.4

- Material: Glass Epoxy Board
- Thickness: 1.6mm
- Thickness of Copper Foil: 0.035mm

(2) Test Substrate B

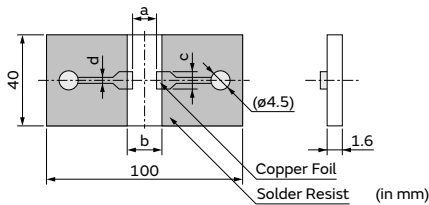

Part Number	Dimension of Pattern (mm)			
	a	b	c	d
GA342	3.5	7.0	2.4	1.0

- Material: Glass Epoxy Board
- Thickness of Copper Foil: 0.035mm

2. Test Method of Substrate Bending Test

(a) Support State

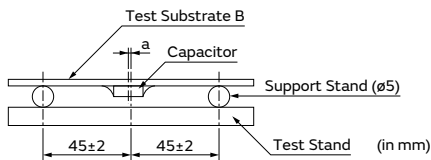

a: ±2 gap between support stand center and test stand

(b) Test State

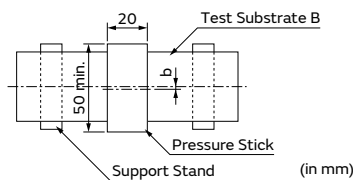

b: ±5 gap between support stand center and test stand center

- Material of Test Stand and Pressure Stick
 The material should be a metal where a remarkable transformation and the distortion are not caused even if it is pressurized.
- Pressurizing Speed
 The pressurizing speed is pressurized at the speed of about 1mm/s until the flexure reaches a regulated value.

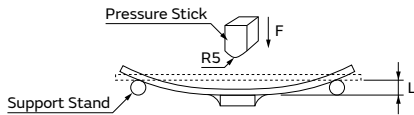

GRM
 GR3
 GRJ
 GR4
 GR7
 GJM
 GQM
 GA2
 GA3 GB
 GA3 GD
 GA3 GF
 LLL
 LLA
 LLM
 LLR
 NFM
 KRM
 KR3
 GMA
 GMD
 Caution / Notice

2

GA3 Series Type GD Specifications and Test Methods (2)

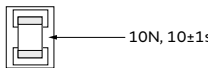
No	Item	Specification	Test Method (Ref. Standard: JIS C 5101, IEC60384)												
1	Appearance	No defects or abnormalities.	Visual inspection.												
2	Dimension	Within the specified dimensions.	Using calipers and micrometers.												
3	Voltage Proof	No defects or abnormalities.	Measurement Point: Between the terminations Test Voltage: AC1500V (r.m.s.) Applied Time: 60±1s Charge/discharge current: 50mA max.												
4	Impulse Voltage	No self healing break downs or flash-overs have taken place in the capacitor.	10 impulse of alternating polarity is subjected. (5 impulse for each polarity) The interval between impulse is 60s. Applied Voltage: 2.5kVo-p												
5	Insulation Resistance (I.R.)	6000MΩ or more	Measurement Point: Between the terminations Measurement Voltage: DC500±50V Charging Time: 60±5s Measurement Temperature: Room Temperature												
6	Capacitance	Shown in Rated value.	Measurement Temperature: Room Temperature Measurement Frequency: 1.0±0.1kHz												
7	Dissipation Factor (D.F.)	0.025 max.	Measurement Voltage: AC1.0±0.2V (r.m.s.)												
8	Temperature Characteristics of Capacitance	R7: Within ±15% (-55 to +125°C)	The capacitance change should be measured after 5 minutes at each specified temp. stage. Capacitance value as a reference is the value in step 3. <table border="1"> <thead> <tr> <th>Step</th> <th>Temperature (°C)</th> </tr> </thead> <tbody> <tr> <td>1</td> <td>Reference Temp. ±2</td> </tr> <tr> <td>2</td> <td>Min. Operating Temp. ±3</td> </tr> <tr> <td>3</td> <td>Reference Temp. ±2</td> </tr> <tr> <td>4</td> <td>Max. Operating Temp. ±3</td> </tr> <tr> <td>5</td> <td>Reference Temp. ±2</td> </tr> </tbody> </table> <ul style="list-style-type: none"> • Pretreatment Perform a heat treatment at 150+0/-10°C for 1h±5min and then let sit for 24±2h at room condition*. 	Step	Temperature (°C)	1	Reference Temp. ±2	2	Min. Operating Temp. ±3	3	Reference Temp. ±2	4	Max. Operating Temp. ±3	5	Reference Temp. ±2
Step	Temperature (°C)														
1	Reference Temp. ±2														
2	Min. Operating Temp. ±3														
3	Reference Temp. ±2														
4	Max. Operating Temp. ±3														
5	Reference Temp. ±2														
9	Vibration	Appearance	Solder the capacitor on the test substrate A shown in "Complement of Test Method". Kind of Vibration: A simple harmonic motion 10Hz to 55Hz to 10Hz (1min) Total amplitude: 1.5mm This motion should be applied for a period of 2h in each 3 mutually perpendicular directions (total of 6h).												
		Capacitance													
		D.F.													
10	Solderability	95% of the terminations is to be soldered evenly and continuously.	Test Method: Solder bath method Flux: Solution of rosin ethanol 25 (wt)% Preheat: 80 to 120°C for 10 to 30s Solder: Sn-3.0Ag-0.5Cu (Lead Free Solder) Solder Temp.: 245±5°C Immersion time: 2±0.5s Immersing in speed: 25±2.5mm/s.												
11	Resistance to Soldering Heat	Appearance	Test Method: Solder bath method Solder: Sn-3.0Ag-0.5Cu (Lead Free Solder) Solder Temp.: 260±5°C Immersion time: 10±1s Immersing in speed: 25±2.5mm/s. Exposure Time: 24±2h at room condition*. Preheat: GA342/43 size: 100 to 120°C for 1min and 170 to 200°C for 1min <ul style="list-style-type: none"> • Pretreatment Perform a heat treatment at 150+0/-10°C for 1h±5min and then let sit for 24±2h at room condition*. 												
		Capacitance Change													
		I.R.													
		Voltage Proof													
12	Adhesive Strength of Termination	No removal of the terminations or other defect should occur.	Solder the capacitor on the test substrate A shown in "Complement of Test Method".  Applied Direction: In parallel with the test substrate and vertical with the capacitor side.												

* Room Condition: Temperature: 15 to 35°C, Relative humidity: 45 to 75%, Atmosphere pressure: 86 to 106kPa

Continued on the following page. ↗

GRM
GR3
GRJ
GR4
GR7
GJM
GQM
GA2
GA3 GB
GA3 GD
GA3 GF
LLL
LLA
LLM
LLR
NFM
KPM
KR3
GMA
GMD
⚠Caution / Notice

GA3 Series Type GD Specifications and Test Methods (2)

Continued from the preceding page. ↘

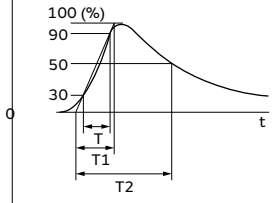
No	Item	Specification	Test Method (Ref. Standard: JIS C 5101, IEC60384)															
13	Substrate Bending Test	No defects or abnormalities.	Solder the capacitor on the test substrate B shown in "Complement of Test Method". Then apply the force in the direction shown in "Test Method of Substrate Bending Test" of "Complement of Test Method" Flexure: 1mm Holding Time: 5±1s Soldering Method: Reflow soldering															
14	Temperature Sudden Change	Appearance	Fix the capacitor to the supporting test substrate A (glass epoxy board) shown in "Complement of Test Method". Perform the 5 cycles according to the four heat treatments shown in the following table. <table border="1" style="margin: 10px auto;"> <thead> <tr> <th>Step</th> <th>Temp. (°C)</th> <th>Time (min)</th> </tr> </thead> <tbody> <tr> <td>1</td> <td>Min. Operating Temp. +0/-3</td> <td>30±3</td> </tr> <tr> <td>2</td> <td>Room Temp.</td> <td>2 to 3</td> </tr> <tr> <td>3</td> <td>Max. Operating Temp. +3/-0</td> <td>30±3</td> </tr> <tr> <td>4</td> <td>Room Temp.</td> <td>2 to 3</td> </tr> </tbody> </table> Exposure Time: 24±2h at room condition*. • Pretreatment Perform a heat treatment at 150+0/-10°C for 1h±5min and then let sit for 24±2h at room condition*.	Step	Temp. (°C)	Time (min)	1	Min. Operating Temp. +0/-3	30±3	2	Room Temp.	2 to 3	3	Max. Operating Temp. +3/-0	30±3	4	Room Temp.	2 to 3
		Step		Temp. (°C)	Time (min)													
		1		Min. Operating Temp. +0/-3	30±3													
		2		Room Temp.	2 to 3													
		3		Max. Operating Temp. +3/-0	30±3													
4	Room Temp.	2 to 3																
Capacitance Change	Within±15%																	
D.F.	0.05 max.																	
I.R.	3000MΩ or more																	
Voltage Proof	No defects.																	
15	High Temperature High Humidity (Steady)	Appearance	Fix the capacitor to the supporting test substrate B (glass epoxy board) shown in "Complement of Test Method". Before this test, the test shown in the following is performed. • No.12 Adhesive Strength of Termination (apply force: 5N) • No.13 Substrate Bending Test Test Temperature: 40±2°C Test Humidity: 90 to 95%RH Test Time: 500+24/-0h Applied Voltage: Rated voltage Exposure Time: 24±2h at room condition*. • Pretreatment Perform a heat treatment at 150+0/-10°C for 1h±5min and then let sit for 24±2h at room condition*.															
		Capacitance Change		Within±15%														
		D.F.		0.05 max.														
		I.R.		3000MΩ or more														
		Voltage Proof		No defects.														
16	Durability	Appearance	Fix the capacitor to the supporting test substrate B (glass epoxy board) shown in "Complement of Test Method". Before this test, the test shown in the following is performed. • No.12 Adhesive Strength of Termination (apply force: 5N) • No.13 Substrate Bending Test Next, Impulse Voltage test is performed. Each individual capacitor shall be subjected to a 2.5kV Impulse (the voltage value means zero to peak) for 3 times. Then the capacitors are applied to life test. 															
		Capacitance Change		Within ±20%														
		D.F.		0.05 max.														
		I.R.		3000MΩ or more														
		Voltage Proof		No defects.														
			Apply voltage as Table for 1000h at 125+2/-0°C, relative humidity 50% max. <table border="1" style="margin: 10px auto;"> <thead> <tr> <th>Applied Voltage</th> </tr> </thead> <tbody> <tr> <td>AC425V (r.m.s.), except that once each hour the voltage is increased to AC1000V (r.m.s.) for 0.1s.</td> </tr> </tbody> </table> Exposure Time: 24±2h at room condition*. • Pretreatment Perform a heat treatment at 150+0/-10°C for 1h±5min and then let sit for 24±2h at room condition*.	Applied Voltage	AC425V (r.m.s.), except that once each hour the voltage is increased to AC1000V (r.m.s.) for 0.1s.													
Applied Voltage																		
AC425V (r.m.s.), except that once each hour the voltage is increased to AC1000V (r.m.s.) for 0.1s.																		

* Room Condition: Temperature: 15 to 35°C, Relative humidity: 45 to 75%, Atmosphere pressure: 86 to 106kPa

Continued on the following page. ↗

GRM
GR3
GRJ
GR4
GR7
GJM
GQM
GA2
GA3 GB
GA3 GD
GA3 GF
LLL
LLA
LLM
LLR
NFM
KRM
KR3
GMA
GMD
Caution / Notice

GA3 Series Type GD Specifications and Test Methods (2)

Continued from the preceding page. ↘

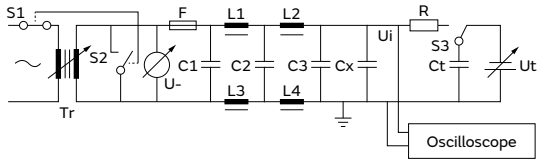
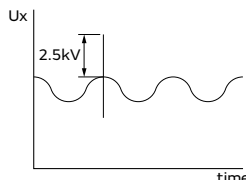
No	Item	Specification	Test Method (Ref. Standard: JIS C 5101, IEC60384)
17	Passive Flammability	The burning time shall not be exceeded the time 30s. The tissue paper shall not ignite.	<p>The capacitor under test shall be held in the flame in the position which best promotes burning. Each specimen shall only be exposed once to the flame. Time of exposure to flame: 30s Length of flame: 12±1mm Gas burner: Length 35mm min. Inside dia: 0.5±0.1mm Outside dia: 0.9mm max. Gas: Butane gas purity 95% min.</p> 
18	Active Flammability	The cheesecloth shall not be on fire.	<p>The specimens shall be individually wrapped in at least one but more than two complete layers of cheesecloth. The specimens shall be subjected to 20 discharges. The interval between successive discharges shall be 5s. The UAC shall be maintained for 2min after the last discharge.</p>  <p>C1, C2: Filter capacitor 1μF±10% C3: Capacitor 0.033μF±5% L1 to L4: Rod coa choke 1.5mH±20%, 16A R: Resistor 100Ω±2% Cx < 0.068μF Ct: Tank capacitor 3μF±5% 10kV Cx ≤ 1μF U-: UR±5% UR: Rated voltage Cx: Capacitor under test F: Slow-blow fuse, rated 16A Ut: Voltage to which the tank capacitor Ct is charged</p> 

GRM
 GR3
 GRJ
 GR4
 GR7
 GJM
 GQM
 GA2
 GA3 GB
 GA3 GD
 GA3 GF
 LLL
 LLA
 LLM
 LLR
 NFM
 KFM
 KR3
 GMA
 GMD
 ⚠Caution / Notice

GA3 Series Type GD Specifications and Test Methods (2)

Continued from the preceding page. ↘

Complement of Test Method

1. Test Substrate

The test substrate should be Substrate A or Substrate B as described in "Specifications and Test Methods".
 The specimen should be soldered by the conditions as described below.

Soldering Method: Reflow soldering
 Solder: Sn-3.0Ag-0.5Cu

(1) Test Substrate A

- Land Dimensions

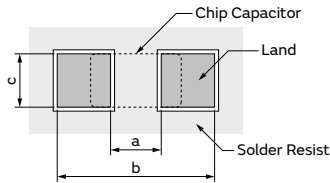

- Material: Glass Epoxy Board
- Thickness: 1.6mm
- Thickness of Copper Foil: 0.035mm

Part Number	Dimension (mm)		
	a	b	c
GA342	3.5	7.0	2.4
GA343	3.5	7.0	3.7

(2) Test Substrate B

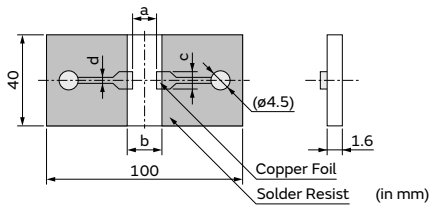

- Material: Glass Epoxy Board
- Thickness of Copper Foil: 0.035mm

Part Number	Dimension of Pattern (mm)			
	a	b	c	d
GA342	3.5	7.0	2.4	1.0
GA343	3.5	7.0	3.7	1.0

2. Test Method of Substrate Bending Test

(a) Support State

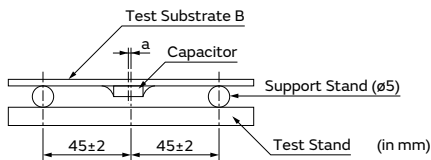

a: ±2 gap between support stand center and test stand

- Material of Test Stand and Pressure Stick
 The material should be a metal where a remarkable transformation and the distortion are not caused even if it is pressurized.
- Pressurizing Speed
 The pressurizing speed is pressurized at the speed of about 1mm/s until the flexure reaches a regulated value.

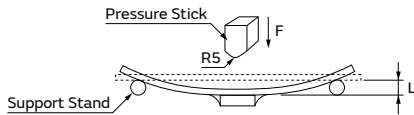

(b) Test State

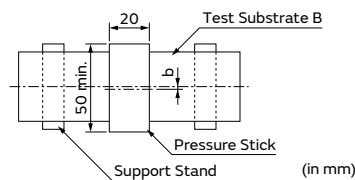

b: ±5 gap between support stand center and test stand center

GRM
 GR3
 GRJ
 GR4
 GR7
 GJM
 GQM
 GA2
 GA3 GB
 GA3 GD
 GA3 GF
 LLL
 LLA
 LLM
 LLR
 NFM
 KRM
 KR3
 GMA
 GMD
 Caution / Notice

Safety Standard Certified Chip Multilayer Ceramic Capacitors for General Purpose / Acquired certifications of IEC60384-14 Class X1/Y2 and UL60950-1

GA3 Series Type GF



Size 4.5x2.0mm: This product is applicable only for the instruments certified by EN/IEC60950-1
Size 5.7x2.8mm or 5.7x5.0mm: This product is applicable as X or Y capacitor

Features

① **International Standard (IEC60384-14) certified product.**

Please down load Safety Standard Certification (Type GF: X1/Y2) from here.



② **Can be used as a Class Y2 capacitor.**

● **Switching Power Supply - Class 1 Equipment**

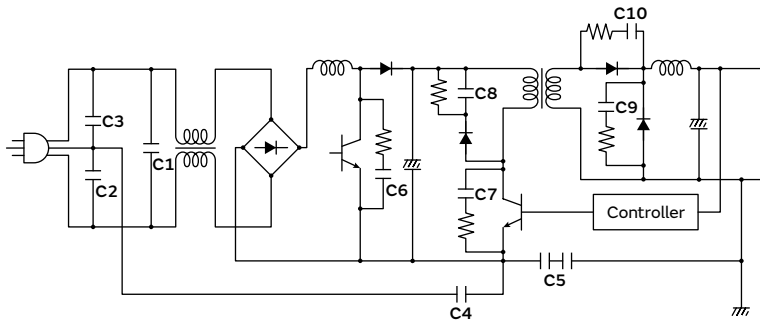

No.	Application	Recommend MLCC Type
C1	X Cap	Type: GB
C2	Y Cap	Type: GF
C3		
C4		
C5	Primary - Secondary Coupling	Type: GF×2

● **Switching Power Supply - Class 2 Equipment**

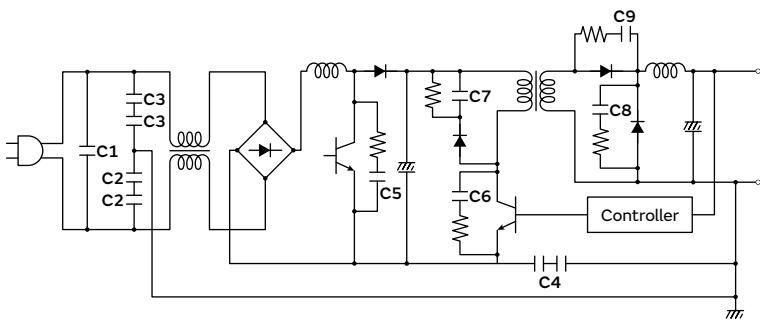

No.	Application	Recommend MLCC Type
C1	X Cap	Type: GB
C2	Y Cap	Type: GF×2
C3		
C4	Primary - Secondary Coupling	

- GRM
- GR3
- GRJ
- GR4
- GR7
- GJM
- GQM
- GA2
- GA3 GB
- GA3 GD
- GA3 GF
- LLL
- LLA
- LLM
- LLR
- NFM
- KPM
- KR3
- GMA
- GMD
- ⚠Caution /Notice

GRM
 GR3
 GRJ
 GR4
 GR7
 GJM
 GQM
 GA2
 GA3 GB
 GA3 GD
 GA3 GF
 LLL
 LLA
 LLM
 LLR
 NFM
 KRM
 KR3
 GMA
 GMD
 ⚠Caution /Notice

③ Realized large capacitance value and small size while maintaining high withstand voltages by the multilayer structure.

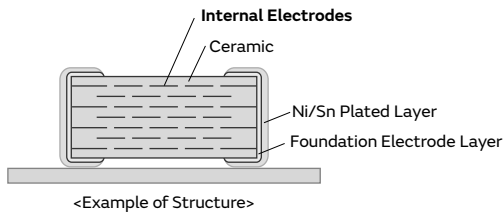

④ This product is only for reflow soldering.

Specifications

Size (mm)	4.5×2.0mm to 5.7×5.0mm
Rated Voltage	250Vac
Capacitance	10pF to 4700pF
Main Applications	AC-DC power supply

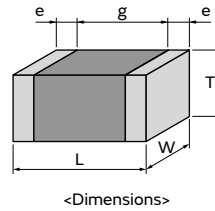

This catalog contains only a portion of the product lineup.
 Please refer to the capacitor search tool on the Murata Web site for details.

GA3 Series Type GF Temperature Compensating Type Part Number List

4.5×2.0mm

T max.	Rated Voltage	TC Code	Cap.	Tol.	Part Number	p*
1.0mm	250Vac	SL	10pF	±5%	GA342A1XGF100JW31#	p211
			12pF	±5%	GA342A1XGF120JW31#	p211
			15pF	±5%	GA342A1XGF150JW31#	p211
			18pF	±5%	GA342A1XGF180JW31#	p211
			22pF	±5%	GA342A1XGF220JW31#	p211
			27pF	±5%	GA342A1XGF270JW31#	p211
			33pF	±5%	GA342A1XGF330JW31#	p211
			39pF	±5%	GA342A1XGF390JW31#	p211
			47pF	±5%	GA342A1XGF470JW31#	p211
			56pF	±5%	GA342A1XGF560JW31#	p211
			68pF	±5%	GA342A1XGF680JW31#	p211
			82pF	±5%	GA342A1XGF820JW31#	p211

- GRM
- GR3
- GRJ
- GR4
- GR7
- GJM
- GQM
- GA2
- GA3 GB
- GA3 GD
- GA3 GF**
- LLL
- LLA
- LLM
- LLR
- NFM
- KRM
- KR3
- GMA
- GMD
- ⚠Caution /Notice

*: Refers to the page of the "Specifications and Test Methods".

Part number # indicates the package specification code.

GA3 Series Type GF High Dielectric Constant Type Part Number List

4.5×2.0mm

T max.	Rated Voltage	TC Code	Cap.	Tol.	Part Number	p*
1.5mm	250Vac	X7R	100pF	±10%	GA342QR7GF101KW01#	p215
			150pF	±10%	GA342QR7GF151KW01#	p215
			470pF	±10%	GA342QR7GF471KW01#	p215
			680pF	±10%	GA342QR7GF681KW01#	p215
2.2mm	250Vac	X7R	220pF	±10%	GA342DR7GF221KW02#	p215
			330pF	±10%	GA342DR7GF331KW02#	p215
			1000pF	±10%	GA342DR7GF102KW02#	p215

5.7×2.8mm

T max.	Rated Voltage	TC Code	Cap.	Tol.	Part Number	p*
1.5mm	250Vac	X7R	100pF	±10%	GA352QR7GF101KW31#	p215
			150pF	±10%	GA352QR7GF151KW31#	p215
			220pF	±10%	GA352QR7GF221KW31#	p215
			330pF	±10%	GA352QR7GF331KW31#	p215
			470pF	±10%	GA352QR7GF471KW01#	p215
			680pF	±10%	GA352QR7GF681KW01#	p215
			1000pF	±10%	GA352QR7GF102KW01#	p215
			1500pF	±10%	GA352QR7GF152KW01#	p215

5.7×5.0mm

T max.	Rated Voltage	TC Code	Cap.	Tol.	Part Number	p*
1.5mm	250Vac	X7R	1800pF	±10%	GA355QR7GF182KW01#	p215
			2200pF	±10%	GA355QR7GF222KW01#	p215
			3300pF	±10%	GA355QR7GF332KW01#	p215
2.0mm	250Vac	X7R	4700pF	±10%	GA355DR7GF472KW01#	p215

GRM
 GR3
 GRJ
 GR4
 GR7
 GJM
 GQM
 GA2
 GA3 GB
 GA3 GD
 GA3 GF
 LLL
 LLA
 LLM
 LLR
 NFM
 KRM
 KR3
 GMA
 GMD
 ⚠Caution /Notice

*: Refers to the page of the "Specifications and Test Methods".

Part number # indicates the package specification code.

1

GA3 Series Type GF Specifications and Test Methods (1)

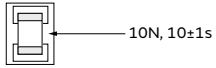
No	Item	Specification	Test Method (Ref. Standard: JIS C 5101, IEC60384)												
1	Appearance	No defects or abnormalities.	Visual inspection.												
2	Dimension	Within the specified dimensions.	Using calipers and micrometers.												
3	Voltage Proof	No defects or abnormalities.	Measurement Point: Between the terminations Test Voltage: AC2000V (r.m.s.) Applied Time: 60±1s Charge/discharge current: 50mA max.												
4	Impulse Voltage	No self healing break downs or flash-overs have taken place in the capacitor.	10 impulse of alternating polarity is subjected. (5 impulse for each polarity) The interval between impulse is 60s. Applied Voltage: 2.5kVo-p												
5	Insulation Resistance (I.R.)	6000MΩ or more	Measurement Point: Between the terminations Measurement Voltage: DC500±50V Charging Time: 60±5s Measurement Temperature: Room Temperature												
6	Capacitance	Shown in Rated value.	Measurement Temperature: Room Temperature Measurement Frequency: 1.0±0.1MHz Measurement Voltage: AC1.0±0.2V (r.m.s.)												
7	Q	C ≥ 30pF: 1000 or more C < 30pF: 400+20C or more C: Nominal Capacitance (pF)													
8	Temperature Characteristics of Capacitance	1X: +350 to -1000 ppm/°C (Temp.Range:+20 to +85°C)	The capacitance change should be measured after 5 minutes at each specified temp. stage. Capacitance value as a reference is the value in step 3. <table border="1" style="margin-left: auto; margin-right: auto;"> <thead> <tr> <th>Step</th> <th>Temperature (°C)</th> </tr> </thead> <tbody> <tr> <td>1</td> <td>Reference Temp. ±2</td> </tr> <tr> <td>2</td> <td>Min. Operating Temp. ±3</td> </tr> <tr> <td>3</td> <td>Reference Temp. ±2</td> </tr> <tr> <td>4</td> <td>Max. Operating Temp. ±3</td> </tr> <tr> <td>5</td> <td>Reference Temp. ±2</td> </tr> </tbody> </table> However, the capacitance shall be measured at even 85°C between step 3 and step 4.	Step	Temperature (°C)	1	Reference Temp. ±2	2	Min. Operating Temp. ±3	3	Reference Temp. ±2	4	Max. Operating Temp. ±3	5	Reference Temp. ±2
Step	Temperature (°C)														
1	Reference Temp. ±2														
2	Min. Operating Temp. ±3														
3	Reference Temp. ±2														
4	Max. Operating Temp. ±3														
5	Reference Temp. ±2														
9	Vibration	Appearance	Solder the capacitor on the test substrate A shown in "Complement of Test Method". Kind of Vibration: A simple harmonic motion 10Hz to 55Hz to 10Hz (1min) Total amplitude: 1.5mm This motion should be applied for a period of 2h in each 3 mutually perpendicular directions (total of 6h).												
		Capacitance													
		Q													
10	Solderability	95% of the terminations is to be soldered evenly and continuously.	Test Method: Solder bath method Flux: Solution of rosin ethanol 25 (wt)% Preheat: 80 to 120°C for 10 to 30s Solder: Sn-3.0Ag-0.5Cu (Lead Free Solder) Solder Temp.: 245±5°C Immersion time: 2±0.5s Immersing in speed: 25±2.5mm/s.												
11	Resistance to Soldering Heat	Appearance	Test Method: Solder bath method Solder: Sn-3.0Ag-0.5Cu (Lead Free Solder) Solder Temp.: 260±5°C Immersion time: 10±1s Immersing in speed: 25±2.5mm/s. Exposure Time: 24±2h at room condition*. Preheat: GA342 size: 100 to 120°C for 1min and 170 to 200°C for 1min												
		Capacitance Change													
		I.R.													
		Voltage Proof													
12	Adhesive Strength of Termination	No removal of the terminations or other defect should occur.	Solder the capacitor on the test substrate A shown in "Complement of Test Method".  Applied Direction: In parallel with the test substrate and vertical with the capacitor side.												
13	Substrate Bending Test	No defects or abnormalities.	Solder the capacitor on the test substrate B shown in "Complement of Test Method". Then apply the force in the direction shown in "Test Method of Substrate Bending Test" of "Complement of Test Method". Flexure: 1mm Holding Time: 5±1s Soldering Method: Reflow soldering												

* Room Condition: Temperature: 15 to 35°C, Relative humidity: 45 to 75%, Atmosphere pressure: 86 to 106kPa

Continued on the following page. ↗

GRM
 GR3
 GRJ
 GR4
 GR7
 GJM
 GQM
 GA2
 GA3 GB
 GA3 GD
 GA3 GF
 LLL
 LLA
 LLM
 LLR
 NFM
 KPM
 KR3
 GMA
 GMD
 ⚠Caution /Notice

GA3 Series Type GF Specifications and Test Methods (1)

Continued from the preceding page. ↘

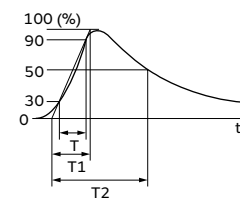
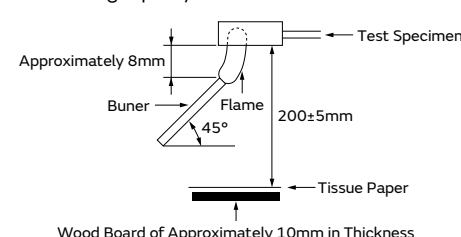
No	Item	Specification	Test Method (Ref. Standard: JIS C 5101, IEC60384)															
14	Temperature Sudden Change	Appearance	No defects or abnormalities.															
		Capacitance Change	Within $\pm 2.5\%$ or $\pm 0.25\text{pF}$ (Whichever is larger)															
		Q	Within the specified initial value.															
		I.R.	3000M Ω or more															
		Voltage Proof	No defects.															
			Fix the capacitor to the supporting test substrate A (glass epoxy board) shown in "Complement of Test Method". Perform the 5 cycles according to the four heat treatments shown in the following table.															
			<table border="1"> <thead> <tr> <th>Step</th> <th>Temp. (°C)</th> <th>Time (min)</th> </tr> </thead> <tbody> <tr> <td>1</td> <td>Min. Operating Temp. +0/-3</td> <td>30\pm3</td> </tr> <tr> <td>2</td> <td>Room Temp.</td> <td>2 to 3</td> </tr> <tr> <td>3</td> <td>Max. Operating Temp. +3/-0</td> <td>30\pm3</td> </tr> <tr> <td>4</td> <td>Room Temp.</td> <td>2 to 3</td> </tr> </tbody> </table>	Step	Temp. (°C)	Time (min)	1	Min. Operating Temp. +0/-3	30 \pm 3	2	Room Temp.	2 to 3	3	Max. Operating Temp. +3/-0	30 \pm 3	4	Room Temp.	2 to 3
Step	Temp. (°C)	Time (min)																
1	Min. Operating Temp. +0/-3	30 \pm 3																
2	Room Temp.	2 to 3																
3	Max. Operating Temp. +3/-0	30 \pm 3																
4	Room Temp.	2 to 3																
			Exposure Time: 24 \pm 2h at room condition*.															
15	High Temperature High Humidity (Steady)	Appearance	No defects or abnormalities.															
		Capacitance Change	Within $\pm 5.0\%$ or $\pm 0.5\text{pF}$ (Whichever is larger)															
		Q	C \geq 30pF: 350 or more C < 30pF: 275+5/2C or more C: Nominal Capacitance (pF)															
		I.R.	3000M Ω or more															
		Voltage Proof	No defects.															
			Fix the capacitor to the supporting test substrate B (glass epoxy board) shown in "Complement of Test Method". Before this test, the test shown in the following is performed. • No.12 Adhesive Strength of Termination (apply force: 5N) • No.13 Substrate Bending test Test Temperature: 40 \pm 2°C Test Humidity: 90 to 95%RH Test Time: 500+24/-0h Applied Voltage: Rated voltage Exposure Time: 24 \pm 2h at room condition*.															
16	Durability	Appearance	No defects or abnormalities.															
		Capacitance Change	Within $\pm 3.0\%$ or $\pm 0.3\text{pF}$ (Whichever is larger)															
		Q	C \geq 30pF: 350 or more C < 30pF: 275+5/2C or more C: Nominal Capacitance (pF)															
		I.R.	3000M Ω or more															
		Voltage Proof	No defects.															
			Fix the capacitor to the supporting test substrate B (glass epoxy board) shown in "Complement of Test Method". Before this test, the test shown in the following is performed. • No.12 Adhesive Strength of Termination (apply force: 5N) • No.13 Substrate Bending test Next, Impulse Voltage test is performed. Each individual capacitor shall be subjected to a 5kV Impulse (the voltage value means zero to peak) for 3 times. Then the capacitors are applied to life test.															
			 <p>Front time (T1) = 1.2μs=1.67T Time to half-value (T2) = 50μs</p>															
			Apply voltage as Table for 1000h at 125+2/-0°C, relative humidity 50% max.															
			<table border="1"> <thead> <tr> <th colspan="2">Applied voltage</th> </tr> </thead> <tbody> <tr> <td>AC425V (r.m.s.), except that once each hour the voltage is increased to AC1000V (r.m.s.) for 0.1s.</td> <td></td> </tr> </tbody> </table>	Applied voltage		AC425V (r.m.s.), except that once each hour the voltage is increased to AC1000V (r.m.s.) for 0.1s.												
Applied voltage																		
AC425V (r.m.s.), except that once each hour the voltage is increased to AC1000V (r.m.s.) for 0.1s.																		
			Exposure Time: 24 \pm 2h at room condition*.															
17	Passive Flammability	The burning time shall not be exceeded the time 30s. The tissue paper shall not ignite.	The capacitor under test shall be held in the flame in the position which best promotes burning. Each specimen shall only be exposed once to the flame. Time of exposure to flame: 30s Length of flame: 12 \pm 1mm Gas burner: Length 35mm min. Inside dia: 0.5 \pm 0.1mm Outside dia: 0.9mm max. Gas: Butane gas purity 95% min.															
																		

* Room Condition: Temperature: 15 to 35°C, Relative humidity: 45 to 75%, Atmosphere pressure: 86 to 106kPa

Continued on the following page. ↗

GRM
GR3
GRJ
GR4
GR7
GJM
GQM
GA2
GA3 GB
GA3 GD
GA3 GF
LLL
LLA
LLM
LLR
NFM
KRM
KR3
GMA
GMD
Caution / Notice

GA3 Series Type GF Specifications and Test Methods (1)

Continued from the preceding page. ↘

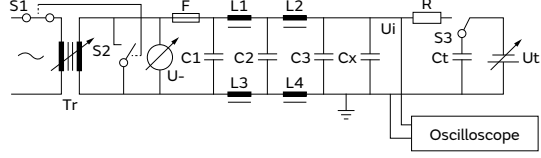
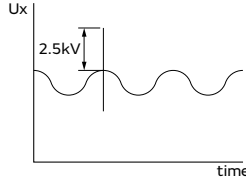
No	Item	Specification	Test Method (Ref. Standard: JIS C 5101, IEC60384)
18	Active Flammability	The cheesecloth shall not be on fire.	<p>The specimens shall be individually wrapped in at least one but more than two complete layers of cheesecloth. The specimens shall be subjected to 20 discharges. The interval between successive discharges shall be 5s. The UAC shall be maintained for 2min after the last discharge.</p>  <p>C1, C2: Filter capacitor $1\mu\text{F}\pm 10\%$ C3: Capacitor $0.033\mu\text{F}\pm 5\%$ L1 to L4: Rod coa choke $1.5\text{mH}\pm 20\%$, 16A R: Resistor $100\Omega\pm 2\%$ $C_x < 0.068\mu\text{F}$ Ct: Tank capacitor $3\mu\text{F}\pm 5\%$ 10kV $C_x \leq 1\mu\text{F}$ U-: $UR\pm 5\%$ UR: Rated voltage Cx: Capacitor under test F: Slow-blow fuse, rated 16A Ut: Voltage to which the tank capacitor Ct is charged</p> 

GRM
 GR3
 GRJ
 GR4
 GR7
 GJM
 GQM
 GA2
 GA3 GB
 GA3 GD
 GA3 GF
 LLL
 LLA
 LLM
 LLR
 NFM
 KPM
 KR3
 GMA
 GMD
 △Caution / Notice

GA3 Series Type GF Specifications and Test Methods (1)

Continued from the preceding page. ↘

Complement of Test Method

1. Test Substrate

The test substrate should be Substrate A or Substrate B as described in "Specifications and Test Methods".
 The specimen should be soldered by the conditions as described below.

Soldering Method: Reflow soldering
 Solder: Sn-3.0Ag-0.5Cu

(1) Test Substrate A

• Land Dimensions

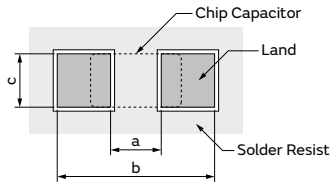

Part Number	Dimension (mm)		
	a	b	c
GA342	3.5	7.0	2.4

- Material: Glass Epoxy Board
- Thickness: 1.6mm
- Thickness of Copper Foil: 0.035mm

(2) Test Substrate B

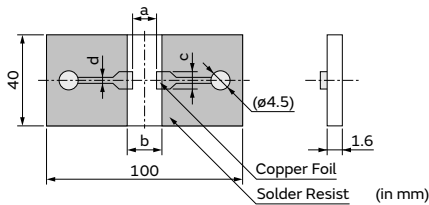

Part Number	Dimension of Pattern (mm)			
	a	b	c	d
GA342	3.5	7.0	2.4	1.0

- Material: Glass Epoxy Board
- Thickness of Copper Foil: 0.035mm

2. Test Method of Substrate Bending Test

(a) Support State

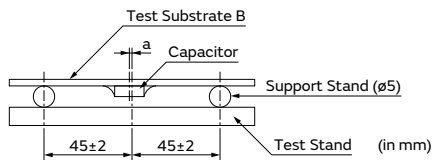

a: ±2 gap between support stand center and test stand

(b) Test State

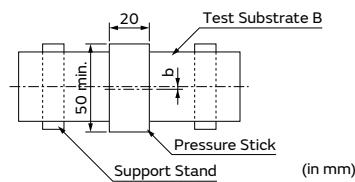

b: ±5 gap between support stand center and test stand center

- Material of Test Stand and Pressure Stick
 The material should be a metal where a remarkable transformation and the distortion are not caused even if it is pressurized.
- Pressurizing Speed
 The pressurizing speed is pressurized at the speed of about 1mm/s until the flexure reaches a regulated value.

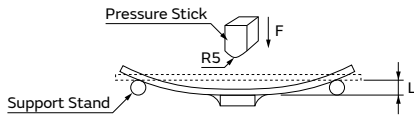

GRM
 GR3
 GRJ
 GR4
 GR7
 GJM
 GQM
 GA2
 GA3 GB
 GA3 GD
 GA3 GF
 LLL
 LLA
 LLM
 LLR
 NFM
 KRM
 KR3
 GMA
 GMD
 ⚠️Caution /Notice

2

GA3 Series Type GF Specifications and Test Methods (2)

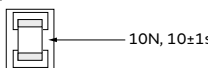
No	Item	Specification	Test Method (Ref. Standard: JIS C 5101, IEC60384)												
1	Appearance	No defects or abnormalities.	Visual inspection.												
2	Dimension	Within the specified dimensions.	Using calipers and micrometers.												
3	Voltage Proof	No defects or abnormalities.	Measurement Point: Between the terminations Test Voltage: AC2000V (r.m.s.) Applied Time: 60±1s Charge/discharge current: 50mA max.												
4	Impulse Voltage	No self healing break downs or flash-overs have taken place in the capacitor.	10 impulse of alternating polarity is subjected. (5 impulse for each polarity) The interval between impulse is 60s. Applied Voltage: 2.5kVo-p												
5	Insulation Resistance (I.R.)	6000MΩ or more	Measurement Point: Between the terminations Measurement Voltage: DC500±50V Charging Time: 60±5s Charge/discharge current: 50mA max. Measurement Temperature: Room Temperature												
6	Capacitance	Shown in Rated value.	Measurement Temperature: Room Temperature Measurement Frequency: 1.0±0.1kHz Measurement Voltage: AC1.0±0.2V (r.m.s.)												
7	Dissipation Factor (D.F.)	0.025 max.													
8	Temperature Characteristics of Capacitance	R7: Within ±15% (-55 to +125°C)	The capacitance change should be measured after 5 minutes at each specified temp. stage. Capacitance value as a reference is the value in step 3. <table border="1" style="margin-left: 20px;"> <thead> <tr> <th>Step</th> <th>Temperature (°C)</th> </tr> </thead> <tbody> <tr> <td>1</td> <td>Reference Temp. ±2</td> </tr> <tr> <td>2</td> <td>Min. Operating Temp. ±3</td> </tr> <tr> <td>3</td> <td>Reference Temp. ±2</td> </tr> <tr> <td>4</td> <td>Max. Operating Temp. ±3</td> </tr> <tr> <td>5</td> <td>Reference Temp. ±2</td> </tr> </tbody> </table> <ul style="list-style-type: none"> • Pretreatment Perform a heat treatment at 150+0/-10°C for 1h±5min and then let sit for 24±2h at room condition*. 	Step	Temperature (°C)	1	Reference Temp. ±2	2	Min. Operating Temp. ±3	3	Reference Temp. ±2	4	Max. Operating Temp. ±3	5	Reference Temp. ±2
Step	Temperature (°C)														
1	Reference Temp. ±2														
2	Min. Operating Temp. ±3														
3	Reference Temp. ±2														
4	Max. Operating Temp. ±3														
5	Reference Temp. ±2														
9	Vibration	Appearance	No defects or abnormalities.												
		Capacitance	Within the specified initial value.												
		D.F.	Within the specified initial value.												
Test Method: Solder bath method Flux: Solution of rosin ethanol 25 (wt)% Preheat: 80 to 120°C for 10 to 30s Solder: Sn-3.0Ag-0.5Cu (Lead Free Solder) Solder Temp.: 245±5°C Immersion time: 2±0.5s Immersing in speed: 25±2.5mm/s.															
Kind of Vibration: A simple harmonic motion 10Hz to 55Hz to 10Hz (1min) Total amplitude: 1.5mm This motion should be applied for a period of 2h in each 3 mutually perpendicular directions (total of 6h).															
11	Resistance to Soldering Heat	Appearance	No defects or abnormalities.												
		Capacitance Change	Within ±10%												
		I.R.	1000MΩ or more												
		Voltage Proof	No defects.												
12	Adhesive Strength of Termination	No removal of the terminations or other defect should occur.													
		Solder the capacitor on the test substrate A shown in "Complement of Test Method".  Applied Direction: In parallel with the test substrate and vertical with the capacitor side.													

* Room Condition: Temperature: 15 to 35°C, Relative humidity: 45 to 75%, Atmosphere pressure: 86 to 106kPa

Continued on the following page. ↗

GRM
 GR3
 GRJ
 GR4
 GR7
 GJM
 GQM
 GA2
 GA3 GB
 GA3 GD
 GA3 GF
 LLL
 LLA
 LLM
 LLR
 NFM
 KPM
 KR3
 GMA
 GMD
 △Caution / Notice

GA3 Series Type GF Specifications and Test Methods (2)

Continued from the preceding page. ↘

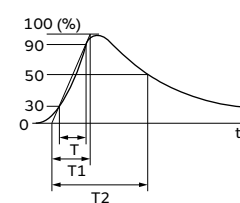
No	Item	Specification	Test Method (Ref. Standard: JIS C 5101, IEC60384)															
13	Substrate Bending Test	No defects or abnormalities.	Solder the capacitor on the test substrate B shown in "Complement of Test Method". Then apply the force in the direction shown in "Test Method of Substrate Bending Test" of "Complement of Test Method". Flexure: 1mm Holding Time: 5±1s Soldering Method: Reflow soldering															
14	Temperature Sudden Change	Appearance	Fix the capacitor to the supporting test substrate A (glass epoxy board) shown in "Complement of Test Method". Perform the 5 cycles according to the four heat treatments shown in the following table. <table border="1" style="margin: 10px auto;"> <thead> <tr> <th>Step</th> <th>Temp. (°C)</th> <th>Time (min)</th> </tr> </thead> <tbody> <tr> <td>1</td> <td>Min. Operating Temp. +0/-3</td> <td>30±3</td> </tr> <tr> <td>2</td> <td>Room Temp.</td> <td>2 to 3</td> </tr> <tr> <td>3</td> <td>Max. Operating Temp. +3/-0</td> <td>30±3</td> </tr> <tr> <td>4</td> <td>Room Temp.</td> <td>2 to 3</td> </tr> </tbody> </table> Exposure Time: 24±2h at room condition*. • Pretreatment Perform a heat treatment at 150+0/-10°C for 1h±5min and then let sit for 24±2h at room condition*.	Step	Temp. (°C)	Time (min)	1	Min. Operating Temp. +0/-3	30±3	2	Room Temp.	2 to 3	3	Max. Operating Temp. +3/-0	30±3	4	Room Temp.	2 to 3
		Step		Temp. (°C)	Time (min)													
		1		Min. Operating Temp. +0/-3	30±3													
		2		Room Temp.	2 to 3													
		3		Max. Operating Temp. +3/-0	30±3													
4	Room Temp.	2 to 3																
Capacitance Change	Within±15%																	
D.F.	0.05 max.																	
I.R.	3000MΩ or more																	
Voltage Proof	No defects.																	
15	High Temperature High Humidity (Steady)	Appearance	Fix the capacitor to the supporting test substrate B (glass epoxy board) shown in "Complement of Test Method". Before this test, the test shown in the following is performed. • No.12 Adhesive Strength of Termination (apply force: 5N) • No.13 Substrate Bending Test Test Temperature: 40±2°C Test Humidity: 90 to 95%RH Test Time: 500+24/-0h Applied Voltage: Rated voltage Exposure Time: 24±2h at room condition*. • Pretreatment Perform a heat treatment at 150+0/-10°C for 1h±5min and then let sit for 24±2h at room condition*.															
		Capacitance Change		Within±15%														
		D.F.		0.05 max.														
		I.R.		3000MΩ or more														
		Voltage Proof		No defects.														
16	Durability	Appearance	Fix the capacitor to the supporting test substrate B (glass epoxy board) shown in "Complement of Test Method". Before this test, the test shown in the following is performed. • No.12 Adhesive Strength of Termination (apply force: 5N) • No.13 Substrate Bending Test Next, Impulse Voltage test is performed. Each individual capacitor shall be subjected to a 5kV Impulse (the voltage value means zero to peak) for 3 times. Then the capacitors are applied to life test.  Front time (T1) = 1.2μs=1.67T Time to half-value (T2) = 50μs Apply voltage as Table for 1000h at 125+2/-0°C, relative humidity 50% max. <table border="1" style="margin: 10px auto;"> <thead> <tr> <th colspan="2">Applied Voltage</th> </tr> </thead> <tbody> <tr> <td>AC425V (r.m.s.), except that once each hour the voltage is increased to AC1000V (r.m.s.) for 0.1s.</td> <td></td> </tr> </tbody> </table> Exposure Time: 24±2h at room condition*. • Pretreatment Perform a heat treatment at 150+0/-10°C for 1h±5min and then let sit for 24±2h at room condition*.	Applied Voltage		AC425V (r.m.s.), except that once each hour the voltage is increased to AC1000V (r.m.s.) for 0.1s.												
		Applied Voltage																
		AC425V (r.m.s.), except that once each hour the voltage is increased to AC1000V (r.m.s.) for 0.1s.																
		Capacitance Change		Within ±20%														
		D.F.		0.05 max.														
I.R.	3000MΩ or more																	
Voltage Proof	No defects.																	

* Room Condition: Temperature: 15 to 35°C, Relative humidity: 45 to 75%, Atmosphere pressure: 86 to 106kPa

Continued on the following page. ↗

GRM
GR3
GRJ
GR4
GR7
GJM
GQM
GA2
GA3 GB
GA3 GD
GA3 GF
LLL
LLA
LLM
LLR
NFM
KRM
KR3
GMA
GMD
Caution / Notice

GA3 Series Type GF Specifications and Test Methods (2)

Continued from the preceding page. ↘

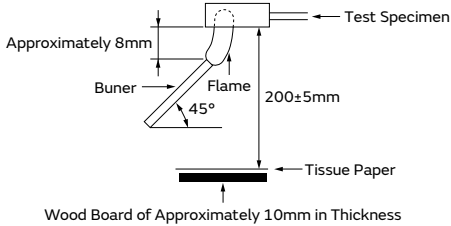
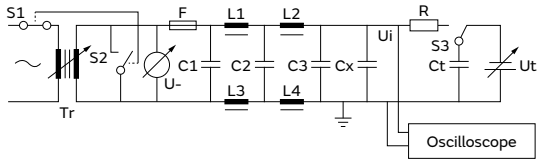
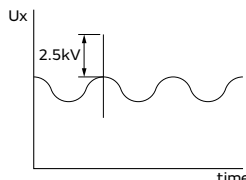
No	Item	Specification	Test Method (Ref. Standard: JIS C 5101, IEC60384)
17	Passive Flammability	The burning time shall not be exceeded the time 30s. The tissue paper shall not ignite.	<p>The capacitor under test shall be held in the flame in the position which best promotes burning. Each specimen shall only be exposed once to the flame. Time of exposure to flame: 30s Length of flame: 12±1mm Gas burner: Length 35mm min. Inside dia: 0.5±0.1mm Outside dia: 0.9mm max. Gas: Butane gas purity 95% min.</p> 
18	Active Flammability	The cheesecloth shall not be on fire.	<p>The specimens shall be individually wrapped in at least one but more than two complete layers of cheesecloth. The specimens shall be subjected to 20 discharges. The interval between successive discharges shall be 5s. The UAC shall be maintained for 2min after the last discharge.</p>  <p>C1, C2: Filter capacitor 1µF±10% C3: Capacitor 0.033µF±5% L1 to L4: Rod coa choke 1.5mH±20%, 16A R: Resistor 100Ω±2% Cx < 0.068µF Ct: Tank capacitor 3µF±5% 10kV Cx ≤ 1µF U-: UR±5% UR: Rated voltage Cx: Capacitor under test F: Slow-blow fuse, rated 16A Ut: Voltage to which the tank capacitor Ct is charged</p> 

GRM
 GR3
 GRJ
 GR4
 GR7
 GJM
 GQM
 GA2
 GA3 GB
 GA3 GD
 GA3 GF
 LLL
 LLA
 LLM
 LLR
 NFM
 KPM
 KR3
 GMA
 GMD
 ⚠Caution / Notice

GA3 Series Type GF Specifications and Test Methods (2)

Continued from the preceding page. ↘

Complement of Test Method

1. Test Substrate

The test substrate should be Substrate A or Substrate B as described in "Specifications and Test Methods".
 The specimen should be soldered by the conditions as described below.

Soldering Method: Reflow soldering
 Solder: Sn-3.0Ag-0.5Cu

(1) Test Substrate A

- Land Dimensions

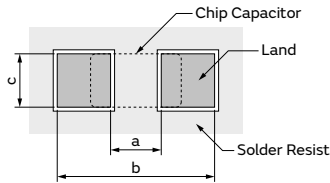

- Material: Glass Epoxy Board
- Thickness: 1.6mm
- Thickness of Copper Foil: 0.035mm

Part Number	Dimension (mm)		
	a	b	c
GA342	3.5	7.0	2.4
GA352	4.5	8.0	3.2
GA355	4.5	8.0	5.6

(2) Test Substrate B

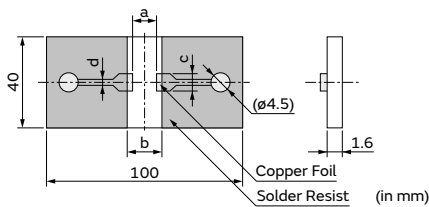

- Material: Glass Epoxy Board
- Thickness of Copper Foil: 0.035mm

Part Number	Dimension of Pattern (mm)			
	a	b	c	d
GA342	3.5	7.0	2.4	1.0
GA352	4.5	8.0	3.2	1.0
GA355	4.5	8.0	5.6	1.0

2. Test Method of Substrate Bending Test

(a) Support State

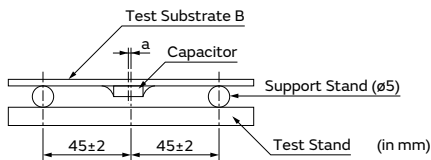

a: ±2 gap between support stand center and test stand

- Material of Test Stand and Pressure Stick
 The material should be a metal where a remarkable transformation and the distortion are not caused even if it is pressurized.
- Pressurizing Speed
 The pressurizing speed is pressurized at the speed of about 1mm/s until the flexure reaches a regulated value.

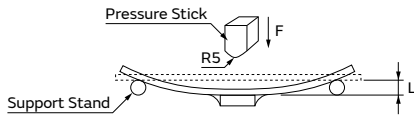

(b) Test State

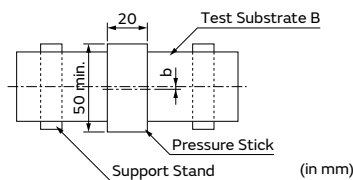

b: ±5 gap between support stand center and test stand center

GRM
 GR3
 GRJ
 GR4
 GR7
 GJM
 GQM
 GA2
 GA3 GB
 GA3 GD
 GA3 GF
 LLL
 LLA
 LLM
 LLR
 NFM
 KRM
 KR3
 GMA
 GMD
 Caution / Notice

LW Reversed Low ESL Chip Multilayer Ceramic Capacitors for General Purpose

LLL Series



This low ESL capacitor is ideal for power supply decoupling of high-speed operation electronic equipment.

Features

① Low ESL

Since the equivalent series inductance (ESL) is low and excellent in high frequency characteristics, this capacitor is suitable for power supply decoupling of high-speed operation electronic equipment.

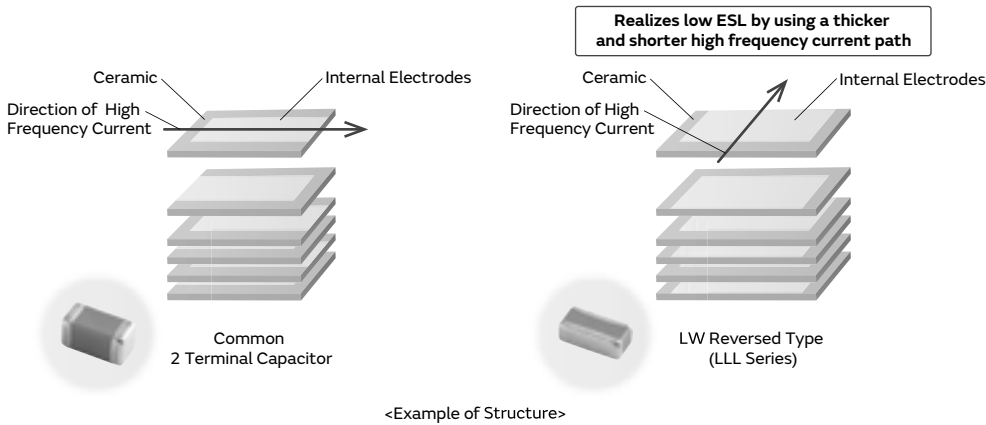

② Contributes to a reduction in the number of components.

The number of components can be reduced by using low ESL capacitors, while maintaining functions equivalent to general purpose capacitors (GRM Series).

Murata proposes the use of the LLL series to reduce the number of components and high costs. Simulation is also possible.

Proposal for Cost Reductions

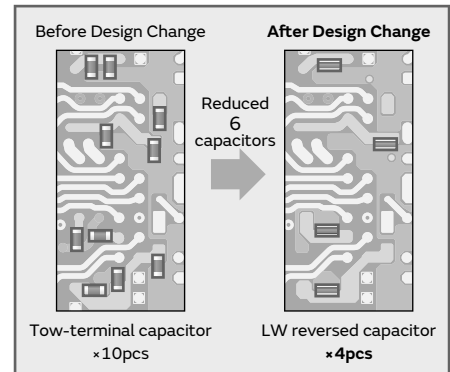

③ A maximum operating temperature up to 125°C

We also offer an abundant lineup of X7* characteristics that can be used in high temperature locations, such as IC packages.

Specifications

Size (mm)	0.5×1.0mm to 1.6×3.2mm
Rated Voltage	2.5Vdc to 50Vdc
Capacitance	2200pF to 10μF
Main Applications	Application processor/CPU/GPU

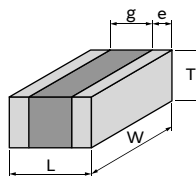

<Dimensions>

This catalog contains only a portion of the product lineup. Please refer to the capacitor search tool on the Murata Web site for details.

- GRM
- GR3
- GRJ
- GR4
- GR7
- GJM
- GQM
- GA2
- GA3 GB
- GA3 GD
- GA3 GF
- LLL
- LLA
- LLM
- LLR
- NFM
- KRM
- KR3
- GMA
- GMD
- △Caution /Notice

LLL Series High Dielectric Constant Type Part Number List

0.5×1.0mm

T max.	Rated Voltage	TC Code	Cap.	Tol.	Part Number
0.35mm	6.3Vdc	X6S	0.10μF	±20%	LLL153C80J104ME01#
			0.22μF	±20%	LLL153C80J224ME14#
	4Vdc	X7S	0.47μF	±20%	LLL153C70G474ME17#
		X6S	1.0μF	±20%	LLL153C80G105ME21#

0.6×1.0mm

T max.	Rated Voltage	TC Code	Cap.	Tol.	Part Number
0.45mm	4Vdc	X5R	4.3μF	±20%	LLL1U4R60G435ME22# D1

0.8×1.6mm

T max.	Rated Voltage	TC Code	Cap.	Tol.	Part Number
0.5mm	25Vdc	X7R	10000pF	±20%	LLL185R71E103MA11#
			22000pF	±20%	LLL185R71C223MA11#
				±20%	LLL185R71C473MA11#
	10Vdc	X7R	0.10μF	±20%	LLL185R71A104MA11#
			X7S	0.22μF	±20%
0.55mm	4Vdc	X7S	2.2μF	±20%	LLL185C70G225ME01#
0.6mm	50Vdc	X7R	2200pF	±20%	LLL185R71H222MA01#
			4700pF	±20%	LLL185R71H472MA01#
	25Vdc	X7R	10000pF	±20%	LLL185R71E103MA01#
			22000pF	±20%	LLL185R71E223MA01#
	16Vdc	X7R	47000pF	±20%	LLL185R71C473MA01#
			10Vdc	X7R	0.10μF
	0.22μF	±20%	LLL185R71A224MA01#		
		4Vdc	X7S	0.47μF	±20%

1.25×2.0mm

T max.	Rated Voltage	TC Code	Cap.	Tol.	Part Number
0.5mm	50Vdc	X7R	10000pF	±20%	LLL215R71H103MA11#
			22000pF	±20%	LLL215R71E223MA11#
	16Vdc	X7R	47000pF	±20%	LLL215R71C473MA11#
			0.10μF	±20%	LLL215R71C104MA11#
	10Vdc	X7R	0.22μF	±20%	LLL215R71A224MA11#
	6.3Vdc	X7R	0.47μF	±20%	LLL215R70J474MA11#
	4Vdc	X7S	1.0μF	±20%	LLL215C70G105MA11#
10Vdc			X7R	10000pF	±20%
22000pF	±20%	LLL216R71H223MA01#			
	25Vdc	X7R	47000pF	±20%	LLL216R71E473MA01#
0.10μF			±20%	LLL216R71E104MA01#	
10Vdc	X7R	0.22μF	±20%	LLL216R71A224MA01#	
0.95mm	16Vdc	X7R	0.22μF	±20%	LLL219R71C224MA01#
			10Vdc	X7R	0.47μF
	1.0μF	±20%	LLL219R71A105MA01#		
	4Vdc	X7S	2.2μF	±20%	LLL219C70G225MA01#

1.6×3.2mm

T max.	Rated Voltage	TC Code	Cap.	Tol.	Part Number
0.5mm	50Vdc	X7R	10000pF	±20%	LLL315R71H103MA11#
			22000pF	±20%	LLL315R71H223MA11#
	25Vdc	X7R	47000pF	±20%	LLL315R71E473MA11#
			0.10μF	±20%	LLL315R71E104MA11#
	16Vdc	X7R	0.22μF	±20%	LLL315R71C224MA11#
	10Vdc	X7R	0.47μF	±20%	LLL315R71A474MA11#
0.8mm	50Vdc	X7R	10000pF	±20%	LLL317R71H103MA01#
			22000pF	±20%	LLL317R71H223MA01#
			47000pF	±20%	LLL317R71H473MA01#
	25Vdc	X7R	0.10μF	±20%	LLL317R71E104MA01#
			16Vdc	X7R	0.22μF
	0.47μF	±20%			LLL317R71C474MA01#
	10Vdc	X7R	1.0μF	±20%	LLL317R71A105MA01#
	6.3Vdc	X7R	2.2μF	±20%	LLL317R70J225MA01#
	1.25mm	50Vdc	X7R	0.10μF	±20%
25Vdc				X7R	0.22μF
		0.47μF	±20%		LLL31MR71E474MA01#
16Vdc		X7R	1.0μF	±20%	LLL31MR71C105MA01#
10Vdc		X7R	2.2μF	±20%	LLL31MR71A225MA01#
6.3Vdc		X7R	4.7μF	±20%	LLL31MR70J475MA01#
	X5R		10μF	±20%	LLL31MR60J106ME01#

Part number # indicates the package specification code.

GRM
GR3
GRJ
GR4
GR7
GJM
GQM
GA2
GA3 GB
GA3 GD
GA3 GF
LLL
LLA
LLM
LLR
NFM
KRM
KR3
GMA
GMD
⚠Caution /Notice

LLL Series Specifications and Test Methods

Specifications and Test Methods, please refer to the search web page.
<https://www.murata.com/en-global/products/capacitor>

LLL Series High Dielectric Constant Typ

0.5×1.0mm

T max.	Rated Voltage	TC Code	Cap.	Tol.	Part Number
0.35mm	6.3Vdc	X6S	0.10μF	±20%	LLL153C70G104ME01#
			0.22μF	±20%	LLL153C70J224ME14#
	4Vdc	X7S	0.47μF	±20%	LLL153C70E047ME17#
			1.0μF	±20%	LLL153C70E104ME21#

0.6×1.0mm

T max.	Rated Voltage	TC Code	Cap.	Tol.	Part Number
--------	---------------	---------	------	------	-------------

Links are provided to the product detail pages on the web, and are shown below in the product number table from the PDF version of the catalog which is available on the web.

Detailed Specifications Sheet

- Rated value
- Specifications and Test Methods
- Package
- Caution, Notice

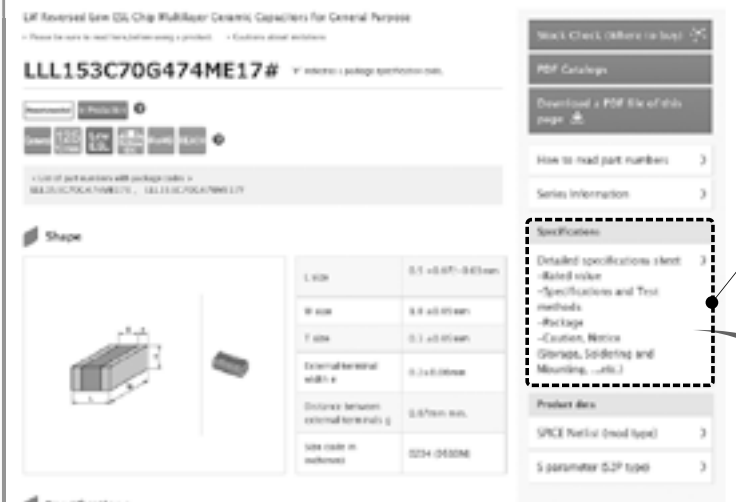

Specifications and Test Methods

No	Item	Specification	Test Method (Ref. Standard: JIS C 5101, IEC60384)												
1	Rated Voltage	Shown in Rated value.	The rated voltage is defined as the maximum voltage which may be applied continuously to the capacitor. When AC voltage is superimposed on DC voltage, V^{AC-P} or V^{AC-N} , whichever is larger, should be maintained within the rated voltage range.												
2	Appearance	No defects or abnormalities.	Visual inspection.												
3	Dimension	Within the specified dimensions.	Using Measuring instrument of dimension.												
4	Voltage proof	No defects or abnormalities.	Measurement Point : Between the terminations Test Voltage : 250% of the rated voltage Applied Time : 1 to 5 s Charge/discharge current : 50mA max.												
5	Insulation Resistance(I.R.)	More than 2000MΩ or 50Ω · F (Whichever is smaller)	Measurement Point : Between the terminations Measurement Voltage : DC Rated Voltage Charging Time : 1 min (LLL153C70E474M only 2 min) Charge/discharge current : 50mA max. Measurement Temperature : Room Temperature												
6	Capacitance	Shown in Rated value.	Measurement Temperature : Room Temperature <table border="1"> <thead> <tr> <th>Capacitance</th> <th>Frequency</th> <th>Voltage</th> </tr> </thead> <tbody> <tr> <td>C ≤ 10μF (10V min.)</td> <td>1.0+/-0.1kHz</td> <td>1.0+/-0.2Vrms</td> </tr> <tr> <td>C ≤ 10μF (6.3V max.)</td> <td>1.0+/-0.1kHz</td> <td>0.5+/-0.1Vrms</td> </tr> <tr> <td>C > 10μF</td> <td>120+/-24Hz</td> <td>0.5+/-0.1Vrms</td> </tr> </tbody> </table>	Capacitance	Frequency	Voltage	C ≤ 10μF (10V min.)	1.0+/-0.1kHz	1.0+/-0.2Vrms	C ≤ 10μF (6.3V max.)	1.0+/-0.1kHz	0.5+/-0.1Vrms	C > 10μF	120+/-24Hz	0.5+/-0.1Vrms
Capacitance	Frequency	Voltage													
C ≤ 10μF (10V min.)	1.0+/-0.1kHz	1.0+/-0.2Vrms													
C ≤ 10μF (6.3V max.)	1.0+/-0.1kHz	0.5+/-0.1Vrms													
C > 10μF	120+/-24Hz	0.5+/-0.1Vrms													
7	Dissipation Factor (D.F.)	0.120 max.													
8	Temperature Characteristics of Capacitance	No bias R6 : Within +/-15% (-55°C to +85°C) C7 : Within +/-22% (-55°C to +125°C) C8 : Within +/-22% (-55°C to +105°C) D7 : Within +/-22/-33% (-55°C to +125°C) D8 : Within +/-22/-33% (-55°C to +105°C)	The capacitance change should be measured after 5 min. at each specified temp. stage. Capacitance value as a reference is the value in step 3. - Measurement Voltage : LLL153 D7 0E/0G 224M only : 0.25+/-0.05Vrms LLL153 C7 0E/0G 104M only : 0.30+/-0.05Vrms LLL152R60G105M , LLL152D80E105M only : 0.10+/-0.03Vrms <table border="1"> <thead> <tr> <th>Step</th> <th>Temperature(°C)</th> <th>Applying Voltage(VDC)</th> </tr> </thead> <tbody> <tr> <td>1</td> <td>Reference Temp. +/2</td> <td rowspan="3">No bias</td> </tr> <tr> <td>2</td> <td>Min. Operating Temp. +/3</td> </tr> <tr> <td>3</td> <td>Reference Temp. +/2</td> </tr> </tbody> </table>	Step	Temperature(°C)	Applying Voltage(VDC)	1	Reference Temp. +/2	No bias	2	Min. Operating Temp. +/3	3	Reference Temp. +/2		
Step	Temperature(°C)	Applying Voltage(VDC)													
1	Reference Temp. +/2	No bias													
2	Min. Operating Temp. +/3														
3	Reference Temp. +/2														

8 Terminals Low ESL Chip Multilayer Ceramic Capacitors for General Purpose

LLA Series



8-Terminal Type Low ESL Capacitor Ideal for Power Supply Decoupling of High-speed Operation IC

Features

① **Ultra-low ESL**

Since the equivalent series inductance (ESL) is very low with excellent high frequency characteristics due to the design structure, this capacitor is ideal for power supply decoupling of high-speed operation IC.

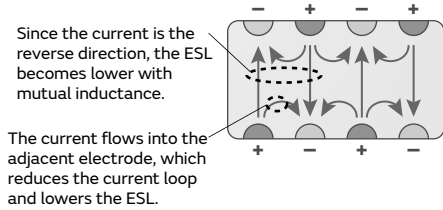
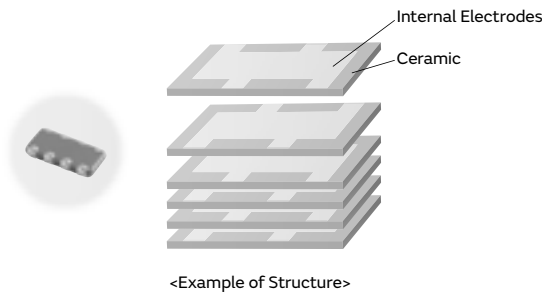

<Effectiveness of Cancelling Out Inductance by Mutual Inductance>

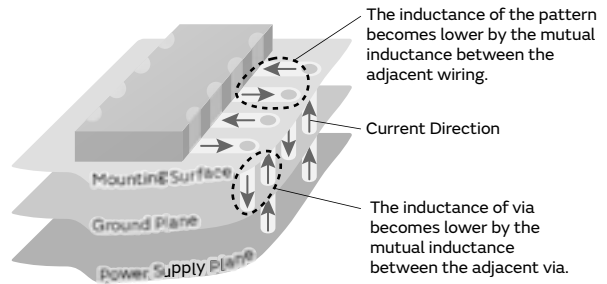

<Effectiveness of Suppressing Inductance when Mounting a Multi-terminal Capacitor>

The inductance for the boards also becomes lower, not only the capacitor.

② **A maximum operating temperature up to 125°C**

This product is applicable to high temperatures (X7* characteristics); however, Murata also offers numerous thin type products, which are ideal as decoupling capacitors on IC package.

Specifications

Size (mm)	1.6×0.8mm to 2.0×1.25mm
Rated Voltage	4Vdc to 25Vdc
Capacitance	10000pF to 4.7μF
Main Applications	Application processor/CPU/GPU

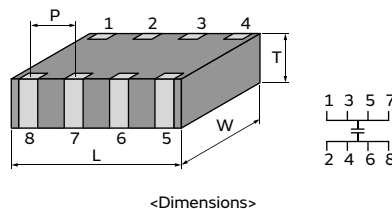

This catalog contains only a portion of the product lineup. Please refer to the capacitor search tool on the Murata Web site for details.

GRM
 GR3
 GRJ
 GR4
 GR7
 GJM
 GQM
 GA2
 GA3 GB
 GA3 GD
 GA3 GF
 LLL
LLA
 LLM
 LLR
 NFM
 KRM
 KR3
 GMA
 GMD
 Caution / Notice

LLA Series High Dielectric Constant Type Part Number List

1.6×0.8mm

T max.	Rated Voltage	TC Code	Cap.	Tol.	Part Number	p*
0.55mm	4Vdc	X7S	0.10μF	±20%	LLA185C70G104MA01#	p224
			0.22μF	±20%	LLA185C70G224MA01#	p224
			0.47μF	±20%	LLA185C70G474MA01#	p224
			2.2μF	±20%	LLA185C70G225ME16#	p226

2.0×1.25mm

T max.	Rated Voltage	TC Code	Cap.	Tol.	Part Number	p*
0.55mm	25Vdc	X7R	10000pF	±20%	LLA215R71E103MA14#	p224
			22000pF	±20%	LLA215R71E223MA14#	p224
	16Vdc	X7R	47000pF	±20%	LLA215R71C473MA14#	p224
			0.10μF	±20%	LLA215R71C104MA14#	p224
	10Vdc	X7R	0.22μF	±20%	LLA215R71A224MA14#	p224
	6.3Vdc	X7R	0.47μF	±20%	LLA215R70J474MA14#	p224
	4Vdc	X7S	1.0μF	±20%	LLA215C70G105MA14#	p224
			4.7μF	±20%	LLA215C70G475ME19#	p226
0.95mm	25Vdc	X7R	10000pF	±20%	LLA219R71E103MA01#	p224
			22000pF	±20%	LLA219R71E223MA01#	p224
			47000pF	±20%	LLA219R71E473MA01#	p224
	16Vdc	X7R	0.10μF	±20%	LLA219R71C104MA01#	p224
			0.22μF	±20%	LLA219R71C224MA01#	p224
	10Vdc	X7R	0.47μF	±20%	LLA219R71A474MA01#	p224
	6.3Vdc	X7R	1.0μF	±20%	LLA219R70J105MA01#	p224
	4Vdc	X7S	2.2μF	±20%	LLA219C70G225MA01#	p224

*: Refers to the page of the "Specifications and Test Methods".

Part number # indicates the package specification code.

1

LLA Series Specifications and Test Methods (1)

No	Item	Specification	Test Method (Ref. Standard: JIS C 5101, IEC60384)														
1	Rated Voltage	Shown in Rated value.	The rated voltage is defined as the maximum voltage which may be applied continuously to the capacitor. When AC voltage is superimposed on DC voltage, V^{P-P} or V^{O-P} , whichever is larger, should be maintained within the rated voltage range.														
2	Appearance	No defects or abnormalities.	Visual inspection.														
3	Dimension	Within the specified dimensions.	Using Measuring instrument of dimension.														
4	Voltage Proof	No defects or abnormalities.	Measurement Point: Between the terminations Test Voltage: 250% of the rated voltage Applied Time: 1 to 5s Charge/discharge current: 50mA max.														
5	Insulation Resistance (I.R.)	$C \leq 0.047\mu\text{F}$: More than 10000MΩ $C > 0.047\mu\text{F}$: More than $500\Omega \cdot \text{F}$ C: Nominal Capacitance	Measurement Point: Between the terminations Measurement Voltage: DC Rated Voltage Charging Time: 2min Charge/discharge current: 50mA max. Measurement Temperature: Room Temperature														
6	Capacitance	Shown in Rated value.	Measurement Temperature: Room Temperature														
7	Dissipation Factor (D.F.)	W.V.:25Vdc min.: 0.025max. W.V.:16/10Vdc: 0.035max. W.V.:6.3Vdc max.: 0.05max.	<table border="1"> <thead> <tr> <th>Capacitance</th> <th>Frequency</th> <th>Voltage</th> </tr> </thead> <tbody> <tr> <td>$C \leq 10\mu\text{F}$</td> <td>1.0±0.1kHz</td> <td>1.0±0.2Vrms *</td> </tr> </tbody> </table>	Capacitance	Frequency	Voltage	$C \leq 10\mu\text{F}$	1.0±0.1kHz	1.0±0.2Vrms *								
			Capacitance	Frequency	Voltage												
$C \leq 10\mu\text{F}$	1.0±0.1kHz	1.0±0.2Vrms *															
* For item LLA185 C7 0G 274 to 474, the capacitance should be measured using a voltage of 0.5±0.1Vrms. For item LLA185/215 C7 0G 473, the capacitance should be measured using a voltage of 0.5±0.2Vrms.																	
8	Temperature Characteristics of Capacitance	No Bias R7: Within ±15% (-55 to +125°C) R6: Within ±15% (-55 to +85°C) C7: Within ±22% (-55 to +125°C)	The capacitance change should be measured after 5 minutes at each specified temp. stage. Capacitance value as a reference is the value in step 3.														
			<table border="1"> <thead> <tr> <th>Step</th> <th>Temperature (°C)</th> <th>Applying Voltage(VDC)</th> </tr> </thead> <tbody> <tr> <td>1</td> <td>Reference Temp. ±2</td> <td rowspan="5">No bias</td> </tr> <tr> <td>2</td> <td>Min. Operating Temp. ±3</td> </tr> <tr> <td>3</td> <td>Reference Temp. ±2</td> </tr> <tr> <td>4</td> <td>Max. Operating Temp. ±3</td> </tr> <tr> <td>5</td> <td>Reference Temp. ±2</td> </tr> </tbody> </table>	Step	Temperature (°C)	Applying Voltage(VDC)	1	Reference Temp. ±2	No bias	2	Min. Operating Temp. ±3	3	Reference Temp. ±2	4	Max. Operating Temp. ±3	5	Reference Temp. ±2
Step	Temperature (°C)	Applying Voltage(VDC)															
1	Reference Temp. ±2	No bias															
2	Min. Operating Temp. ±3																
3	Reference Temp. ±2																
4	Max. Operating Temp. ±3																
5	Reference Temp. ±2																
• Initial measurement Perform a heat treatment at 150+0/-10°C for 1h and then let sit for 24±2h at room temperature, then measure.																	
9	Adhesive Strength of Termination	No removal of the terminations or other defect should occur.	Solder the capacitor on the test substrate (glass epoxy board). Applied Force: 5N Holding Time: 10±1s Applied Direction: In parallel with the test substrate and vertical with the capacitor side.														
10	Vibration	Appearance	No defects or abnormalities.														
		Capacitance	Within the specified initial value.														
		D.F.	Within the specified initial value.														
Solder the capacitor on the test substrate (glass epoxy board). Kind of Vibration: A simple harmonic motion 10Hz to 55Hz to 10Hz (1min) Total amplitude: 1.5mm This motion should be applied for a period of 2h in each 3 mutually perpendicular directions (total of 6h).																	
11	Solderability	75% of the terminations is to be soldered evenly and continuously.	Test Method: Solder bath method Flux: Solution of rosin ethanol 25 (mass)% Preheat: 80 to 120°C for 10 to 30s Solder: Sn-3.0Ag-0.5Cu Solder Temp.: 245±5°C Immersion time: 2±0.5s														
12	Temperature Sudden Change	Appearance	No defects or abnormalities.														
		Capacitance Change	Within ±7.5%														
		D.F.	Within the specified initial value.														
		I.R.	Within the specified initial value.														
		Voltage Proof	No defects.														
Solder the capacitor on the test substrate (glass epoxy board). Perform the 5 cycles according to the four heat treatments shown in the following table.																	
<table border="1"> <thead> <tr> <th>Step</th> <th>Temp. (°C)</th> <th>Time (min)</th> </tr> </thead> <tbody> <tr> <td>1</td> <td>Min. Operating Temp. +0/-3</td> <td>30±3</td> </tr> <tr> <td>2</td> <td>Room Temp.</td> <td>2 to 3</td> </tr> <tr> <td>3</td> <td>Max. Operating Temp. +3/-0</td> <td>30±3</td> </tr> <tr> <td>4</td> <td>Room Temp.</td> <td>2 to 3</td> </tr> </tbody> </table>			Step	Temp. (°C)	Time (min)	1	Min. Operating Temp. +0/-3	30±3	2	Room Temp.	2 to 3	3	Max. Operating Temp. +3/-0	30±3	4	Room Temp.	2 to 3
Step	Temp. (°C)	Time (min)															
1	Min. Operating Temp. +0/-3	30±3															
2	Room Temp.	2 to 3															
3	Max. Operating Temp. +3/-0	30±3															
4	Room Temp.	2 to 3															
Exposure Time: 24±2h • Initial measurement Perform a heat treatment at 150+0/-10°C for 1h and then let sit for 24±2h at room temperature, then measure.																	

Continued on the following page. ↗

GRM
 GR3
 GRJ
 GR4
 GR7
 GJM
 GQM
 GA2
 GA3 GB
 GA3 GD
 GA3 GF
 LLL
 LLA
 LLM
 LLR
 NFM
 KRM
 KR3
 GMA
 GMD
 ⚠Caution /Notice

LLA Series Specifications and Test Methods (1)

Continued from the preceding page. ↘

No	Item	Specification	Test Method (Ref. Standard: JIS C 5101, IEC60384)
13	High Temperature High Humidity (Steady)	Appearance	No defects or abnormalities.
		Capacitance Change	Within $\pm 12.5\%$
		D.F.	W.V.: 10Vdc min.: 0.05max. W.V.: 6.3Vdc max.: 0.075max.
		I.R.	More than 500M Ω or 25 Ω • F (Whichever is smaller)
14	Durability	Appearance	No defects or abnormalities.
		Capacitance Change	Within $\pm 12.5\%$
		D.F.	W.V.:10Vdc min.: 0.05max. W.V.:6.3Vdc max.: 0.075max.
		I.R.	More than 1000M Ω or 50 Ω • F (Whichever is smaller)
			Solder the capacitor on the test substrate (glass epoxy board). Test Temperature: 40 $\pm 2^{\circ}\text{C}$ Test Humidity: 90 to 95%RH Test Time: 500 ± 12 h Applied Voltage: DC Rated Voltage Charge/discharge current: 50mA max. Exposure Time: 24 ± 2 h
			Solder the capacitor on the test substrate (glass epoxy board). Test Temperature: Max. Operating Temp. $\pm 3^{\circ}\text{C}$ Test Time: 1000 ± 12 h Applied Voltage: 200% of the rated voltage Charge/discharge current: 50mA max. Exposure Time: 24 ± 2 h • Initial measurement Apply 200% of the rated DC voltage at the max. operating temp. $\pm 3^{\circ}\text{C}$ for 1h. Remove and set for 24 ± 2 h at room temperature. Perform initial measurement.

GRM

GR3

GRJ

GR4

GR7

GJM

GQM

GA2

GA3
GB

GA3
GD

GA3
GF

LLL

LLA

LLM

LLR

NFM

KPM

KR3

GMA

GMD

⚠Caution
/Notice

225

2

LLA Series Specifications and Test Methods (2)

No	Item	Specification	Test Method (Ref. Standard: JIS C 5101, IEC60384)															
1	Rated Voltage	Shown in Rated value.	The rated voltage is defined as the maximum voltage which may be applied continuously to the capacitor. When AC voltage is superimposed on DC voltage, V^{P-P} or V^{O-P} , whichever is larger, should be maintained within the rated voltage range.															
2	Appearance	No defects or abnormalities.	Visual inspection.															
3	Dimension	Within the specified dimensions.	Using Measuring instrument of dimension.															
4	Voltage Proof	No defects or abnormalities.	Measurement Point: Between the terminations Test Voltage: 250% of the rated voltage Applied Time: 1 to 5s Charge/discharge current: 50mA max.															
5	Insulation Resistance (I.R.)	More than 2000MΩ or 50Ω • F (Whichever is smaller)	Measurement Point: Between the terminations Measurement Voltage: DC Rated Voltage Charging Time: 1min Charge/discharge current: 50mA max. Measurement Temperature: Room Temperature															
6	Capacitance	Shown in Rated value.	Measurement Temperature: Room Temperature															
7	Dissipation Factor (D.F.)	0.120max.	<table border="1"> <thead> <tr> <th>Capacitance</th> <th>Frequency</th> <th>Voltage</th> </tr> </thead> <tbody> <tr> <td>$C \leq 10\mu\text{F}$ (10V min.)</td> <td>1.0±0.1kHz</td> <td>1.0±0.2Vrms</td> </tr> <tr> <td>$C \leq 10\mu\text{F}$ (6.3V max.)</td> <td>1.0±0.1kHz</td> <td>0.5±0.1Vrms</td> </tr> <tr> <td>$C > 10\mu\text{F}$</td> <td>120±24Hz</td> <td>0.5±0.1Vrms</td> </tr> </tbody> </table>	Capacitance	Frequency	Voltage	$C \leq 10\mu\text{F}$ (10V min.)	1.0±0.1kHz	1.0±0.2Vrms	$C \leq 10\mu\text{F}$ (6.3V max.)	1.0±0.1kHz	0.5±0.1Vrms	$C > 10\mu\text{F}$	120±24Hz	0.5±0.1Vrms			
			Capacitance	Frequency	Voltage													
			$C \leq 10\mu\text{F}$ (10V min.)	1.0±0.1kHz	1.0±0.2Vrms													
$C \leq 10\mu\text{F}$ (6.3V max.)	1.0±0.1kHz	0.5±0.1Vrms																
$C > 10\mu\text{F}$	120±24Hz	0.5±0.1Vrms																
8	Temperature Characteristics of Capacitance	No Bias	C7: Within ±22% (-55 to +125°C)															
				<table border="1"> <thead> <tr> <th>Step</th> <th>Temperature (°C)</th> <th>Applying Voltage(VDC)</th> </tr> </thead> <tbody> <tr> <td>1</td> <td>Reference Temp. ±2</td> <td rowspan="5">No bias</td> </tr> <tr> <td>2</td> <td>Min. Operating Temp. ±3</td> </tr> <tr> <td>3</td> <td>Reference Temp. ±2</td> </tr> <tr> <td>4</td> <td>Max. Operating Temp. ±3</td> </tr> <tr> <td>5</td> <td>Reference Temp. ±2</td> </tr> </tbody> </table>	Step	Temperature (°C)	Applying Voltage(VDC)	1	Reference Temp. ±2	No bias	2	Min. Operating Temp. ±3	3	Reference Temp. ±2	4	Max. Operating Temp. ±3	5	Reference Temp. ±2
Step	Temperature (°C)	Applying Voltage(VDC)																
1	Reference Temp. ±2	No bias																
2	Min. Operating Temp. ±3																	
3	Reference Temp. ±2																	
4	Max. Operating Temp. ±3																	
5	Reference Temp. ±2																	
9	Adhesive Strength of Termination	No removal of the terminations or other defect should occur.	The capacitance change should be measured after 5 minutes at each specified temp. stage. Capacitance value as a reference is the value in step 3. • Initial measurement Perform a heat treatment at 150+0/-10°C for 1h and then let sit for 24±2h at room temperature, then measure.															
10	Vibration	Appearance	No defects or abnormalities.															
		Capacitance	Within the specified initial value.															
		D.F.	Within the specified initial value.															
11	Solderability	75% of the terminations is to be soldered evenly and continuously.	Solder the capacitor on the test substrate (glass epoxy board). Applied Force: 5N Holding Time: 10±1s Applied Direction: In parallel with the test substrate and vertical with the capacitor side. Test Method: Solder bath method Flux: Solution of rosin ethanol 25 (mass)% Preheat: 80 to 120°C for 10 to 30s Solder: Sn-3.0Ag-0.5Cu Solder Temp.: 245±5°C Immersion time: 2±0.5s															
12	Temperature Sudden Change	Appearance	No defects or abnormalities.															
		Capacitance Change	Within ±12.5%															
		D.F.	Within the specified initial value.															
		I.R.	Within the specified initial value.															
		Voltage Proof	No defects.															
			<table border="1"> <thead> <tr> <th>Step</th> <th>Temp. (°C)</th> <th>Time (min)</th> </tr> </thead> <tbody> <tr> <td>1</td> <td>Min. Operating Temp. +0/-3</td> <td>30±3</td> </tr> <tr> <td>2</td> <td>Room Temp.</td> <td>2 to 3</td> </tr> <tr> <td>3</td> <td>Max. Operating Temp. +3/-0</td> <td>30±3</td> </tr> <tr> <td>4</td> <td>Room Temp.</td> <td>2 to 3</td> </tr> </tbody> </table> EExposure Time: 24±2h • Initial measurement Perform a heat treatment at 150+0/-10°C for 1h and then let sit for 24±2h at room temperature, then measure.	Step	Temp. (°C)	Time (min)	1	Min. Operating Temp. +0/-3	30±3	2	Room Temp.	2 to 3	3	Max. Operating Temp. +3/-0	30±3	4	Room Temp.	2 to 3
Step	Temp. (°C)	Time (min)																
1	Min. Operating Temp. +0/-3	30±3																
2	Room Temp.	2 to 3																
3	Max. Operating Temp. +3/-0	30±3																
4	Room Temp.	2 to 3																

Continued on the following page. ↗

GRM
 GR3
 GRJ
 GR4
 GR7
 GJM
 GQM
 GA2
 GA3 GB
 GA3 GD
 GA3 GF
 LLL
 LLA
 LLM
 LLR
 NFM
 KRM
 KR3
 GMA
 GMD
 ⚠Caution /Notice

LLA Series Specifications and Test Methods (2)

Continued from the preceding page. ↘

No	Item	Specification	Test Method (Ref. Standard: JIS C 5101, IEC60384)
13	High Temperature High Humidity (Steady)	Appearance	No defects or abnormalities.
	Capacitance Change	Within $\pm 12.5\%$	Solder the capacitor on the test substrate (glass epoxy board). Test Temperature: $40\pm 2^\circ\text{C}$ Test Humidity: 90 to 95%RH Test Time: $500\pm 12\text{h}$
	D.F.	0.2 max.	Applied Voltage: DC Rated Voltage Charge/discharge current: 50mA max.
	I.R.	More than $500\text{M}\Omega$ or $12.5\Omega \cdot \text{F}$ (Whichever is smaller)	• Initial measurement Perform a heat treatment at $150+0/-10^\circ\text{C}$ for 1h and then let sit for $24\pm 2\text{h}$ at room temperature, then measure. • Measurement after test Perform a heat treatment at $150+0/-10^\circ\text{C}$ for 1h and then let sit for $24\pm 2\text{h}$ at room temperature, then measure.
14	Durability	Appearance	No defects or abnormalities.
		Capacitance Change	Within $\pm 12.5\%$
		D.F.	0.2 max.
		I.R.	More than $1000\text{M}\Omega$ or $25\Omega \cdot \text{F}$ (Whichever is smaller)
			Solder the capacitor on the test substrate (glass epoxy board). Test Temperature: Max. Operating Temp. $\pm 3^\circ\text{C}$ Test Time: $1000\pm 12\text{h}$ Applied Voltage: 150% of the rated voltage Charge/discharge current: 50mA max. • Initial measurement Perform a heat treatment at $150+0/-10^\circ\text{C}$ for 1h and then let sit for $24\pm 2\text{h}$ at room temperature, then measure. • Measurement after test Perform a heat treatment at $150+0/-10^\circ\text{C}$ for 1h and then let sit for $24\pm 2\text{h}$ at room temperature, then measure.

GRM

GR3

GRJ

GR4

GR7

GJM

GQM

GA2

GA3 GB

GA3 GD

GA3 GF

LLL

LLA

LLM

LLR

NFM

KPM

KR3

GMA

GMD

⚠Caution /Notice

227

10 Terminals Low ESL Chip Multilayer Ceramic Capacitors for General Purpose

LLM Series  **Low ESL** 

10-Terminal Type Low ESL Capacitor Ideal for Power Supply Decoupling of High-speed Operation IC

Features

① This is the lowest ESL LW reversed type capacitor.

Since the equivalent series inductance (ESL) of this product is even lower than the LLA series (8-terminal product) with excellent high frequency characteristics, this capacitor is ideal for power supply decoupling of high-speed operation IC.

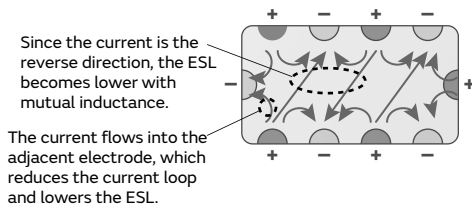
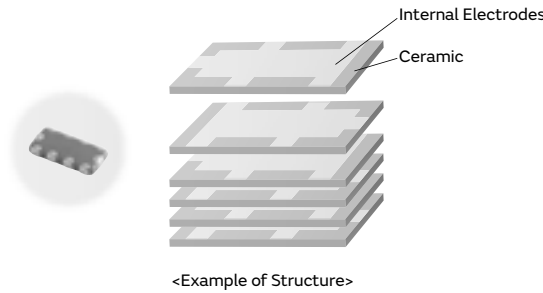

<Effectiveness of Cancelling Out Inductance by Mutual Inductance>

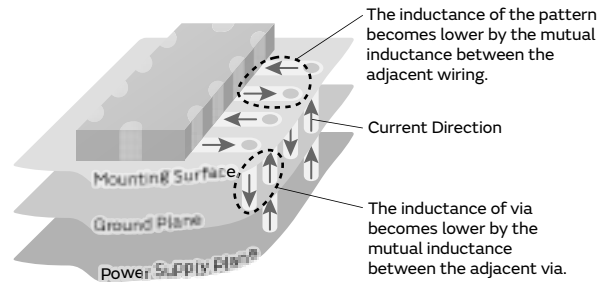

<Effectiveness of Suppressing Inductance when Mounting a Multi-terminal Capacitor>

The inductance for the boards also becomes lower, not only the capacitor.

② A maximum operating temperature up to 125°C

This product is applicable to high temperatures (X7* characteristics); however, Murata also offers numerous thin type products, which are ideal as decoupling capacitors on IC package.

Specifications

Size (mm)	2.0×1.25mm
Rated Voltage	4Vdc to 25Vdc
Capacitance	0.22μF to 1.0μF
Main Applications	Application processor/CPU/GPU

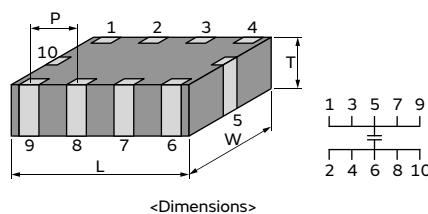

This catalog contains only a portion of the product lineup. Please refer to the capacitor search tool on the Murata Web site for details.

GRM
 GR3
 GRJ
 GR4
 GR7
 GJM
 GQM
 GA2
 GA3 GB
 GA3 GD
 GA3 GF
 LLL
 LLA
 LLM
 LLR
 NFM
 KRM
 KR3
 GMA
 GMD
 ⚠Caution /Notice

LLM Series High Dielectric Constant Type Part Number List

2.0×1.25mm

T max.	Rated Voltage	TC Code	Cap.	Tol.	Part Number	p*
0.55mm	6.3Vdc	X7R	0.22μF	±20%	LLM215R70J224MA11#	p230
			0.47μF	±20%	LLM215R70J474MA11#	p230
	4Vdc	X7S	1.0μF	±20%	LLM215C70G105MA11#	p230

GRM

GR3

GRJ

GR4

GR7

GJM

GQM

GA2

GA3
GB

GA3
GD

GA3
GF

LLL

LLA

LLM

LLR

NFM

KRM

KR3

GMA

GMD

⚠Caution / Notice

*: Refers to the page of the "Specifications and Test Methods".

Part number # indicates the package specification code.

1

LLM Series Specifications and Test Methods (1)

No	Item	Specification	Test Method (Ref. Standard: JIS C 5101, IEC60384)															
1	Rated Voltage	Shown in Rated value.	The rated voltage is defined as the maximum voltage which may be applied continuously to the capacitor. When AC voltage is superimposed on DC voltage, V^P -P or V^O -P, whichever is larger, should be maintained within the rated voltage range.															
2	Appearance	No defects or abnormalities.	Visual inspection.															
3	Dimension	Within the specified dimensions.	Using Measuring instrument of dimension.															
4	Voltage Proof	No defects or abnormalities.	Measurement Point: Between the terminations Test Voltage: 250% of the rated voltage Applied Time: 1 to 5s Charge/discharge current: 50mA max.															
5	Insulation Resistance (I.R.)	$C \leq 0.047\mu\text{F}$: More than 10000MΩ $C > 0.047\mu\text{F}$: More than $500\Omega \cdot \text{F}$ C: Nominal Capacitance	Measurement Point: Between the terminations Measurement Voltage: DC Rated Voltage Charging Time: 2min Charge/discharge current: 50mA max. Measurement Temperature: Room Temperature															
6	Capacitance	Shown in Rated value.	Measurement Temperature: Room Temperature															
7	Dissipation Factor (D.F.)	W.V.:25Vdc min.: 0.025max. W.V.:16/10Vdc: 0.035max. W.V.:6.3Vdc max.: 0.05max.	<table border="1"> <thead> <tr> <th>Capacitance</th> <th>Frequency</th> <th>Voltage</th> </tr> </thead> <tbody> <tr> <td>$C \leq 10\mu\text{F}$</td> <td>1.0±0.1kHz</td> <td>1.0±0.2Vrms *</td> </tr> </tbody> </table> <p>* For item LLA185 C7 0G 274 to 474, the capacitance should be measured using a voltage of 0.5±0.1Vrms. For item LLA185/215 C7 0G 473, the capacitance should be measured using a voltage of 0.5±0.2Vrms.</p>	Capacitance	Frequency	Voltage	$C \leq 10\mu\text{F}$	1.0±0.1kHz	1.0±0.2Vrms *									
			Capacitance	Frequency	Voltage													
$C \leq 10\mu\text{F}$	1.0±0.1kHz	1.0±0.2Vrms *																
<table border="1"> <thead> <tr> <th>Step</th> <th>Temperature (°C)</th> <th>Applying Voltage(VDC)</th> </tr> </thead> <tbody> <tr> <td>1</td> <td>Reference Temp. ±2</td> <td rowspan="5">No bias</td> </tr> <tr> <td>2</td> <td>Min. Operating Temp. ±3</td> </tr> <tr> <td>3</td> <td>Reference Temp. ±2</td> </tr> <tr> <td>4</td> <td>Max. Operating Temp. ±3</td> </tr> <tr> <td>5</td> <td>Reference Temp. ±2</td> </tr> </tbody> </table> <p>• Initial measurement Perform a heat treatment at 150+0/-10°C for 1h and then let sit for 24±2h at room temperature, then measure.</p>	Step	Temperature (°C)	Applying Voltage(VDC)	1	Reference Temp. ±2	No bias	2	Min. Operating Temp. ±3	3	Reference Temp. ±2	4	Max. Operating Temp. ±3	5	Reference Temp. ±2				
Step	Temperature (°C)	Applying Voltage(VDC)																
1	Reference Temp. ±2	No bias																
2	Min. Operating Temp. ±3																	
3	Reference Temp. ±2																	
4	Max. Operating Temp. ±3																	
5	Reference Temp. ±2																	
8	Temperature Characteristics of Capacitance No Bias	R7: Within ±15% (-55 to +125°C) R6: Within ±15% (-55 to +85°C) C7: Within ±22% (-55 to +125°C)	The capacitance change should be measured after 5 minutes at each specified temp. stage. Capacitance value as a reference is the value in step 3.															
9	Adhesive Strength of Termination	No removal of the terminations or other defect should occur.	Solder the capacitor on the test substrate (glass epoxy board). Applied Force: 5N Holding Time: 10±1s Applied Direction: In parallel with the test substrate and vertical with the capacitor side.															
10	Vibration	Appearance	No defects or abnormalities.															
		Capacitance	Within the specified initial value.															
		D.F.	Within the specified initial value.															
11	Solderability	75% of the terminations is to be soldered evenly and continuously.	Test Method: Solder bath method Flux: Solution of rosin ethanol 25 (mass)% Preheat: 80 to 120°C for 10 to 30s Solder: Sn-3.0Ag-0.5Cu Solder Temp.: 245±5°C Immersion time: 2±0.5s															
12	Temperature Sudden Change	Appearance	No defects or abnormalities.															
		Capacitance Change	Within ±7.5%															
		D.F.	Within the specified initial value.															
		I.R.	Within the specified initial value.															
		Voltage Proof	No defects.															
			<table border="1"> <thead> <tr> <th>Step</th> <th>Temp. (°C)</th> <th>Time (min)</th> </tr> </thead> <tbody> <tr> <td>1</td> <td>Min. Operating Temp. +0/-3</td> <td>30±3</td> </tr> <tr> <td>2</td> <td>Room Temp.</td> <td>2 to 3</td> </tr> <tr> <td>3</td> <td>Max. Operating Temp. +3/-0</td> <td>30±3</td> </tr> <tr> <td>4</td> <td>Room Temp.</td> <td>2 to 3</td> </tr> </tbody> </table> <p>Exposure Time: 24±2h • Initial measurement Perform a heat treatment at 150+0/-10°C for 1h and then let sit for 24±2h at room temperature, then measure.</p>	Step	Temp. (°C)	Time (min)	1	Min. Operating Temp. +0/-3	30±3	2	Room Temp.	2 to 3	3	Max. Operating Temp. +3/-0	30±3	4	Room Temp.	2 to 3
Step	Temp. (°C)	Time (min)																
1	Min. Operating Temp. +0/-3	30±3																
2	Room Temp.	2 to 3																
3	Max. Operating Temp. +3/-0	30±3																
4	Room Temp.	2 to 3																

Continued on the following page. ↗

GRM
GR3
GRJ
GR4
GR7
GJM
GQM
GA2
GA3 GB
GA3 GD
GA3 GF
LLL
LLA
LLM
LLR
NFM
KRM
KR3
GMA
GMD
Caution /Notice

LLM Series Specifications and Test Methods (1)

Continued from the preceding page. ↘

No	Item	Specification	Test Method (Ref. Standard: JIS C 5101, IEC60384)
13	High Temperature High Humidity (Steady)	Appearance	No defects or abnormalities.
		Capacitance Change	Within $\pm 12.5\%$
		D.F.	W.V.: 10Vdc min.: 0.05max. W.V.: 6.3Vdc max.: 0.075max.
		I.R.	More than 500M Ω or 25 Ω • F (Whichever is smaller)
14	Durability	Appearance	No defects or abnormalities.
		Capacitance Change	Within $\pm 12.5\%$
		D.F.	W.V.:10Vdc min.: 0.05max. W.V.:6.3Vdc max.: 0.075max.
		I.R.	More than 1000M Ω or 50 Ω • F (Whichever is smaller)
			Solder the capacitor on the test substrate (glass epoxy board). Test Temperature: 40 $\pm 2^{\circ}\text{C}$ Test Humidity: 90 to 95%RH Test Time: 500 ± 12 h Applied Voltage: DC Rated Voltage Charge/discharge current: 50mA max. Exposure Time: 24 ± 2 h
			Solder the capacitor on the test substrate (glass epoxy board). Test Temperature: Max. Operating Temp. $\pm 3^{\circ}\text{C}$ Test Time: 1000 ± 12 h Applied Voltage: 200% of the rated voltage Charge/discharge current: 50mA max. Exposure Time: 24 ± 2 h • Initial measurement Apply 200% of the rated DC voltage at the max. operating temp. $\pm 3^{\circ}\text{C}$ for 1h. Remove and set for 24 ± 2 h at room temperature. Perform initial measurement.

GRM

GR3

GRJ

GR4

GR7

GJM

GQM

GA2

GA3
GB

GA3
GD

GA3
GF

LLL

LLA

LLM

LLR

NFM

KPM

KR3

GMA

GMD

⚠Caution
/Notice

LW Reversed Controlled ESR Low ESL Chip Multilayer Ceramic Capacitors for General Purpose

LLR Series



ESR Controlled Type Low ESL Capacitors Equipped with Anti-resonance Control Function

Features

① Reduces Anti-resonance

This capacitor is controlled so that the equivalent series resistance (ESR) becomes slightly higher, and is effective in reducing the anti-resonance that occurs when capacitor arrays are used.

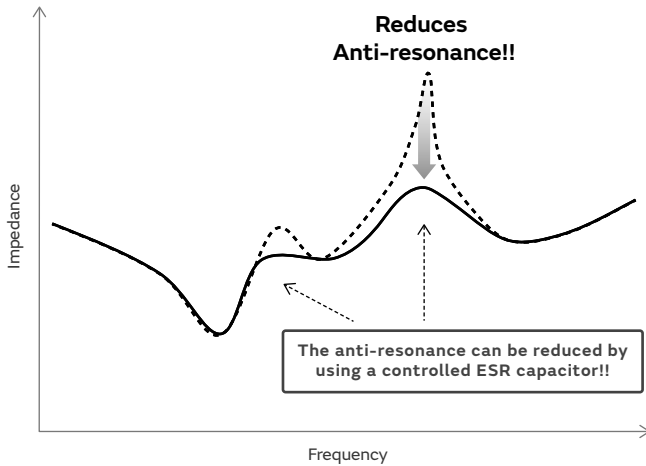

② Lineup of capacitors with ESR values from 100-1,000mΩ.

According to the conditions of the anti-resonance, the most suitable ESR value can be selected from 4 types.

③ Low ESL

This ESR controlled type capacitor has excellent high frequency characteristics, with low equivalent series inductance (ESL). This is also ideal as a decoupling component.

Specifications

Size (mm)	0.8×1.6mm
Rated Voltage	4Vdc
Capacitance	1.0μF
Main Applications	Network processor/ASIC/PMIC

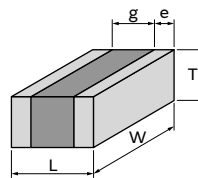

<Dimensions>

This catalog contains only a portion of the product lineup.
 Please refer to the capacitor search tool on the Murata Web site for details.

GRM
 GR3
 GRJ
 GR4
 GR7
 GJM
 GQM
 GA2
 GA3 GB
 GA3 GD
 GA3 GF
 LLL
 LLA
 LLM
LLR
 NFM
 KRM
 KR3
 GMA
 GMD
 ⚠️Caution /Notice

LLR Series High Dielectric Constant Type Part Number List

0.8×1.6mm

T max.	Rated Voltage	TC Code	Cap.	Tol.	Part Number	p*
0.55mm	4Vdc	X7S	1.0μF	±20%	LLR185C70G105ME01#	p234
				±20%	LLR185C70G105ME03#	p234
				±20%	LLR185C70G105ME05#	p234
				±20%	LLR185C70G105ME07#	p234

- GRM
- GR3
- GRJ
- GR4
- GR7
- GJM
- GQM
- GA2
- GA3 GB
- GA3 GD
- GA3 GF
- LLL
- LLA
- LLM
- LLR**
- NFM
- KRM
- KR3
- GMA
- GMD
- ⚠Caution /Notice

*: Refers to the page of the "Specifications and Test Methods".

Part number # indicates the package specification code.

1

LLR Series Specifications and Test Methods (1)

No	Item	Specification	Test Method (Ref. Standard: JIS C 5101, IEC60384)														
1	Rated Voltage	Shown in Rated value.	The rated voltage is defined as the maximum voltage which may be applied continuously to the capacitor. When AC voltage is superimposed on DC voltage, V^{P-P} or V^{O-P} , whichever is larger, should be maintained within the rated voltage range.														
2	Appearance	No defects or abnormalities.	Visual inspection.														
3	Dimension	Within the specified dimensions.	Using Measuring instrument of dimension.														
4	Voltage Proof	No defects or abnormalities.	Measurement Point: Between the terminations Test Voltage: 250% of the rated voltage Applied Time: 1 to 5s Charge/discharge current: 50mA max.														
5	Insulation Resistance (I.R.)	More than 2000MΩ or 50Ω · F (Whichever is smaller)	Measurement Point: Between the terminations Measurement Voltage: DC Rated Voltage Charging Time: 1min Charge/discharge current: 50mA max. Measurement Temperature: Room Temperature														
6	Capacitance	Shown in Rated value.	Measurement Temperature: Room Temperature														
7	Dissipation Factor (D.F.)	0.120 max.	<table border="1"> <thead> <tr> <th>Capacitance</th> <th>Frequency</th> <th>Voltage</th> </tr> </thead> <tbody> <tr> <td>$C \leq 10\mu\text{F}$ (10V min.)</td> <td>1.0±0.1kHz</td> <td>1.0±0.2Vrms</td> </tr> <tr> <td>$C \leq 10\mu\text{F}$ (6.3V max.)</td> <td>1.0±0.1kHz</td> <td>0.5±0.1Vrms</td> </tr> </tbody> </table>	Capacitance	Frequency	Voltage	$C \leq 10\mu\text{F}$ (10V min.)	1.0±0.1kHz	1.0±0.2Vrms	$C \leq 10\mu\text{F}$ (6.3V max.)	1.0±0.1kHz	0.5±0.1Vrms					
			Capacitance	Frequency	Voltage												
$C \leq 10\mu\text{F}$ (10V min.)	1.0±0.1kHz	1.0±0.2Vrms															
$C \leq 10\mu\text{F}$ (6.3V max.)	1.0±0.1kHz	0.5±0.1Vrms															
8	Temperature Characteristics of Capacitance	No Bias C7: Within ±22% (-55 to +125°C)	<p>The capacitance change should be measured after 5 minutes at each specified temp. stage. Capacitance value as a reference is the value in step 3.</p> <table border="1"> <thead> <tr> <th>Step</th> <th>Temperature (°C)</th> <th>Applying Voltage(VDC)</th> </tr> </thead> <tbody> <tr> <td>1</td> <td>Reference Temp. ±2</td> <td rowspan="5">No bias</td> </tr> <tr> <td>2</td> <td>Min. Operating Temp. ±3</td> </tr> <tr> <td>3</td> <td>Reference Temp. ±2</td> </tr> <tr> <td>4</td> <td>Max. Operating Temp. ±3</td> </tr> <tr> <td>5</td> <td>Reference Temp. ±2</td> </tr> </tbody> </table> <p>• Initial measurement Perform a heat treatment at 150+0/-10°C for 1h and then let sit for 24±2h at room temperature, then measure.</p>	Step	Temperature (°C)	Applying Voltage(VDC)	1	Reference Temp. ±2	No bias	2	Min. Operating Temp. ±3	3	Reference Temp. ±2	4	Max. Operating Temp. ±3	5	Reference Temp. ±2
			Step	Temperature (°C)	Applying Voltage(VDC)												
1	Reference Temp. ±2	No bias															
2	Min. Operating Temp. ±3																
3	Reference Temp. ±2																
4	Max. Operating Temp. ±3																
5	Reference Temp. ±2																
9	Adhesive Strength of Termination	No removal of the terminations or other defect should occur.	<p>Solder the capacitor on the test substrate (glass epoxy board). Applied Force: 5N Holding Time: 10±1s Applied Direction: In parallel with the test substrate and vertical with the capacitor side.</p> <table border="1"> <thead> <tr> <th rowspan="2">Part Number</th> <th colspan="3">Dimension (mm)</th> </tr> <tr> <th>a</th> <th>b</th> <th>c</th> </tr> </thead> <tbody> <tr> <td>LLR18</td> <td>0.3</td> <td>1.2</td> <td>2.0</td> </tr> </tbody> </table>	Part Number	Dimension (mm)			a	b	c	LLR18	0.3	1.2	2.0			
		Part Number			Dimension (mm)												
a	b		c														
LLR18	0.3	1.2	2.0														
		<p>Land Dimensions</p> <p>Fig.1</p>															
10	Vibration	Appearance	<p>Solder the capacitor on the test substrate (glass epoxy board). (Refer to No.9) Kind of Vibration: A simple harmonic motion 10Hz to 55Hz to 10Hz (1min) Total amplitude: 1.5mm This motion should be applied for a period of 2h in each 3 mutually perpendicular directions (total of 6h).</p>														
		Capacitance															
		D.F.															
11	Solderability	75% of the terminations is to be soldered evenly and continuously.	<p>Test Method: Solder bath method Flux: Solution of rosin ethanol 25 (mass)% Preheat: 80 to 120°C for 10 to 30s Solder: Sn-3.0Ag-0.5Cu Solder Temp.: 245±5°C Immersion time: 2±0.5s</p>														
12	Resistance to Soldering Heat	Appearance	<p>Test Method: Solder bath Method Solder: Sn-3.0Ag-0.5Cu Solder Temp.: 270±5°C Immersion time: 10±0.5s Exposure Time: 24±2h Preheat: 120 to 150°C for 1min • Initial measurement Perform a heat treatment at 150+0/-10°C for 1h and then let sit for 24±2h at room temperature, then measure.</p>														
		Capacitance Change															
		D.F.															
		I.R.															
		Voltage Proof															

Continued on the following page. ↗

GRM
GR3
GRJ
GR4
GR7
GJM
GQM
GA2
GA3
GB
GA3
GD
GA3
GF
LLL
LLA
LLM
LLR
NFM
KRM
KR3
GMA
GMD
⚠Caution /Notice

LLR Series Specifications and Test Methods (1)

Continued from the preceding page. ↘

No	Item	Specification	Test Method (Ref. Standard: JIS C 5101, IEC60384)														
13	Temperature Sudden Change	Appearance	No defects or abnormalities.														
		Capacitance Change	Within $\pm 12.5\%$														
		D.F.	Within the specified initial value.														
		I.R.	Within the specified initial value.														
		Voltage Proof	No defects.														
14	High Temperature High Humidity (Steady)	Appearance	No defects or abnormalities.														
		Capacitance Change	Within $\pm 12.5\%$														
		D.F.	0.2 max.														
		I.R.	More than 500M Ω or 12.5 Ω · F (Whichever is smaller)														
15	Durability	Appearance	No defects or abnormalities.														
		Capacitance Change	Within $\pm 12.5\%$														
		D.F.	0.2 max.														
		I.R.	More than 1000M Ω or 25 Ω · F (Whichever is smaller)														
16	ESR		<table border="1"> <thead> <tr> <th>Murata's Control Code</th> <th>Specification</th> </tr> </thead> <tbody> <tr> <td>E01</td> <td>100mΩ±30%</td> </tr> <tr> <td>E03</td> <td>220mΩ±30%</td> </tr> <tr> <td>E05</td> <td>470mΩ±30%</td> </tr> <tr> <td>E07</td> <td>1000mΩ±30%</td> </tr> </tbody> </table>	Murata's Control Code	Specification	E01	100m Ω ±30%	E03	220m Ω ±30%	E05	470m Ω ±30%	E07	1000m Ω ±30%				
		Murata's Control Code	Specification														
		E01	100m Ω ±30%														
		E03	220m Ω ±30%														
		E05	470m Ω ±30%														
E07	1000m Ω ±30%																
		<p>Solder the capacitor on the test substrate (glass epoxy board). (Refer to No.9)</p> <p>Perform the 5 cycles according to the four heat treatments shown in the following table.</p> <table border="1"> <thead> <tr> <th>Step</th> <th>Temp. (°C)</th> <th>Time (min)</th> </tr> </thead> <tbody> <tr> <td>1</td> <td>Min. Operating Temp. +0/-3</td> <td>30±3</td> </tr> <tr> <td>2</td> <td>Room Temp.</td> <td>2 to 3</td> </tr> <tr> <td>3</td> <td>Max. Operating Temp. +3/-0</td> <td>30±3</td> </tr> <tr> <td>4</td> <td>Room Temp.</td> <td>2 to 3</td> </tr> </tbody> </table> <p>Exposure Time:24±2h • Initial measurement Perform a heat treatment at 150+0/-10°C for 1h and then let sit for 24±2h at room temperature, then measure.</p>	Step	Temp. (°C)	Time (min)	1	Min. Operating Temp. +0/-3	30±3	2	Room Temp.	2 to 3	3	Max. Operating Temp. +3/-0	30±3	4	Room Temp.	2 to 3
Step	Temp. (°C)	Time (min)															
1	Min. Operating Temp. +0/-3	30±3															
2	Room Temp.	2 to 3															
3	Max. Operating Temp. +3/-0	30±3															
4	Room Temp.	2 to 3															
		<p>Solder the capacitor on the test substrate (glass epoxy board). (Refer to No.9)</p> <p>Test Temperature: 40±2°C Test Humidity: 90 to 95%RH Test Time: 500±12h Applied Voltage: DC Rated Voltage Charge/discharge current: 50mA max. • Initial measurement Perform a heat treatment at 150+0/-10°C for 1h and then let sit for 24±2h at room temperature, then measure. • Measurement after test Perform a heat treatment at 150+0/-10°C for 1h and then let sit for 24±2h at room temperature, then measure.</p>															
		<p>Solder the capacitor on the test substrate (glass epoxy board). (Refer to No.9)</p> <p>Test Temperature: Max. Operating Temp. ±3°C Test Time: 1000±12h Applied Voltage: 150% of the rated voltage Charge/discharge current: 50mA max. • Initial measurement Perform a heat treatment at 150+0/-10°C for 1h and then let sit for 24±2h at room temperature, then measure. • Measurement after test Perform a heat treatment at 150+0/-10°C for 1h and then let sit for 24±2h at room temperature, then measure.</p>															
		<p>Measurement Frequency: 10±0.1MHz Measurement Temperature: Room Temperature Measurement Equivalent: HP4294A</p>															

GRM
 GR3
 GRJ
 GR4
 GR7
 GJM
 GQM
 GA2
 GA3 GB
 GA3 GD
 GA3 GF
 LLL
 LLA
 LLM
 LLR
 NFM
 KPM
 KR3
 GMA
 GMD
 △Caution / Notice

3 Terminals Low ESL Chip Multilayer Ceramic Capacitors for General Purpose

NFM Series  **Low ESL** **EMI FIL®** **WEB** 

This is the most suitable Low ESL capacitors for noise measurement and power decoupling of highspeed electrical devices.

Features

① **Low ESL**

Since the equivalent series inductance (ESL) is low and excellent in high frequency characteristics, this capacitor is suitable for power supply decoupling of high-speed operation electronic equipment.

• 2-terminal Capacitor

Realizes Ultra low ESL by using a extremely shorter high frequency current path

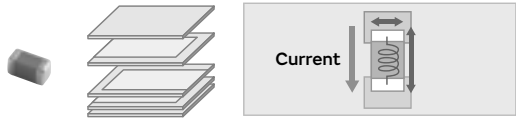

× long current distance
 × Narrow wiring width

• 3-terminal capacitor

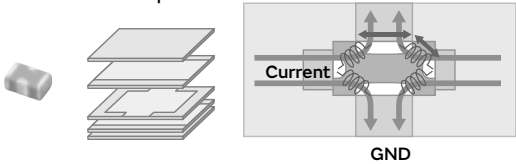

○ Short current distance
 ○ Wide wiring width
 ○ Four routes formed in parallel

② **Contributes to a reduction in the number of components.**

The number of components can be reduced by using low ESL capacitors, while maintaining functions equivalent to 2-terminal capacitor.

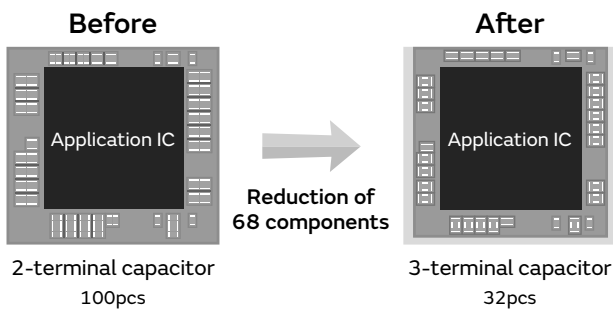

③ **Contributes to noise suppression**

Example of noise suppression effect **WEB** 

Specifications

Size (mm)	1.0×0.5mm to 4.5×1.6mm
Rated Voltage	2.5Vdc to 100Vdc
Capacitance	100pF to 27μF
Main Applications	For decoupling and smoothing circuits, For noise suppression

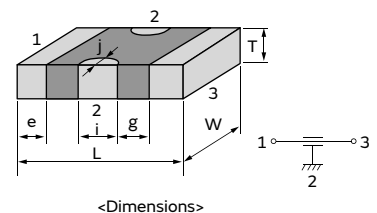

GRM, GR3, GRJ, GR4, GR7, GJM, GQM, GA2, GA3 GB, GA3 GD, GA3 GF, LLL, LLA, LLM, LLR, NFM, KRM, KR3, GMA, GMD, Caution /Notice

NFM Series Part Number List

1.0×0.5mm

T max.	Rated Voltage	Cap.	Tol.	Part Number
0.35mm	6.3Vdc	0.47μF	±20%	NFM15PC474R0J3#
	4Vdc	0.47μF	±20%	NFM15PC474D0G3#
		1.0μF	±20%	NFM15PC105R0G3#
0.5mm	16Vdc	2200pF	±20%	NFM15CC222D1C3#
		22000pF	±20%	NFM15CC223C1C3#
		47000pF	±20%	NFM15PC473C1C3#
	10Vdc	2200pF	±20%	NFM15CC222D1A3#
		22000pF	±20%	NFM15CC223C1A3#
		47000pF	±20%	NFM15PC473C1A3#
		0.10μF	±20%	NFM15PC104R1A3#
		0.22μF	±20%	NFM15PC224R1A3#
	6.3Vdc	0.10μF	±20%	NFM15PC104D0J3#
0.22μF		±20%	NFM15PC224D0J3#	
2.5Vdc	4.3μF	±20%	NFM15PC435R0E3#	
0.65mm	2.5Vdc	7.5μF	±20%	NFM15PC755R0E3#
0.7mm	2.5Vdc	9.1μF	±20%	NFM15PC915R0E3#

1.6×0.8mm

T max.	Rated Voltage	Cap.	Tol.	Part Number
0.7mm	16Vdc	100pF	±20%	NFM18CC101R1C3#
		220pF	±20%	NFM18CC221R1C3#
		470pF	±20%	NFM18CC471R1C3#
		1000pF	±20%	NFM18CC102R1C3#
		2200pF	±20%	NFM18CC222R1C3#
		22000pF	±20%	NFM18CC223R1C3#
		0.10μF	±20%	NFM18PC104R1C3#
		6.3Vdc	0.22μF	±20%
	0.47μF		±20%	NFM18PC474R0J3#
			±20%	NFM18PS474R0J3#
	1.0μF	±20%	NFM18PS105D0J3#	
		±20%	NFM18PS105R0J3#	
	2.2μF	±20%	NFM18PC225B0J3#	
0.9mm	10Vdc	2.2μF	±20%	NFM18PC225B1A3#
	6.3Vdc	1.0μF	±20%	NFM18PC105R0J3#

2.0×1.25mm

T max.	Rated Voltage	Cap.	Tol.	Part Number
0.95mm	50Vdc	220pF	±20%	NFM21CC221R1H3#
		470pF	±20%	NFM21CC471R1H3#
		1000pF	±20%	NFM21CC102R1H3#
		2200pF	±20%	NFM21CC222R1H3#
		22000pF	±20%	NFM21CC223R1H3#
	25Vdc	0.10μF	±20%	NFM21PC104R1E3#
	16Vdc	0.22μF	±20%	NFM21PC224R1C3#
		0.47μF	±20%	NFM21PC474R1C3#
		1.0μF	±20%	NFM21PC105B1C3#
	10Vdc	1.0μF	±20%	NFM21PC105B1A3#
		4.7μF	±20%	NFM21PC475B1A3#

T max.	Rated Voltage	Cap.	Tol.	Part Number
0.95mm	6.3Vdc	2.2μF	±20%	NFM21PC225B0J3#
		10μF	±20%	NFM21PS106B0J3#

3.2×1.25mm

T max.	Rated Voltage	Cap.	Tol.	Part Number
0.9mm	50Vdc	220pF	+50/-20%	NFM3DCC221R1H3#
		470pF	+50/-20%	NFM3DCC471R1H3#
		1000pF	+50/-20%	NFM3DCC102R1H3#
		2200pF	+50/-20%	NFM3DCC222R1H3#
		22000pF	+50/-20%	NFM3DCC223R1H3#
			±20%	NFM3DPC223R1H3#

3.2×1.6mm

T max.	Rated Voltage	Cap.	Tol.	Part Number	
1.5mm	100Vdc	10000pF	±20%	NFM31KC103R2A3#	
		15000pF	±20%	NFM31KC153R2A3#	
		22000pF	±20%	NFM31KC223R2A3#	
		0.10μF	±20%	NFM31KC104R2A3#	
	50Vdc	10000pF	±20%	NFM31KC103R1H3#	
		15000pF	±20%	NFM31KC153R1H3#	
		22000pF	±20%	NFM31KC223R1H3#	
		0.10μF	±20%	NFM31KC104R1H3#	
	6.3Vdc	27μF	±20%	NFM31PC276B0J3#	D3

4.5×1.6mm

T max.	Rated Voltage	Cap.	Tol.	Part Number	
1.2mm	100Vdc	470pF	+50/-20%	NFM41CC471R2A3#	
		1000pF	+50/-20%	NFM41CC102R2A3#	
		2200pF	+50/-20%	NFM41CC222R2A3#	
		22000pF	+50/-20%	NFM41CC223R2A3#	
	50Vdc	1.5μF	±20%	NFM41PC155B1H3#	
					25Vdc

Part number # indicates the package specification code.

GRM
 GR3
 GRJ
 GR4
 GR7
 GJM
 GQM
 GA2
 GA3 GB
 GA3 GD
 GA3 GF
 LLL
 LLA
 LLM
 LLR
 NFM
 KRM
 KR3
 GMA
 GMD
 ⚠Caution / Notice

NFM Series Specifications and Test Methods

Specifications and Test Methods, please refer to the search web page.
<https://www.murata.com/en-global/products/capacitor>

NFM Series Low ESR EMI Filter Part Number List

1.0×0.5mm

T max.	Rated Voltage	Cap.	Tol.	Part Number
0.35mm	6.3Vdc	0.47µF	±20%	NFM15PC474RQJ3#
	4Vdc	0.47µF	±20%	NFM15P74DOG3#
		1.0µF	±20%	NFM15P74DOG3#
0.5mm	16Vdc	2200pF	±20%	NFM15C222D1A3#
		2200pF	±20%	NFM15C222C1A3#
		47000pF	±20%	NFM15PC473C1A3#
	10Vdc	2200pF	±20%	NFM15CC222D1A3#
		2200pF	±20%	NFM15CC223C1A3#

Links are provided to the product detail pages on the web, and are shown below in the product number table from the PDF version of the catalog which is available on the web.

3 Terminals Low ESR, Chip Multilayer Ceramic Capacitors for General Purpose

NFM15CC222D1A3#

Shape

L (mm)	1.0 ±0.1mm
W (mm)	0.5 ±0.1mm
T (mm)	0.4 ±0.1mm
External terminal width	0.8±0.1mm
External terminal size (L)	0.35±0.1mm
External terminal size (W)	0.35±0.1mm
Distance between external terminals (L)	0.9mm min.

Specifications

Capacitance	2200pF
Rated voltage	16Vdc
Operating temperature range	-55 to 125
Rated Current	1A
DC Resistance (max.)	100Ω

Detailed Specifications Sheet

- Rated value
- Specifications and Test Methods
- Package
- Caution, Notice

SPECIFICATIONS AND TEST METHODS											
Mechanical Performance											
No	Item	Specification	Test Method								
1	Appearance and Dimensions	Appearance: No defects or abnormalities. Dimensions: Within the specified dimensions.	Appearance: Visual inspection. Dimensions: Using calipers.								
2	Solderability	Electrodes shall be at least 90% covered with new solder coating.	Flux : Ethanol solution of rosin, 25(wt)% Pre-heat : 150±10°C, 60 to 90s Solder : Sn-3.0Ag-0.5Cu Solder Temperature : 240 ± 3°C Immersion Time : 3±1 s Immersion and emersion rates : 25mm / s								
3	Resistance to soldering heat	Meet Table 1. Table 1 <table border="1"> <tr><td>Appearance</td><td>No damaged</td></tr> <tr><td>Cap. Change</td><td>Within ±7.5%</td></tr> <tr><td>I.R.</td><td>Meet the initial rated value.</td></tr> <tr><td>DC Resistance</td><td>0.05Ω max.</td></tr> </table>	Appearance	No damaged	Cap. Change	Within ±7.5%	I.R.	Meet the initial rated value.	DC Resistance	0.05Ω max.	Flux : Ethanol solution of rosin, 25(wt)% Pre-heat : 150±10°C, 60 to 90s Solder : Sn-3.0Ag-0.5Cu Solder Temperature : 270 ± 5°C Immersion Time : 10 ± 1 s Immersion and emersion rates : 25mm / s Initial values : measured after heat treatment (150+0 / -10 °C, 1hour) and exposure in the room condition for 48±4 hours. Then measured after exposure in the room condition for 48±4 hours.
Appearance	No damaged										
Cap. Change	Within ±7.5%										
I.R.	Meet the initial rated value.										
DC Resistance	0.05Ω max.										
4	Bending Strength	Meet Table 2. Table 2 <table border="1"> <tr><td>Appearance</td><td>No damaged</td></tr> <tr><td>Cap. Change</td><td>Within ±7.5%</td></tr> <tr><td>DC Resistance</td><td>0.05Ω max.</td></tr> </table>	Appearance	No damaged	Cap. Change	Within ±7.5%	DC Resistance	0.05Ω max.	It shall be soldered on the glass-epoxy substrate (100 × 40 × 0.8mm). Deflection : 1.0 mm Keeping Time : 5 s 		
Appearance	No damaged										
Cap. Change	Within ±7.5%										
DC Resistance	0.05Ω max.										
5	Drop	Products shall be no failure after tested.	It shall be dropped on concrete or steel board. Height : 1m Method : Free fall Attitude from which the product is dropped : 3 directions The Number of Time : 3 times for each direction (Total 9 times)								

GRM
GR3
GRJ
GR4
GR7
GJM
GQM
GA2
GA3 GB
GA3 GD
GA3 GF
LLL
LLA
LLM
LLR
NFM
KRM
KR3
GMA
GMD
Caution / Notice

Metal Terminal Type Multilayer Ceramic Capacitors for General Purpose

KRM Series



Anti-noise

Deflecting crack

Soldering crack

WEB

Bonding the metal terminals to external electrodes solves design issues by mounting large size MLCC!

Features

① **Bond metal terminals to the external electrodes of chips.**

The stress applied to the chip is relieved by the elastic action of the metal terminal.

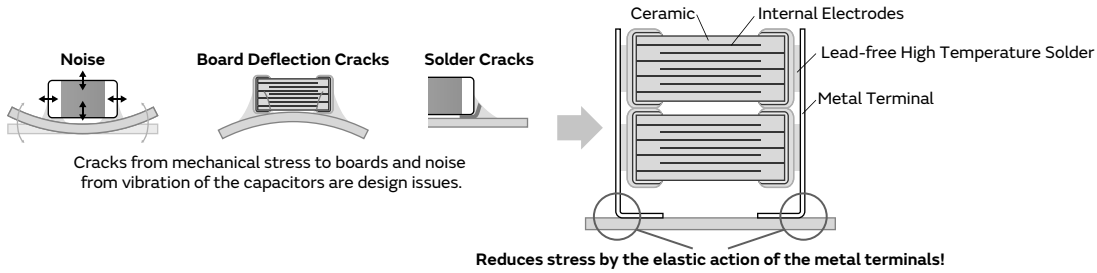

② **Substantially reduces noise, board deflection cracks and soldering cracks.**

This product is not damaged even with a board deflection of 6 mm.

Solder cracks do not occur even with 2,000 cycles of heat stress.

● **Acoustic Noise is Reduced with Metal Terminals**

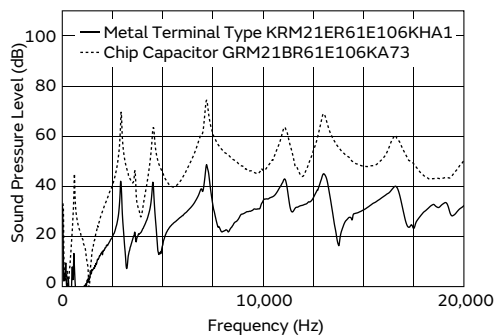

● **Reduces Stress Caused by Board Deflection**

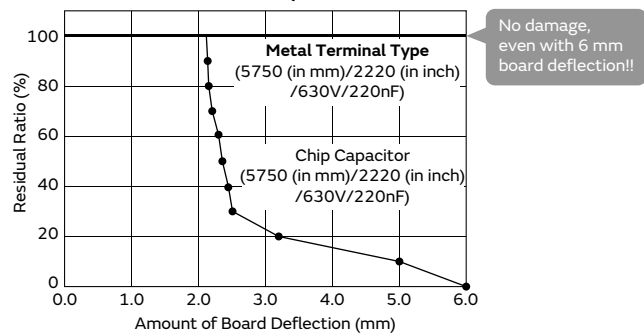

● **Suppresses Solder Cracks Caused by Heat Stress**

Chip Size	Chip Only (5750 (in mm)/2220 (in inch) size)	Metal Terminal Type (5750 (in mm)/2220 (in inch) size)
1000 Cycle	 ↑Solder Crack	
2000 Cycle	 ↑Solder Crack	

Compared with chips only, this product is excellent in solder cracking resistance.

Test Condition: -55 to +125°C, 5min.,(Liquid Phase)
 Board Used: Glass Epoxy Board (FR-4)

Demonstrates replacement value of low noise capacitors Experience the effectiveness of the KRM Series.

Examples of Noise Countermeasures

WEB

GRM
 GR3
 GRJ
 GR4
 GR7
 GJM
 GQM
 GA2
 GA3 GB
 GA3 GD
 GA3 GF
 LLL
 LLA
 LLM
 LLR
 NFM
 KRM
 KR3
 GMA
 GMD
 ⚠Caution / Notice

- GRM
- GR3
- GRJ
- GR4
- GR7
- GJM
- GQM
- GA2
- GA3 GB
- GA3 GD
- GA3 GF
- LLL
- LLA
- LLM
- LLR
- NFM
- KRM
- KR3
- GMA
- GMD
- ⚠Caution /Notice

③ **2 chips can be stacked.**

Realize large capacity by stacking 2 capacitors.

Specifications

Size (mm)	2.2×1.25mm to 6.1×5.3mm
Rated Voltage	16Vdc to 1000Vdc
Capacitance	68000pF to 100μF
Main Applications	For smoothing and noise suppression of DC-DC converters

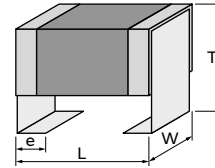

<Dimensions>

This catalog contains only a portion of the product lineup.
 Please refer to the capacitor search tool on the Murata Web site for details.

KRM Series High Dielectric Constant Type Anti-noise Deflecting crack Soldering crack Part Number List

2.2×1.25mm

T max.	Rated Voltage	TC Code	Cap.	Tol.	Part Number	
1.9mm	25Vdc	X5R	10μF	±10%	KRM21ER61E106KFA1#	
	16Vdc	X5R	10μF	±10%	KRM21ER61C106KFA1#	
2.0mm	25Vdc	X7S	10μF	±10%	KRM21FC71E106KFA1#	D1
		X6S	10μF	±10%	KRM21FC81E106KFA1#	D1
		X5R	22μF	±20%	KRM21FR61E226MFA1#	

3.5×1.7mm

T max.	Rated Voltage	TC Code	Cap.	Tol.	Part Number	
2.0mm	25Vdc	X5R	10μF	±10%	KRM31FR61E106KH01#	
2.9mm	100Vdc	X7R	1.0μF	±10%	KRM31KR72A105KH01#	
	50Vdc	X7R	4.7μF	±10%	KRM31KR71H475KH01#	
	35Vdc	X6S	10μF	±10%	KRM31KC8YA106KH01#	
	25Vdc	X6S	10μF	±10%	KRM31KC81E106KH01#	

3.6×1.7mm

T max.	Rated Voltage	TC Code	Cap.	Tol.	Part Number	
2.9mm	50Vdc	X7R	2.2μF	±10%	KRM31KR71H225KH01#	

3.7×1.85mm

T max.	Rated Voltage	TC Code	Cap.	Tol.	Part Number	
2.9mm	100Vdc	X7R	2.2μF	±10%	KRM31KR72A225KH01#	

6.1×5.3mm

T max.	Rated Voltage	TC Code	Cap.	Tol.	Part Number	
3.0mm	1000Vdc	X7R	68000pF	±10%	KRM55LR73A683KH01#	
			0.10μF	±10%	KRM55LR73A104KH01#	
	630Vdc	X7R	0.15μF	±10%	KRM55LR72J154KH01#	
			0.22μF	±10%	KRM55LR72J224KH01#	
	450Vdc	X7R	0.33μF	±10%	KRM55LR72W334KH01#	
			0.47μF	±10%	KRM55LR72W474KH01#	
	250Vdc	X7R	0.68μF	±10%	KRM55LR72E684KH01#	
			1.0μF	±10%	KRM55LR72E105KH01#	
	100Vdc	X7R	4.7μF	±10%	KRM55LR72A475KH01#	
	63Vdc	X7R	4.7μF	±10%	KRM55LR71J475KH01#	
			10μF	±10%	KRM55LR71H106KH01#	
	50Vdc	X7R	4.7μF	±10%	KRM55LR71H475KH01#	
			10μF	±10%	KRM55LR71H106KH01#	
	35Vdc	X7R	10μF	±10%	KRM55LR7YA106KH01#	
15μF			±10%	KRM55LR7YA156KH01#		
25Vdc	X7R	15μF	±10%	KRM55LR71E156KH01#		
3.9mm	100Vdc	X7R	6.8μF	±10%	KRM55QR72A685KH01#	
			10μF	±10%	KRM55QR72A106KH01#	
	63Vdc	X7R	10μF	±10%	KRM55QR71J106KH01#	
	50Vdc	X7R	17μF	±10%	KRM55QR71H176KH01#	
	35Vdc	X7R	17μF	±10%	KRM55QR7YA176KH01#	

T max.	Rated Voltage	TC Code	Cap.	Tol.	Part Number		
3.9mm	35Vdc	X7R	22μF	±10%	KRM55QR7YA226KH01#		
			22μF	±10%	KRM55QR71E226KH01#		
	25Vdc	X7R	33μF	±10%	KRM55QR71E336KH01#		
			X7S	47μF	±10%	KRM55QC71E476KH13#	
5.0mm	1000Vdc	X7R	0.15μF	±20%	KRM55TR73A154MH01#		
			0.22μF	±20%	KRM55TR73A224MH01#		
	630Vdc	X7R	0.33μF	±20%	KRM55TR72J334MH01#		
			0.47μF	±20%	KRM55TR72J474MH01#		
			450Vdc	X7R	0.68μF	±20%	KRM55TR72W684MH01#
	1μF	±20%			KRM55TR72W105MH01#		
	250Vdc	X7R	1.5μF	±20%	KRM55TR72E155MH01#		
			2.2μF	±20%	KRM55TR72E225MH01#		
	100Vdc	X7R	10μF	±20%	KRM55TR72A106MH01#		
	50Vdc	X7R	22μF	±20%	KRM55TR71H226MH01#		
	35Vdc	X7R	22μF	±20%	KRM55TR7YA226MH01#		
			33μF	±20%	KRM55TR7YA336MH01#		
		25Vdc	X7R	33μF	±20%	KRM55TR71E336MH01#	
				15μF	±20%	KRM55WR72A156MH01#	
6.7mm	100Vdc	X7R	22μF	±20%	KRM55WR72A226MH01#		
			22μF	±20%	KRM55WR72A226MH01#		
	63Vdc	X7R	22μF	±20%	KRM55WR71J226MH01#		
	50Vdc	X7R	33μF	±20%	KRM55WR71H336MH01#		
	35Vdc	X7R	47μF	±20%	KRM55WR7YA476MH01#		
	25Vdc	X7R	47μF	±20%	KRM55WR71E476MH01#		
			68μF	±20%	KRM55WR71E686MH01#		
			X7S	100μF	±20%	KRM55WC71E107MH13#	

- GRM
- GR3
- GRJ
- GR4
- GR7
- GJM
- GQM
- GA2
- GA3 GB
- GA3 GD
- GA3 GF
- LLL
- LLA
- LLM
- LLR
- NFM
- KRM
- KR3
- GMA
- GMD
- ⚠Caution / Notice

Part number # indicates the package specification code.

KRM Series Specifications and Test Methods

Specifications and Test Methods, please refer to the search web page.
<https://www.murata.com/en-global/products/capacitor>

KRM Series High Dielectric Constant Type

2.2×1.25mm

T max.	Rated Voltage	TC Code	Cap.	Tol.	Part Number
1.9mm	25Vdc	X5R	10μF	±10%	KRM215R61E106KFA1#
	16Vdc	X5R	10μF	±10%	KRM215R61E106KFA1#
2.0mm	25Vdc	X7S	10μF	±10%	KRM215R61E106KFA1#
	X6S	10μF	±10%	KRM215R61E106KFA1#	
	X5R	22μF	±20%	KRM215R61E226MFA1#	

3.5×1.7mm

Links are provided to the product detail pages on the web, and are shown below in the product number table from the PDF version of the catalog which is available on the web.

The screenshot shows the product page for KRM31FR61E106KH01#. It includes a 'Specifications' section with a table of parameters, a 'Shape' section with a 3D model and dimensions, and a 'References' section with a chart of characteristic data. A dashed box highlights the 'Specifications' section, which is linked to the 'Detailed Specifications Sheet'.

Detailed Specifications Sheet

- Rated value
- Specifications and Test Methods
- Package
- Caution, Notice

Reference only

4. Specifications and test methods																				
No.	Item	Specifications	Test method																	
1	Operating temperature range	Char. X5R : -55 to +85°C Char. X6S : -55 to +105°C Char. X7R : -55 to +125°C																		
2	Appearance	No defects or abnormalities.	Visual inspection.																	
3	Dimensions	Within the specified dimension.	Using calipers and micrometers.																	
4	Dielectric strength	No defects or abnormalities.	No failure should be observed when voltage in the table is applied between the terminations for 1 to 5 s, provided the charge/discharge current is less than 50mA. <table border="1"> <thead> <tr> <th>Rated Voltage</th> <th>Test Voltage</th> </tr> </thead> <tbody> <tr> <td>DC25V, DC35V, DC50V</td> <td>250% of the rated voltage</td> </tr> <tr> <td>DC100V</td> <td>200% of the rated voltage</td> </tr> </tbody> </table>	Rated Voltage	Test Voltage	DC25V, DC35V, DC50V	250% of the rated voltage	DC100V	200% of the rated voltage											
Rated Voltage	Test Voltage																			
DC25V, DC35V, DC50V	250% of the rated voltage																			
DC100V	200% of the rated voltage																			
5	Insulation resistance (I.R.)	<table border="1"> <thead> <tr> <th>Rated Voltage</th> <th>I.R.</th> </tr> </thead> <tbody> <tr> <td>DC25V, DC35V</td> <td>50MΩ·μF or more</td> </tr> <tr> <td>DC50V, DC100V</td> <td>500MΩ·μF or more</td> </tr> </tbody> </table>	Rated Voltage	I.R.	DC25V, DC35V	50MΩ·μF or more	DC50V, DC100V	500MΩ·μF or more	The insulation resistance should be measured with rated voltage and within 60±5 s of charging.											
Rated Voltage	I.R.																			
DC25V, DC35V	50MΩ·μF or more																			
DC50V, DC100V	500MΩ·μF or more																			
6	Capacitance	Within the specified tolerance.	The capacitance/D.F. should be measured at reference temperature at the meaning frequency and voltage shown in the table.																	
7	Dissipation Factor (D.F.)	<table border="1"> <thead> <tr> <th>Rated Voltage</th> <th>D.F.</th> </tr> </thead> <tbody> <tr> <td>DC25V, DC35V</td> <td>0.15 max.</td> </tr> <tr> <td>DC50V</td> <td>0.025 max.</td> </tr> <tr> <td>DC100V</td> <td>0.05 max.</td> </tr> </tbody> </table>	Rated Voltage	D.F.	DC25V, DC35V	0.15 max.	DC50V	0.025 max.	DC100V	0.05 max.	<table border="1"> <thead> <tr> <th>Nominal capacitance</th> <th>Measuring frequency</th> <th>Measuring voltage</th> </tr> </thead> <tbody> <tr> <td>C > 10 μF</td> <td>120±24Hz</td> <td>AC0.5±0.1V (r.m.s.)</td> </tr> <tr> <td>C ≤ 10 μF</td> <td>1±0.2kHz</td> <td>AC1.0±0.2V (r.m.s.)</td> </tr> </tbody> </table>	Nominal capacitance	Measuring frequency	Measuring voltage	C > 10 μF	120±24Hz	AC0.5±0.1V (r.m.s.)	C ≤ 10 μF	1±0.2kHz	AC1.0±0.2V (r.m.s.)
Rated Voltage	D.F.																			
DC25V, DC35V	0.15 max.																			
DC50V	0.025 max.																			
DC100V	0.05 max.																			
Nominal capacitance	Measuring frequency	Measuring voltage																		
C > 10 μF	120±24Hz	AC0.5±0.1V (r.m.s.)																		
C ≤ 10 μF	1±0.2kHz	AC1.0±0.2V (r.m.s.)																		
8	Capacitance Temperature Characteristics	Char. X5R : within ±15% (Temp.Range:-55 to +85°C) Char. X6S : within ±22% (Temp.Range:-55 to +105°C) Char. X7R : within ±15% (Temp.Range:-55 to +125°C)	The capacitance measurement should be made at each step specified in the table. •Pretreatment Perform the heat treatment at 150+0/-10°C for 60±5 min and then let sit for 24±2 h at room condition*. <table border="1"> <thead> <tr> <th>Step</th> <th>1</th> <th>2</th> <th>3</th> <th>4</th> <th>5</th> </tr> </thead> <tbody> <tr> <td>Temp.(°C)</td> <td>25±2</td> <td>Min. Operating Temp. ±3</td> <td>25±2</td> <td>Max. Operating Temp. ±2</td> <td>25±2</td> </tr> </tbody> </table>	Step	1	2	3	4	5	Temp.(°C)	25±2	Min. Operating Temp. ±3	25±2	Max. Operating Temp. ±2	25±2					
Step	1	2	3	4	5															
Temp.(°C)	25±2	Min. Operating Temp. ±3	25±2	Max. Operating Temp. ±2	25±2															
9	Vibration resistance	Appearance Capacitance	No defects or abnormalities. Within the specified tolerance	Solder the capacitor to the Test Jig A (glass epoxy board) shown in "Complement of test"																

High Effective Capacitance & High Allowable Ripple Current Metal Terminal Type Multilayer Ceramic Capacitors for General Purpose

KR3 Series



Anti-noise

Deflecting crack

Soldering crack

WEB

Bonding the metal terminals to external electrodes solves design issues by mounting large size MLCC!

Features

1 Bond Metal Terminals to External Electrodes of Chips

This product has high resistance to heat and mechanical impact and greatly reduces acoustic noise of boards by ceramics.

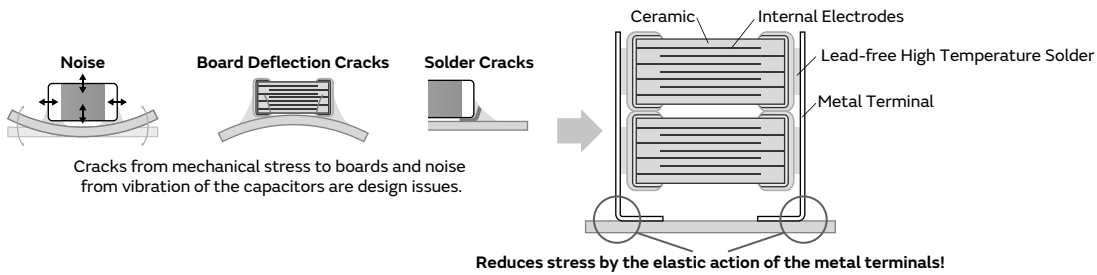

2 Stacking of Chips

Achieve high capacity by stacking 2 capacitors.

● Comparison of Noise Reduction Effects

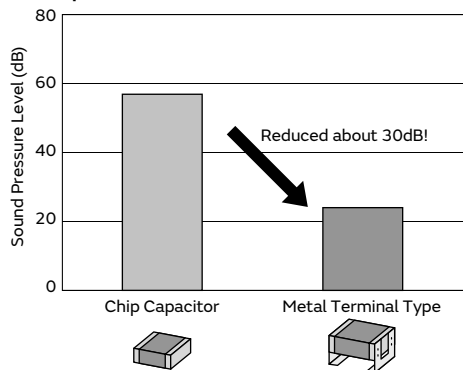

Evaluation Items: 5750 (in mm)/2220 (in inch) size/DC630V/220nF
 Test Method: DC50V, AC10Vp-p/3kHz
 Test Board: Glass Epoxy Board (T=1.6mm)
 Test Quantity: 3pc
 Distance Between Microphone and Board: 3mm

Note: Results Using Murata's Evaluation Board

● Reduces Stress Caused by Board Deflection

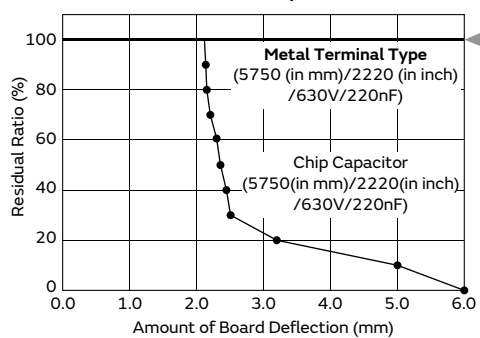

No damage, even with 6 mm board deflection!!

● Suppresses Solder Cracks Caused by Heat Stress

Chip Size	Chip Only (5750 (in mm)/2220 (in inch) size)	Metal Terminal Type (5750 (in mm)/2220 (in inch) size)
1000 Cycle	 ↑ Solder Crack	
2000 Cycle	 ↑ Solder Crack	

Compared with chips only, this product is excellent in solder cracking resistance.

Test Condition: -55 to +125°C, 5min., (Liquid Phase)
 Board Used: Glass Epoxy Board (FR-4)

- GRM
- GR3
- GRJ
- GR4
- GR7
- GJM
- GQM
- GA2
- GA3 GB
- GA3 GD
- GA3 GF
- LLL
- LLA
- LLM
- LLR
- NFM
- KPM
- KR3
- GMA
- GMD
- ⚠Caution / Notice

GRM
 GR3
 GRJ
 GR4
 GR7
 GJM
 GQM
 GA2
 GA3 GB
 GA3 GD
 GA3 GF
 LLL
 LLA
 LLM
 LLR
 NFM
 KRM
 KR3
 GMA
 GMD
 ⚠Caution /Notice

3 Adopted Low Dielectric Constant Materials

Improved effective capacity and ripple resistant performance, compared to conventional products (X7R characteristics).

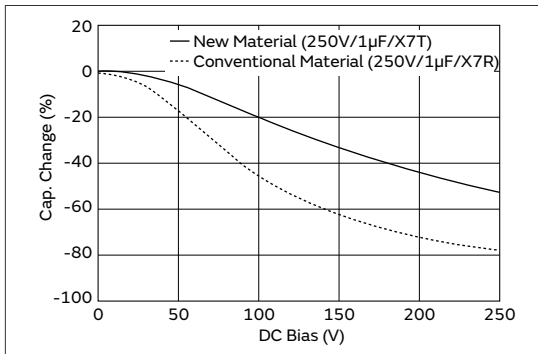

Specifications

Size (mm)	6.1×5.3mm
Rated Voltage	250Vdc to 630Vdc
Capacitance	0.10µF to 2.2µF
Main Applications	For DC-DC converters of general electronic equipment

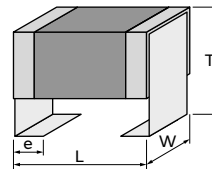

<Dimensions>

This catalog contains only a portion of the product lineup.
 Please refer to the capacitor search tool on the Murata Web site for details.

KR3 Series High Dielectric Constant Type **Anti-noise** **Deflecting crack** **Soldering crack** Part Number List

6.1×5.3mm

T max.	Rated Voltage	TC Code	Cap.	Tol.	Part Number	p*
3.0mm	630Vdc	X7T	0.10μF	±10%	KR355LD72J104KH01#	p246
			0.15μF	±10%	KR355LD72J154KH01#	p246
	450Vdc	X7T	0.22μF	±10%	KR355LD72W224KH01#	p246
			0.33μF	±10%	KR355LD72W334KH01#	p246
			0.47μF	±10%	KR355LD72W474KH01#	p246
	250Vdc	X7T	0.47μF	±10%	KR355LD72E474KH01#	p246
0.68μF			±10%	KR355LD72E684KH01#	p246	
3.9mm	630Vdc	X7T	0.22μF	±10%	KR355QD72J224KH01#	p246
			0.27μF	±10%	KR355QD72J274KH01#	p246
	450Vdc	X7T	0.56μF	±10%	KR355QD72W564KH01#	p246
			1.0μF	±10%	KR355QD72E105KH01#	p246
5.0mm	450Vdc	X7T	0.68μF	±20%	KR355TD72W684MH01#	p246
			1.0μF	±20%	KR355TD72W105MH01#	p246
	250Vdc	X7T	1.5μF	±20%	KR355TD72E155MH01#	p246
6.7mm	630Vdc	X7T	0.47μF	±20%	KR355WD72J474MH01#	p246
			0.56μF	±20%	KR355WD72J564MH01#	p246
	450Vdc	X7T	1.2μF	±20%	KR355WD72W125MH01#	p246
			2.2μF	±20%	KR355WD72E225MH01#	p246

*: Refers to the page of the "Specifications and Test Methods".

Part number # indicates the package specification code.

1

KR3 Series Specifications and Test Methods (1)

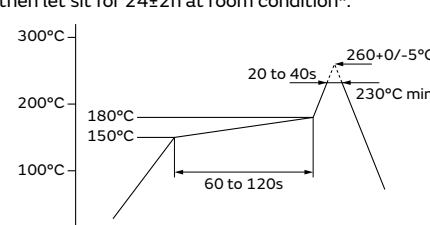
No	Item	Specification	Test Method (Ref. Standard: JIS C 5101, IEC60384)												
1	Operating Temperature	-55 to +125°C													
2	Appearance	No defects or abnormalities	Visual inspection.												
3	Dimension	Within the specified dimension.	Using calipers and micrometers.												
4	Dielectric Strength	No defects or abnormalities.	No failure should be observed when voltage in the table is applied between the terminations for 1 to 5s, provided the charge/discharge current is less than 50mA. <table border="1"> <thead> <tr> <th>Rated Voltage</th> <th>Test Voltage</th> </tr> </thead> <tbody> <tr> <td>DC250V</td> <td>200% of the rated voltage</td> </tr> <tr> <td>DC450V</td> <td>150% of the rated voltage</td> </tr> <tr> <td>DC630V</td> <td>120% of the rated voltage</td> </tr> </tbody> </table>	Rated Voltage	Test Voltage	DC250V	200% of the rated voltage	DC450V	150% of the rated voltage	DC630V	120% of the rated voltage				
Rated Voltage	Test Voltage														
DC250V	200% of the rated voltage														
DC450V	150% of the rated voltage														
DC630V	120% of the rated voltage														
5	Insulation Resistance (I.R.)	More than 10000MΩ or 100MΩ • μF (Whichever is smaller)	The insulation resistance should be measured with DC500±50V (DC250±25V in case of rated voltage: DC250V, DC450V) and within 60±5s of charging.												
6	Capacitance	Within the specified tolerance.	Capacitance should be measured at the frequency of 1±0.2kHz and a voltage of AC1.0±0.2V (r.m.s.).												
7	Dissipation Factor (D.F.)	0.01 max.	D.F. should be measured at the frequency of 1±0.2kHz and a voltage of AC1.0±0.2V (r.m.s.).												
8	Capacitance Temperature Characteristics	Cap. change within +22/-33% (Temp.Range: -55 to +125°C)	The capacitance measurement should be made at each step specified in the table. • Pretreatment Perform the heat treatment at 150+0/-10°C for 60±5min and then let sit for 24±2h at room condition*. <table border="1"> <thead> <tr> <th>Step</th> <th>Temperature (°C)</th> </tr> </thead> <tbody> <tr> <td>1</td> <td>25±2</td> </tr> <tr> <td>2</td> <td>Min. Operating Temp. ±3</td> </tr> <tr> <td>3</td> <td>25±2</td> </tr> <tr> <td>4</td> <td>Max. Operating Temp. ±3</td> </tr> <tr> <td>5</td> <td>25±2</td> </tr> </tbody> </table>	Step	Temperature (°C)	1	25±2	2	Min. Operating Temp. ±3	3	25±2	4	Max. Operating Temp. ±3	5	25±2
Step	Temperature (°C)														
1	25±2														
2	Min. Operating Temp. ±3														
3	25±2														
4	Max. Operating Temp. ±3														
5	25±2														
9	Appearance	No defects or abnormalities.	Solder the capacitor to the Test Jig A (glass epoxy board) shown in "Complement of Test Method". The capacitor should be subjected to a simple harmonic motion having a total amplitude of 1.5mm, the frequency being varied uniformly between the approximate limits of 10 and 55Hz. The frequency range, from 10 to 55Hz and return to 10Hz, should be traversed in approximately 1min. This motion should be applied for a period of 2h in each of 3 mutually perpendicular directions (total of 6h).												
	Capacitance	Within the specified tolerance.													
	D.F.	Pass the item No.7.													
10	Solderability of Termination	The metal surface is soldered well.	Reflow Soldering: Peak 260+0/-5°C The area of soldering 230°C min., 20 to 40s Let sit for 24±2h at room condition*, then measure. • Pretreatment Perform the heat treatment at 150+0/-10°C for 60±5min and then let sit for 24±2h at room condition*. 												
11	Appearance	No marking defects.	Reflow Soldering • See Item 10 Solderability of termination In a soldering iron case Temp. of solder: 350±10°C Solder time: 4+1/-0 s Let sit for 24±2h at room condition*, then measure. Please refer to "⚠Caution 4-3. Correction of Soldered Portion"												
	Resistance to Soldering Heat														
	Capacitance Change	Within ±10%													
	D.F.	Pass the item No.7.													
	I.R.	Pass the item No.5.													
	Dielectric Strength	Pass the item No.4.													

* Room Condition: Temperature: 15 to 35°C, Relative humidity: 45 to 75%, Atmosphere pressure: 86 to 106kPa

Continued on the following page. ↗

GRM
 GR3
 GRJ
 GR4
 GR7
 GJM
 GQM
 GA2
 GA3
 GB
 GA3
 GD
 GA3
 GF
 LLL
 LLA
 LLM
 LLR
 NFM
 KRM
 KR3
 GMA
 GMD
 ⚠Caution /Notice

KR3 Series Specifications and Test Methods (1)

Continued from the preceding page. ↘

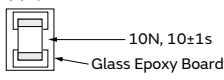
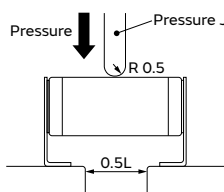
No	Item	Specification	Test Method (Ref. Standard: JIS C 5101, IEC60384)															
12	Adhesive Strength of Termination	No removal of the terminations or other defects should occur.	Solder the capacitor to the Test Jig A (glass epoxy board) shown in "Complement of Test Method". Then apply 10N force in the direction of the arrow. 															
13	Deflection	No marking defects.	Solder the capacitor to the Test Jig B (glass epoxy board) shown in "Complement of Test Method". Then apply the force in the direction shown in "Test Method of Deflection" of "Complement of Test Method". • Flexure: 5mm • Hold time: 5s															
14	Strength of metal Terminal	Termination not to be broken or loosened.	A static load of 10N using a pressure jig should be applied to the center in the direction of the arrow and held for 10s 															
15	Temperature Cycle	Appearance	Fix the capacitor to the supporting Test Jig A (glass epoxy board) shown in "Complement of Test Method". Perform the 100 cycles according to the 4 heat treatments listed the following table. <table border="1" data-bbox="933 952 1380 1086"> <thead> <tr> <th>Step</th> <th>Temp. (°C)</th> <th>Time (min)</th> </tr> </thead> <tbody> <tr> <td>1</td> <td>Min. Operating Temp. ±3</td> <td>30±3</td> </tr> <tr> <td>2</td> <td>Room Temp.</td> <td>2 to 3</td> </tr> <tr> <td>3</td> <td>Max. Operating Temp. ±2</td> <td>30±3</td> </tr> <tr> <td>4</td> <td>Room Temp.</td> <td>2 to 3</td> </tr> </tbody> </table> Let sit for 24±2h at room condition*, then measure. • Pretreatment Perform the heat treatment at 150+0/-10°C for 60±5min and then let sit for 24±2h at room condition*.	Step	Temp. (°C)	Time (min)	1	Min. Operating Temp. ±3	30±3	2	Room Temp.	2 to 3	3	Max. Operating Temp. ±2	30±3	4	Room Temp.	2 to 3
		Step		Temp. (°C)	Time (min)													
		1		Min. Operating Temp. ±3	30±3													
		2		Room Temp.	2 to 3													
		3		Max. Operating Temp. ±2	30±3													
4	Room Temp.	2 to 3																
Capacitance Change	Within ±7.5%																	
D.F.	Pass the item No.7.																	
I.R.	Pass the item No.5.																	
Dielectric Strength	Pass the item No.4.																	
16	Humidity (Steady State)	Appearance	Sit the capacitor at 40±2°C and relative humidity 90 to 95% for 500+24/-0h. Remove and let sit for 24±2h at room condition*, then measure. • Pretreatment Perform the heat treatment at 150+0/-10°C for 60±5min and then let sit for 24±2h at room condition*.															
		Capacitance Change		Within ±12.5%														
		D.F.		0.02 max.														
		I.R.		More than 1000 MΩ or 10 MΩ · μF (Whichever is smaller)														
		Dielectric Strength		Pass the item No.4.														
17	Life	Appearance	Apply voltage as in the table for 1000+48/-0h at maximum operating temperature±3°C. Remove and let sit for 24±2h at room condition*, then measure. <table border="1" data-bbox="933 1534 1452 1646"> <thead> <tr> <th>Rated Voltage</th> <th>Applied Voltage</th> </tr> </thead> <tbody> <tr> <td>DC250V</td> <td>150% of the rated voltage</td> </tr> <tr> <td>DC450V</td> <td>130% of the rated voltage</td> </tr> <tr> <td>DC630V</td> <td>120% of the rated voltage</td> </tr> </tbody> </table> The charge/discharge current is less than 50mA. • Pretreatment Apply test voltage for 60±5min at test temperature.	Rated Voltage	Applied Voltage	DC250V	150% of the rated voltage	DC450V	130% of the rated voltage	DC630V	120% of the rated voltage							
		Rated Voltage		Applied Voltage														
		DC250V		150% of the rated voltage														
		DC450V		130% of the rated voltage														
		DC630V		120% of the rated voltage														
Capacitance Change	Within ±12.5%																	
D.F.	0.02 max.																	
I.R.	More than 1000 MΩ or 10 MΩ · μF (Whichever is smaller)																	
Dielectric Strength	Pass the item No.4.																	

* Room Condition: Temperature: 15 to 35°C, Relative humidity: 45 to 75%, Atmosphere pressure: 86 to 106kPa

Continued on the following page. ↗

GRM
GR3
GRJ
GR4
GR7
GJM
GQM
GA2
GA3 GB
GA3 GD
GA3 GF
LLL
LLA
LLM
LLR
NFM
KPM
KR3
GMA
GMD
△Caution / Notice

KR3 Series Specifications and Test Methods (1)

Continued from the preceding page. ↘

Complement of Test Method

Test Jig

The test jig should be Jig A or Jig B as described in "Specifications and Test Methods".
 The specimen should be soldered by the conditions as described below.

Soldering Method: Reflow soldering
 Thickness of Metal-mask: 200 μ m
 Solder: Sn-3.0Ag-0.5Cu

(1) Test Jig A

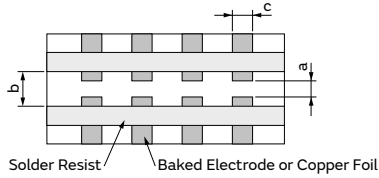

Dimension (mm)		
a	b	c
4.5	8.0	5.6

- Material: Glass Epoxy Board
- Thickness: 1.6mm
- Thickness of copper foil: 0.035mm

(2) Test Jig B

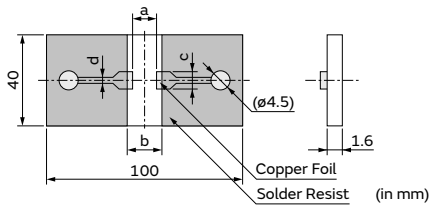

Dimension (mm)			
a	b	c	d
4.5	8.0	5.6	1.0

- Material: Glass Epoxy Board
- Thickness of copper foil: 0.035mm

GRM
 GR3
 GRJ
 GR4
 GR7
 GJM
 GQM
 GA2
 GA3 GB
 GA3 GD
 GA3 GF
 LLL
 LLA
 LLM
 LLR
 NFM
 KRM
 KR3
 GMA
 GMD
 ⚠Caution /Notice

Wire Bonding Mount Multilayer Microchip Capacitors for General Purpose

GMA Series



These capacitors have gold-plated electrodes and are designed specifically for wire bonding.

Features

① Allows for high density mounting.

Noise can be reduced by eliminating the routing of the wire, and high efficiency can be achieved with a built-in capacitor in a package, such as IC. Miniaturization of the set is also possible.

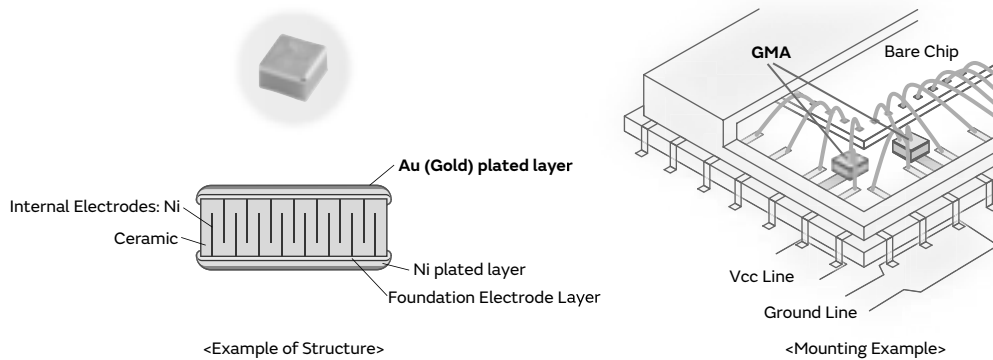

② Achieved small size and high capacitance with a multilayer structure.

Small size, high capacitance	Minimum 0.38mm×0.38mm Achieved 0.1μF in 0.5mm×0.5mm size
------------------------------	---

Lineup comparison table with competitor's is provided in my Murata Capacitor Site (need to sign in & approval from the site)



③ Ideal for bypass applications

Especially for optical communication related devices such as TOSA/ROSA.

④ Excellent in high frequency characteristics.

Since the capacitor consists of an upper/lower electrode structure, the current path becomes shorter and lowers the ESL. Compared with the general purpose GRM series of the same capacity, the impedance of this product becomes lower at high frequencies.

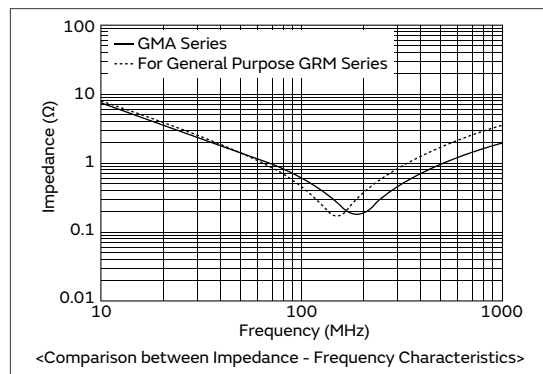

GRM
 GR3
 GRJ
 GR4
 GR7
 GJM
 GQM
 GA2
 GA3 GB
 GA3 GD
 GA3 GF
 LLL
 LLA
 LLM
 LLR
 NFM
 KPM
 KR3
 GMA
 GMD
 ⚠Caution / Notice

- GRM
- GR3
- GRJ
- GR4
- GR7
- GJM
- GQM
- GA2
- GA3
GB
- GA3
GD
- GA3
GF
- LLL
- LLA
- LLM
- LLR
- NFM
- KRM
- KR3
- GMA
- GMD
- ⚠Caution /Notice

Specifications

Size (mm)	0.38×0.38mm to 0.8×0.8mm
Rated Voltage	6.3Vdc to 100Vdc
Capacitance	100pF to 0.47μF
Main Applications	<ol style="list-style-type: none"> 1. Optical communication related devices such as TOSA/ROSA. 2. Various device related, such as GaAsIC (mounted in IC packages) 3. Measuring instruments, other ultra compact/thin devices

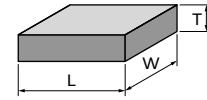

<Dimensions>

This catalog contains only a portion of the product lineup.
 Please refer to the capacitor search tool on the Murata Web site for details.

GMA Series High Dielectric Constant Type Part Number List

0.38×0.38mm

T max.	Rated Voltage	TC Code	Cap.	Tol.	Part Number	p*	
0.35mm	10Vdc	X7R	1000pF	±20%	GMA0D3R71A102MA01#	p254	
			1500pF	±20%	GMA0D3R71A152MA01#	p254	
			1800pF	±20%	GMA0D3R71A182MA01#	p254	
			10000pF	±20%	GMA0D3R71A103MA01#	p254	
			R	1000pF	±20%	GMA0D3R11A102MA01#	p254
				1500pF	±20%	GMA0D3R11A152MA01#	p254
		1800pF		±20%	GMA0D3R11A182MA01#	p254	
		10000pF		±20%	GMA0D3R11A103MA01#	p254	
		B		1000pF	±20%	GMA0D3B11A102MA01#	p254
				1500pF	±20%	GMA0D3B11A152MA01#	p254
			1800pF	±20%	GMA0D3B11A182MA01#	p254	
			10000pF	±20%	GMA0D3B11A103MA01#	p254	

0.5×0.5mm

T max.	Rated Voltage	TC Code	Cap.	Tol.	Part Number	p*			
0.4mm	100Vdc	X7R	100pF	±20%	GMA05XR72A101MA01#	p254			
			150pF	±20%	GMA05XR72A151MA01#	p254			
			220pF	±20%	GMA05XR72A221MA01#	p254			
			330pF	±20%	GMA05XR72A331MA01#	p254			
			470pF	±20%	GMA05XR72A471MA01#	p254			
			680pF	±20%	GMA05XR72A681MA01#	p254			
			1000pF	±20%	GMA05XR72A102MA01#	p254			
			X7R	1500pF	±20%	GMA05XR71E152MA11#	p254		
				2200pF	±20%	GMA05XR71E222MA11#	p254		
				3300pF	±20%	GMA05XR71E332MA11#	p254		
				4700pF	±20%	GMA05XR71E472MA11#	p254		
				B	1500pF	±20%	GMA05XB31E152MA11#	p254	
		2200pF			±20%	GMA05XB31E222MA11#	p254		
		3300pF			±20%	GMA05XB31E332MA11#	p254		
		4700pF			±20%	GMA05XB31E472MA11#	p254		
		10Vdc			X7R	6800pF	±20%	GMA05XR71A682MA01#	p254
						10000pF	±20%	GMA05XR71A103MA01#	p254
				15000pF		±20%	GMA05XR71A153MA01#	p254	
				22000pF		±20%	GMA05XR71A223MA01#	p254	
			R	6800pF		±20%	GMA05XR11A682MA01#	p254	
				10000pF		±20%	GMA05XR11A103MA01#	p254	
				15000pF	±20%	GMA05XR11A153MA01#	p254		
				22000pF	±20%	GMA05XR11A223MA01#	p254		
				B	6800pF	±20%	GMA05XB11A682MA01#	p254	
	10000pF				±20%	GMA05XB11A103MA01#	p254		
	15000pF		±20%		GMA05XB11A153MA01#	p254			
	22000pF		±20%		GMA05XB11A223MA01#	p254			
	6.3Vdc	X5R	0.10μF		±20%	GMA05XR60J104ME12#	p252		
			B		0.10μF	±20%	GMA05XB30J104ME12#	p252	

0.8×0.8mm

T max.	Rated Voltage	TC Code	Cap.	Tol.	Part Number	p*
0.6mm	100Vdc	X7R	1500pF	±20%	GMA085R72A152MA01#	p254
			2200pF	±20%	GMA085R72A222MA01#	p254

T max.	Rated Voltage	TC Code	Cap.	Tol.	Part Number	p*	
0.6mm	100Vdc	X7R	3300pF	±20%	GMA085R72A332MA01#	p254	
			4700pF	±20%	GMA085R72A472MA01#	p254	
			6800pF	±20%	GMA085R72A682MA01#	p254	
		X7R	10000pF	±20%	GMA085R71E103MA11#	p254	
			15000pF	±20%	GMA085R71E153MA11#	p254	
			22000pF	±20%	GMA085R71E223MA11#	p254	
	B		10000pF	±20%	GMA085B31E103MA11#	p254	
			15000pF	±20%	GMA085B31E153MA11#	p254	
			22000pF	±20%	GMA085B31E223MA11#	p254	
	10Vdc	X7R	33000pF	±20%	GMA085R71A333MA01#	p254	
			47000pF	±20%	GMA085R71A473MA01#	p254	
			68000pF	±20%	GMA085R71A683MA01#	p254	
			0.10μF	±20%	GMA085R71A104MA01#	p254	
			R	33000pF	±20%	GMA085R11A333MA01#	p254
				47000pF	±20%	GMA085R11A473MA01#	p254
		68000pF		±20%	GMA085R11A683MA01#	p254	
		0.10μF		±20%	GMA085R11A104MA01#	p254	
		B		33000pF	±20%	GMA085B11A333MA01#	p254
				47000pF	±20%	GMA085B11A473MA01#	p254
			68000pF	±20%	GMA085B11A683MA01#	p254	
			0.10μF	±20%	GMA085B11A104MA01#	p254	
	6.3Vdc		X5R	0.47μF	±20%	GMA085R60J474ME12#	p252
				B	0.47μF	±20%	GMA085B30J474ME12#

*: Refers to the page of the "Specifications and Test Methods".

Part number # indicates the package specification code.

1

GMA Series Specifications and Test Methods (1)

No	Item	Specification	Test Method (Ref. Standard: JIS C 5101, IEC60384)														
1	Rated Voltage	Shown in Rated value.	The rated voltage is defined as the maximum voltage which may be applied continuously to the capacitor. When AC voltage is superimposed on DC voltage, V ^{P-P} or V ^{O-P} , whichever is larger, should be maintained within the rated voltage range.														
2	Appearance	No defects or abnormalities.	Visual inspection.														
3	Dimension	Within the specified dimensions.	Using Measuring instrument of dimension.														
4	Voltage Proof	No defects or abnormalities.	Measurement Point: Between the terminations Test Voltage: 250% of the rated voltage Applied Time: 1 to 5s Charge/discharge current: 50mA max.														
5	Insulation Resistance (I.R.)	More than 2000MΩ or 50Ω · F (Whichever is smaller)	Measurement Point: Between the terminations Measurement Voltage: DC Rated Voltage Charging Time: 1min Charge/discharge current: 50mA max. Measurement Temperature: Room Temperature														
6	Capacitance	Shown in Rated value.	Measurement Temperature: Room Temperature														
7	Dissipation Factor (D.F.)	0.1 max.	<table border="1"> <thead> <tr> <th>Capacitance</th> <th>Frequency</th> <th>Voltage</th> </tr> </thead> <tbody> <tr> <td>C ≤ 10μF (6.3V max.)</td> <td>1.0±0.1kHz</td> <td>0.5±0.1Vrms</td> </tr> </tbody> </table>	Capacitance	Frequency	Voltage	C ≤ 10μF (6.3V max.)	1.0±0.1kHz	0.5±0.1Vrms								
Capacitance	Frequency	Voltage															
C ≤ 10μF (6.3V max.)	1.0±0.1kHz	0.5±0.1Vrms															
8	Temperature Characteristics of Capacitance	No Bias B3: Within ±10% (-25 to +85°C) R6: Within ±15% (-55 to +85°C) C8: Within ±22% (-55 to +105°C)	<p>The capacitance change should be measured after 5 minutes at each specified temp. stage. Capacitance value as a reference is the value in step 3.</p> <table border="1"> <thead> <tr> <th>Step</th> <th>Temperature (°C)</th> <th>Applying Voltage (VDC)</th> </tr> </thead> <tbody> <tr> <td>1</td> <td>Reference Temp. ±2</td> <td rowspan="5">No bias</td> </tr> <tr> <td>2</td> <td>Min. Operating Temp. ±3</td> </tr> <tr> <td>3</td> <td>Reference Temp. ±2</td> </tr> <tr> <td>4</td> <td>Max. Operating Temp. ±3</td> </tr> <tr> <td>5</td> <td>Reference Temp. ±2</td> </tr> </tbody> </table> <p>• Initial measurement Perform a heat treatment at 150+0/-10°C for 1h and then let sit for 24±2h at room temperature, then measure.</p>	Step	Temperature (°C)	Applying Voltage (VDC)	1	Reference Temp. ±2	No bias	2	Min. Operating Temp. ±3	3	Reference Temp. ±2	4	Max. Operating Temp. ±3	5	Reference Temp. ±2
Step	Temperature (°C)	Applying Voltage (VDC)															
1	Reference Temp. ±2	No bias															
2	Min. Operating Temp. ±3																
3	Reference Temp. ±2																
4	Max. Operating Temp. ±3																
5	Reference Temp. ±2																
9	Adhesive Strength of Termination	Bond Strength	Pull force: 0.03N min. MIL-STD-883 Method 2011 Condition D Mount the capacitor on a gold metalized alumina substrate with Au-20Sn and bond a ø25μm (ø0.001 inch) gold wire to the capacitor terminal using an ultrasonic ball bond. Then, pull wire.														
		Die Shear Strength	Die Shear force: 2N min. MIL-STD-883 Method 2019 Mount the capacitor on a gold metalized alumina substrate with Au-20Sn. Apply the force parallel to the substrate.														
10	Vibration *	Appearance	No defects or abnormalities.														
		Capacitance	Within the specified initial value.														
		D.F.	Within the specified initial value.														
11	Temperature Sudden Change *	Appearance	No defects or abnormalities.														
		Capacitance Change	Within ±7.5%														
		D.F.	Within the specified initial value.														
		I.R.	Within the specified initial value.														
		Voltage Proof	No defects.														

Continued on the following page. ↗

- GRM
- GR3
- GRJ
- GR4
- GR7
- GJM
- GQM
- GA2
- GA3 GB
- GA3 GD
- GA3 GF
- LLL
- LLA
- LLM
- LLR
- NFM
- KRM
- KR3
- GMA
- GMD
- ⚠️Caution /Notice

GMA Series Specifications and Test Methods (1)

Continued from the preceding page. ↘

No	Item	Specification	Test Method (Ref. Standard: JIS C 5101, IEC60384)	
12	High Temperature High Humidity (Steady) *	Appearance	No defects or abnormalities.	
	Capacitance Change	Within $\pm 12.5\%$	Test Temperature: $40\pm 2^\circ\text{C}$ Test Humidity: 90 to 95%RH Test Time: $500\pm 12\text{h}$ Applied Voltage: DC Rated Voltage Charge/discharge current: 50mA max.	
	D.F.	0.2 max.	• Initial measurement	
	I.R.	More than $500\text{M}\Omega$ or $12.5\Omega \cdot \text{F}$ (Whichever is smaller)	Perform a heat treatment at $150+0/-10^\circ\text{C}$ for 1h and then let sit for $24\pm 2\text{h}$ at room temperature, then measure. • Measurement after test Perform a heat treatment at $150+0/-10^\circ\text{C}$ for 1h and then let sit for $24\pm 2\text{h}$ at room temperature, then measure.	
13	Durability *	Appearance	No defects or abnormalities.	
		Capacitance Change	Within $\pm 12.5\%$	Test Temperature: Max. Operating Temp. $\pm 3^\circ\text{C}$ Test Time: $1000\pm 12\text{h}$ Applied Voltage: 150% of the rated voltage Charge/discharge current: 50mA max.
		D.F.	0.2 max.	• Initial measurement
		I.R.	More than $1000\text{M}\Omega$ or $25\Omega \cdot \text{F}$ (Whichever is smaller)	Perform a heat treatment at $150+0/-10^\circ\text{C}$ for 1h and then let sit for $24\pm 2\text{h}$ at room temperature, then measure. • Measurement after test Perform a heat treatment at $150+0/-10^\circ\text{C}$ for 1h and then let sit for $24\pm 2\text{h}$ at room temperature, then measure.

* Mounting for testing: The capacitors should be mounted on the substrate as shown below using die bonding and wire bonding when tests No.10 to 13 are performed.

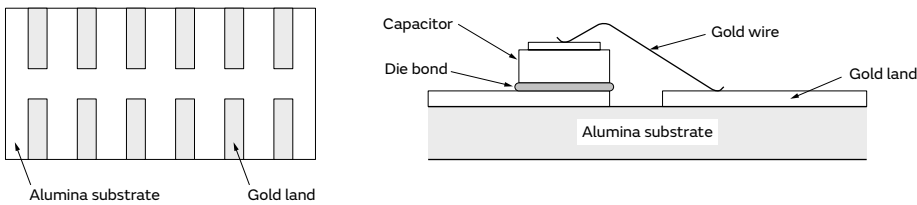

GRM
 GR3
 GRJ
 GR4
 GR7
 GJM
 GQM
 GA2
 GA3 GB
 GA3 GD
 GA3 GF
 LLL
 LLA
 LLM
 LLR
 NFM
 KPM
 KR3
 GMA
 GMD
 ⚠Caution / Notice

2

GMA Series Specifications and Test Methods (2)

No	Item	Specification	Test Method (Ref. Standard: JIS C 5101, IEC60384)																					
1	Rated Voltage	Shown in Rated value.	The rated voltage is defined as the maximum voltage which may be applied continuously to the capacitor. When AC voltage is superimposed on DC voltage, V^P -P or V^O -P, whichever is larger, should be maintained within the rated voltage range.																					
2	Appearance	No defects or abnormalities.	Visual inspection.																					
3	Dimension	Within the specified dimensions.	Using Measuring instrument of dimension.																					
4	Voltage Proof	No defects or abnormalities.	Measurement Point: Between the terminations Test Voltage: 250% of the rated voltage Applied Time: 1 to 5s Charge/discharge current: 50mA max.																					
5	Insulation Resistance (I.R.)	$C \leq 0.047\mu\text{F}$: More than 10000MΩ $C > 0.047\mu\text{F}$: More than $500\Omega \cdot \text{F}$ C: Nominal Capacitance	Measurement Point: Between the terminations Measurement Voltage: DC Rated Voltage Charging Time: 2min Charge/discharge current: 50mA max. Measurement Temperature: Room Temperature																					
6	Capacitance	Shown in Rated value.	Measurement Temperature: Room Temperature Measurement Frequency: $1.0 \pm 0.1\text{kHz}$ Measurement Voltage: $1.0 \pm 0.2\text{Vrms}$																					
7	Dissipation Factor (D.F.)	W.V.: 25Vdc min.: 0.025max. W.V.: 16/10Vdc: 0.035max. W.V.: 6.3Vdc: 0.05max.																						
8	Temperature Characteristics of Capacitance	No Bias	The capacitance change should be measured after 5 minutes at each specified temp. stage. In case of applying voltage, the capacitance change should be measured after 1min with applying voltage in equilibration of each temp. stage. Capacitance value as a reference is the value in step 3.																					
		50% of the Rated Voltage																						
		B1, B3: Within $\pm 10\%$ (-25 to +85°C) R1, R7: Within $\pm 15\%$ (-55 to +125°C)	<table border="1"> <thead> <tr> <th>Step</th> <th>Temperature (°C)</th> <th>Applying Voltage (VDC)</th> </tr> </thead> <tbody> <tr> <td>1</td> <td>Reference Temp. ± 2</td> <td rowspan="4">No bias</td> </tr> <tr> <td>2</td> <td>Min.Operating Temp. ± 3</td> </tr> <tr> <td>3</td> <td>Reference Temp. ± 2</td> </tr> <tr> <td>4</td> <td>Max.Operating Temp. ± 3</td> </tr> <tr> <td>5</td> <td>Reference Temp. ± 2</td> <td rowspan="4">50% of the rated voltage (For B1, R1)</td> </tr> <tr> <td>6</td> <td>Min.Operating Temp. ± 3</td> </tr> <tr> <td>7</td> <td>Reference Temp. ± 2</td> </tr> <tr> <td>8</td> <td>Max.Operating Temp. ± 3</td> </tr> </tbody> </table>	Step	Temperature (°C)	Applying Voltage (VDC)	1	Reference Temp. ± 2	No bias	2	Min.Operating Temp. ± 3	3	Reference Temp. ± 2	4	Max.Operating Temp. ± 3	5	Reference Temp. ± 2	50% of the rated voltage (For B1, R1)	6	Min.Operating Temp. ± 3	7	Reference Temp. ± 2	8	Max.Operating Temp. ± 3
Step	Temperature (°C)	Applying Voltage (VDC)																						
1	Reference Temp. ± 2	No bias																						
2	Min.Operating Temp. ± 3																							
3	Reference Temp. ± 2																							
4	Max.Operating Temp. ± 3																							
5	Reference Temp. ± 2	50% of the rated voltage (For B1, R1)																						
6	Min.Operating Temp. ± 3																							
7	Reference Temp. ± 2																							
8	Max.Operating Temp. ± 3																							
		B1: Within +10/-30% R1: Within +15/-40%	<ul style="list-style-type: none"> Initial measurement Perform a heat treatment at $150 \pm 0/-10^\circ\text{C}$ for 1h and then let sit for $24 \pm 2\text{h}$ at room temperature, then measure. 																					
9	Adhesive Strength of Termination	Bond Strength	MIL-STD-883 Method 2011 Condition D Mount the capacitor on a gold metalized alumina substrate with Au-20Sn and bond a $\phi 25\mu\text{m}$ ($\phi 0.001$ inch) gold wire to the capacitor terminal using an ultrasonic ball bond. Then, pull wire.																					
		Die Shear Strength	MIL-STD-883 Method 2019 Mount the capacitor on a gold metalized alumina substrate with Au-20Sn. Apply the force parallel to the substrate.																					
10	Vibration *	Appearance	Kind of Vibration: A simple harmonic motion 10Hz to 55Hz to 10Hz (1min) Total amplitude: 1.5mm This motion should be applied for a period of 2h in each 3 mutually perpendicular directions (total of 6h).																					
		Capacitance																						
		D.F.																						
11	Temperature Sudden Change *	Appearance	Perform the five cycles according to the four heat treatments shown in the following table.																					
		Capacitance Change																						
		D.F.																						
		I.R.																						
		Voltage Proof																						
		Within $\pm 7.5\%$	<table border="1"> <thead> <tr> <th>Step</th> <th>Temp. (°C)</th> <th>Time (min)</th> </tr> </thead> <tbody> <tr> <td>1</td> <td>Min. Operating Temp. +0/-3</td> <td>30\pm3</td> </tr> <tr> <td>2</td> <td>Room Temp.</td> <td>2 to 3</td> </tr> <tr> <td>3</td> <td>Max. Operating Temp. +3/-0</td> <td>30\pm3</td> </tr> <tr> <td>4</td> <td>Room Temp.</td> <td>2 to 3</td> </tr> </tbody> </table>	Step	Temp. (°C)	Time (min)	1	Min. Operating Temp. +0/-3	30 \pm 3	2	Room Temp.	2 to 3	3	Max. Operating Temp. +3/-0	30 \pm 3	4	Room Temp.	2 to 3						
Step	Temp. (°C)	Time (min)																						
1	Min. Operating Temp. +0/-3	30 \pm 3																						
2	Room Temp.	2 to 3																						
3	Max. Operating Temp. +3/-0	30 \pm 3																						
4	Room Temp.	2 to 3																						
		Within the specified initial value.	<ul style="list-style-type: none"> Initial measurement Perform a heat treatment at $150 \pm 0/-10^\circ\text{C}$ for 1h and then let sit for $24 \pm 2\text{h}$ at room temperature, then measure. 																					
		Within the specified initial value.	Exposure Time: $24 \pm 2\text{h}$																					
		No defects.																						

Continued on the following page. ↗

⚠Caution /Notice

GRM
GR3
GRJ
GR4
GR7
GJM
GQM
GA2
GA3 GB
GA3 GD
GA3 GF
LLL
LLA
LLM
LLR
NFM
KRM
KR3
GMA
GMD

GMA Series Specifications and Test Methods (2)

Continued from the preceding page. ↘

No	Item	Specification	Test Method (Ref. Standard: JIS C 5101, IEC60384)
12	High Temperature High Humidity (Steady) *	Appearance	No defects or abnormalities.
	Capacitance Change	Within $\pm 12.5\%$	Test Temperature: $40\pm 2^\circ\text{C}$ Test Humidity: 90 to 95%RH Test Time: $500\pm 12\text{h}$ Applied Voltage: DC Rated Voltage Charge/discharge current: 50mA max. Exposure Time: $24\pm 2\text{h}$
	D.F.	W.V.: 25Vdc min.: 0.05max. W.V.: 16/10Vdc: 0.05max. W.V.: 6.3Vdc: 0.075max.	
	I.R.	More than $500\text{M}\Omega$ or $25\Omega \cdot \text{F}$ (Whichever is smaller)	
13	Durability *	Appearance	
	Capacitance Change	Within $\pm 12.5\%$	Test Temperature: Max. Operating Temp. $\pm 3^\circ\text{C}$ Test Time: $1000\pm 12\text{h}$ Applied Voltage: 200% of the rated voltage Charge/discharge current: 50mA max. Exposure Time: $24\pm 2\text{h}$ • Initial measurement Apply 200% of the rated DC voltage at the max. operating temp. $\pm 3^\circ\text{C}$ for 1h. Remove and set for $24\pm 2\text{h}$ at room temperature. Perform initial measurement.
	D.F.	W.V.: 25Vdc min.: 0.05max. W.V.: 16/10Vdc: 0.05max. W.V.: 6.3Vdc: 0.075max.	
	I.R.	More than $1000\text{M}\Omega$ or $50\Omega \cdot \text{F}$ (Whichever is smaller)	

* Mounting for testing: The capacitors should be mounted on the substrate as shown below using die bonding and wire bonding when tests No.10 to 13 are performed.

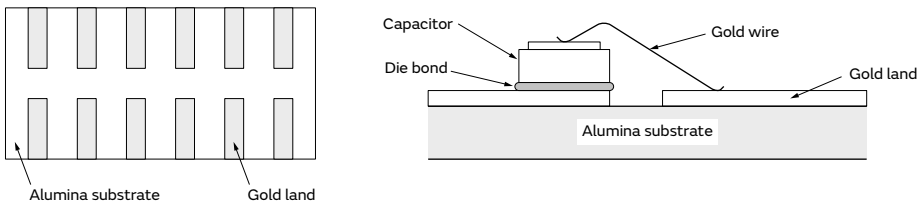

GRM
 GR3
 GRJ
 GR4
 GR7
 GJM
 GQM
 GA2
 GA3 GB
 GA3 GD
 GA3 GF
 LLL
 LLA
 LLM
 LLR
 NFM
 KPM
 KR3
 GMA
 GMD
 ⚠Caution / Notice

Wire Bonding/AuSn Soldering Mount Chip Multilayer Ceramic Capacitors for General Purpose

GMD Series



These capacitors have gold-plated electrodes and are designed specifically for wire bonding and use of gold-tin (AuSn) solder.

Features

① Designed specifically for wire bonding and use of gold-tin (AuSn) solder.

The gold-plated external electrodes make these devices suitable for wire bonding or use of gold tin (AuSn) solder.

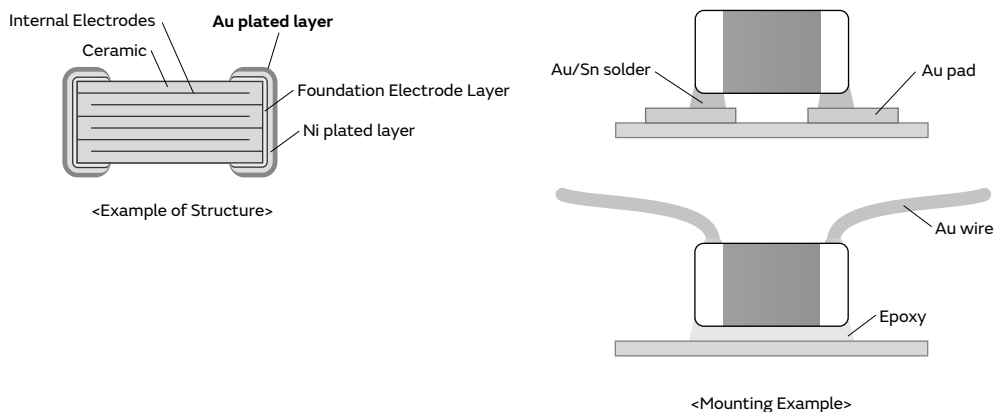

*This product is suitable only for wire bonding or use of gold-tin (AuSn) solder. Other mounting methods should not be used.

② Ideal for mounting in packages, such as optical communication related devices, IC and etc.

Noise can be reduced by eliminating the routing of the wire, and high efficiency can be achieved with a built-in capacitor in the package, such as TO-CAN, IC and etc. by wire bonding mounting.

③ Contributes to the miniaturization of the set.

Murata offers a lineup of small size products, such as the 0603 (0201) and 1005 (0402) in mm (inch).

Specifications

Size (mm)	0.6×0.3mm to 1.0×0.5mm
Rated Voltage	6.3Vdc to 50Vdc
Capacitance	100pF to 1.0μF
Main Applications	Various device related, such as GaAsIC (mounted in IC packages)

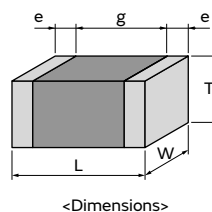

This catalog contains only a portion of the product lineup. Please refer to the capacitor search tool on the Murata Web site for details.

GRM
 GR3
 GRJ
 GR4
 GR7
 GJM
 GQM
 GA2
 GA3 GB
 GA3 GD
 GA3 GF
 LLL
 LLA
 LLM
 LLR
 NFM
 KRM
 KR3
 GMA
 GMD
 ⚠Caution /Notice

GMD Series High Dielectric Constant Type Part Number List

0.6×0.3mm

T max.	Rated Voltage	TC Code	Cap.	Tol.	Part Number	p*			
0.33mm	25Vdc	X7R	100pF	±10%	GMD033R71E101KA01#	p259			
			120pF	±10%	GMD033R71E121KA01#	p259			
			150pF	±10%	GMD033R71E151KA01#	p259			
			180pF	±10%	GMD033R71E181KA01#	p259			
			220pF	±10%	GMD033R71E221KA01#	p259			
			270pF	±10%	GMD033R71E271KA01#	p259			
			330pF	±10%	GMD033R71E331KA01#	p259			
			390pF	±10%	GMD033R71E391KA01#	p259			
			470pF	±10%	GMD033R71E471KA01#	p259			
			560pF	±10%	GMD033R71E561KA01#	p259			
			680pF	±10%	GMD033R71E681KA01#	p259			
			820pF	±10%	GMD033R71E821KA01#	p259			
			1000pF	±10%	GMD033R71E102KA01#	p259			
			1200pF	±10%	GMD033R71E122KA01#	p259			
			1500pF	±10%	GMD033R71E152KA01#	p259			
			R	100pF	±10%	GMD033R11E101KA01#	p259		
				120pF	±10%	GMD033R11E121KA01#	p259		
				150pF	±10%	GMD033R11E151KA01#	p259		
				180pF	±10%	GMD033R11E181KA01#	p259		
				220pF	±10%	GMD033R11E221KA01#	p259		
				270pF	±10%	GMD033R11E271KA01#	p259		
				330pF	±10%	GMD033R11E331KA01#	p259		
				390pF	±10%	GMD033R11E391KA01#	p259		
				470pF	±10%	GMD033R11E471KA01#	p259		
				560pF	±10%	GMD033R11E561KA01#	p259		
				680pF	±10%	GMD033R11E681KA01#	p259		
				820pF	±10%	GMD033R11E821KA01#	p259		
		1000pF		±10%	GMD033R11E102KA01#	p259			
		1200pF		±10%	GMD033R11E122KA01#	p259			
		1500pF		±10%	GMD033R11E152KA01#	p259			
		B		100pF	±10%	GMD033B11E101KA01#	p259		
				120pF	±10%	GMD033B11E121KA01#	p259		
				150pF	±10%	GMD033B11E151KA01#	p259		
				180pF	±10%	GMD033B11E181KA01#	p259		
				220pF	±10%	GMD033B11E221KA01#	p259		
				270pF	±10%	GMD033B11E271KA01#	p259		
				330pF	±10%	GMD033B11E331KA01#	p259		
				390pF	±10%	GMD033B11E391KA01#	p259		
				470pF	±10%	GMD033B11E471KA01#	p259		
				560pF	±10%	GMD033B11E561KA01#	p259		
				680pF	±10%	GMD033B11E681KA01#	p259		
				820pF	±10%	GMD033B11E821KA01#	p259		
			1000pF	±10%	GMD033B11E102KA01#	p259			
			1200pF	±10%	GMD033B11E122KA01#	p259			
			1500pF	±10%	GMD033B11E152KA01#	p259			
			16Vdc	X7R	1800pF	±10%	GMD033R71C182KA11#	p259	
					2200pF	±10%	GMD033R71C222KA11#	p259	
					2700pF	±10%	GMD033R71C272KA11#	p259	
					3300pF	±10%	GMD033R71C332KA11#	p259	
					R	1800pF	±10%	GMD033R11C182KA11#	p259
						2200pF	±10%	GMD033R11C222KA11#	p259
						2700pF	±10%	GMD033R11C272KA11#	p259
						3300pF	±10%	GMD033R11C332KA11#	p259

T max.	Rated Voltage	TC Code	Cap.	Tol.	Part Number	p*		
0.33mm	16Vdc	R	3300pF	±10%	GMD033R11C332KA11#	p259		
			B	1800pF	±10%	GMD033B31C182KA11#	p259	
				2200pF	±10%	GMD033B31C222KA11#	p259	
				2700pF	±10%	GMD033B31C272KA11#	p259	
		3300pF	±10%	GMD033B31C332KA11#	p259			
		10Vdc	X7R	3900pF	±10%	GMD033R71A392KA01#	p259	
				4700pF	±10%	GMD033R71A472KA01#	p259	
				5600pF	±10%	GMD033R71A562KA01#	p259	
				6800pF	±10%	GMD033R71A682KA01#	p259	
				8200pF	±10%	GMD033R71A822KA01#	p259	
				10000pF	±10%	GMD033R71A103KA01#	p259	
				R	3900pF	±10%	GMD033R11A392KA01#	p259
					4700pF	±10%	GMD033R11A472KA01#	p259
					5600pF	±10%	GMD033R11A562KA01#	p259
					6800pF	±10%	GMD033R11A682KA01#	p259
	8200pF		±10%		GMD033R11A822KA01#	p259		
	6.3Vdc		X5R	56000pF	±10%	GMD033R60J563KE11#	p261	
				68000pF	±10%	GMD033R60J683KE11#	p261	
				82000pF	±10%	GMD033R60J823KE11#	p261	
				0.10μF	±10%	GMD033R60J104KE11#	p261	
		B		56000pF	±10%	GMD033B30J563KE11#	p261	
				68000pF	±10%	GMD033B30J683KE11#	p261	
			82000pF	±10%	GMD033B30J823KE11#	p261		
			0.10μF	±10%	GMD033B30J104KE11#	p261		

1.0×0.5mm

T max.	Rated Voltage	TC Code	Cap.	Tol.	Part Number	p*	
0.55mm	50Vdc	X7R	220pF	±10%	GMD155R71H221KA01#	p259	
			270pF	±10%	GMD155R71H271KA01#	p259	
			330pF	±10%	GMD155R71H331KA01#	p259	
			390pF	±10%	GMD155R71H391KA01#	p259	
			470pF	±10%	GMD155R71H471KA01#	p259	
			560pF	±10%	GMD155R71H561KA01#	p259	
			680pF	±10%	GMD155R71H681KA01#	p259	
			820pF	±10%	GMD155R71H821KA01#	p259	
			1000pF	±10%	GMD155R71H102KA01#	p259	
			1200pF	±10%	GMD155R71H122KA01#	p259	
			1500pF	±10%	GMD155R71H152KA01#	p259	
			1800pF	±10%	GMD155R71H182KA01#	p259	
			2200pF	±10%	GMD155R71H222KA01#	p259	
			2700pF	±10%	GMD155R71H272KA01#	p259	
			3300pF	±10%	GMD155R71H332KA01#	p259	
			3900pF	±10%	GMD155R71H392KA01#	p259	
			4700pF	±10%	GMD155R71H472KA01#	p259	
			R	220pF	±10%	GMD155R11H221KA01#	p259

*: Refers to the page of the "Specifications and Test Methods".

Part number # indicates the package specification code.

GMD Series High Dielectric Constant Type Part Number List

(→ 1.0×0.5mm)

T max.	Rated Voltage	TC Code	Cap.	Tol.	Part Number	p*		
0.55mm	50Vdc	R	270pF	±10%	GMD155R11H271KA01#	p259		
			330pF	±10%	GMD155R11H331KA01#	p259		
			390pF	±10%	GMD155R11H391KA01#	p259		
			470pF	±10%	GMD155R11H471KA01#	p259		
			560pF	±10%	GMD155R11H561KA01#	p259		
			680pF	±10%	GMD155R11H681KA01#	p259		
			820pF	±10%	GMD155R11H821KA01#	p259		
			1000pF	±10%	GMD155R11H102KA01#	p259		
			1200pF	±10%	GMD155R11H122KA01#	p259		
			1500pF	±10%	GMD155R11H152KA01#	p259		
			1800pF	±10%	GMD155R11H182KA01#	p259		
			2200pF	±10%	GMD155R11H222KA01#	p259		
			2700pF	±10%	GMD155R11H272KA01#	p259		
			3300pF	±10%	GMD155R11H332KA01#	p259		
			3900pF	±10%	GMD155R11H392KA01#	p259		
			4700pF	±10%	GMD155R11H472KA01#	p259		
			B	220pF	±10%	GMD155B11H221KA01#	p259	
				270pF	±10%	GMD155B11H271KA01#	p259	
				330pF	±10%	GMD155B11H331KA01#	p259	
				390pF	±10%	GMD155B11H391KA01#	p259	
		470pF		±10%	GMD155B11H471KA01#	p259		
		560pF		±10%	GMD155B11H561KA01#	p259		
		680pF		±10%	GMD155B11H681KA01#	p259		
		820pF		±10%	GMD155B11H821KA01#	p259		
		1000pF		±10%	GMD155B11H102KA01#	p259		
		1200pF		±10%	GMD155B11H122KA01#	p259		
		1500pF		±10%	GMD155B11H152KA01#	p259		
		1800pF		±10%	GMD155B11H182KA01#	p259		
		2200pF		±10%	GMD155B11H222KA01#	p259		
		2700pF		±10%	GMD155B11H272KA01#	p259		
		3300pF		±10%	GMD155B11H332KA01#	p259		
		3900pF		±10%	GMD155B11H392KA01#	p259		
		4700pF		±10%	GMD155B11H472KA01#	p259		
		X7R		25Vdc	5600pF	±10%	GMD155R71E562KA01#	p259
					6800pF	±10%	GMD155R71E682KA01#	p259
					8200pF	±10%	GMD155R71E822KA01#	p259
					10000pF	±10%	GMD155R71E103KA01#	p259
					12000pF	±10%	GMD155R71E123KA01#	p259
					15000pF	±10%	GMD155R71E153KA01#	p259
					18000pF	±10%	GMD155R71E183KA01#	p259
					22000pF	±10%	GMD155R71E223KA01#	p259
					27000pF	±10%	GMD155R71E273KA11#	p259
					33000pF	±10%	GMD155R71E333KA11#	p259
			39000pF		±10%	GMD155R71E393KA11#	p259	
			47000pF		±10%	GMD155R71E473KA11#	p259	
			R		5600pF	±10%	GMD155R11E562KA01#	p259
					6800pF	±10%	GMD155R11E682KA01#	p259
8200pF	±10%				GMD155R11E822KA01#	p259		
10000pF	±10%				GMD155R11E103KA01#	p259		
12000pF	±10%				GMD155R11E123KA01#	p259		
15000pF	±10%				GMD155R11E153KA01#	p259		
18000pF	±10%				GMD155R11E183KA01#	p259		
22000pF	±10%				GMD155R11E223KA01#	p259		
27000pF	±10%	GMD155R11E273KA11#		p259				

T max.	Rated Voltage	TC Code	Cap.	Tol.	Part Number	p*		
0.55mm	25Vdc	R	33000pF	±10%	GMD155R11E333KA11#	p259		
			39000pF	±10%	GMD155R11E393KA11#	p259		
			47000pF	±10%	GMD155R11E473KA11#	p259		
			B	5600pF	±10%	GMD155B11E562KA01#	p259	
				6800pF	±10%	GMD155B11E682KA01#	p259	
				8200pF	±10%	GMD155B11E822KA01#	p259	
				10000pF	±10%	GMD155B11E103KA01#	p259	
				12000pF	±10%	GMD155B11E123KA01#	p259	
				15000pF	±10%	GMD155B11E153KA01#	p259	
				18000pF	±10%	GMD155B11E183KA01#	p259	
		22000pF		±10%	GMD155B11E223KA01#	p259		
		27000pF		±10%	GMD155B31E273KA11#	p259		
		33000pF		±10%	GMD155B31E333KA11#	p259		
		39000pF	±10%	GMD155B31E393KA11#	p259			
		47000pF	±10%	GMD155B31E473KA11#	p259			
		16Vdc	X7R	56000pF	±10%	GMD155R71C563KA11#	p259	
				68000pF	±10%	GMD155R71C683KA11#	p259	
				82000pF	±10%	GMD155R71C823KA11#	p259	
				0.10μF	±10%	GMD155R71C104KA11#	p259	
				R	56000pF	±10%	GMD155R11C563KA11#	p259
	68000pF				±10%	GMD155R11C683KA11#	p259	
	82000pF				±10%	GMD155R11C823KA11#	p259	
	0.10μF				±10%	GMD155R11C104KA11#	p259	
	B				56000pF	±10%	GMD155B31C563KA11#	p259
					68000pF	±10%	GMD155B31C683KA11#	p259
			82000pF		±10%	GMD155B31C823KA11#	p259	
			0.10μF	±10%	GMD155B31C104KA11#	p259		
			10Vdc	X5R	0.12μF	±10%	GMD155R61A124KE12#	p261
					0.15μF	±10%	GMD155R61A154KE12#	p261
	0.18μF				±10%	GMD155R61A184KE12#	p261	
	0.22μF				±10%	GMD155R61A224KE12#	p261	
	0.27μF				±10%	GMD155R61A274KE11#	p263	
	0.33μF	±10%			GMD155R61A334KE11#	p263		
	0.39μF	±10%			GMD155R61A394KE11#	p263		
	0.47μF	±10%			GMD155R61A474KE11#	p263		
	B	0.12μF			±10%	GMD155B31A124KE12#	p261	
		0.15μF			±10%	GMD155B31A154KE12#	p261	
		0.18μF	±10%	GMD155B31A184KE12#	p261			
		0.22μF	±10%	GMD155B31A224KE12#	p261			
		0.27μF	±10%	GMD155B31A274KE11#	p263			
		0.33μF	±10%	GMD155B31A334KE11#	p263			
		0.39μF	±10%	GMD155B31A394KE11#	p263			
		0.47μF	±10%	GMD155B31A474KE11#	p263			

*: Refers to the page of the "Specifications and Test Methods".

Part number # indicates the package specification code.

1

GMD Series Specifications and Test Methods (1)

No	Item	Specification	Test Method (Ref. Standard: JIS C 5101, IEC60384)																					
1	Rated Voltage	Shown in Rated value.	The rated voltage is defined as the maximum voltage which may be applied continuously to the capacitor. When AC voltage is superimposed on DC voltage, V^P -P or V^O -P, whichever is larger, should be maintained within the rated voltage range.																					
2	Appearance	No defects or abnormalities.	Visual inspection.																					
3	Dimension	Within the specified dimensions.	Using Measuring instrument of dimension.																					
4	Voltage Proof	No defects or abnormalities.	Measurement Point: Between the terminations Test Voltage: 250% of the rated voltage Applied Time: 1 to 5s Charge/discharge current: 50mA max.																					
5	Insulation Resistance (I.R.)	$C \leq 0.047\mu\text{F}$: More than 10000M Ω $C > 0.047\mu\text{F}$: More than $500\Omega \cdot \text{F}$ C: Nominal Capacitance	Measurement Point: Between the terminations Measurement Voltage: DC Rated Voltage Charging Time: 2min Charge/discharge current: 50mA max. Measurement Temperature: Room Temperature																					
6	Capacitance	Shown in Rated value.	Measurement Temperature: Room Temperature																					
7	Dissipation Factor (D.F.)	W.V.: 25Vdc min.: 0.025max. W.V.: 16/10Vdc: 0.035max.	Measurement Frequency: 1.0 \pm 0.1kHz Measurement Voltage: 1.0 \pm 0.2Vrms																					
8	Temperature Characteristics of Capacitance	No Bias	The capacitance change should be measured after 5 minutes at each specified temp. stage. In case of applying voltage, the capacitance change should be measured after 1 minute with applying voltage in equilibration of each temp. stage. Capacitance value as a reference is the value in step 3.																					
		50% of the Rated Voltage																						
			<table border="1"> <thead> <tr> <th>Step</th> <th>Temperature (°C)</th> <th>Applying Voltage (VDC)</th> </tr> </thead> <tbody> <tr> <td>1</td> <td>Reference Temp. ± 2</td> <td rowspan="4">No bias</td> </tr> <tr> <td>2</td> <td>Min. Operating Temp. ± 3</td> </tr> <tr> <td>3</td> <td>Reference Temp. ± 2</td> </tr> <tr> <td>4</td> <td>Max. Operating Temp. ± 3</td> </tr> <tr> <td>5</td> <td>Reference Temp. ± 2</td> <td rowspan="4">50% of the rated voltage (For B1, R1)</td> </tr> <tr> <td>6</td> <td>Min. Operating Temp. ± 3</td> </tr> <tr> <td>7</td> <td>Reference Temp. ± 2</td> </tr> <tr> <td>8</td> <td>Max. Operating Temp. ± 3</td> </tr> </tbody> </table>	Step	Temperature (°C)	Applying Voltage (VDC)	1	Reference Temp. ± 2	No bias	2	Min. Operating Temp. ± 3	3	Reference Temp. ± 2	4	Max. Operating Temp. ± 3	5	Reference Temp. ± 2	50% of the rated voltage (For B1, R1)	6	Min. Operating Temp. ± 3	7	Reference Temp. ± 2	8	Max. Operating Temp. ± 3
Step	Temperature (°C)	Applying Voltage (VDC)																						
1	Reference Temp. ± 2	No bias																						
2	Min. Operating Temp. ± 3																							
3	Reference Temp. ± 2																							
4	Max. Operating Temp. ± 3																							
5	Reference Temp. ± 2	50% of the rated voltage (For B1, R1)																						
6	Min. Operating Temp. ± 3																							
7	Reference Temp. ± 2																							
8	Max. Operating Temp. ± 3																							
9	Adhesive Strength of Termination	Bond Strength	MIL-STD-883 Method 2011 Condition D Mount the capacitor on a gold metalized alumina substrate with Au-20Sn and bond a $\phi 25\mu\text{m}$ ($\phi 0.001$ inch) gold wire to the capacitor terminal using an ultrasonic ball bond. Then, pull wire.																					
		Die Shear Strength	MIL-STD-883 Method 2019 Mount the capacitor on a gold metalized alumina substrate with Au-20Sn. Apply the force parallel to the substrate.																					
10	Vibration *	Appearance	Kind of Vibration: A simple harmonic motion 10Hz to 55Hz to 10Hz (1min) Total amplitude: 1.5mm This motion should be applied for a period of 2h in each 3 mutually perpendicular directions (total of 6h).																					
		Capacitance																						
		D.F.																						
11	Temperature Sudden Change *	Appearance	Perform the five cycles according to the four heat treatments shown in the following table.																					
		Capacitance Change																						
		D.F.																						
		I.R.																						
		Voltage Proof	No defects.																					
			<table border="1"> <thead> <tr> <th>Step</th> <th>Temp. (°C)</th> <th>Time (min)</th> </tr> </thead> <tbody> <tr> <td>1</td> <td>Min. Operating Temp. +0/-3</td> <td>30\pm3</td> </tr> <tr> <td>2</td> <td>Room Temp.</td> <td>2 to 3</td> </tr> <tr> <td>3</td> <td>Max. Operating Temp. +3/-0</td> <td>30\pm3</td> </tr> <tr> <td>4</td> <td>Room Temp.</td> <td>2 to 3</td> </tr> </tbody> </table>	Step	Temp. (°C)	Time (min)	1	Min. Operating Temp. +0/-3	30 \pm 3	2	Room Temp.	2 to 3	3	Max. Operating Temp. +3/-0	30 \pm 3	4	Room Temp.	2 to 3						
Step	Temp. (°C)	Time (min)																						
1	Min. Operating Temp. +0/-3	30 \pm 3																						
2	Room Temp.	2 to 3																						
3	Max. Operating Temp. +3/-0	30 \pm 3																						
4	Room Temp.	2 to 3																						

Continued on the following page. ↗

GRM
GR3
GRJ
GR4
GR7
GJM
GQM
GA2
GA3 GB
GA3 GD
GA3 GF
LLL
LLA
LLM
LLR
NFM
KPM
KR3
GMA
GMD
⚠Caution / Notice

GMD Series Specifications and Test Methods (1)

Continued from the preceding page. ↘

No	Item	Specification	Test Method (Ref. Standard: JIS C 5101, IEC60384)
12	High Temperature High Humidity (Steady) *	Appearance	No defects or abnormalities.
		Capacitance Change	Within $\pm 12.5\%$
		D.F.	0.05max.
		I.R.	More than $500M\Omega$ or $25\Omega \cdot F$ (Whichever is smaller)
13	Durability *	Appearance	No defects or abnormalities.
		Capacitance Change	Within $\pm 12.5\%$
		D.F.	0.05max.
		I.R.	More than $1000M\Omega$ or $50\Omega \cdot F$ (Whichever is smaller)
			Test Temperature: $40\pm 2^\circ C$ Test Humidity: 90 to 95%RH Test Time: $500\pm 12h$ Applied Voltage: DC Rated Voltage Charge/discharge current: 50mA max. Exposure Time: $24\pm 2h$
			Test Temperature: Max. Operating Temp. $\pm 3^\circ C$ Test Time: $1000\pm 12h$ Applied Voltage: 200% of the rated voltage Charge/discharge current: 50mA max. Exposure Time: $24\pm 2h$ • Initial measurement Apply 200% of the rated DC voltage at the max. operating temp. $\pm 3^\circ C$ for 1h. Remove and set for $24\pm 2h$ at room temperature. Perform initial measurement.

* Mounting for testing: The capacitors should be mounted on the substrate as shown below using die bonding and wire bonding when tests No.10 to 13 are performed.

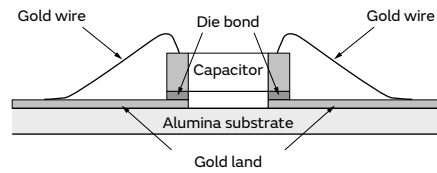
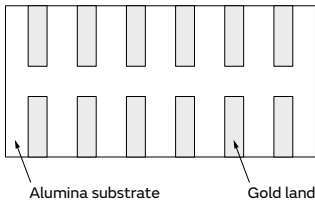

GRM
 GR3
 GRJ
 GR4
 GR7
 GJM
 GQM
 GA2
 GA3 GB
 GA3 GD
 GA3 GF
 LLL
 LLA
 LLM
 LLR
 NFM
 KRM
 KR3
 GMA
GMD
 ⚠Caution /Notice

2

GMD Series Specifications and Test Methods (2)

No	Item	Specification	Test Method (Ref. Standard: JIS C 5101, IEC60384)											
1	Rated Voltage	Shown in Rated value.	The rated voltage is defined as the maximum voltage which may be applied continuously to the capacitor. When AC voltage is superimposed on DC voltage, V^P -P or V^O -P, whichever is larger, should be maintained within the rated voltage range.											
2	Appearance	No defects or abnormalities.	Visual inspection.											
3	Dimension	Within the specified dimensions.	Using Measuring instrument of dimension.											
4	Voltage Proof	No defects or abnormalities.	Measurement Point: Between the terminations Test Voltage: 250% of the rated voltage Applied Time: 1 to 5s Charge/discharge current: 50mA max.											
5	Insulation Resistance (I.R.)	More than 2000MΩ or 50Ω • F (Whichever is smaller)	Measurement Point: Between the terminations Measurement Voltage: DC Rated Voltage Charging Time: 1min Charge/discharge current: 50mA max. Measurement Temperature: Room Temperature											
6	Capacitance	Shown in Rated value.	Measurement Temperature: Room Temperature											
7	Dissipation Factor (D.F.)	0.1 max.	<table border="1"> <thead> <tr> <th>Capacitance</th> <th>Frequency</th> <th>Voltage</th> </tr> </thead> <tbody> <tr> <td>*1 C ≤ 10μF (10V min.)</td> <td>1.0±0.1kHz</td> <td>1.0±0.2Vrms</td> </tr> <tr> <td>C ≤ 10μF (6.3V max.)</td> <td>1.0±0.1kHz</td> <td>0.5±0.1Vrms</td> </tr> </tbody> </table>	Capacitance	Frequency	Voltage	*1 C ≤ 10μF (10V min.)	1.0±0.1kHz	1.0±0.2Vrms	C ≤ 10μF (6.3V max.)	1.0±0.1kHz	0.5±0.1Vrms		
			Capacitance	Frequency	Voltage									
*1 C ≤ 10μF (10V min.)	1.0±0.1kHz	1.0±0.2Vrms												
C ≤ 10μF (6.3V max.)	1.0±0.1kHz	0.5±0.1Vrms												
			*1 GMD155 B3/R6 1A 124 to 224 are applied to 0.5±0.1Vrms											
8	Temperature Characteristics of Capacitance	No Bias B3: Within ±10% (-25 to +85°C) R6: Within ±15% (-55 to +85°C)	The capacitance change should be measured after 5 minutes at each specified temp. stage. Capacitance value as a reference is the value in step 3.											
			<table border="1"> <thead> <tr> <th>Step</th> <th>Temperature (°C)</th> <th>Applying Voltage (VDC)</th> </tr> </thead> <tbody> <tr> <td>1</td> <td>Reference Temp. ±2</td> <td rowspan="5">No bias</td> </tr> <tr> <td>2</td> <td>Min. Operating Temp. ±3</td> </tr> <tr> <td>3</td> <td>Reference Temp. ±2</td> </tr> <tr> <td>4</td> <td>Max. Operating Temp. ±3</td> </tr> <tr> <td>5</td> <td>Reference Temp. ±2</td> </tr> </tbody> </table>	Step	Temperature (°C)	Applying Voltage (VDC)	1	Reference Temp. ±2	No bias	2	Min. Operating Temp. ±3	3	Reference Temp. ±2	4
Step	Temperature (°C)	Applying Voltage (VDC)												
1	Reference Temp. ±2	No bias												
2	Min. Operating Temp. ±3													
3	Reference Temp. ±2													
4	Max. Operating Temp. ±3													
5	Reference Temp. ±2													
9	Adhesive Strength of Termination	Bond Strength	MIL-STD-883 Method 2011 Condition D Pull force: 0.03N min. Mount the capacitor on a gold metalized alumina substrate with Au-20Sn and bond a ø25μm (ø0.001 inch) gold wire to the capacitor terminal using an ultrasonic ball bond. Then, pull wire.											
		Die Shear Strength	MIL-STD-883 Method 2019 Mount the capacitor on a gold metalized alumina substrate with Au-20Sn. Apply the force parallel to the substrate.											
10	Vibration *2	Appearance	Kind of Vibration: A simple harmonic motion 10Hz to 55Hz to 10Hz (1min) Total amplitude: 1.5mm This motion should be applied for a period of 2h in each 3 mutually perpendicular directions (total of 6h).											
		Capacitance												
		D.F.												
11	Temperature Sudden Change *2	Appearance	Perform the five cycles according to the four heat treatments shown in the following table.											
		Capacitance Change												
		D.F.												
		I.R.												
		Voltage Proof	No defects.											

Continued on the following page. ↗

GRM
GR3
GRJ
GR4
GR7
GJM
GQM
GA2
GA3 GB
GA3 GD
GA3 GF
LLL
LLA
LLM
LLR
NFM
KPM
KR3
GMA
GMD
△Caution /Notice

GMD Series Specifications and Test Methods (2)

Continued from the preceding page. ↘

No	Item	Specification	Test Method (Ref. Standard: JIS C 5101, IEC60384)	
12	High Temperature High Humidity (Steady) *2	Appearance	Test Temperature: 40±2°C Test Humidity: 90 to 95%RH Test Time: 500±12h Applied Voltage: DC Rated Voltage Charge/discharge current: 50mA max. • Initial measurement Perform a heat treatment at 150+0/-10°C for 1h and then let sit for 24±2h at room temperature, then measure. • Measurement after test Perform a heat treatment at 150+0/-10°C for 1h and then let sit for 24±2h at room temperature, then measure.	
	Capacitance Change	Within ±12.5%		
	D.F.	0.2 max.		
	I.R.	More than 500MΩ or 12.5Ω • F (Whichever is smaller)		
13	Durability *2	Appearance	Test Temperature: Max. Operating Temp. ±3°C Test Time: 1000±12h Applied Voltage: 150% of the rated voltage Charge/discharge current: 50mA max. • Initial measurement Perform a heat treatment at 150+0/-10°C for 1h and then let sit for 24±2h at room temperature, then measure. • Measurement after test Perform a heat treatment at 150+0/-10°C for 1h and then let sit for 24±2h at room temperature, then measure.	
		Capacitance Change		Within ±12.5%
		D.F.		0.2 max.
		I.R.		More than 1000MΩ or 25Ω • F (Whichever is smaller)

*2 Mounting for testing: The capacitors should be mounted on the substrate as shown below using die bonding and wire bonding when tests No.10 to 13 are performed.

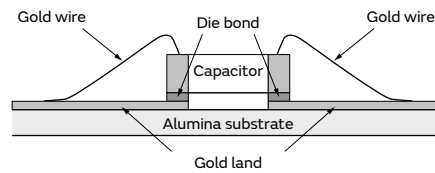
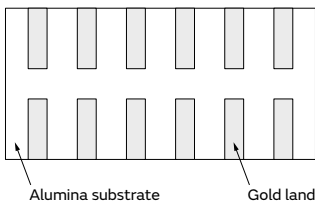

GRM
 GR3
 GRJ
 GR4
 GR7
 GJM
 GQM
 GA2
 GA3 GB
 GA3 GD
 GA3 GF
 LLL
 LLA
 LLM
 LLR
 NFM
 KRM
 KR3
 GMA
 GMD
 ⚠Caution /Notice

3

GMD Series Specifications and Test Methods (3)

No	Item	Specification	Test Method (Ref. Standard: JIS C 5101, IEC60384)											
1	Rated Voltage	Shown in Rated value.	The rated voltage is defined as the maximum voltage which may be applied continuously to the capacitor. When AC voltage is superimposed on DC voltage, V^{P-P} or V^{O-P} , whichever is larger, should be maintained within the rated voltage range.											
2	Appearance	No defects or abnormalities.	Visual inspection.											
3	Dimension	Within the specified dimensions.	Using Measuring instrument of dimension.											
4	Voltage Proof	No defects or abnormalities.	Measurement Point: Between the terminations Test Voltage: 250% of the rated voltage Applied Time: 1 to 5s Charge/discharge current: 50mA max.											
5	Insulation Resistance (I.R.)	More than 2000MΩ or 50Ω · F (Whichever is smaller)	Measurement Point: Between the terminations Measurement Voltage: DC Rated Voltage Charging Time: 1min Charge/discharge current: 50mA max. Measurement Temperature: Room Temperature											
6	Capacitance	Shown in Rated value.	Measurement Temperature: Room Temperature											
7	Dissipation Factor (D.F.)	0.1 max.	<table border="1"> <thead> <tr> <th>Capacitance</th> <th>Frequency</th> <th>Voltage</th> </tr> </thead> <tbody> <tr> <td>*1 C ≤ 10μF (10V min.)</td> <td>1.0±0.1kHz</td> <td>1.0±0.2Vrms</td> </tr> <tr> <td>C ≤ 10μF (6.3V max.)</td> <td>1.0±0.1kHz</td> <td>0.5±0.1Vrms</td> </tr> </tbody> </table>	Capacitance	Frequency	Voltage	*1 C ≤ 10μF (10V min.)	1.0±0.1kHz	1.0±0.2Vrms	C ≤ 10μF (6.3V max.)	1.0±0.1kHz	0.5±0.1Vrms		
			Capacitance	Frequency	Voltage									
*1 C ≤ 10μF (10V min.)	1.0±0.1kHz	1.0±0.2Vrms												
C ≤ 10μF (6.3V max.)	1.0±0.1kHz	0.5±0.1Vrms												
			*1 GMD155 B3/R6 1A 124 to 224 are applied to 0.5±0.1Vrms											
8	Temperature Characteristics of Capacitance	No Bias B3: Within ±10% (-25 to +85°C) R6: Within ±15% (-55 to +85°C)	The capacitance change should be measured after 5 minutes at each specified temp. stage. Capacitance value as a reference is the value in step 3.											
			<table border="1"> <thead> <tr> <th>Step</th> <th>Temperature (°C)</th> <th>Applying Voltage (VDC)</th> </tr> </thead> <tbody> <tr> <td>1</td> <td>Reference Temp. ±2</td> <td rowspan="5">No bias</td> </tr> <tr> <td>2</td> <td>Min. Operating Temp. ±3</td> </tr> <tr> <td>3</td> <td>Reference Temp. ±2</td> </tr> <tr> <td>4</td> <td>Max. Operating Temp. ±3</td> </tr> <tr> <td>5</td> <td>Reference Temp. ±2</td> </tr> </tbody> </table>	Step	Temperature (°C)	Applying Voltage (VDC)	1	Reference Temp. ±2	No bias	2	Min. Operating Temp. ±3	3	Reference Temp. ±2	4
Step	Temperature (°C)	Applying Voltage (VDC)												
1	Reference Temp. ±2	No bias												
2	Min. Operating Temp. ±3													
3	Reference Temp. ±2													
4	Max. Operating Temp. ±3													
5	Reference Temp. ±2													
9	Adhesive Strength of Termination	Bond Strength	MIL-STD-883 Method 2011 Condition D Mount the capacitor on a gold metalized alumina substrate with Au-20Sn and bond a ø25μm (ø0.001 inch) gold wire to the capacitor terminal using an ultrasonic ball bond. Then, pull wire.											
		Die Shear Strength	MIL-STD-883 Method 2019 Mount the capacitor on a gold metalized alumina substrate with Au-20Sn. Apply the force parallel to the substrate.											
10	Vibration *2	Appearance	Kind of Vibration: A simple harmonic motion 10Hz to 55Hz to 10Hz (1min) Total amplitude: 1.5mm This motion should be applied for a period of 2h in each 3 mutually perpendicular directions (total of 6h).											
		Capacitance												
		D.F.												
11	Temperature Sudden Change *2	Appearance	Perform the five cycles according to the four heat treatments shown in the following table.											
		Capacitance Change												
		D.F.												
		I.R.												
		Voltage Proof	No defects.											

Continued on the following page. ↗

GRM
GR3
GRJ
GR4
GR7
GJM
GQM
GA2
GA3 GB
GA3 GD
GA3 GF
LLL
LLA
LLM
LLR
NFM
KPM
KR3
GMA
GMD
△Caution / Notice

GMD Series Specifications and Test Methods (3)

Continued from the preceding page. ↘

No	Item	Specification	Test Method (Ref. Standard: JIS C 5101, IEC60384)
12	High Temperature High Humidity (Steady) *2	Appearance	Test Temperature: 40±2°C Test Humidity: 90 to 95%RH Test Time: 500±12h Applied Voltage: DC Rated Voltage Charge/discharge current: 50mA max. • Initial measurement Perform a heat treatment at 150+0/-10°C for 1h and then let sit for 24±2h at room temperature, then measure. • Measurement after test Perform a heat treatment at 150+0/-10°C for 1h and then let sit for 24±2h at room temperature, then measure.
	Capacitance Change	Within ±12.5%	
	D.F.	0.2 max.	
	I.R.	More than 500MΩ or 12.5Ω · F (Whichever is smaller)	
13	Durability *2	Appearance	Test Temperature: Max. Operating Temp. ±3°C Test Time: 1000±12h Applied Voltage: 120% of the rated voltage Charge/discharge current: 50mA max. • Initial measurement Perform a heat treatment at 150+0/-10°C for 1h and then let sit for 24±2h at room temperature, then measure. • Measurement after test Perform a heat treatment at 150+0/-10°C for 1h and then let sit for 24±2h at room temperature, then measure.
	Capacitance Change	Within ±12.5%	
	D.F.	0.2 max.	
	I.R.	More than 1000MΩ or 25Ω · F (Whichever is smaller)	

*2 Mounting for testing: The capacitors should be mounted on the substrate as shown below using die bonding and wire bonding when tests No.10 to 13 are performed.

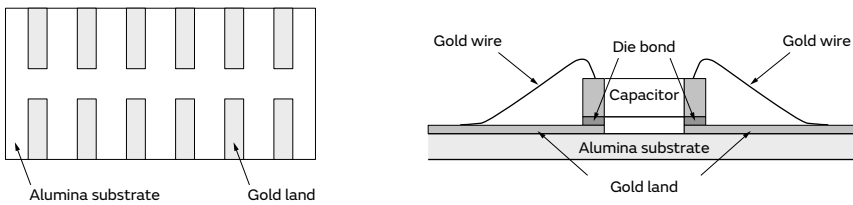

Recommended derating conditions on voltage and temperature

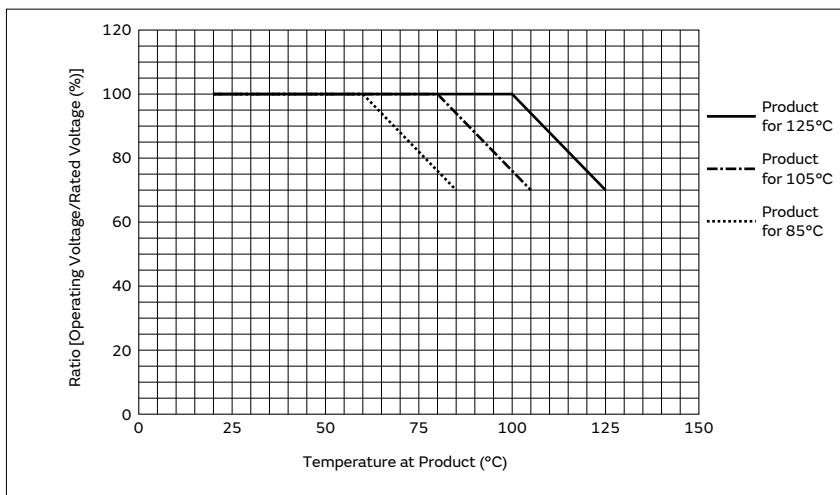

These Part Numbers are designed for use in the circuits where continuous applied voltage to the capacitor is derated than rated voltage, and guarantee Durability Test with 120% × rated voltage as testing voltage at the maximum operating temperature. The voltage and temperature derating conditions on the upside are recommended for use to ensure the same reliability level as normal specification.

GRM
 GR3
 GRJ
 GR4
 GR7
 GJM
 GQM
 GA2
 GA3 GB
 GA3 GD
 GA3 GF
 LLL
 LLA
 LLM
 LLR
 NFM
 KRM
 KR3
 GMA
 GMD
 ⚠Caution /Notice

**GRM, GR3, GRJ, GR4, GR7, GJM,
 GQM, GA2, GA3, LLL, LLA, LLM,
 LLR, NFM, KRM, KR3, GMA, GMD**

⚠️Caution/Notice



⚠️Caution

Notice

Storage and Operation Conditions 266

Rating 266

 1. Temperature Dependent Characteristics 266

 2. Measurement of Capacitance 266

 3. Applied Voltage and Applied Current 267

 4. Type of Applied Voltage and Self-heating Temperature 267

 5. DC Voltage and AC Voltage Characteristics 270

 6. Capacitance Aging 270

 7. Vibration and Shock 271

Soldering and Mounting 271

 1. Mounting Position 271

 2. Information before Mounting 272

 3. Maintenance of the Mounting (pick and place) Machine 272

 4-1. Reflow Soldering 273

 4-2. Flow Soldering 275

 4-3. Correction of Soldered Portion 276

 5. Washing 277

 6. Electrical Test on Printed Circuit Board 277

 7. Printed Circuit Board Cropping 277

 8. Assembly 280

 9. Die Bonding/Wire Bonding 281

Other 281

 1. Under Operation of Equipment 281

 2. Other 282

Rating 283

 1. Operating Temperature 283

 2. Atmosphere Surroundings (gaseous and liquid) 283

 3. Piezo-electric Phenomenon 283

Soldering and Mounting 283

 1. PCB Design 283

 1. Notice for Pattern Forms 283

 2. Land Dimensions 284

 3. Board Design 288

 2. Adhesive Application 288

 3. Adhesive Curing 289

 4. Flux for Flow Soldering 289

 5. Flow Soldering 289

 6. Reflow Soldering 289

 7. Washing 290

 8. Coating 290

Other 290

 1. Transportation 290

 2. Characteristics Evaluation in the Actual System 290

- GRM
- GR3
- GRJ
- GR4
- GR7
- GJM
- GQM
- GA2
- GA3 GB
- GA3 GD
- GA3 GF
- LLL
- LLA
- LLM
- LLR
- NFM
- KRM
- KR3
- GMA
- GMD



Caution

Storage and Operation Conditions

1. The performance of chip multilayer ceramic capacitors and chip EMIFIL NFM series (henceforth just “capacitors”) may be affected by the storage conditions.

Please use them promptly after delivery.

1-1. Maintain appropriate storage for the capacitors using the following conditions: Room Temperature of +5 to +40°C and a Relative Humidity of 20 to 70%.

High temperature and humidity conditions and/or prolonged storage may cause deterioration of the packaging materials. If more than six months have elapsed since delivery, check packaging, mounting, etc. before use.

In addition, this may cause oxidation of the electrodes. If more than one year has elapsed since delivery, also check the solderability before use.

1-2. Corrosive gas can react with the termination (external) electrodes or lead wires of capacitors, and result in poor solderability. Do not store the capacitors in an atmosphere consisting of corrosive gas (e.g., hydrogen sulfide, sulfur dioxide, chlorine, ammonia gas, etc.).

1-3. Due to moisture condensation caused by rapid humidity changes, or the photochemical change caused by direct sunlight on the terminal electrodes and/or the resin/epoxy coatings, the solderability and electrical performance may deteriorate. Do not store capacitors under direct sunlight or in high humidity conditions.

Rating

1. Temperature Dependent Characteristics

1. The electrical characteristics of a capacitor can change with temperature.

1-1. For capacitors having larger temperature dependency, the capacitance may change with temperature changes.

The following actions are recommended in order to ensure suitable capacitance values.

(1) Select a suitable capacitance for the operating temperature range.

(2) The capacitance may change within the rated temperature.

When you use a high dielectric constant type capacitor in a circuit that needs a tight (narrow) capacitance tolerance (e.g., a time-constant circuit), please carefully consider the temperature characteristics, and carefully confirm the various characteristics in actual use conditions and the actual system.

[Example of Temperature Characteristics X7R (R7)]
 Sample: 0.1μF, Rated Voltage 50VDC

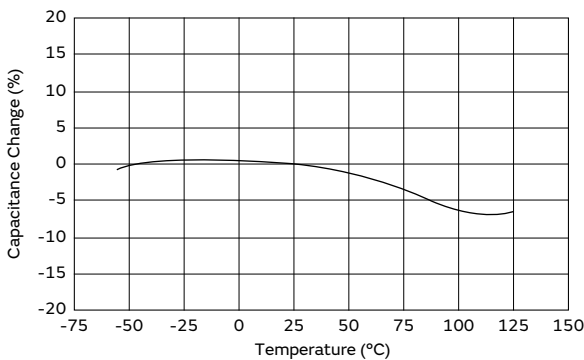

[Example of Temperature Characteristics X5R (R6)]
 Sample: 22μF, Rated Voltage 4VDC

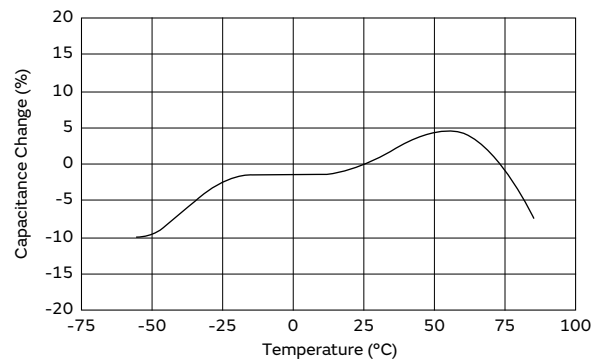

2. Measurement of Capacitance

1. Measure capacitance with the voltage and frequency specified in the product specifications.

1-1. The output voltage of the measuring equipment may decrease occasionally when capacitance is high. Please confirm whether a prescribed measured voltage is impressed to the capacitor.

1-2. The capacitance values of high dielectric constant type capacitors change depending on the AC voltage applied. Please consider the AC voltage characteristics when selecting a capacitor to be used in an AC circuit.

Continued on the following page. ↗

⚠Caution

Continued from the preceding page. ↘

3. Applied Voltage and Applied Current

1. Do not apply a voltage to the capacitor that exceeds the rated voltage as called out in the specifications.
 - 1-1. Applied voltage between the terminals of a capacitor shall be less than or equal to the rated voltage.
 - (1) When AC voltage is superimposed on DC voltage, the zero-to-peak voltage shall not exceed the rated DC voltage.
 When AC voltage or pulse voltage is applied, the peak-to-peak voltage shall not exceed the rated DC voltage.
 - (2) Abnormal voltages (surge voltage, static electricity, pulse voltage, etc.) shall not exceed the rated DC voltage.

Typical Voltage Applied to the DC Capacitor

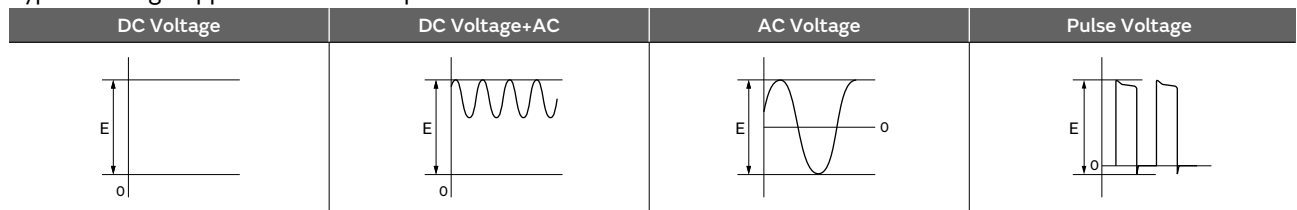

(E: Maximum possible applied voltage.)

- 1-2. Influence of over voltage
 Over voltage that is applied to the capacitor may result in an electrical short circuit caused by the breakdown of the internal dielectric layers. The time duration until breakdown depends on the applied voltage and the ambient temperature.
2. Use a safety standard certified capacitor in a power supply input circuit (AC filter), as it is also necessary to consider the withstand voltage and impulse withstand voltage defined for each device.

4. Type of Applied Voltage and Self-heating Temperature

1. Confirm the operating conditions to make sure that no large current is flowing into the capacitor due to the continuous application of an AC voltage or pulse voltage.
 When a DC rated voltage product is used in an AC voltage circuit or a pulse voltage circuit, the AC current or pulse current will flow into the capacitor; therefore check the self-heating condition.
 Please confirm the surface temperature of the capacitor so that the temperature remains within the upper limits of the operating temperature, including the rise in temperature due to self-heating. When the capacitor is used with a high-frequency voltage or pulse voltage, heat may be generated by dielectric loss.
<Applicable to Rated Voltage of less than 100VDC>
 - 1-1. The load should be contained so that the self-heating of the capacitor body remains below 20°C, when measuring at an ambient temperature of 25°C.

<Applicable to NFM Series>

3. The capacitors also have rated currents.
 The current flowing between the terminals of a capacitor shall be less than or equal to the rated current. Using the capacitor beyond this range could lead to excessive heat.

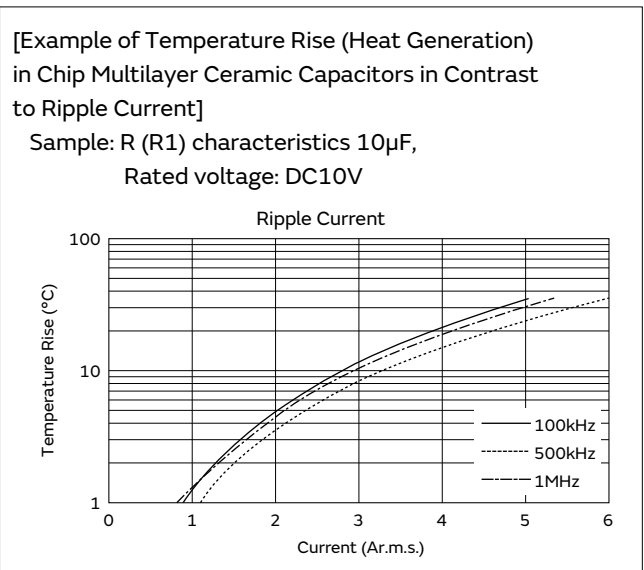

Continued on the following page. ↗

⚠Caution

Continued from the preceding page. ↘

<Applicable to Temperature Characteristics X7R (R7), X7T (D7), X7T (W0) beyond Rated Voltage of 200VDC>

1-2. The load should be contained so that the self-heating of the capacitor body remains below 20°C, when measuring at an ambient temperature of 25°C. In addition, use a K thermocouple of ϕ 0.1mm with less heat capacity when measuring, and measure in a condition where there is no effect from the radiant heat of other components or air flow caused by convection. Excessive generation of heat may cause deterioration of the characteristics and reliability of the capacitor. (Absolutely do not perform measurements while the cooling fan is operating, as an accurate measurement may not be performed.)

<Applicable to Temperature Characteristics U2J (7U), COG (5C) beyond Rated Voltage of 200VDC>

1-3. Since the self-heating is low in the low loss series, the allowable power becomes extremely high compared to the common X7R (R7) characteristics. However, when a load with self-heating of 20°C is applied at the rated voltage, the allowable power may be exceeded. When the capacitor is used in a high-frequency voltage circuit of 1kHz or more, the frequency of the applied voltage should be less than 500kHz sine wave (less than 100kHz for a product with rated voltage of DC3.15kV), to limit the voltage load so that the load remains within the derating shown in the following figure. In the case of non-sine wave, high-frequency components exceeding the fundamental frequency may be included. In such a case, please contact Murata. The excessive generation of heat may cause deterioration of the characteristics and reliability of the capacitor. (Absolutely do not perform measurements while the cooling fan is operating, as an accurate measurement may not be performed.)

[The sine-wave frequency VS allowable voltage]

The surface temperature of the capacitor: 125°C or less (including self-heating)

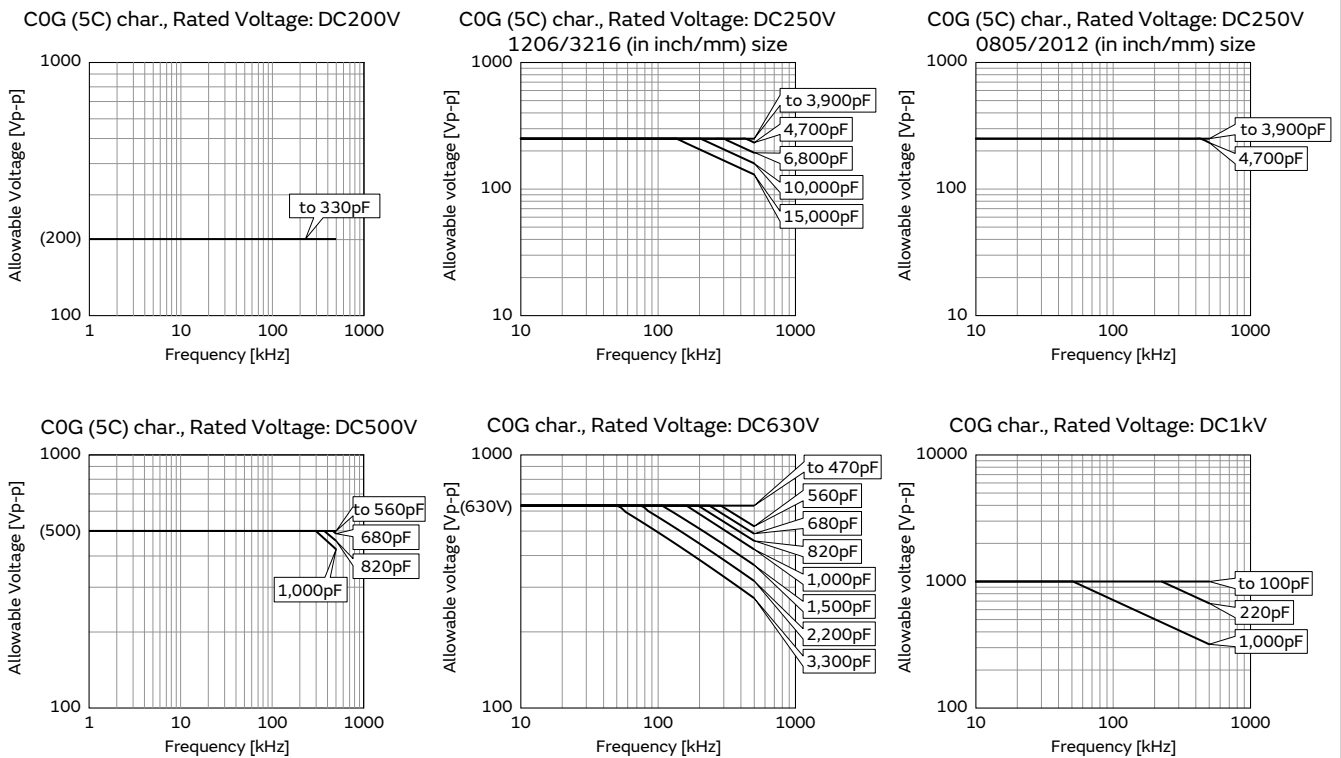

Continued on the following page. ↗

GRM
 GR3
 GRJ
 GR4
 GR7
 GJM
 GQM
 GA2
 GA3 GB
 GA3 GD
 GA3 GF
 LLL
 LLA
 LLM
 LLR
 NFM
 KRM
 KR3
 GMA
 GMD
 ⚠Caution

⚠Caution

Continued from the preceding page. ↘

[The sine-wave frequency VS allowable voltage]

The surface temperature of the capacitor: 125°C or less
 (including self-heating)

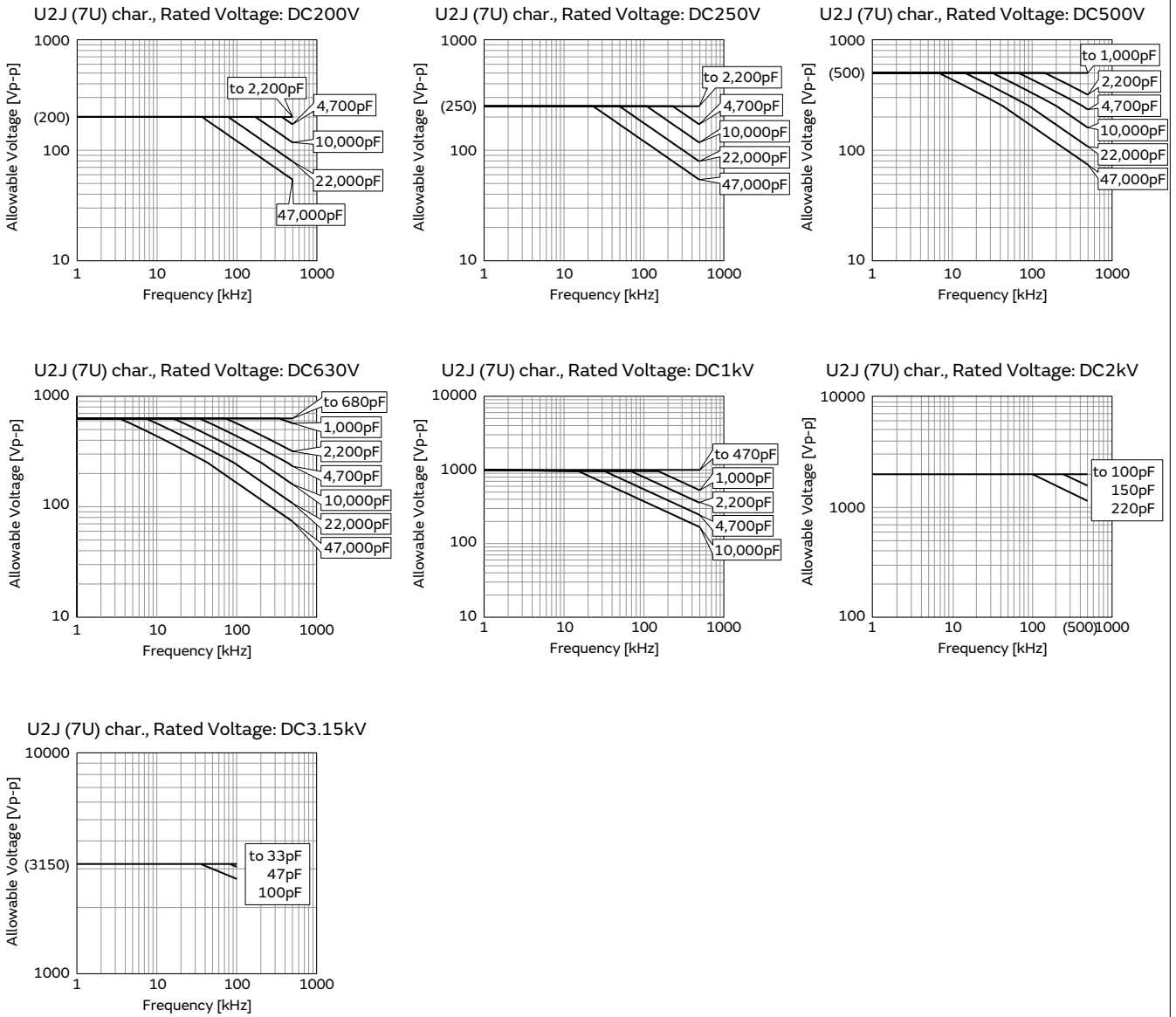

Continued on the following page. ↗

- GRM
- GR3
- GRJ
- GR4
- GR7
- GJM
- GQM
- GA2
- GA3 GB
- GA3 GD
- GA3 GF
- LLL
- LLA
- LLM
- LLR
- NFM
- KPM
- KR3
- GMA
- GMD
- ⚠Caution

⚠Caution

Continued from the preceding page. ↘

5. DC Voltage and AC Voltage Characteristics

1. The capacitance value of a high dielectric constant type capacitor changes depending on the DC voltage applied. Please consider the DC voltage characteristics when a capacitor is selected for use in a DC circuit.

1-1. The capacitance of ceramic capacitors may change sharply depending on the applied voltage (see figure). Please confirm the following in order to secure the capacitance.

- (1) Determine whether the capacitance change caused by the applied voltage is within the allowed range.
- (2) In the DC voltage characteristics, the rate of capacitance change becomes larger as voltage increases, even if the applied voltage is below the rated voltage. When a high dielectric constant type capacitor is used in a circuit that requires a tight (narrow) capacitance tolerance (e.g., a time constant circuit), please carefully consider the voltage characteristics, and confirm the various characteristics in the actual operating conditions of the system.

2. The capacitance values of high dielectric constant type capacitors changes depending on the AC voltage applied. Please consider the AC voltage characteristics when selecting a capacitor to be used in an AC circuit.

6. Capacitance Aging

1. The high dielectric constant type capacitors have an Aging characteristic in which the capacitance value decreases with the passage of time. When you use high dielectric constant type capacitors in a circuit that needs a tight (narrow) capacitance tolerance (e.g., a time-constant circuit), please carefully consider the characteristics of these capacitors, such as their aging, voltage, and temperature characteristics. In addition, check capacitors using your actual appliances at the intended environment and operating conditions.

[Example of DC Voltage Characteristics]
 Sample: X7R (R7) Characteristics 0.1μF,
 Rated Voltage 50VDC

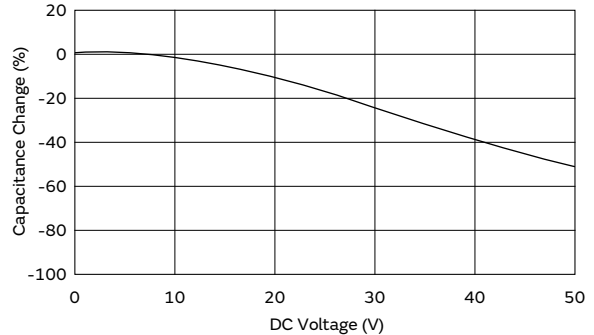

[Example of AC Voltage Characteristics]
 Sample: X7R (R7) Characteristics 10μF,
 Rated Voltage 6.3VDC

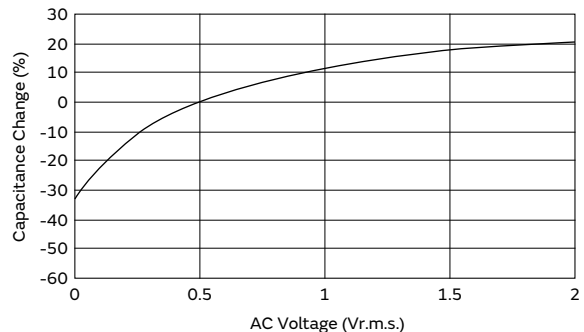

[Example of Change Over Time (Aging Characteristics)]

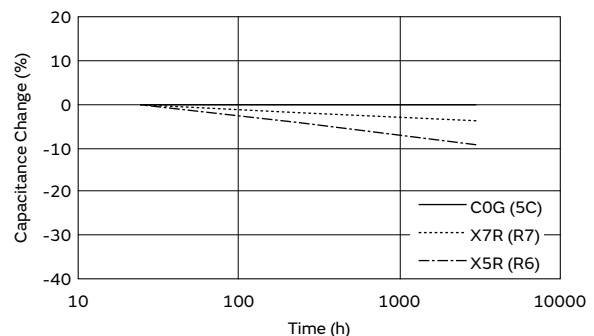

Continued on the following page. ↗

GRM

GR3

GRJ

GR4

GR7

GJM

GQM

GA2

GA3
GB

GA3
GD

GA3
GF

LLL

LLA

LLM

LLR

NFM

KRM

KR3

GMA

GMD

⚠Caution

⚠Caution

Continued from the preceding page. ↘

7. Vibration and Shock

1. Please confirm the kind of vibration and/or shock, its condition, and any generation of resonance.
 Please mount the capacitor so as not to generate resonance, and do not allow any impact on the terminals.
2. Mechanical shock due to being dropped may cause damage or a crack in the dielectric material of the capacitor.
 Do not use a dropped capacitor because the quality and reliability may be deteriorated.
3. When printed circuit boards are piled up or handled, the corner of another printed circuit board should not be allowed to hit the capacitor, in order to avoid a crack or other damage to the capacitor.

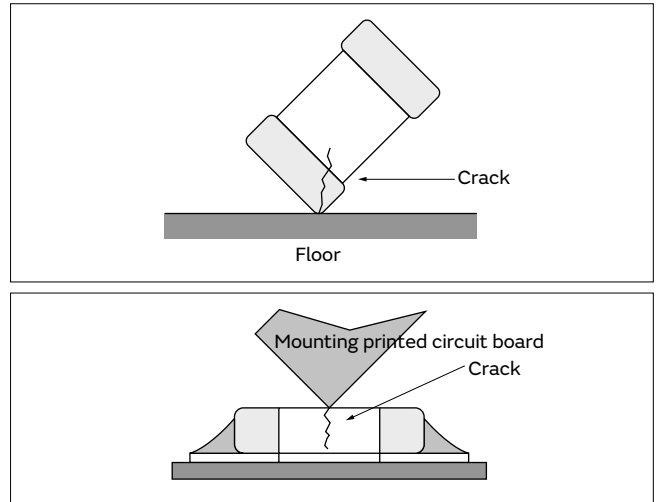

Soldering and Mounting

1. Mounting Position

1. Confirm the best mounting position and direction that minimizes the stress imposed on the capacitor during flexing or bending the printed circuit board.
 - 1-1. Choose a mounting position that minimizes the stress imposed on the chip during flexing or bending of the board.

<Applicable to NFM Series>

2. If you mount the capacitor near components that generate heat, take note of the heat from the other components and carefully check the self-heating of the capacitor before using.
 If there is significant heat radiation from other components, it could lower the insulation resistance of the capacitor or produce excessive heat.

[Component Direction]

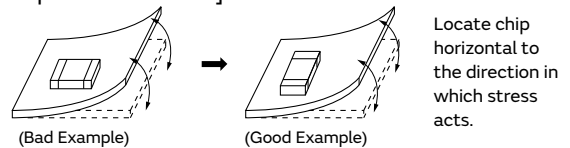

[Chip Mounting Close to Board Separation Point]

It is effective to implement the following measures, to reduce stress in separating the board.

It is best to implement all of the following three measures; however, implement as many measures as possible to reduce stress.

Contents of Measures	Stress Level
(1) Turn the mounting direction of the component parallel to the board separation surface.	A > D *1
(2) Add slits in the board separation part.	A > B
(3) Keep the mounting position of the component away from the board separation surface.	A > C

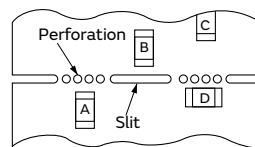

*1 A > D is valid when stress is added vertically to the perforation as with Hand Separation.
 If a Cutting Disc is used, stress will be diagonal to the PCB, therefore A > D is invalid.

[Mounting Capacitors Near Screw Holes]

When a capacitor is mounted near a screw hole, it may be affected by the board deflection that occurs during the tightening of the screw. Mount the capacitor in a position as far away from the screw holes as possible.

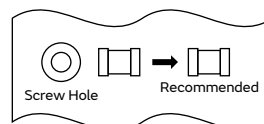

Continued on the following page. ↗

GRM
 GR3
 GRJ
 GR4
 GR7
 GJM
 GQM
 GA2
 GA3 GB
 GA3 GD
 GA3 GF
 LLL
 LLA
 LLM
 LLR
 NFM
 KPM
 KR3
 GMA
 GMD
 ⚠Caution

⚠Caution

Continued from the preceding page. ↘

2. Information before Mounting

1. Do not re-use capacitors that were removed from the equipment.
2. Confirm capacitance characteristics under actual applied voltage.
3. Confirm the mechanical stress under actual process and equipment use.
4. Confirm the rated capacitance, rated voltage and other electrical characteristics before assembly.
5. Prior to use, confirm the solderability of capacitors that were in long-term storage.
6. Prior to measuring capacitance, carry out a heat treatment for capacitors that were in long-term storage.
7. The use of Sn-Zn based solder will deteriorate the reliability of the MLCC.
Please contact our sales representative or product engineers on the use of Sn-Zn based solder in advance.
8. We have also produced a DVD which shows a summary of our recommendations, regarding the precautions for mounting. Please contact our sales representative to request the DVD.

3. Maintenance of the Mounting (pick and place) Machine

1. Make sure that the following excessive forces are not applied to the capacitors. Check the mounting in the actual device under actual use conditions ahead of time.
 - 1-1. In mounting the capacitors on the printed circuit board, any bending force against them shall be kept to a minimum to prevent them from any damage or cracking. Please take into account the following precautions and recommendations for use in your process.
 - (1) Adjust the lowest position of the pickup nozzle so as not to bend the printed circuit board.
2. Dirt particles and dust accumulated in the suction nozzle and suction mechanism prevent the nozzle from moving smoothly. This creates excessive force on the capacitor during mounting, causing cracked chips. Also, the locating claw, when worn out, imposes uneven forces on the chip when positioning, causing cracked chips. The suction nozzle and the locating claw must be maintained, checked, and replaced periodically.

<Applicable to ZRB Series>

3. To adjust the inspection tolerance for automated appearance sorting machine of mounting position, because ZRB series are easier to shift the mounting position than standard MLCC.
4. To check the overturn and reverse of chip.
5. To control mounting speed carefully, because ZRB series is heavier than standard MLCC.

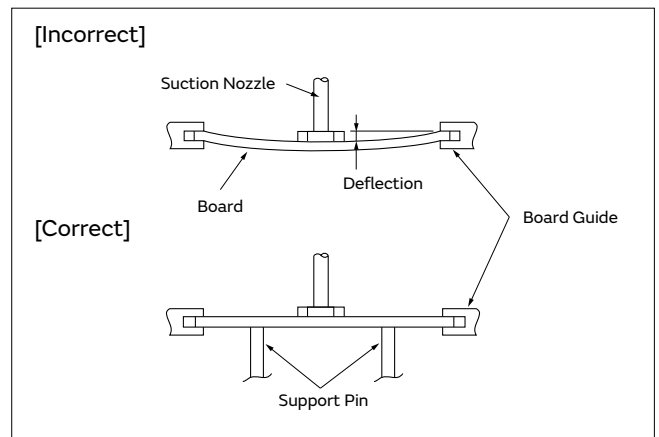

Continued on the following page. ↗

⚠Caution

Continued from the preceding page. ↘

4-1. Reflow Soldering

- When sudden heat is applied to the components, the mechanical strength of the components will decrease because a sudden temperature change causes deformation inside the components. In order to prevent mechanical damage to the components, preheating is required for both the components and the PCB. Preheating conditions are shown in table 1. It is required to keep the temperature differential between the solder and the components surface (ΔT) as small as possible.
- When components are immersed in solvent after mounting, be sure to maintain the temperature difference (ΔT) between the component and the solvent within the range shown in table 1.

Table 1

Series	Chip Dimension Code (L/W)	Temperature Differential
GRM/GJM/GQM/GR3/GRJ/KRM/LLR/NFM/GR7	02/03/15/18/21/31	$\Delta T \leq 190^\circ\text{C}$
LLL	02/03/15/18/1U/21/31	
ZRB	15/18	
GR3/GRJ/GRM/KR3/KRM GA2/GA3/GR4	32/42/43/52/55	$\Delta T \leq 130^\circ\text{C}$
LLA/LLM	18/21/31	
GQM	22	

Recommended Conditions

	Pb-Sn Solder	Lead Free Solder
Peak Temperature	230 to 250°C	240 to 260°C
Atmosphere	Air	Air or N ₂

Pb-Sn Solder: Sn-37Pb

Lead Free Solder: Sn-3.0Ag-0.5Cu

- When a capacitor is mounted at a temperature lower than the peak reflow temperature recommended by the solder manufacturer, the following quality problems can occur. Consider factors such as the placement of peripheral components and the reflow temperature setting to prevent the capacitor's reflow temperature from dropping below the peak temperature specified. Be sure to evaluate the mounting situation beforehand and verify that none of the following problems occur.
 - Drop in solder wettability
 - Solder voids
 - Possible occurrence of whiskering
 - Drop in bonding strength
 - Drop in self-alignment properties
 - Possible occurrence of tombstones and/or shifting on the land patterns of the circuit board

[Example of Temperature Conditions for Reflow Soldering]

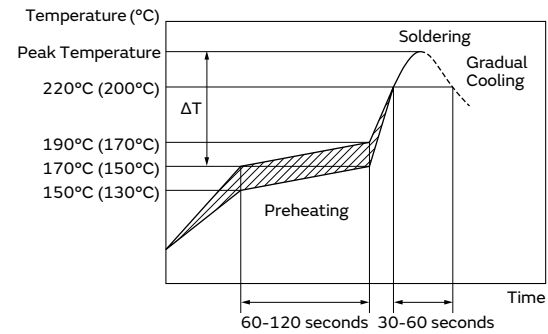

Temperature
 Incase of Lead Free Solder
 (): In case of Pb-Sn Solder

[Allowable Reflow Soldering Temperature and Time]

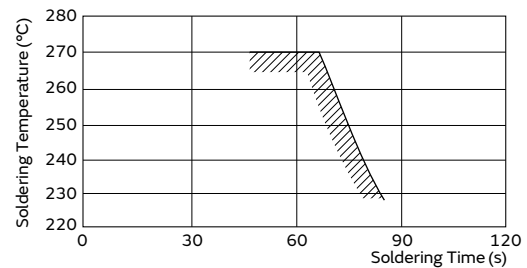

In the case of repeated soldering, the accumulated soldering time must be within the range shown above.

Continued on the following page. ↗

GRM
 GR3
 GRJ
 GR4
 GR7
 GJM
 GQM
 GA2
 GA3 GB
 GA3 GD
 GA3 GF
 LLL
 LLA
 LLM
 LLR
 NFM
 KRM
 KR3
 GMA
 GMD
 ⚠Caution

Caution

Continued from the preceding page. ↘

4. Optimum Solder Amount for Reflow Soldering

- 4-1. Overly thick application of solder paste results in a excessive solder fillet height.
 This makes the chip more susceptible to mechanical and thermal stress on the board and may cause the chips to crack.
- 4-2. Too little solder paste results in a lack of adhesive strength on the termination, which may result in chips breaking loose from the PCB.
- 4-3. Please confirm that solder has been applied smoothly to the termination.

<Applicable to NFM Series>

[Guideline of solder paste thickness]
 100-150 μ m: NFM15/18/21/3D/31
 100-200 μ m: NFM41

NFM15CC/15PC

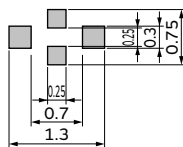

NFM18CC/18PC

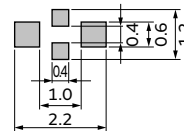

NFM18PS

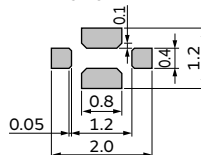

NFM21CC/21PC

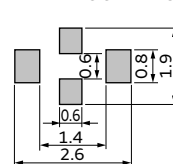

NFM21PS

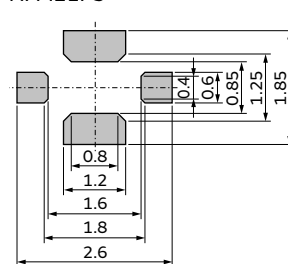

NFM3DCC/3DPC

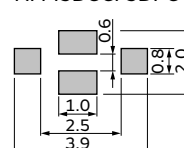

NFM31PC/31KC

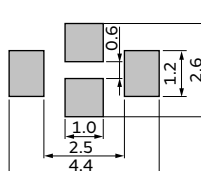

NFM41CC/41PC

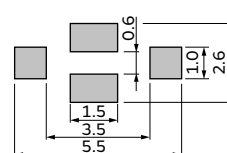

Inverting the PCB

Make sure not to impose any abnormal mechanical shocks to the PCB.

Continued on the following page. ↗

- GRM
- GR3
- GRJ
- GR4
- GR7
- GJM
- GQM
- GA2
- GA3 GB
- GA3 GD
- GA3 GF
- LLL
- LLA
- LLM
- LLR
- NFM
- KRM
- KR3
- GMA
- GMD
- Caution

Caution

Continued from the preceding page. ↘

4-2. Flow Soldering

1. Do not apply flow soldering to chips not listed in table 2.

Table 2

Series	Chip Dimension Code (L/W)	Temperature Differential
GR3/GRM	18/21/31	$\Delta T \leq 150^{\circ}\text{C}$
GQM	18/21	
LLL	21/31	
GRJ	18/21/31	
NFM	3D/31/41	

- When sudden heat is applied to the components, the mechanical strength of the components will decrease because a sudden temperature change causes deformation inside the components. In order to prevent mechanical damage to the components, preheating is required for both of the components and the PCB. Preheating conditions are shown in table 2. It is required to keep the temperature differential between the solder and the components surface (ΔT) as low as possible.
- Excessively long soldering time or high soldering temperature can result in leaching of the terminations, causing poor adhesion or a reduction in capacitance value due to loss of contact between the inner electrodes and terminations.
- When components are immersed in solvent after mounting, be sure to maintain the temperature differential (ΔT) between the component and solvent within the range shown in the table 2.

Recommended Conditions

	Pb-Sn Solder	Lead Free Solder
Preheating Peak Temperature	90 to 110°C	100 to 120°C 140 to 160°C (NFM)
Soldering Peak Temperature	240 to 250°C	250 to 260°C
Atmosphere	Air	Air or N ₂

Pb-Sn Solder: Sn-37Pb

Lead Free Solder: Sn-3.0Ag-0.5Cu

5. Optimum Solder Amount for Flow Soldering

- The top of the solder fillet should be lower than the thickness of the components. If the solder amount is excessive, the risk of cracking is higher during board bending or any other stressful condition.

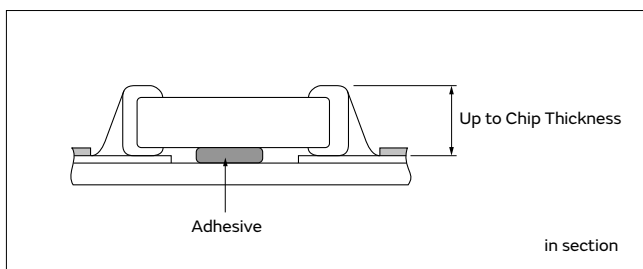

[Example of Temperature Conditions for Flow Soldering]

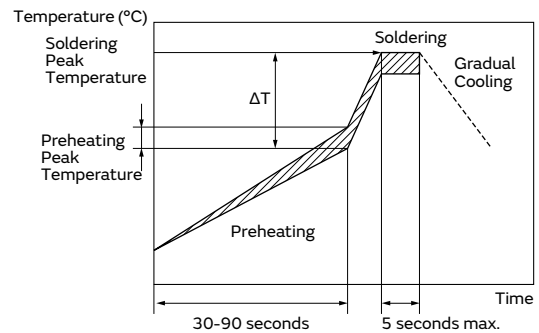

[Allowable Flow Soldering Temperature and Time]

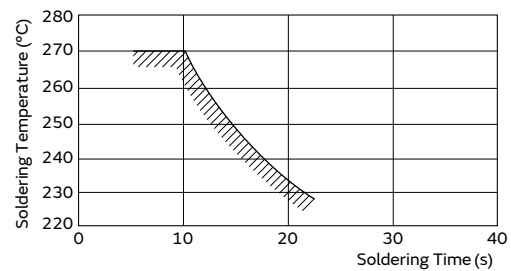

In the case of repeated soldering, the accumulated soldering time must be within the range shown above.

Continued on the following page. ↗

- GRM
- GR3
- GRJ
- GR4
- GR7
- GJM
- GQM
- GA2
- GA3 GB
- GA3 GD
- GA3 GF
- LLL
- LLA
- LLM
- LLR
- NFM
- KRM
- KR3
- GMA
- GMD
- Caution

⚠Caution

Continued from the preceding page. ↘

4-3. Correction of Soldered Portion

When sudden heat is applied to the capacitor, distortion caused by the large temperature difference occurs internally, and can be the cause of cracks. Capacitors also tend to be affected by mechanical and thermal stress depending on the board preheating temperature or the soldering fillet shape, and can be the cause of cracks. Please refer to "1. PCB Design" or "3. Optimum solder amount" for the solder amount and the fillet shapes.

Do not correct with a soldering iron for ZRB series.
 Correction with a soldering iron for ZRB series may cause loss suppress acoustic noise, because the solder amount become excessive.

1. Correction with a Soldering Iron

- 1-1. In order to reduce damage to the capacitor, be sure to preheat the capacitor and the mounting board. Preheat to the temperature range shown in Table 3. A hot plate, hot air type preheater, etc. can be used for preheating.
- 1-2. After soldering, do not allow the component/PCB to cool down rapidly.
- 1-3. Perform the corrections with a soldering iron as quickly as possible. If the soldering iron is applied too long, there is a possibility of causing solder leaching on the terminal electrodes, which will cause deterioration of the adhesive strength and other problems.

Table 3

Series	Chip Dimension Code (L/W)	Temperature of Soldering Iron Tip	Preheating Temperature	Temperature Differential (ΔT)	Atmosphere
GJM/GQM/GR3/GRJ/GRM/GR7	03/15/18/21/31	350°C max.	150°C min.	$\Delta T \leq 190^\circ\text{C}$	Air
GRJ/GRM/GR4/GA2/GA3	32/42/43/52/55	280°C max.	150°C min.	$\Delta T \leq 130^\circ\text{C}$	Air
GQM	22				
NFM	3D/41	350°C max.	150°C min.	$\Delta T \leq 190^\circ\text{C}$	Air
	15	340°C max.			

*Applicable for both Pb-Sn and Lead Free Solder.
 Pb-Sn Solder: Sn-37Pb
 Lead Free Solder: Sn-3.0Ag-0.5Cu
 *Please manage ΔT in the temperature of soldering iron and the preheating temperature.

2. Correction with Spot Heater

Compared to local heating with a soldering iron, hot air heating by a spot heater heats the overall component and board, therefore, it tends to lessen the thermal shock. In the case of a high density mounted board, a spot heater can also prevent concerns of the soldering iron making direct contact with the component.

2-1. If the distance from the hot air outlet of the spot heater to the component is too close, cracks may occur due to thermal shock. To prevent this problem, follow the conditions shown in Table 4.

2-2. In order to create an appropriate solder fillet shape, it is recommended that hot air be applied at the angle shown in Figure 1.

Table 4

Distance	5mm or more
Hot Air Application Angle	45° *Figure 1
Hot Air Temperature Nozzle Outlet	400°C max.
Application Time	Less than 10 seconds (1206 (3216M) size or smaller)
	Less than 30 seconds (1210 (3225M) size or larger)

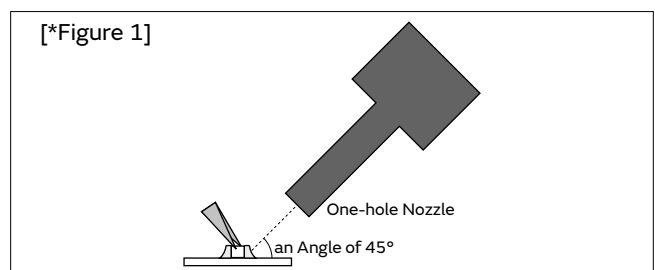

3. Optimum solder amount when re-working with a soldering iron

3-1. If the solder amount is excessive, the risk of cracking is higher during board bending or any other stressful condition.
 Too little solder amount results in a lack of adhesive strength on the termination, which may result in chips breaking loose from the PCB.
 Please confirm that solder has been applied smoothly and rising to the end surface of the chip.

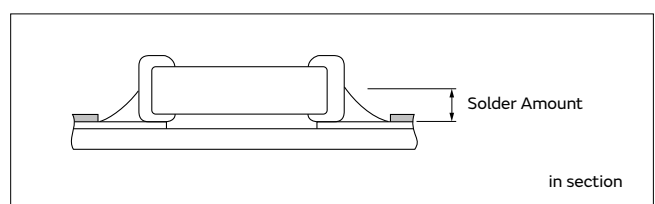

Continued on the following page. ↗

Caution

Continued from the preceding page. ↘

- 3-2. A soldering iron with a tip of $\varnothing 3\text{mm}$ or smaller should be used. It is also necessary to keep the soldering iron from touching the components during the re-work.
- 3-3. Solder wire with $\varnothing 0.5\text{mm}$ or smaller is required for soldering.

<Applicable to KR3/KRM Series>

4. For the shape of the soldering iron tip, refer to the figure on the right.

Regarding the type of solder, use a wire diameter of $\varnothing 0.5\text{mm}$ or less (rosin core wire solder).

4-1. How to Apply the Soldering Iron

Apply the tip of the soldering iron against the lower end of the metal terminal.

- 1) In order to prevent cracking caused by sudden heating of the ceramic device, do not touch the ceramic base directly.
- 2) In order to prevent deviations and dislocating of the chip, do not touch the junction of the chip and the metal terminal, and the metal portion on the outside directly.

4-2. Appropriate Amount of Solder

The amount of solder for corrections by soldering iron, should be lower than the height of the lower side of the chip.

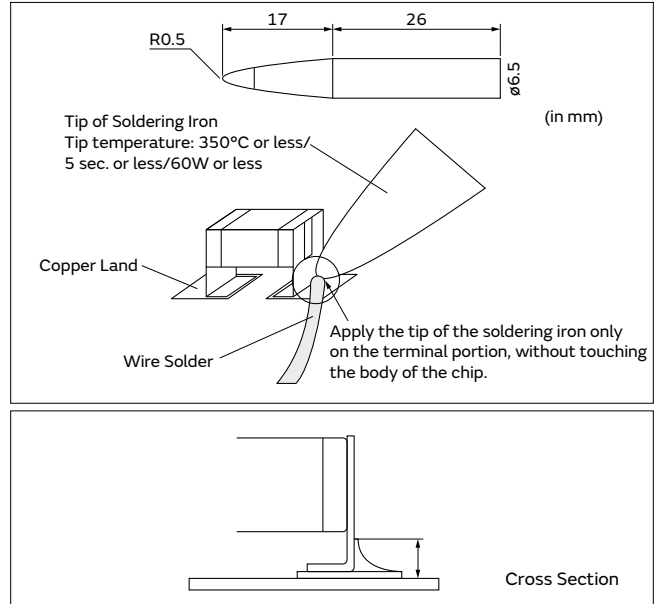

5. Washing

Excessive ultrasonic oscillation during cleaning can cause the PCBs to resonate, resulting in cracked chips or broken solder joints. Before starting your production process, test your cleaning equipment/process to insure it does not degrade the capacitors.

6. Electrical Test on Printed Circuit Board

1. Confirm position of the support pin or specific jig, when inspecting the electrical performance of a capacitor after mounting on the printed circuit board.

1-1. Avoid bending the printed circuit board by the pressure of a test-probe, etc.

The thrusting force of the test probe can flex the PCB, resulting in cracked chips or open solder joints. Provide support pins on the back side of the PCB to prevent warping or flexing. Install support pins as close to the test-probe as possible.

1-2. Avoid vibration of the board by shock when a test-probe contacts a printed circuit board.

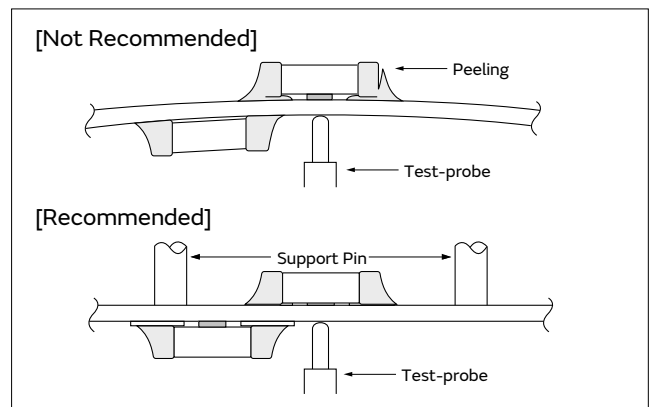

7. Printed Circuit Board Cropping

1. After mounting a capacitor on a printed circuit board, do not apply any stress to the capacitor that causes bending or twisting the board.

- 1-1. In cropping the board, the stress as shown at right may cause the capacitor to crack. Cracked capacitors may cause deterioration of the insulation resistance, and result in a short. Avoid this type of stress to a capacitor.

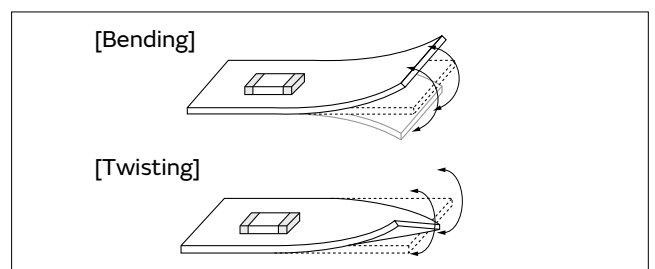

Continued on the following page. ↗

Caution

Continued from the preceding page. ↘

2. Check the cropping method for the printed circuit board in advance.

2-1. Printed circuit board cropping shall be carried out by using a jig or an apparatus (Disc separator, router type separator, etc.) to prevent the mechanical stress that can occur to the board.

Board Separation Method	Hand Separation Nipper Separation	(1) Board Separation Jig	Board Separation Apparatus	
			(2) Disc Separator	(3) Router Type Separator
Level of stress on board	High	Medium	Medium	Low
Recommended	×	△*	△*	○
Notes	Hand and nipper separation apply a high level of stress. Use another method.	<ul style="list-style-type: none"> Board handling Board bending direction Layout of capacitors 	<ul style="list-style-type: none"> Board handling Layout of slits Design of V groove Arrangement of blades Controlling blade life 	Board handling

* When a board separation jig or disc separator is used, if the following precautions are not observed, a large board deflection stress will occur and the capacitors may crack. Use router type separator if at all possible.

(1) Example of a suitable jig

[In the case of Single-side Mounting]

An outline of the board separation jig is shown as follows. Recommended example: Stress on the component mounting position can be minimized by holding the portion close to the jig, and bend in the direction towards the side where the capacitors are mounted. Not recommended example: The risk of cracks occurring in the capacitors increases due to large stress being applied to the component mounting position, if the portion away from the jig is held and bent in the direction opposite the side where the capacitors are mounted.

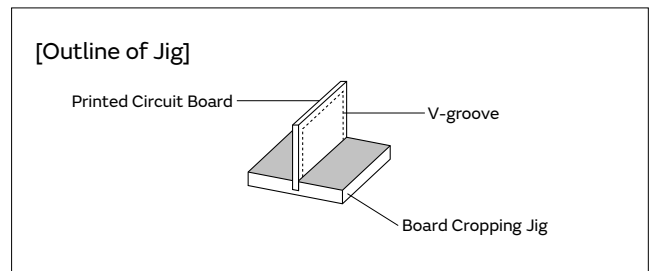

Hand Separation

Recommended	Not Recommended

[In the case of Double-sided Mounting]

Since components are mounted on both sides of the board, the risk of cracks occurring can not be avoided with the above method. Therefore, implement the following measures to prevent stress from being applied to the components.

(Measures)

- (1) Consider introducing a router type separator. If it is difficult to introduce a router type separator, implement the following measures. (Refer to item 1. Mounting Position)
- (2) Mount the components parallel to the board separation surface.
- (3) When mounting components near the board separation point, add slits in the separation position near the component.
- (4) Keep the mounting position of the components away from the board separation point.

Continued on the following page. ↗

GRM
GR3
GRJ
GR4
GR7
GJM
GQM
GA2
GA3 GB
GA3 GD
GA3 GF
LLL
LLA
LLM
LLR
NFM
KRM
KR3
GMA
GMD
Caution

⚠Caution

Continued from the preceding page. ↘

(2) Example of a Disc Separator

An outline of a disc separator is shown as follows. As shown in the Principle of Operation, the top blade and bottom blade are aligned with the V-grooves on the printed circuit board to separate the board.

In the following case, board deflection stress will be applied and cause cracks in the capacitors.

- (1) When the adjustment of the top and bottom blades are misaligned, such as deviating in the top-bottom, left-right or front-rear directions
- (2) The angle of the V groove is too low, depth of the V groove is too shallow, or the V groove is misaligned top-bottom

IF V groove is too deep, it is possible to brake when you handle and carry it. Carefully design depth of the V groove with consideration about strength of material of the printed circuit board.

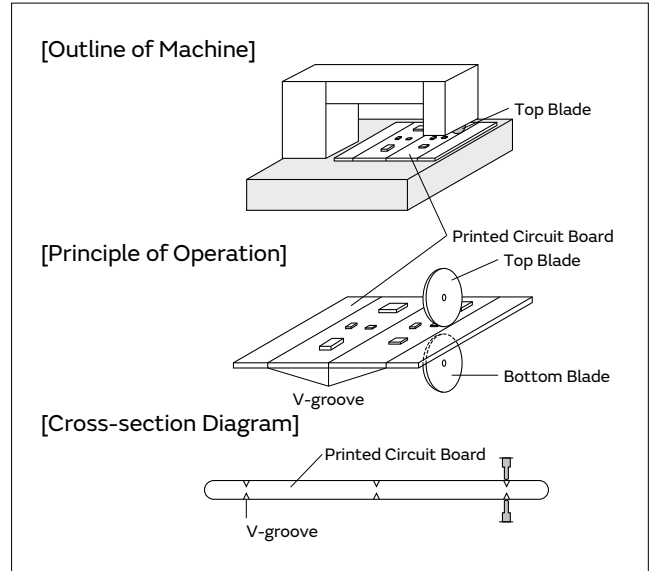

Disc Separator

Recommended	Not Recommended		
	Top-bottom Misalignment	Left-right Misalignment	Front-rear Misalignment
<p>Top Blade</p> <p>Bottom Blade</p>	<p>Top Blade</p> <p>Bottom Blade</p>	<p>Top Blade</p> <p>Bottom Blade</p>	<p>Top Blade</p> <p>Bottom Blade</p>

V-groove Design

Example of Recommended V-groove Design	Not Recommended			
	Left-right Misalignment	Low-Angle	Depth too Shallow	Depth too Deep

(3) Example of Router Type Separator

The router type separator performs cutting by a router rotating at a high speed. Since the board does not bend in the cutting process, stress on the board can be suppressed during board separation.

When attaching or removing boards to/from the router type separator, carefully handle the boards to prevent bending.

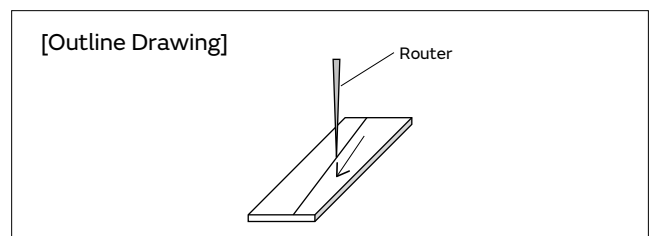

Continued on the following page. ↗

GRM
 GR3
 GRJ
 GR4
 GR7
 GJM
 GQM
 GA2
 GA3 GB
 GA3 GD
 GA3 GF
 LLL
 LLA
 LLM
 LLR
 NFM
 KRM
 KR3
 GMA
 GMD
 ⚠Caution

GRM
GR3
GRJ
GR4
GR7
GJM
GQM
GA2
GA3 GB
GA3 GD
GA3 GF
LLL
LLA
LLM
LLR
NFM
KRM
KR3
GMA
GMD
Caution

⚠Caution

Continued from the preceding page. ↘

8. Assembly

1. Handling

If a board mounted with capacitors is held with one hand, the board may bend. Firmly hold the edges of the board with both hands when handling.

If a board mounted with capacitors is dropped, cracks may occur in the capacitors.

Do not use dropped boards, as there is a possibility that the quality of the capacitors may be impaired.

2. Attachment of Other Components

2-1. Mounting of Other Components

Pay attention to the following items, when mounting other components on the back side of the board after capacitors have been mounted on the opposite side.

When the bottom dead point of the suction nozzle is set too low, board deflection stress may be applied to the capacitors on the back side (bottom side), and cracks may occur in the capacitors.

- After the board is straightened, set the bottom dead point of the nozzle on the upper surface of the board.
- Periodically check and adjust the bottom dead point.

2-2. Inserting Components with Leads into Boards

When inserting components (transformers, IC, etc.) into boards, bending the board may cause cracks in the capacitors or cracks in the solder.

Pay attention to the following.

- Increase the size of the holes to insert the leads, to reduce the stress on the board during insertion.
- Fix the board with support pins or a dedicated jig before insertion.
- Support below the board so that the board does not bend. When using support pins on the board, periodically confirm that there is no difference in the height of each support pin.

2-3. Attaching/Removing Sockets and/or Connectors

Insertion and removal of sockets and connectors, etc., might cause the board to bend. Please insure that the board does not warp during insertion and removal of sockets and connectors, etc., or the bending may damage mounted components on the board.

2-4. Tightening Screws

The board may be bent, when tightening screws, etc. during the attachment of the board to a shield or chassis.

Pay attention to the following items before performing the work.

- Plan the work to prevent the board from bending.
- Use a torque screwdriver, to prevent over-tightening of the screws.
- The board may bend after mounting by reflow soldering, etc. Please note, as stress may be applied to the chips by forcibly flattening the board when tightening the screws.

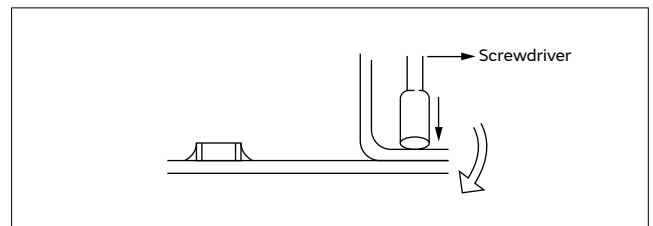
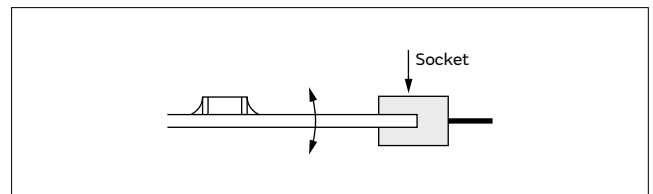
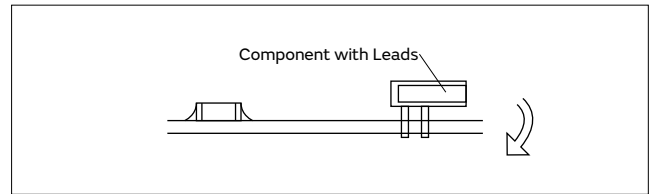
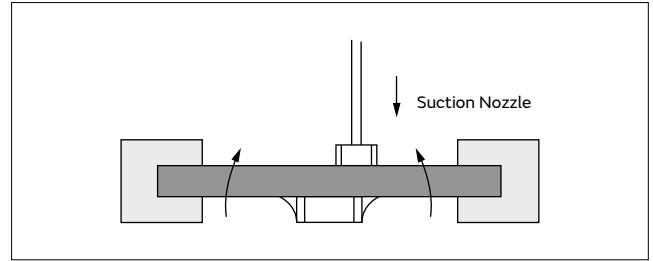

⚠Caution

Continued from the preceding page. ↘

<Applicable to GMA or GMD Series>

9. Die Bonding/Wire Bonding

1. Die Bonding of Capacitors

1-1. Use the following materials for the Brazing alloys:

Au-Sn (80/20) 300 to 320 °C in N₂ atmosphere

1-2. Mounting

- (1) Control the temperature of the substrate so it matches the temperature of the brazing alloy.
- (2) Place the brazing alloy on the substrate and place the capacitor on the alloy. Hold the capacitor and gently apply the load. Be sure to complete the operation within 1 minute.

2. Wire Bonding

2-1. Wire

Gold wire: 25 micro m (0.001 inch) diameter

2-2. Bonding

- (1) Thermo compression, ultrasonic ball bonding.
- (2) Required stage temperature: 150 to 200 °C
- (3) Required wedge or capillary weight: 0.2N to 0.5N
- (4) Bond the capacitor and base substrate or other devices with gold wire.

Other

1. Under Operation of Equipment

- 1-1. Do not touch a capacitor directly with bare hands during operation in order to avoid the danger of an electric shock.
- 1-2. Do not allow the terminals of a capacitor to come in contact with any conductive objects (short-circuit). Do not expose a capacitor to a conductive liquid, including any acid or alkali solutions.
- 1-3. Confirm the environment in which the equipment will operate is under the specified conditions. Do not use the equipment under the following environments.
 - (1) Being splattered with water or oil.
 - (2) Being exposed to direct sunlight.
 - (3) Being exposed to ozone, ultraviolet rays, or radiation.
 - (4) Being exposed to toxic gas (e.g., hydrogen sulfide, sulfur dioxide, chlorine, ammonia gas, etc.)
 - (5) Any vibrations or mechanical shocks exceeding the specified limits.
 - (6) Moisture condensing environments.
- 1-4. Use damp proof countermeasures if using under any conditions that can cause condensation.

Continued on the following page. ↗

GRM

GR3

GRJ

GR4

GR7

GJM

GQM

GA2

GA3
GB

GA3
GD

GA3
GF

LLL

LLA

LLM

LLR

NFM

KRM

KR3

GMA

GMD

⚠Caution

281

⚠Caution

Continued from the preceding page. ↘

2. Other

2-1. In an Emergency

- (1) If the equipment should generate smoke, fire, or smell, immediately turn off or unplug the equipment.

If the equipment is not turned off or unplugged, the hazards may be worsened by supplying continuous power.

- (2) In this type of situation, do not allow face and hands to come in contact with the capacitor or burns may be caused by the capacitor's high temperature.

2-2. Disposal of Waste

When capacitors are disposed of, they must be burned or buried by an industrial waste vendor with the appropriate licenses.

2-3. Circuit Design

(1) Addition of Fail Safe Function

Capacitors that are cracked by dropping or bending of the board may cause deterioration of the insulation resistance, and result in a short.

If the circuit being used may cause an electrical shock, smoke or fire when a capacitor is shorted, be sure to install fail-safe functions, such as a fuse, to prevent secondary accidents.

- (2) Capacitors used to prevent electromagnetic interference in the primary AC side circuit, or as a connection/insulation, must be a safety standard certified product, or satisfy the contents stipulated in the Electrical Appliance and Material Safety Law. Install a fuse for each line in case of a short.

- (3) The GJM, GMA, GMD, GQM, GR3, GRJ, GRM, KR3, KRM, LLA, LLL, LLM, LLR, NFM and ZRB series are not safety standard certified products.

2-4. Test Condition for AC Withstanding Voltage

(1) Test Equipment

Test equipment for AC withstanding voltage should be made with equipment capable of creating a wave similar to a 50/60Hz sine wave.

(2) Voltage Applied Method

The capacitor's lead or terminal should be firmly connected to the output of the withstanding voltage test equipment, and then the voltage should be raised from near zero to the test voltage.

If the test voltage is applied directly to the capacitor without raising it from near zero, it should be applied with the zero cross. *At the end of the test time, the test voltage should be reduced to near zero, and then capacitor's lead or terminals should be taken off the output of the withstanding voltage test equipment.

If the test voltage applied directly to the capacitor without raising it from near zero, surge voltage may occur and cause a defect.

*ZERO CROSS is the point where voltage sine wave passes 0V. - See the figure at right -

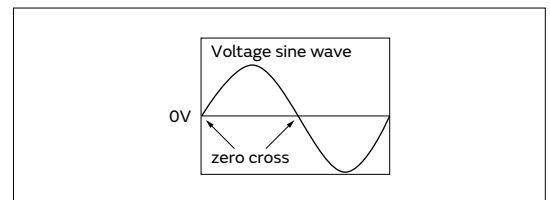

2-5. Remarks

Failure to follow the cautions may result, worst case, in a short circuit and smoking when the product is used.

The above notices are for standard applications and conditions. Contact us when the products are used in special mounting conditions.

Select optimum conditions for operation as they determine the reliability of the product after assembly.

The data herein are given in typical values, not guaranteed ratings.

GRM

GR3

GRJ

GR4

GR7

GJM

GQM

GA2

GA3

GB

GA3

GD

GA3

GF

LLL

LLA

LLM

LLR

NFM

KRM

KR3

GMA

GMD

⚠Caution

Notice

Rating

1. Operating Temperature

1. The operating temperature limit depends on the capacitor.
 - 1-1. Do not apply temperatures exceeding the maximum operating temperature.
It is necessary to select a capacitor with a suitable rated temperature that will cover the operating temperature range.
It is also necessary to consider the temperature distribution in equipment and the seasonal temperature variable factor.
 - 1-2. Consider the self-heating factor of the capacitor.
The surface temperature of the capacitor shall not exceed the maximum operating temperature including self-heating.

2. Atmosphere Surroundings (gaseous and liquid)

1. Restriction on the operating environment of capacitors.
 - 1-1. Capacitors, when used in the above, unsuitable, operating environments may deteriorate due to the corrosion of the terminations and the penetration of moisture into the capacitor.
 - 1-2. The same phenomenon as the above may occur when the electrodes or terminals of the capacitor are subject to moisture condensation.
 - 1-3. The deterioration of characteristics and insulation resistance due to the oxidization or corrosion of terminal electrodes may result in breakdown when the capacitor is exposed to corrosive or volatile gases or solvents for long periods of time.

Soldering and Mounting

1. PCB Design

1. Notice for Pattern Forms
 - 1-1. Unlike leaded components, chip components are susceptible to flexing stresses since they are mounted directly on the substrate.
They are also more sensitive to mechanical and thermal stresses than leaded components.
Excess solder fillet height can multiply these stresses and cause chip cracking. When designing substrates, take land patterns and dimensions into consideration to eliminate the possibility of excess solder fillet height.
 - 1-2. There is a possibility of chip cracking caused by PCB expansion/contraction with heat, because stress on a chip is different depending on PCB material and structure. When the thermal expansion coefficient greatly differs between the board used for mounting and the chip, it will cause cracking of the chip due to the thermal expansion and contraction.
When capacitors are mounted on a fluorine resin printed circuit board or on a single-layered glass epoxy board, it may also cause cracking of the chip for the same reason.

3. Piezo-electric Phenomenon

1. When using high dielectric constant type capacitors in AC or pulse circuits, the capacitor itself vibrates at specific frequencies and noise may be generated.
Moreover, when the mechanical vibration or shock is added to the capacitor, noise may occur.

<Applicable to NFM Series>

- 1-3. Because noise is suppressed by shunting unwanted high-frequency components to the ground, when designing a land for the NFM series, design the ground pattern to be as large as possible in order to better bring out this characteristic.
As shown in the figure below, noise countermeasures can be made more effective by using a via to connect the ground pattern on the chip mounting surface to a larger ground pattern on the inner layer.

Continued on the following page. ↗

Notice

Continued from the preceding page. ↘

Pattern Forms

	Prohibited	Correct
Placing Close to Chassis	<p>in section</p>	<p>in section</p>
Placing of Chip Components and Leaded Components	<p>in section</p>	<p>in section</p>
Placing of Leaded Components after Chip Component	<p>in section</p>	<p>in section</p>
Lateral Mounting		<p>Solder Resist</p>

2. Land Dimensions

2-1. Please refer to the land dimensions in table 1 for flow soldering, table 2 for reflow soldering, table 3 for reflow soldering for ZRB Series, table 4 for reflow soldering for LLA Series, table 5 for reflow soldering for LLM Series.

Please confirm the suitable land dimension by evaluating of the actual SET / PCB.

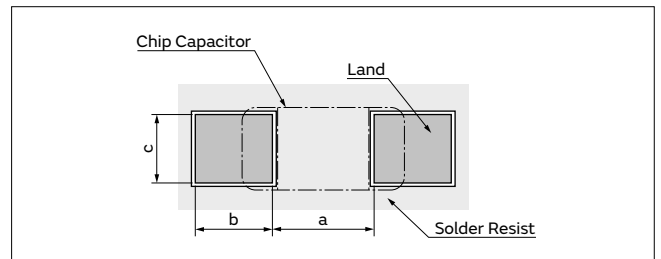

Table 1 Flow Soldering Method

Series	Chip Dimension Code (L/W)	Chip (L×W)	a	b	c
GQM/GR3/GRJ/GRM	18	1.6×0.8	0.6 to 1.0	0.8 to 0.9	0.6 to 0.8
GQM/GR3/GRJ/GRM	21	2.0×1.25	1.0 to 1.2	0.9 to 1.0	0.8 to 1.1
GR3/GRJ/GRM	31	3.2×1.6	2.2 to 2.6	1.0 to 1.1	1.0 to 1.4
LLL	21	1.25×2.0	0.4 to 0.7	0.5 to 0.7	1.4 to 1.8
LLL	31	1.6×3.2	0.6 to 1.0	0.8 to 0.9	2.6 to 2.8

Flow soldering can only be used for products with a chip size from 1.6x0.8mm to 3.2x1.6mm.

(in mm)

Continued on the following page. ↗

Notice

Continued from the preceding page. ↘

Table 2 Reflow Soldering Method

Series	Chip Dimension Code (L/W)	Chip (L×W)	a	b	c
GJM/GRM	02	0.4×0.2	0.16 to 0.2	0.12 to 0.18	0.2 to 0.23
GJM/GRM	03	0.6×0.3 (±0.03)	0.2 to 0.25	0.2 to 0.3	0.25 to 0.35
		0.6×0.3 (±0.05)	0.2 to 0.25	0.25 to 0.35	0.3 to 0.4
		0.6×0.3 (±0.09)	0.23 to 0.3	0.25 to 0.35	0.3 to 0.4
GJM/GRM	15	1.0×0.5 (within ±0.10)	0.3 to 0.5	0.35 to 0.45	0.4 to 0.6
		1.0×0.5 (±0.15/±0.20)	0.4 to 0.6	0.4 to 0.5	0.5 to 0.7
GQM/GR3/GRJ/GRM	18	1.6×0.8 (within ±0.10)	0.6 to 0.8	0.6 to 0.7	0.6 to 0.8
		1.6×0.8 (±0.15/±0.20)	0.7 to 0.9	0.7 to 0.8	0.8 to 1.0
GQM	21	2.0×1.25	1.0 to 1.2	0.6 to 0.7	0.8 to 1.1
GR3/GRJ/GRM/GR7	21	2.0×1.25 (within ±0.10)	1.2	0.6	1.25
		2.0×1.25 (±0.15)	1.2	0.6 to 0.8	1.2 to 1.4
		2.0×1.25 (±0.20)	1.0 to 1.4	0.6 to 0.8	1.2 to 1.4
GQM	22	2.8×2.8	2.2 to 2.5	0.8 to 1.0	1.9 to 2.3
GR3/GRJ/GRM/GR7	31	3.2×1.6 (within ±0.20)	1.8 to 2.0	0.9 to 1.2	1.5 to 1.7
		3.2×1.6 (±0.30)	1.9 to 2.1	1.0 to 1.3	1.7 to 1.9
GR3/GRJ/GRM	32	3.2×2.5	2.0 to 2.4	1.0 to 1.2	1.8 to 2.3
GA2/GA3/GR4	42	4.5×2.0	2.8 to 3.4	1.2 to 1.4	1.4 to 1.8
GR3/GRJ/GRM/GA2/GA3/GR4	43	4.5×3.2	3.0 to 3.5	1.2 to 1.4	2.3 to 3.0
GA2/GA3	52	5.7×2.8	4.0 to 4.6	1.4 to 1.6	2.1 to 2.6
GR3/GRJ/GRM/GA2/GA3/GR4	55	5.7×5.0	4.0 to 4.6	1.4 to 1.6	3.5 to 4.8
LLL	15	0.5×1.0	0.15 to 0.2	0.2 to 0.25	0.7 to 1.0
LLL	1U	0.6×1.0	0.20 to 0.25	0.25 to 0.35	0.7 to 1.0
LLL/LLR	18	0.8×1.6	0.2 to 0.3	0.3 to 0.4	1.4 to 1.6
LLL	21	1.25×2.0	0.4 to 0.5	0.4 to 0.5	1.4 to 1.8
LLL	31	1.6×3.2	0.6 to 0.8	0.6 to 0.7	2.6 to 2.8

(in mm)

<Applicable to Part Number KR3/KRM>

Series	Chip Dimension Code (L/W)	Chip (L×W)	a	b	c
KRM	21	2.0×1.25	1.0 to 1.2	0.6 to 0.7	0.8 to 1.1
KRM	31	3.2×1.6	2.2 to 2.4	0.8 to 0.9	1.0 to 1.4
KR3/KRM	55	5.7×5.0	2.6	2.7	5.6

(in mm)

Table 3 ZRB Series Reflow Soldering Method

Series	Chip Dimension Code (L/W)	Chip (L×W)	a	b	c
ZRB	15	1.0×0.5	0.4 to 0.6	0.4 to 0.5	0.5 to 0.7
ZRB	18*	1.6×0.8	0.7 to 0.9	0.7 to 0.8	0.8 to 1.0

*If distance between parts is too short, there is risk to cause electrical short. Please confirm the mounting pitch (distance between centers of parts) has 1.275mm or more. (ZRB18 only)

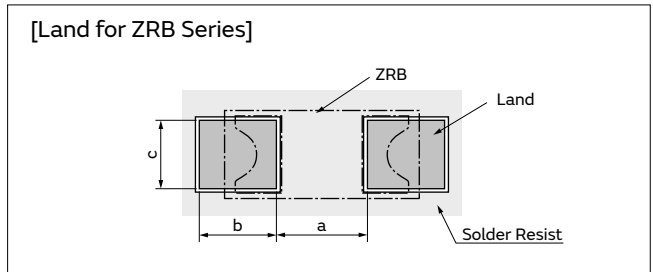

Table 4 LLA Series Reflow Soldering Method

Series	Chip Dimension Code (L/W)	Chip (L×W)	a	b	c	p
LLA	18	1.6×0.8	0.3 to 0.4	0.25 to 0.35	0.15 to 0.25	0.4
LLA	21	2.0×1.25	0.5 to 0.7	0.35 to 0.6	0.2 to 0.3	0.5

(in mm)

Continued on the following page. ↗

Notice

Continued from the preceding page. ↘

Table 5 LLM Series Reflow Soldering Method

Series	Chip Dimension Code (L/W)	Chip (L×W)	a	b, b'	c, c'	d	e	f	p
LLM	21	2.0×1.25	0.6 to 0.8	(0.3 to 0.5)	0.3	2.0 to 2.6	1.3 to 1.8	1.4 to 1.6	0.5

$b=(c-e)/2, b'=(d-f)/2$ (in mm)

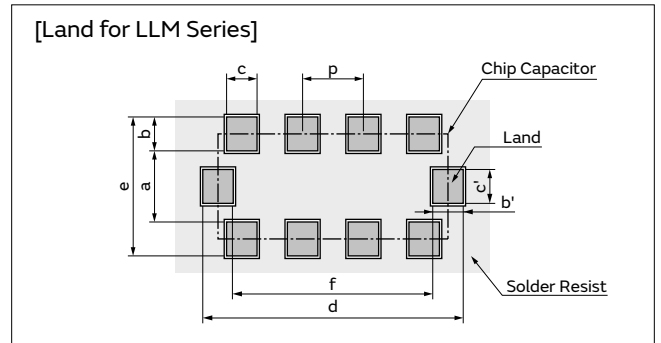
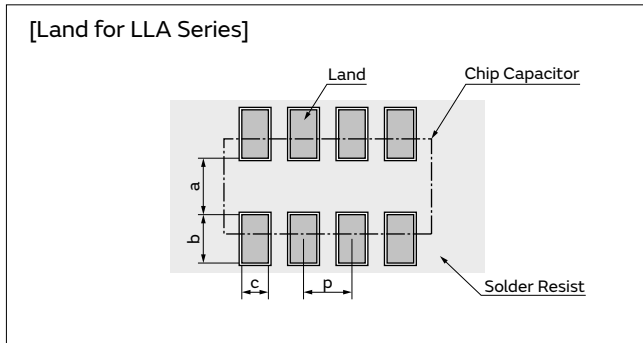

<Applicable to beyond Rated Voltage of 200VDC>

2-2. Dimensions of Slit (Example)

Preparing the slit helps flux cleaning and resin coating on the back of the capacitor.

However, the length of the slit design should be as short as possible to prevent mechanical damage in the capacitor.

A longer slit design might receive more severe mechanical stress from the PCB.

Recommended slit design is shown in the Table.

L×W	d	e
1.6×0.8	-	-
2.0×1.25	-	-
3.2×1.6	1.0 to 2.0	3.2 to 3.7
3.2×2.5	1.0 to 2.0	4.1 to 4.6
4.5×2.0	1.0 to 2.8	3.6 to 4.1
4.5×3.2	1.0 to 2.8	4.8 to 5.3
5.7×2.8	1.0 to 4.0	4.4 to 4.9
5.7×5.0	1.0 to 4.0	6.6 to 7.1

(in mm)

Continued on the following page. ↗

Notice

Continued from the preceding page. ↘

<Applicable to NFM Series>

■ Land Pattern + Solder Resist ■ Land Pattern □ Solder Resist (in mm)

Series	Land Dimensions																																									
NFM15CC NFM15PC NFM18CC NFM18PC NFM18PS NFM21CC NFM21PC NFM21PS	● Reflow Soldering																																									
	NFM15CC/NFM15PC 	NFM18CC/NFM18PC Small diameter thru hole $\phi 0.2\text{-}\phi 0.3$ 	NFM18PS Small diameter thru hole $\phi 0.2$ 																																							
	NFM21CC/NFM21PC Small diameter thru hole $\phi 0.4$ 	NFM21PS Small diameter thru hole $\phi 0.2\text{-}\phi 0.3$ 																																								
	● Reflow Soldering Chip mounting side NFM3DCC/NFM3DPC/NFM31PC/NFM41CC/NFM41PC Small diameter thru hole $\phi 0.4$ <table border="1" style="margin-left: auto; margin-right: auto;"> <thead> <tr> <th rowspan="2">Part Number</th> <th colspan="7">Size (mm)</th> </tr> <tr> <th>a</th> <th>b</th> <th>c</th> <th>d</th> <th>e</th> <th>f</th> <th>g</th> </tr> </thead> <tbody> <tr> <td>NFM3DCC NFM3DPC</td> <td>1.0</td> <td>1.4</td> <td>2.5</td> <td>4.4</td> <td>1.0</td> <td>2.0</td> <td>2.4</td> </tr> <tr> <td>NFM31PC</td> <td>1.0</td> <td>1.4</td> <td>2.5</td> <td>4.4</td> <td>1.2</td> <td>2.6</td> <td>3.0</td> </tr> <tr> <td>NFM41CC NFM41PC</td> <td>1.5</td> <td>2.0</td> <td>3.5</td> <td>6.0</td> <td>1.2</td> <td>2.6</td> <td>3.0</td> </tr> </tbody> </table>			Part Number	Size (mm)							a	b	c	d	e	f	g	NFM3DCC NFM3DPC	1.0	1.4	2.5	4.4	1.0	2.0	2.4	NFM31PC	1.0	1.4	2.5	4.4	1.2	2.6	3.0	NFM41CC NFM41PC	1.5	2.0	3.5	6.0	1.2	2.6	3.0
	Part Number	Size (mm)																																								
		a	b	c	d	e	f	g																																		
NFM3DCC NFM3DPC	1.0	1.4	2.5	4.4	1.0	2.0	2.4																																			
NFM31PC	1.0	1.4	2.5	4.4	1.2	2.6	3.0																																			
NFM41CC NFM41PC	1.5	2.0	3.5	6.0	1.2	2.6	3.0																																			
● Flow Soldering Chip mounting side NFM31KC*1 Small diameter thru hole $\phi 0.4$ <p>10mm or more (in case of 10A)</p> <p>*1 For large current design, width of signal land pattern should be wider not less than 1mm per 1A (1mm/A). For example, in case of 10A, signal land pattern width should be 10mm or more. (1mm/A*10A=10mm)</p>																																										
● Reflow Soldering Chip mounting side NFM31KC*1 Small diameter thru hole $\phi 0.4$ <p>10mm or more (in case of 10A)</p> <p>*1 For large current design, width of signal land pattern should be wider not less than 1mm per 1A (1mm/A). For example, in case of 10A, signal land pattern width should be 10mm or more. (1mm/A*10A=10mm)</p>																																										

Continued on the following page. ↗

GRM
 GR3
 GRJ
 GRU
 GR4
 GR7
 GJM
 GQM
 GA2
 GA3 GB
 GA3 GD
 GA3 GF
 LLL
 LLA
 LLM
 LLR
 NFM
 KRM
 KR3
 GMA
 GMD
 Notice
 287

Notice

Continued from the preceding page. ↘

3. Board Design

When designing the board, keep in mind that the amount of strain which occurs will increase depending on the size and material of the board.

[Relationship with amount of strain to the board thickness, length, width, etc.]

$$\epsilon = \frac{3PL}{2Ewh^2} \quad \text{Relationship between load and strain}$$

ϵ : Strain on center of board (μst)
 L : Distance between supporting points (mm)
 w : Board width (mm)
 h : Board thickness (mm)
 E : Elastic modulus of board ($\text{N}/\text{m}^2=\text{Pa}$)
 Y : Deflection (mm)
 P : Load (N)

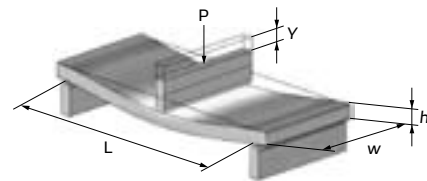

When the load is constant, the following relationship can be established.

- As the distance between the supporting points (L) increases, the amount of strain also increases.
→Reduce the distance between the supporting points.
 - As the elastic modulus (E) decreases, the amount of strain increases.
→Increase the elastic modulus.
 - As the board width (w) decreases, the amount of strain increases.
→Increase the width of the board.
 - As the board thickness (h) decreases, the amount of strain increases.
→Increase the thickness of the board.
- Since the board thickness is squared, the effect on the amount of strain becomes even greater.

2. Adhesive Application

If you want to temporarily attach the capacitor to the board using an adhesive agent before soldering the capacitor, first be sure that the conditions are appropriate for affixing the capacitor. If the dimensions of the land, the type of adhesive, the amount of coating, the contact surface area, the curing temperature, or other conditions are inappropriate, the characteristics of the capacitor may deteriorate.

1. Selection of Adhesive

1-1. Depending on the type of adhesive, there may be a decrease in insulation resistance. In addition, there is a chance that the capacitor might crack from contractile stress due to the difference in the contraction rate of the capacitor and the adhesive.

1-2. If there is not enough adhesive, the contact surface area is too small, or the curing temperature or curing time are inadequate, the adhesive strength will be insufficient and the capacitor may loosen or become disconnected during transportation or soldering.

If there is too much adhesive, for example if it overflows onto the land, the result could be soldering defects, loss of electrical connection, insufficient curing, or slippage after the capacitor is mounted.

Furthermore, if the curing temperature is too high or the curing time is too long, not only will the adhesive

strength be reduced, but solderability may also suffer due to the effects of oxidation on the terminations (outer electrodes) of the capacitor and the land surface on the board.

(1) Selection of Adhesive

Epoxy resins are a typical class of adhesive.

To select the proper adhesive, consider the following points.

- 1) There must be enough adhesive strength to prevent the component from loosening or slipping during the mounting process.
- 2) The adhesive strength must not decrease when exposed to moisture during soldering.
- 3) The adhesive must have good coatability and shape retention properties.
- 4) The adhesive must have a long pot life.
- 5) The curing time must be short.
- 6) The adhesive must not be corrosive to the exterior of the capacitor or the board.
- 7) The adhesive must have good insulation properties.
- 8) The adhesive must not emit toxic gases or otherwise be harmful to health.
- 9) The adhesive must be free of halogenated compounds.

Continued on the following page. ↗

GRM

GR3

GRJ

GR4

GR7

GJM

GQM

GA2

GA3
GB

GA3
GD

GA3
GF

LLL

LLA

LLM

LLR

NFM

KRM

KR3

GMA

GMD

Notice

Notice

Continued from the preceding page. ↘

(2) Use the following illustration as a guide to the amount of adhesive to apply.

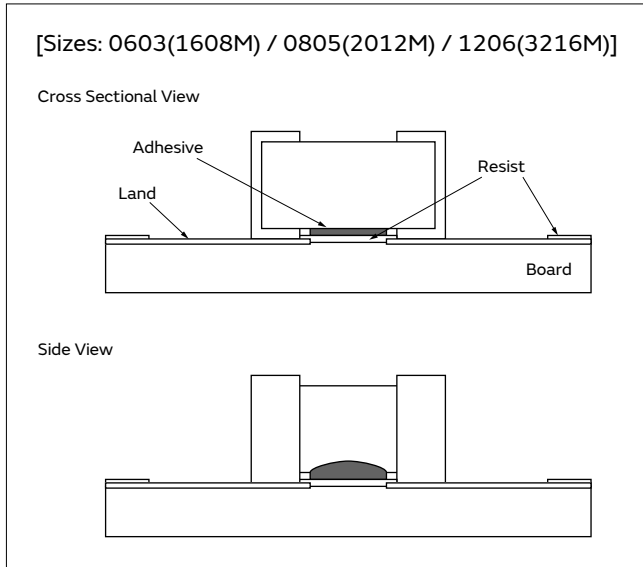

<Applicable to NFM Series>

[Sizes: 1205(3212M) / 1206(3216M) / 1806(4516M)]

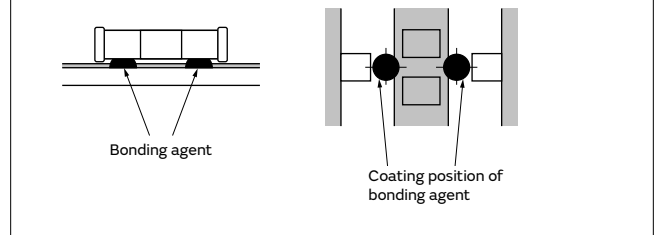

3. Adhesive Curing

1. Insufficient curing of the adhesive can cause chips to disconnect during flow soldering and causes deterioration in the insulation resistance between the terminations due to moisture absorption.

Control curing temperature and time in order to prevent insufficient hardening.

4. Flux for Flow Soldering

1. An excessive amount of flux generates a large quantity of flux gas, which can cause a deterioration of solderability, so apply flux thinly and evenly throughout. (A foaming system is generally used for flow soldering.)

2. Flux containing too high a percentage of halide may cause corrosion of the terminations unless there is sufficient cleaning. Use flux with a halide content of 0.1% max.
 3. Strong acidic flux can corrode the capacitor and degrade its performance.
 Please check the quality of capacitor after mounting.

5. Flow Soldering

● Set temperature and time to ensure that leaching of the terminations does not exceed 25% of the chip end area as a single chip (full length of the edge A-B-C-D shown at right) and 25% of the length A-B shown as mounted on substrate.

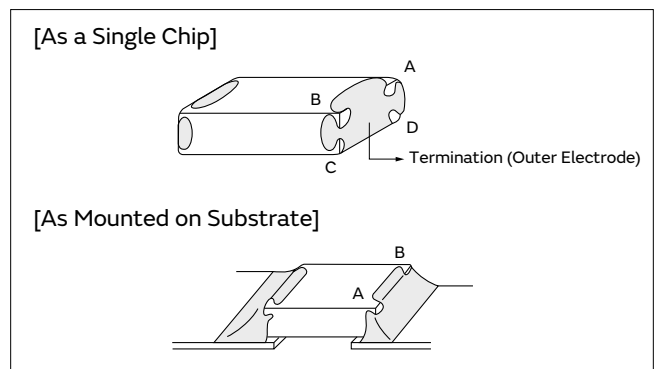

6. Reflow Soldering

The flux in the solder paste contains halogen-based substances and organic acids as activators. Strong acidic flux can corrode the capacitor and degrade its performance.

Please check the quality after mounting, please use.

Continued on the following page. ↗

Notice

Continued from the preceding page. ↘

7. Washing

1. Please evaluate the capacitor using actual cleaning equipment and conditions to confirm the quality, and select the solvent for cleaning.

8. Coating

1. A crack may be caused in the capacitor due to the stress of the thermal contraction of the resin during curing process.
The stress is affected by the amount of resin and curing contraction.
Select a resin with low curing contraction.
The difference in the thermal expansion coefficient between a coating resin or a molding resin and the capacitor may cause the destruction and deterioration of the capacitor such as a crack or peeling, and lead to the deterioration of insulation resistance or dielectric breakdown.
Select a resin for which the thermal expansion coefficient is as close to that of the capacitor as possible.
A silicone resin can be used as an under-coating to buffer against the stress.

2. Unsuitable cleaning may leave residual flux or other foreign substances, causing deterioration of electrical characteristics and the reliability of the capacitors.

2. Select a resin that is less hygroscopic.
Using hygroscopic resins under high humidity conditions may cause the deterioration of the insulation resistance of a capacitor.
An epoxy resin can be used as a less hygroscopic resin.
3. The halogen system substance and organic acid are included in coating material, and a chip corrodes by the kind of Coating material.
Do not use strong acid type.

<Applicable to ZRB Series>

4. Loss suppress acoustic noise may be caused in ZRB series due to the resin during curing process. Please contact our sales representative or product engineers on the apply to resin during curing process.

Other

1. Transportation

1. The performance of a capacitor may be affected by the conditions during transportation.
 - 1-1. The capacitors shall be protected against excessive temperature, humidity, and mechanical force during transportation.
 - (1) Climatic condition
 - low air temperature: -40°C
 - change of temperature air/air: -25°C/+25°C
 - low air pressure: 30 kPa
 - change of air pressure: 6 kPa/min.
 - (2) Mechanical condition
Transportation shall be done in such a way that the boxes are not deformed and forces are not directly passed on to the inner packaging.
 - 1-2. Do not apply excessive vibration, shock, or pressure to the capacitor.
 - (1) When excessive mechanical shock or pressure is applied to a capacitor, chipping or cracking may occur in the ceramic body of the capacitor.
 - (2) When the sharp edge of an air driver, a soldering iron, tweezers, a chassis, etc. impacts strongly on the surface of the capacitor, the capacitor may crack and short-circuit.
 - 1-3. Do not use a capacitor to which excessive shock was applied by dropping, etc.
A capacitor dropped accidentally during processing may be damaged.

2. Characteristics Evaluation in the Actual System

1. Evaluate the capacitor in the actual system, to confirm that there is no problem with the performance and specification values in a finished product before using.
2. Since a voltage dependency and temperature dependency exists in the capacitance of high dielectric type ceramic capacitors, the capacitance may change depending on the operating conditions in the actual system. Therefore, be sure to evaluate the various characteristics, such as the leakage current and noise absorptivity, which will affect the capacitance value of the capacitor.
3. In addition, voltages exceeding the predetermined surge may be applied to the capacitor by the inductance in the actual system. Evaluate the surge resistance in the actual system as required.

<Applicable to NFM Series>

4. The effects of noise suppression can vary depending on the usage conditions, including differences in the circuit or IC to be used, the type of noise, the shape of the pattern to be mounted, and the mounting location. Be sure to verify the effect on the actual device in advance.

GRM

GR3

GRJ

GR4

GR7

GJM

GQM

GA2

GA3
GB

GA3
GD

GA3
GF

LLL

LLA

LLM

LLR

NFM

KRM

KR3

GMA

GMD

Notice

Design Support Tool "SimSurfing"

<https://www.murata.com/simsurfing/>

This is the latest tool to get the electrical characteristics for Capacitors, Inductors, and EMI Suppression Filters, and to simulate Thermistors' behavior !



■ Characteristics viewer

You can easily search and download the following data for Multilayer Ceramic Capacitors, Polymer Capacitors, EMI Suppression Filters (Three-terminal Capacitors, Ferrite Beads) and Power/RF Inductors.

■ Components performance simulator

You can search by the simulation on simple circuits for Thermistors.

■ Selection tool

You can select Medium voltage Capacitors and Power Inductors according to conditions of use.

* Medium voltage: Rated Voltage 250V and over

■ Search tool

You can search the Murata timing device (CERALOCK® and crystal units) that is most suitable for your IC and access information about the recommended circuit constant setting.

If you register as a "my Murata" user

(<https://my.murata.com/en/web/mymurata/>), you can use Enhanced SimSurfing.

■ Usage example of "Multilayer Ceramic Capacitors"

1 Select the products

- (1) By performance/type
- (2) By part number

2 Show graph

Click each button on each tab of [Basic], [S-parameter] and [Detailed].

3 Data download

- Click each purple button in this area.
- Click "CSV output" button.

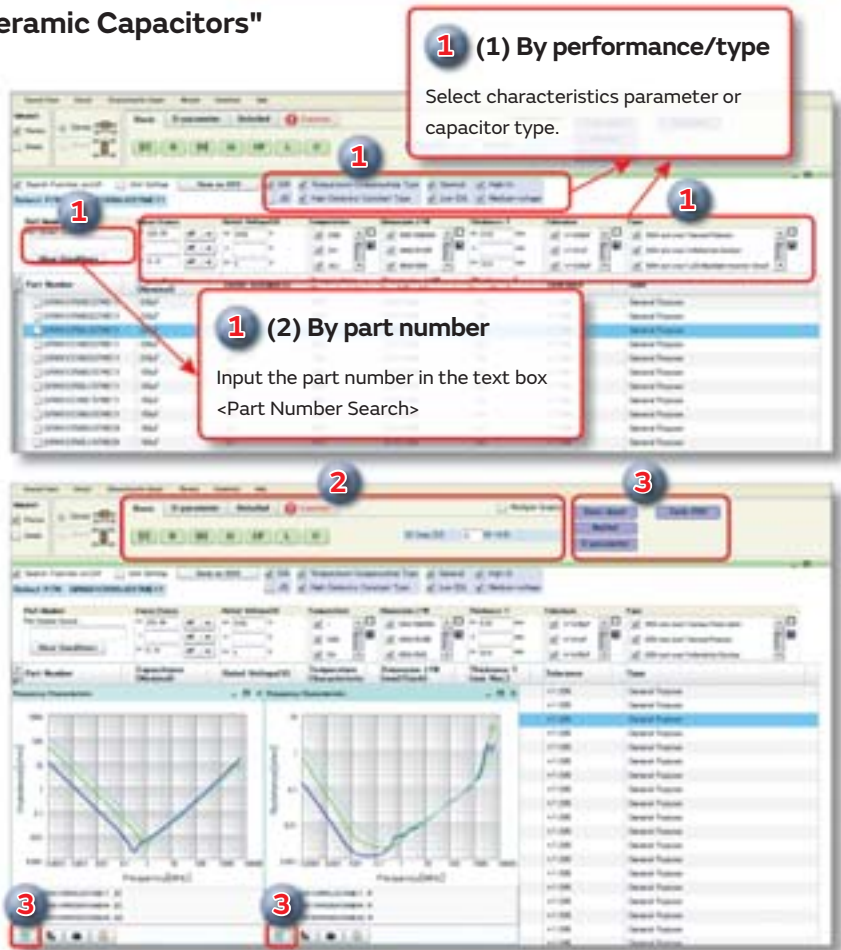

* Images are as of October 2015. Be assured that this software will be updated frequently.

<https://www.murata.com/simsurfing/>

Web page Introduction

muRata Product Search



1 Search by Part Number <http://psearch.en.murata.com/capacitor/partnumber/>



You can search for capacitors by specifying the alphanumeric characters in the part number. The packing codes shown contain the substitute character "#". If you enter the official packing code, part numbers that contain that packing code will be matched.

2 Search by Specifications <http://psearch.en.murata.com/capacitor/spec/smd/>



You can search for SMD, lead type, or screw termination type capacitors by indicating specifications such as application, capacitance, rated voltage, or temperature characteristics.

You can narrow your search by entering values of ranges, and by specifying product characteristics.

The items for narrowing searches are linked, so specifying one condition causes selectable options for the other items to allow input only of conditions that match the relevant part numbers.



Search in the Lineups <http://psearch.en.murata.com/capacitor/lineup/>

You can search for capacitors by specifying the series lineup.

You can also confirm items such as characteristics and applications on each series page.

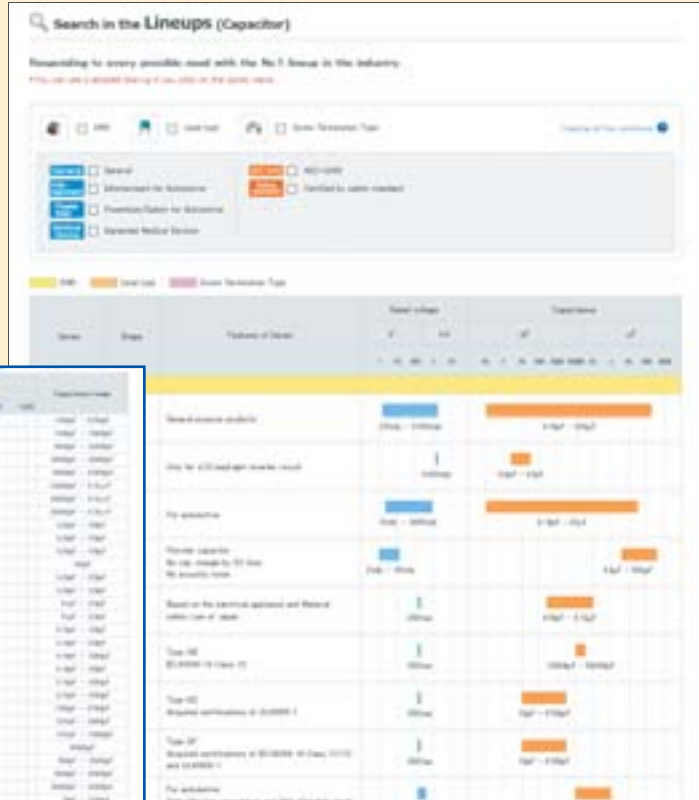

Capacitance chart in Series page.

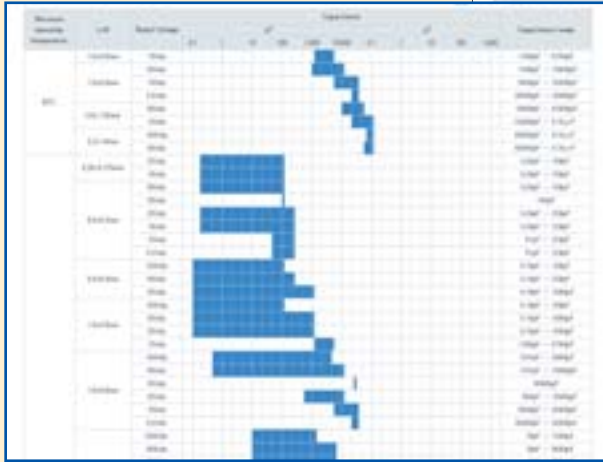

[Search result]

Compares the characteristics of the checked part numbers.

Displays the number of hits for the current search conditions in real time.

Clicking on each search condition button brings up a menu, allowing you to narrow the search results to match the selected condition in real time.

Click "Current search terms" to display a menu, from which you can confirm the current conditions for narrowing the search results.

Click the ▲ mark for each item to switch between ascending and descending display.

Click a product name to display a details page listing more in-depth information (→ P39).

You can download detailed spec sheets.

Icons enable you to check the status and characteristics of products at a glance.

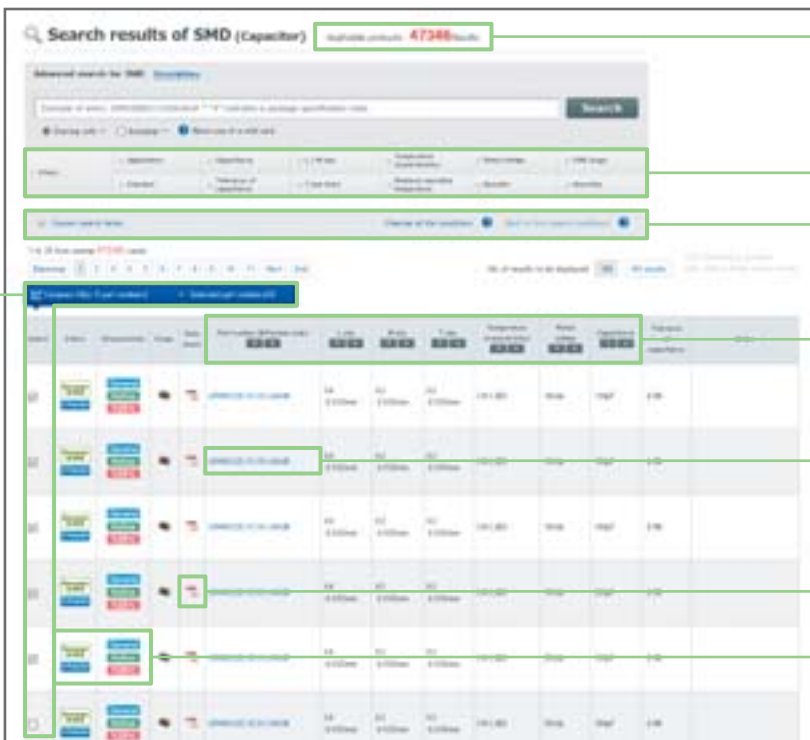

Global Locations

For details please visit www.murata.com



⚠ Note

1 Export Control

For customers outside Japan:

No Murata products should be used or sold, through any channels, for use in the design, development, production, utilization, maintenance or operation of, or otherwise contribution to (1) any weapons (Weapons of Mass Destruction [nuclear, chemical or biological weapons or missiles] or conventional weapons) or (2) goods or systems specially designed or intended for military end-use or utilization by military end-users.

For customers in Japan:

For products which are controlled items subject to the "Foreign Exchange and Foreign Trade Law" of Japan, the export license specified by the law is required for export.

2 Please contact our sales representatives or product engineers before using the products in this catalog for the applications listed below, which require especially high reliability for the prevention of defects which might directly damage a third party's life, body or property, or when one of our products is intended for use in applications other than those specified in this catalog.

- ① Aircraft equipment
- ② Aerospace equipment
- ③ Undersea equipment
- ④ Power plant equipment
- ⑤ Medical equipment
- ⑥ Transportation equipment (vehicles, trains, ships, etc.)
- ⑦ Traffic signal equipment
- ⑧ Disaster prevention / crime prevention equipment
- ⑨ Data-processing equipment
- ⑩ Application of similar complexity and/or reliability requirements to the applications listed above

3 Product specifications in this catalog are as of September 2017. They are subject to change or our products in it may be discontinued without advance notice. Please check with our sales representatives or product engineers before ordering. If there are any questions, please contact our sales representatives or product engineers.

4 Please read rating and ⚠CAUTION (for storage, operating, rating, soldering, mounting and handling) in this catalog to prevent smoking and/or burning, etc.

5 This catalog has only typical specifications. Therefore, please approve our product specifications or transact the approval sheet for product specifications before ordering.

6 Please note that unless otherwise specified, we shall assume no responsibility whatsoever for any conflict or dispute that may occur in connection with the effect of our and/or a third party's intellectual property rights and other related rights in consideration of your use of our products and/or information described or contained in our catalogs. In this connection, no representation shall be made to the effect that any third parties are authorized to use the rights mentioned above under licenses without our consent.

7 No ozone depleting substances (ODS) under the Montreal Protocol are used in our manufacturing process.

Murata Manufacturing Co., Ltd.

www.murata.com

muRata
INNOVATOR IN ELECTRONICS

X-ON Electronics

Largest Supplier of Electrical and Electronic Components

Click to view similar products for [Multilayer Ceramic Capacitors MLCC - SMD/SMT](#) category:

Click to view products by [Murata](#) manufacturer:

Other Similar products are found below :

[M39014/01-1467](#) [M39014/02-1218V](#) [M39014/02-1225V](#) [M39014/02-1262V](#) [M39014/02-1301](#) [M39014/22-0631](#) [1210J5000102JCT](#)
[1210J2K00102KXT](#) [1210J5000103KXT](#) [1210J5000223KXT](#) [D55342E07B379BR-TR](#) [D55342E07B523DR-T/R](#) [1812J1K00103KXT](#)
[1812J1K00473KXT](#) [1812J2K00680JCT](#) [1812J4K00102MXT](#) [1812J5000102JCT](#) [1812J5000103JCT](#) [1812J5000682JCT](#) [NIN-FB391JTRF](#)
[NIN-FC2R7JTRF](#) [NPIS27H102MTRF](#) [C1206C101J1GAC](#) [C1608C0G1E472JT000N](#) [C2012C0G2A472J](#) [2220J2K00101JCT](#)
[KHC201E225M76N0T00](#) [LRC-LRF1206LF-01R025FTR1K](#) [1812J1K00222JCT](#) [1812J2K00102KXT](#) [1812J2K00222KXT](#)
[1812J2K00472KXT](#) [2-1622820-7-CUT-TAPE](#) [2220J3K00102KXT](#) [2225J2500824KXT](#) [CCR07CG103KM](#) [CGA2B2C0G1H010C](#)
[CGA2B2C0G1H040C](#) [CGA2B2C0G1H050C](#) [CGA2B2C0G1H060D](#) [CGA2B2C0G1H070D](#) [CGA2B2C0G1H151J](#) [CGA2B2C0G1H1R5C](#)
[CGA2B2C0G1H2R2C](#) [CGA2B2C0G1H3R3C](#) [CGA2B2C0G1H680J](#) [CGA2B2C0G1H6R8D](#) [CGA2B2X8R1H221K](#) [CGA2B2X8R1H472K](#)
[CGA3E1X7R1C474K](#)