

# Chip Monolithic Ceramic Capacitors

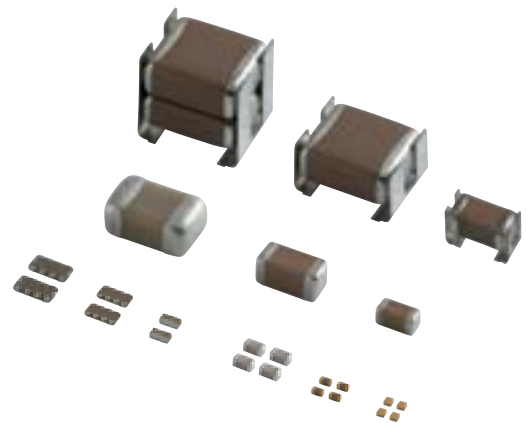

## Explanation of Symbols in This Catalog

**Ultra-compact**

Lx W dimension: products of 0.6 x 0.3 mm or less

**High Q**

Low dissipation for high frequency  
 By devising ceramic materials and electrode materials, low dissipation is achieved in frequency bands of VHF, UHF and microwave or beyond.

**Low ESL**

Low inductance  
 This capacitor is designed so that the parasitic inductance component (ESL) that the capacitor has on the high frequency side becomes lower.

**Anti-noise**

Product suitable for acoustic noise reduction and low distortion  
 This product suppresses acoustic noise, which occurs when a ceramic capacitor is used, by devising the materials and configuration.

**Deflecting crack**

Product resistant to deflection cracking  
 This capacitor is designed to prevent failures as much as possible by short mode caused by cracking when there is board deflection.

**Soldering crack**

Product with solder cracking suppression  
 This capacitor is configured with metal terminals and leads connected to the chip.  
 The metal terminals and leads relieve the stress from expansion and contraction of the solder, to suppress solder cracking.

**Derating**

Voltage and temperature derating recommended product  
 This product is suitable when a voltage continuously applied to a capacitor in an operating circuit, is used below (derated) the rated voltage of the capacitor.  
 This model guarantees the test conditions in the endurance test, at a rated voltage x 100% at the maximum operating temperature. A reliability assurance level equivalent to a common product can be secured, by using this product within the voltage and temperature derated conditions recommended in the figure below.

Recommended Conditions of the Derating Operating Voltage and Temperature

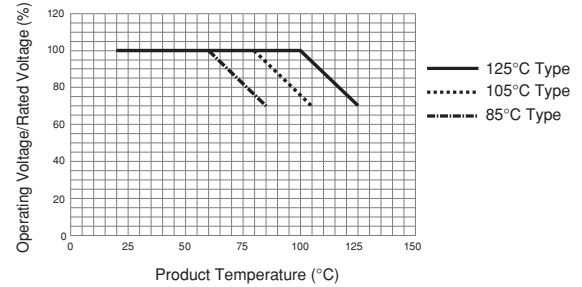

**EU RoHS Compliant**

- All the products in this catalog comply with EU RoHS.
- EU RoHS is "the European Directive 2011/65/EU on the Restriction of the Use of Certain Hazardous Substances in Electrical and Electronic Equipment."
- For more details, please refer to our website 'Murata's Approach for EU RoHS' (<http://www.murata.com/info/rohs.html>).

# Contents

Product specifications are as of August 2014.

|  |      |                           |
|--|------|---------------------------|
| Part Numbering .....   | p2   |                           |
| Selection Guide .....  | p5   |                           |
| Capacitance Table .....  | p6   |                           |
| <u>Cap. Table</u>  |      |                           |
| For General Purpose GRM Series .....   | p17  | separate volume<br>p1–p16 |
| <hr/>  |      |                           |
| High Frequency High Q Type<br>1005(in mm)/0402(in inch) Size Max. GJM Series .....                 | p87  | p7                        |
| <hr/>  |      |                           |
| Top & Bottom Electrode Type for Bonding<br>GMA Series .....  | p109 | p8                        |
| <hr/>  |      |                           |
| Product for Bonding/AuSn Soldering<br>GMD Series .....   | p111 | p9                        |
| <hr/>  |      |                           |
| High Frequency High Q Type<br>1608(in mm)/0603(in inch) Size Min. GQM Series .....                 | p114 | p10                       |
| <hr/>  |      |                           |
| Resin External Electrode Type GRJ Series .....   | p123 | p11                       |
| <hr/>  |      |                           |
| High Effective Capacitance &<br>High Allowable Ripple Current GR3 Series .....                     | p125 | p12                       |
| <hr/>  |      |                           |
| Metal Terminal Type For General Purpose<br>KRM Series .....  | p127 | p13                       |
| <hr/>  |      |                           |
| Metal Terminal Type High Effective Capacitance &<br>High Allowable Ripple Current KR3 Series ..... | p130 | p14                       |
| <hr/>  |      |                           |
| 8-Terminal Low ESL Type LLA Series .....   | p133 | p14                       |
| <hr/>  |      |                           |
| LW Reversed Low ESL Type LLL Series .....  | p135 | p15                       |
| <hr/>  |      |                           |
| 10-Terminal Low ESL Type LLM Series .....  | p137 | p15                       |
| <hr/>  |      |                           |
| ESR Controlled Low ESL Type LLR Series .....   | p139 | p15                       |
| <hr/>  |      |                           |
| ⚠Caution/Notice .....  | p141 |                           |
| Qualified Standards .....  | p163 |                           |
| Introduction of Website SimSurfing .....   | p165 |                           |
| Product Information .....  | p166 |                           |

Please check the MURATA home page (<http://www.murata.com/>) if you cannot find the part number in the catalog.

## ● Part Numbering

### Chip Monolithic Ceramic Capacitors for General

(Part Number) 

|    |   |    |   |    |    |     |   |     |   |
|----|---|----|---|----|----|-----|---|-----|---|
| GR | M | 18 | 8 | B1 | 1H | 102 | K | A01 | D |
| ①  | ② | ③  | ④ | ⑤  | ⑥  | ⑦   | ⑧ | ⑨   | ⑩ |

#### ① Product ID ② Series

| Product ID | Code | Series  |
|------------|------|---|
| GJ         | M    | High frequency HiQ type<br>1005(in mm)/0402(in inch) size max.                    |
|            | A    | Top & bottom electrode type for bonding   |
| GM         | D    | Product for bonding/AuSn soldering  |
|            | M    | High frequency HiQ type<br>1608(in mm)/0603(in inch) size min.                    |
| GR         | 3    | High effective capacitance &<br>High allowable ripple current                     |
|            | J    | Resin external electrode type   |
|            | M    | General purpose products  |
| KR         | 3    | Metal terminal type/High effective capacitance &<br>High allowable ripple current |
|            | M    | Metal terminal type   |
| LL         | A    | 8-terminal low ESL type   |
|            | L    | LW reversed low ESL type  |
|            | M    | 10-terminal low ESL type  |
|            | R    | ESR Controlled low ESL type   |

#### ④ Height Dimension (T) (Except KR□)

| Code | Dimension (T)                    |
|------|----------------------------------|
| 2    | 0.2mm                            |
| 3    | 0.3mm                            |
| 4    | 0.4mm                            |
| 5    | 0.5mm                            |
| 6    | 0.6mm                            |
| 7    | 0.7mm                            |
| 8    | 0.8mm                            |
| 9    | 0.85mm                           |
| A    | 1.0mm                            |
| B    | 1.25mm                           |
| C    | 1.6mm                            |
| D    | 2.0mm                            |
| E    | 2.5mm                            |
| M    | 1.15mm                           |
| Q    | 1.5mm                            |
| S    | 2.8mm                            |
| X    | Depends on individual standards. |

#### ③ Chip Dimensions (L×W)

| Code | Dimensions (L×W) | Size Code (in inch) |
|------|------------------|---------------------|
| 02   | 0.4×0.2mm        | 01005               |
| 03   | 0.6×0.3mm        | 0201                |
| 05   | 0.5×0.5mm        | 0202                |
| 08   | 0.8×0.8mm        | 0303                |
| 0D   | 0.38×0.38mm      | 015015              |
| 15   | 1.0×0.5mm        | 0402                |
| 18   | 1.6×0.8mm        | 0603                |
| 1U   | 0.6×1.0mm        | 02404               |
| 21   | 2.0×1.25mm       | 0805                |
| 22   | 2.8×2.8mm        | 1111                |
| 31   | 3.2×1.6mm        | 1206                |
| 32   | 3.2×2.5mm        | 1210                |
| 42   | 4.5×2.0mm        | 1808                |
| 43   | 4.5×3.2mm        | 1812                |
| 55   | 5.7×5.0mm        | 2220                |

#### ④ Height Dimension (T) (KR□ Only)

| Code | Dimension (T) |
|------|---------------|
| E    | 1.8mm         |
| F    | 1.9mm         |
| K    | 2.7mm         |
| L    | 2.8mm         |
| Q    | 3.7mm         |
| T    | 4.8mm         |
| W    | 6.4mm         |

Continued on the following page.

(Part Number)

GR M 18 8 B1 1H 102 K A01 D  
 ① ② ③ ④ ⑤ ⑥ ⑦ ⑧ ⑨ ⑩

Continued from the preceding page.

⑤ Temperature Characteristics

| Temperature Characteristic Codes |                 |     | Temperature Characteristics |                   |   |              | Operating Temperature Range | Capacitance Change Each Temperature (%) |       |       |       |      |       |
|----------------------------------|-----------------|-----|-----------------------------|-------------------|---|--------------|-----------------------------|---|-------|-------|-------|------|-------|
| Code                             | Public STD Code |     | Reference Temperature       | Temperature Range | Capacitance Change or Temperature Coefficient | -55°C        |                             | *3                                      |       | -10°C |       |      |       |
|                                  |                 |     |                             |                   |   | Max.         |                             | Min.                                    | Max.  | Min.  | Max.  | Min. |       |
| 1X                               | SL              | JIS | 20°C                        | 20 to 85°C        | +350 to -1000ppm/°C                           | -55 to 125°C |                             | -                                       | -     | -     | -     | -    | -     |
| 2C                               | CH              | JIS | 20°C                        | 20 to 125°C       | 0±60ppm/°C                                    | -55 to 125°C |                             | 0.82                                    | -0.45 | 0.49  | -0.27 | 0.33 | -0.18 |
| 3C                               | CJ              | JIS | 20°C                        | 20 to 125°C       | 0±120ppm/°C                                   | -55 to 125°C |                             | 1.37                                    | -0.9  | 0.82  | -0.54 | 0.55 | -0.36 |
| 3U                               | UJ              | JIS | 20°C                        | 20 to 85°C        | -750±120ppm/°C                                | -25 to 85°C  |                             | -                                       | -     | 4.94  | 2.84  | 3.29 | 1.89  |
| 4C                               | CK              | JIS | 20°C                        | 20 to 125°C       | 0±250ppm/°C                                   | -55 to 125°C |                             | 2.56                                    | -1.88 | 1.54  | -1.13 | 1.02 | -0.75 |
| 5C                               | C0G             | EIA | 25°C                        | 25 to 125°C       | 0±30ppm/°C                                    | -55 to 125°C |                             | 0.58                                    | -0.24 | 0.4   | -0.17 | 0.25 | -0.11 |
| 7U                               | U2J             | EIA | 25°C                        | 25 to 125°C *2    | -750±120ppm/°C                                | -55 to 125°C |                             | 8.78                                    | 5.04  | 6.04  | 3.47  | 3.84 | 2.21  |
| B1                               | B *1            | JIS | 20°C                        | -25 to 85°C       | ±10%  | -25 to 85°C  |                             | -                                       | -     | -     | -     | -    | -     |
| B3                               | B               | JIS | 20°C                        | -25 to 85°C       | ±10%  | -25 to 85°C  |                             | -                                       | -     | -     | -     | -    | -     |
| C7                               | X7S             | EIA | 25°C                        | -55 to 125°C      | ±22%  | -55 to 125°C |                             | -                                       | -     | -     | -     | -    | -     |
| C8                               | X6S             | EIA | 25°C                        | -55 to 105°C      | ±22%  | -55 to 105°C |                             | -                                       | -     | -     | -     | -    | -     |
| D7                               | X7T             | EIA | 25°C                        | -55 to 125°C      | +22%, -33%                                    | -55 to 125°C |                             | -                                       | -     | -     | -     | -    | -     |
| D8                               | X6T             | EIA | 25°C                        | -55 to 105°C      | +22%, -33%                                    | -55 to 105°C |                             | -                                       | -     | -     | -     | -    | -     |
| E7                               | X7U             | EIA | 25°C                        | -55 to 125°C      | +22%, -56%                                    | -55 to 125°C |                             | -                                       | -     | -     | -     | -    | -     |
| R1                               | R *1            | JIS | 20°C                        | -55 to 125°C      | ±15%  | -55 to 125°C |                             | -                                       | -     | -     | -     | -    | -     |
| R6                               | X5R             | EIA | 25°C                        | -55 to 85°C       | ±15%  | -55 to 85°C  |                             | -                                       | -     | -     | -     | -    | -     |
| R7                               | X7R             | EIA | 25°C                        | -55 to 125°C      | ±15%  | -55 to 125°C |                             | -                                       | -     | -     | -     | -    | -     |

\*1 Capacitance change is specified with 50% rated voltage applied.

\*2 Rated Voltage 100Vdc max: 25 to 85°C

\*3 -25°C (Reference Temperature 20°C) / -30°C (Reference Temperature 25°C)

⑥ Rated Voltage

| Code | Rated Voltage |
|------|---------------|
| 0E   | DC2.5V        |
| 0G   | DC4V          |
| 0J   | DC6.3V        |
| 1A   | DC10V         |
| 1C   | DC16V         |
| 1E   | DC25V         |
| 1H   | DC50V         |
| 1J   | DC63V         |
| 1K   | DC80V         |
| 2A   | DC100V        |
| 2D   | DC200V        |
| 2E   | DC250V        |
| 2W   | DC450V        |
| 2H   | DC500V        |
| 2J   | DC630V        |
| 3A   | DC1kV         |
| 3D   | DC2kV         |
| 3F   | DC3.15kV      |
| YA   | DC35V         |

⑦ Capacitance

Expressed by three-digit alphanumerics. The unit is picofarad (pF). The first and second figures are significant digits, and the third figure expresses the number of zeros which follow the two numbers. If there is a decimal point, it is expressed by the capital letter "R." In this case, all figures are significant digits. If any alphabet, other than "R", is included, this indicates the specific part number is a non-standard part.

Ex.)

| Code | Capacitance |
|------|-------------|
| R50  | 0.50pF      |
| 1R0  | 1.0pF       |
| 100  | 10pF        |
| 103  | 10000pF     |

⑧ Capacitance Tolerance

| Code | Capacitance Tolerance   |
|------|-------------------------|
| B    | ±0.1pF                  |
| C    | ±0.25pF                 |
| D    | ±0.5pF (10pF and below) |
|      | ±0.5% (10pF and over)   |
| F    | ±1%                     |
| G    | ±2%                     |
| J    | ±5%                     |
| K    | ±10%                    |
| M    | ±20%                    |
| W    | ±0.05pF                 |

Continued on the following page. ↗

(Part Number)

|    |   |    |   |    |    |     |   |     |    |
|----|---|----|---|----|----|-----|---|-----|----|
| GR | M | 18 | 8 | B1 | 1H | 102 | K | A01 | D  |
| 1  | 2 | 3  | 4 | 5  | 6  | 7   | 8 | 9   | 10 |

Continued from the preceding page.

⑨ Individual Specification Code (Except LLR)

Expressed by three figures.

⑨ ESR (LLR Only)

| Code | ESR    |
|------|--------|
| E01  | 100mΩ  |
| E03  | 220mΩ  |
| E05  | 470mΩ  |
| E07  | 1000mΩ |

⑩ Packaging

| Code  | Packaging              |
|-------|------------------------|
| L     | ø180mm Embossed Taping |
| D/E/W | ø180mm Paper Taping    |
| K     | ø330mm Embossed Taping |
| J/F   | ø330mm Paper Taping    |
| B     | Bulk                   |
| T     | Bulk Tray              |

Please contact us if you find any part number not provided in this table.

## Selection Guide for Chip Monolithic Ceramic Capacitors

| Series                     | Ultra-small (smaller than 0201)      | Low dissipation/HiQ | Low ESL | Fail safe | Anti-deflecting crack | Anti-soldering crack | Anti-noise, low distortion | For bonding | Specific applications | Safety standard certified type |  |
|----------------------------|--------------------------------------|---------------------|---------|-----------|-----------------------|----------------------|----------------------------|-------------|-----------------------|--------------------------------|--|
| <b>For General Purpose</b> | GRM <small>page p17</small>          |                     |         |           |                       |                      |                            |             |                       |                                |  |
|                            | GA2                                  |                     |         |           |                       |                      |                            |             |                       |                                |  |
|                            | GA3                                  |                     |         |           |                       |                      |                            |             |                       |                                |  |
|                            | GJM <small>p87</small>               |                     |         |           |                       |                      |                            |             |                       |                                |  |
|                            | GJ4                                  |                     |         |           |                       |                      |                            |             |                       |                                |  |
|                            | GJ8                                  |                     |         |           |                       |                      |                            |             |                       |                                |  |
|                            | GMA <small>p109</small>              |                     |         |           |                       |                      |                            |             |                       |                                |  |
|                            | GMD <small>p111</small>              |                     |         |           |                       |                      |                            |             |                       |                                |  |
|                            | GQM <small>p114</small>              |                     |         |           |                       |                      |                            |             |                       |                                |  |
|                            | GRJ <small>p123</small>              |                     |         |           |                       |                      |                            |             |                       |                                |  |
|                            | GR3 <small>p125</small>              |                     |         |           |                       |                      |                            |             |                       |                                |  |
|                            | GR4                                  |                     |         |           |                       |                      |                            |             |                       |                                |  |
|                            | GR7                                  |                     |         |           |                       |                      |                            |             |                       |                                |  |
|                            | KRM <small>p127</small>              |                     |         |           |                       |                      |                            |             |                       |                                |  |
|                            | KR3 <small>p130</small>              |                     |         |           |                       |                      |                            |             |                       |                                |  |
|                            | LLA <small>p133</small>              |                     |         |           |                       |                      |                            |             |                       |                                |  |
|                            | LLL <small>p135</small>              |                     |         |           |                       |                      |                            |             |                       |                                |  |
|                            | LLM <small>p137</small>              |                     |         |           |                       |                      |                            |             |                       |                                |  |
|                            | LLR <small>p139</small>              |                     |         |           |                       |                      |                            |             |                       |                                |  |
|                            | ZRA                                  |                     |         |           |                       |                      |                            |             |                       |                                |  |
|                            | ZRB                                  |                     |         |           |                       |                      |                            |             |                       |                                |  |
|                            | <b>For Automotive (Cat. No. C03)</b> | GCM                 |         |           |                       |                      |                            |             |                       |                                |  |
|                            |                                      | GCD                 |         |           |                       |                      |                            |             |                       |                                |  |
| GCE                        |                                      |                     |         |           |                       |                      |                            |             |                       |                                |  |
| GCG                        |                                      |                     |         |           |                       |                      |                            |             |                       |                                |  |
| GCJ                        |                                      |                     |         |           |                       |                      |                            |             |                       |                                |  |
| GC3                        |                                      |                     |         |           |                       |                      |                            |             |                       |                                |  |
| KCM                        |                                      |                     |         |           |                       |                      |                            |             |                       |                                |  |
| KC3                        |                                      |                     |         |           |                       |                      |                            |             |                       |                                |  |

## Capacitance Table

### How to read the Capacitance Table

| LxW (mm)            | 0.4x0.2 |     | 0.6x0.3 |     | 1.0  |
|---------------------|---------|-----|---------|-----|------|
| T max. (mm)         | 0.22    |     | 0.33    |     | 0.5  |
| Rated Voltage (Vdc) | 25      |     | 25      |     | 50   |
| Cap. / TC Code      | C0G     | CΔ  | C0G     | CΔ  | C0G  |
| 0.10pF              |         |     |         |     | p101 |
| 0.20pF              | p88     | p91 | p94     | p97 | p101 |
| 1.0pF               | p88     | p91 | p94     | p98 | p101 |
| 2.0pF               | p88     | p91 | p95     | p98 | p101 |
| 3.0pF               | p88     | p91 | p95     | p98 | p102 |

→ The values can be narrowed down in the order of size, rated voltage, and temperature characteristics.

→ Refers to the page of the part number list.  
Check the part number list for the applicable product number.

### Temperature Characteristics Table

The Table is colored by temperature characteristic codes.  
Refer to the following Table for the meaning of each code.

|      |     |     |     |     |     |     |     |     |     |
|------|-----|-----|-----|-----|-----|-----|-----|-----|-----|
| EIA: | C0G | U2J | X7R | X7S | X7T | X7U | X6S | X6T | X5R |
| JIS: | CK  | CJ  | CH  | SL  | UJ  | R   | B   |     |     |

| Temperature Characteristic Codes |     | Temperature Characteristics |                   |   | Operating Temperature Range | Capacitance Change Each Temperature (%) |       |      |       |       |       |
|----------------------------------|-----|-----------------------------|-------------------|---|-----------------------------|---|-------|------|-------|-------|-------|
|                                  |     | Reference Temperature       | Temperature Range | Capacitance Change or Temperature Coefficient |                             | -55°C                                   |       | *2   |       | -10°C |       |
|                                  |     |                             |                   |   |                             | Max.                                    | Min.  | Max. | Min.  | Max.  | Min.  |
| C0G                              | EIA | 25°C                        | 25 to 125°C       | 0±30ppm/°C                                    | -55 to 125°C                | 0.58                                    | -0.24 | 0.4  | -0.17 | 0.25  | -0.11 |
| CK                               | JIS | 20°C                        | 20 to 125°C       | 0±250ppm/°C                                   | -55 to 125°C                | 2.56                                    | -1.88 | 1.54 | -1.13 | 1.02  | -0.75 |
| CJ                               | JIS | 20°C                        | 20 to 125°C       | 0±120ppm/°C                                   | -55 to 125°C                | 1.37                                    | -0.9  | 0.82 | -0.54 | 0.55  | -0.36 |
| CH                               | JIS | 20°C                        | 20 to 125°C       | 0±60ppm/°C                                    | -55 to 125°C                | 0.82                                    | -0.45 | 0.49 | -0.27 | 0.33  | -0.18 |
| SL                               | JIS | 20°C                        | 20 to 85°C        | +350 to -1000ppm/°C                           | -55 to 125°C                | -                                       | -     | -    | -     | -     | -     |
| U2J                              | EIA | 25°C                        | 25 to 125°C *1    | -750±120ppm/°C                                | -55 to 125°C                | 8.78                                    | 5.04  | 6.04 | 3.47  | 3.84  | 2.21  |
| UJ                               | JIS | 20°C                        | 20 to 85°C        | -750±120ppm/°C                                | -25 to 85°C                 | -                                       | -     | 4.94 | 2.84  | 3.29  | 1.89  |
| X7R                              | EIA | 25°C                        | -55 to 125°C      | ±15%  | -55 to 125°C                | -                                       | -     | -    | -     | -     | -     |
| X7S                              | EIA | 25°C                        | -55 to 125°C      | ±22%  | -55 to 125°C                | -                                       | -     | -    | -     | -     | -     |
| X7T                              | EIA | 25°C                        | -55 to 125°C      | +22%, -33%                                    | -55 to 125°C                | -                                       | -     | -    | -     | -     | -     |
| X7U                              | EIA | 25°C                        | -55 to 125°C      | +22%, -56%                                    | -55 to 125°C                | -                                       | -     | -    | -     | -     | -     |
| R                                | JIS | 20°C                        | -55 to 125°C      | ±15%  | -55 to 125°C                | -                                       | -     | -    | -     | -     | -     |
| X6S                              | EIA | 25°C                        | -55 to 105°C      | ±22%  | -55 to 105°C                | -                                       | -     | -    | -     | -     | -     |
| X6T                              | EIA | 25°C                        | -55 to 105°C      | +22%, -33%                                    | -55 to 105°C                | -                                       | -     | -    | -     | -     | -     |
| X5R                              | EIA | 25°C                        | -55 to 85°C       | ±15%  | -55 to 85°C                 | -                                       | -     | -    | -     | -     | -     |
| B                                | JIS | 20°C                        | -25 to 85°C       | ±10%  | -25 to 85°C                 | -                                       | -     | -    | -     | -     | -     |

\*1 Rated Voltage 100Vdc max: 25 to 85°C

\*2 -25°C (Reference Temperature 20°C) / -30°C (Reference Temperature 25°C)



# Capacitance Table

p00

Each number in the Part Number List refers to the page number printed at the bottom of the page.

## GRM Series Temperature Compensating Type

Part Number List ← JIS: **CK** **CJ** **CH** **SL** **UJ** EIA: **COG** **U2J**

| LxW (mm)            | 0.4x0.2 |     |     |     | 0.6x0.3 |     |     |     |     |     | 1.0x0.5 |     |    | 1.6x0.8 |     |     |     |     |     |     |    |     |     |     |     |     |
|---------------------|---------|-----|-----|-----|---------|-----|-----|-----|-----|-----|---------|-----|----|---------|-----|-----|-----|-----|-----|-----|----|-----|-----|-----|-----|-----|
|                     | 0.22    |     |     |     | 0.33    |     |     |     |     |     | 0.55    |     |    | 0.5     |     |     |     |     |     |     |    |     |     |     |     |     |
| T max. (mm)         | 10      |     |     |     | 50      |     |     |     |     |     | 100     |     |    | 100     |     |     |     |     |     |     |    |     |     |     |     |     |
| Rated Voltage (Vdc) | 16      |     |     |     | 100     |     |     |     |     |     | 50      |     |    | 50      |     |     |     |     |     |     |    |     |     |     |     |     |
| Cap. / TC Code      | COG     | CA  | COG | CH  | COG     | CA  | COG | CA  | COG | CA  | COG     | CA  | SL | U2J     | UJ  | SL  | U2J | UJ  | SL  | U2J | UJ | COG | CA  | COG | CA  | SL  |
| 0.10pF              |         |     |     |     | p26     | p29 | p32 | p36 | p39 | p43 | p46     | p49 |    |         |     |     |     |     |     |     |    |     |     |     |     |     |
| 0.20pF              | p18     | p21 | p22 |     | p26     | p29 | p32 | p36 | p39 | p43 | p46     | p49 |    |         |     |     |     |     |     |     |    |     |     |     |     |     |
| 0.50pF              | p18     | p21 | p22 |     | p26     | p29 | p32 | p36 | p39 | p43 | p46     | p50 |    |         |     |     |     |     |     |     |    |     | p54 | p57 | p60 | p64 |
| 1.0pF               | p18     | p21 | p22 |     | p26     | p29 | p32 | p36 | p39 | p43 | p46     | p50 |    |         |     |     |     |     |     |     |    |     | p54 | p57 | p60 | p64 |
| 2.0pF               | p18     | p22 | p23 |     | p26     | p30 | p33 | p36 | p40 | p43 | p46     | p50 |    |         |     |     |     |     |     |     |    |     | p54 | p57 | p61 | p64 |
| 3.0pF               | p18     | p22 | p23 |     | p27     | p30 | p33 | p36 | p40 | p43 | p47     | p50 |    |         |     |     |     |     |     |     |    |     | p54 | p58 | p61 | p64 |
| 4.0pF               | p19     | p23 |     |     | p27     | p30 | p33 | p37 | p40 | p44 | p47     | p50 |    |         |     |     |     |     |     |     |    |     | p54 | p58 | p61 | p64 |
| 5.0pF               | p19     | p23 |     |     | p27     | p30 | p34 | p37 | p40 | p44 | p47     | p51 |    |         |     |     |     |     |     |     |    |     | p55 | p58 | p61 | p65 |
| 6.0pF               | p19     | p24 |     |     | p28     | p31 | p34 | p37 | p41 | p44 | p48     | p51 |    |         |     |     |     |     |     |     |    |     | p55 | p58 | p62 | p65 |
| 7.0pF               | p20     | p24 |     |     | p28     | p31 | p34 | p38 | p41 | p45 | p48     | p51 |    |         |     |     |     |     |     |     |    |     | p56 | p59 | p62 | p65 |
| 8.0pF               | p20     | p24 |     |     | p28     | p32 | p35 | p38 | p42 | p45 | p48     | p52 |    |         |     |     |     |     |     |     |    |     | p56 | p59 | p62 | p66 |
| 9.0pF               | p20     | p25 |     |     | p29     | p32 | p35 | p38 | p42 | p45 | p49     | p52 |    |         |     |     |     |     |     |     |    |     | p56 | p60 | p63 | p66 |
| 10pF                | p21     | p25 |     |     | p29     | p32 | p35 | p39 | p42 | p46 | p49     | p53 |    |         |     |     |     |     |     |     |    |     | p57 | p60 | p63 | p67 |
| 10.5pF              |         | p25 |     |     |         |     |     |     |     |     |         |     |    |         |     |     |     |     |     |     |    |     |     |     |     |     |
| 11pF                | p21     | p25 |     |     |         |     |     |     |     |     |         |     |    |         |     |     |     |     |     |     |    |     |     |     |     |     |
| 12pF                | p21     | p25 |     |     | p29     | p32 | p35 | p39 | p42 | p46 | p49     | p53 |    |         |     |     |     |     |     |     |    |     | p57 | p60 | p63 | p67 |
| 12.5pF              |         | p25 |     |     |         |     |     |     |     |     |         |     |    |         |     |     |     |     |     |     |    |     |     |     |     |     |
| 13pF                | p21     | p25 |     |     |         |     |     |     |     |     |         |     |    |         |     |     |     |     |     |     |    |     |     |     |     |     |
| 14pF                | p21     | p25 |     |     |         |     |     |     |     |     |         |     |    |         |     |     |     |     |     |     |    |     |     |     |     |     |
| 15pF                | p21     | p25 |     |     | p29     | p32 | p35 | p39 | p42 | p46 | p49     | p53 |    |         |     |     |     |     |     |     |    |     | p57 | p60 | p63 | p67 |
| 16pF                | p21     | p25 |     |     |         |     |     |     |     |     |         |     |    |         |     |     |     |     |     |     |    |     |     |     |     |     |
| 17pF                | p21     | p25 |     |     |         |     |     |     |     |     |         |     |    |         |     |     |     |     |     |     |    |     |     |     |     |     |
| 18pF                | p21     | p25 |     |     |         |     |     |     |     |     |         |     |    |         |     |     |     |     |     |     |    |     |     |     |     |     |
| 19pF                |         | p25 |     |     |         |     |     |     |     |     |         |     |    |         |     |     |     |     |     |     |    |     |     |     |     |     |
| 20pF                | p21     | p25 |     |     |         |     |     |     |     |     |         |     |    |         |     |     |     |     |     |     |    |     |     |     |     |     |
| 21pF                |         | p25 |     |     |         |     |     |     |     |     |         |     |    |         |     |     |     |     |     |     |    |     |     |     |     |     |
| 22pF                | p21     | p25 |     |     |         |     |     |     |     |     |         |     |    |         |     |     |     |     |     |     |    |     |     |     |     |     |
| 24pF                | p21     | p25 |     |     |         |     |     |     |     |     |         |     |    |         |     |     |     |     |     |     |    |     |     |     |     |     |
| 27pF                | p21     | p25 |     |     |         |     |     |     |     |     |         |     |    |         |     |     |     |     |     |     |    |     |     |     |     |     |
| 30pF                | p21     | p26 |     |     |         |     |     |     |     |     |         |     |    |         |     |     |     |     |     |     |    |     |     |     |     |     |
| 33pF                | p21     | p26 |     |     |         |     |     |     |     |     |         |     |    |         |     |     |     |     |     |     |    |     |     |     |     |     |
| 36pF                | p21     | p26 |     |     |         |     |     |     |     |     |         |     |    |         |     |     |     |     |     |     |    |     |     |     |     |     |
| 39pF                | p21     | p26 |     |     |         |     |     |     |     |     |         |     |    |         |     |     |     |     |     |     |    |     |     |     |     |     |
| 43pF                | p21     | p26 |     |     |         |     |     |     |     |     |         |     |    |         |     |     |     |     |     |     |    |     |     |     |     |     |
| 47pF                | p21     | p26 |     |     |         |     |     |     |     |     |         |     |    |         |     |     |     |     |     |     |    |     |     |     |     |     |
| 51pF                | p21     | p26 |     |     |         |     |     |     |     |     |         |     |    |         |     |     |     |     |     |     |    |     |     |     |     |     |
| 56pF                | p21     | p26 | p26 | p26 |         |     |     |     |     |     |         |     |    |         |     |     |     |     |     |     |    |     |     |     |     |     |
| 62pF                | p21     | p26 |     |     |         |     |     |     |     |     |         |     |    |         |     |     |     |     |     |     |    |     |     |     |     |     |
| 68pF                | p21     | p26 | p26 | p26 |         |     |     |     |     |     |         |     |    |         |     |     |     |     |     |     |    |     |     |     |     |     |
| 75pF                | p21     | p26 |     |     |         |     |     |     |     |     |         |     |    |         |     |     |     |     |     |     |    |     |     |     |     |     |
| 82pF                | p21     | p26 | p26 | p26 |         |     |     |     |     |     |         |     |    |         |     |     |     |     |     |     |    |     |     |     |     |     |
| 91pF                | p21     | p26 |     |     |         |     |     |     |     |     |         |     |    |         |     |     |     |     |     |     |    |     |     |     |     |     |
| 94pF                | p21     |     |     |     |         |     |     |     |     |     |         |     |    |         |     |     |     |     |     |     |    |     |     |     |     |     |
| 96pF                | p21     |     |     |     |         |     |     |     |     |     |         |     |    |         |     |     |     |     |     |     |    |     |     |     |     |     |
| 100pF               | p21     | p26 | p26 | p26 |         |     |     |     |     |     |         |     |    |         |     |     |     |     |     |     |    |     |     |     |     |     |
| 120pF               |         |     |     |     |         |     |     |     |     |     |         |     |    |         |     |     |     |     |     |     |    |     |     |     |     |     |
| 150pF               |         |     |     |     |         |     |     |     |     |     |         |     |    |         |     |     |     |     |     |     |    |     |     |     |     |     |
| 180pF               |         |     |     |     |         |     |     |     |     |     |         |     |    |         |     |     |     |     |     |     |    |     |     |     |     |     |
| 220pF               |         |     |     |     |         |     |     |     |     |     |         |     |    |         |     |     |     |     |     |     |    |     |     |     |     |     |
| 270pF               |         |     |     |     |         |     |     |     |     |     |         |     |    |         |     |     |     |     |     |     |    |     |     |     |     |     |
| 330pF               |         |     |     |     |         |     |     |     |     |     |         |     |    |         |     |     |     |     |     |     |    |     |     |     |     |     |
| 390pF               |         |     |     |     |         |     |     |     |     |     |         |     |    |         |     |     |     |     |     |     |    |     |     |     |     |     |
| 470pF               |         |     |     |     |         |     |     |     |     |     |         |     |    |         |     |     |     |     |     |     |    |     |     |     |     |     |
| 560pF               |         |     |     |     |         |     |     |     |     |     |         |     |    |         |     |     |     |     |     |     |    |     |     |     |     |     |
| 680pF               |         |     |     |     |         |     |     |     |     |     |         |     |    |         |     |     |     |     |     |     |    |     |     |     |     |     |
| 820pF               |         |     |     |     |         |     |     |     |     |     |         |     |    |         |     |     |     |     |     |     |    |     |     |     |     |     |
| 1000pF              |         |     |     |     |         |     |     |     |     |     |         |     |    |         |     |     |     |     |     |     |    |     |     |     |     |     |
| 1200pF              |         |     |     |     |         |     |     |     |     |     |         |     |    | p53     | p53 | p53 |     |     |     |     |    |     |     |     |     |     |
| 1500pF              |         |     |     |     |         |     |     |     |     |     |         |     |    | p53     | p53 | p53 |     |     |     |     |    |     |     |     |     |     |
| 1800pF              |         |     |     |     |         |     |     |     |     |     |         |     |    | p53     | p53 | p53 |     |     |     |     |    |     |     |     |     |     |
| 2200pF              |         |     |     |     |         |     |     |     |     |     |         |     |    | p53     | p53 | p53 | p53 | p53 | p53 |     |    |     |     |     |     |     |
| 2700pF              |         |     |     |     |         |     |     |     |     |     |         |     |    | p53     | p53 | p53 | p53 | p53 | p53 |     |    |     |     |     |     |     |
| 3300pF              |         |     |     |     |         |     |     |     |     |     |         |     |    | p53     | p53 | p53 | p53 | p53 | p53 |     |    |     |     |     |     |     |
| 3900pF              |         |     |     |     |         |     |     |     |     |     |         |     |    | p53     | p53 | p53 | p53 | p53 | p53 |     |    |     |     |     |     |     |
| 4700pF              |         |     |     |     |         |     |     |     |     |     |         |     |    | p53     | p53 | p53 | p53 | p53 | p53 |     |    |     |     |     |     |     |
| 5600pF              |         |     |     |     |         |     |     |     |     |     |         |     |    |         |     |     |     |     |     |     |    |     |     |     |     |     |
| 6800pF              |         |     |     |     |         |     |     |     |     |     |         |     |    |         |     |     |     |     |     |     |    |     |     |     |     |     |
| 8200pF              |         |     |     |     |         |     |     |     |     |     |         |     |    |         |     |     |     |     |     |     |    |     |     |     |     |     |
| 10000pF             |         |     |     |     |         |     |     |     |     |     |         |     |    |         |     |     |     |     |     |     |    |     |     |     |     |     |
| 12000pF             |         |     |     |     |         |     |     |     |     |     |         |     |    |         |     |     |     |     |     |     |    |     |     |     |     |     |
| 15000pF             |         |     |     |     |         |     |     |     |     |     |         |     |    |         |     |     |     |     |     |     |    |     |     |     |     |     |
| 18000pF             |         |     |     |     |         |     |     |     |     |     |         |     |    |         |     |     |     |     |     |     |    |     |     |     |     |     |
| 22000pF             |         |     |     |     |         |     |     |     |     |     |         |     |    |         |     |     |     |     |     |     |    |     |     |     |     |     |
| 27000pF             |         |     |     |     |         |     |     |     |     |     |         |     |    |         |     |     |     |     |     |     |    |     |     |     |     |     |
| 33000pF             |         |     |     |     |         |     |     |     |     |     |         |     |    |         |     |     |     |     |     |     |    |     |     |     |     |     |
| 39000pF             |         |     |     |     |         |     |     |     |     |     |         |     |    |         |     |     |     |     |     |     |    |     |     |     |     |     |
| 47000pF             |         |     |     |     |         |     |     |     |     |     |         |     |    |         |     |     |     |     |     |     |    |     |     |     |     |     |
| 56000pF             |         |     |     |     |         |     |     |     |     |     |         |     |    |         |     |     |     |     |     |     |    |     |     |     |     |     |
| 68000pF             |         |     |     |     |         |     |     |     |     |     |         |     |    |         |     |     |     |     |     |     |    |     |     |     |     |     |
| 82000pF             |         |     |     |     |         |     |     |     |     |     |         |     |    |         |     |     |     |     |     |     |    |     |     |     |     |     |
| 0.10μF              |         |     |     |     |         |     |     |     |     |     |         |     |    |         |     |     |     |     |     |     |    |     |     |     |     |     |
| 0.12μF              |         |     |     |     |         |     |     |     |     |     |         |     |    |         |     |     |     |     |     |     |    |     |     |     |     |     |

The indication for every 0.1 pF has been omitted for less than 10 pF. Refer to the Part Number List for details.





# Capacitance Table

p00 Each number in the Part Number List refers to the page number printed at the bottom of the page.

(→ ■ GRM Series Temperature Compensating Type)

| LxW (mm)            | 2.0x1.25 |     |    |    |      |    |    |     |      |     |     |     | 3.2x1.6 |     |    |    |     |    |     |     |      |    |     |     |      |    |     |     |     |    |     |     |     |    |     |  |     |  |  |  |
|---------------------|----------|-----|----|----|------|----|----|-----|------|-----|-----|-----|---------|-----|----|----|-----|----|-----|-----|------|----|-----|-----|------|----|-----|-----|-----|----|-----|-----|-----|----|-----|--|-----|--|--|--|
|                     | 1.0      |     |    |    |      |    |    |     |      |     |     |     | 1.0     |     |    |    |     |    |     |     |      |    |     |     |      |    |     |     |     |    |     |     |     |    |     |  |     |  |  |  |
|                     | 1.35     |     |    |    | 1.45 |    |    |     | 0.95 |     |     |     | 1.0     |     |    |    | 1.0 |    |     |     |      |    |     |     |      |    |     |     |     |    |     |     |     |    |     |  |     |  |  |  |
| Rated Voltage (Vdc) | 50       |     |    |    | 10   |    |    |     | 250  |     |     |     | 100     |     |    |    | 50  |    |     |     | 2000 |    |     |     | 1000 |    |     |     | 630 |    |     |     | 500 |    |     |  | 250 |  |  |  |
| Cap. / TC Code      | UJ       | CoG | CH | SL | U2J  | UJ | SL | U2J | UJ   | U2J | U2J | CoG | CH      | CoG | CH | SL | U2J | UJ | U2J | CoG | U2J  | UJ | U2J | CoG | U2J  | UJ | U2J | CoG | U2J | UJ | U2J | CoG | U2J | UJ | U2J |  |     |  |  |  |
| 0.10pF              |          |     |    |    |      |    |    |     |      |     |     |     |         |     |    |    |     |    |     |     |      |    |     |     |      |    |     |     |     |    |     |     |     |    |     |  |     |  |  |  |
| 0.20pF              |          |     |    |    |      |    |    |     |      |     |     |     |         |     |    |    |     |    |     |     |      |    |     |     |      |    |     |     |     |    |     |     |     |    |     |  |     |  |  |  |
| 0.50pF              |          |     |    |    |      |    |    |     |      |     |     |     |         |     |    |    |     |    |     |     |      |    |     |     |      |    |     |     |     |    |     |     |     |    |     |  |     |  |  |  |
| 1.0pF               |          |     |    |    |      |    |    |     |      |     |     |     |         |     |    |    |     |    |     |     |      |    |     |     |      |    |     |     |     |    |     |     |     |    |     |  |     |  |  |  |
| 2.0pF               |          |     |    |    |      |    |    |     |      |     |     |     |         |     |    |    |     |    |     |     |      |    |     |     |      |    |     |     |     |    |     |     |     |    |     |  |     |  |  |  |
| 3.0pF               |          |     |    |    |      |    |    |     |      |     |     |     |         |     |    |    |     |    |     |     |      |    |     |     |      |    |     |     |     |    |     |     |     |    |     |  |     |  |  |  |
| 4.0pF               |          |     |    |    |      |    |    |     |      |     |     |     |         |     |    |    |     |    |     |     |      |    |     |     |      |    |     |     |     |    |     |     |     |    |     |  |     |  |  |  |
| 5.0pF               |          |     |    |    |      |    |    |     |      |     |     |     |         |     |    |    |     |    |     |     |      |    |     |     |      |    |     |     |     |    |     |     |     |    |     |  |     |  |  |  |
| 6.0pF               |          |     |    |    |      |    |    |     |      |     |     |     |         |     |    |    |     |    |     |     |      |    |     |     |      |    |     |     |     |    |     |     |     |    |     |  |     |  |  |  |
| 7.0pF               |          |     |    |    |      |    |    |     |      |     |     |     |         |     |    |    |     |    |     |     |      |    |     |     |      |    |     |     |     |    |     |     |     |    |     |  |     |  |  |  |
| 8.0pF               |          |     |    |    |      |    |    |     |      |     |     |     |         |     |    |    |     |    |     |     |      |    |     |     |      |    |     |     |     |    |     |     |     |    |     |  |     |  |  |  |
| 9.0pF               |          |     |    |    |      |    |    |     |      |     |     |     |         |     |    |    |     |    |     |     |      |    |     |     |      |    |     |     |     |    |     |     |     |    |     |  |     |  |  |  |
| 10pF                |          |     |    |    |      |    |    |     |      |     |     |     |         |     |    |    |     |    |     |     |      |    |     |     |      |    |     |     |     |    |     |     |     |    |     |  |     |  |  |  |
| 10.5pF              |          |     |    |    |      |    |    |     |      |     |     |     |         |     |    |    |     |    |     |     |      |    |     |     |      |    |     |     |     |    |     |     |     |    |     |  |     |  |  |  |
| 11pF                |          |     |    |    |      |    |    |     |      |     |     |     |         |     |    |    |     |    |     |     |      |    |     |     |      |    |     |     |     |    |     |     |     |    |     |  |     |  |  |  |
| 12pF                |          |     |    |    |      |    |    |     |      |     |     |     |         |     |    |    |     |    |     |     |      |    |     |     |      |    |     |     |     |    |     |     |     |    |     |  |     |  |  |  |
| 12.5pF              |          |     |    |    |      |    |    |     |      |     |     |     |         |     |    |    |     |    |     |     |      |    |     |     |      |    |     |     |     |    |     |     |     |    |     |  |     |  |  |  |
| 13pF                |          |     |    |    |      |    |    |     |      |     |     |     |         |     |    |    |     |    |     |     |      |    |     |     |      |    |     |     |     |    |     |     |     |    |     |  |     |  |  |  |
| 14pF                |          |     |    |    |      |    |    |     |      |     |     |     |         |     |    |    |     |    |     |     |      |    |     |     |      |    |     |     |     |    |     |     |     |    |     |  |     |  |  |  |
| 15pF                |          |     |    |    |      |    |    |     |      |     |     |     |         |     |    |    |     |    |     |     |      |    |     |     |      |    |     |     |     |    |     |     |     |    |     |  |     |  |  |  |
| 16pF                |          |     |    |    |      |    |    |     |      |     |     |     |         |     |    |    |     |    |     |     |      |    |     |     |      |    |     |     |     |    |     |     |     |    |     |  |     |  |  |  |
| 17pF                |          |     |    |    |      |    |    |     |      |     |     |     |         |     |    |    |     |    |     |     |      |    |     |     |      |    |     |     |     |    |     |     |     |    |     |  |     |  |  |  |
| 18pF                |          |     |    |    |      |    |    |     |      |     |     |     |         |     |    |    |     |    |     |     |      |    |     |     |      |    |     |     |     |    |     |     |     |    |     |  |     |  |  |  |
| 19pF                |          |     |    |    |      |    |    |     |      |     |     |     |         |     |    |    |     |    |     |     |      |    |     |     |      |    |     |     |     |    |     |     |     |    |     |  |     |  |  |  |
| 20pF                |          |     |    |    |      |    |    |     |      |     |     |     |         |     |    |    |     |    |     |     |      |    |     |     |      |    |     |     |     |    |     |     |     |    |     |  |     |  |  |  |
| 21pF                |          |     |    |    |      |    |    |     |      |     |     |     |         |     |    |    |     |    |     |     |      |    |     |     |      |    |     |     |     |    |     |     |     |    |     |  |     |  |  |  |
| 22pF                |          |     |    |    |      |    |    |     |      |     |     |     |         |     |    |    |     |    |     |     |      |    |     |     |      |    |     |     |     |    |     |     |     |    |     |  |     |  |  |  |
| 24pF                |          |     |    |    |      |    |    |     |      |     |     |     |         |     |    |    |     |    |     |     |      |    |     |     |      |    |     |     |     |    |     |     |     |    |     |  |     |  |  |  |
| 27pF                |          |     |    |    |      |    |    |     |      |     |     |     |         |     |    |    |     |    |     |     |      |    |     |     |      |    |     |     |     |    |     |     |     |    |     |  |     |  |  |  |
| 30pF                |          |     |    |    |      |    |    |     |      |     |     |     |         |     |    |    |     |    |     |     |      |    |     |     |      |    |     |     |     |    |     |     |     |    |     |  |     |  |  |  |
| 33pF                |          |     |    |    |      |    |    |     |      |     |     |     |         |     |    |    |     |    |     |     |      |    |     |     |      |    |     |     |     |    |     |     |     |    |     |  |     |  |  |  |
| 36pF                |          |     |    |    |      |    |    |     |      |     |     |     |         |     |    |    |     |    |     |     |      |    |     |     |      |    |     |     |     |    |     |     |     |    |     |  |     |  |  |  |
| 39pF                |          |     |    |    |      |    |    |     |      |     |     |     |         |     |    |    |     |    |     |     |      |    |     |     |      |    |     |     |     |    |     |     |     |    |     |  |     |  |  |  |
| 43pF                |          |     |    |    |      |    |    |     |      |     |     |     |         |     |    |    |     |    |     |     |      |    |     |     |      |    |     |     |     |    |     |     |     |    |     |  |     |  |  |  |
| 47pF                |          |     |    |    |      |    |    |     |      |     |     |     |         |     |    |    |     |    |     |     |      |    |     |     |      |    |     |     |     |    |     |     |     |    |     |  |     |  |  |  |
| 51pF                |          |     |    |    |      |    |    |     |      |     |     |     |         |     |    |    |     |    |     |     |      |    |     |     |      |    |     |     |     |    |     |     |     |    |     |  |     |  |  |  |
| 56pF                |          |     |    |    |      |    |    |     |      |     |     |     |         |     |    |    |     |    |     |     |      |    |     |     |      |    |     |     |     |    |     |     |     |    |     |  |     |  |  |  |
| 62pF                |          |     |    |    |      |    |    |     |      |     |     |     |         |     |    |    |     |    |     |     |      |    |     |     |      |    |     |     |     |    |     |     |     |    |     |  |     |  |  |  |
| 68pF                |          |     |    |    |      |    |    |     |      |     |     |     |         |     |    |    |     |    |     |     |      |    |     |     |      |    |     |     |     |    |     |     |     |    |     |  |     |  |  |  |
| 75pF                |          |     |    |    |      |    |    |     |      |     |     |     |         |     |    |    |     |    |     |     |      |    |     |     |      |    |     |     |     |    |     |     |     |    |     |  |     |  |  |  |
| 82pF                |          |     |    |    |      |    |    |     |      |     |     |     |         |     |    |    |     |    |     |     |      |    |     |     |      |    |     |     |     |    |     |     |     |    |     |  |     |  |  |  |
| 91pF                |          |     |    |    |      |    |    |     |      |     |     |     |         |     |    |    |     |    |     |     |      |    |     |     |      |    |     |     |     |    |     |     |     |    |     |  |     |  |  |  |
| 94pF                |          |     |    |    |      |    |    |     |      |     |     |     |         |     |    |    |     |    |     |     |      |    |     |     |      |    |     |     |     |    |     |     |     |    |     |  |     |  |  |  |
| 96pF                |          |     |    |    |      |    |    |     |      |     |     |     |         |     |    |    |     |    |     |     |      |    |     |     |      |    |     |     |     |    |     |     |     |    |     |  |     |  |  |  |
| 100pF               |          |     |    |    |      |    |    |     |      |     |     |     |         |     |    |    |     |    |     |     |      |    |     |     |      |    |     |     |     |    |     |     |     |    |     |  |     |  |  |  |
| 120pF               |          |     |    |    |      |    |    |     |      |     |     |     |         |     |    |    |     |    |     |     |      |    |     |     |      |    |     |     |     |    |     |     |     |    |     |  |     |  |  |  |
| 150pF               |          |     |    |    |      |    |    |     |      |     |     |     |         |     |    |    |     |    |     |     |      |    |     |     |      |    |     |     |     |    |     |     |     |    |     |  |     |  |  |  |
| 180pF               |          |     |    |    |      |    |    |     |      |     |     |     |         |     |    |    |     |    |     |     |      |    |     |     |      |    |     |     |     |    |     |     |     |    |     |  |     |  |  |  |
| 220pF               |          |     |    |    |      |    |    |     |      |     |     |     |         |     |    |    |     |    |     |     |      |    |     |     |      |    |     |     |     |    |     |     |     |    |     |  |     |  |  |  |
| 270pF               |          |     |    |    |      |    |    |     |      |     |     |     |         |     |    |    |     |    |     |     |      |    |     |     |      |    |     |     |     |    |     |     |     |    |     |  |     |  |  |  |
| 330pF               |          |     |    |    |      |    |    |     |      |     |     |     |         |     |    |    |     |    |     |     |      |    |     |     |      |    |     |     |     |    |     |     |     |    |     |  |     |  |  |  |
| 390pF               |          |     |    |    |      |    |    |     |      |     |     |     |         |     |    |    |     |    |     |     |      |    |     |     |      |    |     |     |     |    |     |     |     |    |     |  |     |  |  |  |
| 470pF               |          |     |    |    |      |    |    |     |      |     |     |     |         |     |    |    |     |    |     |     |      |    |     |     |      |    |     |     |     |    |     |     |     |    |     |  |     |  |  |  |
| 560pF               |          |     |    |    |      |    |    |     |      |     |     |     |         |     |    |    |     |    |     |     |      |    |     |     |      |    |     |     |     |    |     |     |     |    |     |  |     |  |  |  |
| 680pF               |          |     |    |    |      |    |    |     |      |     |     |     |         |     |    |    |     |    |     |     |      |    |     |     |      |    |     |     |     |    |     |     |     |    |     |  |     |  |  |  |
| 820pF               |          |     |    |    |      |    |    |     |      |     |     |     |         |     |    |    |     |    |     |     |      |    |     |     |      |    |     |     |     |    |     |     |     |    |     |  |     |  |  |  |
| 1000pF              |          |     |    |    |      |    |    |     |      |     |     |     |         |     |    |    |     |    |     |     |      |    |     |     |      |    |     |     |     |    |     |     |     |    |     |  |     |  |  |  |
| 1200pF              |          |     |    |    |      |    |    |     |      |     |     |     |         |     |    |    |     |    |     |     |      |    |     |     |      |    |     |     |     |    |     |     |     |    |     |  |     |  |  |  |
| 1500pF              |          |     |    |    |      |    |    |     |      |     |     |     |         |     |    |    |     |    |     |     |      |    |     |     |      |    |     |     |     |    |     |     |     |    |     |  |     |  |  |  |
| 1800pF              |          |     |    |    |      |    |    |     |      |     |     |     |         |     |    |    |     |    |     |     |      |    |     |     |      |    |     |     |     |    |     |     |     |    |     |  |     |  |  |  |
| 2200pF              |          |     |    |    |      |    |    |     |      |     |     |     |         |     |    |    |     |    |     |     |      |    |     |     |      |    |     |     |     |    |     |     |     |    |     |  |     |  |  |  |
| 2700pF              |          |     |    |    |      |    |    |     |      |     |     |     |         |     |    |    |     |    |     |     |      |    |     |     |      |    |     |     |     |    |     |     |     |    |     |  |     |  |  |  |
| 3300pF              |          |     |    |    |      |    |    |     |      |     |     |     |         |     |    |    |     |    |     |     |      |    |     |     |      |    |     |     |     |    |     |     |     |    |     |  |     |  |  |  |
| 3900pF              |          |     |    |    |      |    |    |     |      |     |     |     |         |     |    |    |     |    |     |     |      |    |     |     |      |    |     |     |     |    |     |     |     |    |     |  |     |  |  |  |
| 4700pF              |          |     |    |    |      |    |    |     |      |     |     |     |         |     |    |    |     |    |     |     |      |    |     |     |      |    |     |     |     |    |     |     |     |    |     |  |     |  |  |  |
| 5600pF              |          |     |    |    |      |    |    |     |      |     |     |     |         |     |    |    |     |    |     |     |      |    |     |     |      |    |     |     |     |    |     |     |     |    |     |  |     |  |  |  |
| 6800pF              |          |     |    |    |      |    |    |     |      |     |     |     |         |     |    |    |     |    |     |     |      |    |     |     |      |    |     |     |     |    |     |     |     |    |     |  |     |  |  |  |
| 8200pF              |          |     |    |    |      |    |    |     |      |     |     |     |         |     |    |    |     |    |     |     |      |    |     |     |      |    |     |     |     |    |     |     |     |    |     |  |     |  |  |  |
| 0.10μF              |          |     |    |    |      |    |    |     |      |     |     |     |         |     |    |    |     |    |     |     |      |    |     |     |      |    |     |     |     |    |     |     |     |    |     |  |     |  |  |  |
| 0.12μF              |          |     |    |    |      |    |    |     |      |     |     |     |         |     |    |    |     |    |     |     |      |    |     |     |      |    |     |     |     |    |     |     |     |    |     |  |     |  |  |  |



# Capacitance Table p00 Each number in the Part Number List refers to the page number printed at the bottom of the page.

(→ ■ GRM Series Temperature Compensating Type)

| LxW (mm)<br>T max. (mm)<br>Rated Voltage (Vdc)<br>Cap. / TC Code | 3.2x1.6 |      |      |     |     |     |     |      |     |     |     |    |     |     |      |     |     |     |    |     | 3.2x2.5 |     |     |     |     |
|--|---------|------|------|-----|-----|-----|-----|------|-----|-----|-----|----|-----|-----|------|-----|-----|-----|----|-----|---------|-----|-----|-----|-----|
|  | 1.0     |      | 1.25 |     |     |     |     |      |     |     | 1.8 |    |     |     |      |     |     |     |    |     | 1.0     |     |     |     |     |
|  | 200     | 1000 | 630  | 500 | 250 | 200 | 50  | 1000 | 630 | 500 | 250 | 50 | 25  | 16  | 2000 | 630 | 500 |     |    |     |         |     |     |     |     |
|  | U2J     | U2J  | COG  | U2J | COG | U2J | U2J | COG  | CH  | SL  | U2J | UJ | U2J | U2J | U2J  | COG | CH  | COG | CH | COG | CH      | U2J | U2J | U2J |     |
| 0.10pF   |         |      |      |     |     |     |     |      |     |     |     |    |     |     |      |     |     |     |    |     |         |     |     |     |     |
| 0.20pF   |         |      |      |     |     |     |     |      |     |     |     |    |     |     |      |     |     |     |    |     |         |     |     |     |     |
| 0.50pF   |         |      |      |     |     |     |     |      |     |     |     |    |     |     |      |     |     |     |    |     |         |     |     |     |     |
| 1.0pF  |         |      |      |     |     |     |     |      |     |     |     |    |     |     |      |     |     |     |    |     |         |     |     |     |     |
| 2.0pF  |         |      |      |     |     |     |     |      |     |     |     |    |     |     |      |     |     |     |    |     |         |     |     |     |     |
| 3.0pF  |         |      |      |     |     |     |     |      |     |     |     |    |     |     |      |     |     |     |    |     |         |     |     |     |     |
| 4.0pF  |         |      |      |     |     |     |     |      |     |     |     |    |     |     |      |     |     |     |    |     |         |     |     |     |     |
| 5.0pF  |         |      |      |     |     |     |     |      |     |     |     |    |     |     |      |     |     |     |    |     |         |     |     |     |     |
| 6.0pF  |         |      |      |     |     |     |     |      |     |     |     |    |     |     |      |     |     |     |    |     |         |     |     |     |     |
| 7.0pF  |         |      |      |     |     |     |     |      |     |     |     |    |     |     |      |     |     |     |    |     |         |     |     |     |     |
| 8.0pF  |         |      |      |     |     |     |     |      |     |     |     |    |     |     |      |     |     |     |    |     |         |     |     |     |     |
| 9.0pF  |         |      |      |     |     |     |     |      |     |     |     |    |     |     |      |     |     |     |    |     |         |     |     |     |     |
| 10pF   |         |      |      |     |     |     |     |      |     |     |     |    |     |     |      |     |     |     |    |     |         |     |     |     |     |
| 10.5pF   |         |      |      |     |     |     |     |      |     |     |     |    |     |     |      |     |     |     |    |     |         |     |     |     |     |
| 11pF   |         |      |      |     |     |     |     |      |     |     |     |    |     |     |      |     |     |     |    |     |         |     |     |     |     |
| 12pF   |         |      |      |     |     |     |     |      |     |     |     |    |     |     |      |     |     |     |    |     |         |     |     |     |     |
| 12.5pF   |         |      |      |     |     |     |     |      |     |     |     |    |     |     |      |     |     |     |    |     |         |     |     |     |     |
| 13pF   |         |      |      |     |     |     |     |      |     |     |     |    |     |     |      |     |     |     |    |     |         |     |     |     |     |
| 14pF   |         |      |      |     |     |     |     |      |     |     |     |    |     |     |      |     |     |     |    |     |         |     |     |     |     |
| 15pF   |         |      |      |     |     |     |     |      |     |     |     |    |     |     |      |     |     |     |    |     |         |     |     |     |     |
| 16pF   |         |      |      |     |     |     |     |      |     |     |     |    |     |     |      |     |     |     |    |     |         |     |     |     |     |
| 17pF   |         |      |      |     |     |     |     |      |     |     |     |    |     |     |      |     |     |     |    |     |         |     |     |     |     |
| 18pF   |         |      |      |     |     |     |     |      |     |     |     |    |     |     |      |     |     |     |    |     |         |     |     |     |     |
| 19pF   |         |      |      |     |     |     |     |      |     |     |     |    |     |     |      |     |     |     |    |     |         |     |     |     |     |
| 20pF   |         |      |      |     |     |     |     |      |     |     |     |    |     |     |      |     |     |     |    |     |         |     |     |     |     |
| 21pF   |         |      |      |     |     |     |     |      |     |     |     |    |     |     |      |     |     |     |    |     |         |     |     |     |     |
| 22pF   |         |      |      |     |     |     |     |      |     |     |     |    |     |     |      |     |     |     |    |     |         |     |     |     |     |
| 24pF   |         |      |      |     |     |     |     |      |     |     |     |    |     |     |      |     |     |     |    |     |         |     |     |     |     |
| 27pF   |         |      |      |     |     |     |     |      |     |     |     |    |     |     |      |     |     |     |    |     |         |     |     |     |     |
| 30pF   |         |      |      |     |     |     |     |      |     |     |     |    |     |     |      |     |     |     |    |     |         |     |     |     |     |
| 33pF   |         |      |      |     |     |     |     |      |     |     |     |    |     |     |      |     |     |     |    |     |         |     |     |     |     |
| 36pF   |         |      |      |     |     |     |     |      |     |     |     |    |     |     |      |     |     |     |    |     |         |     |     |     |     |
| 39pF   |         |      |      |     |     |     |     |      |     |     |     |    |     |     |      |     |     |     |    |     |         |     |     |     |     |
| 43pF   |         |      |      |     |     |     |     |      |     |     |     |    |     |     |      |     |     |     |    |     |         |     |     |     |     |
| 47pF   |         |      |      |     |     |     |     |      |     |     |     |    |     |     |      |     |     |     |    |     |         |     |     |     |     |
| 51pF   |         |      |      |     |     |     |     |      |     |     |     |    |     |     |      |     |     |     |    |     |         |     |     |     |     |
| 56pF   |         |      |      |     |     |     |     |      |     |     |     |    |     |     |      |     |     |     |    |     |         |     |     |     |     |
| 62pF   |         |      |      |     |     |     |     |      |     |     |     |    |     |     |      |     |     |     |    |     |         |     |     |     |     |
| 68pF   |         |      |      |     |     |     |     |      |     |     |     |    |     |     |      |     |     |     |    |     |         |     |     |     |     |
| 75pF   |         |      |      |     |     |     |     |      |     |     |     |    |     |     |      |     |     |     |    |     |         |     |     |     |     |
| 82pF   |         |      |      |     |     |     |     |      |     |     |     |    |     |     |      |     |     |     |    |     |         |     |     |     | p72 |
| 91pF   |         |      |      |     |     |     |     |      |     |     |     |    |     |     |      |     |     |     |    |     |         |     |     |     |     |
| 94pF   |         |      |      |     |     |     |     |      |     |     |     |    |     |     |      |     |     |     |    |     |         |     |     |     |     |
| 96pF   |         |      |      |     |     |     |     |      |     |     |     |    |     |     |      |     |     |     |    |     |         |     |     |     |     |
| 100pF  |         |      |      |     |     |     |     |      |     |     |     |    |     |     |      |     |     |     |    |     |         |     |     |     | p72 |
| 120pF  |         |      |      |     |     |     |     |      |     |     |     |    |     |     |      |     |     |     |    |     |         |     |     |     | p72 |
| 150pF  |         |      |      |     |     |     |     |      |     |     |     |    |     |     |      |     |     |     |    |     |         |     |     |     | p72 |
| 180pF  |         |      |      |     |     |     |     |      |     |     |     |    |     |     |      |     |     |     |    |     |         |     |     |     | p72 |
| 220pF  |         |      |      |     |     |     |     |      |     |     |     |    |     |     |      |     |     |     |    |     |         |     |     |     |     |
| 270pF  |         |      |      |     |     |     |     |      |     |     |     |    |     |     |      |     |     |     |    |     |         |     |     |     |     |
| 330pF  |         |      |      |     |     |     |     |      |     |     |     |    |     |     |      |     |     |     |    |     |         |     |     |     |     |
| 390pF  |         | p71  |      |     |     |     |     |      |     |     |     |    |     |     |      |     |     |     |    |     |         |     |     |     |     |
| 470pF  |         | p71  |      |     |     |     |     |      |     |     |     |    |     |     |      |     |     |     |    |     |         |     |     |     |     |
| 560pF  |         | p71  |      |     |     |     |     |      |     |     |     |    |     |     |      |     |     |     |    |     |         |     |     |     |     |
| 680pF  |         | p71  | p71  |     |     | p71 |     |      |     |     |     |    |     |     |      |     |     |     |    |     |         |     |     |     |     |
| 820pF  |         |      | p71  |     |     | p71 |     |      |     |     |     |    |     |     | p71  |     |     |     |    |     |         |     |     |     |     |
| 1000pF   |         |      | p71  |     |     | p71 |     |      |     |     |     |    |     |     | p71  |     |     |     |    |     |         |     |     |     |     |
| 1200pF   |         |      |      |     |     |     |     |      |     |     |     |    |     |     |      |     |     |     |    |     |         |     |     |     |     |
| 1500pF   |         |      |      |     |     |     |     |      |     |     |     |    |     |     |      |     |     |     |    |     |         |     |     |     | p72 |
| 1800pF   |         |      |      |     |     |     |     |      |     |     |     |    |     |     |      |     |     |     |    |     |         |     |     |     | p72 |
| 2200pF   |         |      |      |     |     |     |     |      |     |     |     |    |     |     |      |     |     |     |    |     |         |     |     |     | p72 |
| 2700pF   |         | p71  |      |     |     | p71 |     |      |     |     |     |    |     |     |      |     |     |     |    |     |         |     |     |     |     |
| 3300pF   |         | p71  |      |     |     | p71 |     |      |     |     |     |    |     |     |      |     |     |     |    |     |         |     |     |     |     |
| 3900pF   |         | p71  |      |     |     |     |     |      |     |     |     |    |     |     |      |     |     |     |    |     |         |     |     |     |     |
| 4700pF   |         | p71  |      |     |     |     |     |      |     |     |     |    |     |     |      |     |     |     |    |     |         |     |     |     |     |
| 5600pF   |         | p71  |      |     |     |     |     |      |     |     |     |    |     |     |      |     |     |     |    |     |         |     |     |     |     |
| 6800pF   |         |      |      |     |     |     |     |      |     |     |     |    |     |     |      |     |     |     |    |     |         |     |     |     |     |
| 8200pF   |         |      |      |     |     |     |     |      |     |     |     |    |     |     |      |     |     |     |    |     |         |     |     |     |     |
| 10000pF  |         |      |      |     |     |     |     |      |     |     |     |    |     |     |      |     |     |     |    |     |         |     |     |     |     |
| 12000pF  |         |      |      |     |     |     |     |      |     |     |     |    |     |     |      |     |     |     |    |     |         |     |     |     |     |
| 15000pF  |         |      |      |     |     |     |     |      |     |     |     |    |     |     |      |     |     |     |    |     |         |     |     |     |     |
| 18000pF  |         |      |      |     |     |     |     |      |     |     |     |    |     |     |      |     |     |     |    |     |         |     |     |     |     |
| 22000pF  |         |      |      |     |     |     |     |      |     |     |     |    |     |     |      |     |     |     |    |     |         |     |     |     |     |
| 27000pF  |         |      |      |     |     |     |     |      |     |     |     |    |     |     |      |     |     |     |    |     |         |     |     |     |     |
| 33000pF  |         |      |      |     |     |     |     |      |     |     |     |    |     |     |      |     |     |     |    |     |         |     |     |     |     |
| 39000pF  |         |      |      |     |     |     |     |      |     |     |     |    |     |     |      |     |     |     |    |     |         |     |     |     |     |
| 47000pF  |         |      |      |     |     |     |     |      |     |     |     |    |     |     |      |     |     |     |    |     |         |     |     |     |     |
| 56000pF  |         |      |      |     |     |     |     |      |     |     |     |    |     |     |      |     |     |     |    |     |         |     |     |     |     |
| 68000pF  |         |      |      |     |     |     |     |      |     |     |     |    |     |     |      |     |     |     |    |     |         |     |     |     |     |
| 82000pF  |         |      |      |     |     |     |     |      |     |     |     |    |     |     |      |     |     |     |    |     |         |     |     |     |     |
| 0.10μF   |         |      |      |     |     |     |     |      |     |     |     |    |     |     |      |     |     |     |    |     |         |     |     |     |     |
| 0.12μF   |         |      |      |     |     |     |     |      |     |     |     |    |     |     |      |     |     |     |    |     |         |     |     |     |     |



# Capacitance Table p00 Each number in the Part Number List refers to the page number printed at the bottom of the page.

(→ ■ GRM Series Temperature Compensating Type)

| LxW (mm)            | 3.2x2.5        |      |     |     |      |     |     |     |      |     |     |     | 4.5x2.0 |     | 4.5x3.2 |     |     |      |     |     | 5.7x5.0 |     |     |      |     |     |
|---------------------|----------------|------|-----|-----|------|-----|-----|-----|------|-----|-----|-----|---------|-----|---------|-----|-----|------|-----|-----|---------|-----|-----|------|-----|-----|
|                     | 1.25           |      |     |     | 1.5  |     |     |     | 2.0  |     |     |     | 1.0     |     | 1.5     |     | 2.0 |      | 1.5 |     |         | 2.0 |     |      |     |     |
| T max. (mm)         | 2000           | 1000 | 630 | 500 | 1000 | 630 | 500 | 250 | 1000 | 630 | 500 | 250 | COG     | U2J | 1000    | 630 | 500 | 1000 | 630 | 500 | 1000    | 630 | 500 | 1000 | 630 | 500 |
| Rated Voltage (Vdc) | Cap. / TC Code |      |     |     |      |     |     |     |      |     |     |     |         |     |         |     |     |      |     |     |         |     |     |      |     |     |
| 0.10pF              |                |      |     |     |      |     |     |     |      |     |     |     |         |     |         |     |     |      |     |     |         |     |     |      |     |     |
| 0.20pF              |                |      |     |     |      |     |     |     |      |     |     |     |         |     |         |     |     |      |     |     |         |     |     |      |     |     |
| 0.50pF              |                |      |     |     |      |     |     |     |      |     |     |     |         |     |         |     |     |      |     |     |         |     |     |      |     |     |
| 1.0pF               |                |      |     |     |      |     |     |     |      |     |     |     |         |     |         |     |     |      |     |     |         |     |     |      |     |     |
| 2.0pF               |                |      |     |     |      |     |     |     |      |     |     |     |         |     |         |     |     |      |     |     |         |     |     |      |     |     |
| 3.0pF               |                |      |     |     |      |     |     |     |      |     |     |     |         |     |         |     |     |      |     |     |         |     |     |      |     |     |
| 4.0pF               |                |      |     |     |      |     |     |     |      |     |     |     |         |     |         |     |     |      |     |     |         |     |     |      |     |     |
| 5.0pF               |                |      |     |     |      |     |     |     |      |     |     |     | p72     |     |         |     |     |      |     |     |         |     |     |      |     |     |
| 6.0pF               |                |      |     |     |      |     |     |     |      |     |     |     |         |     |         |     |     |      |     |     |         |     |     |      |     |     |
| 7.0pF               |                |      |     |     |      |     |     |     |      |     |     |     |         |     |         |     |     |      |     |     |         |     |     |      |     |     |
| 8.0pF               |                |      |     |     |      |     |     |     |      |     |     |     |         |     |         |     |     |      |     |     |         |     |     |      |     |     |
| 9.0pF               |                |      |     |     |      |     |     |     |      |     |     |     |         |     |         |     |     |      |     |     |         |     |     |      |     |     |
| 10pF                |                |      |     |     |      |     |     |     |      |     |     |     | p72     | p72 |         |     |     |      |     |     |         |     |     |      |     |     |
| 10.5pF              |                |      |     |     |      |     |     |     |      |     |     |     |         |     |         |     |     |      |     |     |         |     |     |      |     |     |
| 11pF                |                |      |     |     |      |     |     |     |      |     |     |     |         |     |         |     |     |      |     |     |         |     |     |      |     |     |
| 12pF                |                |      |     |     |      |     |     |     |      |     |     |     | p72     | p72 |         |     |     |      |     |     |         |     |     |      |     |     |
| 12.5pF              |                |      |     |     |      |     |     |     |      |     |     |     |         |     |         |     |     |      |     |     |         |     |     |      |     |     |
| 13pF                |                |      |     |     |      |     |     |     |      |     |     |     |         |     |         |     |     |      |     |     |         |     |     |      |     |     |
| 14pF                |                |      |     |     |      |     |     |     |      |     |     |     |         |     |         |     |     |      |     |     |         |     |     |      |     |     |
| 15pF                |                |      |     |     |      |     |     |     |      |     |     |     | p72     | p72 |         |     |     |      |     |     |         |     |     |      |     |     |
| 16pF                |                |      |     |     |      |     |     |     |      |     |     |     |         |     |         |     |     |      |     |     |         |     |     |      |     |     |
| 17pF                |                |      |     |     |      |     |     |     |      |     |     |     |         |     |         |     |     |      |     |     |         |     |     |      |     |     |
| 18pF                |                |      |     |     |      |     |     |     |      |     |     |     | p72     | p72 |         |     |     |      |     |     |         |     |     |      |     |     |
| 19pF                |                |      |     |     |      |     |     |     |      |     |     |     |         |     |         |     |     |      |     |     |         |     |     |      |     |     |
| 20pF                |                |      |     |     |      |     |     |     |      |     |     |     |         |     |         |     |     |      |     |     |         |     |     |      |     |     |
| 21pF                |                |      |     |     |      |     |     |     |      |     |     |     |         |     |         |     |     |      |     |     |         |     |     |      |     |     |
| 22pF                |                |      |     |     |      |     |     |     |      |     |     |     | p72     | p72 |         |     |     |      |     |     |         |     |     |      |     |     |
| 24pF                |                |      |     |     |      |     |     |     |      |     |     |     |         |     |         |     |     |      |     |     |         |     |     |      |     |     |
| 27pF                |                |      |     |     |      |     |     |     |      |     |     |     | p72     | p72 |         |     |     |      |     |     |         |     |     |      |     |     |
| 30pF                |                |      |     |     |      |     |     |     |      |     |     |     |         |     |         |     |     |      |     |     |         |     |     |      |     |     |
| 33pF                |                |      |     |     |      |     |     |     |      |     |     |     | p72     | p72 |         |     |     |      |     |     |         |     |     |      |     |     |
| 36pF                |                |      |     |     |      |     |     |     |      |     |     |     |         |     |         |     |     |      |     |     |         |     |     |      |     |     |
| 39pF                |                |      |     |     |      |     |     |     |      |     |     |     | p72     | p72 |         |     |     |      |     |     |         |     |     |      |     |     |
| 43pF                |                |      |     |     |      |     |     |     |      |     |     |     |         |     |         |     |     |      |     |     |         |     |     |      |     |     |
| 47pF                |                |      |     |     |      |     |     |     |      |     |     |     | p72     | p72 |         |     |     |      |     |     |         |     |     |      |     |     |
| 51pF                |                |      |     |     |      |     |     |     |      |     |     |     |         |     |         |     |     |      |     |     |         |     |     |      |     |     |
| 56pF                |                |      |     |     |      |     |     |     |      |     |     |     |         | p72 |         |     |     |      |     |     |         |     |     |      |     |     |
| 62pF                |                |      |     |     |      |     |     |     |      |     |     |     |         |     |         |     |     |      |     |     |         |     |     |      |     |     |
| 68pF                |                |      |     |     |      |     |     |     |      |     |     |     |         |     |         |     |     |      |     |     |         |     |     |      |     |     |
| 75pF                |                |      |     |     |      |     |     |     |      |     |     |     |         |     |         |     |     |      |     |     |         |     |     |      |     |     |
| 82pF                |                |      |     |     |      |     |     |     |      |     |     |     |         |     |         |     |     |      |     |     |         |     |     |      |     |     |
| 91pF                |                |      |     |     |      |     |     |     |      |     |     |     |         |     |         |     |     |      |     |     |         |     |     |      |     |     |
| 94pF                |                |      |     |     |      |     |     |     |      |     |     |     |         |     |         |     |     |      |     |     |         |     |     |      |     |     |
| 96pF                |                |      |     |     |      |     |     |     |      |     |     |     |         |     |         |     |     |      |     |     |         |     |     |      |     |     |
| 100pF               |                |      |     |     |      |     |     |     |      |     |     |     |         | p72 |         |     |     |      |     |     |         |     |     |      |     |     |
| 120pF               |                |      |     |     |      |     |     |     |      |     |     |     |         |     |         |     |     |      |     |     |         |     |     |      |     |     |
| 150pF               |                |      |     |     |      |     |     |     |      |     |     |     |         |     |         |     |     |      |     |     |         |     |     |      |     |     |
| 180pF               | p72            |      |     |     |      |     |     |     |      |     |     |     |         |     |         |     |     |      |     |     |         |     |     |      |     |     |
| 220pF               | p72            |      |     |     |      |     |     |     |      |     |     |     |         |     |         |     |     |      |     |     |         |     |     |      |     |     |
| 270pF               |                |      |     |     |      |     |     |     |      |     |     |     |         |     |         |     |     |      |     |     |         |     |     |      |     |     |
| 330pF               |                |      |     |     |      |     |     |     |      |     |     |     |         |     |         |     |     |      |     |     |         |     |     |      |     |     |
| 390pF               |                |      |     |     |      |     |     |     |      |     |     |     |         |     |         |     |     |      |     |     |         |     |     |      |     |     |
| 470pF               |                |      |     |     |      |     |     |     |      |     |     |     |         |     |         |     |     |      |     |     |         |     |     |      |     |     |
| 560pF               |                |      |     |     |      |     |     |     |      |     |     |     |         |     |         |     |     |      |     |     |         |     |     |      |     |     |
| 680pF               |                |      | p72 | p72 |      |     |     |     |      |     |     |     |         |     |         |     |     |      |     |     |         |     |     |      |     |     |
| 820pF               |                |      |     |     |      |     |     |     |      |     |     |     |         |     |         |     |     |      |     |     |         |     |     |      |     |     |
| 1000pF              |                |      |     |     |      |     |     |     |      |     |     |     |         |     |         |     |     |      |     |     |         |     |     |      |     |     |
| 1200pF              |                |      | p72 |     |      |     |     |     |      |     |     |     |         |     |         |     |     |      |     |     |         |     |     |      |     |     |
| 1500pF              |                |      |     |     | p72  |     |     |     |      |     |     |     |         |     |         |     |     |      |     |     |         |     |     |      |     |     |
| 1800pF              |                |      |     |     |      |     |     |     |      |     |     |     |         |     |         |     |     |      |     |     |         |     |     |      |     |     |
| 2200pF              |                |      |     |     |      |     |     |     |      |     |     |     |         |     |         |     |     |      |     |     |         |     |     |      |     |     |
| 2700pF              |                |      |     |     |      |     |     |     |      |     |     |     |         |     |         |     |     |      |     |     |         |     |     |      |     |     |
| 3300pF              |                |      |     |     |      |     |     |     |      |     |     |     |         |     |         |     |     |      |     |     |         |     |     |      |     |     |
| 3900pF              |                |      |     |     |      |     |     |     |      |     |     |     |         |     |         |     |     |      |     |     |         |     |     |      |     |     |
| 4700pF              |                |      |     |     |      |     |     |     |      |     |     |     |         |     |         |     |     |      |     |     |         |     |     |      |     |     |
| 5600pF              |                |      |     |     |      |     |     |     |      |     |     |     |         |     |         |     |     |      |     |     |         |     |     |      |     |     |
| 6800pF              |                |      |     |     |      |     |     |     |      |     |     |     |         |     |         |     |     |      |     |     |         |     |     |      |     |     |
| 8200pF              |                |      |     |     |      |     |     |     |      |     |     |     |         |     |         |     |     |      |     |     |         |     |     |      |     |     |
| 10000pF             |                |      |     |     |      |     |     |     |      |     |     |     |         |     |         |     |     |      |     |     |         |     |     |      |     |     |
| 12000pF             |                |      |     |     |      |     |     |     |      |     |     |     |         |     |         |     |     |      |     |     |         |     |     |      |     |     |
| 15000pF             |                |      |     |     |      |     |     |     |      |     |     |     |         |     |         |     |     |      |     |     |         |     |     |      |     |     |
| 18000pF             |                |      |     |     |      |     |     |     |      |     |     |     |         |     |         |     |     |      |     |     |         |     |     |      |     |     |
| 22000pF             |                |      |     |     |      |     |     |     |      |     |     |     |         |     |         |     |     |      |     |     |         |     |     |      |     |     |
| 27000pF             |                |      |     |     |      |     |     |     |      |     |     |     |         |     |         |     |     |      |     |     |         |     |     |      |     |     |
| 33000pF             |                |      |     |     |      |     |     |     |      |     |     |     |         |     |         |     |     |      |     |     |         |     |     |      |     |     |
| 39000pF             |                |      |     |     |      |     |     |     |      |     |     |     |         |     |         |     |     |      |     |     |         |     |     |      |     |     |
| 47000pF             |                |      |     |     |      |     |     |     |      |     |     |     |         |     |         |     |     |      |     |     |         |     |     |      |     |     |
| 56000pF             |                |      |     |     |      |     |     |     |      |     |     |     |         |     |         |     |     |      |     |     |         |     |     |      |     |     |
| 68000pF             |                |      |     |     |      |     |     |     |      |     |     |     |         |     |         |     |     |      |     |     |         |     |     |      |     |     |
| 82000pF             |                |      |     |     |      |     |     |     |      |     |     |     |         |     |         |     |     |      |     |     |         |     |     |      |     |     |
| 0.10μF              |                |      |     |     |      |     |     |     |      |     |     |     |         |     |         |     |     |      |     |     |         |     |     |      |     |     |
| 0.12μF              |                |      |     |     |      |     |     |     |      |     |     |     |         |     |         |     |     |      |     |     |         |     |     |      |     |     |

# Capacitance Table

p00

Each number in the Part Number List refers to the page number printed at the bottom of the page.

## GRM Series High Dielectric Constant Type

p00 ← Part Number List    JIS: R B    EIA: X7R X7S X7T X7U X6S X6T X5R

| LxW (mm)            | 0.4x0.2 |     |        |        |     |     | 0.6x0.3 |     |     |     |        |     |        |        |     |        | 1.0x0.5 |        |        |     |        |     |        |     |        |     |        |     |     |     |
|---------------------|---------|-----|--------|--------|-----|-----|---------|-----|-----|-----|--------|-----|--------|--------|-----|--------|---------|--------|--------|-----|--------|-----|--------|-----|--------|-----|--------|-----|-----|-----|
|                     | 0.22    |     |        |        |     |     | 0.33    |     |     |     |        |     |        |        |     |        | 0.22    |        |        |     |        |     |        |     |        |     |        |     |     |     |
| T max. (mm)         | 0.22    |     |        |        |     |     | 0.33    |     |     |     |        |     |        |        |     |        | 0.22    |        |        |     |        |     |        |     |        |     |        |     |     |     |
| Rated Voltage (Vdc) | 16      | 10  | 6.3    | 4      | 2.5 | 50  | 35      | 25  | 16  | 10  | 6.3    | 4   | 10     | 6.3    | 4   |        |         |        |        |     |        |     |        |     |        |     |        |     |     |     |
| Cap. / TC Code      | X7R     | X7R | X5R, B | X5R, B | X6T | X5R | X6T     | X7R | B   | X5R | X7R, R | X6S | X5R, B | X7Δ, R | X6S | X5R, B | X7Δ, R  | X5R, B | X7R, R | X6S | X5R, B | X6S | X5R, B | X6S | X5R, B | X6S | X5R, B | X7T |     |     |
| 100pF               | p74     | p74 | p74    | p74    |     |     |         | p75 | p75 |     | p75    |     |        |        |     |        |         |        |        |     |        |     |        |     |        |     |        |     |     |     |
| 150pF               | p74     | p74 | p74    | p74    |     |     |         | p75 | p75 |     | p75    |     |        |        |     |        |         |        |        |     |        |     |        |     |        |     |        |     |     |     |
| 220pF               | p74     | p74 | p74    | p74    |     |     |         | p75 | p75 |     | p75    |     |        |        |     |        |         |        |        |     |        |     |        |     |        |     |        |     |     |     |
| 330pF               | p74     | p74 | p74    | p74    |     |     |         | p75 | p75 |     | p75    |     |        |        |     |        |         |        |        |     |        |     |        |     |        |     |        |     |     |     |
| 470pF               | p74     | p74 | p74    | p74    |     |     |         | p75 | p75 |     | p75    |     |        |        |     |        |         |        |        |     |        |     |        |     |        |     |        |     |     |     |
| 680pF               |         | p74 | p74    | p74    |     |     |         | p75 | p75 |     | p75    |     |        |        |     |        |         |        |        |     |        |     |        |     |        |     |        |     |     |     |
| 820pF               |         | p74 |        |        |     |     |         |     |     |     |        |     |        |        |     |        |         |        |        |     |        |     |        |     |        |     |        |     |     |     |
| 1000pF              | p74     | p74 | p74    | p74    | p74 |     |         | p75 | p75 |     | p75    | p75 |        | p75    |     |        |         |        |        |     |        |     |        |     |        |     |        |     |     |     |
| 1500pF              |         |     | p74    | p74    | p74 |     |         | p75 | p75 |     | p75    | p75 |        | p75    |     |        |         |        |        |     |        |     |        |     |        |     |        |     |     |     |
| 2200pF              |         |     | p74    | p74    | p74 |     |         |     |     |     | p75    |     |        | p75    | p75 |        | p76     |        |        |     |        |     |        |     |        |     |        |     |     |     |
| 3300pF              |         |     | p74    | p74    | p74 |     |         |     |     |     | p75    |     |        | p75    | p75 |        | p76     |        |        |     |        |     |        |     |        |     |        |     |     |     |
| 4700pF              |         |     | p74    | p74    | p74 |     |         |     |     |     | p75    |     |        | p75    | p75 |        | p76     | p76    | p76    | p76 | p76    |     |        |     |        |     |        |     |     |     |
| 6800pF              |         |     | p74    | p74    | p74 |     |         |     |     |     | p75    |     |        | p75    | p75 |        | p76     | p76    | p76    | p76 | p76    |     |        |     |        |     |        |     |     |     |
| 10000pF             |         |     | p74    | p74    | p74 |     |         |     |     |     | p75    |     |        | p75    | p75 |        | p76     | p76    | p76    | p76 | p76    |     |        |     |        |     |        |     |     |     |
| 15000pF             |         |     |        | p74    |     |     | p74     |     |     |     |        |     |        | p75    | p76 |        | p76     | p76    |        |     | p76    | p76 |        |     |        |     |        |     |     |     |
| 22000pF             |         |     |        | p74    |     |     | p74     |     |     |     |        |     |        | p75    | p76 |        | p76     | p76    |        |     | p76    | p76 |        |     |        |     |        |     |     |     |
| 33000pF             |         |     |        | p74    |     |     | p75     |     |     |     |        |     |        | p75    | p76 |        | p76     | p76    |        |     | p76    | p76 |        |     |        |     |        |     |     |     |
| 47000pF             |         |     |        | p74    |     |     | p75     |     |     |     |        |     |        | p76    | p76 |        | p76     | p76    |        |     | p76    | p76 |        |     |        |     |        |     |     |     |
| 68000pF             |         |     |        | p74    |     |     | p75     |     |     |     |        |     |        | p76    | p76 |        | p76     | p76    |        |     | p76    | p76 |        |     |        |     |        |     |     |     |
| 0.10μF              |         |     |        | p74    | p74 | p75 | p75     |     |     | p75 |        | p75 | p75    | p75    | p75 | p76    | p76     | p76    | p76    | p76 |        |     |        |     |        | p76 | p77    | p77 | p77 | p77 |
| 0.15μF              |         |     |        |        |     |     |         |     |     |     |        |     |        |        |     |        |         |        |        |     |        |     |        |     |        |     |        |     |     |     |
| 0.22μF              |         |     |        |        |     |     |         |     |     |     |        |     |        |        |     |        |         |        |        |     |        |     |        |     |        |     |        |     |     |     |
| 0.33μF              |         |     |        |        |     |     |         |     |     |     |        |     |        |        |     |        |         |        |        |     |        |     |        |     |        |     |        |     |     |     |
| 0.47μF              |         |     |        |        |     |     |         |     |     |     |        |     |        |        |     |        |         |        |        |     |        |     |        |     |        |     |        |     |     |     |
| 0.68μF              |         |     |        |        |     |     |         |     |     |     |        |     |        |        |     |        |         |        |        |     |        |     |        |     |        |     |        |     |     |     |
| 1.0μF               |         |     |        |        |     |     |         |     |     |     |        |     |        |        |     |        |         |        |        |     |        |     |        |     |        |     |        |     |     |     |
| 2.2μF               |         |     |        |        |     |     |         |     |     |     |        |     |        |        |     |        |         |        |        |     |        |     |        |     |        |     |        |     |     |     |
| 4.7μF               |         |     |        |        |     |     |         |     |     |     |        |     |        |        |     |        |         |        |        |     |        |     |        |     |        |     |        |     |     |     |
| 10μF                |         |     |        |        |     |     |         |     |     |     |        |     |        |        |     |        |         |        |        |     |        |     |        |     |        |     |        |     |     |     |
| 22μF                |         |     |        |        |     |     |         |     |     |     |        |     |        |        |     |        |         |        |        |     |        |     |        |     |        |     |        |     |     |     |
| 47μF                |         |     |        |        |     |     |         |     |     |     |        |     |        |        |     |        |         |        |        |     |        |     |        |     |        |     |        |     |     |     |
| 100μF               |         |     |        |        |     |     |         |     |     |     |        |     |        |        |     |        |         |        |        |     |        |     |        |     |        |     |        |     |     |     |
| 220μF               |         |     |        |        |     |     |         |     |     |     |        |     |        |        |     |        |         |        |        |     |        |     |        |     |        |     |        |     |     |     |



# Capacitance Table

p00

Each number in the Part Number List refers to the page number printed at the bottom of the page.

(→ ■ GRM Series High Dielectric Constant Type)

p00 ← Part Number List    JIS: R B    EIA: X7R X7S X7T X7U X6S X6T X5R

| LxW (mm)            | 1.0x0.5 |     |     |        |     |     |     |     |     |      |        |     |        |      |     |        |     |        |     |     |        |     |        |        |     |        |     |     |
|---------------------|---------|-----|-----|--------|-----|-----|-----|-----|-----|------|--------|-----|--------|------|-----|--------|-----|--------|-----|-----|--------|-----|--------|--------|-----|--------|-----|-----|
| T max. (mm)         | 0.22    |     |     | 0.3    |     |     |     |     |     | 0.33 |        |     |        | 0.55 |     |        |     |        |     |     |        |     |        |        |     |        |     |     |
| Rated Voltage (Vdc) | 4       |     | 2.5 | 50     |     | 25  |     | 16  |     | 10   | 10     |     | 6.3    |      | 4   | 100    |     | 50     |     | 35  |        | 25  |        | 16     |     |        |     |     |
| Cap. / TC Code      | X6Δ     | X5R | X7T | X7R, R | B   | X7R | B   | X7R | B   | X5R  | X5R, B | X6T | X5R, B | X6T  | X7R | X7R, R | X6S | X5R, B | X6S | X5R | X7R, R | X6S | X5R, B | X7R, R | X6S | X5R, B |     |     |
| 100pF               |         |     |     |        |     |     |     |     |     |      |        |     |        |      |     |        |     |        |     |     |        |     |        |        |     |        |     |     |
| 150pF               |         |     |     |        |     |     |     |     |     |      |        |     |        |      |     |        |     |        |     |     |        |     |        |        |     |        |     |     |
| 220pF               |         |     |     | p77    | p77 | p77 |     |     |     |      |        |     |        |      | p77 | p77    | p78 |        | p78 |     |        |     |        |        |     |        |     |     |
| 330pF               |         |     |     | p77    | p77 | p77 |     |     |     |      |        |     |        |      | p77 | p77    | p78 |        | p78 |     |        |     |        |        |     |        |     |     |
| 470pF               |         |     |     | p77    | p77 | p77 |     |     |     |      |        |     |        |      | p77 | p77    | p78 |        | p78 |     |        |     |        |        |     |        |     |     |
| 680pF               |         |     |     | p77    | p77 | p77 |     |     |     |      |        |     |        |      | p77 | p77    | p78 |        | p78 |     |        |     |        |        |     |        |     |     |
| 820pF               |         |     |     |        |     |     |     |     |     |      |        |     |        |      |     |        |     |        |     |     |        |     |        |        |     |        |     |     |
| 1000pF              |         |     |     | p77    | p77 | p77 |     |     |     |      |        |     |        |      | p77 | p77    | p78 |        | p78 |     |        |     |        |        |     |        |     |     |
| 1500pF              |         |     |     | p77    | p77 | p77 |     |     |     |      |        |     |        |      | p77 | p77    | p78 |        | p78 |     |        |     |        |        |     |        |     |     |
| 2200pF              |         |     |     |        |     | p77 | p77 |     |     |      |        |     |        |      | p77 | p77    | p78 |        | p78 |     |        |     |        |        |     |        |     |     |
| 3300pF              |         |     |     |        |     |     |     | p77 | p77 |      |        |     |        |      | p77 | p77    | p78 |        | p78 |     |        |     |        |        |     |        |     |     |
| 4700pF              |         |     |     |        |     |     |     |     |     | p77  | p77    |     |        |      | p77 | p77    | p78 |        | p78 |     |        |     |        |        |     |        |     |     |
| 6800pF              |         |     |     |        |     |     |     |     |     |      |        |     |        |      |     |        | p78 | p78    |     | p78 |        |     |        | p78    |     |        |     |     |
| 10000pF             |         |     |     |        |     |     |     |     |     |      |        |     |        |      |     |        | p78 | p78    |     | p78 |        |     |        | p78    | p78 | p78    |     |     |
| 15000pF             |         |     |     |        |     |     |     |     |     |      |        |     |        |      |     |        | p78 |        | p78 |     |        |     |        | p78    | p78 | p78    |     |     |
| 22000pF             |         |     |     |        |     |     |     |     |     |      |        |     |        |      |     |        | p78 |        | p78 |     |        |     |        | p78    | p78 | p78    |     |     |
| 33000pF             |         |     |     |        |     |     |     |     |     |      |        |     |        |      |     |        | p78 | p78    | p78 |     |        |     |        | p78    | p78 | p78    |     |     |
| 47000pF             |         |     |     |        |     |     |     |     |     |      |        |     |        |      |     |        | p78 | p78    | p78 |     |        |     |        | p78    | p78 | p78    |     |     |
| 68000pF             |         |     |     |        |     |     |     |     |     |      |        |     |        |      |     |        | p78 | p78    | p78 |     |        |     |        | p78    | p78 | p78    | p79 | p79 |
| 0.10μF              | p77     |     |     | p77    |     |     |     |     |     |      |        |     |        |      |     |        | p78 |        | p78 | p78 |        |     |        | p78    | p78 |        |     |     |
| 0.15μF              |         |     |     |        |     |     |     |     |     |      |        |     |        |      |     |        |     |        |     |     |        |     |        |        |     |        |     | p79 |
| 0.22μF              | p77     |     |     | p77    |     |     |     |     |     |      |        |     |        |      |     |        |     |        |     |     |        |     |        |        |     |        |     | p79 |
| 0.33μF              |         |     |     |        |     |     |     |     |     |      |        |     |        |      |     |        |     |        |     |     |        |     |        |        |     |        |     |     |
| 0.47μF              | p77     |     |     |        |     |     |     |     |     |      |        |     |        |      |     |        |     |        |     |     |        |     |        |        |     |        |     | p79 |
| 0.68μF              |         |     |     |        |     |     |     |     |     |      |        |     |        |      |     |        |     |        |     |     |        |     |        |        |     |        |     | p79 |
| 1.0μF               | p77     | p77 |     |        |     |     |     |     |     |      |        |     |        |      |     |        |     |        |     |     |        |     |        |        |     |        |     | p79 |
| 2.2μF               |         |     |     |        |     |     |     |     |     |      |        |     |        |      |     |        |     |        |     |     |        |     |        |        |     |        |     | p79 |
| 4.7μF               |         |     |     |        |     |     |     |     |     |      |        |     |        |      |     |        |     |        |     |     |        |     |        |        |     |        |     |     |
| 10μF                |         |     |     |        |     |     |     |     |     |      |        |     |        |      |     |        |     |        |     |     |        |     |        |        |     |        |     |     |
| 22μF                |         |     |     |        |     |     |     |     |     |      |        |     |        |      |     |        |     |        |     |     |        |     |        |        |     |        |     |     |
| 47μF                |         |     |     |        |     |     |     |     |     |      |        |     |        |      |     |        |     |        |     |     |        |     |        |        |     |        |     |     |
| 100μF               |         |     |     |        |     |     |     |     |     |      |        |     |        |      |     |        |     |        |     |     |        |     |        |        |     |        |     |     |
| 220μF               |         |     |     |        |     |     |     |     |     |      |        |     |        |      |     |        |     |        |     |     |        |     |        |        |     |        |     |     |



# Capacitance Table p00 Each number in the Part Number List refers to the page number printed at the bottom of the page.

(→ ■ GRM Series High Dielectric Constant Type)

p00 ← Part Number List    JIS: R B    EIA: X7R X7S X7T X7U X6S X6T X5R

| LxW (mm)            | 1.0x0.5 |     |        |     |     |        |     |     |     |        |        |     |      |     |     |     | 1.6x0.8 |     |     |     |     |        |        |     |     |     |
|---------------------|---------|-----|--------|-----|-----|--------|-----|-----|-----|--------|--------|-----|------|-----|-----|-----|---------|-----|-----|-----|-----|--------|--------|-----|-----|-----|
|                     | 0.55    |     |        |     |     |        | 0.6 |     |     |        |        |     | 0.65 | 0.7 |     |     |         | 0.5 |     |     |     |        |        |     |     |     |
| T max. (mm)         | 10      |     | 6.3    |     | 4   | 35     | 25  | 16  | 6.3 | 4      | 2.5    | 6.3 | 25   | 16  | 10  | 6.3 | 4       | 2.5 | 25  | 16  | 6.3 | 4      |        |     |     |     |
| Rated Voltage (Vdc) | X7R     | X6S | X5R, B | X7R | X6S | X5R, B | X7R | X5R | X6S | X5R, B | X5R, B | X6T | X6S  | X5R | X6S | X5R | X7S     | X6S | X7S | X5R | X5R | X5R, B | X5R, B | X5R | X5R |     |
| Cap. / TC Code      | X7R     | X6S | X5R, B | X7R | X6S | X5R, B | X7R | X5R | X6S | X5R, B | X5R, B | X6T | X6S  | X5R | X6S | X5R | X7S     | X6S | X7S | X5R | X5R | X5R, B | X5R, B | X5R | X5R |     |
| 100pF               |         |     |        |     |     |        |     |     |     |        |        |     |      |     |     |     |         |     |     |     |     |        |        |     |     |     |
| 150pF               |         |     |        |     |     |        |     |     |     |        |        |     |      |     |     |     |         |     |     |     |     |        |        |     |     |     |
| 220pF               |         |     |        |     |     |        |     |     |     |        |        |     |      |     |     |     |         |     |     |     |     |        |        |     |     |     |
| 330pF               |         |     |        |     |     |        |     |     |     |        |        |     |      |     |     |     |         |     |     |     |     |        |        |     |     |     |
| 470pF               |         |     |        |     |     |        |     |     |     |        |        |     |      |     |     |     |         |     |     |     |     |        |        |     |     |     |
| 680pF               |         |     |        |     |     |        |     |     |     |        |        |     |      |     |     |     |         |     |     |     |     |        |        |     |     |     |
| 820pF               |         |     |        |     |     |        |     |     |     |        |        |     |      |     |     |     |         |     |     |     |     |        |        |     |     |     |
| 1000pF              |         |     |        |     |     |        |     |     |     |        |        |     |      |     |     |     |         |     |     |     |     |        |        |     |     |     |
| 1500pF              |         |     |        |     |     |        |     |     |     |        |        |     |      |     |     |     |         |     |     |     |     |        |        |     |     |     |
| 2200pF              |         |     |        |     |     |        |     |     |     |        |        |     |      |     |     |     |         |     |     |     |     |        |        |     |     |     |
| 3300pF              |         |     |        |     |     |        |     |     |     |        |        |     |      |     |     |     |         |     |     |     |     |        |        |     |     |     |
| 4700pF              |         |     |        |     |     |        |     |     |     |        |        |     |      |     |     |     |         |     |     |     |     |        |        |     |     |     |
| 6800pF              |         |     |        |     |     |        |     |     |     |        |        |     |      |     |     |     |         |     |     |     |     |        |        |     |     |     |
| 10000pF             |         |     |        |     |     |        |     |     |     |        |        |     |      |     |     |     |         |     |     |     |     |        |        |     |     |     |
| 15000pF             |         |     |        |     |     |        |     |     |     |        |        |     |      |     |     |     |         |     |     |     |     |        |        |     |     |     |
| 22000pF             |         |     |        |     |     |        |     |     |     |        |        |     |      |     |     |     |         |     |     |     |     |        |        |     |     |     |
| 33000pF             |         |     |        |     |     |        |     |     |     |        |        |     |      |     |     |     |         |     |     |     |     |        |        |     |     |     |
| 47000pF             |         |     |        |     |     |        |     |     |     |        |        |     |      |     |     |     |         |     |     |     |     |        |        |     |     |     |
| 68000pF             |         |     |        |     |     |        |     |     |     |        |        |     |      |     |     |     |         |     |     |     |     |        |        |     |     |     |
| 0.10μF              |         |     |        |     |     |        |     |     |     |        |        |     |      |     |     |     |         |     |     |     |     |        |        |     |     |     |
| 0.15μF              |         |     | p79    | p79 |     |        | p79 | p79 |     |        |        |     |      |     |     |     |         |     |     |     |     |        |        |     |     |     |
| 0.22μF              | p79     |     | p79    | p79 |     |        | p79 | p79 |     |        |        |     |      |     |     |     |         |     |     |     |     |        |        |     |     |     |
| 0.33μF              |         |     | p79    | p79 |     |        | p79 | p79 |     |        |        |     |      |     |     |     |         |     |     |     |     |        |        |     |     |     |
| 0.47μF              | p79     |     | p79    | p79 |     |        | p79 | p79 |     |        |        |     |      |     |     |     |         |     |     |     |     |        |        |     |     |     |
| 0.68μF              |         |     | p79    | p79 |     |        | p79 | p79 |     |        |        |     |      |     |     |     |         |     |     |     |     |        |        |     |     |     |
| 1.0μF               |         | p79 |        | p79 |     |        | p79 | p79 | p79 | p79    |        |     |      |     |     |     |         |     |     |     |     |        | p80    | p80 | p80 | p80 |
| 2.2μF               |         |     | p79    |     | p79 | p79    |     |     |     |        |        |     | p79  | p79 | p79 | p79 | p79     | p79 |     |     |     |        |        |     |     |     |
| 4.7μF               |         |     |        |     |     |        |     |     |     |        |        | p79 | p79  | p79 | p79 |     |         |     |     |     |     |        |        |     |     |     |
| 10μF                |         |     |        |     |     |        |     |     |     |        |        |     |      |     |     |     |         |     |     |     |     |        |        |     |     |     |
| 22μF                |         |     |        |     |     |        |     |     |     |        |        |     |      |     |     |     |         |     |     |     |     |        |        |     |     |     |
| 47μF                |         |     |        |     |     |        |     |     |     |        |        |     |      |     |     |     |         |     |     |     |     |        |        |     |     |     |
| 100μF               |         |     |        |     |     |        |     |     |     |        |        |     |      |     |     |     |         |     |     |     |     |        |        |     |     |     |
| 220μF               |         |     |        |     |     |        |     |     |     |        |        |     |      |     |     |     |         |     |     |     |     |        |        |     |     |     |





# Capacitance Table

p00

Each number in the Part Number List refers to the page number printed at the bottom of the page.

(→ ■ GRM Series High Dielectric Constant Type)

p00 ← Part Number List    JIS: R B    EIA: X7R X7S X7T X7U X6S X6T X5R

| LxW (mm)            | 1.6x0.8 |     |     |     |     |     |     |     |        |        |        |        |        |     |        |     |        |   |     |     |        |     |        |     |     |     |  |  |
|---------------------|---------|-----|-----|-----|-----|-----|-----|-----|--------|--------|--------|--------|--------|-----|--------|-----|--------|---|-----|-----|--------|-----|--------|-----|-----|-----|--|--|
| T max. (mm)         | 0.55    |     |     |     |     | 0.9 |     |     |        |        |        | 1.0    |        |     |        | 1.0 |        |   |     |     |        |     |        |     |     |     |  |  |
| Rated Voltage (Vdc) | 16      | 10  | 6.3 | 250 | 200 | 100 | 50  | 25  | 16     | 10     | 6.3    | 25     | 16     | 10  | 50     | 35  |        |   |     |     |        |     |        |     |     |     |  |  |
| Cap. / TC Code      | X5R     | X6S | X5R | X7T | X6S | X7R | X7R | X7R | X7R, R | X5R, B | X7R, R | X5R, B | X7Δ, R | X6S | X5R, B | X7Δ | X5R, B | B | X5R | X6S | X5R, B | X7S | X5R, B | X5R | X6S | X5R |  |  |
| 100pF               |         |     |     |     |     |     |     |     |        |        |        |        |        |     |        |     |        |   |     |     |        |     |        |     |     |     |  |  |
| 150pF               |         |     |     |     |     |     |     |     |        |        |        |        |        |     |        |     |        |   |     |     |        |     |        |     |     |     |  |  |
| 220pF               |         |     |     |     |     | p80 | p80 | p80 | p80    | p80    | p80    | p80    |        |     |        |     |        |   |     |     |        |     |        |     |     |     |  |  |
| 330pF               |         |     |     |     |     | p80 | p80 | p80 | p80    | p80    | p80    | p80    |        |     |        |     |        |   |     |     |        |     |        |     |     |     |  |  |
| 470pF               |         |     |     |     |     | p80 | p80 | p80 | p80    | p80    | p80    | p80    |        |     |        |     |        |   |     |     |        |     |        |     |     |     |  |  |
| 680pF               |         |     |     |     |     | p80 | p80 | p80 | p80    | p80    | p80    | p80    |        |     |        |     |        |   |     |     |        |     |        |     |     |     |  |  |
| 820pF               |         |     |     |     |     |     |     |     |        |        |        |        |        |     |        |     |        |   |     |     |        |     |        |     |     |     |  |  |
| 1000pF              |         |     |     |     |     | p80 | p80 | p80 | p80    | p80    | p80    | p80    |        |     |        |     |        |   |     |     |        |     |        |     |     |     |  |  |
| 1500pF              |         |     |     |     |     | p80 | p80 | p80 | p80    | p80    | p80    | p80    |        |     |        |     |        |   |     |     |        |     |        |     |     |     |  |  |
| 2200pF              |         |     |     |     |     | p80 | p80 | p80 | p80    | p80    | p80    | p80    |        |     |        |     |        |   |     |     |        |     |        |     |     |     |  |  |
| 3300pF              |         |     |     |     |     |     |     | p80 | p80    | p80    | p80    | p80    |        |     |        |     |        |   |     |     |        |     |        |     |     |     |  |  |
| 4700pF              |         |     |     |     |     |     |     | p80 | p80    | p80    | p81    | p81    |        |     |        |     |        |   |     |     |        |     |        |     |     |     |  |  |
| 6800pF              |         |     |     |     |     |     |     | p80 | p80    | p80    | p81    | p81    |        |     |        |     |        |   |     |     |        |     |        |     |     |     |  |  |
| 10000pF             |         |     |     |     |     |     |     | p80 | p80    | p80    | p81    | p81    | p81    |     |        |     |        |   |     |     |        |     |        |     |     |     |  |  |
| 15000pF             |         |     |     |     |     |     |     | p80 | p80    | p80    | p81    | p81    | p81    |     |        |     |        |   |     |     |        |     |        |     |     |     |  |  |
| 22000pF             |         |     |     |     |     |     |     | p80 | p80    | p80    | p81    | p81    | p81    |     |        |     |        |   |     |     |        |     |        |     |     |     |  |  |
| 33000pF             |         |     |     |     |     |     |     | p80 | p80    | p80    | p81    | p81    | p81    | p81 |        |     |        |   |     |     |        |     |        |     |     |     |  |  |
| 47000pF             |         |     |     |     |     |     |     | p80 | p80    | p80    | p81    | p81    | p81    | p81 |        |     |        |   |     |     |        |     |        |     |     |     |  |  |
| 68000pF             |         |     |     |     |     |     |     | p80 | p80    | p80    | p81    | p81    | p81    | p81 |        |     |        |   |     |     |        |     |        |     |     |     |  |  |
| 0.10μF              |         |     |     |     |     | p80 | p80 | p80 | p81    | p81    | p81    | p81    | p81    |     |        |     |        |   |     |     |        |     |        |     |     |     |  |  |
| 0.15μF              |         |     |     |     |     |     |     | p80 | p81    | p81    | p81    | p81    | p81    | p81 |        |     |        |   |     |     |        |     |        |     |     |     |  |  |
| 0.22μF              |         |     |     |     |     |     |     | p80 | p80    | p81    | p81    | p81    | p81    | p81 | p81    |     |        |   |     |     |        |     |        |     |     |     |  |  |
| 0.33μF              |         |     |     |     |     |     |     |     |        |        |        |        | p81    | p81 | p81    | p81 |        |   | p81 | p81 | p81    | p81 |        |     |     |     |  |  |
| 0.47μF              |         |     |     |     |     |     |     |     |        |        |        |        | p80    | p81 | p81    | p81 | p81    |   |     |     |        |     |        |     |     |     |  |  |
| 0.68μF              |         |     |     |     |     |     |     |     |        |        |        |        |        |     |        |     |        |   | p81 | p81 | p81    |     |        |     |     |     |  |  |
| 1.0μF               |         |     |     |     |     |     |     |     |        |        |        |        |        |     |        |     |        |   |     |     |        |     |        |     |     |     |  |  |
| 2.2μF               |         |     |     |     |     |     |     |     |        |        |        |        |        |     |        |     |        |   |     |     |        |     |        |     |     |     |  |  |
| 4.7μF               | p80     | p80 | p80 | p80 | p80 |     |     |     |        |        |        |        |        |     |        |     |        |   |     |     |        |     |        |     |     |     |  |  |
| 10μF                |         |     |     |     |     |     |     |     |        |        |        |        |        |     |        |     |        |   |     |     |        |     |        |     |     |     |  |  |
| 22μF                |         |     |     |     |     |     |     |     |        |        |        |        |        |     |        |     |        |   |     |     |        |     |        |     |     |     |  |  |
| 47μF                |         |     |     |     |     |     |     |     |        |        |        |        |        |     |        |     |        |   |     |     |        |     |        |     |     |     |  |  |
| 100μF               |         |     |     |     |     |     |     |     |        |        |        |        |        |     |        |     |        |   |     |     |        |     |        |     |     |     |  |  |
| 220μF               |         |     |     |     |     |     |     |     |        |        |        |        |        |     |        |     |        |   |     |     |        |     |        |     |     |     |  |  |



# Capacitance Table

p00

Each number in the Part Number List refers to the page number printed at the bottom of the page.

## (→ ■ GRM Series High Dielectric Constant Type)

p00 ← Part Number List    JIS: R B    EIA: X7R X7S X7T X7U X6S X6T X5R

| LxW (mm)            | 1.6x0.8 |     |     |     |     |     |     |        |     |        |     | 2.0x1.25 |        |        |     |     |        |     |        |        |     |        |        |     |        |        |     |        |     |        |     |        |     |  |  |
|---------------------|---------|-----|-----|-----|-----|-----|-----|--------|-----|--------|-----|----------|--------|--------|-----|-----|--------|-----|--------|--------|-----|--------|--------|-----|--------|--------|-----|--------|-----|--------|-----|--------|-----|--|--|
|                     | 1.0     |     |     |     |     |     |     |        |     |        |     | 0.7      | 0.95   |        |     |     |        |     |        |        |     |        |        |     |        |        |     |        |     |        |     |        |     |  |  |
| T max. (mm)         | 1.0     |     |     |     |     |     |     |        |     |        |     | 0.7      | 0.95   |        |     |     |        |     |        |        |     |        |        |     |        |        |     |        |     |        |     |        |     |  |  |
| Rated Voltage (Vdc) | 25      |     |     | 16  |     |     | 10  |        |     | 6.3    |     |          | 4      |        |     | 16  | 100    | 50  |        |        | 35  |        |        | 25  |        |        | 16  |        |     | 10     |     |        | 6.3 |  |  |
| Cap. / TC Code      | X7S     | X6S | X5R | X7S | X6S | X7T | X7T | X5R, B | X6S | X5R, B | X6S | X7R      | X7R, R | X5R, B | X6S | X5R | X7R, R | X6S | X5R, B | X7R, R | X6S | X5R, B | X7R, R | X6S | X5R, B | X7R, R | X6S | X5R, B | X7Δ | X5R, B | X6S | X5R, B |     |  |  |
| 100pF               |         |     |     |     |     |     |     |        |     |        |     |          |        |        |     |     |        |     |        |        |     |        |        |     |        |        |     |        |     |        |     |        |     |  |  |
| 150pF               |         |     |     |     |     |     |     |        |     |        |     |          |        |        |     |     |        |     |        |        |     |        |        |     |        |        |     |        |     |        |     |        |     |  |  |
| 220pF               |         |     |     |     |     |     |     |        |     |        |     |          |        |        |     |     |        |     |        |        |     |        |        |     |        |        |     |        |     |        |     |        |     |  |  |
| 330pF               |         |     |     |     |     |     |     |        |     |        |     |          |        |        |     |     |        |     |        |        |     |        |        |     |        |        |     |        |     |        |     |        |     |  |  |
| 470pF               |         |     |     |     |     |     |     |        |     |        |     |          |        |        |     |     |        |     |        |        |     |        |        |     |        |        |     |        |     |        |     |        |     |  |  |
| 680pF               |         |     |     |     |     |     |     |        |     |        |     |          |        |        |     |     |        |     |        |        |     |        |        |     |        |        |     |        |     |        |     |        |     |  |  |
| 820pF               |         |     |     |     |     |     |     |        |     |        |     |          |        |        |     |     |        |     |        |        |     |        |        |     |        |        |     |        |     |        |     |        |     |  |  |
| 1000pF              |         |     |     |     |     |     |     |        |     |        |     |          |        |        |     |     |        |     |        |        |     |        |        |     |        |        |     |        |     |        |     |        |     |  |  |
| 1500pF              |         |     |     |     |     |     |     |        |     |        |     |          |        |        |     |     |        |     |        |        |     |        |        |     |        |        |     |        |     |        |     |        |     |  |  |
| 2200pF              |         |     |     |     |     |     |     |        |     |        |     |          |        |        |     |     |        |     |        |        |     |        |        |     |        |        |     |        |     |        |     |        |     |  |  |
| 3300pF              |         |     |     |     |     |     |     |        |     |        |     |          |        |        |     |     |        |     |        |        |     |        |        |     |        |        |     |        |     |        |     |        |     |  |  |
| 4700pF              |         |     |     |     |     |     |     |        |     |        |     |          |        |        |     |     |        |     |        |        |     |        |        |     |        |        |     |        |     |        |     |        |     |  |  |
| 6800pF              |         |     |     |     |     |     |     |        |     |        |     |          |        |        |     |     |        |     |        |        |     |        |        |     |        |        |     |        |     |        |     |        |     |  |  |
| 10000pF             |         |     |     |     |     |     |     |        |     |        |     |          |        |        |     |     |        |     |        |        |     |        |        |     |        |        |     |        |     |        |     |        |     |  |  |
| 15000pF             |         |     |     |     |     |     |     |        |     |        |     |          |        |        |     |     |        |     |        |        |     |        |        |     |        |        |     |        |     |        |     |        |     |  |  |
| 22000pF             |         |     |     |     |     |     |     |        |     |        |     |          |        |        |     |     |        |     |        |        |     |        |        |     |        |        |     |        |     |        |     |        |     |  |  |
| 33000pF             |         |     |     |     |     |     |     |        |     |        |     |          |        |        |     |     |        |     |        |        |     |        |        |     |        |        |     |        |     |        |     |        |     |  |  |
| 47000pF             |         |     |     |     |     |     |     |        |     |        |     |          |        |        |     |     |        |     |        |        |     |        |        |     |        |        |     |        |     |        |     |        |     |  |  |
| 68000pF             |         |     |     |     |     |     |     |        |     |        |     |          |        |        |     |     |        |     |        |        |     |        |        |     |        |        |     |        |     |        |     |        |     |  |  |
| 0.10μF              |         |     |     |     |     |     |     |        |     |        |     |          |        |        |     |     |        |     |        |        |     |        |        |     |        |        |     |        |     |        |     |        |     |  |  |
| 0.15μF              |         |     |     |     |     |     |     |        |     |        |     |          |        |        |     |     |        |     |        |        |     |        |        |     |        |        |     |        |     |        |     |        |     |  |  |
| 0.22μF              |         |     |     |     |     |     |     |        |     |        |     |          |        |        |     |     |        |     |        |        |     |        |        |     |        |        |     |        |     |        |     |        |     |  |  |
| 0.33μF              |         |     |     |     |     |     |     |        |     |        |     |          |        |        |     |     |        |     |        |        |     |        |        |     |        |        |     |        |     |        |     |        |     |  |  |
| 0.47μF              |         |     |     |     |     |     |     |        |     |        |     |          |        |        |     |     |        |     |        |        |     |        |        |     |        |        |     |        |     |        |     |        |     |  |  |
| 0.68μF              |         |     |     |     |     |     |     |        |     |        |     |          |        |        |     |     |        |     |        |        |     |        |        |     |        |        |     |        |     |        |     |        |     |  |  |
| 1.0μF               |         |     |     |     |     |     |     |        |     |        |     |          |        |        |     |     |        |     |        |        |     |        |        |     |        |        |     |        |     |        |     |        |     |  |  |
| 2.2μF               | p82     | p82 |     | p82 |     |     |     |        |     |        |     |          |        |        |     |     |        |     |        |        |     |        |        |     |        |        |     |        |     |        |     |        |     |  |  |
| 4.7μF               |         | p82 |     |     |     |     |     |        |     |        |     |          |        |        |     |     |        |     |        |        |     |        |        |     |        |        |     |        |     |        |     |        |     |  |  |
| 10μF                |         |     | p82 |     | p82 | p82 | p82 |        |     |        |     |          |        |        |     |     |        |     |        |        |     |        |        |     |        |        |     |        |     |        |     |        |     |  |  |
| 22μF                |         |     |     |     |     |     |     |        |     |        |     |          |        |        |     |     |        |     |        |        |     |        |        |     |        |        |     |        |     |        |     |        |     |  |  |
| 47μF                |         |     |     |     |     |     |     |        |     |        |     |          |        |        |     |     |        |     |        |        |     |        |        |     |        |        |     |        |     |        |     |        |     |  |  |
| 100μF               |         |     |     |     |     |     |     |        |     |        |     |          |        |        |     |     |        |     |        |        |     |        |        |     |        |        |     |        |     |        |     |        |     |  |  |
| 220μF               |         |     |     |     |     |     |     |        |     |        |     |          |        |        |     |     |        |     |        |        |     |        |        |     |        |        |     |        |     |        |     |        |     |  |  |



# Capacitance Table

p00

Each number in the Part Number List refers to the page number printed at the bottom of the page.

(→ ■ GRM Series High Dielectric Constant Type)

p00 ← Part Number List    JIS: R B    EIA: X7R X7S X7T X7U X6S X6T X5R

| LxW (mm)            | 2.0x1.25 |     |     |     |     |     |     |     |     |      |     |     |        |        |     |     |        |     |        |     |        |        |        |     |     |     |  |
|---------------------|----------|-----|-----|-----|-----|-----|-----|-----|-----|------|-----|-----|--------|--------|-----|-----|--------|-----|--------|-----|--------|--------|--------|-----|-----|-----|--|
| T max. (mm)         | 0.95     |     |     | 1.0 |     |     |     |     |     | 1.35 |     |     |        |        |     | 1.4 |        |     |        |     |        |        |        |     |     |     |  |
| Rated Voltage (Vdc) | 4        | 2.5 | 250 | 200 | 100 | 50  | 35  | 25  | 16  | 100  | 50  | 25  | 16     | 100    | 50  | 25  | 16     |     |        |     |        |        |        |     |     |     |  |
| Cap. / TC Code      | X6S      | X5R | X6T | X7R | X7R | X7R | X6S | X7S | X6S | X7S  | X5R | X7R | X7R, R | X5R, B | R   | X6S | X5R, B | X7R | X5R, B | X7R | X5R, B | X7R, R | X5R, B | X7R | X6S |     |  |
| 100pF               |          |     |     |     |     |     |     |     |     |      |     |     |        |        |     |     |        |     |        |     |        |        |        |     |     |     |  |
| 150pF               |          |     |     |     |     |     |     |     |     |      |     |     |        |        |     |     |        |     |        |     |        |        |        |     |     |     |  |
| 220pF               |          |     |     |     |     |     |     |     |     |      |     |     |        |        |     |     |        |     |        |     |        |        |        |     |     |     |  |
| 330pF               |          |     |     |     |     |     |     |     |     |      |     |     |        |        |     |     |        |     |        |     |        |        |        |     |     |     |  |
| 470pF               |          |     |     |     |     |     |     |     |     |      |     |     |        |        |     |     |        |     |        |     |        |        |        |     |     |     |  |
| 680pF               |          |     |     |     |     |     |     |     |     |      |     |     |        |        |     |     |        |     |        |     |        |        |        |     |     |     |  |
| 820pF               |          |     |     |     |     |     |     |     |     |      |     |     |        |        |     |     |        |     |        |     |        |        |        |     |     |     |  |
| 1000pF              |          |     |     | p82 | p83 |     |     |     |     |      |     |     |        |        |     |     |        |     |        |     |        |        |        |     |     |     |  |
| 1500pF              |          |     |     | p83 | p83 |     |     |     |     |      |     |     |        |        |     |     |        |     |        |     |        |        |        |     |     |     |  |
| 2200pF              |          |     |     | p83 | p83 |     |     |     |     |      |     |     |        |        |     |     |        |     |        |     |        |        |        |     |     |     |  |
| 3300pF              |          |     |     | p83 | p83 |     |     |     |     |      |     |     |        |        |     |     |        |     |        |     |        |        |        |     |     |     |  |
| 4700pF              |          |     |     | p83 | p83 |     |     |     |     |      |     |     |        |        |     |     |        |     |        |     |        |        |        |     |     |     |  |
| 6800pF              |          |     |     | p83 | p83 |     |     |     |     |      |     |     |        |        |     |     |        |     |        |     |        |        |        |     |     |     |  |
| 10000pF             |          |     |     |     |     |     |     |     |     |      |     | p83 |        |        |     |     |        |     |        |     |        |        |        |     |     |     |  |
| 15000pF             |          |     |     |     |     |     |     |     |     |      |     | p83 |        |        |     |     |        |     |        |     |        |        |        |     |     |     |  |
| 22000pF             |          |     |     |     |     |     | p83 |     |     |      |     | p83 |        |        |     |     |        |     |        |     |        |        |        |     |     |     |  |
| 33000pF             |          |     |     |     |     |     |     |     |     |      |     | p83 |        |        |     |     |        |     |        |     |        |        |        |     |     |     |  |
| 47000pF             |          |     |     |     |     |     |     |     |     |      |     | p83 | p83    |        |     |     |        |     |        |     |        |        |        |     |     |     |  |
| 68000pF             |          |     |     |     |     |     |     |     |     |      |     | p83 | p83    |        |     |     |        |     |        |     |        |        |        |     |     |     |  |
| 0.10μF              |          |     |     |     |     |     |     |     |     |      |     | p83 | p83    | p83    |     |     |        |     |        |     |        |        |        |     |     |     |  |
| 0.15μF              |          |     |     |     |     |     |     |     |     |      |     | p83 | p83    | p83    |     |     |        |     |        |     |        |        |        |     |     |     |  |
| 0.22μF              |          |     |     |     |     |     | p83 |     |     |      |     | p83 | p83    |        |     |     |        |     |        |     |        |        |        |     |     |     |  |
| 0.33μF              |          |     |     |     |     |     | p83 |     |     |      |     |     |        |        |     |     |        |     |        |     |        |        |        |     |     |     |  |
| 0.47μF              |          |     |     |     |     |     |     |     |     |      |     | p83 | p83    |        |     |     |        |     |        |     |        | p83    |        |     |     |     |  |
| 0.68μF              |          |     |     |     |     |     |     |     |     |      |     |     |        | p83    |     |     |        |     |        |     |        |        |        |     |     |     |  |
| 1.0μF               |          |     |     |     |     |     |     |     |     |      |     | p83 | p83    |        |     |     |        |     |        |     |        |        | p83    | p83 |     |     |  |
| 2.2μF               |          |     |     |     |     |     |     |     |     |      |     |     |        | p83    | p83 |     |        |     |        |     |        | p83    | p83    | p83 |     |     |  |
| 4.7μF               |          |     |     |     |     |     |     |     |     |      |     |     |        | p83    | p83 | p83 |        |     |        |     |        | p83    | p83    | p83 |     | p83 |  |
| 10μF                | p82      |     |     |     |     |     |     |     |     |      |     |     |        |        |     |     |        |     |        |     |        |        |        |     |     |     |  |
| 22μF                |          |     |     |     |     |     |     |     |     |      | p83 |     |        |        |     |     |        |     |        |     |        |        |        |     |     |     |  |
| 47μF                |          | p82 | p82 |     |     |     |     |     |     |      |     |     |        |        |     |     |        |     |        |     |        |        |        |     |     |     |  |
| 100μF               |          |     |     |     |     |     |     |     |     |      |     |     |        |        |     |     |        |     |        |     |        |        |        |     |     |     |  |
| 220μF               |          |     |     |     |     |     |     |     |     |      |     |     |        |        |     |     |        |     |        |     |        |        |        |     |     |     |  |



# Capacitance Table p00 Each number in the Part Number List refers to the page number printed at the bottom of the page.

(→ ■ GRM Series High Dielectric Constant Type)

p00 ← Part Number List    JIS: R B    EIA: X7R X7S X7T X7U X6S X6T X5R

| LxW (mm)            | 2.0x1.25 |     |     |     |     |     |     |     |     |     |     |     |     |     |      |     |     |     |     |     |     |     |     |        |     |        |  |  |
|---------------------|----------|-----|-----|-----|-----|-----|-----|-----|-----|-----|-----|-----|-----|-----|------|-----|-----|-----|-----|-----|-----|-----|-----|--------|-----|--------|--|--|
| T max. (mm)         | 1.4      |     |     |     |     |     |     |     |     |     |     |     |     |     | 1.45 |     |     |     |     |     |     |     |     |        |     |        |  |  |
| Rated Voltage (Vdc) | 10       |     | 6.3 |     | 4   |     | 250 | 200 | 50  |     | 35  |     |     | 25  |      |     | 16  |     |     | 10  |     | 6.3 |     | 4      |     |        |  |  |
| Cap. / TC Code      | X7R      | B   | X7R | X6S | X7U | X6S | X7R | X7R | X7S | X6S | X7S | X6S | X5R | X7S | X6S  | X5R | X7S | X6S | X5R | X7T | X6S | X5R | X7T | X5R, B | X6S | X5R, B |  |  |
| 100pF               |          |     |     |     |     |     |     |     |     |     |     |     |     |     |      |     |     |     |     |     |     |     |     |        |     |        |  |  |
| 150pF               |          |     |     |     |     |     |     |     |     |     |     |     |     |     |      |     |     |     |     |     |     |     |     |        |     |        |  |  |
| 220pF               |          |     |     |     |     |     |     |     |     |     |     |     |     |     |      |     |     |     |     |     |     |     |     |        |     |        |  |  |
| 330pF               |          |     |     |     |     |     |     |     |     |     |     |     |     |     |      |     |     |     |     |     |     |     |     |        |     |        |  |  |
| 470pF               |          |     |     |     |     |     |     |     |     |     |     |     |     |     |      |     |     |     |     |     |     |     |     |        |     |        |  |  |
| 680pF               |          |     |     |     |     |     |     |     |     |     |     |     |     |     |      |     |     |     |     |     |     |     |     |        |     |        |  |  |
| 820pF               |          |     |     |     |     |     |     |     |     |     |     |     |     |     |      |     |     |     |     |     |     |     |     |        |     |        |  |  |
| 1000pF              |          |     |     |     |     |     |     |     |     |     |     |     |     |     |      |     |     |     |     |     |     |     |     |        |     |        |  |  |
| 1500pF              |          |     |     |     |     |     |     |     |     |     |     |     |     |     |      |     |     |     |     |     |     |     |     |        |     |        |  |  |
| 2200pF              |          |     |     |     |     |     |     |     |     |     |     |     |     |     |      |     |     |     |     |     |     |     |     |        |     |        |  |  |
| 3300pF              |          |     |     |     |     |     |     |     |     |     |     |     |     |     |      |     |     |     |     |     |     |     |     |        |     |        |  |  |
| 4700pF              |          |     |     |     |     |     |     |     |     |     |     |     |     |     |      |     |     |     |     |     |     |     |     |        |     |        |  |  |
| 6800pF              |          |     |     |     |     |     |     |     |     |     |     |     |     |     |      |     |     |     |     |     |     |     |     |        |     |        |  |  |
| 10000pF             |          |     |     |     |     |     |     |     |     |     |     |     |     |     |      |     |     |     |     |     |     |     |     |        |     |        |  |  |
| 15000pF             |          |     |     |     |     |     |     |     |     |     |     |     |     |     |      |     |     |     |     |     |     |     |     |        |     |        |  |  |
| 22000pF             |          |     |     |     |     |     |     |     |     |     |     |     |     |     |      |     |     |     |     |     |     |     |     |        |     |        |  |  |
| 33000pF             |          |     |     |     |     |     |     |     |     |     |     |     |     |     |      |     |     |     |     |     |     |     |     |        |     |        |  |  |
| 47000pF             |          |     |     |     |     |     |     |     |     |     |     |     |     |     |      |     |     |     |     |     |     |     |     |        |     |        |  |  |
| 68000pF             |          |     |     |     |     |     |     |     |     |     |     |     |     |     |      |     |     |     |     |     |     |     |     |        |     |        |  |  |
| 0.10μF              |          |     |     |     |     |     |     |     |     |     |     |     |     |     |      |     |     |     |     |     |     |     |     |        |     |        |  |  |
| 0.15μF              |          |     |     |     |     |     |     |     |     |     |     |     |     |     |      |     |     |     |     |     |     |     |     |        |     |        |  |  |
| 0.22μF              |          |     |     |     |     |     |     |     |     |     |     |     |     |     |      |     |     |     |     |     |     |     |     |        |     |        |  |  |
| 0.33μF              |          |     |     |     |     |     |     |     |     |     |     |     |     |     |      |     |     |     |     |     |     |     |     |        |     |        |  |  |
| 0.47μF              |          |     |     |     |     |     |     |     |     |     |     |     |     |     |      |     |     |     |     |     |     |     |     |        |     |        |  |  |
| 0.68μF              |          |     |     |     |     |     |     |     |     |     |     |     |     |     |      |     |     |     |     |     |     |     |     |        |     |        |  |  |
| 1.0μF               |          |     |     |     |     |     |     |     |     |     |     |     |     |     |      |     |     |     |     |     |     |     |     |        |     |        |  |  |
| 2.2μF               |          |     |     |     |     |     |     |     |     |     |     |     |     |     |      |     |     |     |     |     |     |     |     |        |     |        |  |  |
| 4.7μF               | p83      |     |     |     |     |     |     |     |     |     |     |     |     |     |      |     |     |     |     |     |     |     |     |        |     |        |  |  |
| 10μF                | p83      |     |     |     |     |     |     |     |     |     |     |     |     |     |      |     |     |     |     |     |     |     |     |        |     |        |  |  |
| 22μF                |          | p83 |     |     |     |     |     |     |     |     |     |     |     |     |      |     |     |     |     |     |     |     |     |        |     |        |  |  |
| 47μF                |          |     |     |     |     |     |     |     |     |     |     |     |     |     |      |     |     |     |     |     |     |     |     |        |     |        |  |  |
| 100μF               |          |     |     |     |     |     |     |     |     |     |     |     |     |     |      |     |     |     |     |     |     |     |     |        |     |        |  |  |
| 220μF               |          |     |     |     |     |     |     |     |     |     |     |     |     |     |      |     |     |     |     |     |     |     |     |        |     |        |  |  |



# Capacitance Table

p00

Each number in the Part Number List refers to the page number printed at the bottom of the page.

(→ ■ GRM Series High Dielectric Constant Type)

p00 ← Part Number List    JIS: R B    EIA: X7R X7S X7T X7U X6S X6T X5R

| LxW (mm)            | 3.2x1.6 |    |        |        |     |        |      |      |     |     |     |    |     |      |     |     |     |     |     |        |     |        |     |     |
|---------------------|---------|----|--------|--------|-----|--------|------|------|-----|-----|-----|----|-----|------|-----|-----|-----|-----|-----|--------|-----|--------|-----|-----|
| T max. (mm)         | 0.95    |    |        |        |     | 1.0    |      | 1.25 |     |     |     |    | 1.3 |      | 1.8 |     |     |     |     |        |     |        |     |     |
| Rated Voltage (Vdc) | 35      | 25 | 16     | 10     | 6.3 | 630    | 1000 | 630  | 250 | 200 | 50  | 25 | 100 | 1000 | 630 | 250 | 200 | 100 | 50  | 25     | 16  |        |     |     |
| Cap. / TC Code      | X5R     | R  | X5R, B | X5R, B | X6S | X5R, B | X7R  | X7R  | X7R | X7R | X7R | B  | X5R | X7R  | X7R | X7R | X7R | X7R | X7R | X5R, B | X7R | X5R, B | X7R | X6S |
| 100pF               |         |    |        |        |     |        |      |      |     |     |     |    |     |      |     |     |     |     |     |        |     |        |     |     |
| 150pF               |         |    |        |        |     |        |      |      |     |     |     |    |     |      |     |     |     |     |     |        |     |        |     |     |
| 220pF               |         |    |        |        |     |        |      |      |     |     |     |    |     |      |     |     |     |     |     |        |     |        |     |     |
| 330pF               |         |    |        |        |     |        |      |      |     |     |     |    |     |      |     |     |     |     |     |        |     |        |     |     |
| 470pF               |         |    |        |        |     |        |      |      |     |     |     |    |     |      |     |     |     |     |     |        |     |        |     |     |
| 680pF               |         |    |        |        |     |        |      |      |     |     |     |    |     |      |     |     |     |     |     |        |     |        |     |     |
| 820pF               |         |    |        |        |     |        |      |      |     |     |     |    |     |      |     |     |     |     |     |        |     |        |     |     |
| 1000pF              |         |    |        |        |     |        |      |      |     |     |     |    |     |      |     |     |     |     |     |        |     |        |     |     |
| 1500pF              |         |    |        |        |     |        |      |      |     |     |     |    |     |      |     |     |     |     |     |        |     |        |     |     |
| 2200pF              |         |    |        |        |     |        |      |      |     |     |     |    |     |      |     |     |     |     |     |        |     |        |     |     |
| 3300pF              |         |    |        |        |     |        |      |      |     |     |     |    |     |      |     |     |     |     |     |        |     |        |     |     |
| 4700pF              |         |    |        |        |     |        |      |      |     |     |     |    |     |      |     |     |     |     |     |        |     |        |     |     |
| 6800pF              |         |    |        |        |     |        |      |      |     |     |     |    |     |      |     |     |     |     |     |        |     |        |     |     |
| 10000pF             |         |    |        |        |     |        |      |      |     |     |     |    |     |      |     |     |     |     |     |        |     |        |     |     |
| 15000pF             |         |    |        |        |     |        |      |      |     |     |     |    |     |      |     |     |     |     |     |        |     |        |     |     |
| 22000pF             |         |    |        |        |     |        |      |      |     |     |     |    |     |      |     |     |     |     |     |        |     |        |     |     |
| 33000pF             |         |    |        |        |     |        |      |      |     |     |     |    |     |      |     |     |     |     |     |        |     |        |     |     |
| 47000pF             |         |    |        |        |     |        |      |      |     |     |     |    |     |      |     |     |     |     |     |        |     |        |     |     |
| 68000pF             |         |    |        |        |     |        |      |      |     |     |     |    |     |      |     |     |     |     |     |        |     |        |     |     |
| 0.10μF              |         |    |        |        |     |        |      |      |     |     |     |    |     |      |     |     |     |     |     |        |     |        |     |     |
| 0.15μF              |         |    |        |        |     |        |      |      |     |     |     |    |     |      |     |     |     |     |     |        |     |        |     |     |
| 0.22μF              |         |    |        |        |     |        |      |      |     |     |     |    |     |      |     |     |     |     |     |        |     |        |     |     |
| 0.33μF              |         |    |        |        |     |        |      |      |     |     |     |    |     |      |     |     |     |     |     |        |     |        |     |     |
| 0.47μF              |         |    |        |        |     |        |      |      |     |     |     |    |     |      |     |     |     |     |     |        |     |        |     |     |
| 0.68μF              |         |    |        |        |     |        |      |      |     |     |     |    |     |      |     |     |     |     |     |        |     |        |     |     |
| 1.0μF               |         |    |        |        |     |        |      |      |     |     |     |    |     |      |     |     |     |     |     |        |     |        |     |     |
| 2.2μF               |         |    |        |        |     |        |      |      |     |     |     |    |     |      |     |     |     |     |     |        |     |        |     |     |
| 4.7μF               |         |    |        |        |     |        |      |      |     |     |     |    |     |      |     |     |     |     |     |        |     |        |     |     |
| 10μF                |         |    |        |        |     |        |      |      |     |     |     |    |     |      |     |     |     |     |     |        |     |        |     |     |
| 22μF                |         |    |        |        |     |        |      |      |     |     |     |    |     |      |     |     |     |     |     |        |     |        |     |     |
| 47μF                |         |    |        |        |     |        |      |      |     |     |     |    |     |      |     |     |     |     |     |        |     |        |     |     |
| 100μF               |         |    |        |        |     |        |      |      |     |     |     |    |     |      |     |     |     |     |     |        |     |        |     |     |
| 220μF               |         |    |        |        |     |        |      |      |     |     |     |    |     |      |     |     |     |     |     |        |     |        |     |     |



# Capacitance Table

p00

Each number in the Part Number List refers to the page number printed at the bottom of the page.

(→ ■ GRM Series High Dielectric Constant Type)

p00 ← Part Number List    JIS: R B    EIA: X7R X7S X7T X7U X6S X6T X5R

| LxW (mm)            | 3.2x1.6 |     |        |     |     |        |     |     |     |     |     |      |     |     |     | 3.2x2.5 |      |     |     |     |     |     |     |     |     |     |  |
|---------------------|---------|-----|--------|-----|-----|--------|-----|-----|-----|-----|-----|------|-----|-----|-----|---------|------|-----|-----|-----|-----|-----|-----|-----|-----|-----|--|
|                     | 1.8     |     |        |     |     | 1.9    |     |     |     |     | 1.5 |      |     |     | 1.8 |         | 2.0  |     | 2.2 |     |     |     |     |     |     |     |  |
| T max. (mm)         | 1.8     |     |        |     |     | 1.9    |     |     |     |     | 1.5 |      |     |     | 1.8 |         | 2.0  |     | 2.2 |     |     |     |     |     |     |     |  |
| Rated Voltage (Vdc) | 16      | 10  | 6.3    |     | 4   | 100    | 25  | 16  | 6.3 | 4   |     | 1000 | 630 | 250 | 200 | 100     | 1000 | 630 | 250 | 200 | 25  |     |     |     |     |     |  |
| Cap. / TC Code      | X5R, B  | X7R | X5R, B | X7Δ | X6S | X5R, B | X7U | X6S | X7R | X6S | X7S | X6T  | X5R | X7U | X6T | X5R     | X7R  | X7R | X7R | X7R | X7R | X7R | X7R | X7R | X7R | X7R |  |
| 100pF               |         |     |        |     |     |        |     |     |     |     |     |      |     |     |     |         |      |     |     |     |     |     |     |     |     |     |  |
| 150pF               |         |     |        |     |     |        |     |     |     |     |     |      |     |     |     |         |      |     |     |     |     |     |     |     |     |     |  |
| 220pF               |         |     |        |     |     |        |     |     |     |     |     |      |     |     |     |         |      |     |     |     |     |     |     |     |     |     |  |
| 330pF               |         |     |        |     |     |        |     |     |     |     |     |      |     |     |     |         |      |     |     |     |     |     |     |     |     |     |  |
| 470pF               |         |     |        |     |     |        |     |     |     |     |     |      |     |     |     |         |      |     |     |     |     |     |     |     |     |     |  |
| 680pF               |         |     |        |     |     |        |     |     |     |     |     |      |     |     |     |         |      |     |     |     |     |     |     |     |     |     |  |
| 820pF               |         |     |        |     |     |        |     |     |     |     |     |      |     |     |     |         |      |     |     |     |     |     |     |     |     |     |  |
| 1000pF              |         |     |        |     |     |        |     |     |     |     |     |      |     |     |     |         |      |     |     |     |     |     |     |     |     |     |  |
| 1500pF              |         |     |        |     |     |        |     |     |     |     |     |      |     |     |     |         |      |     |     |     |     |     |     |     |     |     |  |
| 2200pF              |         |     |        |     |     |        |     |     |     |     |     |      |     |     |     |         |      |     |     |     |     |     |     |     |     |     |  |
| 3300pF              |         |     |        |     |     |        |     |     |     |     |     |      |     |     |     |         |      |     |     |     |     |     |     |     |     |     |  |
| 4700pF              |         |     |        |     |     |        |     |     |     |     |     |      |     |     |     |         |      |     |     |     |     |     |     |     |     |     |  |
| 6800pF              |         |     |        |     |     |        |     |     |     |     |     |      |     |     |     |         |      |     |     |     |     |     |     |     |     |     |  |
| 10000pF             |         |     |        |     |     |        |     |     |     |     |     |      |     |     |     |         |      |     |     |     |     |     |     |     |     |     |  |
| 15000pF             |         |     |        |     |     |        |     |     |     |     |     |      |     |     |     |         |      |     |     |     |     |     |     |     |     |     |  |
| 22000pF             |         |     |        |     |     |        |     |     |     |     |     |      |     |     |     |         |      |     |     |     |     |     |     |     |     |     |  |
| 33000pF             |         |     |        |     |     |        |     |     |     |     |     |      |     |     |     |         |      |     |     |     |     |     |     |     |     |     |  |
| 47000pF             |         |     |        |     |     |        |     |     |     |     |     |      |     |     |     |         |      |     |     |     |     |     |     |     |     |     |  |
| 68000pF             |         |     |        |     |     |        |     |     |     |     |     |      |     |     |     |         |      |     |     |     |     |     |     |     |     |     |  |
| 0.10μF              |         |     |        |     |     |        |     |     |     |     |     |      |     |     |     |         |      |     |     |     |     |     |     |     |     |     |  |
| 0.15μF              |         |     |        |     |     |        |     |     |     |     |     |      |     |     |     |         |      |     |     |     |     |     |     |     |     |     |  |
| 0.22μF              |         |     |        |     |     |        |     |     |     |     |     |      |     |     |     |         |      |     |     |     |     |     |     |     |     |     |  |
| 0.33μF              |         |     |        |     |     |        |     |     |     |     |     |      |     |     |     |         |      |     |     |     |     |     |     |     |     |     |  |
| 0.47μF              |         |     |        |     |     |        |     |     |     |     |     |      |     |     |     |         |      |     |     |     |     |     |     |     |     |     |  |
| 0.68μF              |         |     |        |     |     |        |     |     |     |     |     |      |     |     |     |         |      |     |     |     |     |     |     |     |     |     |  |
| 1.0μF               |         |     |        |     |     |        |     |     |     |     |     |      |     |     |     |         |      |     |     |     |     |     |     |     |     |     |  |
| 2.2μF               |         |     |        |     |     |        |     |     |     |     |     |      |     |     |     |         |      |     |     |     |     |     |     |     |     |     |  |
| 4.7μF               |         |     |        |     |     |        |     |     |     |     |     |      |     |     |     |         |      |     |     |     |     |     |     |     |     |     |  |
| 10μF                |         |     |        |     |     |        |     |     |     |     |     |      |     |     |     |         |      |     |     |     |     |     |     |     |     |     |  |
| 22μF                |         |     |        |     |     |        |     |     |     |     |     |      |     |     |     |         |      |     |     |     |     |     |     |     |     |     |  |
| 47μF                |         |     |        |     |     |        |     |     |     |     |     |      |     |     |     |         |      |     |     |     |     |     |     |     |     |     |  |
| 100μF               |         |     |        |     |     |        |     |     |     |     |     |      |     |     |     |         |      |     |     |     |     |     |     |     |     |     |  |
| 220μF               |         |     |        |     |     |        |     |     |     |     |     |      |     |     |     |         |      |     |     |     |     |     |     |     |     |     |  |



# Capacitance Table p00 Each number in the Part Number List refers to the page number printed at the bottom of the page.

(→ ■ GRM Series High Dielectric Constant Type)

p00 ← Part Number List    JIS: R B    EIA: X7R X7S X7T X7U X6S X6T X5R

| LxW (mm)            | 3.2x2.5 |     |     |     |        |     |        |     |        |     | 4.5x3.2 |        |     |        |     |        | 5.7x5.0 |     |      |     |     |     |      |     |
|---------------------|---------|-----|-----|-----|--------|-----|--------|-----|--------|-----|---------|--------|-----|--------|-----|--------|---------|-----|------|-----|-----|-----|------|-----|
| T max. (mm)         | 2.7     |     |     |     |        |     |        |     |        |     | 1.5     |        |     | 2.0    |     |        | 2.0     |     |      |     |     |     |      |     |
| Rated Voltage (Vdc) | 100     | 80  | 63  | 50  |        | 35  |        | 25  |        | 16  |         | 10     |     | 6.3    | 4   | 630    | 250     | 200 | 1000 | 630 | 250 | 200 | 1000 | 630 |
| Cap. / TC Code      | X7R     | X7R | X7R | X7R | X5R, B | X7R | X5R, B | X7R | X5R, B | X7R | X6S     | X5R, B | X7R | X5R, B | X7Δ | X5R, B | X7U     | X7R | X7R  | X7R | X7R | X7R | X7R  | X7R |
| 100pF               |         |     |     |     |        |     |        |     |        |     |         |        |     |        |     |        |         |     |      |     |     |     |      |     |
| 150pF               |         |     |     |     |        |     |        |     |        |     |         |        |     |        |     |        |         |     |      |     |     |     |      |     |
| 220pF               |         |     |     |     |        |     |        |     |        |     |         |        |     |        |     |        |         |     |      |     |     |     |      |     |
| 330pF               |         |     |     |     |        |     |        |     |        |     |         |        |     |        |     |        |         |     |      |     |     |     |      |     |
| 470pF               |         |     |     |     |        |     |        |     |        |     |         |        |     |        |     |        |         |     |      |     |     |     |      |     |
| 680pF               |         |     |     |     |        |     |        |     |        |     |         |        |     |        |     |        |         |     |      |     |     |     |      |     |
| 820pF               |         |     |     |     |        |     |        |     |        |     |         |        |     |        |     |        |         |     |      |     |     |     |      |     |
| 1000pF              |         |     |     |     |        |     |        |     |        |     |         |        |     |        |     |        |         |     |      |     |     |     |      |     |
| 1500pF              |         |     |     |     |        |     |        |     |        |     |         |        |     |        |     |        |         |     |      |     |     |     |      |     |
| 2200pF              |         |     |     |     |        |     |        |     |        |     |         |        |     |        |     |        |         |     |      |     |     |     |      |     |
| 3300pF              |         |     |     |     |        |     |        |     |        |     |         |        |     |        |     |        |         |     |      |     |     |     |      |     |
| 4700pF              |         |     |     |     |        |     |        |     |        |     |         |        |     |        |     |        |         |     |      |     |     |     |      |     |
| 6800pF              |         |     |     |     |        |     |        |     |        |     |         |        |     |        |     |        |         |     |      |     |     |     |      |     |
| 10000pF             |         |     |     |     |        |     |        |     |        |     |         |        |     |        |     |        |         |     |      |     |     |     |      |     |
| 15000pF             |         |     |     |     |        |     |        |     |        |     |         |        |     |        |     |        |         |     |      |     |     |     |      |     |
| 22000pF             |         |     |     |     |        |     |        |     |        |     |         |        |     |        |     |        |         |     |      |     |     |     |      |     |
| 33000pF             |         |     |     |     |        |     |        |     |        |     |         |        |     |        |     |        |         |     |      |     |     |     |      |     |
| 47000pF             |         |     |     |     |        |     |        |     |        |     |         |        |     |        |     |        |         |     |      |     |     |     |      |     |
| 68000pF             |         |     |     |     |        |     |        |     |        |     |         |        |     |        |     |        |         |     |      |     |     |     |      |     |
| 0.10μF              |         |     |     |     |        |     |        |     |        |     |         |        |     |        |     |        |         |     |      |     |     |     |      |     |
| 0.15μF              |         |     |     |     |        |     |        |     |        |     |         |        |     |        |     |        |         |     |      |     |     |     |      |     |
| 0.22μF              |         |     |     |     |        |     |        |     |        |     |         |        |     |        |     |        |         |     |      |     |     |     |      |     |
| 0.33μF              |         |     |     |     |        |     |        |     |        |     |         |        |     |        |     |        |         |     |      |     |     |     |      |     |
| 0.47μF              |         |     |     |     |        |     |        |     |        |     |         |        |     |        |     |        |         |     |      |     |     |     |      |     |
| 0.68μF              |         |     |     |     |        |     |        |     |        |     |         |        |     |        |     |        |         |     |      |     |     |     |      |     |
| 1.0μF               |         |     |     |     |        |     |        |     |        |     |         |        |     |        |     |        |         |     |      |     |     |     |      |     |
| 2.2μF               | p85     |     |     |     |        |     |        |     |        |     |         |        |     |        |     |        |         |     |      |     |     |     |      |     |
| 4.7μF               |         | p85 |     |     |        |     |        |     |        |     |         |        |     |        |     |        |         |     |      |     |     |     |      |     |
| 10μF                |         |     | p85 | p85 | p85    | p85 | p85    | p85 |        |     |         |        |     |        |     |        |         |     |      |     |     |     |      |     |
| 22μF                |         |     |     |     |        |     |        | p85 | p85    | p85 |         |        |     |        |     |        |         |     |      |     |     |     |      |     |
| 47μF                |         |     |     |     |        |     |        |     |        |     | p85     | p85    | p85 | p85    |     |        |         |     |      |     |     |     |      |     |
| 100μF               |         |     |     |     |        |     |        |     |        |     |         |        |     | p85    | p85 | p85    | p85     |     |      |     |     |     |      |     |
| 220μF               |         |     |     |     |        |     |        |     |        |     |         |        |     |        |     |        |         |     |      |     |     |     |      |     |



# Capacitance Table p00 Each number in the Part Number List refers to the page number printed at the bottom of the page.

(→ ■ GRM Series High Dielectric Constant Type)

p00 ← Part Number List    JIS: R B    EIA: X7R X7S X7T X7U X6S X6T X5R

| LxW (mm)            | 5.7x5.0 |     |
|---------------------|---------|-----|
| T max. (mm)         | 2.0     |     |
| Rated Voltage (Vdc) | 250     | 200 |
| Cap. / TC Code      | X7R     | X7R |
| 100pF               |         |     |
| 150pF               |         |     |
| 220pF               |         |     |
| 330pF               |         |     |
| 470pF               |         |     |
| 680pF               |         |     |
| 820pF               |         |     |
| 1000pF              |         |     |
| 1500pF              |         |     |
| 2200pF              |         |     |
| 3300pF              |         |     |
| 4700pF              |         |     |
| 6800pF              |         |     |
| 10000pF             |         |     |
| 15000pF             |         |     |
| 22000pF             |         |     |
| 33000pF             |         |     |
| 47000pF             |         |     |
| 68000pF             |         |     |
| 0.10μF              |         |     |
| 0.15μF              |         |     |
| 0.22μF              |         |     |
| 0.33μF              | p85     | p86 |
| 0.47μF              | p86     | p86 |
| 0.68μF              | p86     | p86 |
| 1.0μF               | p86     | p86 |
| 2.2μF               |         |     |
| 4.7μF               |         |     |
| 10μF                |         |     |
| 22μF                |         |     |
| 47μF                |         |     |
| 100μF               |         |     |
| 220μF               |         |     |



# Capacitance Table

p00

Each number in the Part Number List refers to the page number printed at the bottom of the page.

## ■ GJM Series Temperature Compensating Type

p00

← Part Number List

JIS:

CK

CJ

CH

EIA:

C0G

| LxW (mm)            | 0.4x0.2 |     | 0.6x0.3 |      | 1.0x0.5 |      |
|---------------------|---------|-----|---------|------|---------|------|
| T max. (mm)         | 0.22    |     | 0.33    |      | 0.55    |      |
| Rated Voltage (Vdc) | 25      |     | 25      |      | 50      |      |
| Cap. / TC Code      | C0G     | CΔ  | C0G     | CΔ   | C0G     | CΔ   |
| 0.10pF              |         |     |         |      | p101    | p104 |
| 0.20pF              | p88     | p91 | p94     | p97  | p101    | p104 |
| 1.0pF               | p88     | p91 | p94     | p98  | p101    | p105 |
| 2.0pF               | p88     | p91 | p95     | p98  | p101    | p105 |
| 3.0pF               | p88     | p91 | p95     | p98  | p102    | p105 |
| 4.0pF               | p89     | p92 | p95     | p98  | p102    | p105 |
| 5.0pF               | p89     | p92 | p95     | p99  | p102    | p106 |
| 6.0pF               | p89     | p92 | p96     | p99  | p102    | p106 |
| 7.0pF               | p90     | p93 | p96     | p99  | p103    | p106 |
| 8.0pF               | p90     | p93 | p96     | p100 | p103    | p107 |
| 9.0pF               | p90     | p94 | p97     | p100 | p104    | p107 |
| 10pF                | p91     | p94 | p97     | p101 | p104    | p107 |
| 11pF                | p91     | p94 | p97     | p101 | p104    | p107 |
| 12pF                | p91     | p94 | p97     | p101 | p104    | p108 |
| 13pF                | p91     | p94 | p97     | p101 | p104    | p108 |
| 15pF                | p91     | p94 | p97     | p101 | p104    | p108 |
| 16pF                | p91     | p94 | p97     | p101 | p104    | p108 |
| 18pF                | p91     | p94 | p97     | p101 | p104    | p108 |
| 20pF                | p91     | p94 | p97     | p101 | p104    | p108 |
| 22pF                | p91     | p94 | p97     | p101 | p104    | p108 |
| 24pF                |         |     | p97     | p101 | p104    | p108 |
| 27pF                |         |     | p97     | p101 | p104    | p108 |
| 30pF                |         |     | p97     | p101 | p104    | p108 |
| 33pF                |         |     | p97     | p101 | p104    | p108 |
| 36pF                |         |     |         |      | p104    | p108 |
| 39pF                |         |     |         |      | p104    | p108 |
| 43pF                |         |     |         |      | p104    | p108 |
| 47pF                |         |     |         |      | p104    | p108 |

The indication for every 0.1 pF has been omitted for less than 10 pF. Refer to the Part Number List for details.

# Capacitance Table

p00

Each number in the Part Number List refers to the page number printed at the bottom of the page.

## ■ GMA Series High Dielectric Constant Type

p00

← Part Number List

JIS:

R

B

EIA:

X7R

X5R

| LxW (mm)            | 0.38x0.38 |      |      | 0.5x0.5 |      |      |      |      |      | 0.8x0.8 |      |      |      |      |      |      |      |      |      |
|---------------------|-----------|------|------|---------|------|------|------|------|------|---------|------|------|------|------|------|------|------|------|------|
| T max. (mm)         | 0.35      |      |      | 0.4     |      |      |      |      |      | 0.6     |      |      |      |      |      |      |      |      |      |
| Rated Voltage (Vdc) | 10        |      |      | 100     | 25   |      | 10   |      |      | 6.3     |      | 100  | 25   |      | 10   |      |      | 6.3  |      |
| Cap. / TC Code      | X7R       | R    | B    | X7R     | X7R  | B    | X7R  | R    | B    | X5R     | B    | X7R  | X7R  | B    | X7R  | R    | B    | X5R  | B    |
| 100pF               |           |      |      | p110    |      |      |      |      |      |         |      |      |      |      |      |      |      |      |      |
| 150pF               |           |      |      | p110    |      |      |      |      |      |         |      |      |      |      |      |      |      |      |      |
| 220pF               |           |      |      | p110    |      |      |      |      |      |         |      |      |      |      |      |      |      |      |      |
| 330pF               |           |      |      | p110    |      |      |      |      |      |         |      |      |      |      |      |      |      |      |      |
| 470pF               |           |      |      | p110    |      |      |      |      |      |         |      |      |      |      |      |      |      |      |      |
| 680pF               |           |      |      | p110    |      |      |      |      |      |         |      |      |      |      |      |      |      |      |      |
| 1000pF              | p110      | p110 | p110 | p110    |      |      |      |      |      |         |      |      |      |      |      |      |      |      |      |
| 1500pF              | p110      | p110 | p110 |         | p110 | p110 |      |      |      |         |      | p110 |      |      |      |      |      |      |      |
| 1800pF              | p110      | p110 | p110 |         |      |      |      |      |      |         |      |      |      |      |      |      |      |      |      |
| 2200pF              |           |      |      |         | p110 | p110 |      |      |      |         |      | p110 |      |      |      |      |      |      |      |
| 3300pF              |           |      |      |         | p110 | p110 |      |      |      |         |      | p110 |      |      |      |      |      |      |      |
| 4700pF              |           |      |      |         | p110 | p110 |      |      |      |         |      | p110 |      |      |      |      |      |      |      |
| 6800pF              |           |      |      |         |      |      | p110 | p110 | p110 |         |      | p110 |      |      |      |      |      |      |      |
| 10000pF             | p110      | p110 |      |         |      |      | p110 | p110 | p110 |         |      |      | p110 | p110 |      |      |      |      |      |
| 15000pF             |           |      |      |         |      |      | p110 | p110 | p110 |         |      |      | p110 | p110 |      |      |      |      |      |
| 22000pF             |           |      |      |         |      |      | p110 | p110 | p110 |         |      |      | p110 | p110 |      |      |      |      |      |
| 33000pF             |           |      |      |         |      |      |      |      |      |         |      |      |      |      | p110 | p110 | p110 |      |      |
| 47000pF             |           |      |      |         |      |      |      |      |      |         |      |      |      |      | p110 | p110 | p110 |      |      |
| 68000pF             |           |      |      |         |      |      |      |      |      |         |      |      |      |      | p110 | p110 | p110 |      |      |
| 0.10μF              |           |      |      |         |      |      |      |      |      | p110    | p110 |      |      |      | p110 | p110 | p110 |      |      |
| 0.47μF              |           |      |      |         |      |      |      |      |      |         |      |      |      |      |      |      |      | p110 | p110 |

# Capacitance Table

p00

Each number in the Part Number List refers to the page number printed at the bottom of the page.

## ■ GMD Series High Dielectric Constant Type

p00

← Part Number List

JIS:

**R**

**B**

EIA:

**X7R**

**X5R**

| LxW (mm)            | 0.6x0.3 |      |      |      |      |      |      |      |      |      | 1.0x0.5 |      |      |      |      |      |      |      |      |      |      |      |  |
|---------------------|---------|------|------|------|------|------|------|------|------|------|---------|------|------|------|------|------|------|------|------|------|------|------|--|
|                     | 0.33    |      |      |      |      |      |      |      |      |      | 0.55    |      |      |      |      |      |      |      |      |      |      |      |  |
| T max. (mm)         | 0.33    |      |      |      |      |      |      |      |      |      | 0.55    |      |      |      |      |      |      |      |      |      |      |      |  |
| Rated Voltage (Vdc) | 25      |      |      | 16   |      |      | 10   |      |      | 6.3  |         | 50   |      |      | 25   |      |      | 16   |      |      | 10   |      |  |
| Cap. / TC Code      | X7R     | R    | B    | X7R  | R    | B    | X7R  | R    | B    | X5R  | B       | X7R  | R    | B    | X7R  | R    | B    | X7R  | R    | B    | X5R  | B    |  |
| 100pF               | p112    | p112 | p112 |      |      |      |      |      |      |      |         |      |      |      |      |      |      |      |      |      |      |      |  |
| 120pF               | p112    | p112 | p112 |      |      |      |      |      |      |      |         |      |      |      |      |      |      |      |      |      |      |      |  |
| 150pF               | p112    | p112 | p112 |      |      |      |      |      |      |      |         |      |      |      |      |      |      |      |      |      |      |      |  |
| 180pF               | p112    | p112 | p112 |      |      |      |      |      |      |      |         |      |      |      |      |      |      |      |      |      |      |      |  |
| 220pF               | p112    | p112 | p112 |      |      |      |      |      |      |      |         | p112 | p112 | p113 |      |      |      |      |      |      |      |      |  |
| 270pF               | p112    | p112 | p112 |      |      |      |      |      |      |      |         | p112 | p113 | p113 |      |      |      |      |      |      |      |      |  |
| 330pF               | p112    | p112 | p112 |      |      |      |      |      |      |      |         | p112 | p113 | p113 |      |      |      |      |      |      |      |      |  |
| 390pF               | p112    | p112 | p112 |      |      |      |      |      |      |      |         | p112 | p113 | p113 |      |      |      |      |      |      |      |      |  |
| 470pF               | p112    | p112 | p112 |      |      |      |      |      |      |      |         | p112 | p113 | p113 |      |      |      |      |      |      |      |      |  |
| 560pF               | p112    | p112 | p112 |      |      |      |      |      |      |      |         | p112 | p113 | p113 |      |      |      |      |      |      |      |      |  |
| 680pF               | p112    | p112 | p112 |      |      |      |      |      |      |      |         | p112 | p113 | p113 |      |      |      |      |      |      |      |      |  |
| 820pF               | p112    | p112 | p112 |      |      |      |      |      |      |      |         | p112 | p113 | p113 |      |      |      |      |      |      |      |      |  |
| 1000pF              | p112    | p112 | p112 |      |      |      |      |      |      |      |         | p112 | p113 | p113 |      |      |      |      |      |      |      |      |  |
| 1200pF              | p112    | p112 | p112 |      |      |      |      |      |      |      |         | p112 | p113 | p113 |      |      |      |      |      |      |      |      |  |
| 1500pF              | p112    | p112 | p112 |      |      |      |      |      |      |      |         | p112 | p113 | p113 |      |      |      |      |      |      |      |      |  |
| 1800pF              |         |      |      | p112 | p112 | p112 |      |      |      |      |         | p112 | p113 | p113 |      |      |      |      |      |      |      |      |  |
| 2200pF              |         |      |      | p112 | p112 | p112 |      |      |      |      |         | p112 | p113 | p113 |      |      |      |      |      |      |      |      |  |
| 2700pF              |         |      |      | p112 | p112 | p112 |      |      |      |      |         | p112 | p113 | p113 |      |      |      |      |      |      |      |      |  |
| 3300pF              |         |      |      | p112 | p112 | p112 |      |      |      |      |         | p112 | p113 | p113 |      |      |      |      |      |      |      |      |  |
| 3900pF              |         |      |      |      |      |      | p112 | p112 | p112 |      |         | p112 | p113 | p113 |      |      |      |      |      |      |      |      |  |
| 4700pF              |         |      |      |      |      |      | p112 | p112 | p112 |      |         | p112 | p113 | p113 |      |      |      |      |      |      |      |      |  |
| 5600pF              |         |      |      |      |      |      | p112 | p112 | p112 |      |         |      |      |      | p113 | p113 | p113 |      |      |      |      |      |  |
| 6800pF              |         |      |      |      |      |      | p112 | p112 | p112 |      |         |      |      |      | p113 | p113 | p113 |      |      |      |      |      |  |
| 8200pF              |         |      |      |      |      |      | p112 | p112 | p112 |      |         |      |      |      | p113 | p113 | p113 |      |      |      |      |      |  |
| 10000pF             |         |      |      |      |      |      | p112 | p112 | p112 |      |         |      |      |      | p113 | p113 | p113 |      |      |      |      |      |  |
| 12000pF             |         |      |      |      |      |      |      |      |      |      |         |      |      |      | p113 | p113 | p113 |      |      |      |      |      |  |
| 15000pF             |         |      |      |      |      |      |      |      |      |      |         |      |      |      | p113 | p113 | p113 |      |      |      |      |      |  |
| 18000pF             |         |      |      |      |      |      |      |      |      |      |         |      |      |      | p113 | p113 | p113 |      |      |      |      |      |  |
| 22000pF             |         |      |      |      |      |      |      |      |      |      |         |      |      |      | p113 | p113 | p113 |      |      |      |      |      |  |
| 27000pF             |         |      |      |      |      |      |      |      |      |      |         |      |      |      | p113 | p113 | p113 |      |      |      |      |      |  |
| 33000pF             |         |      |      |      |      |      |      |      |      |      |         |      |      |      | p113 | p113 | p113 |      |      |      |      |      |  |
| 39000pF             |         |      |      |      |      |      |      |      |      |      |         |      |      |      | p113 | p113 | p113 |      |      |      |      |      |  |
| 47000pF             |         |      |      |      |      |      |      |      |      |      |         |      |      |      | p113 | p113 | p113 |      |      |      |      |      |  |
| 56000pF             |         |      |      |      |      |      |      |      |      | p112 | p112    |      |      |      |      |      |      | p113 | p113 | p113 |      |      |  |
| 68000pF             |         |      |      |      |      |      |      |      |      | p112 | p112    |      |      |      |      |      |      | p113 | p113 | p113 |      |      |  |
| 82000pF             |         |      |      |      |      |      |      |      |      | p112 | p112    |      |      |      |      |      |      | p113 | p113 | p113 |      |      |  |
| 0.10μF              |         |      |      |      |      |      |      |      |      | p112 | p112    |      |      |      |      |      |      | p113 | p113 | p113 |      |      |  |
| 0.12μF              |         |      |      |      |      |      |      |      |      |      |         |      |      |      |      |      |      |      |      |      | p113 | p113 |  |
| 0.15μF              |         |      |      |      |      |      |      |      |      |      |         |      |      |      |      |      |      |      |      |      | p113 | p113 |  |
| 0.18μF              |         |      |      |      |      |      |      |      |      |      |         |      |      |      |      |      |      |      |      |      | p113 | p113 |  |
| 0.22μF              |         |      |      |      |      |      |      |      |      |      |         |      |      |      |      |      |      |      |      |      | p113 | p113 |  |
| 0.27μF              |         |      |      |      |      |      |      |      |      |      |         |      |      |      |      |      |      |      |      |      | p113 | p113 |  |
| 0.33μF              |         |      |      |      |      |      |      |      |      |      |         |      |      |      |      |      |      |      |      |      | p113 | p113 |  |
| 0.39μF              |         |      |      |      |      |      |      |      |      |      |         |      |      |      |      |      |      |      |      |      | p113 | p113 |  |
| 0.47μF              |         |      |      |      |      |      |      |      |      |      |         |      |      |      |      |      |      |      |      |      | p113 | p113 |  |

# Capacitance Table

p00

Each number in the Part Number List refers to the page number printed at the bottom of the page.

## ■ GQM Series Temperature Compensating Type

p00

← Part Number List

JIS:

CK

CJ

CH

EIA:

C0G

| LxW (mm)            | 1.6x0.8 |      |      |      |      | 2.0x1.25 |      |      |      |      | 2.8x2.8 |
|---------------------|---------|------|------|------|------|----------|------|------|------|------|---------|
| T max. (mm)         | 0.8     | 0.9  |      |      |      | 0.95     |      |      |      | 1.0  | 1.35    |
| Rated Voltage (Vdc) | 250     | 100  | 50   |      |      | 100      | 50   |      | 250  | 500  |         |
| Cap. / TC Code      | C0G     | C0G  | CΔ   | C0G  | CH   | C0G      | CΔ   | C0G  | CH   | C0G  | C0G     |
| 1.0pF               | p115    | p115 | p116 |      |      | p117     | p118 |      |      | p120 | p121    |
| 2.0pF               | p115    | p116 | p116 |      |      | p118     | p118 |      |      | p120 | p121    |
| 3.0pF               | p115    | p116 | p116 |      |      | p118     | p118 |      |      | p120 | p121    |
| 4.0pF               | p115    | p116 | p116 |      |      | p118     | p118 |      |      | p120 | p121    |
| 5.0pF               | p115    | p116 | p116 |      |      | p118     | p118 |      |      | p120 | p121    |
| 6.0pF               | p115    | p116 | p116 |      |      | p118     | p119 |      |      | p120 | p121    |
| 7.0pF               | p115    |      |      | p116 | p117 | p118     | p119 |      |      | p120 | p121    |
| 8.0pF               | p115    |      |      | p116 | p117 | p118     | p119 |      |      | p120 | p121    |
| 9.0pF               | p115    |      |      | p116 | p117 | p118     | p119 |      |      | p120 | p121    |
| 10pF                | p115    |      |      | p116 | p117 | p118     | p119 |      |      | p120 | p121    |
| 11pF                | p115    |      |      | p116 | p117 | p118     | p119 |      |      | p120 | p121    |
| 12pF                | p115    |      |      | p116 | p117 | p118     | p119 |      |      | p120 | p121    |
| 13pF                | p115    |      |      | p116 | p117 | p118     | p119 |      |      | p120 | p121    |
| 15pF                | p115    |      |      | p116 | p117 | p118     | p119 |      |      | p120 | p121    |
| 16pF                | p115    |      |      | p116 | p117 | p118     | p119 |      |      | p120 | p121    |
| 18pF                | p115    |      |      | p117 | p117 | p118     | p119 |      |      | p120 | p121    |
| 20pF                | p115    |      |      | p117 | p117 |          |      | p119 | p119 | p120 | p121    |
| 22pF                | p115    |      |      | p117 | p117 |          |      | p119 | p119 | p120 | p121    |
| 24pF                | p115    |      |      | p117 | p117 |          |      | p119 | p119 | p120 | p121    |
| 27pF                | p115    |      |      | p117 | p117 |          |      | p119 | p119 | p120 | p121    |
| 30pF                | p115    |      |      | p117 | p117 |          |      | p119 | p119 | p120 | p121    |
| 33pF                | p115    |      |      | p117 | p117 |          |      | p119 | p119 | p120 | p121    |
| 36pF                | p115    |      |      | p117 | p117 |          |      | p119 | p119 | p120 | p121    |
| 39pF                | p115    |      |      | p117 | p117 |          |      | p119 | p119 | p120 | p121    |
| 43pF                | p115    |      |      | p117 | p117 |          |      | p119 | p119 | p120 | p121    |
| 47pF                | p115    |      |      | p117 | p117 |          |      | p119 | p119 | p120 | p121    |
| 51pF                |         |      |      | p117 | p117 |          |      | p119 | p119 | p120 | p121    |
| 56pF                |         |      |      | p117 | p117 |          |      | p119 | p119 | p120 | p121    |
| 62pF                |         |      |      | p117 | p117 |          |      | p119 | p119 | p120 | p121    |
| 68pF                |         |      |      | p117 | p117 |          |      | p119 | p119 | p120 | p122    |
| 75pF                |         |      |      | p117 | p117 |          |      | p119 | p119 | p120 | p122    |
| 82pF                |         |      |      | p117 | p117 |          |      | p119 | p119 | p120 | p122    |
| 91pF                |         |      |      | p117 | p117 |          |      | p119 | p119 | p120 | p122    |
| 100pF               |         |      |      | p117 | p117 |          |      | p119 | p119 | p121 | p122    |

The indication for every 0.1 pF has been omitted for less than 10 pF. Refer to the Part Number List for details.

# Capacitance Table p00 Each number in the Part Number List refers to the page number printed at the bottom of the page.

## ■ GRJ Series High Dielectric Constant Type

p00 ← Part Number List    EIA: X7R X7S

| LxW (mm)            | 2.0x1.25    |      | 3.2x1.6 |      |      |      |      |      | 3.2x2.5 |      |     |      |      |      |      |      |      |      |      |      |      |
|---------------------|-------------|------|---------|------|------|------|------|------|---------|------|-----|------|------|------|------|------|------|------|------|------|------|
|                     | T max. (mm) |      | 1.25    |      |      | 1.8  |      |      | 1.5     |      |     | 2.0  |      |      | 2.3  | 2.8  |      |      |      |      |      |
| Rated Voltage (Vdc) | 250         | 250  | 1000    | 630  | 250  | 1000 | 630  | 250  | 1000    | 630  | 250 | 1000 | 630  | 250  | 100  | 50   | 25   | 16   | 10   | 6.3  |      |
| Cap. / TC Code      | X7R         | X7R  | X7R     | X7R  | X7R  | X7R  | X7R  | X7R  | X7R     | X7R  | X7R | X7R  | X7R  | X7R  | X7R  | X7R  | X7S  | X7R  | X7R  | X7R  | X7R  |
| 470pF               |             |      | p124    |      |      |      |      |      |         |      |     |      |      |      |      |      |      |      |      |      |      |
| 680pF               |             |      | p124    |      |      |      |      |      |         |      |     |      |      |      |      |      |      |      |      |      |      |
| 1000pF              | p124        |      | p124    | p124 |      |      |      |      |         |      |     |      |      |      |      |      |      |      |      |      |      |
| 1500pF              | p124        |      | p124    | p124 |      |      |      |      |         |      |     |      |      |      |      |      |      |      |      |      |      |
| 2200pF              | p124        |      | p124    | p124 |      |      |      |      |         |      |     |      |      |      |      |      |      |      |      |      |      |
| 3300pF              | p124        |      | p124    | p124 |      |      |      |      |         |      |     |      |      |      |      |      |      |      |      |      |      |
| 4700pF              | p124        |      | p124    | p124 |      |      |      |      |         |      |     |      |      |      |      |      |      |      |      |      |      |
| 6800pF              | p124        |      |         | p124 |      | p124 |      |      | p124    |      |     |      |      |      |      |      |      |      |      |      |      |
| 10000pF             |             | p124 |         | p124 |      | p124 |      |      | p124    |      |     |      |      |      |      |      |      |      |      |      |      |
| 15000pF             |             | p124 |         |      | p124 |      | p124 |      |         |      |     | p124 |      |      |      |      |      |      |      |      |      |
| 22000pF             |             | p124 |         |      | p124 |      | p124 |      |         | p124 |     |      | p124 |      |      |      |      |      |      |      |      |
| 33000pF             |             |      |         |      |      |      |      | p124 |         |      |     |      |      | p124 |      |      |      |      |      |      |      |
| 47000pF             |             |      |         |      |      |      |      | p124 |         |      |     |      |      | p124 |      |      |      |      |      |      |      |
| 68000pF             |             |      |         |      | p124 |      |      |      |         | p124 |     |      |      |      |      |      |      |      |      |      |      |
| 0.10μF              |             |      |         |      |      |      |      | p124 |         |      |     |      |      |      | p124 |      |      |      |      |      |      |
| 0.15μF              |             |      |         |      |      |      |      |      |         | p124 |     |      |      |      |      |      |      |      |      |      |      |
| 0.22μF              |             |      |         |      |      |      |      |      |         |      |     |      |      | p124 |      |      |      |      |      |      |      |
| 0.33μF              |             |      |         |      |      |      |      |      |         |      |     |      |      |      |      |      |      |      |      |      |      |
| 0.47μF              |             |      |         |      |      |      |      |      |         |      |     |      |      |      |      |      |      |      |      |      |      |
| 0.68μF              |             |      |         |      |      |      |      |      |         |      |     |      |      |      |      |      |      |      |      |      |      |
| 1.0μF               |             |      |         |      |      |      |      |      |         |      |     |      |      |      |      |      |      |      |      |      |      |
| 2.2μF               |             |      |         |      |      |      |      |      |         |      |     |      |      |      | p124 |      |      |      |      |      |      |
| 4.7μF               |             |      |         |      |      |      |      |      |         |      |     |      |      |      |      | p124 |      |      |      |      |      |
| 10μF                |             |      |         |      |      |      |      |      |         |      |     |      |      |      |      |      | p124 | p124 |      |      |      |
| 22μF                |             |      |         |      |      |      |      |      |         |      |     |      |      |      |      |      |      |      | p124 | p124 |      |
| 47μF                |             |      |         |      |      |      |      |      |         |      |     |      |      |      |      |      |      |      |      |      | p124 |



| LxW (mm)            | 4.5x3.2     |      |      |      |      | 5.7x5.0 |      |      |
|---------------------|-------------|------|------|------|------|---------|------|------|
|                     | T max. (mm) |      | 2.0  |      |      | 2.0     |      |      |
| Rated Voltage (Vdc) | 630         | 250  | 1000 | 630  | 250  | 1000    | 630  | 250  |
| Cap. / TC Code      | X7R         | X7R  | X7R  | X7R  | X7R  | X7R     | X7R  | X7R  |
| 33000pF             |             |      | p124 |      |      |         |      |      |
| 47000pF             |             |      | p124 |      |      |         |      |      |
| 68000pF             | p124        |      |      |      |      | p124    |      |      |
| 0.10μF              |             |      |      | p124 |      | p124    |      |      |
| 0.15μF              |             | p124 |      |      |      |         | p124 |      |
| 0.22μF              |             |      |      |      | p124 |         | p124 |      |
| 0.33μF              |             |      |      |      |      | p124    |      | p124 |
| 0.47μF              |             |      |      |      |      | p124    |      | p124 |
| 0.68μF              |             |      |      |      |      |         |      | p124 |
| 1.0μF               |             |      |      |      |      |         |      | p124 |

# Capacitance Table

p00

Each number in the Part Number List refers to the page number printed at the bottom of the page.

## GR3 Series High Dielectric Constant Type

p00

← Part Number List

EIA:

X7T

| LxW (mm)            | 2.0x1.25 |      | 3.2x1.6 |      |      |      |      |      | 3.2x2.5 |      |      |     |      | 4.5x3.2 |      |     | 5.7x5.0 |      |     |      |      |     |      |     |      |      |
|---------------------|----------|------|---------|------|------|------|------|------|---------|------|------|-----|------|---------|------|-----|---------|------|-----|------|------|-----|------|-----|------|------|
|                     | 1.0      | 1.45 | 1.0     |      | 1.25 |      | 1.8  |      | 1.5     |      | 2.0  |     |      | 1.5     | 2.0  |     | 2.0     |      |     | 2.7  |      |     |      |     |      |      |
| T max. (mm)         | 250      | 250  | 450     | 250  | 630  | 450  | 250  | 630  | 450     | 250  | 630  | 250 | 630  | 450     | 250  | 250 | 630     | 450  | 250 | 630  | 450  | 250 | 630  | 450 | 250  |      |
| Rated Voltage (Vdc) | 250      | 250  | 450     | 250  | 630  | 450  | 250  | 630  | 450     | 250  | 630  | 250 | 630  | 450     | 250  | 250 | 630     | 450  | 250 | 630  | 450  | 250 | 630  | 450 | 250  |      |
| Cap. / TC Code      | X7T      | X7T  | X7T     | X7T  | X7T  | X7T  | X7T  | X7T  | X7T     | X7T  | X7T  | X7T | X7T  | X7T     | X7T  | X7T | X7T     | X7T  | X7T | X7T  | X7T  | X7T | X7T  | X7T | X7T  |      |
| 10000pF             | p126     |      | p126    |      | p126 |      |      |      |         |      |      |     |      |         |      |     |         |      |     |      |      |     |      |     |      |      |
| 15000pF             | p126     |      | p126    |      |      |      | p126 |      |         |      |      |     |      |         |      |     |         |      |     |      |      |     |      |     |      |      |
| 22000pF             |          | p126 |         |      |      | p126 |      |      |         | p126 |      |     |      |         |      |     |         |      |     |      |      |     |      |     |      |      |
| 33000pF             |          |      |         | p126 |      | p126 |      |      |         |      |      |     | p126 |         |      |     |         |      |     |      |      |     |      |     |      |      |
| 47000pF             |          |      |         |      |      | p126 |      | p126 |         |      |      |     | p126 |         |      |     |         |      |     |      |      |     |      |     |      |      |
| 68000pF             |          |      |         |      |      |      |      |      | p126    |      |      |     |      | p126    |      |     | p126    |      |     |      |      |     |      |     |      |      |
| 0.10μF              |          |      |         |      |      |      |      |      |         |      | p126 |     |      | p126    |      |     |         |      |     | p126 |      |     |      |     |      |      |
| 0.15μF              |          |      |         |      |      |      |      |      |         |      |      |     |      | p126    |      |     | p126    |      |     | p126 |      |     |      |     |      |      |
| 0.22μF              |          |      |         |      |      |      |      |      |         |      |      |     |      |         | p126 |     |         |      |     | p126 |      |     | p126 |     |      |      |
| 0.27μF              |          |      |         |      |      |      |      |      |         |      |      |     |      |         |      |     |         |      |     |      |      |     | p126 |     |      |      |
| 0.33μF              |          |      |         |      |      |      |      |      |         |      |      |     |      |         |      |     |         | p126 |     | p126 |      |     |      |     |      |      |
| 0.47μF              |          |      |         |      |      |      |      |      |         |      |      |     |      |         |      |     |         |      |     | p126 | p126 |     |      |     |      |      |
| 0.56μF              |          |      |         |      |      |      |      |      |         |      |      |     |      |         |      |     |         |      |     |      |      |     |      |     | p126 |      |
| 0.68μF              |          |      |         |      |      |      |      |      |         |      |      |     |      |         |      |     |         |      |     |      | p126 |     |      |     |      |      |
| 1.0μF               |          |      |         |      |      |      |      |      |         |      |      |     |      |         |      |     |         |      |     |      |      |     |      |     |      | p126 |

# Capacitance Table p00 Each number in the Part Number List refers to the page number printed at the bottom of the page.

## ■ KRM Series High Dielectric Constant Type

p00 ← Part Number List    EIA: X7R X6S X5R

| LxW (mm)            | 3.5x1.7 |      |      |      |      |      | 6.1x5.3 |      |      |      |      |      |      |      |      |      |      |     |      |      |      |      |
|---------------------|---------|------|------|------|------|------|---------|------|------|------|------|------|------|------|------|------|------|-----|------|------|------|------|
|                     | 2.0     |      | 2.9  |      |      |      | 2.9     | 2.9  | 3.0  |      |      |      |      |      | 3.9  |      |      |     |      | 5.0  |      |      |
| T max. (mm)         | 2.0     | 100  | 50   | 35   | 25   | 50   | 100     | 1000 | 630  | 250  | 100  | 63   | 50   | 35   | 25   | 100  | 63   | 50  | 35   | 25   | 1000 | 630  |
| Rated Voltage (Vdc) | 25      | 100  | 50   | 35   | 25   | 50   | 100     | 1000 | 630  | 250  | 100  | 63   | 50   | 35   | 25   | 100  | 63   | 50  | 35   | 25   | 1000 | 630  |
| Cap. / TC Code      | X5R     | X7R  | X7R  | X6S  | X6S  | X7R  | X7R     | X7R  | X7R  | X7R  | X7R  | X7R  | X7R  | X7R  | X7R  | X7R  | X7R  | X7R | X7R  | X7R  | X7R  | X7R  |
| 68000pF             |         |      |      |      |      |      |         | p129 |      |      |      |      |      |      |      |      |      |     |      |      |      |      |
| 0.10µF              |         |      |      |      |      |      |         | p129 |      |      |      |      |      |      |      |      |      |     |      |      |      |      |
| 0.15µF              |         |      |      |      |      |      |         |      | p129 |      |      |      |      |      |      |      |      |     |      |      |      | p129 |
| 0.22µF              |         |      |      |      |      |      |         |      | p129 |      |      |      |      |      |      |      |      |     |      |      |      | p129 |
| 0.33µF              |         |      |      |      |      |      |         |      |      |      |      |      |      |      |      |      |      |     |      |      |      | p129 |
| 0.47µF              |         |      |      |      |      |      |         |      |      |      |      |      |      |      |      |      |      |     |      |      |      | p129 |
| 0.68µF              |         |      |      |      |      |      |         |      |      | p129 |      |      |      |      |      |      |      |     |      |      |      |      |
| 1.0µF               |         | p129 |      |      |      |      |         |      |      | p129 |      |      |      |      |      |      |      |     |      |      |      |      |
| 1.5µF               |         |      |      |      |      |      |         |      |      |      |      |      |      |      |      |      |      |     |      |      |      |      |
| 2.2µF               |         |      |      |      |      | p129 | p129    |      |      |      |      |      |      |      |      |      |      |     |      |      |      |      |
| 4.7µF               |         |      | p129 |      |      |      |         |      |      |      | p129 | p129 | p129 |      |      |      |      |     |      |      |      |      |
| 6.8µF               |         |      |      |      |      |      |         |      |      |      |      |      |      |      |      | p129 |      |     |      |      |      |      |
| 10µF                | p129    |      |      | p129 | p129 |      |         |      |      |      |      |      | p129 | p129 |      |      | p129 |     |      |      |      |      |
| 15µF                |         |      |      |      |      |      |         |      |      |      |      |      |      | p129 | p129 |      |      |     |      |      |      |      |
| 17µF                |         |      |      |      |      |      |         |      |      |      |      |      |      |      |      |      |      |     | p129 | p129 |      |      |
| 22µF                |         |      |      |      |      |      |         |      |      |      |      |      |      |      |      |      |      |     |      | p129 | p129 |      |
| 33µF                |         |      |      |      |      |      |         |      |      |      |      |      |      |      |      |      |      |     |      |      | p129 |      |
| 47µF                |         |      |      |      |      |      |         |      |      |      |      |      |      |      |      |      |      |     |      |      |      |      |
| 68µF                |         |      |      |      |      |      |         |      |      |      |      |      |      |      |      |      |      |     |      |      |      |      |



| LxW (mm)            | 6.1x5.3 |      |      |      |      |      |      |      |      |      |
|---------------------|---------|------|------|------|------|------|------|------|------|------|
|                     | 5.0     |      |      |      |      | 6.7  |      |      |      |      |
| T max. (mm)         | 250     | 100  | 50   | 35   | 25   | 100  | 63   | 50   | 35   | 25   |
| Rated Voltage (Vdc) | 250     | 100  | 50   | 35   | 25   | 100  | 63   | 50   | 35   | 25   |
| Cap. / TC Code      | X7R     | X7R  | X7R  | X7R  | X7R  | X7R  | X7R  | X7R  | X7R  | X7R  |
| 68000pF             |         |      |      |      |      |      |      |      |      |      |
| 0.10µF              |         |      |      |      |      |      |      |      |      |      |
| 0.15µF              |         |      |      |      |      |      |      |      |      |      |
| 0.22µF              |         |      |      |      |      |      |      |      |      |      |
| 0.33µF              |         |      |      |      |      |      |      |      |      |      |
| 0.47µF              |         |      |      |      |      |      |      |      |      |      |
| 0.68µF              |         |      |      |      |      |      |      |      |      |      |
| 1.0µF               |         |      |      |      |      |      |      |      |      |      |
| 1.5µF               | p129    |      |      |      |      |      |      |      |      |      |
| 2.2µF               | p129    |      |      |      |      |      |      |      |      |      |
| 4.7µF               |         |      |      |      |      |      |      |      |      |      |
| 6.8µF               |         |      |      |      |      |      |      |      |      |      |
| 10µF                |         | p129 |      |      |      |      |      |      |      |      |
| 15µF                |         |      |      |      |      | p129 |      |      |      |      |
| 17µF                |         |      |      |      |      |      |      |      |      |      |
| 22µF                |         |      | p129 | p129 |      |      | p129 |      |      |      |
| 33µF                |         |      |      | p129 | p129 |      |      | p129 |      |      |
| 47µF                |         |      |      |      |      |      |      |      | p129 | p129 |
| 68µF                |         |      |      |      |      |      |      |      |      | p129 |

# Capacitance Table

p00

Each number in the Part Number List refers to the page number printed at the bottom of the page.

## ■ KR3 Series High Dielectric Constant Type

p00

← Part Number List

EIA:

X7T

| LxW (mm)            | 6.1x5.3 |      |      |      |      |      |      |      |      |      |      |
|---------------------|---------|------|------|------|------|------|------|------|------|------|------|
|                     | 3.0     |      |      | 3.9  |      |      | 5.0  |      | 6.7  |      |      |
| T max. (mm)         | 3.0     |      |      | 3.9  |      |      | 5.0  |      | 6.7  |      |      |
| Rated Voltage (Vdc) | 630     | 450  | 250  | 630  | 450  | 250  | 450  | 250  | 630  | 450  | 250  |
| Cap. / TC Code      | X7T     | X7T  | X7T  | X7T  | X7T  | X7T  | X7T  | X7T  | X7T  | X7T  | X7T  |
| 0.10μF              | p132    |      |      |      |      |      |      |      |      |      |      |
| 0.15μF              | p132    |      |      |      |      |      |      |      |      |      |      |
| 0.22μF              |         | p132 |      | p132 |      |      |      |      |      |      |      |
| 0.27μF              |         |      |      | p132 |      |      |      |      |      |      |      |
| 0.33μF              |         | p132 |      |      |      |      |      |      |      |      |      |
| 0.47μF              |         | p132 | p132 |      |      |      |      |      | p132 |      |      |
| 0.56μF              |         |      |      |      | p132 |      |      |      | p132 |      |      |
| 0.68μF              |         |      | p132 |      |      |      | p132 |      |      |      |      |
| 1.0μF               |         |      |      |      |      | p132 | p132 |      |      |      |      |
| 1.2μF               |         |      |      |      |      |      |      |      |      | p132 |      |
| 1.5μF               |         |      |      |      |      |      |      | p132 |      |      |      |
| 2.2μF               |         |      |      |      |      |      |      |      |      |      | p132 |

## ■ LLA Series High Dielectric Constant Type

p00

← Part Number List

EIA:

X7R

X7S

| LxW (mm)            | 1.6x0.8 | 2.0x1.25 |      |      |      |      |      |      |      |      | 3.2x1.6 |      |      |      |      |      |      |     |      |
|---------------------|---------|----------|------|------|------|------|------|------|------|------|---------|------|------|------|------|------|------|-----|------|
|                     | 0.55    | 0.55     |      |      |      |      | 0.95 |      |      |      | 0.55    |      |      | 0.95 |      | 1.25 |      |     |      |
| Rated Voltage (Vdc) | 4       | 25       | 16   | 10   | 6.3  | 4    | 25   | 16   | 10   | 6.3  | 4       | 16   | 10   | 6.3  | 16   | 10   | 16   | 10  |      |
| Cap. / TC Code      | X7S     | X7R      | X7R  | X7R  | X7R  | X7S  | X7R  | X7R  | X7R  | X7R  | X7S     | X7R  | X7R  | X7R  | X7R  | X7R  | X7R  | X7R | X7R  |
| 10000pF             |         | p134     |      |      |      |      | p134 |      |      |      |         |      |      |      |      |      |      |     |      |
| 22000pF             |         | p134     |      |      |      |      | p134 |      |      |      |         |      |      |      |      |      |      |     |      |
| 47000pF             |         |          | p134 |      |      |      | p134 |      |      |      |         |      |      |      |      |      |      |     |      |
| 0.10μF              | p134    |          | p134 |      |      |      |      | p134 |      |      |         |      |      |      |      |      |      |     |      |
| 0.22μF              | p134    |          |      | p134 |      |      |      | p134 |      |      |         | p134 |      |      |      |      |      |     |      |
| 0.47μF              | p134    |          |      |      | p134 |      |      |      | p134 |      |         |      | p134 |      | p134 |      |      |     |      |
| 1.0μF               |         |          |      |      |      | p134 |      |      |      | p134 |         |      |      | p134 |      | p134 | p134 |     |      |
| 2.2μF               | p134    |          |      |      |      |      |      |      |      |      | p134    |      |      | p134 |      |      |      |     | p134 |
| 4.7μF               |         |          |      |      |      | p134 |      |      |      |      |         |      |      |      |      |      |      |     |      |



# Capacitance Table

p00

Each number in the Part Number List refers to the page number printed at the bottom of the page.

## LLL Series High Dielectric Constant Type

p00

← Part Number List

EIA:

X7R

X7S

X6S

X5R

| LxW (mm)            | 0.5x1.0 |      |      | 0.8x1.6 |      |      |      |      |      |      |     |     |     | 1.25x2.0 |      |      |      |      |      |     |     |      |      |
|---------------------|---------|------|------|---------|------|------|------|------|------|------|-----|-----|-----|----------|------|------|------|------|------|-----|-----|------|------|
| T max. (mm)         | 0.35    |      |      | 0.5     |      |      |      | 0.55 | 0.6  |      |     |     |     | 0.5      |      |      |      |      | 0.7  |     |     |      |      |
| Rated Voltage (Vdc) | 6.3     | 4    |      | 4       | 25   | 16   | 10   | 4    | 4    | 50   | 25  | 16  | 10  | 4        | 50   | 25   | 16   | 10   | 6.3  | 4   | 50  | 25   |      |
| Cap. / TC Code      | X6S     | X7S  | X6S  | X5R     | X7R  | X7R  | X7R  | X7S  | X7R  | X7R  | X7R | X7R | X7S | X7R      | X7R  | X7R  | X7R  | X7R  | X7R  | X7S | X7R | X7R  |      |
| 2200pF              |         |      |      |         |      |      |      |      |      | p136 |     |     |     |          |      |      |      |      |      |     |     | p136 |      |
| 4700pF              |         |      |      |         |      |      |      |      |      | p136 |     |     |     |          |      |      |      |      |      |     |     |      |      |
| 10000pF             |         |      |      |         | p136 |      |      |      |      |      |     |     |     |          | p136 |      |      |      |      |     |     |      | p136 |
| 22000pF             |         |      |      |         |      | p136 |      |      |      |      |     |     |     |          | p136 |      |      |      |      |     |     |      | p136 |
| 47000pF             |         |      |      |         |      |      | p136 |      |      |      |     |     |     |          |      | p136 |      |      |      |     |     |      | p136 |
| 0.10µF              | p136    |      |      |         |      |      |      | p136 |      |      |     |     |     |          |      |      | p136 |      |      |     |     |      | p136 |
| 0.22µF              | p136    |      |      |         |      |      |      |      | p136 |      |     |     |     |          |      |      |      | p136 |      |     |     |      | p136 |
| 0.47µF              |         | p136 |      |         |      |      |      |      |      |      |     |     |     |          |      |      |      |      | p136 |     |     |      |      |
| 1.0µF               |         |      | p136 |         |      |      |      |      |      |      |     |     |     |          |      |      |      |      |      |     |     |      | p136 |
| 2.2µF               |         |      |      |         |      |      |      |      | p136 |      |     |     |     |          |      |      |      |      |      |     |     |      |      |
| 4.3µF               |         |      |      |         |      |      |      |      |      |      |     |     |     |          |      |      |      |      |      |     |     |      |      |
| 4.7µF               |         |      |      |         |      |      |      |      |      |      |     |     |     |          |      |      |      |      |      |     |     |      |      |
| 10µF                |         |      |      |         |      |      |      |      |      |      |     |     |     |          |      |      |      |      |      |     |     |      |      |



| LxW (mm)            | 1.25x2.0 |      |      |      | 1.6x3.2 |      |      |      |     |      |      |      |      |     |      |     |      |     |      |
|---------------------|----------|------|------|------|---------|------|------|------|-----|------|------|------|------|-----|------|-----|------|-----|------|
| T max. (mm)         | 0.7      |      | 0.95 |      | 0.5     |      |      |      | 0.8 |      |      |      |      |     | 1.25 |     |      |     |      |
| Rated Voltage (Vdc) | 10       | 16   | 10   | 4    | 50      | 25   | 16   | 10   | 50  | 25   | 16   | 10   | 6.3  | 50  | 25   | 16  | 10   | 6.3 |      |
| Cap. / TC Code      | X7R      | X7R  | X7R  | X7S  | X7R     | X7R  | X7R  | X7R  | X7R | X7R  | X7R  | X7R  | X7R  | X7R | X7R  | X7R | X7R  | X7R | X5R  |
| 2200pF              |          |      |      |      |         |      |      |      |     |      |      |      |      |     |      |     |      |     |      |
| 4700pF              |          |      |      |      |         |      |      |      |     |      |      |      |      |     |      |     |      |     |      |
| 10000pF             |          |      |      |      | p136    |      |      |      |     | p136 |      |      |      |     |      |     |      |     |      |
| 22000pF             |          |      |      |      | p136    |      |      |      |     | p136 |      |      |      |     |      |     |      |     |      |
| 47000pF             |          |      |      |      |         | p136 |      |      |     | p136 |      |      |      |     |      |     |      |     |      |
| 0.10µF              |          |      |      |      |         | p136 |      |      |     | p136 |      |      |      |     |      |     | p136 |     |      |
| 0.22µF              | p136     | p136 |      |      |         |      | p136 |      |     |      | p136 |      |      |     |      |     | p136 |     |      |
| 0.47µF              |          |      | p136 |      |         |      |      | p136 |     |      |      | p136 |      |     |      |     | p136 |     |      |
| 1.0µF               |          |      |      | p136 |         |      |      |      |     |      |      | p136 |      |     |      |     | p136 |     |      |
| 2.2µF               |          |      |      |      | p136    |      |      |      |     |      |      |      | p136 |     |      |     | p136 |     |      |
| 4.3µF               |          |      |      |      |         |      |      |      |     |      |      |      |      |     |      |     |      |     |      |
| 4.7µF               |          |      |      |      |         |      |      |      |     |      |      |      |      |     |      |     |      |     | p136 |
| 10µF                |          |      |      |      |         |      |      |      |     |      |      |      |      |     |      |     |      |     | p136 |

## LLM Series High Dielectric Constant Type

p00

← Part Number List

EIA:

X7R

X7S

| LxW (mm)            | 2.0x1.25 |      | 3.2x1.6 |      |      |
|---------------------|----------|------|---------|------|------|
| T max. (mm)         | 0.55     |      | 0.55    |      |      |
| Rated Voltage (Vdc) | 6.3      | 4    | 16      | 10   | 6.3  |
| Cap. / TC Code      | X7R      | X7S  | X7R     | X7R  | X7R  |
| 0.10µF              |          |      | p138    |      |      |
| 0.22µF              | p138     |      | p138    |      |      |
| 0.47µF              | p138     |      |         | p138 |      |
| 1.0µF               |          | p138 |         |      |      |
| 2.2µF               |          |      |         |      | p138 |

## LLR Series High Dielectric Constant Type

p00

← Part Number List

EIA:

X7S

| LxW (mm)            | 0.8x1.6 |      |      |      |
|---------------------|---------|------|------|------|
| T max. (mm)         | 0.55    |      |      |      |
| Rated Voltage (Vdc) | 4       |      |      |      |
| TC Code             | X7S     |      |      |      |
| Cap. / ESR (mΩ)     | 100     | 220  | 470  | 1000 |
| 1.0µF               | p140    | p140 | p140 | p140 |

# Search Capacitors

Specifications and Test Methods, Package, Chart of Characteristic Data, please refer to the search web page.  
<http://www.murata.com/products/capacitor/>

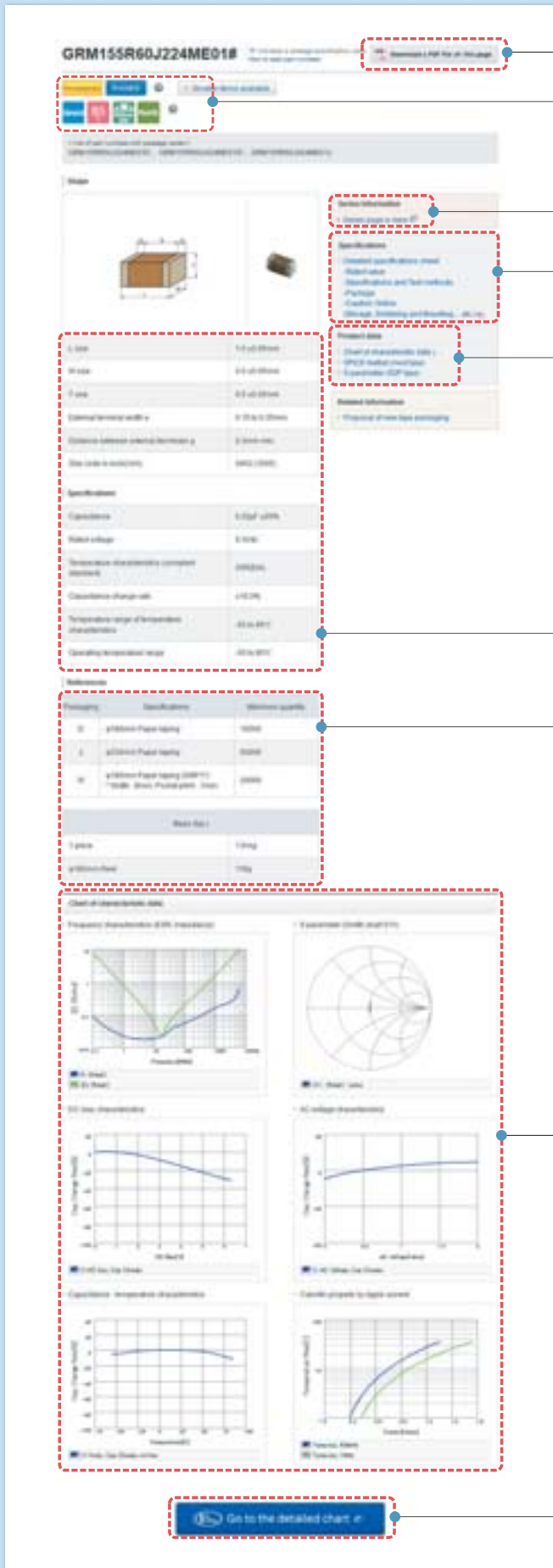

## Data Sheet

The product details page can be output in PDF.

## Status and Features Icons

The status and features of products can be checked at once. When ? is clicked, a description of each icon will be displayed.

## Characteristics & Applications

This links to the introduction page of each series.

## Detailed Specifications Sheet

- Rated value
- Specifications and Test Methods
- Package
- Caution, Notice (Storage, Soldering and Mounting, ....etc.)

## Characteristics Data

The following characteristics data of the main products can be acquired.

- SPICE Netlist (mod type)
- S parameter (S2P type)
- Reliability Test Data \*Typical data

- Shape (Dimensions)
- Rated Values

- Specification by Packaging Code/ Minimum Order Quantity
- Weight (1 pc/ø180mm reel)

## Chart of Characteristic Data

The main products published characteristic data.

- Frequency characteristics (ESR, Impedance)
- S parameter (Smith chart S11)
- DC bias characteristics
- AC voltage characteristics
- Capacitance - temperature characteristics
- Calorific property by ripple current

## Design Tools SimSurfing

The SimSurfing design tools are useful for displaying the graph, downloading CSV data and overwriting the product number graph.

For General Purpose

# GRM Series



This is Murata primary products renowned for both small size and large capacitance value with latest advanced technology.

## Features

### 1 Achieves large-capacity and small size in a multilayer structure.

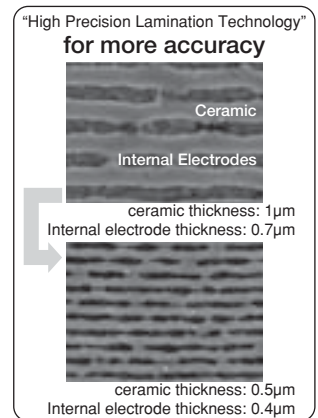
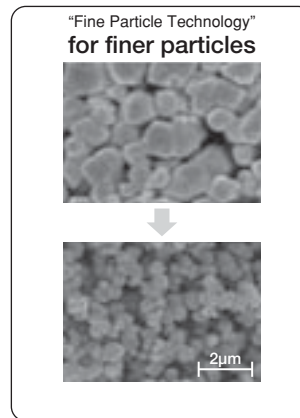
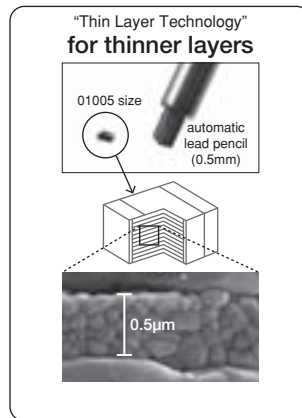
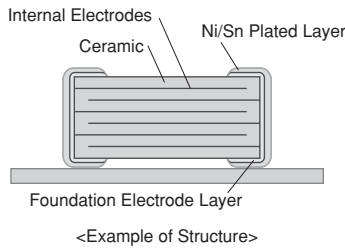

### 2 Sn plating is applied to the external electrodes; excellent solderability.

### 3 High reliability with no polarity.

|  | Ceramic Capacitor | Tantalum Capacitor | Aluminum Electrolytic Capacitor | Conductive Polymer Capacitor |
|--|-------------------|--------------------|---------------------------------|------------------------------|
| Price  | ○                 | ○                  | ◎                               | ○                            |
| Comparison between Impedance Frequency Characteristics | ◎                 | △                  | △                               | ○                            |
| Capacitance temperature characteristics                | ○                 | ◎                  | ○                               | ○                            |
| DC breakdown voltage                                   | ◎                 | △                  | △                               | △                            |
| Polarity   | No                | Yes                | Yes                             | Yes                          |
| Pulse response   | ◎                 | △                  | △                               | ○                            |
| Allowable ripple current                               | ◎                 | △                  | △                               | △                            |
| Reliability  | ◎                 | ○                  | ○                               | ○                            |
| DC bias characteristics                                | △                 | ◎                  | ◎                               | ◎                            |

◎: Particularly excellent ○: Excellent △: Inferior

## Specifications

|                   |  |
|-------------------|--|
| Size              | 0.4×0.2mm to 5.7×5.0mm   |
| Rated Voltage     | DC2.5V to 3.15kV   |
| Capacitance       | 0.1pF to 220µF   |
| Main Applications | 1. Rated voltage 100V Max.<br>High Dielectric Constant Type ··· For decoupling and smoothing circuits<br>Temperature Compensating Type ··· For tuning circuits, oscillating circuits, and high frequency filter circuits<br><br>2. Rated voltage 200V min.<br>High Dielectric Constant Type ··· For clamp snubber circuits and smoothing circuits<br>Temperature Compensating Type ··· Power supply damper snubber |

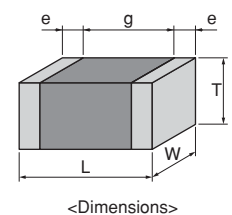

This catalog contains only a portion of the product lineup.  
 Please refer to the capacitor search tool on the Murata Web site for details.

# GRM Series Temperature Compensating Type Part Number List

■ 0.4x0.2mm **Ultra-compact**

| T max.  | Rated Voltage      | TC Code            | Cap.   | Tol.    | Part Number        |
|---------|--------------------|--------------------|--------|---------|--------------------|
| 0.22mm  | 16Vdc              | C0G                | 0.20pF | ±0.05pF | GRM0225C1CR20WA02# |
|         |                    |                    |        | ±0.1pF  | GRM0225C1CR20BA02# |
|         |                    |                    | 0.30pF | ±0.05pF | GRM0225C1CR30WA02# |
|         |                    |                    |        | ±0.1pF  | GRM0225C1CR30BA02# |
|         |                    |                    | 0.40pF | ±0.05pF | GRM0225C1CR40WA02# |
|         |                    |                    |        | ±0.1pF  | GRM0225C1CR40BA02# |
|         |                    |                    | 0.50pF | ±0.05pF | GRM0225C1CR50WA02# |
|         |                    |                    |        | ±0.1pF  | GRM0225C1CR50BA02# |
|         |                    |                    | 0.60pF | ±0.05pF | GRM0225C1CR60WA02# |
|         |                    |                    |        | ±0.1pF  | GRM0225C1CR60BA02# |
|         |                    |                    | 0.70pF | ±0.05pF | GRM0225C1CR70WA02# |
|         |                    |                    |        | ±0.1pF  | GRM0225C1CR70BA02# |
|         |                    |                    | 0.80pF | ±0.05pF | GRM0225C1CR80WA02# |
|         |                    |                    |        | ±0.1pF  | GRM0225C1CR80BA02# |
|         |                    |                    | 0.90pF | ±0.05pF | GRM0225C1CR90WA02# |
|         |                    |                    |        | ±0.1pF  | GRM0225C1CR90BA02# |
|         |                    |                    | 1.0pF  | ±0.05pF | GRM0225C1C1R0WA02# |
|         |                    |                    |        | ±0.1pF  | GRM0225C1C1R0BA02# |
|         |                    |                    |        | ±0.25pF | GRM0225C1C1R0CA02# |
|         |                    |                    | 1.1pF  | ±0.05pF | GRM0225C1C1R1WA02# |
|         |                    |                    |        | ±0.1pF  | GRM0225C1C1R1BA02# |
|         |                    |                    |        | ±0.25pF | GRM0225C1C1R1CA02# |
|         |                    |                    | 1.2pF  | ±0.05pF | GRM0225C1C1R2WA02# |
|         |                    |                    |        | ±0.1pF  | GRM0225C1C1R2BA02# |
|         |                    |                    |        | ±0.25pF | GRM0225C1C1R2CA02# |
|         |                    |                    | 1.3pF  | ±0.05pF | GRM0225C1C1R3WA02# |
|         |                    |                    |        | ±0.1pF  | GRM0225C1C1R3BA02# |
|         |                    |                    |        | ±0.25pF | GRM0225C1C1R3CA02# |
|         |                    |                    | 1.4pF  | ±0.05pF | GRM0225C1C1R4WA02# |
|         |                    |                    |        | ±0.1pF  | GRM0225C1C1R4BA02# |
|         |                    |                    |        | ±0.25pF | GRM0225C1C1R4CA02# |
|         |                    |                    | 1.5pF  | ±0.05pF | GRM0225C1C1R5WA02# |
|         |                    |                    |        | ±0.1pF  | GRM0225C1C1R5BA02# |
|         |                    |                    |        | ±0.25pF | GRM0225C1C1R5CA02# |
|         |                    |                    | 1.6pF  | ±0.05pF | GRM0225C1C1R6WA02# |
|         |                    |                    |        | ±0.1pF  | GRM0225C1C1R6BA02# |
|         |                    |                    |        | ±0.25pF | GRM0225C1C1R6CA02# |
|         |                    |                    | 1.7pF  | ±0.05pF | GRM0225C1C1R7WA02# |
|         |                    |                    |        | ±0.1pF  | GRM0225C1C1R7BA02# |
|         |                    |                    |        | ±0.25pF | GRM0225C1C1R7CA02# |
|         |                    |                    | 1.8pF  | ±0.05pF | GRM0225C1C1R8WA02# |
|         |                    |                    |        | ±0.1pF  | GRM0225C1C1R8BA02# |
|         |                    |                    |        | ±0.25pF | GRM0225C1C1R8CA02# |
|         |                    |                    | 1.9pF  | ±0.05pF | GRM0225C1C1R9WA02# |
|         |                    |                    |        | ±0.1pF  | GRM0225C1C1R9BA02# |
|         |                    |                    |        | ±0.25pF | GRM0225C1C1R9CA02# |
|         |                    |                    | 2.0pF  | ±0.05pF | GRM0225C1C2R0WA02# |
|         |                    |                    |        | ±0.1pF  | GRM0225C1C2R0BA02# |
| ±0.25pF | GRM0225C1C2R0CA02# |                    |        |         |                    |
| 2.1pF   | ±0.05pF            | GRM0225C1C2R1WA02# |        |         |                    |
|         | ±0.1pF             | GRM0225C1C2R1BA02# |        |         |                    |
|         | ±0.25pF            | GRM0225C1C2R1CA02# |        |         |                    |

| T max. | Rated Voltage | TC Code            | Cap.  | Tol.    | Part Number        |
|--------|---------------|--------------------|-------|---------|--------------------|
| 0.22mm | 16Vdc         | C0G                | 2.2pF | ±0.05pF | GRM0225C1C2R2WA02# |
|        |               |                    |       | ±0.1pF  | GRM0225C1C2R2BA02# |
|        |               |                    |       | ±0.25pF | GRM0225C1C2R2CA02# |
|        |               |                    | 2.3pF | ±0.05pF | GRM0225C1C2R3WA02# |
|        |               |                    |       | ±0.1pF  | GRM0225C1C2R3BA02# |
|        |               |                    |       | ±0.25pF | GRM0225C1C2R3CA02# |
|        |               |                    | 2.4pF | ±0.05pF | GRM0225C1C2R4WA02# |
|        |               |                    |       | ±0.1pF  | GRM0225C1C2R4BA02# |
|        |               |                    |       | ±0.25pF | GRM0225C1C2R4CA02# |
|        |               |                    | 2.5pF | ±0.05pF | GRM0225C1C2R5WA02# |
|        |               |                    |       | ±0.1pF  | GRM0225C1C2R5BA02# |
|        |               |                    |       | ±0.25pF | GRM0225C1C2R5CA02# |
|        |               |                    | 2.6pF | ±0.05pF | GRM0225C1C2R6WA02# |
|        |               |                    |       | ±0.1pF  | GRM0225C1C2R6BA02# |
|        |               |                    |       | ±0.25pF | GRM0225C1C2R6CA02# |
|        |               |                    | 2.7pF | ±0.05pF | GRM0225C1C2R7WA02# |
|        |               |                    |       | ±0.1pF  | GRM0225C1C2R7BA02# |
|        |               |                    |       | ±0.25pF | GRM0225C1C2R7CA02# |
|        |               |                    | 2.8pF | ±0.05pF | GRM0225C1C2R8WA02# |
|        |               |                    |       | ±0.1pF  | GRM0225C1C2R8BA02# |
|        |               |                    |       | ±0.25pF | GRM0225C1C2R8CA02# |
|        |               |                    | 2.9pF | ±0.05pF | GRM0225C1C2R9WA02# |
|        |               |                    |       | ±0.1pF  | GRM0225C1C2R9BA02# |
|        |               |                    |       | ±0.25pF | GRM0225C1C2R9CA02# |
|        |               |                    | 3.0pF | ±0.05pF | GRM0225C1C3R0WA02# |
|        |               |                    |       | ±0.1pF  | GRM0225C1C3R0BA02# |
|        |               |                    |       | ±0.25pF | GRM0225C1C3R0CA02# |
|        |               |                    | 3.1pF | ±0.05pF | GRM0225C1C3R1WA02# |
|        |               |                    |       | ±0.1pF  | GRM0225C1C3R1BA02# |
|        |               |                    |       | ±0.25pF | GRM0225C1C3R1CA02# |
|        |               |                    | 3.2pF | ±0.05pF | GRM0225C1C3R2WA02# |
|        |               |                    |       | ±0.1pF  | GRM0225C1C3R2BA02# |
|        |               |                    |       | ±0.25pF | GRM0225C1C3R2CA02# |
|        |               |                    | 3.3pF | ±0.05pF | GRM0225C1C3R3WA02# |
|        |               |                    |       | ±0.1pF  | GRM0225C1C3R3BA02# |
|        |               |                    |       | ±0.25pF | GRM0225C1C3R3CA02# |
| 3.4pF  | ±0.05pF       | GRM0225C1C3R4WA02# |       |         |                    |
|        | ±0.1pF        | GRM0225C1C3R4BA02# |       |         |                    |
|        | ±0.25pF       | GRM0225C1C3R4CA02# |       |         |                    |
| 3.5pF  | ±0.05pF       | GRM0225C1C3R5WA02# |       |         |                    |
|        | ±0.1pF        | GRM0225C1C3R5BA02# |       |         |                    |
|        | ±0.25pF       | GRM0225C1C3R5CA02# |       |         |                    |
| 3.6pF  | ±0.05pF       | GRM0225C1C3R6WA02# |       |         |                    |
|        | ±0.1pF        | GRM0225C1C3R6BA02# |       |         |                    |
|        | ±0.25pF       | GRM0225C1C3R6CA02# |       |         |                    |
| 3.7pF  | ±0.05pF       | GRM0225C1C3R7WA02# |       |         |                    |
|        | ±0.1pF        | GRM0225C1C3R7BA02# |       |         |                    |
|        | ±0.25pF       | GRM0225C1C3R7CA02# |       |         |                    |
| 3.8pF  | ±0.05pF       | GRM0225C1C3R8WA02# |       |         |                    |
|        | ±0.1pF        | GRM0225C1C3R8BA02# |       |         |                    |
|        | ±0.25pF       | GRM0225C1C3R8CA02# |       |         |                    |
| 3.9pF  | ±0.05pF       | GRM0225C1C3R9WA02# |       |         |                    |
|        | ±0.1pF        | GRM0225C1C3R9BA02# |       |         |                    |
|        | ±0.25pF       | GRM0225C1C3R9CA02# |       |         |                    |

Part number # indicates the package specification code.

## GRM Series Temperature Compensating Type Part Number List

(→ ■ 0.4x0.2mm)

| T max. | Rated Voltage | TC Code | Cap.  | Tol.    | Part Number        |
|--------|---------------|---------|-------|---------|--------------------|
| 0.22mm | 16Vdc         | C0G     | 4.0pF | ±0.05pF | GRM0225C1C4R0WA02# |
|        |               |         |       | ±0.1pF  | GRM0225C1C4R0BA02# |
|        |               |         |       | ±0.25pF | GRM0225C1C4R0CA02# |
|        |               |         | 4.1pF | ±0.05pF | GRM0225C1C4R1WA02# |
|        |               |         |       | ±0.1pF  | GRM0225C1C4R1BA02# |
|        |               |         |       | ±0.25pF | GRM0225C1C4R1CA02# |
|        |               |         | 4.2pF | ±0.05pF | GRM0225C1C4R2WA02# |
|        |               |         |       | ±0.1pF  | GRM0225C1C4R2BA02# |
|        |               |         |       | ±0.25pF | GRM0225C1C4R2CA02# |
|        |               |         | 4.3pF | ±0.05pF | GRM0225C1C4R3WA02# |
|        |               |         |       | ±0.1pF  | GRM0225C1C4R3BA02# |
|        |               |         |       | ±0.25pF | GRM0225C1C4R3CA02# |
|        |               |         | 4.4pF | ±0.05pF | GRM0225C1C4R4WA02# |
|        |               |         |       | ±0.1pF  | GRM0225C1C4R4BA02# |
|        |               |         |       | ±0.25pF | GRM0225C1C4R4CA02# |
|        |               |         | 4.5pF | ±0.05pF | GRM0225C1C4R5WA02# |
|        |               |         |       | ±0.1pF  | GRM0225C1C4R5BA02# |
|        |               |         |       | ±0.25pF | GRM0225C1C4R5CA02# |
|        |               |         | 4.6pF | ±0.05pF | GRM0225C1C4R6WA02# |
|        |               |         |       | ±0.1pF  | GRM0225C1C4R6BA02# |
|        |               |         |       | ±0.25pF | GRM0225C1C4R6CA02# |
|        |               |         | 4.7pF | ±0.05pF | GRM0225C1C4R7WA02# |
|        |               |         |       | ±0.1pF  | GRM0225C1C4R7BA02# |
|        |               |         |       | ±0.25pF | GRM0225C1C4R7CA02# |
|        |               |         | 4.8pF | ±0.05pF | GRM0225C1C4R8WA02# |
|        |               |         |       | ±0.1pF  | GRM0225C1C4R8BA02# |
|        |               |         |       | ±0.25pF | GRM0225C1C4R8CA02# |
|        |               |         | 4.9pF | ±0.05pF | GRM0225C1C4R9WA02# |
|        |               |         |       | ±0.1pF  | GRM0225C1C4R9BA02# |
|        |               |         |       | ±0.25pF | GRM0225C1C4R9CA02# |
|        |               |         | 5.0pF | ±0.05pF | GRM0225C1C5R0WA02# |
|        |               |         |       | ±0.1pF  | GRM0225C1C5R0BA02# |
|        |               |         |       | ±0.25pF | GRM0225C1C5R0CA02# |
|        |               |         | 5.1pF | ±0.05pF | GRM0225C1C5R1WA02# |
|        |               |         |       | ±0.1pF  | GRM0225C1C5R1BA02# |
|        |               |         |       | ±0.25pF | GRM0225C1C5R1CA02# |
|        |               |         |       | ±0.5pF  | GRM0225C1C5R1DA02# |
|        |               |         | 5.2pF | ±0.05pF | GRM0225C1C5R2WA02# |
|        |               |         |       | ±0.1pF  | GRM0225C1C5R2BA02# |
|        |               |         |       | ±0.25pF | GRM0225C1C5R2CA02# |
|        |               |         |       | ±0.5pF  | GRM0225C1C5R2DA02# |
|        |               |         | 5.3pF | ±0.05pF | GRM0225C1C5R3WA02# |
|        |               |         |       | ±0.1pF  | GRM0225C1C5R3BA02# |
|        |               |         |       | ±0.25pF | GRM0225C1C5R3CA02# |
|        |               |         |       | ±0.5pF  | GRM0225C1C5R3DA02# |
|        |               |         | 5.4pF | ±0.05pF | GRM0225C1C5R4WA02# |
|        |               |         |       | ±0.1pF  | GRM0225C1C5R4BA02# |
|        |               |         |       | ±0.25pF | GRM0225C1C5R4CA02# |
|        |               |         |       | ±0.5pF  | GRM0225C1C5R4DA02# |
|        |               |         | 5.5pF | ±0.05pF | GRM0225C1C5R5WA02# |
|        |               |         |       | ±0.1pF  | GRM0225C1C5R5BA02# |
|        |               |         |       | ±0.25pF | GRM0225C1C5R5CA02# |
|        |               |         |       | ±0.5pF  | GRM0225C1C5R5DA02# |
|        |               |         | 5.6pF | ±0.05pF | GRM0225C1C5R6WA02# |

| T max. | Rated Voltage | TC Code | Cap.  | Tol.    | Part Number        |
|--------|---------------|---------|-------|---------|--------------------|
| 0.22mm | 16Vdc         | C0G     | 5.6pF | ±0.1pF  | GRM0225C1C5R6BA02# |
|        |               |         |       | ±0.25pF | GRM0225C1C5R6CA02# |
|        |               |         |       | ±0.5pF  | GRM0225C1C5R6DA02# |
|        |               |         | 5.7pF | ±0.05pF | GRM0225C1C5R7WA02# |
|        |               |         |       | ±0.1pF  | GRM0225C1C5R7BA02# |
|        |               |         |       | ±0.25pF | GRM0225C1C5R7CA02# |
|        |               |         | 5.8pF | ±0.05pF | GRM0225C1C5R8WA02# |
|        |               |         |       | ±0.1pF  | GRM0225C1C5R8BA02# |
|        |               |         |       | ±0.25pF | GRM0225C1C5R8CA02# |
|        |               |         | 5.9pF | ±0.05pF | GRM0225C1C5R9WA02# |
|        |               |         |       | ±0.1pF  | GRM0225C1C5R9BA02# |
|        |               |         |       | ±0.25pF | GRM0225C1C5R9CA02# |
|        |               |         | 6.0pF | ±0.05pF | GRM0225C1C6R0WA02# |
|        |               |         |       | ±0.1pF  | GRM0225C1C6R0BA02# |
|        |               |         |       | ±0.25pF | GRM0225C1C6R0CA02# |
|        |               |         | 6.1pF | ±0.05pF | GRM0225C1C6R1WA02# |
|        |               |         |       | ±0.1pF  | GRM0225C1C6R1BA02# |
|        |               |         |       | ±0.25pF | GRM0225C1C6R1CA02# |
|        |               |         | 6.2pF | ±0.05pF | GRM0225C1C6R2WA02# |
|        |               |         |       | ±0.1pF  | GRM0225C1C6R2BA02# |
|        |               |         |       | ±0.25pF | GRM0225C1C6R2CA02# |
|        |               |         | 6.3pF | ±0.05pF | GRM0225C1C6R3WA02# |
|        |               |         |       | ±0.1pF  | GRM0225C1C6R3BA02# |
|        |               |         |       | ±0.25pF | GRM0225C1C6R3CA02# |
|        |               |         | 6.4pF | ±0.05pF | GRM0225C1C6R4WA02# |
|        |               |         |       | ±0.1pF  | GRM0225C1C6R4BA02# |
|        |               |         |       | ±0.25pF | GRM0225C1C6R4CA02# |
|        |               |         | 6.5pF | ±0.05pF | GRM0225C1C6R5WA02# |
|        |               |         |       | ±0.1pF  | GRM0225C1C6R5BA02# |
|        |               |         |       | ±0.25pF | GRM0225C1C6R5CA02# |
|        |               |         | 6.6pF | ±0.05pF | GRM0225C1C6R6WA02# |
|        |               |         |       | ±0.1pF  | GRM0225C1C6R6BA02# |
|        |               |         |       | ±0.25pF | GRM0225C1C6R6CA02# |
|        |               |         | 6.7pF | ±0.05pF | GRM0225C1C6R7WA02# |
|        |               |         |       | ±0.1pF  | GRM0225C1C6R7BA02# |
|        |               |         |       | ±0.25pF | GRM0225C1C6R7CA02# |
|        |               |         | 6.8pF | ±0.05pF | GRM0225C1C6R8WA02# |
|        |               |         |       | ±0.1pF  | GRM0225C1C6R8BA02# |
|        |               |         |       | ±0.25pF | GRM0225C1C6R8CA02# |
|        |               |         | 6.9pF | ±0.05pF | GRM0225C1C6R9WA02# |
|        |               |         |       | ±0.1pF  | GRM0225C1C6R9BA02# |
|        |               |         |       | ±0.25pF | GRM0225C1C6R9CA02# |

Part number # indicates the package specification code.

GRM Series  
GJM Series  
GMA Series  
GMD Series  
GQM Series  
GRJ Series  
GR3 Series  
KRM Series  
KR3 Series  
LLA Series  
LLL Series  
LLM Series  
LLR Series  
⚠Caution/ Notice

## GRM Series Temperature Compensating Type Part Number List

(→ ■ 0.4x0.2mm)

| T max. | Rated Voltage | TC Code | Cap.    | Tol.    | Part Number        |
|--------|---------------|---------|---------|---------|--------------------|
| 0.22mm | 16Vdc         | C0G     | 6.9pF   | ±0.5pF  | GRM0225C1C6R9DA02# |
|        |               |         |         | 7.0pF   | ±0.05pF            |
|        |               |         | ±0.1pF  |         | GRM0225C1C7R0BA02# |
|        |               |         | ±0.25pF |         | GRM0225C1C7R0CA02# |
|        |               |         | ±0.5pF  |         | GRM0225C1C7R0DA02# |
|        |               |         | 7.1pF   | ±0.05pF | GRM0225C1C7R1WA02# |
|        |               |         |         | ±0.1pF  | GRM0225C1C7R1BA02# |
|        |               |         |         | ±0.25pF | GRM0225C1C7R1CA02# |
|        |               |         | 7.2pF   | ±0.05pF | GRM0225C1C7R2WA02# |
|        |               |         |         | ±0.1pF  | GRM0225C1C7R2BA02# |
|        |               |         |         | ±0.25pF | GRM0225C1C7R2CA02# |
|        |               |         | 7.3pF   | ±0.05pF | GRM0225C1C7R3WA02# |
|        |               |         |         | ±0.1pF  | GRM0225C1C7R3BA02# |
|        |               |         |         | ±0.25pF | GRM0225C1C7R3CA02# |
|        |               |         | 7.4pF   | ±0.05pF | GRM0225C1C7R4WA02# |
|        |               |         |         | ±0.1pF  | GRM0225C1C7R4BA02# |
|        |               |         |         | ±0.25pF | GRM0225C1C7R4CA02# |
|        |               |         | 7.5pF   | ±0.05pF | GRM0225C1C7R5WA02# |
|        |               |         |         | ±0.1pF  | GRM0225C1C7R5BA02# |
|        |               |         |         | ±0.25pF | GRM0225C1C7R5CA02# |
|        |               |         | 7.6pF   | ±0.05pF | GRM0225C1C7R6WA02# |
|        |               |         |         | ±0.1pF  | GRM0225C1C7R6BA02# |
|        |               |         |         | ±0.25pF | GRM0225C1C7R6CA02# |
|        |               |         | 7.7pF   | ±0.05pF | GRM0225C1C7R7WA02# |
|        |               |         |         | ±0.1pF  | GRM0225C1C7R7BA02# |
|        |               |         |         | ±0.25pF | GRM0225C1C7R7CA02# |
|        |               |         | 7.8pF   | ±0.05pF | GRM0225C1C7R8WA02# |
|        |               |         |         | ±0.1pF  | GRM0225C1C7R8BA02# |
|        |               |         |         | ±0.25pF | GRM0225C1C7R8CA02# |
|        |               |         | 7.9pF   | ±0.05pF | GRM0225C1C7R9WA02# |
|        |               |         |         | ±0.1pF  | GRM0225C1C7R9BA02# |
|        |               |         |         | ±0.25pF | GRM0225C1C7R9CA02# |
|        |               |         | 8.0pF   | ±0.05pF | GRM0225C1C8R0WA02# |
|        |               |         |         | ±0.1pF  | GRM0225C1C8R0BA02# |
|        |               |         |         | ±0.25pF | GRM0225C1C8R0CA02# |
|        |               |         | 8.1pF   | ±0.05pF | GRM0225C1C8R1WA02# |
|        |               |         |         | ±0.1pF  | GRM0225C1C8R1BA02# |
|        |               |         |         | ±0.25pF | GRM0225C1C8R1CA02# |
|        |               |         | 8.2pF   | ±0.05pF | GRM0225C1C8R2WA02# |
|        |               |         |         | ±0.1pF  | GRM0225C1C8R2BA02# |
|        |               |         |         | ±0.25pF | GRM0225C1C8R2CA02# |
|        |               |         | 8.3pF   | ±0.05pF | GRM0225C1C8R3WA02# |
|        |               |         |         | ±0.1pF  | GRM0225C1C8R3BA02# |
|        |               |         |         | ±0.25pF | GRM0225C1C8R3CA02# |

| T max. | Rated Voltage | TC Code | Cap.  | Tol.    | Part Number        |
|--------|---------------|---------|-------|---------|--------------------|
| 0.22mm | 16Vdc         | C0G     | 8.3pF | ±0.1pF  | GRM0225C1C8R3BA02# |
|        |               |         |       | ±0.25pF | GRM0225C1C8R3CA02# |
|        |               |         |       | ±0.5pF  | GRM0225C1C8R3DA02# |
|        |               |         | 8.4pF | ±0.05pF | GRM0225C1C8R4WA02# |
|        |               |         |       | ±0.1pF  | GRM0225C1C8R4BA02# |
|        |               |         |       | ±0.25pF | GRM0225C1C8R4CA02# |
|        |               |         | 8.5pF | ±0.05pF | GRM0225C1C8R5WA02# |
|        |               |         |       | ±0.1pF  | GRM0225C1C8R5BA02# |
|        |               |         |       | ±0.25pF | GRM0225C1C8R5CA02# |
|        |               |         | 8.6pF | ±0.05pF | GRM0225C1C8R6WA02# |
|        |               |         |       | ±0.1pF  | GRM0225C1C8R6BA02# |
|        |               |         |       | ±0.25pF | GRM0225C1C8R6CA02# |
|        |               |         | 8.7pF | ±0.05pF | GRM0225C1C8R7WA02# |
|        |               |         |       | ±0.1pF  | GRM0225C1C8R7BA02# |
|        |               |         |       | ±0.25pF | GRM0225C1C8R7CA02# |
|        |               |         | 8.8pF | ±0.05pF | GRM0225C1C8R8WA02# |
|        |               |         |       | ±0.1pF  | GRM0225C1C8R8BA02# |
|        |               |         |       | ±0.25pF | GRM0225C1C8R8CA02# |
|        |               |         | 8.9pF | ±0.05pF | GRM0225C1C8R9WA02# |
|        |               |         |       | ±0.1pF  | GRM0225C1C8R9BA02# |
|        |               |         |       | ±0.25pF | GRM0225C1C8R9CA02# |
|        |               |         | 9.0pF | ±0.05pF | GRM0225C1C9R0WA02# |
|        |               |         |       | ±0.1pF  | GRM0225C1C9R0BA02# |
|        |               |         |       | ±0.25pF | GRM0225C1C9R0CA02# |
|        |               |         | 9.1pF | ±0.05pF | GRM0225C1C9R1WA02# |
|        |               |         |       | ±0.1pF  | GRM0225C1C9R1BA02# |
|        |               |         |       | ±0.25pF | GRM0225C1C9R1CA02# |
|        |               |         | 9.2pF | ±0.05pF | GRM0225C1C9R2WA02# |
|        |               |         |       | ±0.1pF  | GRM0225C1C9R2BA02# |
|        |               |         |       | ±0.25pF | GRM0225C1C9R2CA02# |
|        |               |         | 9.3pF | ±0.05pF | GRM0225C1C9R3WA02# |
|        |               |         |       | ±0.1pF  | GRM0225C1C9R3BA02# |
|        |               |         |       | ±0.25pF | GRM0225C1C9R3CA02# |
|        |               |         | 9.4pF | ±0.05pF | GRM0225C1C9R4WA02# |
|        |               |         |       | ±0.1pF  | GRM0225C1C9R4BA02# |
|        |               |         |       | ±0.25pF | GRM0225C1C9R4CA02# |
|        |               |         | 9.5pF | ±0.05pF | GRM0225C1C9R5WA02# |
|        |               |         |       | ±0.1pF  | GRM0225C1C9R5BA02# |
|        |               |         |       | ±0.25pF | GRM0225C1C9R5CA02# |
|        |               |         | 9.6pF | ±0.05pF | GRM0225C1C9R6WA02# |
|        |               |         |       | ±0.1pF  | GRM0225C1C9R6BA02# |
|        |               |         |       | ±0.25pF | GRM0225C1C9R6CA02# |

Part number # indicates the package specification code.

GRM Series  
 GJM Series  
 GMA Series  
 GMD Series  
 GQM Series  
 GRJ Series  
 GR3 Series  
 KRM Series  
 KR3 Series  
 LLA Series  
 LLL Series  
 LLM Series  
 LLR Series  
 ⚠Caution/  
 Notice

## GRM Series Temperature Compensating Type Part Number List

(→ ■ 0.4x0.2mm)

| T max. | Rated Voltage | TC Code | Cap.    | Tol.    | Part Number        |
|--------|---------------|---------|---------|---------|--------------------|
| 0.22mm | 16Vdc         | C0G     | 9.6pF   | ±0.5pF  | GRM0225C1C9R6DA02# |
|        |               |         |         | ±0.05pF | GRM0225C1C9R7WA02# |
|        |               |         | 9.7pF   | ±0.1pF  | GRM0225C1C9R7BA02# |
|        |               |         |         | ±0.25pF | GRM0225C1C9R7CA02# |
|        |               |         |         | ±0.5pF  | GRM0225C1C9R7DA02# |
|        |               |         |         | 9.8pF   | ±0.05pF            |
|        |               |         | ±0.1pF  |         | GRM0225C1C9R8BA02# |
|        |               |         | ±0.25pF |         | GRM0225C1C9R8CA02# |
|        |               |         | ±0.5pF  |         | GRM0225C1C9R8DA02# |
|        |               |         | 9.9pF   | ±0.05pF | GRM0225C1C9R9WA02# |
|        |               |         |         | ±0.1pF  | GRM0225C1C9R9BA02# |
|        |               |         |         | ±0.25pF | GRM0225C1C9R9CA02# |
|        |               |         |         | ±0.5pF  | GRM0225C1C9R9DA02# |
|        |               |         | 10pF    | ±2%     | GRM0225C1C100GA02# |
|        |               |         |         | ±5%     | GRM0225C1C100JA02# |
|        |               |         | 11pF    | ±2%     | GRM0225C1C110GA02# |
|        |               |         |         | ±5%     | GRM0225C1C110JA02# |
|        |               |         | 12pF    | ±2%     | GRM0225C1C120GA02# |
|        |               |         |         | ±5%     | GRM0225C1C120JA02# |
|        |               |         | 13pF    | ±2%     | GRM0225C1C130GA02# |
|        |               |         |         | ±5%     | GRM0225C1C130JA02# |
|        |               |         | 14pF    | ±2%     | GRM0225C1C140GA02# |
|        |               |         |         | ±5%     | GRM0225C1C140JA02# |
|        |               |         | 15pF    | ±2%     | GRM0225C1C150GA02# |
|        |               |         |         | ±5%     | GRM0225C1C150JA02# |
|        |               |         | 16pF    | ±2%     | GRM0225C1C160GA02# |
|        |               |         |         | ±5%     | GRM0225C1C160JA02# |
|        |               |         | 17pF    | ±5%     | GRM0225C1C170JA02# |
|        |               |         | 18pF    | ±2%     | GRM0225C1C180GA02# |
|        |               |         |         | ±5%     | GRM0225C1C180JA02# |
|        |               |         | 20pF    | ±2%     | GRM0225C1C200GA02# |
|        |               |         |         | ±5%     | GRM0225C1C200JA02# |
|        |               |         | 22pF    | ±2%     | GRM0225C1C220GA02# |
|        |               |         |         | ±5%     | GRM0225C1C220JA02# |
|        |               |         | 24pF    | ±2%     | GRM0225C1C240GA02# |
|        |               |         |         | ±5%     | GRM0225C1C240JA02# |
|        |               |         | 27pF    | ±2%     | GRM0225C1C270GA02# |
|        |               |         |         | ±5%     | GRM0225C1C270JA02# |
|        |               |         | 30pF    | ±2%     | GRM0225C1C300GA02# |
|        |               |         |         | ±5%     | GRM0225C1C300JA02# |
|        |               |         | 33pF    | ±2%     | GRM0225C1C330GA02# |
|        |               |         |         | ±5%     | GRM0225C1C330JA02# |
|        |               |         | 36pF    | ±2%     | GRM0225C1C360GA02# |
|        |               |         |         | ±5%     | GRM0225C1C360JA02# |
|        |               |         | 39pF    | ±2%     | GRM0225C1C390GA02# |
|        |               |         |         | ±5%     | GRM0225C1C390JA02# |
|        |               |         | 43pF    | ±2%     | GRM0225C1C430GA02# |
|        |               |         |         | ±5%     | GRM0225C1C430JA02# |
|        |               |         | 47pF    | ±2%     | GRM0225C1C470GA02# |
|        |               |         |         | ±5%     | GRM0225C1C470JA02# |
|        |               |         | 51pF    | ±2%     | GRM0225C1C510GA02# |
|        |               |         |         | ±5%     | GRM0225C1C510JA02# |
|        |               |         | 56pF    | ±2%     | GRM0225C1C560GA02# |
|        |               |         |         | ±5%     | GRM0225C1C560JA02# |

| T max. | Rated Voltage | TC Code | Cap.    | Tol.               | Part Number        |                    |
|--------|---------------|---------|---------|--------------------|--------------------|--------------------|
| 0.22mm | 16Vdc         | C0G     | 62pF    | ±2%                | GRM0225C1C620GA02# |                    |
|        |               |         |         | ±5%                | GRM0225C1C620JA02# |                    |
|        |               |         | 68pF    | ±2%                | GRM0225C1C680GA02# |                    |
|        |               |         |         | ±5%                | GRM0225C1C680JA02# |                    |
|        |               |         | 75pF    | ±2%                | GRM0225C1C750GA02# |                    |
|        |               |         |         | ±5%                | GRM0225C1C750JA02# |                    |
|        |               |         | 82pF    | ±2%                | GRM0225C1C820GA02# |                    |
|        |               |         |         | ±5%                | GRM0225C1C820JA02# |                    |
|        |               |         | 91pF    | ±2%                | GRM0225C1C910GA02# |                    |
|        |               |         |         | ±5%                | GRM0225C1C910JA02# |                    |
|        |               |         | 94pF    | ±5%                | GRM0225C1C940JA02# |                    |
|        |               |         | 96pF    | ±5%                | GRM0225C1C960JA02# |                    |
|        |               |         |         | 100pF              | ±2%                | GRM0225C1C101GA02# |
|        |               |         | ±5%     |                    | GRM0225C1C101JA02# |                    |
|        |               |         | CK      | 0.20pF             | ±0.05pF            | GRM0224C1CR20WA02# |
|        |               |         |         |                    | ±0.1pF             | GRM0224C1CR20BA02# |
|        |               |         |         | 0.30pF             | ±0.05pF            | GRM0224C1CR30WA02# |
|        |               |         |         |                    | ±0.1pF             | GRM0224C1CR30BA02# |
|        |               |         |         | 0.40pF             | ±0.05pF            | GRM0224C1CR40WA02# |
|        |               |         |         |                    | ±0.1pF             | GRM0224C1CR40BA02# |
|        |               |         |         | 0.50pF             | ±0.05pF            | GRM0224C1CR50WA02# |
|        |               |         |         |                    | ±0.1pF             | GRM0224C1CR50BA02# |
|        |               |         |         | 0.60pF             | ±0.05pF            | GRM0224C1CR60WA02# |
|        |               |         |         |                    | ±0.1pF             | GRM0224C1CR60BA02# |
|        |               |         |         | 0.70pF             | ±0.05pF            | GRM0224C1CR70WA02# |
|        |               |         |         |                    | ±0.1pF             | GRM0224C1CR70BA02# |
|        |               |         |         | 0.80pF             | ±0.05pF            | GRM0224C1CR80WA02# |
|        |               |         |         |                    | ±0.1pF             | GRM0224C1CR80BA02# |
|        |               | 0.90pF  |         | ±0.05pF            | GRM0224C1CR90WA02# |                    |
|        |               |         |         | ±0.1pF             | GRM0224C1CR90BA02# |                    |
|        |               | 1.0pF   |         | ±0.05pF            | GRM0224C1C1R0WA02# |                    |
|        |               |         |         | ±0.1pF             | GRM0224C1C1R0BA02# |                    |
|        |               |         |         | ±0.25pF            | GRM0224C1C1R0CA02# |                    |
|        |               | 1.1pF   |         | ±0.05pF            | GRM0224C1C1R1WA02# |                    |
|        |               |         |         | ±0.1pF             | GRM0224C1C1R1BA02# |                    |
|        |               |         |         | ±0.25pF            | GRM0224C1C1R1CA02# |                    |
|        |               | 1.2pF   |         | ±0.05pF            | GRM0224C1C1R2WA02# |                    |
|        |               |         |         | ±0.1pF             | GRM0224C1C1R2BA02# |                    |
|        |               |         |         | ±0.25pF            | GRM0224C1C1R2CA02# |                    |
|        |               | 1.3pF   |         | ±0.05pF            | GRM0224C1C1R3WA02# |                    |
|        |               |         |         | ±0.1pF             | GRM0224C1C1R3BA02# |                    |
|        |               |         |         | ±0.25pF            | GRM0224C1C1R3CA02# |                    |
|        |               | 1.4pF   | ±0.05pF | GRM0224C1C1R4WA02# |                    |                    |
|        |               |         | ±0.1pF  | GRM0224C1C1R4BA02# |                    |                    |
|        |               |         | ±0.25pF | GRM0224C1C1R4CA02# |                    |                    |
|        |               | 1.5pF   | ±0.05pF | GRM0224C1C1R5WA02# |                    |                    |
|        |               |         | ±0.1pF  | GRM0224C1C1R5BA02# |                    |                    |
|        |               |         | ±0.25pF | GRM0224C1C1R5CA02# |                    |                    |
|        |               | 1.6pF   | ±0.05pF | GRM0224C1C1R6WA02# |                    |                    |
|        |               |         | ±0.1pF  | GRM0224C1C1R6BA02# |                    |                    |
|        |               |         | ±0.25pF | GRM0224C1C1R6CA02# |                    |                    |
|        |               | 1.7pF   | ±0.05pF | GRM0224C1C1R7WA02# |                    |                    |
|        |               |         | ±0.1pF  | GRM0224C1C1R7BA02# |                    |                    |
|        |               |         | ±0.25pF | GRM0224C1C1R7CA02# |                    |                    |

Part number # indicates the package specification code.

GRM Series  
GJM Series  
GMA Series  
GMD Series  
GQM Series  
GRJ Series  
GR3 Series  
KRM Series  
KR3 Series  
LLA Series  
LLL Series  
LLM Series  
LLR Series  
⚠Caution/Notice

# GRM Series Temperature Compensating Type Part Number List

(→ ■ 0.4x0.2mm)

| T max. | Rated Voltage | TC Code | Cap.    | Tol.               | Part Number        |                    |
|--------|---------------|---------|---------|--------------------|--------------------|--------------------|
| 0.22mm | 16Vdc         | CK      | 1.8pF   | ±0.05pF            | GRM0224C1C1R8WA02# |                    |
|        |               |         |         | ±0.1pF             | GRM0224C1C1R8BA02# |                    |
|        |               |         |         | ±0.25pF            | GRM0224C1C1R8CA02# |                    |
|        |               |         | 1.9pF   | ±0.05pF            | GRM0224C1C1R9WA02# |                    |
|        |               |         |         | ±0.1pF             | GRM0224C1C1R9BA02# |                    |
|        |               |         |         | ±0.25pF            | GRM0224C1C1R9CA02# |                    |
|        |               |         | 2.0pF   | ±0.05pF            | GRM0224C1C2R0WA02# |                    |
|        |               |         |         | ±0.1pF             | GRM0224C1C2R0BA02# |                    |
|        |               |         |         | ±0.25pF            | GRM0224C1C2R0CA02# |                    |
|        |               |         | CJ      | 2.1pF              | ±0.05pF            | GRM0223C1C2R1WA02# |
|        |               |         |         |                    | ±0.1pF             | GRM0223C1C2R1BA02# |
|        |               |         |         |                    | ±0.25pF            | GRM0223C1C2R1CA02# |
|        |               |         |         | 2.2pF              | ±0.05pF            | GRM0223C1C2R2WA02# |
|        |               |         |         |                    | ±0.1pF             | GRM0223C1C2R2BA02# |
|        |               |         |         |                    | ±0.25pF            | GRM0223C1C2R2CA02# |
|        |               |         |         | 2.3pF              | ±0.05pF            | GRM0223C1C2R3WA02# |
|        |               |         |         |                    | ±0.1pF             | GRM0223C1C2R3BA02# |
|        |               |         |         |                    | ±0.25pF            | GRM0223C1C2R3CA02# |
|        |               | 2.4pF   | ±0.05pF | GRM0223C1C2R4WA02# |                    |                    |
|        |               |         | ±0.1pF  | GRM0223C1C2R4BA02# |                    |                    |
|        |               |         | ±0.25pF | GRM0223C1C2R4CA02# |                    |                    |
|        |               | 2.5pF   | ±0.05pF | GRM0223C1C2R5WA02# |                    |                    |
|        |               |         | ±0.1pF  | GRM0223C1C2R5BA02# |                    |                    |
|        |               |         | ±0.25pF | GRM0223C1C2R5CA02# |                    |                    |
|        |               | 2.6pF   | ±0.05pF | GRM0223C1C2R6WA02# |                    |                    |
|        |               |         | ±0.1pF  | GRM0223C1C2R6BA02# |                    |                    |
|        |               |         | ±0.25pF | GRM0223C1C2R6CA02# |                    |                    |
|        |               | 2.7pF   | ±0.05pF | GRM0223C1C2R7WA02# |                    |                    |
|        |               |         | ±0.1pF  | GRM0223C1C2R7BA02# |                    |                    |
|        |               |         | ±0.25pF | GRM0223C1C2R7CA02# |                    |                    |
|        |               | 2.8pF   | ±0.05pF | GRM0223C1C2R8WA02# |                    |                    |
|        |               |         | ±0.1pF  | GRM0223C1C2R8BA02# |                    |                    |
|        |               |         | ±0.25pF | GRM0223C1C2R8CA02# |                    |                    |
|        |               | 2.9pF   | ±0.05pF | GRM0223C1C2R9WA02# |                    |                    |
|        |               |         | ±0.1pF  | GRM0223C1C2R9BA02# |                    |                    |
|        |               |         | ±0.25pF | GRM0223C1C2R9CA02# |                    |                    |
|        |               | 3.0pF   | ±0.05pF | GRM0223C1C3R0WA02# |                    |                    |
|        |               |         | ±0.1pF  | GRM0223C1C3R0BA02# |                    |                    |
|        |               |         | ±0.25pF | GRM0223C1C3R0CA02# |                    |                    |
|        |               | 3.1pF   | ±0.05pF | GRM0223C1C3R1WA02# |                    |                    |
|        |               |         | ±0.1pF  | GRM0223C1C3R1BA02# |                    |                    |
|        |               |         | ±0.25pF | GRM0223C1C3R1CA02# |                    |                    |
|        |               | 3.2pF   | ±0.05pF | GRM0223C1C3R2WA02# |                    |                    |
|        |               |         | ±0.1pF  | GRM0223C1C3R2BA02# |                    |                    |
|        |               |         | ±0.25pF | GRM0223C1C3R2CA02# |                    |                    |
|        |               | 3.3pF   | ±0.05pF | GRM0223C1C3R3WA02# |                    |                    |
|        |               |         | ±0.1pF  | GRM0223C1C3R3BA02# |                    |                    |
|        |               |         | ±0.25pF | GRM0223C1C3R3CA02# |                    |                    |
|        |               | 3.4pF   | ±0.05pF | GRM0223C1C3R4WA02# |                    |                    |
|        |               |         | ±0.1pF  | GRM0223C1C3R4BA02# |                    |                    |
|        |               |         | ±0.25pF | GRM0223C1C3R4CA02# |                    |                    |
|        |               | 3.5pF   | ±0.05pF | GRM0223C1C3R5WA02# |                    |                    |
|        |               |         | ±0.1pF  | GRM0223C1C3R5BA02# |                    |                    |
|        |               |         | ±0.25pF | GRM0223C1C3R5CA02# |                    |                    |

| T max. | Rated Voltage | TC Code | Cap.    | Tol.               | Part Number        |                    |
|--------|---------------|---------|---------|--------------------|--------------------|--------------------|
| 0.22mm | 16Vdc         | CJ      | 3.6pF   | ±0.05pF            | GRM0223C1C3R6WA02# |                    |
|        |               |         |         | ±0.1pF             | GRM0223C1C3R6BA02# |                    |
|        |               |         |         | ±0.25pF            | GRM0223C1C3R6CA02# |                    |
|        |               |         | 3.7pF   | ±0.05pF            | GRM0223C1C3R7WA02# |                    |
|        |               |         |         | ±0.1pF             | GRM0223C1C3R7BA02# |                    |
|        |               |         |         | ±0.25pF            | GRM0223C1C3R7CA02# |                    |
|        |               |         | 3.8pF   | ±0.05pF            | GRM0223C1C3R8WA02# |                    |
|        |               |         |         | ±0.1pF             | GRM0223C1C3R8BA02# |                    |
|        |               |         |         | ±0.25pF            | GRM0223C1C3R8CA02# |                    |
|        |               |         | 3.9pF   | ±0.05pF            | GRM0223C1C3R9WA02# |                    |
|        |               |         |         | ±0.1pF             | GRM0223C1C3R9BA02# |                    |
|        |               |         |         | ±0.25pF            | GRM0223C1C3R9CA02# |                    |
|        |               |         | CH      | 0.20pF             | ±0.05pF            | GRM0222C1CR20WA02# |
|        |               |         |         |                    | ±0.1pF             | GRM0222C1CR20BA02# |
|        |               |         |         | 0.30pF             | ±0.05pF            | GRM0222C1CR30WA02# |
|        |               |         |         |                    | ±0.1pF             | GRM0222C1CR30BA02# |
|        |               |         |         | 0.40pF             | ±0.05pF            | GRM0222C1CR40WA02# |
|        |               |         |         |                    | ±0.1pF             | GRM0222C1CR40BA02# |
|        |               | 0.50pF  |         | ±0.05pF            | GRM0222C1CR50WA02# |                    |
|        |               |         |         | ±0.1pF             | GRM0222C1CR50BA02# |                    |
|        |               | 0.60pF  |         | ±0.05pF            | GRM0222C1CR60WA02# |                    |
|        |               |         |         | ±0.1pF             | GRM0222C1CR60BA02# |                    |
|        |               | 0.70pF  |         | ±0.05pF            | GRM0222C1CR70WA02# |                    |
|        |               |         |         | ±0.1pF             | GRM0222C1CR70BA02# |                    |
|        |               | 0.80pF  |         | ±0.05pF            | GRM0222C1CR80WA02# |                    |
|        |               |         |         | ±0.1pF             | GRM0222C1CR80BA02# |                    |
|        |               | 0.90pF  |         | ±0.05pF            | GRM0222C1CR90WA02# |                    |
|        |               |         |         | ±0.1pF             | GRM0222C1CR90BA02# |                    |
|        |               | 1.0pF   |         | ±0.05pF            | GRM0222C1C1R0WA02# |                    |
|        |               |         |         | ±0.1pF             | GRM0222C1C1R0BA02# |                    |
|        |               |         | ±0.25pF | GRM0222C1C1R0CA02# |                    |                    |
|        |               | 1.1pF   | ±0.05pF | GRM0222C1C1R1WA02# |                    |                    |
|        |               |         | ±0.1pF  | GRM0222C1C1R1BA02# |                    |                    |
|        |               |         | ±0.25pF | GRM0222C1C1R1CA02# |                    |                    |
|        |               | 1.2pF   | ±0.05pF | GRM0222C1C1R2WA02# |                    |                    |
|        |               |         | ±0.1pF  | GRM0222C1C1R2BA02# |                    |                    |
|        |               |         | ±0.25pF | GRM0222C1C1R2CA02# |                    |                    |
|        |               | 1.3pF   | ±0.05pF | GRM0222C1C1R3WA02# |                    |                    |
|        |               |         | ±0.1pF  | GRM0222C1C1R3BA02# |                    |                    |
|        |               |         | ±0.25pF | GRM0222C1C1R3CA02# |                    |                    |
|        |               | 1.4pF   | ±0.05pF | GRM0222C1C1R4WA02# |                    |                    |
|        |               |         | ±0.1pF  | GRM0222C1C1R4BA02# |                    |                    |
|        |               |         | ±0.25pF | GRM0222C1C1R4CA02# |                    |                    |
|        |               | 1.5pF   | ±0.05pF | GRM0222C1C1R5WA02# |                    |                    |
|        |               |         | ±0.1pF  | GRM0222C1C1R5BA02# |                    |                    |
|        |               |         | ±0.25pF | GRM0222C1C1R5CA02# |                    |                    |
|        |               | 1.6pF   | ±0.05pF | GRM0222C1C1R6WA02# |                    |                    |
|        |               |         | ±0.1pF  | GRM0222C1C1R6BA02# |                    |                    |
|        |               |         | ±0.25pF | GRM0222C1C1R6CA02# |                    |                    |
|        |               | 1.7pF   | ±0.05pF | GRM0222C1C1R7WA02# |                    |                    |
|        |               |         | ±0.1pF  | GRM0222C1C1R7BA02# |                    |                    |
|        |               |         | ±0.25pF | GRM0222C1C1R7CA02# |                    |                    |
|        |               | 1.8pF   | ±0.05pF | GRM0222C1C1R8WA02# |                    |                    |
|        |               |         | ±0.1pF  | GRM0222C1C1R8BA02# |                    |                    |

Part number # indicates the package specification code.



## GRM Series Temperature Compensating Type Part Number List

(→ ■ 0.4x0.2mm)

| T max. | Rated Voltage | TC Code | Cap.    | Tol.               | Part Number        |                    |
|--------|---------------|---------|---------|--------------------|--------------------|--------------------|
| 0.22mm | 16Vdc         | CH      | 1.8pF   | ±0.25pF            | GRM0222C1C1R8CA02# |                    |
|        |               |         |         | ±0.05pF            | GRM0222C1C1R9WA02# |                    |
|        |               |         |         |                    | ±0.1pF             | GRM0222C1C1R9BA02# |
|        |               |         | ±0.25pF | GRM0222C1C1R9CA02# |                    |                    |
|        |               |         |         | 2.0pF              | ±0.05pF            | GRM0222C1C2R0WA02# |
|        |               |         |         |                    | ±0.1pF             | GRM0222C1C2R0BA02# |
|        |               |         | ±0.25pF |                    | GRM0222C1C2R0CA02# |                    |
|        |               |         | 2.1pF   | ±0.05pF            | GRM0222C1C2R1WA02# |                    |
|        |               |         |         | ±0.1pF             | GRM0222C1C2R1BA02# |                    |
|        |               |         |         | ±0.25pF            | GRM0222C1C2R1CA02# |                    |
|        |               |         | 2.2pF   | ±0.05pF            | GRM0222C1C2R2WA02# |                    |
|        |               |         |         | ±0.1pF             | GRM0222C1C2R2BA02# |                    |
|        |               |         |         | ±0.25pF            | GRM0222C1C2R2CA02# |                    |
|        |               |         | 2.3pF   | ±0.05pF            | GRM0222C1C2R3WA02# |                    |
|        |               |         |         | ±0.1pF             | GRM0222C1C2R3BA02# |                    |
|        |               |         |         | ±0.25pF            | GRM0222C1C2R3CA02# |                    |
|        |               |         | 2.4pF   | ±0.05pF            | GRM0222C1C2R4WA02# |                    |
|        |               |         |         | ±0.1pF             | GRM0222C1C2R4BA02# |                    |
|        |               |         |         | ±0.25pF            | GRM0222C1C2R4CA02# |                    |
|        |               |         | 2.5pF   | ±0.05pF            | GRM0222C1C2R5WA02# |                    |
|        |               |         |         | ±0.1pF             | GRM0222C1C2R5BA02# |                    |
|        |               |         |         | ±0.25pF            | GRM0222C1C2R5CA02# |                    |
|        |               |         | 2.6pF   | ±0.05pF            | GRM0222C1C2R6WA02# |                    |
|        |               |         |         | ±0.1pF             | GRM0222C1C2R6BA02# |                    |
|        |               |         |         | ±0.25pF            | GRM0222C1C2R6CA02# |                    |
|        |               |         | 2.7pF   | ±0.05pF            | GRM0222C1C2R7WA02# |                    |
|        |               |         |         | ±0.1pF             | GRM0222C1C2R7BA02# |                    |
|        |               |         |         | ±0.25pF            | GRM0222C1C2R7CA02# |                    |
|        |               |         | 2.8pF   | ±0.05pF            | GRM0222C1C2R8WA02# |                    |
|        |               |         |         | ±0.1pF             | GRM0222C1C2R8BA02# |                    |
|        |               |         |         | ±0.25pF            | GRM0222C1C2R8CA02# |                    |
|        |               |         | 2.9pF   | ±0.05pF            | GRM0222C1C2R9WA02# |                    |
|        |               |         |         | ±0.1pF             | GRM0222C1C2R9BA02# |                    |
|        |               |         |         | ±0.25pF            | GRM0222C1C2R9CA02# |                    |
|        |               |         | 3.0pF   | ±0.05pF            | GRM0222C1C3R0WA02# |                    |
|        |               |         |         | ±0.1pF             | GRM0222C1C3R0BA02# |                    |
|        |               |         |         | ±0.25pF            | GRM0222C1C3R0CA02# |                    |
|        |               |         | 3.1pF   | ±0.05pF            | GRM0222C1C3R1WA02# |                    |
|        |               |         |         | ±0.1pF             | GRM0222C1C3R1BA02# |                    |
|        |               |         |         | ±0.25pF            | GRM0222C1C3R1CA02# |                    |
|        |               |         | 3.2pF   | ±0.05pF            | GRM0222C1C3R2WA02# |                    |
|        |               |         |         | ±0.1pF             | GRM0222C1C3R2BA02# |                    |
|        |               |         |         | ±0.25pF            | GRM0222C1C3R2CA02# |                    |
|        |               |         | 3.3pF   | ±0.05pF            | GRM0222C1C3R3WA02# |                    |
|        |               |         |         | ±0.1pF             | GRM0222C1C3R3BA02# |                    |
|        |               |         |         | ±0.25pF            | GRM0222C1C3R3CA02# |                    |
|        |               |         | 3.4pF   | ±0.05pF            | GRM0222C1C3R4WA02# |                    |
|        |               |         |         | ±0.1pF             | GRM0222C1C3R4BA02# |                    |
|        |               |         |         | ±0.25pF            | GRM0222C1C3R4CA02# |                    |
|        |               |         | 3.5pF   | ±0.05pF            | GRM0222C1C3R5WA02# |                    |
|        |               |         |         | ±0.1pF             | GRM0222C1C3R5BA02# |                    |
|        |               |         |         | ±0.25pF            | GRM0222C1C3R5CA02# |                    |
|        |               |         | 3.6pF   | ±0.05pF            | GRM0222C1C3R6WA02# |                    |
|        |               |         |         | ±0.1pF             | GRM0222C1C3R6BA02# |                    |

| T max. | Rated Voltage | TC Code | Cap.    | Tol.               | Part Number        |                    |
|--------|---------------|---------|---------|--------------------|--------------------|--------------------|
| 0.22mm | 16Vdc         | CH      | 3.6pF   | ±0.25pF            | GRM0222C1C3R6CA02# |                    |
|        |               |         |         | ±0.05pF            | GRM0222C1C3R7WA02# |                    |
|        |               |         |         |                    | ±0.1pF             | GRM0222C1C3R7BA02# |
|        |               |         | ±0.25pF | GRM0222C1C3R7CA02# |                    |                    |
|        |               |         |         | 3.8pF              | ±0.05pF            | GRM0222C1C3R8WA02# |
|        |               |         |         |                    | ±0.1pF             | GRM0222C1C3R8BA02# |
|        |               |         | ±0.25pF |                    | GRM0222C1C3R8CA02# |                    |
|        |               |         | 3.9pF   | ±0.05pF            | GRM0222C1C3R9WA02# |                    |
|        |               |         |         | ±0.1pF             | GRM0222C1C3R9BA02# |                    |
|        |               |         |         | ±0.25pF            | GRM0222C1C3R9CA02# |                    |
|        |               |         | 4.0pF   | ±0.05pF            | GRM0222C1C4R0WA02# |                    |
|        |               |         |         | ±0.1pF             | GRM0222C1C4R0BA02# |                    |
|        |               |         |         | ±0.25pF            | GRM0222C1C4R0CA02# |                    |
|        |               |         | 4.1pF   | ±0.05pF            | GRM0222C1C4R1WA02# |                    |
|        |               |         |         | ±0.1pF             | GRM0222C1C4R1BA02# |                    |
|        |               |         |         | ±0.25pF            | GRM0222C1C4R1CA02# |                    |
|        |               |         | 4.2pF   | ±0.05pF            | GRM0222C1C4R2WA02# |                    |
|        |               |         |         | ±0.1pF             | GRM0222C1C4R2BA02# |                    |
|        |               |         |         | ±0.25pF            | GRM0222C1C4R2CA02# |                    |
|        |               |         | 4.3pF   | ±0.05pF            | GRM0222C1C4R3WA02# |                    |
|        |               |         |         | ±0.1pF             | GRM0222C1C4R3BA02# |                    |
|        |               |         |         | ±0.25pF            | GRM0222C1C4R3CA02# |                    |
|        |               |         | 4.4pF   | ±0.05pF            | GRM0222C1C4R4WA02# |                    |
|        |               |         |         | ±0.1pF             | GRM0222C1C4R4BA02# |                    |
|        |               |         |         | ±0.25pF            | GRM0222C1C4R4CA02# |                    |
|        |               |         | 4.5pF   | ±0.05pF            | GRM0222C1C4R5WA02# |                    |
|        |               |         |         | ±0.1pF             | GRM0222C1C4R5BA02# |                    |
|        |               |         |         | ±0.25pF            | GRM0222C1C4R5CA02# |                    |
|        |               |         | 4.6pF   | ±0.05pF            | GRM0222C1C4R6WA02# |                    |
|        |               |         |         | ±0.1pF             | GRM0222C1C4R6BA02# |                    |
|        |               |         |         | ±0.25pF            | GRM0222C1C4R6CA02# |                    |
|        |               |         | 4.7pF   | ±0.05pF            | GRM0222C1C4R7WA02# |                    |
|        |               |         |         | ±0.1pF             | GRM0222C1C4R7BA02# |                    |
|        |               |         |         | ±0.25pF            | GRM0222C1C4R7CA02# |                    |
|        |               |         | 4.8pF   | ±0.05pF            | GRM0222C1C4R8WA02# |                    |
|        |               |         |         | ±0.1pF             | GRM0222C1C4R8BA02# |                    |
|        |               |         |         | ±0.25pF            | GRM0222C1C4R8CA02# |                    |
|        |               |         | 4.9pF   | ±0.05pF            | GRM0222C1C4R9WA02# |                    |
|        |               |         |         | ±0.1pF             | GRM0222C1C4R9BA02# |                    |
|        |               |         |         | ±0.25pF            | GRM0222C1C4R9CA02# |                    |
|        |               |         | 5.0pF   | ±0.05pF            | GRM0222C1C5R0WA02# |                    |
|        |               |         |         | ±0.1pF             | GRM0222C1C5R0BA02# |                    |
|        |               |         |         | ±0.25pF            | GRM0222C1C5R0CA02# |                    |
|        |               |         | 5.1pF   | ±0.05pF            | GRM0222C1C5R1WA02# |                    |
|        |               |         |         | ±0.1pF             | GRM0222C1C5R1BA02# |                    |
|        |               |         |         | ±0.25pF            | GRM0222C1C5R1CA02# |                    |
|        |               |         | 5.2pF   | ±0.05pF            | GRM0222C1C5R2WA02# |                    |
|        |               |         |         | ±0.1pF             | GRM0222C1C5R2BA02# |                    |
|        |               |         |         | ±0.25pF            | GRM0222C1C5R2CA02# |                    |
|        |               |         | 5.3pF   | ±0.05pF            | GRM0222C1C5R3WA02# |                    |
|        |               |         |         | ±0.1pF             | GRM0222C1C5R3BA02# |                    |
|        |               |         |         | ±0.25pF            | GRM0222C1C5R3CA02# |                    |

Part number # indicates the package specification code.

GRM Series  
GJM Series  
GMA Series  
GMD Series  
GQM Series  
GRJ Series  
GR3 Series  
KRM Series  
KR3 Series  
LLA Series  
LLL Series  
LLM Series  
LLR Series  
⚠Caution/Notice

# GRM Series Temperature Compensating Type Part Number List

(→ ■ 0.4x0.2mm)

| T max. | Rated Voltage | TC Code | Cap.    | Tol.               | Part Number        |                    |
|--------|---------------|---------|---------|--------------------|--------------------|--------------------|
| 0.22mm | 16Vdc         | CH      | 5.3pF   | ±0.5pF             | GRM0222C1C5R3DA02# |                    |
|        |               |         |         | ±0.05pF            | GRM0222C1C5R4WA02# |                    |
|        |               |         |         |                    | ±0.1pF             | GRM0222C1C5R4BA02# |
|        |               |         | ±0.25pF |                    | GRM0222C1C5R4CA02# |                    |
|        |               |         | ±0.5pF  | GRM0222C1C5R4DA02# |                    |                    |
|        |               |         |         | 5.5pF              | ±0.05pF            | GRM0222C1C5R5WA02# |
|        |               |         |         |                    | ±0.1pF             | GRM0222C1C5R5BA02# |
|        |               |         | ±0.25pF |                    | GRM0222C1C5R5CA02# |                    |
|        |               |         | ±0.5pF  | GRM0222C1C5R5DA02# |                    |                    |
|        |               |         |         | 5.6pF              | ±0.05pF            | GRM0222C1C5R6WA02# |
|        |               |         |         |                    | ±0.1pF             | GRM0222C1C5R6BA02# |
|        |               |         | ±0.25pF |                    | GRM0222C1C5R6CA02# |                    |
|        |               |         | ±0.5pF  | GRM0222C1C5R6DA02# |                    |                    |
|        |               |         |         | 5.7pF              | ±0.05pF            | GRM0222C1C5R7WA02# |
|        |               |         |         |                    | ±0.1pF             | GRM0222C1C5R7BA02# |
|        |               |         | ±0.25pF |                    | GRM0222C1C5R7CA02# |                    |
|        |               |         | ±0.5pF  | GRM0222C1C5R7DA02# |                    |                    |
|        |               |         |         | 5.8pF              | ±0.05pF            | GRM0222C1C5R8WA02# |
|        |               |         |         |                    | ±0.1pF             | GRM0222C1C5R8BA02# |
|        |               |         | ±0.25pF |                    | GRM0222C1C5R8CA02# |                    |
|        |               |         | ±0.5pF  | GRM0222C1C5R8DA02# |                    |                    |
|        |               |         |         | 5.9pF              | ±0.05pF            | GRM0222C1C5R9WA02# |
|        |               |         |         |                    | ±0.1pF             | GRM0222C1C5R9BA02# |
|        |               |         | ±0.25pF |                    | GRM0222C1C5R9CA02# |                    |
|        |               |         | ±0.5pF  | GRM0222C1C5R9DA02# |                    |                    |
|        |               |         |         | 6.0pF              | ±0.05pF            | GRM0222C1C6R0WA02# |
|        |               |         |         |                    | ±0.1pF             | GRM0222C1C6R0BA02# |
|        |               |         | ±0.25pF |                    | GRM0222C1C6R0CA02# |                    |
|        |               |         | ±0.5pF  | GRM0222C1C6R0DA02# |                    |                    |
|        |               |         |         | 6.1pF              | ±0.05pF            | GRM0222C1C6R1WA02# |
|        |               |         |         |                    | ±0.1pF             | GRM0222C1C6R1BA02# |
|        |               |         | ±0.25pF |                    | GRM0222C1C6R1CA02# |                    |
|        |               |         | ±0.5pF  | GRM0222C1C6R1DA02# |                    |                    |
|        |               |         |         | 6.2pF              | ±0.05pF            | GRM0222C1C6R2WA02# |
|        |               |         |         |                    | ±0.1pF             | GRM0222C1C6R2BA02# |
|        |               |         | ±0.25pF |                    | GRM0222C1C6R2CA02# |                    |
|        |               |         | ±0.5pF  | GRM0222C1C6R2DA02# |                    |                    |
|        |               |         |         | 6.3pF              | ±0.05pF            | GRM0222C1C6R3WA02# |
|        |               |         |         |                    | ±0.1pF             | GRM0222C1C6R3BA02# |
|        |               |         | ±0.25pF |                    | GRM0222C1C6R3CA02# |                    |
|        |               |         | ±0.5pF  | GRM0222C1C6R3DA02# |                    |                    |
|        |               |         |         | 6.4pF              | ±0.05pF            | GRM0222C1C6R4WA02# |
|        |               |         |         |                    | ±0.1pF             | GRM0222C1C6R4BA02# |
|        |               |         | ±0.25pF |                    | GRM0222C1C6R4CA02# |                    |
|        |               |         | ±0.5pF  | GRM0222C1C6R4DA02# |                    |                    |
|        |               |         |         | 6.5pF              | ±0.05pF            | GRM0222C1C6R5WA02# |
|        |               |         |         |                    | ±0.1pF             | GRM0222C1C6R5BA02# |
|        |               |         | ±0.25pF |                    | GRM0222C1C6R5CA02# |                    |
|        |               |         | ±0.5pF  | GRM0222C1C6R5DA02# |                    |                    |
|        |               |         |         | 6.6pF              | ±0.05pF            | GRM0222C1C6R6WA02# |
|        |               |         |         |                    | ±0.1pF             | GRM0222C1C6R6BA02# |
|        |               |         | ±0.25pF |                    | GRM0222C1C6R6CA02# |                    |
|        |               |         | ±0.5pF  | GRM0222C1C6R6DA02# |                    |                    |
|        |               |         |         | 6.7pF              | ±0.05pF            | GRM0222C1C6R7WA02# |

| T max. | Rated Voltage | TC Code | Cap.    | Tol.               | Part Number        |                    |
|--------|---------------|---------|---------|--------------------|--------------------|--------------------|
| 0.22mm | 16Vdc         | CH      | 6.7pF   | ±0.1pF             | GRM0222C1C6R7BA02# |                    |
|        |               |         |         | ±0.25pF            | GRM0222C1C6R7CA02# |                    |
|        |               |         |         | ±0.5pF             | GRM0222C1C6R7DA02# |                    |
|        |               |         | 6.8pF   | ±0.05pF            | GRM0222C1C6R8WA02# |                    |
|        |               |         |         | ±0.1pF             | GRM0222C1C6R8BA02# |                    |
|        |               |         |         | ±0.25pF            | GRM0222C1C6R8CA02# |                    |
|        |               |         | ±0.5pF  | GRM0222C1C6R8DA02# |                    |                    |
|        |               |         |         | 6.9pF              | ±0.05pF            | GRM0222C1C6R9WA02# |
|        |               |         |         |                    | ±0.1pF             | GRM0222C1C6R9BA02# |
|        |               |         | ±0.25pF |                    | GRM0222C1C6R9CA02# |                    |
|        |               |         | ±0.5pF  | GRM0222C1C6R9DA02# |                    |                    |
|        |               |         |         | 7.0pF              | ±0.05pF            | GRM0222C1C7R0WA02# |
|        |               |         |         |                    | ±0.1pF             | GRM0222C1C7R0BA02# |
|        |               |         | ±0.25pF |                    | GRM0222C1C7R0CA02# |                    |
|        |               |         | ±0.5pF  | GRM0222C1C7R0DA02# |                    |                    |
|        |               |         |         | 7.1pF              | ±0.05pF            | GRM0222C1C7R1WA02# |
|        |               |         |         |                    | ±0.1pF             | GRM0222C1C7R1BA02# |
|        |               |         | ±0.25pF |                    | GRM0222C1C7R1CA02# |                    |
|        |               |         | ±0.5pF  | GRM0222C1C7R1DA02# |                    |                    |
|        |               |         |         | 7.2pF              | ±0.05pF            | GRM0222C1C7R2WA02# |
|        |               |         |         |                    | ±0.1pF             | GRM0222C1C7R2BA02# |
|        |               |         | ±0.25pF |                    | GRM0222C1C7R2CA02# |                    |
|        |               |         | ±0.5pF  | GRM0222C1C7R2DA02# |                    |                    |
|        |               |         |         | 7.3pF              | ±0.05pF            | GRM0222C1C7R3WA02# |
|        |               |         |         |                    | ±0.1pF             | GRM0222C1C7R3BA02# |
|        |               |         | ±0.25pF |                    | GRM0222C1C7R3CA02# |                    |
|        |               |         | ±0.5pF  | GRM0222C1C7R3DA02# |                    |                    |
|        |               |         |         | 7.4pF              | ±0.05pF            | GRM0222C1C7R4WA02# |
|        |               |         |         |                    | ±0.1pF             | GRM0222C1C7R4BA02# |
|        |               |         | ±0.25pF |                    | GRM0222C1C7R4CA02# |                    |
|        |               |         | ±0.5pF  | GRM0222C1C7R4DA02# |                    |                    |
|        |               |         |         | 7.5pF              | ±0.05pF            | GRM0222C1C7R5WA02# |
|        |               |         |         |                    | ±0.1pF             | GRM0222C1C7R5BA02# |
|        |               |         | ±0.25pF |                    | GRM0222C1C7R5CA02# |                    |
|        |               |         | ±0.5pF  | GRM0222C1C7R5DA02# |                    |                    |
|        |               |         |         | 7.6pF              | ±0.05pF            | GRM0222C1C7R6WA02# |
|        |               |         |         |                    | ±0.1pF             | GRM0222C1C7R6BA02# |
|        |               |         | ±0.25pF |                    | GRM0222C1C7R6CA02# |                    |
|        |               |         | ±0.5pF  | GRM0222C1C7R6DA02# |                    |                    |
|        |               |         |         | 7.7pF              | ±0.05pF            | GRM0222C1C7R7WA02# |
|        |               |         |         |                    | ±0.1pF             | GRM0222C1C7R7BA02# |
|        |               |         | ±0.25pF |                    | GRM0222C1C7R7CA02# |                    |
|        |               |         | ±0.5pF  | GRM0222C1C7R7DA02# |                    |                    |
|        |               |         |         | 7.8pF              | ±0.05pF            | GRM0222C1C7R8WA02# |
|        |               |         |         |                    | ±0.1pF             | GRM0222C1C7R8BA02# |
|        |               |         | ±0.25pF |                    | GRM0222C1C7R8CA02# |                    |
|        |               |         | ±0.5pF  | GRM0222C1C7R8DA02# |                    |                    |
|        |               |         |         | 7.9pF              | ±0.05pF            | GRM0222C1C7R9WA02# |
|        |               |         |         |                    | ±0.1pF             | GRM0222C1C7R9BA02# |
|        |               |         | ±0.25pF |                    | GRM0222C1C7R9CA02# |                    |
|        |               |         | ±0.5pF  | GRM0222C1C7R9DA02# |                    |                    |
|        |               |         |         | 8.0pF              | ±0.05pF            | GRM0222C1C8R0WA02# |
|        |               |         |         |                    | ±0.1pF             | GRM0222C1C8R0BA02# |
|        |               |         | ±0.25pF |                    | GRM0222C1C8R0CA02# |                    |

Part number # indicates the package specification code.

## GRM Series Temperature Compensating Type Part Number List

(→ ■ 0.4x0.2mm)

| T max. | Rated Voltage | TC Code | Cap.   | Tol.               | Part Number        |                    |
|--------|---------------|---------|--------|--------------------|--------------------|--------------------|
| 0.22mm | 16Vdc         | CH      | 8.0pF  | ±0.5pF             | GRM0222C1C8R0DA02# |                    |
|        |               |         |        | 8.1pF              | ±0.05pF            | GRM0222C1C8R1WA02# |
|        |               |         |        |                    | ±0.1pF             | GRM0222C1C8R1BA02# |
|        |               |         |        |                    | ±0.25pF            | GRM0222C1C8R1CA02# |
|        |               |         | ±0.5pF | GRM0222C1C8R1DA02# |                    |                    |
|        |               |         | 8.2pF  | ±0.05pF            | GRM0222C1C8R2WA02# |                    |
|        |               |         |        | ±0.1pF             | GRM0222C1C8R2BA02# |                    |
|        |               |         |        | ±0.25pF            | GRM0222C1C8R2CA02# |                    |
|        |               |         |        | ±0.5pF             | GRM0222C1C8R2DA02# |                    |
|        |               |         | 8.3pF  | ±0.05pF            | GRM0222C1C8R3WA02# |                    |
|        |               |         |        | ±0.1pF             | GRM0222C1C8R3BA02# |                    |
|        |               |         |        | ±0.25pF            | GRM0222C1C8R3CA02# |                    |
|        |               |         |        | ±0.5pF             | GRM0222C1C8R3DA02# |                    |
|        |               |         | 8.4pF  | ±0.05pF            | GRM0222C1C8R4WA02# |                    |
|        |               |         |        | ±0.1pF             | GRM0222C1C8R4BA02# |                    |
|        |               |         |        | ±0.25pF            | GRM0222C1C8R4CA02# |                    |
|        |               |         |        | ±0.5pF             | GRM0222C1C8R4DA02# |                    |
|        |               |         | 8.5pF  | ±0.05pF            | GRM0222C1C8R5WA02# |                    |
|        |               |         |        | ±0.1pF             | GRM0222C1C8R5BA02# |                    |
|        |               |         |        | ±0.25pF            | GRM0222C1C8R5CA02# |                    |
|        |               |         |        | ±0.5pF             | GRM0222C1C8R5DA02# |                    |
|        |               |         | 8.6pF  | ±0.05pF            | GRM0222C1C8R6WA02# |                    |
|        |               |         |        | ±0.1pF             | GRM0222C1C8R6BA02# |                    |
|        |               |         |        | ±0.25pF            | GRM0222C1C8R6CA02# |                    |
|        |               |         |        | ±0.5pF             | GRM0222C1C8R6DA02# |                    |
|        |               |         | 8.7pF  | ±0.05pF            | GRM0222C1C8R7WA02# |                    |
|        |               |         |        | ±0.1pF             | GRM0222C1C8R7BA02# |                    |
|        |               |         |        | ±0.25pF            | GRM0222C1C8R7CA02# |                    |
|        |               |         |        | ±0.5pF             | GRM0222C1C8R7DA02# |                    |
|        |               |         | 8.8pF  | ±0.05pF            | GRM0222C1C8R8WA02# |                    |
|        |               |         |        | ±0.1pF             | GRM0222C1C8R8BA02# |                    |
|        |               |         |        | ±0.25pF            | GRM0222C1C8R8CA02# |                    |
|        |               |         |        | ±0.5pF             | GRM0222C1C8R8DA02# |                    |
|        |               |         | 8.9pF  | ±0.05pF            | GRM0222C1C8R9WA02# |                    |
|        |               |         |        | ±0.1pF             | GRM0222C1C8R9BA02# |                    |
|        |               |         |        | ±0.25pF            | GRM0222C1C8R9CA02# |                    |
|        |               |         |        | ±0.5pF             | GRM0222C1C8R9DA02# |                    |
|        |               |         | 9.0pF  | ±0.05pF            | GRM0222C1C9R0WA02# |                    |
|        |               |         |        | ±0.1pF             | GRM0222C1C9R0BA02# |                    |
|        |               |         |        | ±0.25pF            | GRM0222C1C9R0CA02# |                    |
|        |               |         |        | ±0.5pF             | GRM0222C1C9R0DA02# |                    |
|        |               |         | 9.1pF  | ±0.05pF            | GRM0222C1C9R1WA02# |                    |
|        |               |         |        | ±0.1pF             | GRM0222C1C9R1BA02# |                    |
|        |               |         |        | ±0.25pF            | GRM0222C1C9R1CA02# |                    |
|        |               |         |        | ±0.5pF             | GRM0222C1C9R1DA02# |                    |
|        |               |         | 9.2pF  | ±0.05pF            | GRM0222C1C9R2WA02# |                    |
|        |               |         |        | ±0.1pF             | GRM0222C1C9R2BA02# |                    |
|        |               |         |        | ±0.25pF            | GRM0222C1C9R2CA02# |                    |
|        |               |         |        | ±0.5pF             | GRM0222C1C9R2DA02# |                    |
|        |               |         | 9.3pF  | ±0.05pF            | GRM0222C1C9R3WA02# |                    |
|        |               |         |        | ±0.1pF             | GRM0222C1C9R3BA02# |                    |
|        |               |         |        | ±0.25pF            | GRM0222C1C9R3CA02# |                    |
|        |               |         |        | ±0.5pF             | GRM0222C1C9R3DA02# |                    |
|        |               |         | 9.4pF  | ±0.05pF            | GRM0222C1C9R4WA02# |                    |

| T max. | Rated Voltage | TC Code            | Cap.   | Tol.               | Part Number        |
|--------|---------------|--------------------|--------|--------------------|--------------------|
| 0.22mm | 16Vdc         | CH                 | 9.4pF  | ±0.1pF             | GRM0222C1C9R4BA02# |
|        |               |                    |        | ±0.25pF            | GRM0222C1C9R4CA02# |
|        |               |                    |        | ±0.5pF             | GRM0222C1C9R4DA02# |
|        |               |                    | 9.5pF  | ±0.05pF            | GRM0222C1C9R5WA02# |
|        |               |                    |        | ±0.1pF             | GRM0222C1C9R5BA02# |
|        |               |                    |        | ±0.25pF            | GRM0222C1C9R5CA02# |
|        |               |                    | ±0.5pF | GRM0222C1C9R5DA02# |                    |
|        |               |                    | 9.6pF  | ±0.05pF            | GRM0222C1C9R6WA02# |
|        |               |                    |        | ±0.1pF             | GRM0222C1C9R6BA02# |
|        |               |                    |        | ±0.25pF            | GRM0222C1C9R6CA02# |
|        |               |                    | ±0.5pF | GRM0222C1C9R6DA02# |                    |
|        |               |                    | 9.7pF  | ±0.05pF            | GRM0222C1C9R7WA02# |
|        |               |                    |        | ±0.1pF             | GRM0222C1C9R7BA02# |
|        |               |                    |        | ±0.25pF            | GRM0222C1C9R7CA02# |
|        |               |                    | ±0.5pF | GRM0222C1C9R7DA02# |                    |
|        |               |                    | 9.8pF  | ±0.05pF            | GRM0222C1C9R8WA02# |
|        |               |                    |        | ±0.1pF             | GRM0222C1C9R8BA02# |
|        |               |                    |        | ±0.25pF            | GRM0222C1C9R8CA02# |
|        |               |                    | ±0.5pF | GRM0222C1C9R8DA02# |                    |
|        |               |                    | 9.9pF  | ±0.05pF            | GRM0222C1C9R9WA02# |
|        |               |                    |        | ±0.1pF             | GRM0222C1C9R9BA02# |
|        |               |                    |        | ±0.25pF            | GRM0222C1C9R9CA02# |
|        |               |                    | ±0.5pF | GRM0222C1C9R9DA02# |                    |
|        |               |                    | 10pF   | ±2%                | GRM0222C1C100GA02# |
|        |               |                    |        | ±5%                | GRM0222C1C100JA02# |
|        |               |                    | 10.5pF | ±2%                | GRM0222C1C10EGA02# |
|        |               |                    | 11pF   | ±2%                | GRM0222C1C110GA02# |
|        |               |                    |        | ±5%                | GRM0222C1C110JA02# |
|        |               |                    | 12pF   | ±2%                | GRM0222C1C120GA02# |
|        |               |                    |        | ±5%                | GRM0222C1C120JA02# |
|        |               |                    | 12.5pF | ±2%                | GRM0222C1C12EGA02# |
|        |               |                    |        | ±2%                | GRM0222C1C130GA02# |
|        |               |                    | 13pF   | ±2%                | GRM0222C1C130JA02# |
|        |               |                    |        | ±5%                | GRM0222C1C130JA02# |
|        |               |                    | 14pF   | ±2%                | GRM0222C1C140GA02# |
|        |               |                    |        | ±5%                | GRM0222C1C140JA02# |
|        |               |                    | 15pF   | ±2%                | GRM0222C1C150GA02# |
|        |               |                    |        | ±5%                | GRM0222C1C150JA02# |
|        |               |                    | 16pF   | ±2%                | GRM0222C1C160GA02# |
|        |               |                    |        | ±5%                | GRM0222C1C160JA02# |
| 17pF   | ±2%           | GRM0222C1C170GA02# |        |                    |                    |
|        | ±5%           | GRM0222C1C170JA02# |        |                    |                    |
| 18pF   | ±2%           | GRM0222C1C180GA02# |        |                    |                    |
|        | ±5%           | GRM0222C1C180JA02# |        |                    |                    |
| 19pF   | ±2%           | GRM0222C1C190GA02# |        |                    |                    |
|        | ±5%           | GRM0222C1C190JA02# |        |                    |                    |
| 20pF   | ±2%           | GRM0222C1C200GA02# |        |                    |                    |
|        | ±5%           | GRM0222C1C200JA02# |        |                    |                    |
| 21pF   | ±2%           | GRM0222C1C210GA02# |        |                    |                    |
|        | ±5%           | GRM0222C1C210JA02# |        |                    |                    |
| 22pF   | ±2%           | GRM0222C1C220GA02# |        |                    |                    |
|        | ±5%           | GRM0222C1C220JA02# |        |                    |                    |
| 24pF   | ±2%           | GRM0222C1C240GA02# |        |                    |                    |
|        | ±5%           | GRM0222C1C240JA02# |        |                    |                    |
| 27pF   | ±2%           | GRM0222C1C270GA02# |        |                    |                    |

Part number # indicates the package specification code.

GRM Series  
GJM Series  
GMA Series  
GMD Series  
GQM Series  
GRJ Series  
GR3 Series  
KRM Series  
KR3 Series  
LLA Series  
LLL Series  
LLM Series  
LLR Series  
⚠Caution/ Notice

# GRM Series Temperature Compensating Type Part Number List

(→ ■ 0.4x0.2mm)

| T max. | Rated Voltage      | TC Code | Cap.               | Tol.  | Part Number        |      |                    |
|--------|--------------------|---------|--------------------|-------|--------------------|------|--------------------|
| 0.22mm | 16Vdc              | CH      | 27pF               | ±5%   | GRM0222C1C270JA02# |      |                    |
|        |                    |         |                    | ±2%   | GRM0222C1C300GA02# |      |                    |
|        |                    |         | 30pF               | ±5%   | GRM0222C1C300JA02# |      |                    |
|        |                    |         |                    | ±2%   | GRM0222C1C330GA02# |      |                    |
|        |                    |         | 33pF               | ±5%   | GRM0222C1C330JA02# |      |                    |
|        |                    |         |                    | ±2%   | GRM0222C1C360GA02# |      |                    |
|        |                    |         | 36pF               | ±5%   | GRM0222C1C360JA02# |      |                    |
|        |                    |         |                    | ±2%   | GRM0222C1C390GA02# |      |                    |
|        |                    |         | 39pF               | ±5%   | GRM0222C1C390JA02# |      |                    |
|        |                    |         |                    | ±2%   | GRM0222C1C430GA02# |      |                    |
|        |                    |         | 43pF               | ±5%   | GRM0222C1C430JA02# |      |                    |
|        |                    |         |                    | ±2%   | GRM0222C1C470GA02# |      |                    |
|        |                    |         | 47pF               | ±5%   | GRM0222C1C470JA02# |      |                    |
|        |                    |         |                    | ±2%   | GRM0222C1C510GA02# |      |                    |
|        |                    |         | 51pF               | ±5%   | GRM0222C1C510JA02# |      |                    |
|        |                    |         |                    | ±2%   | GRM0222C1C560GA02# |      |                    |
|        |                    |         | 56pF               | ±5%   | GRM0222C1C560JA02# |      |                    |
|        |                    |         |                    | ±2%   | GRM0222C1C620GA02# |      |                    |
|        |                    |         | 62pF               | ±5%   | GRM0222C1C620JA02# |      |                    |
|        |                    |         |                    | ±2%   | GRM0222C1C680GA02# |      |                    |
|        |                    |         | 68pF               | ±5%   | GRM0222C1C680JA02# |      |                    |
|        |                    |         |                    | ±2%   | GRM0222C1C750GA02# |      |                    |
|        |                    |         | 75pF               | ±5%   | GRM0222C1C750JA02# |      |                    |
|        |                    |         |                    | ±2%   | GRM0222C1C820GA02# |      |                    |
|        |                    |         | 82pF               | ±5%   | GRM0222C1C820JA02# |      |                    |
|        |                    |         |                    | ±2%   | GRM0222C1C910GA02# |      |                    |
|        |                    |         | 91pF               | ±5%   | GRM0222C1C910JA02# |      |                    |
|        |                    |         |                    | ±2%   | GRM0222C1C101GA02# |      |                    |
|        |                    |         | 100pF              | ±5%   | GRM0222C1C101JA02# |      |                    |
|        |                    |         |                    | 10Vdc | COG                | 56pF | ±2%                |
|        |                    |         | ±5%                |       |                    |      | GRM0225C1A560JD05# |
|        |                    |         | 68pF               |       |                    | ±2%  | GRM0225C1A680GD05# |
|        |                    |         |                    |       |                    | ±5%  | GRM0225C1A680JD05# |
|        |                    |         | 82pF               |       |                    | ±2%  | GRM0225C1A820GD05# |
|        |                    |         |                    |       |                    | ±5%  | GRM0225C1A820JD05# |
|        |                    |         | 100pF              |       |                    | ±2%  | GRM0225C1A101GD05# |
| ±5%    | GRM0225C1A101JD05# |         |                    |       |                    |      |                    |
| CH     | 56pF               | ±2%     | GRM0222C1A560GD05# |       |                    |      |                    |
|        |                    | ±5%     | GRM0222C1A560JD05# |       |                    |      |                    |
|        | 68pF               | ±2%     | GRM0222C1A680GD05# |       |                    |      |                    |
|        |                    | ±5%     | GRM0222C1A680JD05# |       |                    |      |                    |
|        | 82pF               | ±2%     | GRM0222C1A820GD05# |       |                    |      |                    |
|        |                    | ±5%     | GRM0222C1A820JD05# |       |                    |      |                    |
|        | 100pF              | ±2%     | GRM0222C1A101GD05# |       |                    |      |                    |
|        |                    | ±5%     | GRM0222C1A101JD05# |       |                    |      |                    |

■ 0.6x0.3mm **Ultra-compact**

| T max. | Rated Voltage | TC Code            | Cap.   | Tol.    | Part Number        |
|--------|---------------|--------------------|--------|---------|--------------------|
| 0.33mm | 100Vdc        | COG                | 0.10pF | ±0.05pF | GRM0335C2AR10WA01# |
|        |               |                    |        | ±0.1pF  | GRM0335C2AR20BA01# |
|        |               |                    | 0.20pF | ±0.05pF | GRM0335C2AR20WA01# |
|        |               |                    |        | ±0.1pF  | GRM0335C2AR20BA01# |
| 0.30pF | ±0.05pF       | GRM0335C2AR30WA01# |        |         |                    |
|        | ±0.1pF        | GRM0335C2AR30BA01# |        |         |                    |

| T max.  | Rated Voltage      | TC Code            | Cap.   | Tol.    | Part Number        |
|---------|--------------------|--------------------|--------|---------|--------------------|
| 0.33mm  | 100Vdc             | COG                | 0.30pF | ±0.1pF  | GRM0335C2AR30BA01# |
|         |                    |                    |        | ±0.05pF | GRM0335C2AR40WA01# |
|         |                    |                    | 0.40pF | ±0.1pF  | GRM0335C2AR40BA01# |
|         |                    |                    |        | ±0.05pF | GRM0335C2AR50WA01# |
|         |                    |                    | 0.50pF | ±0.1pF  | GRM0335C2AR50BA01# |
|         |                    |                    |        | ±0.05pF | GRM0335C2AR60WA01# |
|         |                    |                    | 0.60pF | ±0.1pF  | GRM0335C2AR60BA01# |
|         |                    |                    |        | ±0.05pF | GRM0335C2AR70WA01# |
|         |                    |                    | 0.70pF | ±0.1pF  | GRM0335C2AR70BA01# |
|         |                    |                    |        | ±0.05pF | GRM0335C2AR80WA01# |
|         |                    |                    | 0.80pF | ±0.1pF  | GRM0335C2AR80BA01# |
|         |                    |                    |        | ±0.05pF | GRM0335C2AR90WA01# |
|         |                    |                    | 0.90pF | ±0.1pF  | GRM0335C2AR90BA01# |
|         |                    |                    |        | ±0.05pF | GRM0335C2A1R0WA01# |
|         |                    |                    | 1.0pF  | ±0.1pF  | GRM0335C2A1R0BA01# |
|         |                    |                    |        | ±0.25pF | GRM0335C2A1R0CA01# |
|         |                    |                    |        | ±0.05pF | GRM0335C2A1R1WA01# |
|         |                    |                    | 1.1pF  | ±0.1pF  | GRM0335C2A1R1BA01# |
|         |                    |                    |        | ±0.25pF | GRM0335C2A1R1CA01# |
|         |                    |                    |        | ±0.05pF | GRM0335C2A1R2WA01# |
|         |                    |                    | 1.2pF  | ±0.1pF  | GRM0335C2A1R2BA01# |
|         |                    |                    |        | ±0.25pF | GRM0335C2A1R2CA01# |
|         |                    |                    |        | ±0.05pF | GRM0335C2A1R3WA01# |
|         |                    |                    | 1.3pF  | ±0.1pF  | GRM0335C2A1R3BA01# |
|         |                    |                    |        | ±0.25pF | GRM0335C2A1R3CA01# |
|         |                    |                    |        | ±0.05pF | GRM0335C2A1R4WA01# |
|         |                    |                    | 1.4pF  | ±0.1pF  | GRM0335C2A1R4BA01# |
|         |                    |                    |        | ±0.25pF | GRM0335C2A1R4CA01# |
|         |                    |                    |        | ±0.05pF | GRM0335C2A1R5WA01# |
|         |                    |                    | 1.5pF  | ±0.1pF  | GRM0335C2A1R5BA01# |
|         |                    |                    |        | ±0.25pF | GRM0335C2A1R5CA01# |
|         |                    |                    |        | ±0.05pF | GRM0335C2A1R6WA01# |
|         |                    |                    | 1.6pF  | ±0.1pF  | GRM0335C2A1R6BA01# |
|         |                    |                    |        | ±0.25pF | GRM0335C2A1R6CA01# |
|         |                    |                    |        | ±0.05pF | GRM0335C2A1R7WA01# |
|         |                    |                    | 1.7pF  | ±0.1pF  | GRM0335C2A1R7BA01# |
|         |                    |                    |        | ±0.25pF | GRM0335C2A1R7CA01# |
|         |                    |                    |        | ±0.05pF | GRM0335C2A1R8WA01# |
|         |                    |                    | 1.8pF  | ±0.1pF  | GRM0335C2A1R8BA01# |
|         |                    |                    |        | ±0.25pF | GRM0335C2A1R8CA01# |
|         |                    |                    |        | ±0.05pF | GRM0335C2A1R9WA01# |
|         |                    |                    | 1.9pF  | ±0.1pF  | GRM0335C2A1R9BA01# |
|         |                    |                    |        | ±0.25pF | GRM0335C2A1R9CA01# |
|         |                    |                    |        | ±0.05pF | GRM0335C2A2R0WA01# |
|         |                    |                    | 2.0pF  | ±0.1pF  | GRM0335C2A2R0BA01# |
|         |                    |                    |        | ±0.25pF | GRM0335C2A2R0CA01# |
|         |                    |                    |        | ±0.05pF | GRM0335C2A2R1WA01# |
|         |                    |                    | 2.1pF  | ±0.1pF  | GRM0335C2A2R1BA01# |
| ±0.25pF | GRM0335C2A2R1CA01# |                    |        |         |                    |
| ±0.05pF | GRM0335C2A2R2WA01# |                    |        |         |                    |
| 2.2pF   | ±0.1pF             | GRM0335C2A2R2BA01# |        |         |                    |
|         | ±0.25pF            | GRM0335C2A2R2CA01# |        |         |                    |
|         | ±0.05pF            | GRM0335C2A2R3WA01# |        |         |                    |
| 2.3pF   | ±0.1pF             | GRM0335C2A2R3BA01# |        |         |                    |

Part number # indicates the package specification code.

## GRM Series Temperature Compensating Type Part Number List

(→ ■ 0.6x0.3mm)

| T max.  | Rated Voltage      | TC Code            | Cap.    | Tol.               | Part Number        |                    |
|---------|--------------------|--------------------|---------|--------------------|--------------------|--------------------|
| 0.33mm  | 100Vdc             | C0G                | 2.3pF   | ±0.25pF            | GRM0335C2A2R3CA01# |                    |
|         |                    |                    |         | ±0.05pF            | GRM0335C2A2R4WA01# |                    |
|         |                    |                    |         |                    | ±0.1pF             | GRM0335C2A2R4BA01# |
|         |                    |                    | ±0.25pF | GRM0335C2A2R4CA01# |                    |                    |
|         |                    |                    |         | 2.5pF              | ±0.05pF            | GRM0335C2A2R5WA01# |
|         |                    |                    |         |                    | ±0.1pF             | GRM0335C2A2R5BA01# |
|         |                    |                    | ±0.25pF |                    | GRM0335C2A2R5CA01# |                    |
|         |                    |                    | 2.6pF   | ±0.05pF            | GRM0335C2A2R6WA01# |                    |
|         |                    |                    |         | ±0.1pF             | GRM0335C2A2R6BA01# |                    |
|         |                    |                    |         | ±0.25pF            | GRM0335C2A2R6CA01# |                    |
|         |                    |                    | 2.7pF   | ±0.05pF            | GRM0335C2A2R7WA01# |                    |
|         |                    |                    |         | ±0.1pF             | GRM0335C2A2R7BA01# |                    |
|         |                    |                    |         | ±0.25pF            | GRM0335C2A2R7CA01# |                    |
|         |                    |                    | 2.8pF   | ±0.05pF            | GRM0335C2A2R8WA01# |                    |
|         |                    |                    |         | ±0.1pF             | GRM0335C2A2R8BA01# |                    |
|         |                    |                    |         | ±0.25pF            | GRM0335C2A2R8CA01# |                    |
|         |                    |                    | 2.9pF   | ±0.05pF            | GRM0335C2A2R9WA01# |                    |
|         |                    |                    |         | ±0.1pF             | GRM0335C2A2R9BA01# |                    |
|         |                    |                    |         | ±0.25pF            | GRM0335C2A2R9CA01# |                    |
|         |                    |                    | 3.0pF   | ±0.05pF            | GRM0335C2A3R0WA01# |                    |
|         |                    |                    |         | ±0.1pF             | GRM0335C2A3R0BA01# |                    |
|         |                    |                    |         | ±0.25pF            | GRM0335C2A3R0CA01# |                    |
|         |                    |                    | 3.1pF   | ±0.05pF            | GRM0335C2A3R1WA01# |                    |
|         |                    |                    |         | ±0.1pF             | GRM0335C2A3R1BA01# |                    |
|         |                    |                    |         | ±0.25pF            | GRM0335C2A3R1CA01# |                    |
|         |                    |                    | 3.2pF   | ±0.05pF            | GRM0335C2A3R2WA01# |                    |
|         |                    |                    |         | ±0.1pF             | GRM0335C2A3R2BA01# |                    |
|         |                    |                    |         | ±0.25pF            | GRM0335C2A3R2CA01# |                    |
|         |                    |                    | 3.3pF   | ±0.05pF            | GRM0335C2A3R3WA01# |                    |
|         |                    |                    |         | ±0.1pF             | GRM0335C2A3R3BA01# |                    |
|         |                    |                    |         | ±0.25pF            | GRM0335C2A3R3CA01# |                    |
|         |                    |                    | 3.4pF   | ±0.05pF            | GRM0335C2A3R4WA01# |                    |
|         |                    |                    |         | ±0.1pF             | GRM0335C2A3R4BA01# |                    |
|         |                    |                    |         | ±0.25pF            | GRM0335C2A3R4CA01# |                    |
|         |                    |                    | 3.5pF   | ±0.05pF            | GRM0335C2A3R5WA01# |                    |
|         |                    |                    |         | ±0.1pF             | GRM0335C2A3R5BA01# |                    |
|         |                    |                    |         | ±0.25pF            | GRM0335C2A3R5CA01# |                    |
|         |                    |                    | 3.6pF   | ±0.05pF            | GRM0335C2A3R6WA01# |                    |
|         |                    |                    |         | ±0.1pF             | GRM0335C2A3R6BA01# |                    |
|         |                    |                    |         | ±0.25pF            | GRM0335C2A3R6CA01# |                    |
|         |                    |                    | 3.7pF   | ±0.05pF            | GRM0335C2A3R7WA01# |                    |
|         |                    |                    |         | ±0.1pF             | GRM0335C2A3R7BA01# |                    |
|         |                    |                    |         | ±0.25pF            | GRM0335C2A3R7CA01# |                    |
|         |                    |                    | 3.8pF   | ±0.05pF            | GRM0335C2A3R8WA01# |                    |
|         |                    |                    |         | ±0.1pF             | GRM0335C2A3R8BA01# |                    |
|         |                    |                    |         | ±0.25pF            | GRM0335C2A3R8CA01# |                    |
|         |                    |                    | 3.9pF   | ±0.05pF            | GRM0335C2A3R9WA01# |                    |
|         |                    |                    |         | ±0.1pF             | GRM0335C2A3R9BA01# |                    |
| ±0.25pF | GRM0335C2A3R9CA01# |                    |         |                    |                    |                    |
| 4.0pF   | ±0.05pF            | GRM0335C2A4R0WA01# |         |                    |                    |                    |
|         | ±0.1pF             | GRM0335C2A4R0BA01# |         |                    |                    |                    |
|         | ±0.25pF            | GRM0335C2A4R0CA01# |         |                    |                    |                    |
| 4.1pF   | ±0.05pF            | GRM0335C2A4R1WA01# |         |                    |                    |                    |
|         | ±0.1pF             | GRM0335C2A4R1BA01# |         |                    |                    |                    |

| T max. | Rated Voltage      | TC Code            | Cap.               | Tol.               | Part Number        |                    |
|--------|--------------------|--------------------|--------------------|--------------------|--------------------|--------------------|
| 0.33mm | 100Vdc             | C0G                | 4.1pF              | ±0.25pF            | GRM0335C2A4R1CA01# |                    |
|        |                    |                    |                    | ±0.05pF            | GRM0335C2A4R2WA01# |                    |
|        |                    |                    |                    |                    | ±0.1pF             | GRM0335C2A4R2BA01# |
|        |                    |                    | ±0.25pF            | GRM0335C2A4R2CA01# |                    |                    |
|        |                    |                    |                    | 4.3pF              | ±0.05pF            | GRM0335C2A4R3WA01# |
|        |                    |                    |                    |                    | ±0.1pF             | GRM0335C2A4R3BA01# |
|        |                    |                    | ±0.25pF            |                    | GRM0335C2A4R3CA01# |                    |
|        |                    |                    | 4.4pF              | ±0.05pF            | GRM0335C2A4R4WA01# |                    |
|        |                    |                    |                    | ±0.1pF             | GRM0335C2A4R4BA01# |                    |
|        |                    |                    |                    | ±0.25pF            | GRM0335C2A4R4CA01# |                    |
|        |                    |                    | 4.5pF              | ±0.05pF            | GRM0335C2A4R5WA01# |                    |
|        |                    |                    |                    | ±0.1pF             | GRM0335C2A4R5BA01# |                    |
|        |                    |                    |                    | ±0.25pF            | GRM0335C2A4R5CA01# |                    |
|        |                    |                    | 4.6pF              | ±0.05pF            | GRM0335C2A4R6WA01# |                    |
|        |                    |                    |                    | ±0.1pF             | GRM0335C2A4R6BA01# |                    |
|        |                    |                    |                    | ±0.25pF            | GRM0335C2A4R6CA01# |                    |
|        |                    |                    | 4.7pF              | ±0.05pF            | GRM0335C2A4R7WA01# |                    |
|        |                    |                    |                    | ±0.1pF             | GRM0335C2A4R7BA01# |                    |
|        |                    |                    |                    | ±0.25pF            | GRM0335C2A4R7CA01# |                    |
|        |                    |                    | 4.8pF              | ±0.05pF            | GRM0335C2A4R8WA01# |                    |
|        |                    |                    |                    | ±0.1pF             | GRM0335C2A4R8BA01# |                    |
|        |                    |                    |                    | ±0.25pF            | GRM0335C2A4R8CA01# |                    |
|        |                    |                    | 4.9pF              | ±0.05pF            | GRM0335C2A4R9WA01# |                    |
|        |                    |                    |                    | ±0.1pF             | GRM0335C2A4R9BA01# |                    |
|        |                    |                    |                    | ±0.25pF            | GRM0335C2A4R9CA01# |                    |
|        |                    |                    | 5.0pF              | ±0.05pF            | GRM0335C2A5R0WA01# |                    |
|        |                    |                    |                    | ±0.1pF             | GRM0335C2A5R0BA01# |                    |
|        |                    |                    |                    | ±0.25pF            | GRM0335C2A5R0CA01# |                    |
|        |                    |                    | 5.1pF              | ±0.05pF            | GRM0335C2A5R1WA01# |                    |
|        |                    |                    |                    | ±0.1pF             | GRM0335C2A5R1BA01# |                    |
|        |                    |                    |                    | ±0.25pF            | GRM0335C2A5R1CA01# |                    |
|        |                    |                    | ±0.5pF             | GRM0335C2A5R1DA01# |                    |                    |
|        |                    |                    |                    | 5.2pF              | ±0.05pF            | GRM0335C2A5R2WA01# |
|        |                    |                    |                    |                    | ±0.1pF             | GRM0335C2A5R2BA01# |
|        |                    |                    | ±0.25pF            |                    | GRM0335C2A5R2CA01# |                    |
|        |                    |                    | ±0.5pF             | GRM0335C2A5R2DA01# |                    |                    |
|        |                    |                    |                    | 5.3pF              | ±0.05pF            | GRM0335C2A5R3WA01# |
|        |                    |                    |                    |                    | ±0.1pF             | GRM0335C2A5R3BA01# |
|        |                    |                    | ±0.25pF            |                    | GRM0335C2A5R3CA01# |                    |
|        |                    |                    | ±0.5pF             | GRM0335C2A5R3DA01# |                    |                    |
|        |                    |                    |                    | 5.4pF              | ±0.05pF            | GRM0335C2A5R4WA01# |
|        |                    |                    |                    |                    | ±0.1pF             | GRM0335C2A5R4BA01# |
|        |                    |                    | ±0.25pF            |                    | GRM0335C2A5R4CA01# |                    |
|        |                    |                    | ±0.5pF             | GRM0335C2A5R4DA01# |                    |                    |
|        |                    |                    |                    | 5.5pF              | ±0.05pF            | GRM0335C2A5R5WA01# |
|        |                    |                    |                    |                    | ±0.1pF             | GRM0335C2A5R5BA01# |
|        |                    |                    | ±0.25pF            |                    | GRM0335C2A5R5CA01# |                    |
|        |                    |                    | ±0.5pF             | GRM0335C2A5R5DA01# |                    |                    |
| 5.6pF  | ±0.05pF            | GRM0335C2A5R6WA01# |                    |                    |                    |                    |
|        | ±0.1pF             | GRM0335C2A5R6BA01# |                    |                    |                    |                    |
|        | ±0.25pF            | GRM0335C2A5R6CA01# |                    |                    |                    |                    |
| ±0.5pF | GRM0335C2A5R6DA01# |                    |                    |                    |                    |                    |
|        | 5.7pF              | ±0.05pF            | GRM0335C2A5R7WA01# |                    |                    |                    |
|        |                    | ±0.1pF             | GRM0335C2A5R7BA01# |                    |                    |                    |

Part number # indicates the package specification code.

GRM Series  
GJM Series  
GMA Series  
GMD Series  
GQM Series  
GRJ Series  
GR3 Series  
KRM Series  
KR3 Series  
LLA Series  
LLL Series  
LLM Series  
LLR Series  
⚠Caution/ Notice

# GRM Series Temperature Compensating Type Part Number List

(→ ■ 0.6x0.3mm)

| T max. | Rated Voltage | TC Code | Cap.  | Tol.    | Part Number        |
|--------|---------------|---------|-------|---------|--------------------|
| 0.33mm | 100Vdc        | C0G     | 5.7pF | ±0.25pF | GRM0335C2A5R7CA01# |
|        |               |         |       | ±0.5pF  | GRM0335C2A5R7DA01# |
|        |               |         | 5.8pF | ±0.05pF | GRM0335C2A5R8WA01# |
|        |               |         |       | ±0.1pF  | GRM0335C2A5R8BA01# |
|        |               |         |       | ±0.25pF | GRM0335C2A5R8CA01# |
|        |               |         |       | ±0.5pF  | GRM0335C2A5R8DA01# |
|        |               |         | 5.9pF | ±0.05pF | GRM0335C2A5R9WA01# |
|        |               |         |       | ±0.1pF  | GRM0335C2A5R9BA01# |
|        |               |         |       | ±0.25pF | GRM0335C2A5R9CA01# |
|        |               |         |       | ±0.5pF  | GRM0335C2A5R9DA01# |
|        |               |         | 6.0pF | ±0.05pF | GRM0335C2A6R0WA01# |
|        |               |         |       | ±0.1pF  | GRM0335C2A6R0BA01# |
|        |               |         |       | ±0.25pF | GRM0335C2A6R0CA01# |
|        |               |         |       | ±0.5pF  | GRM0335C2A6R0DA01# |
|        |               |         | 6.1pF | ±0.05pF | GRM0335C2A6R1WA01# |
|        |               |         |       | ±0.1pF  | GRM0335C2A6R1BA01# |
|        |               |         |       | ±0.25pF | GRM0335C2A6R1CA01# |
|        |               |         |       | ±0.5pF  | GRM0335C2A6R1DA01# |
|        |               |         | 6.2pF | ±0.05pF | GRM0335C2A6R2WA01# |
|        |               |         |       | ±0.1pF  | GRM0335C2A6R2BA01# |
|        |               |         |       | ±0.25pF | GRM0335C2A6R2CA01# |
|        |               |         |       | ±0.5pF  | GRM0335C2A6R2DA01# |
|        |               |         | 6.3pF | ±0.05pF | GRM0335C2A6R3WA01# |
|        |               |         |       | ±0.1pF  | GRM0335C2A6R3BA01# |
|        |               |         |       | ±0.25pF | GRM0335C2A6R3CA01# |
|        |               |         |       | ±0.5pF  | GRM0335C2A6R3DA01# |
|        |               |         | 6.4pF | ±0.05pF | GRM0335C2A6R4WA01# |
|        |               |         |       | ±0.1pF  | GRM0335C2A6R4BA01# |
|        |               |         |       | ±0.25pF | GRM0335C2A6R4CA01# |
|        |               |         |       | ±0.5pF  | GRM0335C2A6R4DA01# |
|        |               |         | 6.5pF | ±0.05pF | GRM0335C2A6R5WA01# |
|        |               |         |       | ±0.1pF  | GRM0335C2A6R5BA01# |
|        |               |         |       | ±0.25pF | GRM0335C2A6R5CA01# |
|        |               |         |       | ±0.5pF  | GRM0335C2A6R5DA01# |
|        |               |         | 6.6pF | ±0.05pF | GRM0335C2A6R6WA01# |
|        |               |         |       | ±0.1pF  | GRM0335C2A6R6BA01# |
|        |               |         |       | ±0.25pF | GRM0335C2A6R6CA01# |
|        |               |         |       | ±0.5pF  | GRM0335C2A6R6DA01# |
|        |               |         | 6.7pF | ±0.05pF | GRM0335C2A6R7WA01# |
|        |               |         |       | ±0.1pF  | GRM0335C2A6R7BA01# |
|        |               |         |       | ±0.25pF | GRM0335C2A6R7CA01# |
|        |               |         |       | ±0.5pF  | GRM0335C2A6R7DA01# |
|        |               |         | 6.8pF | ±0.05pF | GRM0335C2A6R8WA01# |
|        |               |         |       | ±0.1pF  | GRM0335C2A6R8BA01# |
|        |               |         |       | ±0.25pF | GRM0335C2A6R8CA01# |
|        |               |         |       | ±0.5pF  | GRM0335C2A6R8DA01# |
|        |               |         | 6.9pF | ±0.05pF | GRM0335C2A6R9WA01# |
|        |               |         |       | ±0.1pF  | GRM0335C2A6R9BA01# |
|        |               |         |       | ±0.25pF | GRM0335C2A6R9CA01# |
|        |               |         |       | ±0.5pF  | GRM0335C2A6R9DA01# |
|        |               |         | 7.0pF | ±0.05pF | GRM0335C2A7R0WA01# |
|        |               |         |       | ±0.1pF  | GRM0335C2A7R0BA01# |
|        |               |         |       | ±0.25pF | GRM0335C2A7R0CA01# |
|        |               |         |       | ±0.5pF  | GRM0335C2A7R0DA01# |

| T max. | Rated Voltage | TC Code | Cap.  | Tol.    | Part Number        |
|--------|---------------|---------|-------|---------|--------------------|
| 0.33mm | 100Vdc        | C0G     | 7.1pF | ±0.05pF | GRM0335C2A7R1WA01# |
|        |               |         |       | ±0.1pF  | GRM0335C2A7R1BA01# |
|        |               |         |       | ±0.25pF | GRM0335C2A7R1CA01# |
|        |               |         |       | ±0.5pF  | GRM0335C2A7R1DA01# |
|        |               |         | 7.2pF | ±0.05pF | GRM0335C2A7R2WA01# |
|        |               |         |       | ±0.1pF  | GRM0335C2A7R2BA01# |
|        |               |         |       | ±0.25pF | GRM0335C2A7R2CA01# |
|        |               |         |       | ±0.5pF  | GRM0335C2A7R2DA01# |
|        |               |         | 7.3pF | ±0.05pF | GRM0335C2A7R3WA01# |
|        |               |         |       | ±0.1pF  | GRM0335C2A7R3BA01# |
|        |               |         |       | ±0.25pF | GRM0335C2A7R3CA01# |
|        |               |         |       | ±0.5pF  | GRM0335C2A7R3DA01# |
|        |               |         | 7.4pF | ±0.05pF | GRM0335C2A7R4WA01# |
|        |               |         |       | ±0.1pF  | GRM0335C2A7R4BA01# |
|        |               |         |       | ±0.25pF | GRM0335C2A7R4CA01# |
|        |               |         |       | ±0.5pF  | GRM0335C2A7R4DA01# |
|        |               |         | 7.5pF | ±0.05pF | GRM0335C2A7R5WA01# |
|        |               |         |       | ±0.1pF  | GRM0335C2A7R5BA01# |
|        |               |         |       | ±0.25pF | GRM0335C2A7R5CA01# |
|        |               |         |       | ±0.5pF  | GRM0335C2A7R5DA01# |
|        |               |         | 7.6pF | ±0.05pF | GRM0335C2A7R6WA01# |
|        |               |         |       | ±0.1pF  | GRM0335C2A7R6BA01# |
|        |               |         |       | ±0.25pF | GRM0335C2A7R6CA01# |
|        |               |         |       | ±0.5pF  | GRM0335C2A7R6DA01# |
|        |               |         | 7.7pF | ±0.05pF | GRM0335C2A7R7WA01# |
|        |               |         |       | ±0.1pF  | GRM0335C2A7R7BA01# |
|        |               |         |       | ±0.25pF | GRM0335C2A7R7CA01# |
|        |               |         |       | ±0.5pF  | GRM0335C2A7R7DA01# |
|        |               |         | 7.8pF | ±0.05pF | GRM0335C2A7R8WA01# |
|        |               |         |       | ±0.1pF  | GRM0335C2A7R8BA01# |
|        |               |         |       | ±0.25pF | GRM0335C2A7R8CA01# |
|        |               |         |       | ±0.5pF  | GRM0335C2A7R8DA01# |
|        |               |         | 7.9pF | ±0.05pF | GRM0335C2A7R9WA01# |
|        |               |         |       | ±0.1pF  | GRM0335C2A7R9BA01# |
|        |               |         |       | ±0.25pF | GRM0335C2A7R9CA01# |
|        |               |         |       | ±0.5pF  | GRM0335C2A7R9DA01# |
|        |               |         | 8.0pF | ±0.05pF | GRM0335C2A8R0WA01# |
|        |               |         |       | ±0.1pF  | GRM0335C2A8R0BA01# |
|        |               |         |       | ±0.25pF | GRM0335C2A8R0CA01# |
|        |               |         |       | ±0.5pF  | GRM0335C2A8R0DA01# |
|        |               |         | 8.1pF | ±0.05pF | GRM0335C2A8R1WA01# |
|        |               |         |       | ±0.1pF  | GRM0335C2A8R1BA01# |
|        |               |         |       | ±0.25pF | GRM0335C2A8R1CA01# |
|        |               |         |       | ±0.5pF  | GRM0335C2A8R1DA01# |
|        |               |         | 8.2pF | ±0.05pF | GRM0335C2A8R2WA01# |
|        |               |         |       | ±0.1pF  | GRM0335C2A8R2BA01# |
|        |               |         |       | ±0.25pF | GRM0335C2A8R2CA01# |
|        |               |         |       | ±0.5pF  | GRM0335C2A8R2DA01# |
|        |               |         | 8.3pF | ±0.05pF | GRM0335C2A8R3WA01# |
|        |               |         |       | ±0.1pF  | GRM0335C2A8R3BA01# |
|        |               |         |       | ±0.25pF | GRM0335C2A8R3CA01# |
|        |               |         |       | ±0.5pF  | GRM0335C2A8R3DA01# |
|        |               |         | 8.4pF | ±0.05pF | GRM0335C2A8R4WA01# |
|        |               |         |       | ±0.1pF  | GRM0335C2A8R4BA01# |

Part number # indicates the package specification code.

GRM Series  
 GJM Series  
 GMA Series  
 GMD Series  
 GQM Series  
 GRJ Series  
 GR3 Series  
 KRM Series  
 KR3 Series  
 LLA Series  
 LLL Series  
 LLM Series  
 LLR Series  
 ⚠Caution/  
 Notice

## GRM Series Temperature Compensating Type Part Number List

(→ ■ 0.6x0.3mm)

| T max. | Rated Voltage | TC Code | Cap.  | Tol.    | Part Number        |
|--------|---------------|---------|-------|---------|--------------------|
| 0.33mm | 100Vdc        | C0G     | 8.4pF | ±0.25pF | GRM0335C2A8R4CA01# |
|        |               |         |       | ±0.5pF  | GRM0335C2A8R4DA01# |
|        |               |         | 8.5pF | ±0.05pF | GRM0335C2A8R5WA01# |
|        |               |         |       | ±0.1pF  | GRM0335C2A8R5BA01# |
|        |               |         |       | ±0.25pF | GRM0335C2A8R5CA01# |
|        |               |         |       | ±0.5pF  | GRM0335C2A8R5DA01# |
|        |               |         | 8.6pF | ±0.05pF | GRM0335C2A8R6WA01# |
|        |               |         |       | ±0.1pF  | GRM0335C2A8R6BA01# |
|        |               |         |       | ±0.25pF | GRM0335C2A8R6CA01# |
|        |               |         |       | ±0.5pF  | GRM0335C2A8R6DA01# |
|        |               |         | 8.7pF | ±0.05pF | GRM0335C2A8R7WA01# |
|        |               |         |       | ±0.1pF  | GRM0335C2A8R7BA01# |
|        |               |         |       | ±0.25pF | GRM0335C2A8R7CA01# |
|        |               |         |       | ±0.5pF  | GRM0335C2A8R7DA01# |
|        |               |         | 8.8pF | ±0.05pF | GRM0335C2A8R8WA01# |
|        |               |         |       | ±0.1pF  | GRM0335C2A8R8BA01# |
|        |               |         |       | ±0.25pF | GRM0335C2A8R8CA01# |
|        |               |         |       | ±0.5pF  | GRM0335C2A8R8DA01# |
|        |               |         | 8.9pF | ±0.05pF | GRM0335C2A8R9WA01# |
|        |               |         |       | ±0.1pF  | GRM0335C2A8R9BA01# |
|        |               |         |       | ±0.25pF | GRM0335C2A8R9CA01# |
|        |               |         |       | ±0.5pF  | GRM0335C2A8R9DA01# |
|        |               |         | 9.0pF | ±0.05pF | GRM0335C2A9R0WA01# |
|        |               |         |       | ±0.1pF  | GRM0335C2A9R0BA01# |
|        |               |         |       | ±0.25pF | GRM0335C2A9R0CA01# |
|        |               |         |       | ±0.5pF  | GRM0335C2A9R0DA01# |
|        |               |         | 9.1pF | ±0.05pF | GRM0335C2A9R1WA01# |
|        |               |         |       | ±0.1pF  | GRM0335C2A9R1BA01# |
|        |               |         |       | ±0.25pF | GRM0335C2A9R1CA01# |
|        |               |         |       | ±0.5pF  | GRM0335C2A9R1DA01# |
|        |               |         | 9.2pF | ±0.05pF | GRM0335C2A9R2WA01# |
|        |               |         |       | ±0.1pF  | GRM0335C2A9R2BA01# |
|        |               |         |       | ±0.25pF | GRM0335C2A9R2CA01# |
|        |               |         |       | ±0.5pF  | GRM0335C2A9R2DA01# |
|        |               |         | 9.3pF | ±0.05pF | GRM0335C2A9R3WA01# |
|        |               |         |       | ±0.1pF  | GRM0335C2A9R3BA01# |
|        |               |         |       | ±0.25pF | GRM0335C2A9R3CA01# |
|        |               |         |       | ±0.5pF  | GRM0335C2A9R3DA01# |
|        |               |         | 9.4pF | ±0.05pF | GRM0335C2A9R4WA01# |
|        |               |         |       | ±0.1pF  | GRM0335C2A9R4BA01# |
|        |               |         |       | ±0.25pF | GRM0335C2A9R4CA01# |
|        |               |         |       | ±0.5pF  | GRM0335C2A9R4DA01# |
|        |               |         | 9.5pF | ±0.05pF | GRM0335C2A9R5WA01# |
|        |               |         |       | ±0.1pF  | GRM0335C2A9R5BA01# |
|        |               |         |       | ±0.25pF | GRM0335C2A9R5CA01# |
|        |               |         |       | ±0.5pF  | GRM0335C2A9R5DA01# |
|        |               |         | 9.6pF | ±0.05pF | GRM0335C2A9R6WA01# |
|        |               |         |       | ±0.1pF  | GRM0335C2A9R6BA01# |
|        |               |         |       | ±0.25pF | GRM0335C2A9R6CA01# |
|        |               |         |       | ±0.5pF  | GRM0335C2A9R6DA01# |
|        |               |         | 9.7pF | ±0.05pF | GRM0335C2A9R7WA01# |
|        |               |         |       | ±0.1pF  | GRM0335C2A9R7BA01# |
|        |               |         |       | ±0.25pF | GRM0335C2A9R7CA01# |
|        |               |         |       | ±0.5pF  | GRM0335C2A9R7DA01# |

| T max. | Rated Voltage | TC Code            | Cap.    | Tol.               | Part Number        |                    |
|--------|---------------|--------------------|---------|--------------------|--------------------|--------------------|
| 0.33mm | 100Vdc        | C0G                | 9.8pF   | ±0.05pF            | GRM0335C2A9R8WA01# |                    |
|        |               |                    |         | ±0.1pF             | GRM0335C2A9R8BA01# |                    |
|        |               |                    |         | ±0.25pF            | GRM0335C2A9R8CA01# |                    |
|        |               |                    |         | ±0.5pF             | GRM0335C2A9R8DA01# |                    |
|        |               |                    | 9.9pF   | ±0.05pF            | GRM0335C2A9R9WA01# |                    |
|        |               |                    |         | ±0.1pF             | GRM0335C2A9R9BA01# |                    |
|        |               |                    |         | ±0.25pF            | GRM0335C2A9R9CA01# |                    |
|        |               |                    | 10pF    | ±2%                | GRM0335C2A100GA01# |                    |
|        |               |                    |         | ±5%                | GRM0335C2A100JA01# |                    |
|        |               |                    |         | ±5%                | GRM0335C2A100JA01# |                    |
|        |               |                    | 12pF    | ±2%                | GRM0335C2A120GA01# |                    |
|        |               |                    |         | ±5%                | GRM0335C2A120JA01# |                    |
|        |               |                    | 15pF    | ±2%                | GRM0335C2A150GA01# |                    |
|        |               |                    |         | ±5%                | GRM0335C2A150JA01# |                    |
|        |               |                    | CK      | 0.10pF             | ±0.05pF            | GRM0334C2AR10WA01# |
|        |               |                    |         |                    | ±0.1pF             | GRM0334C2AR10BA01# |
|        |               |                    |         | 0.20pF             | ±0.05pF            | GRM0334C2AR20WA01# |
|        |               |                    |         |                    | ±0.1pF             | GRM0334C2AR20BA01# |
|        |               |                    |         | 0.30pF             | ±0.05pF            | GRM0334C2AR30WA01# |
|        |               |                    |         |                    | ±0.1pF             | GRM0334C2AR30BA01# |
|        |               |                    |         | 0.40pF             | ±0.05pF            | GRM0334C2AR40WA01# |
|        |               |                    |         |                    | ±0.1pF             | GRM0334C2AR40BA01# |
|        |               |                    |         | 0.50pF             | ±0.05pF            | GRM0334C2AR50WA01# |
|        |               |                    |         |                    | ±0.1pF             | GRM0334C2AR50BA01# |
|        |               | 0.60pF             |         | ±0.05pF            | GRM0334C2AR60WA01# |                    |
|        |               |                    |         | ±0.1pF             | GRM0334C2AR60BA01# |                    |
|        |               | 0.70pF             |         | ±0.05pF            | GRM0334C2AR70WA01# |                    |
|        |               |                    |         | ±0.1pF             | GRM0334C2AR70BA01# |                    |
|        |               | 0.80pF             |         | ±0.05pF            | GRM0334C2AR80WA01# |                    |
|        |               |                    |         | ±0.1pF             | GRM0334C2AR80BA01# |                    |
|        |               | 0.90pF             |         | ±0.05pF            | GRM0334C2AR90WA01# |                    |
|        |               |                    |         | ±0.1pF             | GRM0334C2AR90BA01# |                    |
|        |               | 1.0pF              |         | ±0.05pF            | GRM0334C2A1R0WA01# |                    |
|        |               |                    |         | ±0.1pF             | GRM0334C2A1R0BA01# |                    |
|        |               |                    |         | ±0.25pF            | GRM0334C2A1R0CA01# |                    |
|        |               |                    |         | ±0.25pF            | GRM0334C2A1R0CA01# |                    |
|        |               | 1.1pF              |         | ±0.05pF            | GRM0334C2A1R1WA01# |                    |
|        |               |                    |         | ±0.1pF             | GRM0334C2A1R1BA01# |                    |
|        |               |                    | ±0.25pF | GRM0334C2A1R1CA01# |                    |                    |
|        |               | 1.2pF              | ±0.05pF | GRM0334C2A1R2WA01# |                    |                    |
|        |               |                    | ±0.1pF  | GRM0334C2A1R2BA01# |                    |                    |
|        |               |                    | ±0.25pF | GRM0334C2A1R2CA01# |                    |                    |
|        |               | 1.3pF              | ±0.05pF | GRM0334C2A1R3WA01# |                    |                    |
|        |               |                    | ±0.1pF  | GRM0334C2A1R3BA01# |                    |                    |
|        |               |                    | ±0.25pF | GRM0334C2A1R3CA01# |                    |                    |
|        |               | 1.4pF              | ±0.05pF | GRM0334C2A1R4WA01# |                    |                    |
|        |               |                    | ±0.1pF  | GRM0334C2A1R4BA01# |                    |                    |
|        |               |                    | ±0.25pF | GRM0334C2A1R4CA01# |                    |                    |
|        |               | 1.5pF              | ±0.05pF | GRM0334C2A1R5WA01# |                    |                    |
|        |               |                    | ±0.1pF  | GRM0334C2A1R5BA01# |                    |                    |
|        |               |                    | ±0.25pF | GRM0334C2A1R5CA01# |                    |                    |
|        |               | 1.6pF              | ±0.05pF | GRM0334C2A1R6WA01# |                    |                    |
|        |               |                    | ±0.1pF  | GRM0334C2A1R6BA01# |                    |                    |
|        |               |                    | ±0.25pF | GRM0334C2A1R6CA01# |                    |                    |
| 1.7pF  | ±0.05pF       | GRM0334C2A1R7WA01# |         |                    |                    |                    |
|        | ±0.1pF        | GRM0334C2A1R7BA01# |         |                    |                    |                    |

Part number # indicates the package specification code.

GRM Series  
GJM Series  
GMA Series  
GMD Series  
GQM Series  
GRJ Series  
GR3 Series  
KRM Series  
KR3 Series  
LLA Series  
LLL Series  
LLM Series  
LLR Series  
⚠Caution/ Notice

# GRM Series Temperature Compensating Type Part Number List

(→ ■ 0.6x0.3mm)

| T max. | Rated Voltage | TC Code | Cap.    | Tol.               | Part Number        |                    |
|--------|---------------|---------|---------|--------------------|--------------------|--------------------|
| 0.33mm | 100Vdc        | CK      | 1.7pF   | ±0.25pF            | GRM0334C2A1R7CA01# |                    |
|        |               |         |         | ±0.05pF            | GRM0334C2A1R8WA01# |                    |
|        |               |         |         |                    | ±0.1pF             | GRM0334C2A1R8BA01# |
|        |               |         | ±0.25pF | GRM0334C2A1R8CA01# |                    |                    |
|        |               |         |         | 1.9pF              | ±0.05pF            | GRM0334C2A1R9WA01# |
|        |               |         |         |                    | ±0.1pF             | GRM0334C2A1R9BA01# |
|        |               |         | ±0.25pF |                    | GRM0334C2A1R9CA01# |                    |
|        |               |         | 2.0pF   | ±0.05pF            | GRM0334C2A2R0WA01# |                    |
|        |               |         |         | ±0.1pF             | GRM0334C2A2R0BA01# |                    |
|        |               |         |         | ±0.25pF            | GRM0334C2A2R0CA01# |                    |
|        |               |         | CJ      | 2.1pF              | ±0.05pF            | GRM0333C2A2R1WA01# |
|        |               |         |         |                    | ±0.1pF             | GRM0333C2A2R1BA01# |
|        |               |         |         |                    | ±0.25pF            | GRM0333C2A2R1CA01# |
|        |               |         |         | 2.2pF              | ±0.05pF            | GRM0333C2A2R2WA01# |
|        |               |         |         |                    | ±0.1pF             | GRM0333C2A2R2BA01# |
|        |               |         |         |                    | ±0.25pF            | GRM0333C2A2R2CA01# |
|        |               |         |         | 2.3pF              | ±0.05pF            | GRM0333C2A2R3WA01# |
|        |               |         |         |                    | ±0.1pF             | GRM0333C2A2R3BA01# |
|        |               | ±0.25pF |         |                    | GRM0333C2A2R3CA01# |                    |
|        |               | 2.4pF   | ±0.05pF | GRM0333C2A2R4WA01# |                    |                    |
|        |               |         | ±0.1pF  | GRM0333C2A2R4BA01# |                    |                    |
|        |               |         | ±0.25pF | GRM0333C2A2R4CA01# |                    |                    |
|        |               | 2.5pF   | ±0.05pF | GRM0333C2A2R5WA01# |                    |                    |
|        |               |         | ±0.1pF  | GRM0333C2A2R5BA01# |                    |                    |
|        |               |         | ±0.25pF | GRM0333C2A2R5CA01# |                    |                    |
|        |               | 2.6pF   | ±0.05pF | GRM0333C2A2R6WA01# |                    |                    |
|        |               |         | ±0.1pF  | GRM0333C2A2R6BA01# |                    |                    |
|        |               |         | ±0.25pF | GRM0333C2A2R6CA01# |                    |                    |
|        |               | 2.7pF   | ±0.05pF | GRM0333C2A2R7WA01# |                    |                    |
|        |               |         | ±0.1pF  | GRM0333C2A2R7BA01# |                    |                    |
|        |               |         | ±0.25pF | GRM0333C2A2R7CA01# |                    |                    |
|        |               | 2.8pF   | ±0.05pF | GRM0333C2A2R8WA01# |                    |                    |
|        |               |         | ±0.1pF  | GRM0333C2A2R8BA01# |                    |                    |
|        |               |         | ±0.25pF | GRM0333C2A2R8CA01# |                    |                    |
|        |               | 2.9pF   | ±0.05pF | GRM0333C2A2R9WA01# |                    |                    |
|        |               |         | ±0.1pF  | GRM0333C2A2R9BA01# |                    |                    |
|        |               |         | ±0.25pF | GRM0333C2A2R9CA01# |                    |                    |
|        |               | 3.0pF   | ±0.05pF | GRM0333C2A3R0WA01# |                    |                    |
|        |               |         | ±0.1pF  | GRM0333C2A3R0BA01# |                    |                    |
|        |               |         | ±0.25pF | GRM0333C2A3R0CA01# |                    |                    |
|        |               | 3.1pF   | ±0.05pF | GRM0333C2A3R1WA01# |                    |                    |
|        |               |         | ±0.1pF  | GRM0333C2A3R1BA01# |                    |                    |
|        |               |         | ±0.25pF | GRM0333C2A3R1CA01# |                    |                    |
|        |               | 3.2pF   | ±0.05pF | GRM0333C2A3R2WA01# |                    |                    |
|        |               |         | ±0.1pF  | GRM0333C2A3R2BA01# |                    |                    |
|        |               |         | ±0.25pF | GRM0333C2A3R2CA01# |                    |                    |
|        |               | 3.3pF   | ±0.05pF | GRM0333C2A3R3WA01# |                    |                    |
|        |               |         | ±0.1pF  | GRM0333C2A3R3BA01# |                    |                    |
|        |               |         | ±0.25pF | GRM0333C2A3R3CA01# |                    |                    |
|        |               | 3.4pF   | ±0.05pF | GRM0333C2A3R4WA01# |                    |                    |
|        |               |         | ±0.1pF  | GRM0333C2A3R4BA01# |                    |                    |
|        |               |         | ±0.25pF | GRM0333C2A3R4CA01# |                    |                    |
|        |               | 3.5pF   | ±0.05pF | GRM0333C2A3R5WA01# |                    |                    |
|        |               |         | ±0.1pF  | GRM0333C2A3R5BA01# |                    |                    |

| T max. | Rated Voltage | TC Code | Cap.    | Tol.               | Part Number        |                    |
|--------|---------------|---------|---------|--------------------|--------------------|--------------------|
| 0.33mm | 100Vdc        | CJ      | 3.5pF   | ±0.25pF            | GRM0333C2A3R5CA01# |                    |
|        |               |         |         | ±0.05pF            | GRM0333C2A3R6WA01# |                    |
|        |               |         |         |                    | ±0.1pF             | GRM0333C2A3R6BA01# |
|        |               |         | ±0.25pF | GRM0333C2A3R6CA01# |                    |                    |
|        |               |         |         | 3.7pF              | ±0.05pF            | GRM0333C2A3R7WA01# |
|        |               |         |         |                    | ±0.1pF             | GRM0333C2A3R7BA01# |
|        |               |         | ±0.25pF |                    | GRM0333C2A3R7CA01# |                    |
|        |               |         | 3.8pF   | ±0.05pF            | GRM0333C2A3R8WA01# |                    |
|        |               |         |         | ±0.1pF             | GRM0333C2A3R8BA01# |                    |
|        |               |         |         | ±0.25pF            | GRM0333C2A3R8CA01# |                    |
|        |               |         | 3.9pF   | ±0.05pF            | GRM0333C2A3R9WA01# |                    |
|        |               |         |         | ±0.1pF             | GRM0333C2A3R9BA01# |                    |
|        |               |         |         | ±0.25pF            | GRM0333C2A3R9CA01# |                    |
|        |               |         | CH      | 4.0pF              | ±0.05pF            | GRM0332C2A4R0WA01# |
|        |               |         |         |                    | ±0.1pF             | GRM0332C2A4R0BA01# |
|        |               |         |         |                    | ±0.25pF            | GRM0332C2A4R0CA01# |
|        |               |         |         | 4.1pF              | ±0.05pF            | GRM0332C2A4R1WA01# |
|        |               |         |         |                    | ±0.1pF             | GRM0332C2A4R1BA01# |
|        |               | ±0.25pF |         |                    | GRM0332C2A4R1CA01# |                    |
|        |               | 4.2pF   |         | ±0.05pF            | GRM0332C2A4R2WA01# |                    |
|        |               |         |         | ±0.1pF             | GRM0332C2A4R2BA01# |                    |
|        |               |         |         | ±0.25pF            | GRM0332C2A4R2CA01# |                    |
|        |               | 4.3pF   | ±0.05pF | GRM0332C2A4R3WA01# |                    |                    |
|        |               |         | ±0.1pF  | GRM0332C2A4R3BA01# |                    |                    |
|        |               |         | ±0.25pF | GRM0332C2A4R3CA01# |                    |                    |
|        |               | 4.4pF   | ±0.05pF | GRM0332C2A4R4WA01# |                    |                    |
|        |               |         | ±0.1pF  | GRM0332C2A4R4BA01# |                    |                    |
|        |               |         | ±0.25pF | GRM0332C2A4R4CA01# |                    |                    |
|        |               | 4.5pF   | ±0.05pF | GRM0332C2A4R5WA01# |                    |                    |
|        |               |         | ±0.1pF  | GRM0332C2A4R5BA01# |                    |                    |
|        |               |         | ±0.25pF | GRM0332C2A4R5CA01# |                    |                    |
|        |               | 4.6pF   | ±0.05pF | GRM0332C2A4R6WA01# |                    |                    |
|        |               |         | ±0.1pF  | GRM0332C2A4R6BA01# |                    |                    |
|        |               |         | ±0.25pF | GRM0332C2A4R6CA01# |                    |                    |
|        |               | 4.7pF   | ±0.05pF | GRM0332C2A4R7WA01# |                    |                    |
|        |               |         | ±0.1pF  | GRM0332C2A4R7BA01# |                    |                    |
|        |               |         | ±0.25pF | GRM0332C2A4R7CA01# |                    |                    |
|        |               | 4.8pF   | ±0.05pF | GRM0332C2A4R8WA01# |                    |                    |
|        |               |         | ±0.1pF  | GRM0332C2A4R8BA01# |                    |                    |
|        |               |         | ±0.25pF | GRM0332C2A4R8CA01# |                    |                    |
|        |               | 4.9pF   | ±0.05pF | GRM0332C2A4R9WA01# |                    |                    |
|        |               |         | ±0.1pF  | GRM0332C2A4R9BA01# |                    |                    |
|        |               |         | ±0.25pF | GRM0332C2A4R9CA01# |                    |                    |
|        |               | 5.0pF   | ±0.05pF | GRM0332C2A5R0WA01# |                    |                    |
|        |               |         | ±0.1pF  | GRM0332C2A5R0BA01# |                    |                    |
|        |               |         | ±0.25pF | GRM0332C2A5R0CA01# |                    |                    |
|        |               | 5.1pF   | ±0.05pF | GRM0332C2A5R1WA01# |                    |                    |
|        |               |         | ±0.1pF  | GRM0332C2A5R1BA01# |                    |                    |
|        |               |         | ±0.25pF | GRM0332C2A5R1CA01# |                    |                    |
|        |               | ±0.5pF  | ±0.5pF  | GRM0332C2A5R1DA01# |                    |                    |
|        |               |         | 5.2pF   | ±0.05pF            | GRM0332C2A5R2WA01# |                    |
|        |               |         |         | ±0.1pF             | GRM0332C2A5R2BA01# |                    |
|        |               | ±0.25pF |         | GRM0332C2A5R2CA01# |                    |                    |
|        |               | ±0.5pF  | ±0.5pF  | GRM0332C2A5R2DA01# |                    |                    |

Part number # indicates the package specification code.



## GRM Series Temperature Compensating Type Part Number List

(→ ■ 0.6x0.3mm)

| T max. | Rated Voltage | TC Code | Cap.  | Tol.    | Part Number        |
|--------|---------------|---------|-------|---------|--------------------|
| 0.33mm | 100Vdc        | CH      | 5.3pF | ±0.05pF | GRM0332C2A5R3WA01# |
|        |               |         |       | ±0.1pF  | GRM0332C2A5R3BA01# |
|        |               |         |       | ±0.25pF | GRM0332C2A5R3CA01# |
|        |               |         |       | ±0.5pF  | GRM0332C2A5R3DA01# |
|        |               |         | 5.4pF | ±0.05pF | GRM0332C2A5R4WA01# |
|        |               |         |       | ±0.1pF  | GRM0332C2A5R4BA01# |
|        |               |         |       | ±0.25pF | GRM0332C2A5R4CA01# |
|        |               |         |       | ±0.5pF  | GRM0332C2A5R4DA01# |
|        |               |         | 5.5pF | ±0.05pF | GRM0332C2A5R5WA01# |
|        |               |         |       | ±0.1pF  | GRM0332C2A5R5BA01# |
|        |               |         |       | ±0.25pF | GRM0332C2A5R5CA01# |
|        |               |         |       | ±0.5pF  | GRM0332C2A5R5DA01# |
|        |               |         | 5.6pF | ±0.05pF | GRM0332C2A5R6WA01# |
|        |               |         |       | ±0.1pF  | GRM0332C2A5R6BA01# |
|        |               |         |       | ±0.25pF | GRM0332C2A5R6CA01# |
|        |               |         |       | ±0.5pF  | GRM0332C2A5R6DA01# |
|        |               |         | 5.7pF | ±0.05pF | GRM0332C2A5R7WA01# |
|        |               |         |       | ±0.1pF  | GRM0332C2A5R7BA01# |
|        |               |         |       | ±0.25pF | GRM0332C2A5R7CA01# |
|        |               |         |       | ±0.5pF  | GRM0332C2A5R7DA01# |
|        |               |         | 5.8pF | ±0.05pF | GRM0332C2A5R8WA01# |
|        |               |         |       | ±0.1pF  | GRM0332C2A5R8BA01# |
|        |               |         |       | ±0.25pF | GRM0332C2A5R8CA01# |
|        |               |         |       | ±0.5pF  | GRM0332C2A5R8DA01# |
|        |               |         | 5.9pF | ±0.05pF | GRM0332C2A5R9WA01# |
|        |               |         |       | ±0.1pF  | GRM0332C2A5R9BA01# |
|        |               |         |       | ±0.25pF | GRM0332C2A5R9CA01# |
|        |               |         |       | ±0.5pF  | GRM0332C2A5R9DA01# |
|        |               |         | 6.0pF | ±0.05pF | GRM0332C2A6R0WA01# |
|        |               |         |       | ±0.1pF  | GRM0332C2A6R0BA01# |
|        |               |         |       | ±0.25pF | GRM0332C2A6R0CA01# |
|        |               |         |       | ±0.5pF  | GRM0332C2A6R0DA01# |
|        |               |         | 6.1pF | ±0.05pF | GRM0332C2A6R1WA01# |
|        |               |         |       | ±0.1pF  | GRM0332C2A6R1BA01# |
|        |               |         |       | ±0.25pF | GRM0332C2A6R1CA01# |
|        |               |         |       | ±0.5pF  | GRM0332C2A6R1DA01# |
|        |               |         | 6.2pF | ±0.05pF | GRM0332C2A6R2WA01# |
|        |               |         |       | ±0.1pF  | GRM0332C2A6R2BA01# |
|        |               |         |       | ±0.25pF | GRM0332C2A6R2CA01# |
|        |               |         |       | ±0.5pF  | GRM0332C2A6R2DA01# |
|        |               |         | 6.3pF | ±0.05pF | GRM0332C2A6R3WA01# |
|        |               |         |       | ±0.1pF  | GRM0332C2A6R3BA01# |
|        |               |         |       | ±0.25pF | GRM0332C2A6R3CA01# |
|        |               |         |       | ±0.5pF  | GRM0332C2A6R3DA01# |
|        |               |         | 6.4pF | ±0.05pF | GRM0332C2A6R4WA01# |
|        |               |         |       | ±0.1pF  | GRM0332C2A6R4BA01# |
|        |               |         |       | ±0.25pF | GRM0332C2A6R4CA01# |
|        |               |         |       | ±0.5pF  | GRM0332C2A6R4DA01# |
|        |               |         | 6.5pF | ±0.05pF | GRM0332C2A6R5WA01# |
|        |               |         |       | ±0.1pF  | GRM0332C2A6R5BA01# |
|        |               |         |       | ±0.25pF | GRM0332C2A6R5CA01# |
|        |               |         |       | ±0.5pF  | GRM0332C2A6R5DA01# |
|        |               |         | 6.6pF | ±0.05pF | GRM0332C2A6R6WA01# |
|        |               |         |       | ±0.1pF  | GRM0332C2A6R6BA01# |

| T max. | Rated Voltage | TC Code | Cap.  | Tol.    | Part Number        |        |                    |
|--------|---------------|---------|-------|---------|--------------------|--------|--------------------|
| 0.33mm | 100Vdc        | CH      | 6.6pF | ±0.25pF | GRM0332C2A6R6CA01# |        |                    |
|        |               |         |       | ±0.5pF  | GRM0332C2A6R6DA01# |        |                    |
|        |               |         | 6.7pF | ±0.05pF | GRM0332C2A6R7WA01# |        |                    |
|        |               |         |       | ±0.1pF  | GRM0332C2A6R7BA01# |        |                    |
|        |               |         |       | ±0.25pF | GRM0332C2A6R7CA01# |        |                    |
|        |               |         | 6.8pF | ±0.05pF | GRM0332C2A6R8WA01# |        |                    |
|        |               |         |       | ±0.1pF  | GRM0332C2A6R8BA01# |        |                    |
|        |               |         |       | ±0.25pF | GRM0332C2A6R8CA01# |        |                    |
|        |               |         | 6.9pF | ±0.05pF | GRM0332C2A6R9WA01# |        |                    |
|        |               |         |       | ±0.1pF  | GRM0332C2A6R9BA01# |        |                    |
|        |               |         |       | ±0.25pF | GRM0332C2A6R9CA01# |        |                    |
|        |               |         | 7.0pF | ±0.05pF | GRM0332C2A7R0WA01# |        |                    |
|        |               |         |       | ±0.1pF  | GRM0332C2A7R0BA01# |        |                    |
|        |               |         |       | ±0.25pF | GRM0332C2A7R0CA01# |        |                    |
|        |               |         | 7.1pF | ±0.05pF | GRM0332C2A7R1WA01# |        |                    |
|        |               |         |       | ±0.1pF  | GRM0332C2A7R1BA01# |        |                    |
|        |               |         |       | ±0.25pF | GRM0332C2A7R1CA01# |        |                    |
|        |               |         | 7.2pF | ±0.05pF | GRM0332C2A7R2WA01# |        |                    |
|        |               |         |       | ±0.1pF  | GRM0332C2A7R2BA01# |        |                    |
|        |               |         |       | ±0.25pF | GRM0332C2A7R2CA01# |        |                    |
|        |               |         | 7.3pF | ±0.05pF | GRM0332C2A7R3WA01# |        |                    |
|        |               |         |       | ±0.1pF  | GRM0332C2A7R3BA01# |        |                    |
|        |               |         |       | ±0.25pF | GRM0332C2A7R3CA01# |        |                    |
|        |               |         | 7.4pF | ±0.05pF | GRM0332C2A7R4WA01# |        |                    |
|        |               |         |       | ±0.1pF  | GRM0332C2A7R4BA01# |        |                    |
|        |               |         |       | ±0.25pF | GRM0332C2A7R4CA01# |        |                    |
|        |               |         | 7.5pF | ±0.05pF | GRM0332C2A7R5WA01# |        |                    |
|        |               |         |       | ±0.1pF  | GRM0332C2A7R5BA01# |        |                    |
|        |               |         |       | ±0.25pF | GRM0332C2A7R5CA01# |        |                    |
|        |               |         | 7.6pF | ±0.05pF | GRM0332C2A7R6WA01# |        |                    |
|        |               |         |       | ±0.1pF  | GRM0332C2A7R6BA01# |        |                    |
|        |               |         |       | ±0.25pF | GRM0332C2A7R6CA01# |        |                    |
|        |               |         | 7.7pF | ±0.05pF | GRM0332C2A7R7WA01# |        |                    |
|        |               |         |       | ±0.1pF  | GRM0332C2A7R7BA01# |        |                    |
|        |               |         |       | ±0.25pF | GRM0332C2A7R7CA01# |        |                    |
|        |               |         | 7.8pF | ±0.05pF | GRM0332C2A7R8WA01# |        |                    |
|        |               |         |       | ±0.1pF  | GRM0332C2A7R8BA01# |        |                    |
|        |               |         |       | ±0.25pF | GRM0332C2A7R8CA01# |        |                    |
|        |               |         | 7.9pF | ±0.05pF | GRM0332C2A7R9WA01# |        |                    |
|        |               |         |       | ±0.1pF  | GRM0332C2A7R9BA01# |        |                    |
|        |               |         |       | ±0.25pF | GRM0332C2A7R9CA01# |        |                    |
|        |               |         |       |         |                    | ±0.5pF | GRM0332C2A7R9DA01# |

Part number # indicates the package specification code.

GRM Series  
GJM Series  
GMA Series  
GMD Series  
GQM Series  
GRJ Series  
GR3 Series  
KRM Series  
KR3 Series  
LLA Series  
LLL Series  
LLM Series  
LLR Series  
⚠Caution/ Notice

## GRM Series Temperature Compensating Type Part Number List

(→ ■ 0.6x0.3mm)

| T max. | Rated Voltage | TC Code | Cap.  | Tol.    | Part Number        |
|--------|---------------|---------|-------|---------|--------------------|
| 0.33mm | 100Vdc        | CH      | 8.0pF | ±0.05pF | GRM0332C2A8R0WA01# |
|        |               |         |       | ±0.1pF  | GRM0332C2A8R0BA01# |
|        |               |         |       | ±0.25pF | GRM0332C2A8R0CA01# |
|        |               |         |       | ±0.5pF  | GRM0332C2A8R0DA01# |
|        |               |         | 8.1pF | ±0.05pF | GRM0332C2A8R1WA01# |
|        |               |         |       | ±0.1pF  | GRM0332C2A8R1BA01# |
|        |               |         |       | ±0.25pF | GRM0332C2A8R1CA01# |
|        |               |         |       | ±0.5pF  | GRM0332C2A8R1DA01# |
|        |               |         | 8.2pF | ±0.05pF | GRM0332C2A8R2WA01# |
|        |               |         |       | ±0.1pF  | GRM0332C2A8R2BA01# |
|        |               |         |       | ±0.25pF | GRM0332C2A8R2CA01# |
|        |               |         |       | ±0.5pF  | GRM0332C2A8R2DA01# |
|        |               |         | 8.3pF | ±0.05pF | GRM0332C2A8R3WA01# |
|        |               |         |       | ±0.1pF  | GRM0332C2A8R3BA01# |
|        |               |         |       | ±0.25pF | GRM0332C2A8R3CA01# |
|        |               |         |       | ±0.5pF  | GRM0332C2A8R3DA01# |
|        |               |         | 8.4pF | ±0.05pF | GRM0332C2A8R4WA01# |
|        |               |         |       | ±0.1pF  | GRM0332C2A8R4BA01# |
|        |               |         |       | ±0.25pF | GRM0332C2A8R4CA01# |
|        |               |         |       | ±0.5pF  | GRM0332C2A8R4DA01# |
|        |               |         | 8.5pF | ±0.05pF | GRM0332C2A8R5WA01# |
|        |               |         |       | ±0.1pF  | GRM0332C2A8R5BA01# |
|        |               |         |       | ±0.25pF | GRM0332C2A8R5CA01# |
|        |               |         |       | ±0.5pF  | GRM0332C2A8R5DA01# |
|        |               |         | 8.6pF | ±0.05pF | GRM0332C2A8R6WA01# |
|        |               |         |       | ±0.1pF  | GRM0332C2A8R6BA01# |
|        |               |         |       | ±0.25pF | GRM0332C2A8R6CA01# |
|        |               |         |       | ±0.5pF  | GRM0332C2A8R6DA01# |
|        |               |         | 8.7pF | ±0.05pF | GRM0332C2A8R7WA01# |
|        |               |         |       | ±0.1pF  | GRM0332C2A8R7BA01# |
|        |               |         |       | ±0.25pF | GRM0332C2A8R7CA01# |
|        |               |         |       | ±0.5pF  | GRM0332C2A8R7DA01# |
|        |               |         | 8.8pF | ±0.05pF | GRM0332C2A8R8WA01# |
|        |               |         |       | ±0.1pF  | GRM0332C2A8R8BA01# |
|        |               |         |       | ±0.25pF | GRM0332C2A8R8CA01# |
|        |               |         |       | ±0.5pF  | GRM0332C2A8R8DA01# |
|        |               |         | 8.9pF | ±0.05pF | GRM0332C2A8R9WA01# |
|        |               |         |       | ±0.1pF  | GRM0332C2A8R9BA01# |
|        |               |         |       | ±0.25pF | GRM0332C2A8R9CA01# |
|        |               |         |       | ±0.5pF  | GRM0332C2A8R9DA01# |
|        |               |         | 9.0pF | ±0.05pF | GRM0332C2A9R0WA01# |
|        |               |         |       | ±0.1pF  | GRM0332C2A9R0BA01# |
|        |               |         |       | ±0.25pF | GRM0332C2A9R0CA01# |
|        |               |         |       | ±0.5pF  | GRM0332C2A9R0DA01# |
|        |               |         | 9.1pF | ±0.05pF | GRM0332C2A9R1WA01# |
|        |               |         |       | ±0.1pF  | GRM0332C2A9R1BA01# |
|        |               |         |       | ±0.25pF | GRM0332C2A9R1CA01# |
|        |               |         |       | ±0.5pF  | GRM0332C2A9R1DA01# |
|        |               |         | 9.2pF | ±0.05pF | GRM0332C2A9R2WA01# |
|        |               |         |       | ±0.1pF  | GRM0332C2A9R2BA01# |
|        |               |         |       | ±0.25pF | GRM0332C2A9R2CA01# |
|        |               |         |       | ±0.5pF  | GRM0332C2A9R2DA01# |
|        |               |         | 9.3pF | ±0.05pF | GRM0332C2A9R3WA01# |
|        |               |         |       | ±0.1pF  | GRM0332C2A9R3BA01# |

| T max. | Rated Voltage      | TC Code | Cap.  | Tol.    | Part Number        |         |                    |
|--------|--------------------|---------|-------|---------|--------------------|---------|--------------------|
| 0.33mm | 100Vdc             | CH      | 9.3pF | ±0.25pF | GRM0332C2A9R3CA01# |         |                    |
|        |                    |         |       | ±0.5pF  | GRM0332C2A9R3DA01# |         |                    |
|        |                    |         | 9.4pF | ±0.05pF | GRM0332C2A9R4WA01# |         |                    |
|        |                    |         |       | ±0.1pF  | GRM0332C2A9R4BA01# |         |                    |
|        |                    |         |       | ±0.25pF | GRM0332C2A9R4CA01# |         |                    |
|        |                    |         | 9.5pF | ±0.05pF | GRM0332C2A9R5WA01# |         |                    |
|        |                    |         |       | ±0.1pF  | GRM0332C2A9R5BA01# |         |                    |
|        |                    |         |       | ±0.25pF | GRM0332C2A9R5CA01# |         |                    |
|        |                    |         | 9.6pF | ±0.05pF | GRM0332C2A9R6WA01# |         |                    |
|        |                    |         |       | ±0.1pF  | GRM0332C2A9R6BA01# |         |                    |
|        |                    |         |       | ±0.25pF | GRM0332C2A9R6CA01# |         |                    |
|        |                    |         | 9.7pF | ±0.05pF | GRM0332C2A9R7WA01# |         |                    |
|        |                    |         |       | ±0.1pF  | GRM0332C2A9R7BA01# |         |                    |
|        |                    |         |       | ±0.25pF | GRM0332C2A9R7CA01# |         |                    |
|        |                    |         | 9.8pF | ±0.05pF | GRM0332C2A9R8WA01# |         |                    |
|        |                    |         |       | ±0.1pF  | GRM0332C2A9R8BA01# |         |                    |
|        |                    |         |       | ±0.25pF | GRM0332C2A9R8CA01# |         |                    |
|        |                    |         | 9.9pF | ±0.05pF | GRM0332C2A9R9WA01# |         |                    |
|        |                    |         |       | ±0.1pF  | GRM0332C2A9R9BA01# |         |                    |
|        |                    |         |       | ±0.25pF | GRM0332C2A9R9CA01# |         |                    |
|        |                    |         | 10pF  | ±2%     | GRM0332C2A100GA01# |         |                    |
|        |                    |         |       | ±5%     | GRM0332C2A100JA01# |         |                    |
|        |                    |         | 12pF  | ±2%     | GRM0332C2A120GA01# |         |                    |
|        |                    |         |       | ±5%     | GRM0332C2A120JA01# |         |                    |
|        |                    |         | 15pF  | ±2%     | GRM0332C2A150GA01# |         |                    |
|        |                    |         |       | ±5%     | GRM0332C2A150JA01# |         |                    |
|        |                    |         | 50Vdc | C0G     | 0.10pF             | ±0.05pF | GRM0335C1HR10WA01# |
|        |                    |         |       |         |                    | ±0.05pF | GRM0335C1HR20WA01# |
|        |                    |         |       |         | 0.20pF             | ±0.05pF | GRM0335C1HR20BA01# |
|        |                    |         |       |         |                    | ±0.1pF  | GRM0335C1HR20CA01# |
|        |                    |         |       |         | 0.30pF             | ±0.05pF | GRM0335C1HR30WA01# |
|        |                    |         |       |         |                    | ±0.1pF  | GRM0335C1HR30BA01# |
|        |                    |         |       |         | 0.40pF             | ±0.05pF | GRM0335C1HR40WA01# |
|        |                    |         |       |         |                    | ±0.1pF  | GRM0335C1HR40BA01# |
|        |                    |         |       |         | 0.50pF             | ±0.05pF | GRM0335C1HR50WA01# |
|        |                    |         |       |         |                    | ±0.1pF  | GRM0335C1HR50BA01# |
|        |                    |         |       |         | 0.60pF             | ±0.05pF | GRM0335C1HR60WA01# |
|        |                    |         |       |         |                    | ±0.1pF  | GRM0335C1HR60BA01# |
|        |                    |         |       |         | 0.70pF             | ±0.05pF | GRM0335C1HR70WA01# |
|        |                    |         |       |         |                    | ±0.1pF  | GRM0335C1HR70BA01# |
|        |                    |         |       |         | 0.80pF             | ±0.05pF | GRM0335C1HR80WA01# |
|        |                    |         |       |         |                    | ±0.1pF  | GRM0335C1HR80BA01# |
|        |                    |         |       |         | 0.90pF             | ±0.05pF | GRM0335C1HR90WA01# |
|        |                    |         |       |         |                    | ±0.1pF  | GRM0335C1HR90BA01# |
|        |                    |         |       |         | 1.0pF              | ±0.05pF | GRM0335C1H1R0WA01# |
|        |                    |         |       |         |                    | ±0.1pF  | GRM0335C1H1R0BA01# |
|        |                    |         |       |         |                    | ±0.25pF | GRM0335C1H1R0CA01# |
|        |                    |         |       |         | 1.1pF              | ±0.05pF | GRM0335C1H1R1WA01# |
| ±0.1pF | GRM0335C1H1R1BA01# |         |       |         |                    |         |                    |

Part number # indicates the package specification code.

## GRM Series Temperature Compensating Type Part Number List

(→ ■ 0.6x0.3mm)

| T max. | Rated Voltage | TC Code | Cap.    | Tol.               | Part Number        |                    |
|--------|---------------|---------|---------|--------------------|--------------------|--------------------|
| 0.33mm | 50Vdc         | COG     | 1.1pF   | ±0.25pF            | GRM0335C1H1R1CA01# |                    |
|        |               |         |         | ±0.05pF            | GRM0335C1H1R2WA01# |                    |
|        |               |         |         |                    | ±0.1pF             | GRM0335C1H1R2BA01# |
|        |               |         | ±0.25pF | GRM0335C1H1R2CA01# |                    |                    |
|        |               |         |         | 1.3pF              | ±0.05pF            | GRM0335C1H1R3WA01# |
|        |               |         |         |                    | ±0.1pF             | GRM0335C1H1R3BA01# |
|        |               |         | ±0.25pF |                    | GRM0335C1H1R3CA01# |                    |
|        |               |         | 1.4pF   | ±0.05pF            | GRM0335C1H1R4WA01# |                    |
|        |               |         |         | ±0.1pF             | GRM0335C1H1R4BA01# |                    |
|        |               |         |         | ±0.25pF            | GRM0335C1H1R4CA01# |                    |
|        |               |         | 1.5pF   | ±0.05pF            | GRM0335C1H1R5WA01# |                    |
|        |               |         |         | ±0.1pF             | GRM0335C1H1R5BA01# |                    |
|        |               |         |         | ±0.25pF            | GRM0335C1H1R5CA01# |                    |
|        |               |         | 1.6pF   | ±0.05pF            | GRM0335C1H1R6WA01# |                    |
|        |               |         |         | ±0.1pF             | GRM0335C1H1R6BA01# |                    |
|        |               |         |         | ±0.25pF            | GRM0335C1H1R6CA01# |                    |
|        |               |         | 1.7pF   | ±0.05pF            | GRM0335C1H1R7WA01# |                    |
|        |               |         |         | ±0.1pF             | GRM0335C1H1R7BA01# |                    |
|        |               |         |         | ±0.25pF            | GRM0335C1H1R7CA01# |                    |
|        |               |         | 1.8pF   | ±0.05pF            | GRM0335C1H1R8WA01# |                    |
|        |               |         |         | ±0.1pF             | GRM0335C1H1R8BA01# |                    |
|        |               |         |         | ±0.25pF            | GRM0335C1H1R8CA01# |                    |
|        |               |         | 1.9pF   | ±0.05pF            | GRM0335C1H1R9WA01# |                    |
|        |               |         |         | ±0.1pF             | GRM0335C1H1R9BA01# |                    |
|        |               |         |         | ±0.25pF            | GRM0335C1H1R9CA01# |                    |
|        |               |         | 2.0pF   | ±0.05pF            | GRM0335C1H2R0WA01# |                    |
|        |               |         |         | ±0.1pF             | GRM0335C1H2R0BA01# |                    |
|        |               |         |         | ±0.25pF            | GRM0335C1H2R0CA01# |                    |
|        |               |         | 2.1pF   | ±0.05pF            | GRM0335C1H2R1WA01# |                    |
|        |               |         |         | ±0.1pF             | GRM0335C1H2R1BA01# |                    |
|        |               |         |         | ±0.25pF            | GRM0335C1H2R1CA01# |                    |
|        |               |         | 2.2pF   | ±0.05pF            | GRM0335C1H2R2WA01# |                    |
|        |               |         |         | ±0.1pF             | GRM0335C1H2R2BA01# |                    |
|        |               |         |         | ±0.25pF            | GRM0335C1H2R2CA01# |                    |
|        |               |         | 2.3pF   | ±0.05pF            | GRM0335C1H2R3WA01# |                    |
|        |               |         |         | ±0.1pF             | GRM0335C1H2R3BA01# |                    |
|        |               |         |         | ±0.25pF            | GRM0335C1H2R3CA01# |                    |
|        |               |         | 2.4pF   | ±0.05pF            | GRM0335C1H2R4WA01# |                    |
|        |               |         |         | ±0.1pF             | GRM0335C1H2R4BA01# |                    |
|        |               |         |         | ±0.25pF            | GRM0335C1H2R4CA01# |                    |
|        |               |         | 2.5pF   | ±0.05pF            | GRM0335C1H2R5WA01# |                    |
|        |               |         |         | ±0.1pF             | GRM0335C1H2R5BA01# |                    |
|        |               |         |         | ±0.25pF            | GRM0335C1H2R5CA01# |                    |
|        |               |         | 2.6pF   | ±0.05pF            | GRM0335C1H2R6WA01# |                    |
|        |               |         |         | ±0.1pF             | GRM0335C1H2R6BA01# |                    |
|        |               |         |         | ±0.25pF            | GRM0335C1H2R6CA01# |                    |
|        |               |         | 2.7pF   | ±0.05pF            | GRM0335C1H2R7WA01# |                    |
|        |               |         |         | ±0.1pF             | GRM0335C1H2R7BA01# |                    |
|        |               |         |         | ±0.25pF            | GRM0335C1H2R7CA01# |                    |
|        |               |         | 2.8pF   | ±0.05pF            | GRM0335C1H2R8WA01# |                    |
|        |               |         |         | ±0.1pF             | GRM0335C1H2R8BA01# |                    |
|        |               |         |         | ±0.25pF            | GRM0335C1H2R8CA01# |                    |
|        |               |         | 2.9pF   | ±0.05pF            | GRM0335C1H2R9WA01# |                    |
|        |               |         |         | ±0.1pF             | GRM0335C1H2R9BA01# |                    |

| T max. | Rated Voltage | TC Code | Cap.    | Tol.               | Part Number        |                    |
|--------|---------------|---------|---------|--------------------|--------------------|--------------------|
| 0.33mm | 50Vdc         | COG     | 2.9pF   | ±0.25pF            | GRM0335C1H2R9CA01# |                    |
|        |               |         |         | ±0.05pF            | GRM0335C1H3R0WA01# |                    |
|        |               |         |         |                    | ±0.1pF             | GRM0335C1H3R0BA01# |
|        |               |         | ±0.25pF | GRM0335C1H3R0CA01# |                    |                    |
|        |               |         |         | 3.1pF              | ±0.05pF            | GRM0335C1H3R1WA01# |
|        |               |         |         |                    | ±0.1pF             | GRM0335C1H3R1BA01# |
|        |               |         | ±0.25pF |                    | GRM0335C1H3R1CA01# |                    |
|        |               |         | 3.2pF   | ±0.05pF            | GRM0335C1H3R2WA01# |                    |
|        |               |         |         | ±0.1pF             | GRM0335C1H3R2BA01# |                    |
|        |               |         |         | ±0.25pF            | GRM0335C1H3R2CA01# |                    |
|        |               |         | 3.3pF   | ±0.05pF            | GRM0335C1H3R3WA01# |                    |
|        |               |         |         | ±0.1pF             | GRM0335C1H3R3BA01# |                    |
|        |               |         |         | ±0.25pF            | GRM0335C1H3R3CA01# |                    |
|        |               |         | 3.4pF   | ±0.05pF            | GRM0335C1H3R4WA01# |                    |
|        |               |         |         | ±0.1pF             | GRM0335C1H3R4BA01# |                    |
|        |               |         |         | ±0.25pF            | GRM0335C1H3R4CA01# |                    |
|        |               |         | 3.5pF   | ±0.05pF            | GRM0335C1H3R5WA01# |                    |
|        |               |         |         | ±0.1pF             | GRM0335C1H3R5BA01# |                    |
|        |               |         |         | ±0.25pF            | GRM0335C1H3R5CA01# |                    |
|        |               |         | 3.6pF   | ±0.05pF            | GRM0335C1H3R6WA01# |                    |
|        |               |         |         | ±0.1pF             | GRM0335C1H3R6BA01# |                    |
|        |               |         |         | ±0.25pF            | GRM0335C1H3R6CA01# |                    |
|        |               |         | 3.7pF   | ±0.05pF            | GRM0335C1H3R7WA01# |                    |
|        |               |         |         | ±0.1pF             | GRM0335C1H3R7BA01# |                    |
|        |               |         |         | ±0.25pF            | GRM0335C1H3R7CA01# |                    |
|        |               |         | 3.8pF   | ±0.05pF            | GRM0335C1H3R8WA01# |                    |
|        |               |         |         | ±0.1pF             | GRM0335C1H3R8BA01# |                    |
|        |               |         |         | ±0.25pF            | GRM0335C1H3R8CA01# |                    |
|        |               |         | 3.9pF   | ±0.05pF            | GRM0335C1H3R9WA01# |                    |
|        |               |         |         | ±0.1pF             | GRM0335C1H3R9BA01# |                    |
|        |               |         |         | ±0.25pF            | GRM0335C1H3R9CA01# |                    |
|        |               |         | 4.0pF   | ±0.05pF            | GRM0335C1H4R0WA01# |                    |
|        |               |         |         | ±0.1pF             | GRM0335C1H4R0BA01# |                    |
|        |               |         |         | ±0.25pF            | GRM0335C1H4R0CA01# |                    |
|        |               |         | 4.1pF   | ±0.05pF            | GRM0335C1H4R1WA01# |                    |
|        |               |         |         | ±0.1pF             | GRM0335C1H4R1BA01# |                    |
|        |               |         |         | ±0.25pF            | GRM0335C1H4R1CA01# |                    |
|        |               |         | 4.2pF   | ±0.05pF            | GRM0335C1H4R2WA01# |                    |
|        |               |         |         | ±0.1pF             | GRM0335C1H4R2BA01# |                    |
|        |               |         |         | ±0.25pF            | GRM0335C1H4R2CA01# |                    |
|        |               |         | 4.3pF   | ±0.05pF            | GRM0335C1H4R3WA01# |                    |
|        |               |         |         | ±0.1pF             | GRM0335C1H4R3BA01# |                    |
|        |               |         |         | ±0.25pF            | GRM0335C1H4R3CA01# |                    |
|        |               |         | 4.4pF   | ±0.05pF            | GRM0335C1H4R4WA01# |                    |
|        |               |         |         | ±0.1pF             | GRM0335C1H4R4BA01# |                    |
|        |               |         |         | ±0.25pF            | GRM0335C1H4R4CA01# |                    |
|        |               |         | 4.5pF   | ±0.05pF            | GRM0335C1H4R5WA01# |                    |
|        |               |         |         | ±0.1pF             | GRM0335C1H4R5BA01# |                    |
|        |               |         |         | ±0.25pF            | GRM0335C1H4R5CA01# |                    |
|        |               |         | 4.6pF   | ±0.05pF            | GRM0335C1H4R6WA01# |                    |
|        |               |         |         | ±0.1pF             | GRM0335C1H4R6BA01# |                    |
|        |               |         |         | ±0.25pF            | GRM0335C1H4R6CA01# |                    |
|        |               |         | 4.7pF   | ±0.05pF            | GRM0335C1H4R7WA01# |                    |
|        |               |         |         | ±0.1pF             | GRM0335C1H4R7BA01# |                    |

Part number # indicates the package specification code.

GRM Series  
GJM Series  
GMA Series  
GMD Series  
GQM Series  
GRJ Series  
GR3 Series  
KRM Series  
KR3 Series  
LLA Series  
LLM Series  
LLR Series  
⚠Caution/ Notice

## GRM Series Temperature Compensating Type Part Number List

(→ ■ 0.6x0.3mm)

| T max. | Rated Voltage | TC Code | Cap.  | Tol.    | Part Number        |                    |
|--------|---------------|---------|-------|---------|--------------------|--------------------|
| 0.33mm | 50Vdc         | COG     | 4.7pF | ±0.25pF | GRM0335C1H4R7CA01# |                    |
|        |               |         |       | ±0.05pF | GRM0335C1H4R8WA01# |                    |
|        |               |         |       |         | ±0.1pF             | GRM0335C1H4R8BA01# |
|        |               |         |       |         | ±0.25pF            | GRM0335C1H4R8CA01# |
|        |               |         | 4.9pF | ±0.05pF | GRM0335C1H4R9WA01# |                    |
|        |               |         |       | ±0.1pF  | GRM0335C1H4R9BA01# |                    |
|        |               |         |       | ±0.25pF | GRM0335C1H4R9CA01# |                    |
|        |               |         | 5.0pF | ±0.05pF | GRM0335C1H5R0WA01# |                    |
|        |               |         |       | ±0.1pF  | GRM0335C1H5R0BA01# |                    |
|        |               |         |       | ±0.25pF | GRM0335C1H5R0CA01# |                    |
|        |               |         | 5.1pF | ±0.05pF | GRM0335C1H5R1WA01# |                    |
|        |               |         |       | ±0.1pF  | GRM0335C1H5R1BA01# |                    |
|        |               |         |       | ±0.25pF | GRM0335C1H5R1CA01# |                    |
|        |               |         |       | ±0.5pF  | GRM0335C1H5R1DA01# |                    |
|        |               |         | 5.2pF | ±0.05pF | GRM0335C1H5R2WA01# |                    |
|        |               |         |       | ±0.1pF  | GRM0335C1H5R2BA01# |                    |
|        |               |         |       | ±0.25pF | GRM0335C1H5R2CA01# |                    |
|        |               |         |       | ±0.5pF  | GRM0335C1H5R2DA01# |                    |
|        |               |         | 5.3pF | ±0.05pF | GRM0335C1H5R3WA01# |                    |
|        |               |         |       | ±0.1pF  | GRM0335C1H5R3BA01# |                    |
|        |               |         |       | ±0.25pF | GRM0335C1H5R3CA01# |                    |
|        |               |         |       | ±0.5pF  | GRM0335C1H5R3DA01# |                    |
|        |               |         | 5.4pF | ±0.05pF | GRM0335C1H5R4WA01# |                    |
|        |               |         |       | ±0.1pF  | GRM0335C1H5R4BA01# |                    |
|        |               |         |       | ±0.25pF | GRM0335C1H5R4CA01# |                    |
|        |               |         |       | ±0.5pF  | GRM0335C1H5R4DA01# |                    |
|        |               |         | 5.5pF | ±0.05pF | GRM0335C1H5R5WA01# |                    |
|        |               |         |       | ±0.1pF  | GRM0335C1H5R5BA01# |                    |
|        |               |         |       | ±0.25pF | GRM0335C1H5R5CA01# |                    |
|        |               |         |       | ±0.5pF  | GRM0335C1H5R5DA01# |                    |
|        |               |         | 5.6pF | ±0.05pF | GRM0335C1H5R6WA01# |                    |
|        |               |         |       | ±0.1pF  | GRM0335C1H5R6BA01# |                    |
|        |               |         |       | ±0.25pF | GRM0335C1H5R6CA01# |                    |
|        |               |         |       | ±0.5pF  | GRM0335C1H5R6DA01# |                    |
|        |               |         | 5.7pF | ±0.05pF | GRM0335C1H5R7WA01# |                    |
|        |               |         |       | ±0.1pF  | GRM0335C1H5R7BA01# |                    |
|        |               |         |       | ±0.25pF | GRM0335C1H5R7CA01# |                    |
|        |               |         |       | ±0.5pF  | GRM0335C1H5R7DA01# |                    |
|        |               |         | 5.8pF | ±0.05pF | GRM0335C1H5R8WA01# |                    |
|        |               |         |       | ±0.1pF  | GRM0335C1H5R8BA01# |                    |
|        |               |         |       | ±0.25pF | GRM0335C1H5R8CA01# |                    |
|        |               |         |       | ±0.5pF  | GRM0335C1H5R8DA01# |                    |
|        |               |         | 5.9pF | ±0.05pF | GRM0335C1H5R9WA01# |                    |
|        |               |         |       | ±0.1pF  | GRM0335C1H5R9BA01# |                    |
|        |               |         |       | ±0.25pF | GRM0335C1H5R9CA01# |                    |
|        |               |         |       | ±0.5pF  | GRM0335C1H5R9DA01# |                    |
|        |               |         | 6.0pF | ±0.05pF | GRM0335C1H6R0WA01# |                    |
|        |               |         |       | ±0.1pF  | GRM0335C1H6R0BA01# |                    |
|        |               |         |       | ±0.25pF | GRM0335C1H6R0CA01# |                    |
|        |               |         |       | ±0.5pF  | GRM0335C1H6R0DA01# |                    |
|        |               |         | 6.1pF | ±0.05pF | GRM0335C1H6R1WA01# |                    |
|        |               |         |       | ±0.1pF  | GRM0335C1H6R1BA01# |                    |
|        |               |         |       | ±0.25pF | GRM0335C1H6R1CA01# |                    |
|        |               |         |       | ±0.5pF  | GRM0335C1H6R1DA01# |                    |

| T max. | Rated Voltage | TC Code | Cap.  | Tol.    | Part Number        |
|--------|---------------|---------|-------|---------|--------------------|
| 0.33mm | 50Vdc         | COG     | 6.2pF | ±0.05pF | GRM0335C1H6R2WA01# |
|        |               |         |       | ±0.1pF  | GRM0335C1H6R2BA01# |
|        |               |         |       | ±0.25pF | GRM0335C1H6R2CA01# |
|        |               |         |       | ±0.5pF  | GRM0335C1H6R2DA01# |
|        |               |         | 6.3pF | ±0.05pF | GRM0335C1H6R3WA01# |
|        |               |         |       | ±0.1pF  | GRM0335C1H6R3BA01# |
|        |               |         |       | ±0.25pF | GRM0335C1H6R3CA01# |
|        |               |         |       | ±0.5pF  | GRM0335C1H6R3DA01# |
|        |               |         | 6.4pF | ±0.05pF | GRM0335C1H6R4WA01# |
|        |               |         |       | ±0.1pF  | GRM0335C1H6R4BA01# |
|        |               |         |       | ±0.25pF | GRM0335C1H6R4CA01# |
|        |               |         |       | ±0.5pF  | GRM0335C1H6R4DA01# |
|        |               |         | 6.5pF | ±0.05pF | GRM0335C1H6R5WA01# |
|        |               |         |       | ±0.1pF  | GRM0335C1H6R5BA01# |
|        |               |         |       | ±0.25pF | GRM0335C1H6R5CA01# |
|        |               |         |       | ±0.5pF  | GRM0335C1H6R5DA01# |
|        |               |         | 6.6pF | ±0.05pF | GRM0335C1H6R6WA01# |
|        |               |         |       | ±0.1pF  | GRM0335C1H6R6BA01# |
|        |               |         |       | ±0.25pF | GRM0335C1H6R6CA01# |
|        |               |         |       | ±0.5pF  | GRM0335C1H6R6DA01# |
|        |               |         | 6.7pF | ±0.05pF | GRM0335C1H6R7WA01# |
|        |               |         |       | ±0.1pF  | GRM0335C1H6R7BA01# |
|        |               |         |       | ±0.25pF | GRM0335C1H6R7CA01# |
|        |               |         |       | ±0.5pF  | GRM0335C1H6R7DA01# |
|        |               |         | 6.8pF | ±0.05pF | GRM0335C1H6R8WA01# |
|        |               |         |       | ±0.1pF  | GRM0335C1H6R8BA01# |
|        |               |         |       | ±0.25pF | GRM0335C1H6R8CA01# |
|        |               |         |       | ±0.5pF  | GRM0335C1H6R8DA01# |
|        |               |         | 6.9pF | ±0.05pF | GRM0335C1H6R9WA01# |
|        |               |         |       | ±0.1pF  | GRM0335C1H6R9BA01# |
|        |               |         |       | ±0.25pF | GRM0335C1H6R9CA01# |
|        |               |         |       | ±0.5pF  | GRM0335C1H6R9DA01# |
|        |               |         | 7.0pF | ±0.05pF | GRM0335C1H7R0WA01# |
|        |               |         |       | ±0.1pF  | GRM0335C1H7R0BA01# |
|        |               |         |       | ±0.25pF | GRM0335C1H7R0CA01# |
|        |               |         |       | ±0.5pF  | GRM0335C1H7R0DA01# |
|        |               |         | 7.1pF | ±0.05pF | GRM0335C1H7R1WA01# |
|        |               |         |       | ±0.1pF  | GRM0335C1H7R1BA01# |
|        |               |         |       | ±0.25pF | GRM0335C1H7R1CA01# |
|        |               |         |       | ±0.5pF  | GRM0335C1H7R1DA01# |
|        |               |         | 7.2pF | ±0.05pF | GRM0335C1H7R2WA01# |
|        |               |         |       | ±0.1pF  | GRM0335C1H7R2BA01# |
|        |               |         |       | ±0.25pF | GRM0335C1H7R2CA01# |
|        |               |         |       | ±0.5pF  | GRM0335C1H7R2DA01# |
|        |               |         | 7.3pF | ±0.05pF | GRM0335C1H7R3WA01# |
|        |               |         |       | ±0.1pF  | GRM0335C1H7R3BA01# |
|        |               |         |       | ±0.25pF | GRM0335C1H7R3CA01# |
|        |               |         |       | ±0.5pF  | GRM0335C1H7R3DA01# |
|        |               |         | 7.4pF | ±0.05pF | GRM0335C1H7R4WA01# |
|        |               |         |       | ±0.1pF  | GRM0335C1H7R4BA01# |
|        |               |         |       | ±0.25pF | GRM0335C1H7R4CA01# |
|        |               |         |       | ±0.5pF  | GRM0335C1H7R4DA01# |
|        |               |         | 7.5pF | ±0.05pF | GRM0335C1H7R5WA01# |
|        |               |         |       | ±0.1pF  | GRM0335C1H7R5BA01# |

Part number # indicates the package specification code.

GRM Series  
 GJM Series  
 GMA Series  
 GMD Series  
 GQM Series  
 GRJ Series  
 GR3 Series  
 KRM Series  
 KR3 Series  
 LLA Series  
 LLL Series  
 LLM Series  
 LLR Series  
 ⚠Caution/  
 Notice

## GRM Series Temperature Compensating Type Part Number List

(→ ■ 0.6x0.3mm)

| T max.  | Rated Voltage      | TC Code            | Cap.  | Tol.    | Part Number        |
|---------|--------------------|--------------------|-------|---------|--------------------|
| 0.33mm  | 50Vdc              | C0G                | 7.5pF | ±0.25pF | GRM0335C1H7R5CA01# |
|         |                    |                    |       | ±0.5pF  | GRM0335C1H7R5DA01# |
|         |                    |                    | 7.6pF | ±0.05pF | GRM0335C1H7R6WA01# |
|         |                    |                    |       | ±0.1pF  | GRM0335C1H7R6BA01# |
|         |                    |                    |       | ±0.25pF | GRM0335C1H7R6CA01# |
|         |                    |                    |       | ±0.5pF  | GRM0335C1H7R6DA01# |
|         |                    |                    | 7.7pF | ±0.05pF | GRM0335C1H7R7WA01# |
|         |                    |                    |       | ±0.1pF  | GRM0335C1H7R7BA01# |
|         |                    |                    |       | ±0.25pF | GRM0335C1H7R7CA01# |
|         |                    |                    |       | ±0.5pF  | GRM0335C1H7R7DA01# |
|         |                    |                    | 7.8pF | ±0.05pF | GRM0335C1H7R8WA01# |
|         |                    |                    |       | ±0.1pF  | GRM0335C1H7R8BA01# |
|         |                    |                    |       | ±0.25pF | GRM0335C1H7R8CA01# |
|         |                    |                    |       | ±0.5pF  | GRM0335C1H7R8DA01# |
|         |                    |                    | 7.9pF | ±0.05pF | GRM0335C1H7R9WA01# |
|         |                    |                    |       | ±0.1pF  | GRM0335C1H7R9BA01# |
|         |                    |                    |       | ±0.25pF | GRM0335C1H7R9CA01# |
|         |                    |                    |       | ±0.5pF  | GRM0335C1H7R9DA01# |
|         |                    |                    | 8.0pF | ±0.05pF | GRM0335C1H8R0WA01# |
|         |                    |                    |       | ±0.1pF  | GRM0335C1H8R0BA01# |
|         |                    |                    |       | ±0.25pF | GRM0335C1H8R0CA01# |
|         |                    |                    |       | ±0.5pF  | GRM0335C1H8R0DA01# |
|         |                    |                    | 8.1pF | ±0.05pF | GRM0335C1H8R1WA01# |
|         |                    |                    |       | ±0.1pF  | GRM0335C1H8R1BA01# |
|         |                    |                    |       | ±0.25pF | GRM0335C1H8R1CA01# |
|         |                    |                    |       | ±0.5pF  | GRM0335C1H8R1DA01# |
|         |                    |                    | 8.2pF | ±0.05pF | GRM0335C1H8R2WA01# |
|         |                    |                    |       | ±0.1pF  | GRM0335C1H8R2BA01# |
|         |                    |                    |       | ±0.25pF | GRM0335C1H8R2CA01# |
|         |                    |                    |       | ±0.5pF  | GRM0335C1H8R2DA01# |
|         |                    |                    | 8.3pF | ±0.05pF | GRM0335C1H8R3WA01# |
|         |                    |                    |       | ±0.1pF  | GRM0335C1H8R3BA01# |
|         |                    |                    |       | ±0.25pF | GRM0335C1H8R3CA01# |
|         |                    |                    |       | ±0.5pF  | GRM0335C1H8R3DA01# |
|         |                    |                    | 8.4pF | ±0.05pF | GRM0335C1H8R4WA01# |
|         |                    |                    |       | ±0.1pF  | GRM0335C1H8R4BA01# |
|         |                    |                    |       | ±0.25pF | GRM0335C1H8R4CA01# |
|         |                    |                    |       | ±0.5pF  | GRM0335C1H8R4DA01# |
|         |                    |                    | 8.5pF | ±0.05pF | GRM0335C1H8R5WA01# |
|         |                    |                    |       | ±0.1pF  | GRM0335C1H8R5BA01# |
|         |                    |                    |       | ±0.25pF | GRM0335C1H8R5CA01# |
|         |                    |                    |       | ±0.5pF  | GRM0335C1H8R5DA01# |
|         |                    |                    | 8.6pF | ±0.05pF | GRM0335C1H8R6WA01# |
|         |                    |                    |       | ±0.1pF  | GRM0335C1H8R6BA01# |
|         |                    |                    |       | ±0.25pF | GRM0335C1H8R6CA01# |
|         |                    |                    |       | ±0.5pF  | GRM0335C1H8R6DA01# |
|         |                    |                    | 8.7pF | ±0.05pF | GRM0335C1H8R7WA01# |
|         |                    |                    |       | ±0.1pF  | GRM0335C1H8R7BA01# |
| ±0.25pF | GRM0335C1H8R7CA01# |                    |       |         |                    |
| ±0.5pF  | GRM0335C1H8R7DA01# |                    |       |         |                    |
| 8.8pF   | ±0.05pF            | GRM0335C1H8R8WA01# |       |         |                    |
|         | ±0.1pF             | GRM0335C1H8R8BA01# |       |         |                    |
|         | ±0.25pF            | GRM0335C1H8R8CA01# |       |         |                    |
|         | ±0.5pF             | GRM0335C1H8R8DA01# |       |         |                    |

| T max. | Rated Voltage | TC Code | Cap.  | Tol.    | Part Number        |
|--------|---------------|---------|-------|---------|--------------------|
| 0.33mm | 50Vdc         | C0G     | 8.9pF | ±0.05pF | GRM0335C1H8R9WA01# |
|        |               |         |       | ±0.1pF  | GRM0335C1H8R9BA01# |
|        |               |         |       | ±0.25pF | GRM0335C1H8R9CA01# |
|        |               |         |       | ±0.5pF  | GRM0335C1H8R9DA01# |
|        |               |         | 9.0pF | ±0.05pF | GRM0335C1H9R0WA01# |
|        |               |         |       | ±0.1pF  | GRM0335C1H9R0BA01# |
|        |               |         |       | ±0.25pF | GRM0335C1H9R0CA01# |
|        |               |         | 9.1pF | ±0.05pF | GRM0335C1H9R1WA01# |
|        |               |         |       | ±0.1pF  | GRM0335C1H9R1BA01# |
|        |               |         |       | ±0.25pF | GRM0335C1H9R1CA01# |
|        |               |         | 9.2pF | ±0.05pF | GRM0335C1H9R2WA01# |
|        |               |         |       | ±0.1pF  | GRM0335C1H9R2BA01# |
|        |               |         |       | ±0.25pF | GRM0335C1H9R2CA01# |
|        |               |         | 9.3pF | ±0.05pF | GRM0335C1H9R3WA01# |
|        |               |         |       | ±0.1pF  | GRM0335C1H9R3BA01# |
|        |               |         |       | ±0.25pF | GRM0335C1H9R3CA01# |
|        |               |         | 9.4pF | ±0.05pF | GRM0335C1H9R4WA01# |
|        |               |         |       | ±0.1pF  | GRM0335C1H9R4BA01# |
|        |               |         |       | ±0.25pF | GRM0335C1H9R4CA01# |
|        |               |         | 9.5pF | ±0.05pF | GRM0335C1H9R5WA01# |
|        |               |         |       | ±0.1pF  | GRM0335C1H9R5BA01# |
|        |               |         |       | ±0.25pF | GRM0335C1H9R5CA01# |
|        |               |         | 9.6pF | ±0.05pF | GRM0335C1H9R6WA01# |
|        |               |         |       | ±0.1pF  | GRM0335C1H9R6BA01# |
|        |               |         |       | ±0.25pF | GRM0335C1H9R6CA01# |
|        |               |         | 9.7pF | ±0.05pF | GRM0335C1H9R7WA01# |
|        |               |         |       | ±0.1pF  | GRM0335C1H9R7BA01# |
|        |               |         |       | ±0.25pF | GRM0335C1H9R7CA01# |
|        |               |         | 9.8pF | ±0.05pF | GRM0335C1H9R8WA01# |
|        |               |         |       | ±0.1pF  | GRM0335C1H9R8BA01# |
|        |               |         |       | ±0.25pF | GRM0335C1H9R8CA01# |
|        |               |         | 9.9pF | ±0.05pF | GRM0335C1H9R9WA01# |
|        |               |         |       | ±0.1pF  | GRM0335C1H9R9BA01# |
|        |               |         |       | ±0.25pF | GRM0335C1H9R9CA01# |
|        |               |         | 10pF  | ±2%     | GRM0335C1H100GA01# |
|        |               |         |       | ±5%     | GRM0335C1H100JA01# |
|        |               |         | 12pF  | ±2%     | GRM0335C1H120GA01# |
|        |               |         |       | ±5%     | GRM0335C1H120JA01# |
|        |               |         | 15pF  | ±2%     | GRM0335C1H150GA01# |
|        |               |         |       | ±5%     | GRM0335C1H150JA01# |
|        |               |         | 18pF  | ±2%     | GRM0335C1H180GA01# |
|        |               |         |       | ±5%     | GRM0335C1H180JA01# |
|        |               |         | 22pF  | ±2%     | GRM0335C1H220GA01# |
|        |               |         |       | ±5%     | GRM0335C1H220JA01# |

Part number # indicates the package specification code.

GRM Series  
GJM Series  
GMA Series  
GMD Series  
GQM Series  
GRJ Series  
GR3 Series  
KRM Series  
KR3 Series  
LLA Series  
LLL Series  
LLM Series  
LLR Series  
⚠Caution/Notice

# GRM Series Temperature Compensating Type Part Number List

(→ ■ 0.6x0.3mm)

| T max. | Rated Voltage | TC Code            | Cap.  | Tol. | Part Number        |         |                    |
|--------|---------------|--------------------|-------|------|--------------------|---------|--------------------|
| 0.33mm | 50Vdc         | COG                | 27pF  | ±2%  | GRM0335C1H270GA01# |         |                    |
|        |               |                    |       | ±5%  | GRM0335C1H270JA01# |         |                    |
|        |               |                    | 33pF  | ±2%  | GRM0335C1H330GA01# |         |                    |
|        |               |                    |       | ±5%  | GRM0335C1H330JA01# |         |                    |
|        |               |                    | 39pF  | ±2%  | GRM0335C1H390GA01# |         |                    |
|        |               |                    |       | ±5%  | GRM0335C1H390JA01# |         |                    |
|        |               |                    | 47pF  | ±2%  | GRM0335C1H470GA01# |         |                    |
|        |               |                    |       | ±5%  | GRM0335C1H470JA01# |         |                    |
|        |               |                    | 56pF  | ±2%  | GRM0335C1H560GA01# |         |                    |
|        |               |                    |       | ±5%  | GRM0335C1H560JA01# |         |                    |
|        |               |                    | 68pF  | ±2%  | GRM0335C1H680GA01# |         |                    |
|        |               |                    |       | ±5%  | GRM0335C1H680JA01# |         |                    |
|        |               |                    | 82pF  | ±2%  | GRM0335C1H820GA01# |         |                    |
|        |               |                    |       | ±5%  | GRM0335C1H820JA01# |         |                    |
|        |               |                    | 100pF | ±2%  | GRM0335C1H101GA01# |         |                    |
|        |               |                    |       | ±5%  | GRM0335C1H101JA01# |         |                    |
|        |               |                    | 120pF | ±2%  | GRM0335C1H121GA01# |         |                    |
|        |               |                    |       | ±5%  | GRM0335C1H121JA01# |         |                    |
|        |               |                    | 150pF | ±2%  | GRM0335C1H151GA01# |         |                    |
|        |               |                    |       | ±5%  | GRM0335C1H151JA01# |         |                    |
|        |               |                    | 180pF | ±2%  | GRM0335C1H181GA01# |         |                    |
|        |               |                    |       | ±5%  | GRM0335C1H181JA01# |         |                    |
|        |               |                    | 220pF | ±2%  | GRM0335C1H221GA01# |         |                    |
|        |               |                    |       | ±5%  | GRM0335C1H221JA01# |         |                    |
|        |               | CK                 | 50Vdc | CK   | 0.10pF             | ±0.05pF | GRM0334C1HR10WA01# |
|        |               |                    |       |      |                    | ±0.1pF  | GRM0334C1HR10BA01# |
|        |               |                    |       |      | 0.20pF             | ±0.05pF | GRM0334C1HR20WA01# |
|        |               |                    |       |      |                    | ±0.1pF  | GRM0334C1HR20BA01# |
|        |               |                    |       |      | 0.30pF             | ±0.05pF | GRM0334C1HR30WA01# |
|        |               |                    |       |      |                    | ±0.1pF  | GRM0334C1HR30BA01# |
|        |               |                    |       |      | 0.40pF             | ±0.05pF | GRM0334C1HR40WA01# |
|        |               |                    |       |      |                    | ±0.1pF  | GRM0334C1HR40BA01# |
|        |               |                    |       |      | 0.50pF             | ±0.05pF | GRM0334C1HR50WA01# |
|        |               |                    |       |      |                    | ±0.1pF  | GRM0334C1HR50BA01# |
|        |               |                    |       |      | 0.60pF             | ±0.05pF | GRM0334C1HR60WA01# |
|        |               |                    |       |      |                    | ±0.1pF  | GRM0334C1HR60BA01# |
|        |               |                    |       |      | 0.70pF             | ±0.05pF | GRM0334C1HR70WA01# |
|        |               |                    |       |      |                    | ±0.1pF  | GRM0334C1HR70BA01# |
|        |               |                    |       |      | 0.80pF             | ±0.05pF | GRM0334C1HR80WA01# |
|        |               |                    |       |      |                    | ±0.1pF  | GRM0334C1HR80BA01# |
|        |               |                    |       |      | 0.90pF             | ±0.05pF | GRM0334C1HR90WA01# |
|        |               |                    |       |      |                    | ±0.1pF  | GRM0334C1HR90BA01# |
|        |               |                    |       |      | 1.0pF              | ±0.05pF | GRM0334C1H1R0WA01# |
|        |               |                    |       |      |                    | ±0.1pF  | GRM0334C1H1R0BA01# |
|        |               |                    |       |      |                    | ±0.25pF | GRM0334C1H1R0CA01# |
|        |               |                    |       |      | 1.1pF              | ±0.05pF | GRM0334C1H1R1WA01# |
|        |               |                    |       |      |                    | ±0.1pF  | GRM0334C1H1R1BA01# |
|        |               |                    |       |      |                    | ±0.25pF | GRM0334C1H1R1CA01# |
| 1.2pF  | ±0.05pF       | GRM0334C1H1R2WA01# |       |      |                    |         |                    |
|        | ±0.1pF        | GRM0334C1H1R2BA01# |       |      |                    |         |                    |
|        | ±0.25pF       | GRM0334C1H1R2CA01# |       |      |                    |         |                    |
| 1.3pF  | ±0.05pF       | GRM0334C1H1R3WA01# |       |      |                    |         |                    |
|        | ±0.1pF        | GRM0334C1H1R3BA01# |       |      |                    |         |                    |
|        | ±0.25pF       | GRM0334C1H1R3CA01# |       |      |                    |         |                    |
| 1.4pF  | ±0.05pF       | GRM0334C1H1R4WA01# |       |      |                    |         |                    |

| T max. | Rated Voltage | TC Code | Cap.    | Tol.               | Part Number        |         |                    |                    |
|--------|---------------|---------|---------|--------------------|--------------------|---------|--------------------|--------------------|
| 0.33mm | 50Vdc         | CK      | 1.4pF   | ±0.1pF             | GRM0334C1H1R4BA01# |         |                    |                    |
|        |               |         |         | ±0.25pF            | GRM0334C1H1R4CA01# |         |                    |                    |
|        |               |         | 1.5pF   | ±0.05pF            | GRM0334C1H1R5WA01# |         |                    |                    |
|        |               |         |         | ±0.1pF             | GRM0334C1H1R5BA01# |         |                    |                    |
|        |               |         | 1.6pF   | ±0.05pF            | GRM0334C1H1R6WA01# |         |                    |                    |
|        |               |         |         | ±0.1pF             | GRM0334C1H1R6BA01# |         |                    |                    |
|        |               |         | 1.7pF   | ±0.05pF            | GRM0334C1H1R7WA01# |         |                    |                    |
|        |               |         |         | ±0.1pF             | GRM0334C1H1R7BA01# |         |                    |                    |
|        |               |         | 1.8pF   | ±0.05pF            | GRM0334C1H1R8WA01# |         |                    |                    |
|        |               |         |         | ±0.1pF             | GRM0334C1H1R8BA01# |         |                    |                    |
|        |               |         | 1.9pF   | ±0.05pF            | GRM0334C1H1R9WA01# |         |                    |                    |
|        |               |         |         | ±0.1pF             | GRM0334C1H1R9BA01# |         |                    |                    |
|        |               |         | 2.0pF   | ±0.05pF            | GRM0334C1H2R0WA01# |         |                    |                    |
|        |               |         |         | ±0.1pF             | GRM0334C1H2R0BA01# |         |                    |                    |
|        |               |         | CJ      | 50Vdc              | CJ                 | 2.1pF   | ±0.05pF            | GRM0333C1H2R1WA01# |
|        |               |         |         |                    |                    |         | ±0.1pF             | GRM0333C1H2R1BA01# |
|        |               |         |         |                    |                    | 2.2pF   | ±0.05pF            | GRM0333C1H2R2WA01# |
|        |               |         |         |                    |                    |         | ±0.1pF             | GRM0333C1H2R2BA01# |
|        |               |         |         |                    |                    | 2.3pF   | ±0.05pF            | GRM0333C1H2R3WA01# |
|        |               |         |         |                    |                    |         | ±0.1pF             | GRM0333C1H2R3BA01# |
|        |               |         |         |                    |                    | 2.4pF   | ±0.05pF            | GRM0333C1H2R4WA01# |
|        |               |         |         |                    |                    |         | ±0.1pF             | GRM0333C1H2R4BA01# |
|        |               |         |         |                    |                    | 2.5pF   | ±0.05pF            | GRM0333C1H2R5WA01# |
|        |               |         |         |                    |                    |         | ±0.1pF             | GRM0333C1H2R5BA01# |
|        |               | 2.6pF   |         |                    |                    | ±0.05pF | GRM0333C1H2R6WA01# |                    |
|        |               |         |         |                    |                    | ±0.1pF  | GRM0333C1H2R6BA01# |                    |
|        |               | 2.7pF   |         |                    |                    | ±0.05pF | GRM0333C1H2R7WA01# |                    |
|        |               |         |         |                    |                    | ±0.1pF  | GRM0333C1H2R7BA01# |                    |
|        |               | 2.8pF   |         |                    |                    | ±0.05pF | GRM0333C1H2R8WA01# |                    |
|        |               |         |         |                    |                    | ±0.1pF  | GRM0333C1H2R8BA01# |                    |
|        |               | 2.9pF   |         |                    |                    | ±0.05pF | GRM0333C1H2R9WA01# |                    |
|        |               |         |         |                    |                    | ±0.1pF  | GRM0333C1H2R9BA01# |                    |
|        |               | 3.0pF   |         |                    |                    | ±0.05pF | GRM0333C1H3R0WA01# |                    |
|        |               |         |         |                    |                    | ±0.1pF  | GRM0333C1H3R0BA01# |                    |
|        |               |         |         |                    |                    | ±0.25pF | GRM0333C1H3R0CA01# |                    |
|        |               | 3.1pF   |         |                    |                    | ±0.05pF | GRM0333C1H3R1WA01# |                    |
|        |               |         |         |                    |                    | ±0.1pF  | GRM0333C1H3R1BA01# |                    |
|        |               |         |         |                    |                    | ±0.25pF | GRM0333C1H3R1CA01# |                    |
|        |               | 3.2pF   | ±0.05pF | GRM0333C1H3R2WA01# |                    |         |                    |                    |

Part number # indicates the package specification code.

## GRM Series Temperature Compensating Type Part Number List

(→ ■ 0.6x0.3mm)

| T max. | Rated Voltage | TC Code            | Cap.  | Tol.    | Part Number        |                    |                    |
|--------|---------------|--------------------|-------|---------|--------------------|--------------------|--------------------|
| 0.33mm | 50Vdc         | CJ                 | 3.2pF | ±0.1pF  | GRM0333C1H3R2BA01# |                    |                    |
|        |               |                    |       | ±0.25pF | GRM0333C1H3R2CA01# |                    |                    |
|        |               |                    |       |         |                    |                    |                    |
|        |               |                    | 3.3pF | ±0.05pF | GRM0333C1H3R3WA01# |                    |                    |
|        |               |                    |       | ±0.1pF  | GRM0333C1H3R3BA01# |                    |                    |
|        |               |                    |       | ±0.25pF | GRM0333C1H3R3CA01# |                    |                    |
|        |               |                    | 3.4pF | ±0.05pF | GRM0333C1H3R4WA01# |                    |                    |
|        |               |                    |       | ±0.1pF  | GRM0333C1H3R4BA01# |                    |                    |
|        |               |                    |       | ±0.25pF | GRM0333C1H3R4CA01# |                    |                    |
|        |               |                    | 3.5pF | ±0.05pF | GRM0333C1H3R5WA01# |                    |                    |
|        |               |                    |       | ±0.1pF  | GRM0333C1H3R5BA01# |                    |                    |
|        |               |                    |       | ±0.25pF | GRM0333C1H3R5CA01# |                    |                    |
|        |               |                    | 3.6pF | ±0.05pF | GRM0333C1H3R6WA01# |                    |                    |
|        |               |                    |       | ±0.1pF  | GRM0333C1H3R6BA01# |                    |                    |
|        |               |                    |       | ±0.25pF | GRM0333C1H3R6CA01# |                    |                    |
|        |               |                    | 3.7pF | ±0.05pF | GRM0333C1H3R7WA01# |                    |                    |
|        |               |                    |       | ±0.1pF  | GRM0333C1H3R7BA01# |                    |                    |
|        |               |                    |       | ±0.25pF | GRM0333C1H3R7CA01# |                    |                    |
|        |               |                    | 3.8pF | ±0.05pF | GRM0333C1H3R8WA01# |                    |                    |
|        |               |                    |       | ±0.1pF  | GRM0333C1H3R8BA01# |                    |                    |
|        |               |                    |       | ±0.25pF | GRM0333C1H3R8CA01# |                    |                    |
|        |               |                    | 3.9pF | ±0.05pF | GRM0333C1H3R9WA01# |                    |                    |
|        |               |                    |       | ±0.1pF  | GRM0333C1H3R9BA01# |                    |                    |
|        |               |                    |       | ±0.25pF | GRM0333C1H3R9CA01# |                    |                    |
|        |               |                    | CH    | 50Vdc   | 4.0pF              | ±0.05pF            | GRM0332C1H4R0WA01# |
|        |               |                    |       |         |                    | ±0.1pF             | GRM0332C1H4R0BA01# |
|        |               |                    |       |         |                    | ±0.25pF            | GRM0332C1H4R0CA01# |
|        |               |                    |       |         | 4.1pF              | ±0.05pF            | GRM0332C1H4R1WA01# |
|        |               |                    |       |         |                    | ±0.1pF             | GRM0332C1H4R1BA01# |
|        |               |                    |       |         |                    | ±0.25pF            | GRM0332C1H4R1CA01# |
|        |               |                    |       |         | 4.2pF              | ±0.05pF            | GRM0332C1H4R2WA01# |
|        |               |                    |       |         |                    | ±0.1pF             | GRM0332C1H4R2BA01# |
|        |               |                    |       |         |                    | ±0.25pF            | GRM0332C1H4R2CA01# |
|        |               |                    |       |         | 4.3pF              | ±0.05pF            | GRM0332C1H4R3WA01# |
|        |               |                    |       |         |                    | ±0.1pF             | GRM0332C1H4R3BA01# |
|        |               |                    |       |         |                    | ±0.25pF            | GRM0332C1H4R3CA01# |
|        |               | 4.4pF              |       |         | ±0.05pF            | GRM0332C1H4R4WA01# |                    |
|        |               |                    |       |         | ±0.1pF             | GRM0332C1H4R4BA01# |                    |
|        |               |                    |       |         | ±0.25pF            | GRM0332C1H4R4CA01# |                    |
|        |               | 4.5pF              |       |         | ±0.05pF            | GRM0332C1H4R5WA01# |                    |
|        |               |                    |       |         | ±0.1pF             | GRM0332C1H4R5BA01# |                    |
|        |               |                    |       |         | ±0.25pF            | GRM0332C1H4R5CA01# |                    |
|        |               | 4.6pF              |       |         | ±0.05pF            | GRM0332C1H4R6WA01# |                    |
|        |               |                    |       |         | ±0.1pF             | GRM0332C1H4R6BA01# |                    |
|        |               |                    |       |         | ±0.25pF            | GRM0332C1H4R6CA01# |                    |
|        |               | 4.7pF              |       |         | ±0.05pF            | GRM0332C1H4R7WA01# |                    |
|        |               |                    |       |         | ±0.1pF             | GRM0332C1H4R7BA01# |                    |
|        |               |                    |       |         | ±0.25pF            | GRM0332C1H4R7CA01# |                    |
|        |               | 4.8pF              |       |         | ±0.05pF            | GRM0332C1H4R8WA01# |                    |
|        |               |                    |       |         | ±0.1pF             | GRM0332C1H4R8BA01# |                    |
|        |               |                    |       |         | ±0.25pF            | GRM0332C1H4R8CA01# |                    |
|        |               | 4.9pF              |       |         | ±0.05pF            | GRM0332C1H4R9WA01# |                    |
|        |               |                    |       |         | ±0.1pF             | GRM0332C1H4R9BA01# |                    |
|        |               |                    |       |         | ±0.25pF            | GRM0332C1H4R9CA01# |                    |
| 5.0pF  | ±0.05pF       | GRM0332C1H5R0WA01# |       |         |                    |                    |                    |

| T max. | Rated Voltage | TC Code | Cap.  | Tol.    | Part Number        |
|--------|---------------|---------|-------|---------|--------------------|
| 0.33mm | 50Vdc         | CH      | 5.0pF | ±0.1pF  | GRM0332C1H5R0BA01# |
|        |               |         |       | ±0.25pF | GRM0332C1H5R0CA01# |
|        |               |         |       |         |                    |
|        |               |         | 5.1pF | ±0.05pF | GRM0332C1H5R1WA01# |
|        |               |         |       | ±0.1pF  | GRM0332C1H5R1BA01# |
|        |               |         |       | ±0.25pF | GRM0332C1H5R1CA01# |
|        |               |         | 5.2pF | ±0.05pF | GRM0332C1H5R2WA01# |
|        |               |         |       | ±0.1pF  | GRM0332C1H5R2BA01# |
|        |               |         |       | ±0.25pF | GRM0332C1H5R2CA01# |
|        |               |         | 5.3pF | ±0.05pF | GRM0332C1H5R3WA01# |
|        |               |         |       | ±0.1pF  | GRM0332C1H5R3BA01# |
|        |               |         |       | ±0.25pF | GRM0332C1H5R3CA01# |
|        |               |         | 5.4pF | ±0.05pF | GRM0332C1H5R4WA01# |
|        |               |         |       | ±0.1pF  | GRM0332C1H5R4BA01# |
|        |               |         |       | ±0.25pF | GRM0332C1H5R4CA01# |
|        |               |         | 5.5pF | ±0.05pF | GRM0332C1H5R5WA01# |
|        |               |         |       | ±0.1pF  | GRM0332C1H5R5BA01# |
|        |               |         |       | ±0.25pF | GRM0332C1H5R5CA01# |
|        |               |         | 5.6pF | ±0.05pF | GRM0332C1H5R6WA01# |
|        |               |         |       | ±0.1pF  | GRM0332C1H5R6BA01# |
|        |               |         |       | ±0.25pF | GRM0332C1H5R6CA01# |
|        |               |         | 5.7pF | ±0.05pF | GRM0332C1H5R7WA01# |
|        |               |         |       | ±0.1pF  | GRM0332C1H5R7BA01# |
|        |               |         |       | ±0.25pF | GRM0332C1H5R7CA01# |
|        |               |         | 5.8pF | ±0.05pF | GRM0332C1H5R8WA01# |
|        |               |         |       | ±0.1pF  | GRM0332C1H5R8BA01# |
|        |               |         |       | ±0.25pF | GRM0332C1H5R8CA01# |
|        |               |         | 5.9pF | ±0.05pF | GRM0332C1H5R9WA01# |
|        |               |         |       | ±0.1pF  | GRM0332C1H5R9BA01# |
|        |               |         |       | ±0.25pF | GRM0332C1H5R9CA01# |
|        |               |         | 6.0pF | ±0.05pF | GRM0332C1H6R0WA01# |
|        |               |         |       | ±0.1pF  | GRM0332C1H6R0BA01# |
|        |               |         |       | ±0.25pF | GRM0332C1H6R0CA01# |
|        |               |         | 6.1pF | ±0.05pF | GRM0332C1H6R1WA01# |
|        |               |         |       | ±0.1pF  | GRM0332C1H6R1BA01# |
|        |               |         |       | ±0.25pF | GRM0332C1H6R1CA01# |
|        |               |         | 6.2pF | ±0.05pF | GRM0332C1H6R2WA01# |
|        |               |         |       | ±0.1pF  | GRM0332C1H6R2BA01# |
|        |               |         |       | ±0.25pF | GRM0332C1H6R2CA01# |
|        |               |         | 6.3pF | ±0.05pF | GRM0332C1H6R3WA01# |
|        |               |         |       | ±0.1pF  | GRM0332C1H6R3BA01# |
|        |               |         |       | ±0.25pF | GRM0332C1H6R3CA01# |
|        |               |         | 5.0pF | ±0.5pF  | GRM0332C1H6R3DA01# |

Part number # indicates the package specification code.

GRM Series  
GJM Series  
GMA Series  
GMD Series  
GQM Series  
GRJ Series  
GR3 Series  
KRM Series  
KR3 Series  
LLA Series  
LLL Series  
LLM Series  
LLR Series  
⚠Caution/Notice

## GRM Series Temperature Compensating Type Part Number List

(→ ■ 0.6x0.3mm)

| T max. | Rated Voltage | TC Code | Cap.  | Tol.    | Part Number        |
|--------|---------------|---------|-------|---------|--------------------|
| 0.33mm | 50Vdc         | CH      | 6.4pF | ±0.05pF | GRM0332C1H6R4WA01# |
|        |               |         |       | ±0.1pF  | GRM0332C1H6R4BA01# |
|        |               |         |       | ±0.25pF | GRM0332C1H6R4CA01# |
|        |               |         |       | ±0.5pF  | GRM0332C1H6R4DA01# |
|        |               |         | 6.5pF | ±0.05pF | GRM0332C1H6R5WA01# |
|        |               |         |       | ±0.1pF  | GRM0332C1H6R5BA01# |
|        |               |         |       | ±0.25pF | GRM0332C1H6R5CA01# |
|        |               |         |       | ±0.5pF  | GRM0332C1H6R5DA01# |
|        |               |         | 6.6pF | ±0.05pF | GRM0332C1H6R6WA01# |
|        |               |         |       | ±0.1pF  | GRM0332C1H6R6BA01# |
|        |               |         |       | ±0.25pF | GRM0332C1H6R6CA01# |
|        |               |         |       | ±0.5pF  | GRM0332C1H6R6DA01# |
|        |               |         | 6.7pF | ±0.05pF | GRM0332C1H6R7WA01# |
|        |               |         |       | ±0.1pF  | GRM0332C1H6R7BA01# |
|        |               |         |       | ±0.25pF | GRM0332C1H6R7CA01# |
|        |               |         |       | ±0.5pF  | GRM0332C1H6R7DA01# |
|        |               |         | 6.8pF | ±0.05pF | GRM0332C1H6R8WA01# |
|        |               |         |       | ±0.1pF  | GRM0332C1H6R8BA01# |
|        |               |         |       | ±0.25pF | GRM0332C1H6R8CA01# |
|        |               |         |       | ±0.5pF  | GRM0332C1H6R8DA01# |
|        |               |         | 6.9pF | ±0.05pF | GRM0332C1H6R9WA01# |
|        |               |         |       | ±0.1pF  | GRM0332C1H6R9BA01# |
|        |               |         |       | ±0.25pF | GRM0332C1H6R9CA01# |
|        |               |         |       | ±0.5pF  | GRM0332C1H6R9DA01# |
|        |               |         | 7.0pF | ±0.05pF | GRM0332C1H7R0WA01# |
|        |               |         |       | ±0.1pF  | GRM0332C1H7R0BA01# |
|        |               |         |       | ±0.25pF | GRM0332C1H7R0CA01# |
|        |               |         |       | ±0.5pF  | GRM0332C1H7R0DA01# |
|        |               |         | 7.1pF | ±0.05pF | GRM0332C1H7R1WA01# |
|        |               |         |       | ±0.1pF  | GRM0332C1H7R1BA01# |
|        |               |         |       | ±0.25pF | GRM0332C1H7R1CA01# |
|        |               |         |       | ±0.5pF  | GRM0332C1H7R1DA01# |
|        |               |         | 7.2pF | ±0.05pF | GRM0332C1H7R2WA01# |
|        |               |         |       | ±0.1pF  | GRM0332C1H7R2BA01# |
|        |               |         |       | ±0.25pF | GRM0332C1H7R2CA01# |
|        |               |         |       | ±0.5pF  | GRM0332C1H7R2DA01# |
|        |               |         | 7.3pF | ±0.05pF | GRM0332C1H7R3WA01# |
|        |               |         |       | ±0.1pF  | GRM0332C1H7R3BA01# |
|        |               |         |       | ±0.25pF | GRM0332C1H7R3CA01# |
|        |               |         |       | ±0.5pF  | GRM0332C1H7R3DA01# |
|        |               |         | 7.4pF | ±0.05pF | GRM0332C1H7R4WA01# |
|        |               |         |       | ±0.1pF  | GRM0332C1H7R4BA01# |
|        |               |         |       | ±0.25pF | GRM0332C1H7R4CA01# |
|        |               |         |       | ±0.5pF  | GRM0332C1H7R4DA01# |
|        |               |         | 7.5pF | ±0.05pF | GRM0332C1H7R5WA01# |
|        |               |         |       | ±0.1pF  | GRM0332C1H7R5BA01# |
|        |               |         |       | ±0.25pF | GRM0332C1H7R5CA01# |
|        |               |         |       | ±0.5pF  | GRM0332C1H7R5DA01# |
|        |               |         | 7.6pF | ±0.05pF | GRM0332C1H7R6WA01# |
|        |               |         |       | ±0.1pF  | GRM0332C1H7R6BA01# |
|        |               |         |       | ±0.25pF | GRM0332C1H7R6CA01# |
|        |               |         |       | ±0.5pF  | GRM0332C1H7R6DA01# |
|        |               |         | 7.7pF | ±0.05pF | GRM0332C1H7R7WA01# |
|        |               |         |       | ±0.1pF  | GRM0332C1H7R7BA01# |

| T max.  | Rated Voltage      | TC Code | Cap.  | Tol.    | Part Number        |
|---------|--------------------|---------|-------|---------|--------------------|
| 0.33mm  | 50Vdc              | CH      | 7.7pF | ±0.25pF | GRM0332C1H7R7CA01# |
|         |                    |         |       | ±0.5pF  | GRM0332C1H7R7DA01# |
|         |                    |         | 7.8pF | ±0.05pF | GRM0332C1H7R8WA01# |
|         |                    |         |       | ±0.1pF  | GRM0332C1H7R8BA01# |
|         |                    |         |       | ±0.25pF | GRM0332C1H7R8CA01# |
|         |                    |         | 7.9pF | ±0.05pF | GRM0332C1H7R9WA01# |
|         |                    |         |       | ±0.1pF  | GRM0332C1H7R9BA01# |
|         |                    |         |       | ±0.25pF | GRM0332C1H7R9CA01# |
|         |                    |         | 8.0pF | ±0.05pF | GRM0332C1H8R0WA01# |
|         |                    |         |       | ±0.1pF  | GRM0332C1H8R0BA01# |
|         |                    |         |       | ±0.25pF | GRM0332C1H8R0CA01# |
|         |                    |         | 8.1pF | ±0.05pF | GRM0332C1H8R1WA01# |
|         |                    |         |       | ±0.1pF  | GRM0332C1H8R1BA01# |
|         |                    |         |       | ±0.25pF | GRM0332C1H8R1CA01# |
|         |                    |         | 8.2pF | ±0.05pF | GRM0332C1H8R2WA01# |
|         |                    |         |       | ±0.1pF  | GRM0332C1H8R2BA01# |
|         |                    |         |       | ±0.25pF | GRM0332C1H8R2CA01# |
|         |                    |         | 8.3pF | ±0.05pF | GRM0332C1H8R3WA01# |
|         |                    |         |       | ±0.1pF  | GRM0332C1H8R3BA01# |
|         |                    |         |       | ±0.25pF | GRM0332C1H8R3CA01# |
|         |                    |         | 8.4pF | ±0.05pF | GRM0332C1H8R4WA01# |
|         |                    |         |       | ±0.1pF  | GRM0332C1H8R4BA01# |
|         |                    |         |       | ±0.25pF | GRM0332C1H8R4CA01# |
|         |                    |         | 8.5pF | ±0.05pF | GRM0332C1H8R5WA01# |
|         |                    |         |       | ±0.1pF  | GRM0332C1H8R5BA01# |
|         |                    |         |       | ±0.25pF | GRM0332C1H8R5CA01# |
|         |                    |         | 8.6pF | ±0.05pF | GRM0332C1H8R6WA01# |
|         |                    |         |       | ±0.1pF  | GRM0332C1H8R6BA01# |
|         |                    |         |       | ±0.25pF | GRM0332C1H8R6CA01# |
|         |                    |         | 8.7pF | ±0.05pF | GRM0332C1H8R7WA01# |
|         |                    |         |       | ±0.1pF  | GRM0332C1H8R7BA01# |
|         |                    |         |       | ±0.25pF | GRM0332C1H8R7CA01# |
|         |                    |         | 8.8pF | ±0.05pF | GRM0332C1H8R8WA01# |
|         |                    |         |       | ±0.1pF  | GRM0332C1H8R8BA01# |
|         |                    |         |       | ±0.25pF | GRM0332C1H8R8CA01# |
|         |                    |         | 8.9pF | ±0.05pF | GRM0332C1H8R9WA01# |
|         |                    |         |       | ±0.1pF  | GRM0332C1H8R9BA01# |
|         |                    |         |       | ±0.25pF | GRM0332C1H8R9CA01# |
|         |                    |         | 9.0pF | ±0.05pF | GRM0332C1H9R0WA01# |
|         |                    |         |       | ±0.1pF  | GRM0332C1H9R0BA01# |
| ±0.25pF | GRM0332C1H9R0CA01# |         |       |         |                    |

Part number # indicates the package specification code.

GRM Series  
 GJM Series  
 GMA Series  
 GMD Series  
 GQM Series  
 GRJ Series  
 GR3 Series  
 KRM Series  
 KR3 Series  
 LLA Series  
 LLL Series  
 LLM Series  
 LLR Series  
 △Caution/  
 Notice



## GRM Series Temperature Compensating Type Part Number List

(→ ■ 0.6x0.3mm)

| T max. | Rated Voltage | TC Code            | Cap.  | Tol.    | Part Number        |
|--------|---------------|--------------------|-------|---------|--------------------|
| 0.33mm | 50Vdc         | CH                 | 9.1pF | ±0.05pF | GRM0332C1H9R1WA01# |
|        |               |                    |       | ±0.1pF  | GRM0332C1H9R1BA01# |
|        |               |                    |       | ±0.25pF | GRM0332C1H9R1CA01# |
|        |               |                    |       | ±0.5pF  | GRM0332C1H9R1DA01# |
|        |               |                    | 9.2pF | ±0.05pF | GRM0332C1H9R2WA01# |
|        |               |                    |       | ±0.1pF  | GRM0332C1H9R2BA01# |
|        |               |                    |       | ±0.25pF | GRM0332C1H9R2CA01# |
|        |               |                    |       | ±0.5pF  | GRM0332C1H9R2DA01# |
|        |               |                    | 9.3pF | ±0.05pF | GRM0332C1H9R3WA01# |
|        |               |                    |       | ±0.1pF  | GRM0332C1H9R3BA01# |
|        |               |                    |       | ±0.25pF | GRM0332C1H9R3CA01# |
|        |               |                    |       | ±0.5pF  | GRM0332C1H9R3DA01# |
|        |               |                    | 9.4pF | ±0.05pF | GRM0332C1H9R4WA01# |
|        |               |                    |       | ±0.1pF  | GRM0332C1H9R4BA01# |
|        |               |                    |       | ±0.25pF | GRM0332C1H9R4CA01# |
|        |               |                    |       | ±0.5pF  | GRM0332C1H9R4DA01# |
|        |               |                    | 9.5pF | ±0.05pF | GRM0332C1H9R5WA01# |
|        |               |                    |       | ±0.1pF  | GRM0332C1H9R5BA01# |
|        |               |                    |       | ±0.25pF | GRM0332C1H9R5CA01# |
|        |               |                    |       | ±0.5pF  | GRM0332C1H9R5DA01# |
|        |               |                    | 9.6pF | ±0.05pF | GRM0332C1H9R6WA01# |
|        |               |                    |       | ±0.1pF  | GRM0332C1H9R6BA01# |
|        |               |                    |       | ±0.25pF | GRM0332C1H9R6CA01# |
|        |               |                    |       | ±0.5pF  | GRM0332C1H9R6DA01# |
|        |               |                    | 9.7pF | ±0.05pF | GRM0332C1H9R7WA01# |
|        |               |                    |       | ±0.1pF  | GRM0332C1H9R7BA01# |
|        |               |                    |       | ±0.25pF | GRM0332C1H9R7CA01# |
|        |               |                    |       | ±0.5pF  | GRM0332C1H9R7DA01# |
|        |               |                    | 9.8pF | ±0.05pF | GRM0332C1H9R8WA01# |
|        |               |                    |       | ±0.1pF  | GRM0332C1H9R8BA01# |
|        |               |                    |       | ±0.25pF | GRM0332C1H9R8CA01# |
|        |               |                    |       | ±0.5pF  | GRM0332C1H9R8DA01# |
|        |               |                    | 9.9pF | ±0.05pF | GRM0332C1H9R9WA01# |
|        |               |                    |       | ±0.1pF  | GRM0332C1H9R9BA01# |
|        |               |                    |       | ±0.25pF | GRM0332C1H9R9CA01# |
|        |               |                    |       | ±0.5pF  | GRM0332C1H9R9DA01# |
|        |               |                    | 10pF  | ±2%     | GRM0332C1H100GA01# |
|        |               |                    |       | ±5%     | GRM0332C1H100JA01# |
|        |               |                    | 12pF  | ±2%     | GRM0332C1H120GA01# |
|        |               |                    |       | ±5%     | GRM0332C1H120JA01# |
|        |               |                    | 15pF  | ±2%     | GRM0332C1H150GA01# |
|        |               |                    |       | ±5%     | GRM0332C1H150JA01# |
|        |               |                    | 18pF  | ±2%     | GRM0332C1H180GA01# |
|        |               |                    |       | ±5%     | GRM0332C1H180JA01# |
|        |               |                    | 22pF  | ±2%     | GRM0332C1H220GA01# |
|        |               |                    |       | ±5%     | GRM0332C1H220JA01# |
|        |               |                    | 27pF  | ±2%     | GRM0332C1H270GA01# |
|        |               |                    |       | ±5%     | GRM0332C1H270JA01# |
| 33pF   | ±2%           | GRM0332C1H330GA01# |       |         |                    |
|        | ±5%           | GRM0332C1H330JA01# |       |         |                    |
| 39pF   | ±2%           | GRM0332C1H390GA01# |       |         |                    |
|        | ±5%           | GRM0332C1H390JA01# |       |         |                    |
| 47pF   | ±2%           | GRM0332C1H470GA01# |       |         |                    |
|        | ±5%           | GRM0332C1H470JA01# |       |         |                    |

| T max. | Rated Voltage | TC Code | Cap.  | Tol. | Part Number        |
|--------|---------------|---------|-------|------|--------------------|
| 0.33mm | 50Vdc         | CH      | 56pF  | ±2%  | GRM0332C1H560GA01# |
|        |               |         |       | ±5%  | GRM0332C1H560JA01# |
|        |               |         | 68pF  | ±2%  | GRM0332C1H680GA01# |
|        |               |         |       | ±5%  | GRM0332C1H680JA01# |
|        |               |         | 82pF  | ±2%  | GRM0332C1H820GA01# |
|        |               |         |       | ±5%  | GRM0332C1H820JA01# |
|        |               |         | 100pF | ±2%  | GRM0332C1H101GA01# |
|        |               |         |       | ±5%  | GRM0332C1H101JA01# |
|        |               |         | 120pF | ±2%  | GRM0332C1H121GA01# |
|        |               |         |       | ±5%  | GRM0332C1H121JA01# |
|        |               |         | 150pF | ±2%  | GRM0332C1H151GA01# |
|        |               |         |       | ±5%  | GRM0332C1H151JA01# |
|        |               |         | 180pF | ±2%  | GRM0332C1H181GA01# |
|        |               |         |       | ±5%  | GRM0332C1H181JA01# |
|        |               |         | 220pF | ±2%  | GRM0332C1H221GA01# |
|        |               |         |       | ±5%  | GRM0332C1H221JA01# |

■ 1.0x0.5mm

| T max. | Rated Voltage | TC Code            | Cap.   | Tol.    | Part Number        |
|--------|---------------|--------------------|--------|---------|--------------------|
| 0.55mm | 100Vdc        | C0G                | 0.10pF | ±0.05pF | GRM1555C2AR10WA01# |
|        |               |                    |        | ±0.1pF  | GRM1555C2AR20BA01# |
|        |               |                    | 0.20pF | ±0.05pF | GRM1555C2AR20WA01# |
|        |               |                    |        | ±0.1pF  | GRM1555C2AR20BA01# |
|        |               |                    | 0.30pF | ±0.05pF | GRM1555C2AR30WA01# |
|        |               |                    |        | ±0.1pF  | GRM1555C2AR30BA01# |
|        |               |                    | 0.40pF | ±0.05pF | GRM1555C2AR40WA01# |
|        |               |                    |        | ±0.1pF  | GRM1555C2AR40BA01# |
|        |               |                    | 0.50pF | ±0.05pF | GRM1555C2AR50WA01# |
|        |               |                    |        | ±0.1pF  | GRM1555C2AR50BA01# |
|        |               |                    | 0.60pF | ±0.05pF | GRM1555C2AR60WA01# |
|        |               |                    |        | ±0.1pF  | GRM1555C2AR60BA01# |
|        |               |                    | 0.70pF | ±0.05pF | GRM1555C2AR70WA01# |
|        |               |                    |        | ±0.1pF  | GRM1555C2AR70BA01# |
|        |               |                    | 0.80pF | ±0.05pF | GRM1555C2AR80WA01# |
|        |               |                    |        | ±0.1pF  | GRM1555C2AR80BA01# |
|        |               |                    | 0.90pF | ±0.05pF | GRM1555C2AR90WA01# |
|        |               |                    |        | ±0.1pF  | GRM1555C2AR90BA01# |
|        |               |                    | 1.0pF  | ±0.05pF | GRM1555C2A1R0WA01# |
|        |               |                    |        | ±0.1pF  | GRM1555C2A1R0BA01# |
|        |               |                    |        | ±0.25pF | GRM1555C2A1R0CA01# |
|        |               |                    | 1.1pF  | ±0.05pF | GRM1555C2A1R1WA01# |
|        |               |                    |        | ±0.1pF  | GRM1555C2A1R1BA01# |
|        |               |                    |        | ±0.25pF | GRM1555C2A1R1CA01# |
|        |               |                    | 1.2pF  | ±0.05pF | GRM1555C2A1R2WA01# |
|        |               |                    |        | ±0.1pF  | GRM1555C2A1R2BA01# |
|        |               |                    |        | ±0.25pF | GRM1555C2A1R2CA01# |
|        |               |                    | 1.3pF  | ±0.05pF | GRM1555C2A1R3WA01# |
|        |               |                    |        | ±0.1pF  | GRM1555C2A1R3BA01# |
|        |               |                    |        | ±0.25pF | GRM1555C2A1R3CA01# |
| 1.4pF  | ±0.05pF       | GRM1555C2A1R4WA01# |        |         |                    |
|        | ±0.1pF        | GRM1555C2A1R4BA01# |        |         |                    |
|        | ±0.25pF       | GRM1555C2A1R4CA01# |        |         |                    |
| 1.5pF  | ±0.05pF       | GRM1555C2A1R5WA01# |        |         |                    |

Part number # indicates the package specification code.

GRM Series  
GJM Series  
GMA Series  
GMD Series  
GQM Series  
GRJ Series  
GR3 Series  
KRM Series  
KR3 Series  
LLA Series  
LLL Series  
LLM Series  
LLR Series  
⚠Caution/Notice

## GRM Series Temperature Compensating Type Part Number List

(→ ■ 1.0x0.5mm)

| T max. | Rated Voltage | TC Code            | Cap.  | Tol.    | Part Number        |
|--------|---------------|--------------------|-------|---------|--------------------|
| 0.55mm | 100Vdc        | C0G                | 1.5pF | ±0.1pF  | GRM1555C2A1R5BA01# |
|        |               |                    |       | ±0.25pF | GRM1555C2A1R5CA01# |
|        |               |                    |       |         |                    |
|        |               |                    | 1.6pF | ±0.05pF | GRM1555C2A1R6WA01# |
|        |               |                    |       | ±0.1pF  | GRM1555C2A1R6BA01# |
|        |               |                    |       | ±0.25pF | GRM1555C2A1R6CA01# |
|        |               |                    | 1.7pF | ±0.05pF | GRM1555C2A1R7WA01# |
|        |               |                    |       | ±0.1pF  | GRM1555C2A1R7BA01# |
|        |               |                    |       | ±0.25pF | GRM1555C2A1R7CA01# |
|        |               |                    | 1.8pF | ±0.05pF | GRM1555C2A1R8WA01# |
|        |               |                    |       | ±0.1pF  | GRM1555C2A1R8BA01# |
|        |               |                    |       | ±0.25pF | GRM1555C2A1R8CA01# |
|        |               |                    | 1.9pF | ±0.05pF | GRM1555C2A1R9WA01# |
|        |               |                    |       | ±0.1pF  | GRM1555C2A1R9BA01# |
|        |               |                    |       | ±0.25pF | GRM1555C2A1R9CA01# |
|        |               |                    | 2.0pF | ±0.05pF | GRM1555C2A2R0WA01# |
|        |               |                    |       | ±0.1pF  | GRM1555C2A2R0BA01# |
|        |               |                    |       | ±0.25pF | GRM1555C2A2R0CA01# |
|        |               |                    | 2.1pF | ±0.05pF | GRM1555C2A2R1WA01# |
|        |               |                    |       | ±0.1pF  | GRM1555C2A2R1BA01# |
|        |               |                    |       | ±0.25pF | GRM1555C2A2R1CA01# |
|        |               |                    | 2.2pF | ±0.05pF | GRM1555C2A2R2WA01# |
|        |               |                    |       | ±0.1pF  | GRM1555C2A2R2BA01# |
|        |               |                    |       | ±0.25pF | GRM1555C2A2R2CA01# |
|        |               |                    | 2.3pF | ±0.05pF | GRM1555C2A2R3WA01# |
|        |               |                    |       | ±0.1pF  | GRM1555C2A2R3BA01# |
|        |               |                    |       | ±0.25pF | GRM1555C2A2R3CA01# |
|        |               |                    | 2.4pF | ±0.05pF | GRM1555C2A2R4WA01# |
|        |               |                    |       | ±0.1pF  | GRM1555C2A2R4BA01# |
|        |               |                    |       | ±0.25pF | GRM1555C2A2R4CA01# |
|        |               |                    | 2.5pF | ±0.05pF | GRM1555C2A2R5WA01# |
|        |               |                    |       | ±0.1pF  | GRM1555C2A2R5BA01# |
|        |               |                    |       | ±0.25pF | GRM1555C2A2R5CA01# |
|        |               |                    | 2.6pF | ±0.05pF | GRM1555C2A2R6WA01# |
|        |               |                    |       | ±0.1pF  | GRM1555C2A2R6BA01# |
|        |               |                    |       | ±0.25pF | GRM1555C2A2R6CA01# |
|        |               |                    | 2.7pF | ±0.05pF | GRM1555C2A2R7WA01# |
|        |               |                    |       | ±0.1pF  | GRM1555C2A2R7BA01# |
|        |               |                    |       | ±0.25pF | GRM1555C2A2R7CA01# |
|        |               |                    | 2.8pF | ±0.05pF | GRM1555C2A2R8WA01# |
|        |               |                    |       | ±0.1pF  | GRM1555C2A2R8BA01# |
|        |               |                    |       | ±0.25pF | GRM1555C2A2R8CA01# |
|        |               |                    | 2.9pF | ±0.05pF | GRM1555C2A2R9WA01# |
|        |               |                    |       | ±0.1pF  | GRM1555C2A2R9BA01# |
|        |               |                    |       | ±0.25pF | GRM1555C2A2R9CA01# |
| 3.0pF  | ±0.05pF       | GRM1555C2A3R0WA01# |       |         |                    |
|        | ±0.1pF        | GRM1555C2A3R0BA01# |       |         |                    |
|        | ±0.25pF       | GRM1555C2A3R0CA01# |       |         |                    |
| 3.1pF  | ±0.05pF       | GRM1555C2A3R1WA01# |       |         |                    |
|        | ±0.1pF        | GRM1555C2A3R1BA01# |       |         |                    |
|        | ±0.25pF       | GRM1555C2A3R1CA01# |       |         |                    |
| 3.2pF  | ±0.05pF       | GRM1555C2A3R2WA01# |       |         |                    |
|        | ±0.1pF        | GRM1555C2A3R2BA01# |       |         |                    |
|        | ±0.25pF       | GRM1555C2A3R2CA01# |       |         |                    |
| 3.3pF  | ±0.05pF       | GRM1555C2A3R3WA01# |       |         |                    |

| T max. | Rated Voltage | TC Code            | Cap.  | Tol.    | Part Number        |
|--------|---------------|--------------------|-------|---------|--------------------|
| 0.55mm | 100Vdc        | C0G                | 3.3pF | ±0.1pF  | GRM1555C2A3R3BA01# |
|        |               |                    |       | ±0.25pF | GRM1555C2A3R3CA01# |
|        |               |                    |       |         |                    |
|        |               |                    | 3.4pF | ±0.05pF | GRM1555C2A3R4WA01# |
|        |               |                    |       | ±0.1pF  | GRM1555C2A3R4BA01# |
|        |               |                    |       | ±0.25pF | GRM1555C2A3R4CA01# |
|        |               |                    | 3.5pF | ±0.05pF | GRM1555C2A3R5WA01# |
|        |               |                    |       | ±0.1pF  | GRM1555C2A3R5BA01# |
|        |               |                    |       | ±0.25pF | GRM1555C2A3R5CA01# |
|        |               |                    | 3.6pF | ±0.05pF | GRM1555C2A3R6WA01# |
|        |               |                    |       | ±0.1pF  | GRM1555C2A3R6BA01# |
|        |               |                    |       | ±0.25pF | GRM1555C2A3R6CA01# |
|        |               |                    | 3.7pF | ±0.05pF | GRM1555C2A3R7WA01# |
|        |               |                    |       | ±0.1pF  | GRM1555C2A3R7BA01# |
|        |               |                    |       | ±0.25pF | GRM1555C2A3R7CA01# |
|        |               |                    | 3.8pF | ±0.05pF | GRM1555C2A3R8WA01# |
|        |               |                    |       | ±0.1pF  | GRM1555C2A3R8BA01# |
|        |               |                    |       | ±0.25pF | GRM1555C2A3R8CA01# |
|        |               |                    | 3.9pF | ±0.05pF | GRM1555C2A3R9WA01# |
|        |               |                    |       | ±0.1pF  | GRM1555C2A3R9BA01# |
|        |               |                    |       | ±0.25pF | GRM1555C2A3R9CA01# |
|        |               |                    | 4.0pF | ±0.05pF | GRM1555C2A4R0WA01# |
|        |               |                    |       | ±0.1pF  | GRM1555C2A4R0BA01# |
|        |               |                    |       | ±0.25pF | GRM1555C2A4R0CA01# |
|        |               |                    | 4.1pF | ±0.05pF | GRM1555C2A4R1WA01# |
|        |               |                    |       | ±0.1pF  | GRM1555C2A4R1BA01# |
|        |               |                    |       | ±0.25pF | GRM1555C2A4R1CA01# |
|        |               |                    | 4.2pF | ±0.05pF | GRM1555C2A4R2WA01# |
|        |               |                    |       | ±0.1pF  | GRM1555C2A4R2BA01# |
|        |               |                    |       | ±0.25pF | GRM1555C2A4R2CA01# |
|        |               |                    | 4.3pF | ±0.05pF | GRM1555C2A4R3WA01# |
|        |               |                    |       | ±0.1pF  | GRM1555C2A4R3BA01# |
|        |               |                    |       | ±0.25pF | GRM1555C2A4R3CA01# |
|        |               |                    | 4.4pF | ±0.05pF | GRM1555C2A4R4WA01# |
|        |               |                    |       | ±0.1pF  | GRM1555C2A4R4BA01# |
|        |               |                    |       | ±0.25pF | GRM1555C2A4R4CA01# |
|        |               |                    | 4.5pF | ±0.05pF | GRM1555C2A4R5WA01# |
|        |               |                    |       | ±0.1pF  | GRM1555C2A4R5BA01# |
|        |               |                    |       | ±0.25pF | GRM1555C2A4R5CA01# |
|        |               |                    | 4.6pF | ±0.05pF | GRM1555C2A4R6WA01# |
|        |               |                    |       | ±0.1pF  | GRM1555C2A4R6BA01# |
|        |               |                    |       | ±0.25pF | GRM1555C2A4R6CA01# |
|        |               |                    | 4.7pF | ±0.05pF | GRM1555C2A4R7WA01# |
|        |               |                    |       | ±0.1pF  | GRM1555C2A4R7BA01# |
|        |               |                    |       | ±0.25pF | GRM1555C2A4R7CA01# |
| 4.8pF  | ±0.05pF       | GRM1555C2A4R8WA01# |       |         |                    |
|        | ±0.1pF        | GRM1555C2A4R8BA01# |       |         |                    |
|        | ±0.25pF       | GRM1555C2A4R8CA01# |       |         |                    |
| 4.9pF  | ±0.05pF       | GRM1555C2A4R9WA01# |       |         |                    |
|        | ±0.1pF        | GRM1555C2A4R9BA01# |       |         |                    |
|        | ±0.25pF       | GRM1555C2A4R9CA01# |       |         |                    |
| 5.0pF  | ±0.05pF       | GRM1555C2A5R0WA01# |       |         |                    |
|        | ±0.1pF        | GRM1555C2A5R0BA01# |       |         |                    |
|        | ±0.25pF       | GRM1555C2A5R0CA01# |       |         |                    |
| 5.1pF  | ±0.05pF       | GRM1555C2A5R1WA01# |       |         |                    |

Part number # indicates the package specification code.

## GRM Series Temperature Compensating Type Part Number List

(→ ■ 1.0x0.5mm)

| T max. | Rated Voltage | TC Code | Cap.  | Tol.    | Part Number        |
|--------|---------------|---------|-------|---------|--------------------|
| 0.55mm | 100Vdc        | C0G     | 5.1pF | ±0.1pF  | GRM1555C2A5R1BA01# |
|        |               |         |       | ±0.25pF | GRM1555C2A5R1CA01# |
|        |               |         |       | ±0.5pF  | GRM1555C2A5R1DA01# |
|        |               |         | 5.2pF | ±0.05pF | GRM1555C2A5R2WA01# |
|        |               |         |       | ±0.1pF  | GRM1555C2A5R2BA01# |
|        |               |         |       | ±0.25pF | GRM1555C2A5R2CA01# |
|        |               |         | 5.3pF | ±0.05pF | GRM1555C2A5R3WA01# |
|        |               |         |       | ±0.1pF  | GRM1555C2A5R3BA01# |
|        |               |         |       | ±0.25pF | GRM1555C2A5R3CA01# |
|        |               |         | 5.4pF | ±0.05pF | GRM1555C2A5R4WA01# |
|        |               |         |       | ±0.1pF  | GRM1555C2A5R4BA01# |
|        |               |         |       | ±0.25pF | GRM1555C2A5R4CA01# |
|        |               |         | 5.5pF | ±0.05pF | GRM1555C2A5R5WA01# |
|        |               |         |       | ±0.1pF  | GRM1555C2A5R5BA01# |
|        |               |         |       | ±0.25pF | GRM1555C2A5R5CA01# |
|        |               |         | 5.6pF | ±0.05pF | GRM1555C2A5R6WA01# |
|        |               |         |       | ±0.1pF  | GRM1555C2A5R6BA01# |
|        |               |         |       | ±0.25pF | GRM1555C2A5R6CA01# |
|        |               |         | 5.7pF | ±0.05pF | GRM1555C2A5R7WA01# |
|        |               |         |       | ±0.1pF  | GRM1555C2A5R7BA01# |
|        |               |         |       | ±0.25pF | GRM1555C2A5R7CA01# |
|        |               |         | 5.8pF | ±0.05pF | GRM1555C2A5R8WA01# |
|        |               |         |       | ±0.1pF  | GRM1555C2A5R8BA01# |
|        |               |         |       | ±0.25pF | GRM1555C2A5R8CA01# |
|        |               |         | 5.9pF | ±0.05pF | GRM1555C2A5R9WA01# |
|        |               |         |       | ±0.1pF  | GRM1555C2A5R9BA01# |
|        |               |         |       | ±0.25pF | GRM1555C2A5R9CA01# |
|        |               |         | 6.0pF | ±0.05pF | GRM1555C2A6R0WA01# |
|        |               |         |       | ±0.1pF  | GRM1555C2A6R0BA01# |
|        |               |         |       | ±0.25pF | GRM1555C2A6R0CA01# |
|        |               |         | 6.1pF | ±0.05pF | GRM1555C2A6R1WA01# |
|        |               |         |       | ±0.1pF  | GRM1555C2A6R1BA01# |
|        |               |         |       | ±0.25pF | GRM1555C2A6R1CA01# |
|        |               |         | 6.2pF | ±0.05pF | GRM1555C2A6R2WA01# |
|        |               |         |       | ±0.1pF  | GRM1555C2A6R2BA01# |
|        |               |         |       | ±0.25pF | GRM1555C2A6R2CA01# |
|        |               |         | 6.3pF | ±0.05pF | GRM1555C2A6R3WA01# |
|        |               |         |       | ±0.1pF  | GRM1555C2A6R3BA01# |
|        |               |         |       | ±0.25pF | GRM1555C2A6R3CA01# |
|        |               |         | 6.4pF | ±0.05pF | GRM1555C2A6R4WA01# |
|        |               |         |       | ±0.1pF  | GRM1555C2A6R4BA01# |
|        |               |         |       | ±0.25pF | GRM1555C2A6R4CA01# |

| T max. | Rated Voltage | TC Code | Cap.    | Tol.    | Part Number        |
|--------|---------------|---------|---------|---------|--------------------|
| 0.55mm | 100Vdc        | C0G     | 6.4pF   | ±0.5pF  | GRM1555C2A6R4DA01# |
|        |               |         |         | ±0.05pF | GRM1555C2A6R5WA01# |
|        |               |         |         | ±0.1pF  | GRM1555C2A6R5BA01# |
|        |               |         | 6.5pF   | ±0.25pF | GRM1555C2A6R5CA01# |
|        |               |         |         | ±0.5pF  | GRM1555C2A6R5DA01# |
|        |               |         |         | 6.6pF   | ±0.05pF            |
|        |               |         | ±0.1pF  |         | GRM1555C2A6R6BA01# |
|        |               |         | ±0.25pF |         | GRM1555C2A6R6CA01# |
|        |               |         | 6.7pF   | ±0.05pF | GRM1555C2A6R7WA01# |
|        |               |         |         | ±0.1pF  | GRM1555C2A6R7BA01# |
|        |               |         |         | ±0.25pF | GRM1555C2A6R7CA01# |
|        |               |         | 6.8pF   | ±0.05pF | GRM1555C2A6R8WA01# |
|        |               |         |         | ±0.1pF  | GRM1555C2A6R8BA01# |
|        |               |         |         | ±0.25pF | GRM1555C2A6R8CA01# |
|        |               |         | 6.9pF   | ±0.05pF | GRM1555C2A6R9WA01# |
|        |               |         |         | ±0.1pF  | GRM1555C2A6R9BA01# |
|        |               |         |         | ±0.25pF | GRM1555C2A6R9CA01# |
|        |               |         | 7.0pF   | ±0.05pF | GRM1555C2A7R0WA01# |
|        |               |         |         | ±0.1pF  | GRM1555C2A7R0BA01# |
|        |               |         |         | ±0.25pF | GRM1555C2A7R0CA01# |
|        |               |         | 7.1pF   | ±0.05pF | GRM1555C2A7R1WA01# |
|        |               |         |         | ±0.1pF  | GRM1555C2A7R1BA01# |
|        |               |         |         | ±0.25pF | GRM1555C2A7R1CA01# |
|        |               |         | 7.2pF   | ±0.05pF | GRM1555C2A7R2WA01# |
|        |               |         |         | ±0.1pF  | GRM1555C2A7R2BA01# |
|        |               |         |         | ±0.25pF | GRM1555C2A7R2CA01# |
|        |               |         | 7.3pF   | ±0.05pF | GRM1555C2A7R3WA01# |
|        |               |         |         | ±0.1pF  | GRM1555C2A7R3BA01# |
|        |               |         |         | ±0.25pF | GRM1555C2A7R3CA01# |
|        |               |         | 7.4pF   | ±0.05pF | GRM1555C2A7R4WA01# |
|        |               |         |         | ±0.1pF  | GRM1555C2A7R4BA01# |
|        |               |         |         | ±0.25pF | GRM1555C2A7R4CA01# |
|        |               |         | 7.5pF   | ±0.05pF | GRM1555C2A7R5WA01# |
|        |               |         |         | ±0.1pF  | GRM1555C2A7R5BA01# |
|        |               |         |         | ±0.25pF | GRM1555C2A7R5CA01# |
|        |               |         | 7.6pF   | ±0.05pF | GRM1555C2A7R6WA01# |
|        |               |         |         | ±0.1pF  | GRM1555C2A7R6BA01# |
|        |               |         |         | ±0.25pF | GRM1555C2A7R6CA01# |
|        |               |         | 7.7pF   | ±0.05pF | GRM1555C2A7R7WA01# |
|        |               |         |         | ±0.1pF  | GRM1555C2A7R7BA01# |
|        |               |         |         | ±0.25pF | GRM1555C2A7R7CA01# |
|        |               |         | 7.8pF   | ±0.05pF | GRM1555C2A7R8WA01# |
|        |               |         |         | ±0.1pF  | GRM1555C2A7R8BA01# |
|        |               |         |         | ±0.25pF | GRM1555C2A7R8CA01# |

Part number # indicates the package specification code.

GRM Series  
GJM Series  
GMA Series  
GMD Series  
GQM Series  
GRJ Series  
GR3 Series  
KRM Series  
KR3 Series  
LLA Series  
LLL Series  
LLM Series  
LLR Series  
⚠Caution/ Notice

# GRM Series Temperature Compensating Type Part Number List

(→ ■ 1.0x0.5mm)

| T max. | Rated Voltage | TC Code | Cap.  | Tol.    | Part Number        |
|--------|---------------|---------|-------|---------|--------------------|
| 0.55mm | 100Vdc        | C0G     | 7.8pF | ±0.1pF  | GRM1555C2A7R8BA01# |
|        |               |         |       | ±0.25pF | GRM1555C2A7R8CA01# |
|        |               |         |       | ±0.5pF  | GRM1555C2A7R8DA01# |
|        |               |         | 7.9pF | ±0.05pF | GRM1555C2A7R9WA01# |
|        |               |         |       | ±0.1pF  | GRM1555C2A7R9BA01# |
|        |               |         |       | ±0.25pF | GRM1555C2A7R9CA01# |
|        |               |         | 8.0pF | ±0.05pF | GRM1555C2A8R0WA01# |
|        |               |         |       | ±0.1pF  | GRM1555C2A8R0BA01# |
|        |               |         |       | ±0.25pF | GRM1555C2A8R0CA01# |
|        |               |         | 8.1pF | ±0.05pF | GRM1555C2A8R1WA01# |
|        |               |         |       | ±0.1pF  | GRM1555C2A8R1BA01# |
|        |               |         |       | ±0.25pF | GRM1555C2A8R1CA01# |
|        |               |         | 8.2pF | ±0.05pF | GRM1555C2A8R2WA01# |
|        |               |         |       | ±0.1pF  | GRM1555C2A8R2BA01# |
|        |               |         |       | ±0.25pF | GRM1555C2A8R2CA01# |
|        |               |         | 8.3pF | ±0.05pF | GRM1555C2A8R3WA01# |
|        |               |         |       | ±0.1pF  | GRM1555C2A8R3BA01# |
|        |               |         |       | ±0.25pF | GRM1555C2A8R3CA01# |
|        |               |         | 8.4pF | ±0.05pF | GRM1555C2A8R4WA01# |
|        |               |         |       | ±0.1pF  | GRM1555C2A8R4BA01# |
|        |               |         |       | ±0.25pF | GRM1555C2A8R4CA01# |
|        |               |         | 8.5pF | ±0.05pF | GRM1555C2A8R5WA01# |
|        |               |         |       | ±0.1pF  | GRM1555C2A8R5BA01# |
|        |               |         |       | ±0.25pF | GRM1555C2A8R5CA01# |
|        |               |         | 8.6pF | ±0.05pF | GRM1555C2A8R6WA01# |
|        |               |         |       | ±0.1pF  | GRM1555C2A8R6BA01# |
|        |               |         |       | ±0.25pF | GRM1555C2A8R6CA01# |
|        |               |         | 8.7pF | ±0.05pF | GRM1555C2A8R7WA01# |
|        |               |         |       | ±0.1pF  | GRM1555C2A8R7BA01# |
|        |               |         |       | ±0.25pF | GRM1555C2A8R7CA01# |
|        |               |         | 8.8pF | ±0.05pF | GRM1555C2A8R8WA01# |
|        |               |         |       | ±0.1pF  | GRM1555C2A8R8BA01# |
|        |               |         |       | ±0.25pF | GRM1555C2A8R8CA01# |
|        |               |         | 8.9pF | ±0.05pF | GRM1555C2A8R9WA01# |
|        |               |         |       | ±0.1pF  | GRM1555C2A8R9BA01# |
|        |               |         |       | ±0.25pF | GRM1555C2A8R9CA01# |
|        |               |         | 9.0pF | ±0.05pF | GRM1555C2A9R0WA01# |
|        |               |         |       | ±0.1pF  | GRM1555C2A9R0BA01# |
|        |               |         |       | ±0.25pF | GRM1555C2A9R0CA01# |
|        |               |         | 9.1pF | ±0.05pF | GRM1555C2A9R1WA01# |
|        |               |         |       | ±0.1pF  | GRM1555C2A9R1BA01# |
|        |               |         |       | ±0.25pF | GRM1555C2A9R1CA01# |

| T max. | Rated Voltage | TC Code | Cap.    | Tol.    | Part Number        |
|--------|---------------|---------|---------|---------|--------------------|
| 0.55mm | 100Vdc        | C0G     | 9.1pF   | ±0.5pF  | GRM1555C2A9R1DA01# |
|        |               |         |         | ±0.05pF | GRM1555C2A9R2WA01# |
|        |               |         |         | ±0.1pF  | GRM1555C2A9R2BA01# |
|        |               |         | 9.2pF   | ±0.25pF | GRM1555C2A9R2CA01# |
|        |               |         |         | ±0.5pF  | GRM1555C2A9R2DA01# |
|        |               |         |         | 9.3pF   | ±0.05pF            |
|        |               |         | ±0.1pF  |         | GRM1555C2A9R3BA01# |
|        |               |         | ±0.25pF |         | GRM1555C2A9R3CA01# |
|        |               |         | 9.4pF   | ±0.05pF | GRM1555C2A9R4WA01# |
|        |               |         |         | ±0.1pF  | GRM1555C2A9R4BA01# |
|        |               |         |         | ±0.25pF | GRM1555C2A9R4CA01# |
|        |               |         | 9.5pF   | ±0.05pF | GRM1555C2A9R5WA01# |
|        |               |         |         | ±0.1pF  | GRM1555C2A9R5BA01# |
|        |               |         |         | ±0.25pF | GRM1555C2A9R5CA01# |
|        |               |         | 9.6pF   | ±0.05pF | GRM1555C2A9R6WA01# |
|        |               |         |         | ±0.1pF  | GRM1555C2A9R6BA01# |
|        |               |         |         | ±0.25pF | GRM1555C2A9R6CA01# |
|        |               |         | 9.7pF   | ±0.05pF | GRM1555C2A9R7WA01# |
|        |               |         |         | ±0.1pF  | GRM1555C2A9R7BA01# |
|        |               |         |         | ±0.25pF | GRM1555C2A9R7CA01# |
|        |               |         | 9.8pF   | ±0.05pF | GRM1555C2A9R8WA01# |
|        |               |         |         | ±0.1pF  | GRM1555C2A9R8BA01# |
|        |               |         |         | ±0.25pF | GRM1555C2A9R8CA01# |
|        |               |         | 9.9pF   | ±0.05pF | GRM1555C2A9R9WA01# |
|        |               |         |         | ±0.1pF  | GRM1555C2A9R9BA01# |
|        |               |         |         | ±0.25pF | GRM1555C2A9R9CA01# |
|        |               |         | 10pF    | ±2%     | GRM1555C2A100GA01# |
|        |               |         |         | ±5%     | GRM1555C2A100JA01# |
|        |               |         | 12pF    | ±2%     | GRM1555C2A120GA01# |
|        |               |         |         | ±5%     | GRM1555C2A120JA01# |
|        |               |         | 15pF    | ±2%     | GRM1555C2A150GA01# |
|        |               |         |         | ±5%     | GRM1555C2A150JA01# |
|        |               |         | 18pF    | ±2%     | GRM1555C2A180GA01# |
|        |               |         |         | ±5%     | GRM1555C2A180JA01# |
|        |               |         | 22pF    | ±2%     | GRM1555C2A220GA01# |
|        |               |         |         | ±5%     | GRM1555C2A220JA01# |
|        |               |         | 27pF    | ±2%     | GRM1555C2A270GA01# |
|        |               |         |         | ±5%     | GRM1555C2A270JA01# |
|        |               |         | 33pF    | ±2%     | GRM1555C2A330GA01# |
|        |               |         |         | ±5%     | GRM1555C2A330JA01# |
|        |               |         | 39pF    | ±2%     | GRM1555C2A390GA01# |
|        |               |         |         | ±5%     | GRM1555C2A390JA01# |
|        |               |         | 47pF    | ±2%     | GRM1555C2A470GA01# |
|        |               |         |         | ±5%     | GRM1555C2A470JA01# |
|        |               |         | 56pF    | ±2%     | GRM1555C2A560GA01# |
|        |               |         |         | ±5%     | GRM1555C2A560JA01# |
|        |               |         | 68pF    | ±2%     | GRM1555C2A680GA01# |

Part number # indicates the package specification code.

GRM Series  
 GJM Series  
 GMA Series  
 GMD Series  
 GQM Series  
 GRJ Series  
 GR3 Series  
 KRM Series  
 KR3 Series  
 LLA Series  
 LLL Series  
 LLM Series  
 LLR Series  
 ⚠Caution/  
 Notice

## GRM Series Temperature Compensating Type Part Number List

(→ ■ 1.0x0.5mm)

| T max.  | Rated Voltage      | TC Code            | Cap.    | Tol.               | Part Number        |                    |
|---------|--------------------|--------------------|---------|--------------------|--------------------|--------------------|
| 0.55mm  | 100Vdc             | C0G                | 68pF    | ±5%                | GRM1555C2A680JA01# |                    |
|         |                    |                    | 82pF    | ±2%                | GRM1555C2A820GA01# |                    |
|         |                    |                    |         | ±5%                | GRM1555C2A820JA01# |                    |
|         |                    |                    | 100pF   | ±2%                | GRM1555C2A101GA01# |                    |
|         |                    |                    |         | ±5%                | GRM1555C2A101JA01# |                    |
|         |                    |                    | CK      | 0.10pF             | ±0.05pF            | GRM1554C2AR10WA01# |
|         |                    |                    |         | 0.20pF             | ±0.05pF            | GRM1554C2AR20WA01# |
|         |                    |                    |         |                    | ±0.1pF             | GRM1554C2AR20BA01# |
|         |                    | 0.30pF             |         | ±0.05pF            | GRM1554C2AR30WA01# |                    |
|         |                    |                    |         | ±0.1pF             | GRM1554C2AR30BA01# |                    |
|         |                    | 0.40pF             |         | ±0.05pF            | GRM1554C2AR40WA01# |                    |
|         |                    |                    |         | ±0.1pF             | GRM1554C2AR40BA01# |                    |
|         |                    | 0.50pF             |         | ±0.05pF            | GRM1554C2AR50WA01# |                    |
|         |                    |                    |         | ±0.1pF             | GRM1554C2AR50BA01# |                    |
|         |                    | 0.60pF             |         | ±0.05pF            | GRM1554C2AR60WA01# |                    |
|         |                    |                    |         | ±0.1pF             | GRM1554C2AR60BA01# |                    |
|         |                    | 0.70pF             |         | ±0.05pF            | GRM1554C2AR70WA01# |                    |
|         |                    |                    |         | ±0.1pF             | GRM1554C2AR70BA01# |                    |
|         |                    | 0.80pF             |         | ±0.05pF            | GRM1554C2AR80WA01# |                    |
|         |                    |                    |         | ±0.1pF             | GRM1554C2AR80BA01# |                    |
|         |                    | 0.90pF             |         | ±0.05pF            | GRM1554C2AR90WA01# |                    |
|         |                    |                    |         | ±0.1pF             | GRM1554C2AR90BA01# |                    |
|         |                    | 1.0pF              |         | ±0.05pF            | GRM1554C2A1R0WA01# |                    |
|         |                    |                    |         | ±0.1pF             | GRM1554C2A1R0BA01# |                    |
|         |                    |                    |         | ±0.25pF            | GRM1554C2A1R0CA01# |                    |
|         |                    | 1.1pF              |         | ±0.05pF            | GRM1554C2A1R1WA01# |                    |
|         |                    |                    |         | ±0.1pF             | GRM1554C2A1R1BA01# |                    |
|         |                    |                    |         | ±0.25pF            | GRM1554C2A1R1CA01# |                    |
|         |                    | 1.2pF              |         | ±0.05pF            | GRM1554C2A1R2WA01# |                    |
|         |                    |                    |         | ±0.1pF             | GRM1554C2A1R2BA01# |                    |
|         |                    |                    |         | ±0.25pF            | GRM1554C2A1R2CA01# |                    |
|         |                    | 1.3pF              |         | ±0.05pF            | GRM1554C2A1R3WA01# |                    |
|         |                    |                    |         | ±0.1pF             | GRM1554C2A1R3BA01# |                    |
|         |                    |                    |         | ±0.25pF            | GRM1554C2A1R3CA01# |                    |
|         |                    | 1.4pF              |         | ±0.05pF            | GRM1554C2A1R4WA01# |                    |
|         |                    |                    |         | ±0.1pF             | GRM1554C2A1R4BA01# |                    |
|         |                    |                    |         | ±0.25pF            | GRM1554C2A1R4CA01# |                    |
|         |                    | 1.5pF              | ±0.05pF | GRM1554C2A1R5WA01# |                    |                    |
|         |                    |                    | ±0.1pF  | GRM1554C2A1R5BA01# |                    |                    |
|         |                    |                    | ±0.25pF | GRM1554C2A1R5CA01# |                    |                    |
|         |                    | 1.6pF              | ±0.05pF | GRM1554C2A1R6WA01# |                    |                    |
|         |                    |                    | ±0.1pF  | GRM1554C2A1R6BA01# |                    |                    |
|         |                    |                    | ±0.25pF | GRM1554C2A1R6CA01# |                    |                    |
|         |                    | 1.7pF              | ±0.05pF | GRM1554C2A1R7WA01# |                    |                    |
| ±0.1pF  | GRM1554C2A1R7BA01# |                    |         |                    |                    |                    |
| ±0.25pF | GRM1554C2A1R7CA01# |                    |         |                    |                    |                    |
| 1.8pF   | ±0.05pF            | GRM1554C2A1R8WA01# |         |                    |                    |                    |
|         | ±0.1pF             | GRM1554C2A1R8BA01# |         |                    |                    |                    |
|         | ±0.25pF            | GRM1554C2A1R8CA01# |         |                    |                    |                    |
| 1.9pF   | ±0.05pF            | GRM1554C2A1R9WA01# |         |                    |                    |                    |
|         | ±0.1pF             | GRM1554C2A1R9BA01# |         |                    |                    |                    |
|         | ±0.25pF            | GRM1554C2A1R9CA01# |         |                    |                    |                    |
| 2.0pF   | ±0.05pF            | GRM1554C2A2R0WA01# |         |                    |                    |                    |
|         | ±0.1pF             | GRM1554C2A2R0BA01# |         |                    |                    |                    |

| T max.  | Rated Voltage      | TC Code            | Cap.    | Tol.               | Part Number        |
|---------|--------------------|--------------------|---------|--------------------|--------------------|
| 0.55mm  | 100Vdc             | CK                 | 2.0pF   | ±0.25pF            | GRM1554C2A2R0CA01# |
|         |                    |                    | CJ      | 2.1pF              | ±0.05pF            |
|         |                    | ±0.1pF             |         |                    | GRM1553C2A2R1BA01# |
|         |                    | ±0.25pF            |         |                    | GRM1553C2A2R1CA01# |
|         |                    | 2.2pF              |         | ±0.05pF            | GRM1553C2A2R2WA01# |
|         |                    |                    |         | ±0.1pF             | GRM1553C2A2R2BA01# |
|         |                    |                    |         | ±0.25pF            | GRM1553C2A2R2CA01# |
|         |                    | 2.3pF              |         | ±0.05pF            | GRM1553C2A2R3WA01# |
|         |                    |                    |         | ±0.1pF             | GRM1553C2A2R3BA01# |
|         |                    |                    |         | ±0.25pF            | GRM1553C2A2R3CA01# |
|         |                    | 2.4pF              |         | ±0.05pF            | GRM1553C2A2R4WA01# |
|         |                    |                    | ±0.1pF  | GRM1553C2A2R4BA01# |                    |
|         |                    |                    | ±0.25pF | GRM1553C2A2R4CA01# |                    |
|         |                    | 2.5pF              | ±0.05pF | GRM1553C2A2R5WA01# |                    |
|         |                    |                    | ±0.1pF  | GRM1553C2A2R5BA01# |                    |
|         |                    |                    | ±0.25pF | GRM1553C2A2R5CA01# |                    |
|         |                    | 2.6pF              | ±0.05pF | GRM1553C2A2R6WA01# |                    |
|         |                    |                    | ±0.1pF  | GRM1553C2A2R6BA01# |                    |
|         |                    |                    | ±0.25pF | GRM1553C2A2R6CA01# |                    |
|         |                    | 2.7pF              | ±0.05pF | GRM1553C2A2R7WA01# |                    |
|         |                    |                    | ±0.1pF  | GRM1553C2A2R7BA01# |                    |
|         |                    |                    | ±0.25pF | GRM1553C2A2R7CA01# |                    |
|         |                    | 2.8pF              | ±0.05pF | GRM1553C2A2R8WA01# |                    |
|         |                    |                    | ±0.1pF  | GRM1553C2A2R8BA01# |                    |
|         |                    |                    | ±0.25pF | GRM1553C2A2R8CA01# |                    |
|         |                    | 2.9pF              | ±0.05pF | GRM1553C2A2R9WA01# |                    |
|         |                    |                    | ±0.1pF  | GRM1553C2A2R9BA01# |                    |
|         |                    |                    | ±0.25pF | GRM1553C2A2R9CA01# |                    |
|         |                    | 3.0pF              | ±0.05pF | GRM1553C2A3R0WA01# |                    |
|         |                    |                    | ±0.1pF  | GRM1553C2A3R0BA01# |                    |
|         |                    |                    | ±0.25pF | GRM1553C2A3R0CA01# |                    |
|         |                    | 3.1pF              | ±0.05pF | GRM1553C2A3R1WA01# |                    |
|         |                    |                    | ±0.1pF  | GRM1553C2A3R1BA01# |                    |
|         |                    |                    | ±0.25pF | GRM1553C2A3R1CA01# |                    |
|         |                    | 3.2pF              | ±0.05pF | GRM1553C2A3R2WA01# |                    |
|         |                    |                    | ±0.1pF  | GRM1553C2A3R2BA01# |                    |
|         |                    |                    | ±0.25pF | GRM1553C2A3R2CA01# |                    |
|         |                    | 3.3pF              | ±0.05pF | GRM1553C2A3R3WA01# |                    |
|         |                    |                    | ±0.1pF  | GRM1553C2A3R3BA01# |                    |
|         |                    |                    | ±0.25pF | GRM1553C2A3R3CA01# |                    |
|         |                    | 3.4pF              | ±0.05pF | GRM1553C2A3R4WA01# |                    |
|         |                    |                    | ±0.1pF  | GRM1553C2A3R4BA01# |                    |
|         |                    |                    | ±0.25pF | GRM1553C2A3R4CA01# |                    |
|         |                    | 3.5pF              | ±0.05pF | GRM1553C2A3R5WA01# |                    |
| ±0.1pF  | GRM1553C2A3R5BA01# |                    |         |                    |                    |
| ±0.25pF | GRM1553C2A3R5CA01# |                    |         |                    |                    |
| 3.6pF   | ±0.05pF            | GRM1553C2A3R6WA01# |         |                    |                    |
|         | ±0.1pF             | GRM1553C2A3R6BA01# |         |                    |                    |
|         | ±0.25pF            | GRM1553C2A3R6CA01# |         |                    |                    |
| 3.7pF   | ±0.05pF            | GRM1553C2A3R7WA01# |         |                    |                    |
|         | ±0.1pF             | GRM1553C2A3R7BA01# |         |                    |                    |
|         | ±0.25pF            | GRM1553C2A3R7CA01# |         |                    |                    |
| 3.8pF   | ±0.05pF            | GRM1553C2A3R8WA01# |         |                    |                    |
|         | ±0.1pF             | GRM1553C2A3R8BA01# |         |                    |                    |

Part number # indicates the package specification code.

GRM Series  
GJM Series  
GMA Series  
GMD Series  
GQM Series  
GRJ Series  
GR3 Series  
KRM Series  
KR3 Series  
LLA Series  
LLM Series  
LLR Series  
⚠Caution/ Notice

## GRM Series Temperature Compensating Type Part Number List

(→ ■ 1.0x0.5mm)

| T max. | Rated Voltage | TC Code | Cap.    | Tol.               | Part Number        |                    |
|--------|---------------|---------|---------|--------------------|--------------------|--------------------|
| 0.55mm | 100Vdc        | CJ      | 3.8pF   | ±0.25pF            | GRM1553C2A3R8CA01# |                    |
|        |               |         |         | ±0.05pF            | GRM1553C2A3R9WA01# |                    |
|        |               |         |         |                    | ±0.1pF             | GRM1553C2A3R9BA01# |
|        |               |         |         |                    | ±0.25pF            | GRM1553C2A3R9CA01# |
|        |               |         | CH      | 4.0pF              | ±0.05pF            | GRM1552C2A4R0WA01# |
|        |               |         |         |                    | ±0.1pF             | GRM1552C2A4R0BA01# |
|        |               |         |         |                    | ±0.25pF            | GRM1552C2A4R0CA01# |
|        |               |         |         | 4.1pF              | ±0.05pF            | GRM1552C2A4R1WA01# |
|        |               |         |         |                    | ±0.1pF             | GRM1552C2A4R1BA01# |
|        |               |         |         |                    | ±0.25pF            | GRM1552C2A4R1CA01# |
|        |               |         |         | 4.2pF              | ±0.05pF            | GRM1552C2A4R2WA01# |
|        |               |         |         |                    | ±0.1pF             | GRM1552C2A4R2BA01# |
|        |               | ±0.25pF |         |                    | GRM1552C2A4R2CA01# |                    |
|        |               | 4.3pF   |         | ±0.05pF            | GRM1552C2A4R3WA01# |                    |
|        |               |         |         | ±0.1pF             | GRM1552C2A4R3BA01# |                    |
|        |               |         |         | ±0.25pF            | GRM1552C2A4R3CA01# |                    |
|        |               | 4.4pF   | ±0.05pF | GRM1552C2A4R4WA01# |                    |                    |
|        |               |         | ±0.1pF  | GRM1552C2A4R4BA01# |                    |                    |
|        |               |         | ±0.25pF | GRM1552C2A4R4CA01# |                    |                    |
|        |               | 4.5pF   | ±0.05pF | GRM1552C2A4R5WA01# |                    |                    |
|        |               |         | ±0.1pF  | GRM1552C2A4R5BA01# |                    |                    |
|        |               |         | ±0.25pF | GRM1552C2A4R5CA01# |                    |                    |
|        |               | 4.6pF   | ±0.05pF | GRM1552C2A4R6WA01# |                    |                    |
|        |               |         | ±0.1pF  | GRM1552C2A4R6BA01# |                    |                    |
|        |               |         | ±0.25pF | GRM1552C2A4R6CA01# |                    |                    |
|        |               | 4.7pF   | ±0.05pF | GRM1552C2A4R7WA01# |                    |                    |
|        |               |         | ±0.1pF  | GRM1552C2A4R7BA01# |                    |                    |
|        |               |         | ±0.25pF | GRM1552C2A4R7CA01# |                    |                    |
|        |               | 4.8pF   | ±0.05pF | GRM1552C2A4R8WA01# |                    |                    |
|        |               |         | ±0.1pF  | GRM1552C2A4R8BA01# |                    |                    |
|        |               |         | ±0.25pF | GRM1552C2A4R8CA01# |                    |                    |
|        |               | 4.9pF   | ±0.05pF | GRM1552C2A4R9WA01# |                    |                    |
|        |               |         | ±0.1pF  | GRM1552C2A4R9BA01# |                    |                    |
|        |               |         | ±0.25pF | GRM1552C2A4R9CA01# |                    |                    |
|        |               | 5.0pF   | ±0.05pF | GRM1552C2A5R0WA01# |                    |                    |
|        |               |         | ±0.1pF  | GRM1552C2A5R0BA01# |                    |                    |
|        |               |         | ±0.25pF | GRM1552C2A5R0CA01# |                    |                    |
|        |               | 5.1pF   | ±0.05pF | GRM1552C2A5R1WA01# |                    |                    |
|        |               |         | ±0.1pF  | GRM1552C2A5R1BA01# |                    |                    |
|        |               |         | ±0.25pF | GRM1552C2A5R1CA01# |                    |                    |
|        |               |         | ±0.5pF  | GRM1552C2A5R1DA01# |                    |                    |
|        |               | 5.2pF   | ±0.05pF | GRM1552C2A5R2WA01# |                    |                    |
|        |               |         | ±0.1pF  | GRM1552C2A5R2BA01# |                    |                    |
|        |               |         | ±0.25pF | GRM1552C2A5R2CA01# |                    |                    |
|        |               |         | ±0.5pF  | GRM1552C2A5R2DA01# |                    |                    |
|        |               | 5.3pF   | ±0.05pF | GRM1552C2A5R3WA01# |                    |                    |
|        |               |         | ±0.1pF  | GRM1552C2A5R3BA01# |                    |                    |
|        |               |         | ±0.25pF | GRM1552C2A5R3CA01# |                    |                    |
|        |               |         | ±0.5pF  | GRM1552C2A5R3DA01# |                    |                    |
|        |               | 5.4pF   | ±0.05pF | GRM1552C2A5R4WA01# |                    |                    |
|        |               |         | ±0.1pF  | GRM1552C2A5R4BA01# |                    |                    |
|        |               |         | ±0.25pF | GRM1552C2A5R4CA01# |                    |                    |
|        |               |         | ±0.5pF  | GRM1552C2A5R4DA01# |                    |                    |
|        |               | 5.5pF   | ±0.05pF | GRM1552C2A5R5WA01# |                    |                    |

| T max.  | Rated Voltage      | TC Code            | Cap.  | Tol.    | Part Number        |
|---------|--------------------|--------------------|-------|---------|--------------------|
| 0.55mm  | 100Vdc             | CH                 | 5.5pF | ±0.1pF  | GRM1552C2A5R5BA01# |
|         |                    |                    |       | ±0.25pF | GRM1552C2A5R5CA01# |
|         |                    |                    |       | ±0.5pF  | GRM1552C2A5R5DA01# |
|         |                    |                    | 5.6pF | ±0.05pF | GRM1552C2A5R6WA01# |
|         |                    |                    |       | ±0.1pF  | GRM1552C2A5R6BA01# |
|         |                    |                    |       | ±0.25pF | GRM1552C2A5R6CA01# |
|         |                    |                    |       | ±0.5pF  | GRM1552C2A5R6DA01# |
|         |                    |                    | 5.7pF | ±0.05pF | GRM1552C2A5R7WA01# |
|         |                    |                    |       | ±0.1pF  | GRM1552C2A5R7BA01# |
|         |                    |                    |       | ±0.25pF | GRM1552C2A5R7CA01# |
|         |                    |                    |       | ±0.5pF  | GRM1552C2A5R7DA01# |
|         |                    |                    | 5.8pF | ±0.05pF | GRM1552C2A5R8WA01# |
|         |                    |                    |       | ±0.1pF  | GRM1552C2A5R8BA01# |
|         |                    |                    |       | ±0.25pF | GRM1552C2A5R8CA01# |
|         |                    |                    |       | ±0.5pF  | GRM1552C2A5R8DA01# |
|         |                    |                    | 5.9pF | ±0.05pF | GRM1552C2A5R9WA01# |
|         |                    |                    |       | ±0.1pF  | GRM1552C2A5R9BA01# |
|         |                    |                    |       | ±0.25pF | GRM1552C2A5R9CA01# |
|         |                    |                    |       | ±0.5pF  | GRM1552C2A5R9DA01# |
|         |                    |                    | 6.0pF | ±0.05pF | GRM1552C2A6R0WA01# |
|         |                    |                    |       | ±0.1pF  | GRM1552C2A6R0BA01# |
|         |                    |                    |       | ±0.25pF | GRM1552C2A6R0CA01# |
|         |                    |                    |       | ±0.5pF  | GRM1552C2A6R0DA01# |
|         |                    |                    | 6.1pF | ±0.05pF | GRM1552C2A6R1WA01# |
|         |                    |                    |       | ±0.1pF  | GRM1552C2A6R1BA01# |
|         |                    |                    |       | ±0.25pF | GRM1552C2A6R1CA01# |
|         |                    |                    |       | ±0.5pF  | GRM1552C2A6R1DA01# |
|         |                    |                    | 6.2pF | ±0.05pF | GRM1552C2A6R2WA01# |
|         |                    |                    |       | ±0.1pF  | GRM1552C2A6R2BA01# |
|         |                    |                    |       | ±0.25pF | GRM1552C2A6R2CA01# |
|         |                    |                    |       | ±0.5pF  | GRM1552C2A6R2DA01# |
|         |                    |                    | 6.3pF | ±0.05pF | GRM1552C2A6R3WA01# |
|         |                    |                    |       | ±0.1pF  | GRM1552C2A6R3BA01# |
|         |                    |                    |       | ±0.25pF | GRM1552C2A6R3CA01# |
|         |                    |                    |       | ±0.5pF  | GRM1552C2A6R3DA01# |
|         |                    |                    | 6.4pF | ±0.05pF | GRM1552C2A6R4WA01# |
|         |                    |                    |       | ±0.1pF  | GRM1552C2A6R4BA01# |
|         |                    |                    |       | ±0.25pF | GRM1552C2A6R4CA01# |
|         |                    |                    |       | ±0.5pF  | GRM1552C2A6R4DA01# |
|         |                    |                    | 6.5pF | ±0.05pF | GRM1552C2A6R5WA01# |
|         |                    |                    |       | ±0.1pF  | GRM1552C2A6R5BA01# |
|         |                    |                    |       | ±0.25pF | GRM1552C2A6R5CA01# |
|         |                    |                    |       | ±0.5pF  | GRM1552C2A6R5DA01# |
|         |                    |                    | 6.6pF | ±0.05pF | GRM1552C2A6R6WA01# |
|         |                    |                    |       | ±0.1pF  | GRM1552C2A6R6BA01# |
|         |                    |                    |       | ±0.25pF | GRM1552C2A6R6CA01# |
|         |                    |                    |       | ±0.5pF  | GRM1552C2A6R6DA01# |
|         |                    |                    | 6.7pF | ±0.05pF | GRM1552C2A6R7WA01# |
| ±0.1pF  | GRM1552C2A6R7BA01# |                    |       |         |                    |
| ±0.25pF | GRM1552C2A6R7CA01# |                    |       |         |                    |
| ±0.5pF  | GRM1552C2A6R7DA01# |                    |       |         |                    |
| 6.8pF   | ±0.05pF            | GRM1552C2A6R8WA01# |       |         |                    |
|         | ±0.1pF             | GRM1552C2A6R8BA01# |       |         |                    |
|         | ±0.25pF            | GRM1552C2A6R8CA01# |       |         |                    |

Part number # indicates the package specification code.

## GRM Series Temperature Compensating Type Part Number List

(→ ■ 1.0x0.5mm)

| T max. | Rated Voltage | TC Code | Cap.    | Tol.    | Part Number        |
|--------|---------------|---------|---------|---------|--------------------|
| 0.55mm | 100Vdc        | CH      | 6.8pF   | ±0.5pF  | GRM1552C2A6R8DA01# |
|        |               |         |         | ±0.05pF | GRM1552C2A6R9WA01# |
|        |               |         | 6.9pF   | ±0.1pF  | GRM1552C2A6R9BA01# |
|        |               |         |         | ±0.25pF | GRM1552C2A6R9CA01# |
|        |               |         |         | ±0.5pF  | GRM1552C2A6R9DA01# |
|        |               |         |         | 7.0pF   | ±0.05pF            |
|        |               |         | ±0.1pF  |         | GRM1552C2A7R0BA01# |
|        |               |         | ±0.25pF |         | GRM1552C2A7R0CA01# |
|        |               |         | ±0.5pF  |         | GRM1552C2A7R0DA01# |
|        |               |         | 7.1pF   | ±0.05pF | GRM1552C2A7R1WA01# |
|        |               |         |         | ±0.1pF  | GRM1552C2A7R1BA01# |
|        |               |         |         | ±0.25pF | GRM1552C2A7R1CA01# |
|        |               |         |         | ±0.5pF  | GRM1552C2A7R1DA01# |
|        |               |         | 7.2pF   | ±0.05pF | GRM1552C2A7R2WA01# |
|        |               |         |         | ±0.1pF  | GRM1552C2A7R2BA01# |
|        |               |         |         | ±0.25pF | GRM1552C2A7R2CA01# |
|        |               |         |         | ±0.5pF  | GRM1552C2A7R2DA01# |
|        |               |         | 7.3pF   | ±0.05pF | GRM1552C2A7R3WA01# |
|        |               |         |         | ±0.1pF  | GRM1552C2A7R3BA01# |
|        |               |         |         | ±0.25pF | GRM1552C2A7R3CA01# |
|        |               |         |         | ±0.5pF  | GRM1552C2A7R3DA01# |
|        |               |         | 7.4pF   | ±0.05pF | GRM1552C2A7R4WA01# |
|        |               |         |         | ±0.1pF  | GRM1552C2A7R4BA01# |
|        |               |         |         | ±0.25pF | GRM1552C2A7R4CA01# |
|        |               |         |         | ±0.5pF  | GRM1552C2A7R4DA01# |
|        |               |         | 7.5pF   | ±0.05pF | GRM1552C2A7R5WA01# |
|        |               |         |         | ±0.1pF  | GRM1552C2A7R5BA01# |
|        |               |         |         | ±0.25pF | GRM1552C2A7R5CA01# |
|        |               |         |         | ±0.5pF  | GRM1552C2A7R5DA01# |
|        |               |         | 7.6pF   | ±0.05pF | GRM1552C2A7R6WA01# |
|        |               |         |         | ±0.1pF  | GRM1552C2A7R6BA01# |
|        |               |         |         | ±0.25pF | GRM1552C2A7R6CA01# |
|        |               |         |         | ±0.5pF  | GRM1552C2A7R6DA01# |
|        |               |         | 7.7pF   | ±0.05pF | GRM1552C2A7R7WA01# |
|        |               |         |         | ±0.1pF  | GRM1552C2A7R7BA01# |
|        |               |         |         | ±0.25pF | GRM1552C2A7R7CA01# |
|        |               |         |         | ±0.5pF  | GRM1552C2A7R7DA01# |
|        |               |         | 7.8pF   | ±0.05pF | GRM1552C2A7R8WA01# |
|        |               |         |         | ±0.1pF  | GRM1552C2A7R8BA01# |
|        |               |         |         | ±0.25pF | GRM1552C2A7R8CA01# |
|        |               |         |         | ±0.5pF  | GRM1552C2A7R8DA01# |
|        |               |         | 7.9pF   | ±0.05pF | GRM1552C2A7R9WA01# |
|        |               |         |         | ±0.1pF  | GRM1552C2A7R9BA01# |
|        |               |         |         | ±0.25pF | GRM1552C2A7R9CA01# |
|        |               |         |         | ±0.5pF  | GRM1552C2A7R9DA01# |
|        |               |         | 8.0pF   | ±0.05pF | GRM1552C2A8R0WA01# |
|        |               |         |         | ±0.1pF  | GRM1552C2A8R0BA01# |
|        |               |         |         | ±0.25pF | GRM1552C2A8R0CA01# |
|        |               |         |         | ±0.5pF  | GRM1552C2A8R0DA01# |
|        |               |         | 8.1pF   | ±0.05pF | GRM1552C2A8R1WA01# |
|        |               |         |         | ±0.1pF  | GRM1552C2A8R1BA01# |
|        |               |         |         | ±0.25pF | GRM1552C2A8R1CA01# |
|        |               |         |         | ±0.5pF  | GRM1552C2A8R1DA01# |
|        |               |         | 8.2pF   | ±0.05pF | GRM1552C2A8R2WA01# |

| T max. | Rated Voltage | TC Code | Cap.  | Tol.    | Part Number        |
|--------|---------------|---------|-------|---------|--------------------|
| 0.55mm | 100Vdc        | CH      | 8.2pF | ±0.1pF  | GRM1552C2A8R2BA01# |
|        |               |         |       | ±0.25pF | GRM1552C2A8R2CA01# |
|        |               |         |       | ±0.5pF  | GRM1552C2A8R2DA01# |
|        |               |         | 8.3pF | ±0.05pF | GRM1552C2A8R3WA01# |
|        |               |         |       | ±0.1pF  | GRM1552C2A8R3BA01# |
|        |               |         |       | ±0.25pF | GRM1552C2A8R3CA01# |
|        |               |         | 8.4pF | ±0.05pF | GRM1552C2A8R4WA01# |
|        |               |         |       | ±0.1pF  | GRM1552C2A8R4BA01# |
|        |               |         |       | ±0.25pF | GRM1552C2A8R4CA01# |
|        |               |         | 8.5pF | ±0.05pF | GRM1552C2A8R5WA01# |
|        |               |         |       | ±0.1pF  | GRM1552C2A8R5BA01# |
|        |               |         |       | ±0.25pF | GRM1552C2A8R5CA01# |
|        |               |         | 8.6pF | ±0.05pF | GRM1552C2A8R6WA01# |
|        |               |         |       | ±0.1pF  | GRM1552C2A8R6BA01# |
|        |               |         |       | ±0.25pF | GRM1552C2A8R6CA01# |
|        |               |         | 8.7pF | ±0.05pF | GRM1552C2A8R7WA01# |
|        |               |         |       | ±0.1pF  | GRM1552C2A8R7BA01# |
|        |               |         |       | ±0.25pF | GRM1552C2A8R7CA01# |
|        |               |         | 8.8pF | ±0.05pF | GRM1552C2A8R8WA01# |
|        |               |         |       | ±0.1pF  | GRM1552C2A8R8BA01# |
|        |               |         |       | ±0.25pF | GRM1552C2A8R8CA01# |
|        |               |         | 8.9pF | ±0.05pF | GRM1552C2A8R9WA01# |
|        |               |         |       | ±0.1pF  | GRM1552C2A8R9BA01# |
|        |               |         |       | ±0.25pF | GRM1552C2A8R9CA01# |
|        |               |         | 9.0pF | ±0.05pF | GRM1552C2A9R0WA01# |
|        |               |         |       | ±0.1pF  | GRM1552C2A9R0BA01# |
|        |               |         |       | ±0.25pF | GRM1552C2A9R0CA01# |
|        |               |         | 9.1pF | ±0.05pF | GRM1552C2A9R1WA01# |
|        |               |         |       | ±0.1pF  | GRM1552C2A9R1BA01# |
|        |               |         |       | ±0.25pF | GRM1552C2A9R1CA01# |
|        |               |         | 9.2pF | ±0.05pF | GRM1552C2A9R2WA01# |
|        |               |         |       | ±0.1pF  | GRM1552C2A9R2BA01# |
|        |               |         |       | ±0.25pF | GRM1552C2A9R2CA01# |
|        |               |         | 9.3pF | ±0.05pF | GRM1552C2A9R3WA01# |
|        |               |         |       | ±0.1pF  | GRM1552C2A9R3BA01# |
|        |               |         |       | ±0.25pF | GRM1552C2A9R3CA01# |
|        |               |         | 9.4pF | ±0.05pF | GRM1552C2A9R4WA01# |
|        |               |         |       | ±0.1pF  | GRM1552C2A9R4BA01# |
|        |               |         |       | ±0.25pF | GRM1552C2A9R4CA01# |
|        |               |         | 9.5pF | ±0.05pF | GRM1552C2A9R5WA01# |
|        |               |         |       | ±0.1pF  | GRM1552C2A9R5BA01# |
|        |               |         |       | ±0.25pF | GRM1552C2A9R5CA01# |

Part number # indicates the package specification code.

GRM Series  
GJM Series  
GMA Series  
GMD Series  
GQM Series  
GRJ Series  
GR3 Series  
KRM Series  
KR3 Series  
LLA Series  
LLL Series  
LLM Series  
LLR Series  
⚠Caution/ Notice

## GRM Series Temperature Compensating Type Part Number List

(→ ■ 1.0x0.5mm)

| T max. | Rated Voltage      | TC Code            | Cap.  | Tol.    | Part Number        |                    |                    |
|--------|--------------------|--------------------|-------|---------|--------------------|--------------------|--------------------|
| 0.55mm | 100Vdc             | CH                 | 9.5pF | ±0.5pF  | GRM1552C2A9R5DA01# |                    |                    |
|        |                    |                    |       | ±0.05pF | GRM1552C2A9R6WA01# |                    |                    |
|        |                    |                    |       |         | ±0.1pF             | GRM1552C2A9R6BA01# |                    |
|        |                    |                    |       |         | ±0.25pF            | GRM1552C2A9R6CA01# |                    |
|        |                    |                    |       |         | ±0.5pF             | GRM1552C2A9R6DA01# |                    |
|        |                    |                    | 9.7pF | ±0.05pF | GRM1552C2A9R7WA01# |                    |                    |
|        |                    |                    |       | ±0.1pF  | GRM1552C2A9R7BA01# |                    |                    |
|        |                    |                    |       | ±0.25pF | GRM1552C2A9R7CA01# |                    |                    |
|        |                    |                    |       | ±0.5pF  | GRM1552C2A9R7DA01# |                    |                    |
|        |                    |                    | 9.8pF | ±0.05pF | GRM1552C2A9R8WA01# |                    |                    |
|        |                    |                    |       | ±0.1pF  | GRM1552C2A9R8BA01# |                    |                    |
|        |                    |                    |       | ±0.25pF | GRM1552C2A9R8CA01# |                    |                    |
|        |                    |                    |       | ±0.5pF  | GRM1552C2A9R8DA01# |                    |                    |
|        |                    |                    | 9.9pF | ±0.05pF | GRM1552C2A9R9WA01# |                    |                    |
|        |                    |                    |       | ±0.1pF  | GRM1552C2A9R9BA01# |                    |                    |
|        |                    |                    |       | ±0.25pF | GRM1552C2A9R9CA01# |                    |                    |
|        |                    |                    |       | ±0.5pF  | GRM1552C2A9R9DA01# |                    |                    |
|        |                    |                    | 10pF  | ±2%     | GRM1552C2A100GA01# |                    |                    |
|        |                    |                    |       | ±5%     | GRM1552C2A100JA01# |                    |                    |
|        |                    |                    | 12pF  | ±2%     | GRM1552C2A120GA01# |                    |                    |
|        |                    |                    |       | ±5%     | GRM1552C2A120JA01# |                    |                    |
|        |                    |                    | 15pF  | ±2%     | GRM1552C2A150GA01# |                    |                    |
|        |                    |                    |       | ±5%     | GRM1552C2A150JA01# |                    |                    |
|        |                    |                    | 18pF  | ±2%     | GRM1552C2A180GA01# |                    |                    |
|        |                    |                    |       | ±5%     | GRM1552C2A180JA01# |                    |                    |
|        |                    |                    | 22pF  | ±2%     | GRM1552C2A220GA01# |                    |                    |
|        |                    |                    |       | ±5%     | GRM1552C2A220JA01# |                    |                    |
|        |                    |                    | 27pF  | ±2%     | GRM1552C2A270GA01# |                    |                    |
|        |                    |                    |       | ±5%     | GRM1552C2A270JA01# |                    |                    |
|        |                    |                    | 33pF  | ±2%     | GRM1552C2A330GA01# |                    |                    |
|        |                    |                    |       | ±5%     | GRM1552C2A330JA01# |                    |                    |
|        |                    |                    | 39pF  | ±2%     | GRM1552C2A390GA01# |                    |                    |
|        |                    |                    |       | ±5%     | GRM1552C2A390JA01# |                    |                    |
|        |                    |                    | 47pF  | ±2%     | GRM1552C2A470GA01# |                    |                    |
|        |                    |                    |       | ±5%     | GRM1552C2A470JA01# |                    |                    |
|        |                    |                    | 56pF  | ±2%     | GRM1552C2A560GA01# |                    |                    |
|        |                    |                    |       | ±5%     | GRM1552C2A560JA01# |                    |                    |
|        |                    |                    | 68pF  | ±2%     | GRM1552C2A680GA01# |                    |                    |
|        |                    |                    |       | ±5%     | GRM1552C2A680JA01# |                    |                    |
|        |                    |                    | 82pF  | ±2%     | GRM1552C2A820GA01# |                    |                    |
|        |                    |                    |       | ±5%     | GRM1552C2A820JA01# |                    |                    |
|        |                    |                    | 100pF | ±2%     | GRM1552C2A101GA01# |                    |                    |
|        |                    |                    |       | ±5%     | GRM1552C2A101JA01# |                    |                    |
|        |                    |                    | 50Vdc | C0G     | 0.10pF             | ±0.05pF            | GRM1555C1HR10WA01# |
|        |                    |                    |       |         |                    | ±0.05pF            | GRM1555C1HR20WA01# |
|        |                    |                    |       |         |                    |                    | ±0.1pF             |
|        |                    |                    |       |         | 0.30pF             | ±0.05pF            | GRM1555C1HR30WA01# |
|        |                    |                    |       |         |                    | ±0.05pF            | GRM1555C1HR30BA01# |
| ±0.1pF | GRM1555C1HR30CA01# |                    |       |         |                    |                    |                    |
| 0.40pF | ±0.05pF            | GRM1555C1HR40WA01# |       |         |                    |                    |                    |
|        | ±0.05pF            | GRM1555C1HR40BA01# |       |         |                    |                    |                    |
|        |                    | ±0.1pF             |       |         | GRM1555C1HR40CA01# |                    |                    |
| 0.50pF | ±0.05pF            | GRM1555C1HR50WA01# |       |         |                    |                    |                    |
|        | ±0.05pF            | GRM1555C1HR50BA01# |       |         |                    |                    |                    |
|        |                    | ±0.1pF             |       |         | GRM1555C1HR50CA01# |                    |                    |
| 0.60pF | ±0.05pF            | GRM1555C1HR60WA01# |       |         |                    |                    |                    |
|        | ±0.05pF            | GRM1555C1HR60BA01# |       |         |                    |                    |                    |
|        |                    | ±0.1pF             |       |         | GRM1555C1HR60CA01# |                    |                    |

| T max. | Rated Voltage | TC Code            | Cap.   | Tol.    | Part Number        |
|--------|---------------|--------------------|--------|---------|--------------------|
| 0.55mm | 50Vdc         | C0G                | 0.70pF | ±0.05pF | GRM1555C1HR70WA01# |
|        |               |                    |        | ±0.1pF  | GRM1555C1HR70BA01# |
|        |               |                    | 0.80pF | ±0.05pF | GRM1555C1HR80WA01# |
|        |               |                    |        | ±0.1pF  | GRM1555C1HR80BA01# |
|        |               |                    | 0.90pF | ±0.05pF | GRM1555C1HR90WA01# |
|        |               |                    |        | ±0.1pF  | GRM1555C1HR90BA01# |
|        |               |                    | 1.0pF  | ±0.05pF | GRM1555C1H1R0WA01# |
|        |               |                    |        | ±0.1pF  | GRM1555C1H1R0BA01# |
|        |               |                    |        | ±0.25pF | GRM1555C1H1R0CA01# |
|        |               |                    | 1.1pF  | ±0.05pF | GRM1555C1H1R1WA01# |
|        |               |                    |        | ±0.1pF  | GRM1555C1H1R1BA01# |
|        |               |                    |        | ±0.25pF | GRM1555C1H1R1CA01# |
|        |               |                    | 1.2pF  | ±0.05pF | GRM1555C1H1R2WA01# |
|        |               |                    |        | ±0.1pF  | GRM1555C1H1R2BA01# |
|        |               |                    |        | ±0.25pF | GRM1555C1H1R2CA01# |
|        |               |                    | 1.3pF  | ±0.05pF | GRM1555C1H1R3WA01# |
|        |               |                    |        | ±0.1pF  | GRM1555C1H1R3BA01# |
|        |               |                    |        | ±0.25pF | GRM1555C1H1R3CA01# |
|        |               |                    | 1.4pF  | ±0.05pF | GRM1555C1H1R4WA01# |
|        |               |                    |        | ±0.1pF  | GRM1555C1H1R4BA01# |
|        |               |                    |        | ±0.25pF | GRM1555C1H1R4CA01# |
|        |               |                    | 1.5pF  | ±0.05pF | GRM1555C1H1R5WA01# |
|        |               |                    |        | ±0.1pF  | GRM1555C1H1R5BA01# |
|        |               |                    |        | ±0.25pF | GRM1555C1H1R5CA01# |
|        |               |                    | 1.6pF  | ±0.05pF | GRM1555C1H1R6WA01# |
|        |               |                    |        | ±0.1pF  | GRM1555C1H1R6BA01# |
|        |               |                    |        | ±0.25pF | GRM1555C1H1R6CA01# |
|        |               |                    | 1.7pF  | ±0.05pF | GRM1555C1H1R7WA01# |
|        |               |                    |        | ±0.1pF  | GRM1555C1H1R7BA01# |
|        |               |                    |        | ±0.25pF | GRM1555C1H1R7CA01# |
|        |               |                    | 1.8pF  | ±0.05pF | GRM1555C1H1R8WA01# |
|        |               |                    |        | ±0.1pF  | GRM1555C1H1R8BA01# |
|        |               |                    |        | ±0.25pF | GRM1555C1H1R8CA01# |
|        |               |                    | 1.9pF  | ±0.05pF | GRM1555C1H1R9WA01# |
|        |               |                    |        | ±0.1pF  | GRM1555C1H1R9BA01# |
|        |               |                    |        | ±0.25pF | GRM1555C1H1R9CA01# |
|        |               |                    | 2.0pF  | ±0.05pF | GRM1555C1H2R0WA01# |
|        |               |                    |        | ±0.1pF  | GRM1555C1H2R0BA01# |
|        |               |                    |        | ±0.25pF | GRM1555C1H2R0CA01# |
|        |               |                    | 2.1pF  | ±0.05pF | GRM1555C1H2R1WA01# |
|        |               |                    |        | ±0.1pF  | GRM1555C1H2R1BA01# |
|        |               |                    |        | ±0.25pF | GRM1555C1H2R1CA01# |
|        |               |                    | 2.2pF  | ±0.05pF | GRM1555C1H2R2WA01# |
|        |               |                    |        | ±0.1pF  | GRM1555C1H2R2BA01# |
|        |               |                    |        | ±0.25pF | GRM1555C1H2R2CA01# |
|        |               |                    | 2.3pF  | ±0.05pF | GRM1555C1H2R3WA01# |
|        |               |                    |        | ±0.1pF  | GRM1555C1H2R3BA01# |
|        |               |                    |        | ±0.25pF | GRM1555C1H2R3CA01# |
| 2.4pF  | ±0.05pF       | GRM1555C1H2R4WA01# |        |         |                    |
|        | ±0.1pF        | GRM1555C1H2R4BA01# |        |         |                    |
|        | ±0.25pF       | GRM1555C1H2R4CA01# |        |         |                    |
| 2.5pF  | ±0.05pF       | GRM1555C1H2R5WA01# |        |         |                    |
|        | ±0.1pF        | GRM1555C1H2R5BA01# |        |         |                    |
|        | ±0.25pF       | GRM1555C1H2R5CA01# |        |         |                    |

Part number # indicates the package specification code.



## GRM Series Temperature Compensating Type Part Number List

(→ ■ 1.0x0.5mm)

| T max. | Rated Voltage | TC Code            | Cap.  | Tol.    | Part Number        |
|--------|---------------|--------------------|-------|---------|--------------------|
| 0.55mm | 50Vdc         | C0G                | 2.6pF | ±0.05pF | GRM1555C1H2R6WA01# |
|        |               |                    |       | ±0.1pF  | GRM1555C1H2R6BA01# |
|        |               |                    |       | ±0.25pF | GRM1555C1H2R6CA01# |
|        |               |                    | 2.7pF | ±0.05pF | GRM1555C1H2R7WA01# |
|        |               |                    |       | ±0.1pF  | GRM1555C1H2R7BA01# |
|        |               |                    |       | ±0.25pF | GRM1555C1H2R7CA01# |
|        |               |                    | 2.8pF | ±0.05pF | GRM1555C1H2R8WA01# |
|        |               |                    |       | ±0.1pF  | GRM1555C1H2R8BA01# |
|        |               |                    |       | ±0.25pF | GRM1555C1H2R8CA01# |
|        |               |                    | 2.9pF | ±0.05pF | GRM1555C1H2R9WA01# |
|        |               |                    |       | ±0.1pF  | GRM1555C1H2R9BA01# |
|        |               |                    |       | ±0.25pF | GRM1555C1H2R9CA01# |
|        |               |                    | 3.0pF | ±0.05pF | GRM1555C1H3R0WA01# |
|        |               |                    |       | ±0.1pF  | GRM1555C1H3R0BA01# |
|        |               |                    |       | ±0.25pF | GRM1555C1H3R0CA01# |
|        |               |                    | 3.1pF | ±0.05pF | GRM1555C1H3R1WA01# |
|        |               |                    |       | ±0.1pF  | GRM1555C1H3R1BA01# |
|        |               |                    |       | ±0.25pF | GRM1555C1H3R1CA01# |
|        |               |                    | 3.2pF | ±0.05pF | GRM1555C1H3R2WA01# |
|        |               |                    |       | ±0.1pF  | GRM1555C1H3R2BA01# |
|        |               |                    |       | ±0.25pF | GRM1555C1H3R2CA01# |
|        |               |                    | 3.3pF | ±0.05pF | GRM1555C1H3R3WA01# |
|        |               |                    |       | ±0.1pF  | GRM1555C1H3R3BA01# |
|        |               |                    |       | ±0.25pF | GRM1555C1H3R3CA01# |
|        |               |                    | 3.4pF | ±0.05pF | GRM1555C1H3R4WA01# |
|        |               |                    |       | ±0.1pF  | GRM1555C1H3R4BA01# |
|        |               |                    |       | ±0.25pF | GRM1555C1H3R4CA01# |
|        |               |                    | 3.5pF | ±0.05pF | GRM1555C1H3R5WA01# |
|        |               |                    |       | ±0.1pF  | GRM1555C1H3R5BA01# |
|        |               |                    |       | ±0.25pF | GRM1555C1H3R5CA01# |
|        |               |                    | 3.6pF | ±0.05pF | GRM1555C1H3R6WA01# |
|        |               |                    |       | ±0.1pF  | GRM1555C1H3R6BA01# |
|        |               |                    |       | ±0.25pF | GRM1555C1H3R6CA01# |
|        |               |                    | 3.7pF | ±0.05pF | GRM1555C1H3R7WA01# |
|        |               |                    |       | ±0.1pF  | GRM1555C1H3R7BA01# |
|        |               |                    |       | ±0.25pF | GRM1555C1H3R7CA01# |
|        |               |                    | 3.8pF | ±0.05pF | GRM1555C1H3R8WA01# |
|        |               |                    |       | ±0.1pF  | GRM1555C1H3R8BA01# |
|        |               |                    |       | ±0.25pF | GRM1555C1H3R8CA01# |
|        |               |                    | 3.9pF | ±0.05pF | GRM1555C1H3R9WA01# |
|        |               |                    |       | ±0.1pF  | GRM1555C1H3R9BA01# |
|        |               |                    |       | ±0.25pF | GRM1555C1H3R9CA01# |
|        |               |                    | 4.0pF | ±0.05pF | GRM1555C1H4R0WA01# |
|        |               |                    |       | ±0.1pF  | GRM1555C1H4R0BA01# |
|        |               |                    |       | ±0.25pF | GRM1555C1H4R0CA01# |
|        |               |                    | 4.1pF | ±0.05pF | GRM1555C1H4R1WA01# |
|        |               |                    |       | ±0.1pF  | GRM1555C1H4R1BA01# |
|        |               |                    |       | ±0.25pF | GRM1555C1H4R1CA01# |
| 4.2pF  | ±0.05pF       | GRM1555C1H4R2WA01# |       |         |                    |
|        | ±0.1pF        | GRM1555C1H4R2BA01# |       |         |                    |
|        | ±0.25pF       | GRM1555C1H4R2CA01# |       |         |                    |
| 4.3pF  | ±0.05pF       | GRM1555C1H4R3WA01# |       |         |                    |
|        | ±0.1pF        | GRM1555C1H4R3BA01# |       |         |                    |
|        | ±0.25pF       | GRM1555C1H4R3CA01# |       |         |                    |

| T max. | Rated Voltage | TC Code | Cap.  | Tol.    | Part Number        |
|--------|---------------|---------|-------|---------|--------------------|
| 0.55mm | 50Vdc         | C0G     | 4.4pF | ±0.05pF | GRM1555C1H4R4WA01# |
|        |               |         |       | ±0.1pF  | GRM1555C1H4R4BA01# |
|        |               |         |       | ±0.25pF | GRM1555C1H4R4CA01# |
|        |               |         | 4.5pF | ±0.05pF | GRM1555C1H4R5WA01# |
|        |               |         |       | ±0.1pF  | GRM1555C1H4R5BA01# |
|        |               |         |       | ±0.25pF | GRM1555C1H4R5CA01# |
|        |               |         | 4.6pF | ±0.05pF | GRM1555C1H4R6WA01# |
|        |               |         |       | ±0.1pF  | GRM1555C1H4R6BA01# |
|        |               |         |       | ±0.25pF | GRM1555C1H4R6CA01# |
|        |               |         | 4.7pF | ±0.05pF | GRM1555C1H4R7WA01# |
|        |               |         |       | ±0.1pF  | GRM1555C1H4R7BA01# |
|        |               |         |       | ±0.25pF | GRM1555C1H4R7CA01# |
|        |               |         | 4.8pF | ±0.05pF | GRM1555C1H4R8WA01# |
|        |               |         |       | ±0.1pF  | GRM1555C1H4R8BA01# |
|        |               |         |       | ±0.25pF | GRM1555C1H4R8CA01# |
|        |               |         | 4.9pF | ±0.05pF | GRM1555C1H4R9WA01# |
|        |               |         |       | ±0.1pF  | GRM1555C1H4R9BA01# |
|        |               |         |       | ±0.25pF | GRM1555C1H4R9CA01# |
|        |               |         | 5.0pF | ±0.05pF | GRM1555C1H5R0WA01# |
|        |               |         |       | ±0.1pF  | GRM1555C1H5R0BA01# |
|        |               |         |       | ±0.25pF | GRM1555C1H5R0CA01# |
|        |               |         | 5.1pF | ±0.05pF | GRM1555C1H5R1WA01# |
|        |               |         |       | ±0.1pF  | GRM1555C1H5R1BA01# |
|        |               |         |       | ±0.25pF | GRM1555C1H5R1CA01# |
|        |               |         | 5.2pF | ±0.05pF | GRM1555C1H5R2WA01# |
|        |               |         |       | ±0.1pF  | GRM1555C1H5R2BA01# |
|        |               |         |       | ±0.25pF | GRM1555C1H5R2CA01# |
|        |               |         | 5.3pF | ±0.05pF | GRM1555C1H5R3WA01# |
|        |               |         |       | ±0.1pF  | GRM1555C1H5R3BA01# |
|        |               |         |       | ±0.25pF | GRM1555C1H5R3CA01# |
|        |               |         | 5.4pF | ±0.05pF | GRM1555C1H5R4WA01# |
|        |               |         |       | ±0.1pF  | GRM1555C1H5R4BA01# |
|        |               |         |       | ±0.25pF | GRM1555C1H5R4CA01# |
|        |               |         | 5.5pF | ±0.05pF | GRM1555C1H5R5WA01# |
|        |               |         |       | ±0.1pF  | GRM1555C1H5R5BA01# |
|        |               |         |       | ±0.25pF | GRM1555C1H5R5CA01# |
|        |               |         | 5.6pF | ±0.05pF | GRM1555C1H5R6WA01# |
|        |               |         |       | ±0.1pF  | GRM1555C1H5R6BA01# |
|        |               |         |       | ±0.25pF | GRM1555C1H5R6CA01# |
|        |               |         | 5.7pF | ±0.05pF | GRM1555C1H5R7WA01# |
|        |               |         |       | ±0.1pF  | GRM1555C1H5R7BA01# |
|        |               |         |       | ±0.25pF | GRM1555C1H5R7CA01# |
|        |               |         | 5.8pF | ±0.05pF | GRM1555C1H5R8WA01# |
|        |               |         |       | ±0.1pF  | GRM1555C1H5R8BA01# |
|        |               |         |       | ±0.25pF | GRM1555C1H5R8CA01# |
|        |               |         | 5.9pF | ±0.05pF | GRM1555C1H5R9WA01# |
|        |               |         |       | ±0.1pF  | GRM1555C1H5R9BA01# |
|        |               |         |       | ±0.25pF | GRM1555C1H5R9CA01# |

Part number # indicates the package specification code.

GRM Series  
GJM Series  
GMA Series  
GMD Series  
GQM Series  
GRJ Series  
GR3 Series  
KRM Series  
KR3 Series  
LLA Series  
LLL Series  
LLM Series  
LLR Series  
⚠Caution/Notice

# GRM Series Temperature Compensating Type Part Number List

(→ ■ 1.0x0.5mm)

| T max. | Rated Voltage | TC Code | Cap.  | Tol.    | Part Number        |
|--------|---------------|---------|-------|---------|--------------------|
| 0.55mm | 50Vdc         | COG     | 5.9pF | ±0.1pF  | GRM1555C1H5R9BA01# |
|        |               |         |       | ±0.25pF | GRM1555C1H5R9CA01# |
|        |               |         |       | ±0.5pF  | GRM1555C1H5R9DA01# |
|        |               |         | 6.0pF | ±0.05pF | GRM1555C1H6R0WA01# |
|        |               |         |       | ±0.1pF  | GRM1555C1H6R0BA01# |
|        |               |         |       | ±0.25pF | GRM1555C1H6R0CA01# |
|        |               |         | 6.1pF | ±0.05pF | GRM1555C1H6R1WA01# |
|        |               |         |       | ±0.1pF  | GRM1555C1H6R1BA01# |
|        |               |         |       | ±0.25pF | GRM1555C1H6R1CA01# |
|        |               |         | 6.2pF | ±0.05pF | GRM1555C1H6R2WA01# |
|        |               |         |       | ±0.1pF  | GRM1555C1H6R2BA01# |
|        |               |         |       | ±0.25pF | GRM1555C1H6R2CA01# |
|        |               |         | 6.3pF | ±0.05pF | GRM1555C1H6R3WA01# |
|        |               |         |       | ±0.1pF  | GRM1555C1H6R3BA01# |
|        |               |         |       | ±0.25pF | GRM1555C1H6R3CA01# |
|        |               |         | 6.4pF | ±0.05pF | GRM1555C1H6R4WA01# |
|        |               |         |       | ±0.1pF  | GRM1555C1H6R4BA01# |
|        |               |         |       | ±0.25pF | GRM1555C1H6R4CA01# |
|        |               |         | 6.5pF | ±0.05pF | GRM1555C1H6R5WA01# |
|        |               |         |       | ±0.1pF  | GRM1555C1H6R5BA01# |
|        |               |         |       | ±0.25pF | GRM1555C1H6R5CA01# |
|        |               |         | 6.6pF | ±0.05pF | GRM1555C1H6R6WA01# |
|        |               |         |       | ±0.1pF  | GRM1555C1H6R6BA01# |
|        |               |         |       | ±0.25pF | GRM1555C1H6R6CA01# |
|        |               |         | 6.7pF | ±0.05pF | GRM1555C1H6R7WA01# |
|        |               |         |       | ±0.1pF  | GRM1555C1H6R7BA01# |
|        |               |         |       | ±0.25pF | GRM1555C1H6R7CA01# |
|        |               |         | 6.8pF | ±0.05pF | GRM1555C1H6R8WA01# |
|        |               |         |       | ±0.1pF  | GRM1555C1H6R8BA01# |
|        |               |         |       | ±0.25pF | GRM1555C1H6R8CA01# |
|        |               |         | 6.9pF | ±0.05pF | GRM1555C1H6R9WA01# |
|        |               |         |       | ±0.1pF  | GRM1555C1H6R9BA01# |
|        |               |         |       | ±0.25pF | GRM1555C1H6R9CA01# |
|        |               |         | 7.0pF | ±0.05pF | GRM1555C1H7R0WA01# |
|        |               |         |       | ±0.1pF  | GRM1555C1H7R0BA01# |
|        |               |         |       | ±0.25pF | GRM1555C1H7R0CA01# |
|        |               |         | 7.1pF | ±0.05pF | GRM1555C1H7R1WA01# |
|        |               |         |       | ±0.1pF  | GRM1555C1H7R1BA01# |
|        |               |         |       | ±0.25pF | GRM1555C1H7R1CA01# |
|        |               |         | 7.2pF | ±0.05pF | GRM1555C1H7R2WA01# |
|        |               |         |       | ±0.1pF  | GRM1555C1H7R2BA01# |
|        |               |         |       | ±0.25pF | GRM1555C1H7R2CA01# |

| T max. | Rated Voltage | TC Code | Cap.    | Tol.    | Part Number        |
|--------|---------------|---------|---------|---------|--------------------|
| 0.55mm | 50Vdc         | COG     | 7.2pF   | ±0.5pF  | GRM1555C1H7R2DA01# |
|        |               |         |         | ±0.05pF | GRM1555C1H7R3WA01# |
|        |               |         |         | ±0.1pF  | GRM1555C1H7R3BA01# |
|        |               |         | 7.3pF   | ±0.25pF | GRM1555C1H7R3CA01# |
|        |               |         |         | ±0.5pF  | GRM1555C1H7R3DA01# |
|        |               |         |         | 7.4pF   | ±0.05pF            |
|        |               |         | ±0.1pF  |         | GRM1555C1H7R4BA01# |
|        |               |         | ±0.25pF |         | GRM1555C1H7R4CA01# |
|        |               |         | 7.5pF   | ±0.05pF | GRM1555C1H7R5WA01# |
|        |               |         |         | ±0.1pF  | GRM1555C1H7R5BA01# |
|        |               |         |         | ±0.25pF | GRM1555C1H7R5CA01# |
|        |               |         | 7.6pF   | ±0.05pF | GRM1555C1H7R6WA01# |
|        |               |         |         | ±0.1pF  | GRM1555C1H7R6BA01# |
|        |               |         |         | ±0.25pF | GRM1555C1H7R6CA01# |
|        |               |         | 7.7pF   | ±0.05pF | GRM1555C1H7R7WA01# |
|        |               |         |         | ±0.1pF  | GRM1555C1H7R7BA01# |
|        |               |         |         | ±0.25pF | GRM1555C1H7R7CA01# |
|        |               |         | 7.8pF   | ±0.05pF | GRM1555C1H7R8WA01# |
|        |               |         |         | ±0.1pF  | GRM1555C1H7R8BA01# |
|        |               |         |         | ±0.25pF | GRM1555C1H7R8CA01# |
|        |               |         | 7.9pF   | ±0.05pF | GRM1555C1H7R9WA01# |
|        |               |         |         | ±0.1pF  | GRM1555C1H7R9BA01# |
|        |               |         |         | ±0.25pF | GRM1555C1H7R9CA01# |
|        |               |         | 8.0pF   | ±0.05pF | GRM1555C1H8R0WA01# |
|        |               |         |         | ±0.1pF  | GRM1555C1H8R0BA01# |
|        |               |         |         | ±0.25pF | GRM1555C1H8R0CA01# |
|        |               |         | 8.1pF   | ±0.05pF | GRM1555C1H8R1WA01# |
|        |               |         |         | ±0.1pF  | GRM1555C1H8R1BA01# |
|        |               |         |         | ±0.25pF | GRM1555C1H8R1CA01# |
|        |               |         | 8.2pF   | ±0.05pF | GRM1555C1H8R2WA01# |
|        |               |         |         | ±0.1pF  | GRM1555C1H8R2BA01# |
|        |               |         |         | ±0.25pF | GRM1555C1H8R2CA01# |
|        |               |         | 8.3pF   | ±0.05pF | GRM1555C1H8R3WA01# |
|        |               |         |         | ±0.1pF  | GRM1555C1H8R3BA01# |
|        |               |         |         | ±0.25pF | GRM1555C1H8R3CA01# |
|        |               |         | 8.4pF   | ±0.05pF | GRM1555C1H8R4WA01# |
|        |               |         |         | ±0.1pF  | GRM1555C1H8R4BA01# |
|        |               |         |         | ±0.25pF | GRM1555C1H8R4CA01# |
|        |               |         | 8.5pF   | ±0.05pF | GRM1555C1H8R5WA01# |
|        |               |         |         | ±0.1pF  | GRM1555C1H8R5BA01# |
|        |               |         |         | ±0.25pF | GRM1555C1H8R5CA01# |
|        |               |         | 8.6pF   | ±0.05pF | GRM1555C1H8R6WA01# |
|        |               |         |         | ±0.1pF  | GRM1555C1H8R6BA01# |
|        |               |         |         | ±0.25pF | GRM1555C1H8R6CA01# |

Part number # indicates the package specification code.

GRM Series  
 GJM Series  
 GMA Series  
 GMD Series  
 GQM Series  
 GRJ Series  
 GR3 Series  
 KRM Series  
 KR3 Series  
 LLA Series  
 LLL Series  
 LLM Series  
 LLR Series  
 ⚠Caution/  
 Notice

## GRM Series Temperature Compensating Type Part Number List

(→ ■ 1.0x0.5mm)

| T max. | Rated Voltage | TC Code | Cap.  | Tol.    | Part Number        |
|--------|---------------|---------|-------|---------|--------------------|
| 0.55mm | 50Vdc         | C0G     | 8.6pF | ±0.1pF  | GRM1555C1H8R6BA01# |
|        |               |         |       | ±0.25pF | GRM1555C1H8R6CA01# |
|        |               |         |       | ±0.5pF  | GRM1555C1H8R6DA01# |
|        |               |         | 8.7pF | ±0.05pF | GRM1555C1H8R7WA01# |
|        |               |         |       | ±0.1pF  | GRM1555C1H8R7BA01# |
|        |               |         |       | ±0.25pF | GRM1555C1H8R7CA01# |
|        |               |         | 8.8pF | ±0.05pF | GRM1555C1H8R8WA01# |
|        |               |         |       | ±0.1pF  | GRM1555C1H8R8BA01# |
|        |               |         |       | ±0.25pF | GRM1555C1H8R8CA01# |
|        |               |         | 8.9pF | ±0.05pF | GRM1555C1H8R9WA01# |
|        |               |         |       | ±0.1pF  | GRM1555C1H8R9BA01# |
|        |               |         |       | ±0.25pF | GRM1555C1H8R9CA01# |
|        |               |         | 9.0pF | ±0.05pF | GRM1555C1H9R0WA01# |
|        |               |         |       | ±0.1pF  | GRM1555C1H9R0BA01# |
|        |               |         |       | ±0.25pF | GRM1555C1H9R0CA01# |
|        |               |         | 9.1pF | ±0.05pF | GRM1555C1H9R1WA01# |
|        |               |         |       | ±0.1pF  | GRM1555C1H9R1BA01# |
|        |               |         |       | ±0.25pF | GRM1555C1H9R1CA01# |
|        |               |         | 9.2pF | ±0.05pF | GRM1555C1H9R2WA01# |
|        |               |         |       | ±0.1pF  | GRM1555C1H9R2BA01# |
|        |               |         |       | ±0.25pF | GRM1555C1H9R2CA01# |
|        |               |         | 9.3pF | ±0.05pF | GRM1555C1H9R3WA01# |
|        |               |         |       | ±0.1pF  | GRM1555C1H9R3BA01# |
|        |               |         |       | ±0.25pF | GRM1555C1H9R3CA01# |
|        |               |         | 9.4pF | ±0.05pF | GRM1555C1H9R4WA01# |
|        |               |         |       | ±0.1pF  | GRM1555C1H9R4BA01# |
|        |               |         |       | ±0.25pF | GRM1555C1H9R4CA01# |
|        |               |         | 9.5pF | ±0.05pF | GRM1555C1H9R5WA01# |
|        |               |         |       | ±0.1pF  | GRM1555C1H9R5BA01# |
|        |               |         |       | ±0.25pF | GRM1555C1H9R5CA01# |
|        |               |         | 9.6pF | ±0.05pF | GRM1555C1H9R6WA01# |
|        |               |         |       | ±0.1pF  | GRM1555C1H9R6BA01# |
|        |               |         |       | ±0.25pF | GRM1555C1H9R6CA01# |
|        |               |         | 9.7pF | ±0.05pF | GRM1555C1H9R7WA01# |
|        |               |         |       | ±0.1pF  | GRM1555C1H9R7BA01# |
|        |               |         |       | ±0.25pF | GRM1555C1H9R7CA01# |
|        |               |         | 9.8pF | ±0.05pF | GRM1555C1H9R8WA01# |
|        |               |         |       | ±0.1pF  | GRM1555C1H9R8BA01# |
|        |               |         |       | ±0.25pF | GRM1555C1H9R8CA01# |
|        |               |         | 9.9pF | ±0.05pF | GRM1555C1H9R9WA01# |
|        |               |         |       | ±0.1pF  | GRM1555C1H9R9BA01# |
|        |               |         |       | ±0.25pF | GRM1555C1H9R9CA01# |

| T max. | Rated Voltage | TC Code            | Cap.               | Tol.   | Part Number        |
|--------|---------------|--------------------|--------------------|--------|--------------------|
| 0.55mm | 50Vdc         | C0G                | 9.9pF              | ±0.5pF | GRM1555C1H9R9DA01# |
|        |               |                    |                    | ±2%    | GRM1555C1H100GA01# |
|        |               |                    | 10pF               | ±5%    | GRM1555C1H100JA01# |
|        |               |                    |                    | ±2%    | GRM1555C1H120GA01# |
|        |               |                    | 12pF               | ±5%    | GRM1555C1H120JA01# |
|        |               |                    |                    | ±2%    | GRM1555C1H150GA01# |
|        |               |                    | 15pF               | ±5%    | GRM1555C1H150JA01# |
|        |               |                    |                    | ±2%    | GRM1555C1H180GA01# |
|        |               |                    | 18pF               | ±5%    | GRM1555C1H180JA01# |
|        |               |                    |                    | ±2%    | GRM1555C1H220GA01# |
|        |               |                    | 22pF               | ±5%    | GRM1555C1H220JA01# |
|        |               |                    |                    | ±2%    | GRM1555C1H270GA01# |
|        |               |                    | 27pF               | ±5%    | GRM1555C1H270JA01# |
|        |               |                    |                    | ±2%    | GRM1555C1H330GA01# |
|        |               |                    | 33pF               | ±5%    | GRM1555C1H330JA01# |
|        |               |                    |                    | ±2%    | GRM1555C1H390GA01# |
|        |               |                    | 39pF               | ±5%    | GRM1555C1H390JA01# |
|        |               |                    |                    | ±2%    | GRM1555C1H470GA01# |
|        |               |                    | 47pF               | ±5%    | GRM1555C1H470JA01# |
|        |               |                    |                    | ±2%    | GRM1555C1H560GA01# |
|        |               |                    | 56pF               | ±5%    | GRM1555C1H560JA01# |
|        |               |                    |                    | ±2%    | GRM1555C1H680GA01# |
|        |               |                    | 68pF               | ±5%    | GRM1555C1H680JA01# |
|        |               |                    |                    | ±2%    | GRM1555C1H820GA01# |
|        |               |                    | 82pF               | ±5%    | GRM1555C1H820JA01# |
|        |               |                    |                    | ±2%    | GRM1555C1H101GA01# |
|        |               |                    | 100pF              | ±5%    | GRM1555C1H101JA01# |
|        |               |                    |                    | ±2%    | GRM1555C1H121GA01# |
|        |               |                    | 120pF              | ±5%    | GRM1555C1H121JA01# |
|        |               |                    |                    | ±2%    | GRM1555C1H151GA01# |
| 150pF  | ±5%           | GRM1555C1H151JA01# |                    |        |                    |
|        | ±2%           | GRM1555C1H181GA01# |                    |        |                    |
| 180pF  | ±5%           | GRM1555C1H181JA01# |                    |        |                    |
|        | ±2%           | GRM1555C1H221GA01# |                    |        |                    |
| 220pF  | ±5%           | GRM1555C1H221JA01# |                    |        |                    |
|        | ±2%           | GRM1555C1H271GA01# |                    |        |                    |
| 270pF  | ±5%           | GRM1555C1H271JA01# |                    |        |                    |
|        | ±2%           | GRM1555C1H331GA01# |                    |        |                    |
| 330pF  | ±5%           | GRM1555C1H331JA01# |                    |        |                    |
|        | ±2%           | GRM1555C1H391GA01# |                    |        |                    |
| 390pF  | ±5%           | GRM1555C1H391JA01# |                    |        |                    |
|        | ±2%           | GRM1555C1H471GA01# |                    |        |                    |
| 470pF  | ±5%           | GRM1555C1H471JA01# |                    |        |                    |
|        | ±2%           | GRM1555C1H561GA01# |                    |        |                    |
| 560pF  | ±5%           | GRM1555C1H561JA01# |                    |        |                    |
|        | ±2%           | GRM1555C1H681GA01# |                    |        |                    |
| 680pF  | ±5%           | GRM1555C1H681JA01# |                    |        |                    |
|        | ±2%           | GRM1555C1H821GA01# |                    |        |                    |
| 820pF  | ±5%           | GRM1555C1H821JA01# |                    |        |                    |
|        | ±2%           | GRM1555C1H102GA01# |                    |        |                    |
| 1000pF | ±5%           | GRM1555C1H102JA01# |                    |        |                    |
|        | ±2%           | GRM1554C1HR10WA01# |                    |        |                    |
|        | CK            | ±0.05pF            | GRM1554C1HR20WA01# |        |                    |
|        |               | ±0.1pF             | GRM1554C1HR20BA01# |        |                    |

Part number # indicates the package specification code.

GRM Series  
GJM Series  
GMA Series  
GMD Series  
GQM Series  
GRJ Series  
GR3 Series  
KRM Series  
KR3 Series  
LLA Series  
LLL Series  
LLM Series  
LLR Series  
⚠Caution/ Notice

## GRM Series Temperature Compensating Type Part Number List

(→ ■ 1.0x0.5mm)

| T max. | Rated Voltage | TC Code | Cap.    | Tol.               | Part Number        |
|--------|---------------|---------|---------|--------------------|--------------------|
| 0.55mm | 50Vdc         | CK      | 0.30pF  | ±0.05pF            | GRM1554C1HR30WA01# |
|        |               |         |         | ±0.1pF             | GRM1554C1HR30BA01# |
|        |               |         | 0.40pF  | ±0.05pF            | GRM1554C1HR40WA01# |
|        |               |         |         | ±0.1pF             | GRM1554C1HR40BA01# |
|        |               |         | 0.50pF  | ±0.05pF            | GRM1554C1HR50WA01# |
|        |               |         |         | ±0.1pF             | GRM1554C1HR50BA01# |
|        |               |         | 0.60pF  | ±0.05pF            | GRM1554C1HR60WA01# |
|        |               |         |         | ±0.1pF             | GRM1554C1HR60BA01# |
|        |               |         | 0.70pF  | ±0.05pF            | GRM1554C1HR70WA01# |
|        |               |         |         | ±0.1pF             | GRM1554C1HR70BA01# |
|        |               |         | 0.80pF  | ±0.05pF            | GRM1554C1HR80WA01# |
|        |               |         |         | ±0.1pF             | GRM1554C1HR80BA01# |
|        |               |         | 0.90pF  | ±0.05pF            | GRM1554C1HR90WA01# |
|        |               |         |         | ±0.1pF             | GRM1554C1HR90BA01# |
|        |               |         | 1.0pF   | ±0.05pF            | GRM1554C1H1R0WA01# |
|        |               |         |         | ±0.1pF             | GRM1554C1H1R0BA01# |
|        |               |         |         | ±0.25pF            | GRM1554C1H1R0CA01# |
|        |               |         | 1.1pF   | ±0.05pF            | GRM1554C1H1R1WA01# |
|        |               |         |         | ±0.1pF             | GRM1554C1H1R1BA01# |
|        |               |         |         | ±0.25pF            | GRM1554C1H1R1CA01# |
|        |               |         | 1.2pF   | ±0.05pF            | GRM1554C1H1R2WA01# |
|        |               |         |         | ±0.1pF             | GRM1554C1H1R2BA01# |
|        |               |         |         | ±0.25pF            | GRM1554C1H1R2CA01# |
|        |               |         | 1.3pF   | ±0.05pF            | GRM1554C1H1R3WA01# |
|        |               |         |         | ±0.1pF             | GRM1554C1H1R3BA01# |
|        |               |         |         | ±0.25pF            | GRM1554C1H1R3CA01# |
|        |               |         | 1.4pF   | ±0.05pF            | GRM1554C1H1R4WA01# |
|        |               |         |         | ±0.1pF             | GRM1554C1H1R4BA01# |
|        |               |         |         | ±0.25pF            | GRM1554C1H1R4CA01# |
|        |               |         | 1.5pF   | ±0.05pF            | GRM1554C1H1R5WA01# |
|        |               |         |         | ±0.1pF             | GRM1554C1H1R5BA01# |
|        |               |         |         | ±0.25pF            | GRM1554C1H1R5CA01# |
|        |               |         | 1.6pF   | ±0.05pF            | GRM1554C1H1R6WA01# |
|        |               |         |         | ±0.1pF             | GRM1554C1H1R6BA01# |
|        |               |         |         | ±0.25pF            | GRM1554C1H1R6CA01# |
|        |               |         | 1.7pF   | ±0.05pF            | GRM1554C1H1R7WA01# |
|        |               |         |         | ±0.1pF             | GRM1554C1H1R7BA01# |
|        |               |         |         | ±0.25pF            | GRM1554C1H1R7CA01# |
|        |               |         | 1.8pF   | ±0.05pF            | GRM1554C1H1R8WA01# |
|        |               |         |         | ±0.1pF             | GRM1554C1H1R8BA01# |
|        |               |         |         | ±0.25pF            | GRM1554C1H1R8CA01# |
|        |               |         | 1.9pF   | ±0.05pF            | GRM1554C1H1R9WA01# |
|        |               | ±0.1pF  |         | GRM1554C1H1R9BA01# |                    |
|        |               | ±0.25pF |         | GRM1554C1H1R9CA01# |                    |
|        |               | 2.0pF   | ±0.05pF | GRM1554C1H2R0WA01# |                    |
|        |               |         | ±0.1pF  | GRM1554C1H2R0BA01# |                    |
|        |               |         | ±0.25pF | GRM1554C1H2R0CA01# |                    |
|        |               | 2.1pF   | ±0.05pF | GRM1553C1H2R1WA01# |                    |
|        |               |         | ±0.1pF  | GRM1553C1H2R1BA01# |                    |
|        |               |         | ±0.25pF | GRM1553C1H2R1CA01# |                    |
|        |               | 2.2pF   | ±0.05pF | GRM1553C1H2R2WA01# |                    |
|        |               |         | ±0.1pF  | GRM1553C1H2R2BA01# |                    |
|        |               |         | ±0.25pF | GRM1553C1H2R2CA01# |                    |
|        |               | 2.3pF   | ±0.05pF | GRM1553C1H2R3WA01# |                    |

| T max.  | Rated Voltage      | TC Code            | Cap.    | Tol.               | Part Number        |
|---------|--------------------|--------------------|---------|--------------------|--------------------|
| 0.55mm  | 50Vdc              | CJ                 | 2.3pF   | ±0.1pF             | GRM1553C1H2R3BA01# |
|         |                    |                    |         | ±0.25pF            | GRM1553C1H2R3CA01# |
|         |                    |                    | 2.4pF   | ±0.05pF            | GRM1553C1H2R4WA01# |
|         |                    |                    |         | ±0.1pF             | GRM1553C1H2R4BA01# |
|         |                    |                    | 2.5pF   | ±0.05pF            | GRM1553C1H2R5WA01# |
|         |                    |                    |         | ±0.1pF             | GRM1553C1H2R5BA01# |
|         |                    |                    | 2.6pF   | ±0.05pF            | GRM1553C1H2R6WA01# |
|         |                    |                    |         | ±0.1pF             | GRM1553C1H2R6BA01# |
|         |                    |                    | 2.7pF   | ±0.05pF            | GRM1553C1H2R7WA01# |
|         |                    |                    |         | ±0.1pF             | GRM1553C1H2R7BA01# |
|         |                    |                    | 2.8pF   | ±0.05pF            | GRM1553C1H2R8WA01# |
|         |                    |                    |         | ±0.1pF             | GRM1553C1H2R8BA01# |
|         |                    |                    | 2.9pF   | ±0.05pF            | GRM1553C1H2R9WA01# |
|         |                    |                    |         | ±0.1pF             | GRM1553C1H2R9BA01# |
|         |                    |                    | 3.0pF   | ±0.05pF            | GRM1553C1H3R0WA01# |
|         |                    |                    |         | ±0.1pF             | GRM1553C1H3R0BA01# |
|         |                    |                    |         | ±0.25pF            | GRM1553C1H3R0CA01# |
|         |                    |                    | 3.1pF   | ±0.05pF            | GRM1553C1H3R1WA01# |
|         |                    |                    |         | ±0.1pF             | GRM1553C1H3R1BA01# |
|         |                    |                    |         | ±0.25pF            | GRM1553C1H3R1CA01# |
|         |                    |                    | 3.2pF   | ±0.05pF            | GRM1553C1H3R2WA01# |
|         |                    | ±0.1pF             |         | GRM1553C1H3R2BA01# |                    |
|         |                    | ±0.25pF            |         | GRM1553C1H3R2CA01# |                    |
|         |                    | 3.3pF              | ±0.05pF | GRM1553C1H3R3WA01# |                    |
|         |                    |                    | ±0.1pF  | GRM1553C1H3R3BA01# |                    |
|         |                    |                    | ±0.25pF | GRM1553C1H3R3CA01# |                    |
|         |                    | 3.4pF              | ±0.05pF | GRM1553C1H3R4WA01# |                    |
|         |                    |                    | ±0.1pF  | GRM1553C1H3R4BA01# |                    |
|         |                    |                    | ±0.25pF | GRM1553C1H3R4CA01# |                    |
|         |                    | 3.5pF              | ±0.05pF | GRM1553C1H3R5WA01# |                    |
|         |                    |                    | ±0.1pF  | GRM1553C1H3R5BA01# |                    |
|         |                    |                    | ±0.25pF | GRM1553C1H3R5CA01# |                    |
|         |                    | 3.6pF              | ±0.05pF | GRM1553C1H3R6WA01# |                    |
|         |                    |                    | ±0.1pF  | GRM1553C1H3R6BA01# |                    |
|         |                    |                    | ±0.25pF | GRM1553C1H3R6CA01# |                    |
|         |                    | 3.7pF              | ±0.05pF | GRM1553C1H3R7WA01# |                    |
|         |                    |                    | ±0.1pF  | GRM1553C1H3R7BA01# |                    |
|         |                    |                    | ±0.25pF | GRM1553C1H3R7CA01# |                    |
|         |                    | 3.8pF              | ±0.05pF | GRM1553C1H3R8WA01# |                    |
|         |                    |                    | ±0.1pF  | GRM1553C1H3R8BA01# |                    |
|         |                    |                    | ±0.25pF | GRM1553C1H3R8CA01# |                    |
|         |                    | 3.9pF              | ±0.05pF | GRM1553C1H3R9WA01# |                    |
| ±0.1pF  | GRM1553C1H3R9BA01# |                    |         |                    |                    |
| ±0.25pF | GRM1553C1H3R9CA01# |                    |         |                    |                    |
| 4.0pF   | ±0.05pF            | GRM1552C1H4R0WA01# |         |                    |                    |
|         | ±0.1pF             | GRM1552C1H4R0BA01# |         |                    |                    |
|         | ±0.25pF            | GRM1552C1H4R0CA01# |         |                    |                    |
| 4.1pF   | ±0.05pF            | GRM1552C1H4R1WA01# |         |                    |                    |

Part number # indicates the package specification code.

## GRM Series Temperature Compensating Type Part Number List

(→ ■ 1.0x0.5mm)

| T max. | Rated Voltage | TC Code | Cap.  | Tol.    | Part Number        |
|--------|---------------|---------|-------|---------|--------------------|
| 0.55mm | 50Vdc         | CH      | 4.1pF | ±0.1pF  | GRM1552C1H4R1BA01# |
|        |               |         |       | ±0.25pF | GRM1552C1H4R1CA01# |
|        |               |         | 4.2pF | ±0.05pF | GRM1552C1H4R2WA01# |
|        |               |         |       | ±0.1pF  | GRM1552C1H4R2BA01# |
|        |               |         | 4.3pF | ±0.05pF | GRM1552C1H4R3WA01# |
|        |               |         |       | ±0.1pF  | GRM1552C1H4R3BA01# |
|        |               |         | 4.4pF | ±0.05pF | GRM1552C1H4R4WA01# |
|        |               |         |       | ±0.1pF  | GRM1552C1H4R4BA01# |
|        |               |         | 4.5pF | ±0.05pF | GRM1552C1H4R5WA01# |
|        |               |         |       | ±0.1pF  | GRM1552C1H4R5BA01# |
|        |               |         | 4.6pF | ±0.05pF | GRM1552C1H4R6WA01# |
|        |               |         |       | ±0.1pF  | GRM1552C1H4R6BA01# |
|        |               |         | 4.7pF | ±0.05pF | GRM1552C1H4R7WA01# |
|        |               |         |       | ±0.1pF  | GRM1552C1H4R7BA01# |
|        |               |         | 4.8pF | ±0.05pF | GRM1552C1H4R8WA01# |
|        |               |         |       | ±0.1pF  | GRM1552C1H4R8BA01# |
|        |               |         | 4.9pF | ±0.05pF | GRM1552C1H4R9WA01# |
|        |               |         |       | ±0.1pF  | GRM1552C1H4R9BA01# |
|        |               |         | 5.0pF | ±0.05pF | GRM1552C1H5R0WA01# |
|        |               |         |       | ±0.1pF  | GRM1552C1H5R0BA01# |
|        |               |         | 5.1pF | ±0.05pF | GRM1552C1H5R1WA01# |
|        |               |         |       | ±0.1pF  | GRM1552C1H5R1BA01# |
|        |               |         | 5.2pF | ±0.05pF | GRM1552C1H5R2WA01# |
|        |               |         |       | ±0.1pF  | GRM1552C1H5R2BA01# |
|        |               |         | 5.3pF | ±0.05pF | GRM1552C1H5R3WA01# |
|        |               |         |       | ±0.1pF  | GRM1552C1H5R3BA01# |
|        |               |         | 5.4pF | ±0.05pF | GRM1552C1H5R4WA01# |
|        |               |         |       | ±0.1pF  | GRM1552C1H5R4BA01# |
|        |               |         | 5.5pF | ±0.05pF | GRM1552C1H5R5WA01# |
|        |               |         |       | ±0.1pF  | GRM1552C1H5R5BA01# |
|        |               |         | 5.6pF | ±0.05pF | GRM1552C1H5R6WA01# |
|        |               |         |       | ±0.1pF  | GRM1552C1H5R6BA01# |
|        |               |         | 5.7pF | ±0.05pF | GRM1552C1H5R7WA01# |

| T max. | Rated Voltage | TC Code | Cap.  | Tol.    | Part Number        |
|--------|---------------|---------|-------|---------|--------------------|
| 0.55mm | 50Vdc         | CH      | 5.7pF | ±0.1pF  | GRM1552C1H5R7BA01# |
|        |               |         |       | ±0.25pF | GRM1552C1H5R7CA01# |
|        |               |         | 5.8pF | ±0.05pF | GRM1552C1H5R8WA01# |
|        |               |         |       | ±0.1pF  | GRM1552C1H5R8BA01# |
|        |               |         | 5.9pF | ±0.05pF | GRM1552C1H5R9WA01# |
|        |               |         |       | ±0.1pF  | GRM1552C1H5R9BA01# |
|        |               |         | 6.0pF | ±0.05pF | GRM1552C1H6R0WA01# |
|        |               |         |       | ±0.1pF  | GRM1552C1H6R0BA01# |
|        |               |         | 6.1pF | ±0.05pF | GRM1552C1H6R1WA01# |
|        |               |         |       | ±0.1pF  | GRM1552C1H6R1BA01# |
|        |               |         | 6.2pF | ±0.05pF | GRM1552C1H6R2WA01# |
|        |               |         |       | ±0.1pF  | GRM1552C1H6R2BA01# |
|        |               |         | 6.3pF | ±0.05pF | GRM1552C1H6R3WA01# |
|        |               |         |       | ±0.1pF  | GRM1552C1H6R3BA01# |
|        |               |         | 6.4pF | ±0.05pF | GRM1552C1H6R4WA01# |
|        |               |         |       | ±0.1pF  | GRM1552C1H6R4BA01# |
|        |               |         | 6.5pF | ±0.05pF | GRM1552C1H6R5WA01# |
|        |               |         |       | ±0.1pF  | GRM1552C1H6R5BA01# |
|        |               |         | 6.6pF | ±0.05pF | GRM1552C1H6R6WA01# |
|        |               |         |       | ±0.1pF  | GRM1552C1H6R6BA01# |
|        |               |         | 6.7pF | ±0.05pF | GRM1552C1H6R7WA01# |
|        |               |         |       | ±0.1pF  | GRM1552C1H6R7BA01# |
|        |               |         | 6.8pF | ±0.05pF | GRM1552C1H6R8WA01# |
|        |               |         |       | ±0.1pF  | GRM1552C1H6R8BA01# |
|        |               |         | 6.9pF | ±0.05pF | GRM1552C1H6R9WA01# |
|        |               |         |       | ±0.1pF  | GRM1552C1H6R9BA01# |
|        |               |         | 7.0pF | ±0.05pF | GRM1552C1H7R0WA01# |
|        |               |         |       | ±0.1pF  | GRM1552C1H7R0BA01# |

Part number # indicates the package specification code.

GRM Series  
GJM Series  
GMA Series  
GMD Series  
GQM Series  
GRJ Series  
GR3 Series  
KRM Series  
KR3 Series  
LLA Series  
LLL Series  
LLM Series  
LLR Series  
⚠Caution/ Notice

# GRM Series Temperature Compensating Type Part Number List

(→ ■ 1.0x0.5mm)

| T max. | Rated Voltage | TC Code | Cap.    | Tol.               | Part Number        |                    |
|--------|---------------|---------|---------|--------------------|--------------------|--------------------|
| 0.55mm | 50Vdc         | CH      | 7.0pF   | ±0.5pF             | GRM1552C1H7R0DA01# |                    |
|        |               |         |         | ±0.05pF            | GRM1552C1H7R1WA01# |                    |
|        |               |         |         |                    | ±0.1pF             | GRM1552C1H7R1BA01# |
|        |               |         |         |                    | ±0.25pF            | GRM1552C1H7R1CA01# |
|        |               |         | ±0.5pF  | GRM1552C1H7R1DA01# |                    |                    |
|        |               |         |         | 7.2pF              | ±0.05pF            | GRM1552C1H7R2WA01# |
|        |               |         |         |                    | ±0.1pF             | GRM1552C1H7R2BA01# |
|        |               |         | ±0.25pF |                    | GRM1552C1H7R2CA01# |                    |
|        |               |         | ±0.5pF  |                    | GRM1552C1H7R2DA01# |                    |
|        |               |         | 7.3pF   | ±0.05pF            | GRM1552C1H7R3WA01# |                    |
|        |               |         |         | ±0.1pF             | GRM1552C1H7R3BA01# |                    |
|        |               |         |         | ±0.25pF            | GRM1552C1H7R3CA01# |                    |
|        |               |         |         | ±0.5pF             | GRM1552C1H7R3DA01# |                    |
|        |               |         | 7.4pF   | ±0.05pF            | GRM1552C1H7R4WA01# |                    |
|        |               |         |         | ±0.1pF             | GRM1552C1H7R4BA01# |                    |
|        |               |         |         | ±0.25pF            | GRM1552C1H7R4CA01# |                    |
|        |               |         |         | ±0.5pF             | GRM1552C1H7R4DA01# |                    |
|        |               |         | 7.5pF   | ±0.05pF            | GRM1552C1H7R5WA01# |                    |
|        |               |         |         | ±0.1pF             | GRM1552C1H7R5BA01# |                    |
|        |               |         |         | ±0.25pF            | GRM1552C1H7R5CA01# |                    |
|        |               |         |         | ±0.5pF             | GRM1552C1H7R5DA01# |                    |
|        |               |         | 7.6pF   | ±0.05pF            | GRM1552C1H7R6WA01# |                    |
|        |               |         |         | ±0.1pF             | GRM1552C1H7R6BA01# |                    |
|        |               |         |         | ±0.25pF            | GRM1552C1H7R6CA01# |                    |
|        |               |         |         | ±0.5pF             | GRM1552C1H7R6DA01# |                    |
|        |               |         | 7.7pF   | ±0.05pF            | GRM1552C1H7R7WA01# |                    |
|        |               |         |         | ±0.1pF             | GRM1552C1H7R7BA01# |                    |
|        |               |         |         | ±0.25pF            | GRM1552C1H7R7CA01# |                    |
|        |               |         |         | ±0.5pF             | GRM1552C1H7R7DA01# |                    |
|        |               |         | 7.8pF   | ±0.05pF            | GRM1552C1H7R8WA01# |                    |
|        |               |         |         | ±0.1pF             | GRM1552C1H7R8BA01# |                    |
|        |               |         |         | ±0.25pF            | GRM1552C1H7R8CA01# |                    |
|        |               |         |         | ±0.5pF             | GRM1552C1H7R8DA01# |                    |
|        |               |         | 7.9pF   | ±0.05pF            | GRM1552C1H7R9WA01# |                    |
|        |               |         |         | ±0.1pF             | GRM1552C1H7R9BA01# |                    |
|        |               |         |         | ±0.25pF            | GRM1552C1H7R9CA01# |                    |
|        |               |         |         | ±0.5pF             | GRM1552C1H7R9DA01# |                    |
|        |               |         | 8.0pF   | ±0.05pF            | GRM1552C1H8R0WA01# |                    |
|        |               |         |         | ±0.1pF             | GRM1552C1H8R0BA01# |                    |
|        |               |         |         | ±0.25pF            | GRM1552C1H8R0CA01# |                    |
|        |               |         |         | ±0.5pF             | GRM1552C1H8R0DA01# |                    |
|        |               |         | 8.1pF   | ±0.05pF            | GRM1552C1H8R1WA01# |                    |
|        |               |         |         | ±0.1pF             | GRM1552C1H8R1BA01# |                    |
|        |               |         |         | ±0.25pF            | GRM1552C1H8R1CA01# |                    |
|        |               |         |         | ±0.5pF             | GRM1552C1H8R1DA01# |                    |
|        |               |         | 8.2pF   | ±0.05pF            | GRM1552C1H8R2WA01# |                    |
|        |               |         |         | ±0.1pF             | GRM1552C1H8R2BA01# |                    |
|        |               |         |         | ±0.25pF            | GRM1552C1H8R2CA01# |                    |
|        |               |         |         | ±0.5pF             | GRM1552C1H8R2DA01# |                    |
|        |               |         | 8.3pF   | ±0.05pF            | GRM1552C1H8R3WA01# |                    |
|        |               |         |         | ±0.1pF             | GRM1552C1H8R3BA01# |                    |
|        |               |         |         | ±0.25pF            | GRM1552C1H8R3CA01# |                    |
|        |               |         |         | ±0.5pF             | GRM1552C1H8R3DA01# |                    |
|        |               |         | 8.4pF   | ±0.05pF            | GRM1552C1H8R4WA01# |                    |

| T max. | Rated Voltage | TC Code | Cap.    | Tol.               | Part Number        |                    |
|--------|---------------|---------|---------|--------------------|--------------------|--------------------|
| 0.55mm | 50Vdc         | CH      | 8.4pF   | ±0.1pF             | GRM1552C1H8R4BA01# |                    |
|        |               |         |         | ±0.25pF            | GRM1552C1H8R4CA01# |                    |
|        |               |         |         | ±0.5pF             | GRM1552C1H8R4DA01# |                    |
|        |               |         | 8.5pF   | ±0.05pF            | GRM1552C1H8R5WA01# |                    |
|        |               |         |         | ±0.1pF             | GRM1552C1H8R5BA01# |                    |
|        |               |         |         | ±0.25pF            | GRM1552C1H8R5CA01# |                    |
|        |               |         | ±0.5pF  | GRM1552C1H8R5DA01# |                    |                    |
|        |               |         |         | 8.6pF              | ±0.05pF            | GRM1552C1H8R6WA01# |
|        |               |         |         |                    | ±0.1pF             | GRM1552C1H8R6BA01# |
|        |               |         | ±0.25pF |                    | GRM1552C1H8R6CA01# |                    |
|        |               |         | ±0.5pF  | GRM1552C1H8R6DA01# |                    |                    |
|        |               |         |         | 8.7pF              | ±0.05pF            | GRM1552C1H8R7WA01# |
|        |               |         |         |                    | ±0.1pF             | GRM1552C1H8R7BA01# |
|        |               |         | ±0.25pF |                    | GRM1552C1H8R7CA01# |                    |
|        |               |         | ±0.5pF  | GRM1552C1H8R7DA01# |                    |                    |
|        |               |         |         | 8.8pF              | ±0.05pF            | GRM1552C1H8R8WA01# |
|        |               |         |         |                    | ±0.1pF             | GRM1552C1H8R8BA01# |
|        |               |         | ±0.25pF |                    | GRM1552C1H8R8CA01# |                    |
|        |               |         | ±0.5pF  | GRM1552C1H8R8DA01# |                    |                    |
|        |               |         |         | 8.9pF              | ±0.05pF            | GRM1552C1H8R9WA01# |
|        |               |         |         |                    | ±0.1pF             | GRM1552C1H8R9BA01# |
|        |               |         | ±0.25pF |                    | GRM1552C1H8R9CA01# |                    |
|        |               |         | ±0.5pF  | GRM1552C1H8R9DA01# |                    |                    |
|        |               |         |         | 9.0pF              | ±0.05pF            | GRM1552C1H9R0WA01# |
|        |               |         |         |                    | ±0.1pF             | GRM1552C1H9R0BA01# |
|        |               |         | ±0.25pF |                    | GRM1552C1H9R0CA01# |                    |
|        |               |         | ±0.5pF  | GRM1552C1H9R0DA01# |                    |                    |
|        |               |         |         | 9.1pF              | ±0.05pF            | GRM1552C1H9R1WA01# |
|        |               |         |         |                    | ±0.1pF             | GRM1552C1H9R1BA01# |
|        |               |         | ±0.25pF |                    | GRM1552C1H9R1CA01# |                    |
|        |               |         | ±0.5pF  | GRM1552C1H9R1DA01# |                    |                    |
|        |               |         |         | 9.2pF              | ±0.05pF            | GRM1552C1H9R2WA01# |
|        |               |         |         |                    | ±0.1pF             | GRM1552C1H9R2BA01# |
|        |               |         | ±0.25pF |                    | GRM1552C1H9R2CA01# |                    |
|        |               |         | ±0.5pF  | GRM1552C1H9R2DA01# |                    |                    |
|        |               |         |         | 9.3pF              | ±0.05pF            | GRM1552C1H9R3WA01# |
|        |               |         |         |                    | ±0.1pF             | GRM1552C1H9R3BA01# |
|        |               |         | ±0.25pF |                    | GRM1552C1H9R3CA01# |                    |
|        |               |         | ±0.5pF  | GRM1552C1H9R3DA01# |                    |                    |
|        |               |         |         | 9.4pF              | ±0.05pF            | GRM1552C1H9R4WA01# |
|        |               |         |         |                    | ±0.1pF             | GRM1552C1H9R4BA01# |
|        |               |         | ±0.25pF |                    | GRM1552C1H9R4CA01# |                    |
|        |               |         | ±0.5pF  | GRM1552C1H9R4DA01# |                    |                    |
|        |               |         |         | 9.5pF              | ±0.05pF            | GRM1552C1H9R5WA01# |
|        |               |         |         |                    | ±0.1pF             | GRM1552C1H9R5BA01# |
|        |               |         | ±0.25pF |                    | GRM1552C1H9R5CA01# |                    |
|        |               |         | ±0.5pF  | GRM1552C1H9R5DA01# |                    |                    |
|        |               |         |         | 9.6pF              | ±0.05pF            | GRM1552C1H9R6WA01# |
|        |               |         |         |                    | ±0.1pF             | GRM1552C1H9R6BA01# |
|        |               |         | ±0.25pF |                    | GRM1552C1H9R6CA01# |                    |
|        |               |         | ±0.5pF  | GRM1552C1H9R6DA01# |                    |                    |
|        |               |         |         | 9.7pF              | ±0.05pF            | GRM1552C1H9R7WA01# |
|        |               |         |         |                    | ±0.1pF             | GRM1552C1H9R7BA01# |
|        |               |         | ±0.25pF |                    | GRM1552C1H9R7CA01# |                    |

Part number # indicates the package specification code.

## GRM Series Temperature Compensating Type Part Number List

(→ ■ 1.0x0.5mm)

| T max. | Rated Voltage      | TC Code            | Cap.  | Tol.    | Part Number        |                    |
|--------|--------------------|--------------------|-------|---------|--------------------|--------------------|
| 0.55mm | 50Vdc              | CH                 | 9.7pF | ±0.5pF  | GRM1552C1H9R7DA01# |                    |
|        |                    |                    |       | 9.8pF   | ±0.05pF            | GRM1552C1H9R8WA01# |
|        |                    |                    |       |         | ±0.1pF             | GRM1552C1H9R8BA01# |
|        |                    |                    |       |         | ±0.25pF            | GRM1552C1H9R8CA01# |
|        |                    |                    |       |         | ±0.5pF             | GRM1552C1H9R8DA01# |
|        |                    |                    | 9.9pF | ±0.05pF | GRM1552C1H9R9WA01# |                    |
|        |                    |                    |       | ±0.1pF  | GRM1552C1H9R9BA01# |                    |
|        |                    |                    |       | ±0.25pF | GRM1552C1H9R9CA01# |                    |
|        |                    |                    |       | ±0.5pF  | GRM1552C1H9R9DA01# |                    |
|        |                    |                    | 10pF  | ±2%     | GRM1552C1H100GA01# |                    |
|        |                    |                    |       | ±5%     | GRM1552C1H100JA01# |                    |
|        |                    |                    | 12pF  | ±2%     | GRM1552C1H120GA01# |                    |
|        |                    |                    |       | ±5%     | GRM1552C1H120JA01# |                    |
|        |                    |                    | 15pF  | ±2%     | GRM1552C1H150GA01# |                    |
|        |                    |                    |       | ±5%     | GRM1552C1H150JA01# |                    |
|        |                    |                    | 18pF  | ±2%     | GRM1552C1H180GA01# |                    |
|        |                    |                    |       | ±5%     | GRM1552C1H180JA01# |                    |
|        |                    |                    | 22pF  | ±2%     | GRM1552C1H220GA01# |                    |
|        |                    |                    |       | ±5%     | GRM1552C1H220JA01# |                    |
|        |                    |                    | 27pF  | ±2%     | GRM1552C1H270GA01# |                    |
|        |                    |                    |       | ±5%     | GRM1552C1H270JA01# |                    |
|        |                    |                    | 33pF  | ±2%     | GRM1552C1H330GA01# |                    |
|        |                    |                    |       | ±5%     | GRM1552C1H330JA01# |                    |
|        |                    |                    | 39pF  | ±2%     | GRM1552C1H390GA01# |                    |
|        |                    |                    |       | ±5%     | GRM1552C1H390JA01# |                    |
|        |                    |                    | 47pF  | ±2%     | GRM1552C1H470GA01# |                    |
|        |                    |                    |       | ±5%     | GRM1552C1H470JA01# |                    |
|        |                    |                    | 56pF  | ±2%     | GRM1552C1H560GA01# |                    |
|        |                    |                    |       | ±5%     | GRM1552C1H560JA01# |                    |
|        |                    |                    | 68pF  | ±2%     | GRM1552C1H680GA01# |                    |
|        |                    |                    |       | ±5%     | GRM1552C1H680JA01# |                    |
|        |                    |                    | 82pF  | ±2%     | GRM1552C1H820GA01# |                    |
|        |                    |                    |       | ±5%     | GRM1552C1H820JA01# |                    |
|        |                    |                    | 100pF | ±2%     | GRM1552C1H101GA01# |                    |
|        |                    |                    |       | ±5%     | GRM1552C1H101JA01# |                    |
|        |                    |                    | 120pF | ±2%     | GRM1552C1H121GA01# |                    |
|        |                    |                    |       | ±5%     | GRM1552C1H121JA01# |                    |
|        |                    |                    | 150pF | ±2%     | GRM1552C1H151GA01# |                    |
|        |                    |                    |       | ±5%     | GRM1552C1H151JA01# |                    |
|        |                    |                    | 180pF | ±2%     | GRM1552C1H181GA01# |                    |
|        |                    |                    |       | ±5%     | GRM1552C1H181JA01# |                    |
|        |                    |                    | 220pF | ±2%     | GRM1552C1H221GA01# |                    |
|        |                    |                    |       | ±5%     | GRM1552C1H221JA01# |                    |
|        |                    |                    | 270pF | ±2%     | GRM1552C1H271GA01# |                    |
|        |                    |                    |       | ±5%     | GRM1552C1H271JA01# |                    |
|        |                    |                    | 330pF | ±2%     | GRM1552C1H331GA01# |                    |
|        |                    |                    |       | ±5%     | GRM1552C1H331JA01# |                    |
|        |                    |                    | 390pF | ±2%     | GRM1552C1H391GA01# |                    |
|        |                    |                    |       | ±5%     | GRM1552C1H391JA01# |                    |
|        |                    |                    | 470pF | ±2%     | GRM1552C1H471GA01# |                    |
|        |                    |                    |       | ±5%     | GRM1552C1H471JA01# |                    |
|        |                    |                    | 560pF | ±2%     | GRM1552C1H561GA01# |                    |
| ±5%    | GRM1552C1H561JA01# |                    |       |         |                    |                    |
| 680pF  | ±2%                | GRM1552C1H681GA01# |       |         |                    |                    |

| T max. | Rated Voltage | TC Code | Cap.               | Tol.               | Part Number        |                    |                    |
|--------|---------------|---------|--------------------|--------------------|--------------------|--------------------|--------------------|
| 0.55mm | 50Vdc         | CH      | 680pF              | ±5%                | GRM1552C1H681JA01# |                    |                    |
|        |               |         |                    | 820pF              | ±2%                | GRM1552C1H821GA01# |                    |
|        |               |         |                    |                    | ±5%                | GRM1552C1H821JA01# |                    |
|        |               |         | 1000pF             | ±2%                | GRM1552C1H102GA01# |                    |                    |
|        |               |         |                    | ±5%                | GRM1552C1H102JA01# |                    |                    |
|        |               |         | 10Vdc              | SL                 | 1200pF             | ±5%                | GRM1551X1A122JA01# |
|        |               |         |                    |                    | 1500pF             | ±5%                | GRM1551X1A152JA01# |
|        |               |         |                    |                    | 1800pF             | ±5%                | GRM1551X1A182JA01# |
|        |               |         |                    |                    | 2200pF             | ±5%                | GRM1551X1A222JA01# |
|        |               |         |                    |                    | 2700pF             | ±5%                | GRM1551X1A272JA01# |
|        |               |         |                    |                    | 3300pF             | ±5%                | GRM1551X1A332JA01# |
|        |               |         |                    |                    | 3900pF             | ±5%                | GRM1551X1A392JA01# |
|        | 4700pF        | ±5%     |                    |                    | GRM1551X1A472JA01# |                    |                    |
|        | U2J           | 1200pF  |                    |                    | ±5%                | GRM1557U1A122JA01# |                    |
|        |               | 1500pF  |                    |                    | ±5%                | GRM1557U1A152JA01# |                    |
|        |               | 1800pF  |                    |                    | ±5%                | GRM1557U1A182JA01# |                    |
|        |               | 2200pF  |                    |                    | ±5%                | GRM1557U1A222JA01# |                    |
|        |               | 2700pF  |                    | ±5%                | GRM1557U1A272JA01# |                    |                    |
|        |               | 3300pF  |                    | ±5%                | GRM1557U1A332JA01# |                    |                    |
|        | UJ            | 1200pF  |                    | ±5%                | GRM1553U1A122JA01# |                    |                    |
|        |               | 1500pF  |                    | ±5%                | GRM1553U1A152JA01# |                    |                    |
|        |               | 1800pF  |                    | ±5%                | GRM1553U1A182JA01# |                    |                    |
|        |               | 2200pF  |                    | ±5%                | GRM1553U1A222JA01# |                    |                    |
|        |               | 2700pF  | ±5%                | GRM1553U1A272JA01# |                    |                    |                    |
|        |               | 3300pF  | ±5%                | GRM1553U1A332JA01# |                    |                    |                    |
|        | 3900pF        | ±5%     | GRM1553U1A392JA01# |                    |                    |                    |                    |
|        | 4700pF        | ±5%     | GRM1553U1A472JA01# |                    |                    |                    |                    |

■ 1.6x0.8mm

| T max. | Rated Voltage | TC Code | Cap.   | Tol.    | Part Number        |                    |                    |
|--------|---------------|---------|--------|---------|--------------------|--------------------|--------------------|
| 0.5mm  | 50Vdc         | SL      | 2200pF | ±5%     | GRM1851X1H222JA44# |                    |                    |
|        |               |         | 2700pF | ±5%     | GRM1851X1H272JA44# |                    |                    |
|        |               |         | 3300pF | ±5%     | GRM1851X1H332JA44# |                    |                    |
|        |               |         | 3900pF | ±5%     | GRM1851X1H392JA44# |                    |                    |
|        |               |         | 4700pF | ±5%     | GRM1851X1H472JA44# |                    |                    |
|        |               |         | U2J    | 2200pF  | ±5%                | GRM1857U1H222JA44# |                    |
|        |               |         |        | 2700pF  | ±5%                | GRM1857U1H272JA44# |                    |
|        |               |         |        | 3300pF  | ±5%                | GRM1857U1H332JA44# |                    |
|        |               |         |        | 3900pF  | ±5%                | GRM1857U1H392JA44# |                    |
|        |               |         |        | 4700pF  | ±5%                | GRM1857U1H472JA44# |                    |
|        |               |         |        | UJ      | 2200pF             | ±5%                | GRM1853U1H222JA44# |
|        |               |         | 2700pF |         | ±5%                | GRM1853U1H272JA44# |                    |
|        |               | 3300pF  | ±5%    |         | GRM1853U1H332JA44# |                    |                    |
|        |               | 3900pF  | ±5%    |         | GRM1853U1H392JA44# |                    |                    |
|        |               | 4700pF  | ±5%    |         | GRM1853U1H472JA44# |                    |                    |
|        |               | 10Vdc   | SL     |         | 5600pF             | ±5%                | GRM1851X1A562JA44# |
|        |               |         |        | 6800pF  | ±5%                | GRM1851X1A682JA44# |                    |
|        |               |         |        | 8200pF  | ±5%                | GRM1851X1A822JA44# |                    |
|        |               |         |        | 10000pF | ±5%                | GRM1851X1A103JA44# |                    |
|        |               |         |        | U2J     | 5600pF             | ±5%                | GRM1857U1A562JA44# |

Part number # indicates the package specification code.

GRM Series  
GJM Series  
GMA Series  
GMD Series  
GQM Series  
GRJ Series  
GR3 Series  
KRM Series  
KR3 Series  
LLA Series  
LLL Series  
LLM Series  
LLR Series  
⚠Caution/Notice

## GRM Series Temperature Compensating Type Part Number List

(→ ■ 1.6x0.8mm)

| T max. | Rated Voltage | TC Code            | Cap.    | Tol.   | Part Number        |        |         |                    |
|--------|---------------|--------------------|---------|--------|--------------------|--------|---------|--------------------|
| 0.5mm  | 10Vdc         | U2J                | 6800pF  | ±5%    | GRM1857U1A682JA44# |        |         |                    |
|        |               |                    | 8200pF  | ±5%    | GRM1857U1A822JA44# |        |         |                    |
|        |               |                    | 10000pF | ±5%    | GRM1857U1A103JA44# |        |         |                    |
|        |               | UJ                 | 5600pF  | ±5%    | GRM1853U1A562JA44# |        |         |                    |
|        |               |                    | 6800pF  | ±5%    | GRM1853U1A682JA44# |        |         |                    |
|        |               |                    | 8200pF  | ±5%    | GRM1853U1A822JA44# |        |         |                    |
|        |               |                    | 10000pF | ±5%    | GRM1853U1A103JA44# |        |         |                    |
|        |               |                    | 0.9mm   | 100Vdc | C0G                | 0.50pF | ±0.05pF | GRM1885C2AR50WA01# |
|        |               |                    |         |        |                    |        | ±0.1pF  | GRM1885C2AR50BA01# |
| 0.60pF | ±0.05pF       | GRM1885C2AR60WA01# |         |        |                    |        |         |                    |
|        | ±0.1pF        | GRM1885C2AR60BA01# |         |        |                    |        |         |                    |
| 0.70pF | ±0.05pF       | GRM1885C2AR70WA01# |         |        |                    |        |         |                    |
|        | ±0.1pF        | GRM1885C2AR70BA01# |         |        |                    |        |         |                    |
| 0.80pF | ±0.05pF       | GRM1885C2AR80WA01# |         |        |                    |        |         |                    |
|        | ±0.1pF        | GRM1885C2AR80BA01# |         |        |                    |        |         |                    |
| 0.90pF | ±0.05pF       | GRM1885C2AR90WA01# |         |        |                    |        |         |                    |
|        | ±0.1pF        | GRM1885C2AR90BA01# |         |        |                    |        |         |                    |
| 1.0pF  | ±0.05pF       | GRM1885C2A1R0WA01# |         |        |                    |        |         |                    |
|        | ±0.1pF        | GRM1885C2A1R0BA01# |         |        |                    |        |         |                    |
|        | ±0.25pF       | GRM1885C2A1R0CA01# |         |        |                    |        |         |                    |
| 1.1pF  | ±0.05pF       | GRM1885C2A1R1WA01# |         |        |                    |        |         |                    |
|        | ±0.1pF        | GRM1885C2A1R1BA01# |         |        |                    |        |         |                    |
|        | ±0.25pF       | GRM1885C2A1R1CA01# |         |        |                    |        |         |                    |
| 1.2pF  | ±0.05pF       | GRM1885C2A1R2WA01# |         |        |                    |        |         |                    |
|        | ±0.1pF        | GRM1885C2A1R2BA01# |         |        |                    |        |         |                    |
|        | ±0.25pF       | GRM1885C2A1R2CA01# |         |        |                    |        |         |                    |
| 1.3pF  | ±0.05pF       | GRM1885C2A1R3WA01# |         |        |                    |        |         |                    |
|        | ±0.1pF        | GRM1885C2A1R3BA01# |         |        |                    |        |         |                    |
|        | ±0.25pF       | GRM1885C2A1R3CA01# |         |        |                    |        |         |                    |
| 1.4pF  | ±0.05pF       | GRM1885C2A1R4WA01# |         |        |                    |        |         |                    |
|        | ±0.1pF        | GRM1885C2A1R4BA01# |         |        |                    |        |         |                    |
|        | ±0.25pF       | GRM1885C2A1R4CA01# |         |        |                    |        |         |                    |
| 1.5pF  | ±0.05pF       | GRM1885C2A1R5WA01# |         |        |                    |        |         |                    |
|        | ±0.1pF        | GRM1885C2A1R5BA01# |         |        |                    |        |         |                    |
|        | ±0.25pF       | GRM1885C2A1R5CA01# |         |        |                    |        |         |                    |
| 1.6pF  | ±0.05pF       | GRM1885C2A1R6WA01# |         |        |                    |        |         |                    |
|        | ±0.1pF        | GRM1885C2A1R6BA01# |         |        |                    |        |         |                    |
|        | ±0.25pF       | GRM1885C2A1R6CA01# |         |        |                    |        |         |                    |
| 1.7pF  | ±0.05pF       | GRM1885C2A1R7WA01# |         |        |                    |        |         |                    |
|        | ±0.1pF        | GRM1885C2A1R7BA01# |         |        |                    |        |         |                    |
|        | ±0.25pF       | GRM1885C2A1R7CA01# |         |        |                    |        |         |                    |
| 1.8pF  | ±0.05pF       | GRM1885C2A1R8WA01# |         |        |                    |        |         |                    |
|        | ±0.1pF        | GRM1885C2A1R8BA01# |         |        |                    |        |         |                    |
|        | ±0.25pF       | GRM1885C2A1R8CA01# |         |        |                    |        |         |                    |
| 1.9pF  | ±0.05pF       | GRM1885C2A1R9WA01# |         |        |                    |        |         |                    |
|        | ±0.1pF        | GRM1885C2A1R9BA01# |         |        |                    |        |         |                    |
|        | ±0.25pF       | GRM1885C2A1R9CA01# |         |        |                    |        |         |                    |
| 2.0pF  | ±0.05pF       | GRM1885C2A2R0WA01# |         |        |                    |        |         |                    |
|        | ±0.1pF        | GRM1885C2A2R0BA01# |         |        |                    |        |         |                    |
|        | ±0.25pF       | GRM1885C2A2R0CA01# |         |        |                    |        |         |                    |
| 2.1pF  | ±0.05pF       | GRM1885C2A2R1WA01# |         |        |                    |        |         |                    |
|        | ±0.1pF        | GRM1885C2A2R1BA01# |         |        |                    |        |         |                    |
|        | ±0.25pF       | GRM1885C2A2R1CA01# |         |        |                    |        |         |                    |
| 2.2pF  | ±0.05pF       | GRM1885C2A2R2WA01# |         |        |                    |        |         |                    |

| T max.  | Rated Voltage      | TC Code            | Cap.  | Tol.    | Part Number        |
|---------|--------------------|--------------------|-------|---------|--------------------|
| 0.9mm   | 100Vdc             | C0G                | 2.2pF | ±0.1pF  | GRM1885C2A2R2BA01# |
|         |                    |                    |       | ±0.25pF | GRM1885C2A2R2CA01# |
|         |                    |                    | 2.3pF | ±0.05pF | GRM1885C2A2R3WA01# |
|         |                    |                    |       | ±0.1pF  | GRM1885C2A2R3BA01# |
|         |                    |                    |       | ±0.25pF | GRM1885C2A2R3CA01# |
|         |                    |                    | 2.4pF | ±0.05pF | GRM1885C2A2R4WA01# |
|         |                    |                    |       | ±0.1pF  | GRM1885C2A2R4BA01# |
|         |                    |                    |       | ±0.25pF | GRM1885C2A2R4CA01# |
|         |                    |                    | 2.5pF | ±0.05pF | GRM1885C2A2R5WA01# |
|         |                    |                    |       | ±0.1pF  | GRM1885C2A2R5BA01# |
|         |                    |                    |       | ±0.25pF | GRM1885C2A2R5CA01# |
|         |                    |                    | 2.6pF | ±0.05pF | GRM1885C2A2R6WA01# |
|         |                    |                    |       | ±0.1pF  | GRM1885C2A2R6BA01# |
|         |                    |                    |       | ±0.25pF | GRM1885C2A2R6CA01# |
|         |                    |                    | 2.7pF | ±0.05pF | GRM1885C2A2R7WA01# |
|         |                    |                    |       | ±0.1pF  | GRM1885C2A2R7BA01# |
|         |                    |                    |       | ±0.25pF | GRM1885C2A2R7CA01# |
|         |                    |                    | 2.8pF | ±0.05pF | GRM1885C2A2R8WA01# |
|         |                    |                    |       | ±0.1pF  | GRM1885C2A2R8BA01# |
|         |                    |                    |       | ±0.25pF | GRM1885C2A2R8CA01# |
|         |                    |                    | 2.9pF | ±0.05pF | GRM1885C2A2R9WA01# |
|         |                    |                    |       | ±0.1pF  | GRM1885C2A2R9BA01# |
|         |                    |                    |       | ±0.25pF | GRM1885C2A2R9CA01# |
|         |                    |                    | 3.0pF | ±0.05pF | GRM1885C2A3R0WA01# |
|         |                    |                    |       | ±0.1pF  | GRM1885C2A3R0BA01# |
|         |                    |                    |       | ±0.25pF | GRM1885C2A3R0CA01# |
|         |                    |                    | 3.1pF | ±0.05pF | GRM1885C2A3R1WA01# |
|         |                    |                    |       | ±0.1pF  | GRM1885C2A3R1BA01# |
|         |                    |                    |       | ±0.25pF | GRM1885C2A3R1CA01# |
|         |                    |                    | 3.2pF | ±0.05pF | GRM1885C2A3R2WA01# |
|         |                    |                    |       | ±0.1pF  | GRM1885C2A3R2BA01# |
|         |                    |                    |       | ±0.25pF | GRM1885C2A3R2CA01# |
|         |                    |                    | 3.3pF | ±0.05pF | GRM1885C2A3R3WA01# |
|         |                    |                    |       | ±0.1pF  | GRM1885C2A3R3BA01# |
|         |                    |                    |       | ±0.25pF | GRM1885C2A3R3CA01# |
|         |                    |                    | 3.4pF | ±0.05pF | GRM1885C2A3R4WA01# |
|         |                    |                    |       | ±0.1pF  | GRM1885C2A3R4BA01# |
|         |                    |                    |       | ±0.25pF | GRM1885C2A3R4CA01# |
|         |                    |                    | 3.5pF | ±0.05pF | GRM1885C2A3R5WA01# |
|         |                    |                    |       | ±0.1pF  | GRM1885C2A3R5BA01# |
| ±0.25pF | GRM1885C2A3R5CA01# |                    |       |         |                    |
| 3.6pF   | ±0.05pF            | GRM1885C2A3R6WA01# |       |         |                    |
|         | ±0.1pF             | GRM1885C2A3R6BA01# |       |         |                    |
|         | ±0.25pF            | GRM1885C2A3R6CA01# |       |         |                    |
| 3.7pF   | ±0.05pF            | GRM1885C2A3R7WA01# |       |         |                    |
|         | ±0.1pF             | GRM1885C2A3R7BA01# |       |         |                    |
|         | ±0.25pF            | GRM1885C2A3R7CA01# |       |         |                    |
| 3.8pF   | ±0.05pF            | GRM1885C2A3R8WA01# |       |         |                    |
|         | ±0.1pF             | GRM1885C2A3R8BA01# |       |         |                    |
|         | ±0.25pF            | GRM1885C2A3R8CA01# |       |         |                    |
| 3.9pF   | ±0.05pF            | GRM1885C2A3R9WA01# |       |         |                    |
|         | ±0.1pF             | GRM1885C2A3R9BA01# |       |         |                    |
|         | ±0.25pF            | GRM1885C2A3R9CA01# |       |         |                    |
| 4.0pF   | ±0.05pF            | GRM1885C2A4R0WA01# |       |         |                    |

Part number # indicates the package specification code.



## GRM Series Temperature Compensating Type Part Number List

(→ ■ 1.6x0.8mm)

| T max. | Rated Voltage | TC Code | Cap.  | Tol.    | Part Number        |
|--------|---------------|---------|-------|---------|--------------------|
| 0.9mm  | 100Vdc        | C0G     | 4.0pF | ±0.1pF  | GRM1885C2A4R0BA01# |
|        |               |         |       | ±0.25pF | GRM1885C2A4R0CA01# |
|        |               |         | 4.1pF | ±0.05pF | GRM1885C2A4R1WA01# |
|        |               |         |       | ±0.1pF  | GRM1885C2A4R1BA01# |
|        |               |         |       | ±0.25pF | GRM1885C2A4R1CA01# |
|        |               |         | 4.2pF | ±0.05pF | GRM1885C2A4R2WA01# |
|        |               |         |       | ±0.1pF  | GRM1885C2A4R2BA01# |
|        |               |         |       | ±0.25pF | GRM1885C2A4R2CA01# |
|        |               |         | 4.3pF | ±0.05pF | GRM1885C2A4R3WA01# |
|        |               |         |       | ±0.1pF  | GRM1885C2A4R3BA01# |
|        |               |         |       | ±0.25pF | GRM1885C2A4R3CA01# |
|        |               |         | 4.4pF | ±0.05pF | GRM1885C2A4R4WA01# |
|        |               |         |       | ±0.1pF  | GRM1885C2A4R4BA01# |
|        |               |         |       | ±0.25pF | GRM1885C2A4R4CA01# |
|        |               |         | 4.5pF | ±0.05pF | GRM1885C2A4R5WA01# |
|        |               |         |       | ±0.1pF  | GRM1885C2A4R5BA01# |
|        |               |         |       | ±0.25pF | GRM1885C2A4R5CA01# |
|        |               |         | 4.6pF | ±0.05pF | GRM1885C2A4R6WA01# |
|        |               |         |       | ±0.1pF  | GRM1885C2A4R6BA01# |
|        |               |         |       | ±0.25pF | GRM1885C2A4R6CA01# |
|        |               |         | 4.7pF | ±0.05pF | GRM1885C2A4R7WA01# |
|        |               |         |       | ±0.1pF  | GRM1885C2A4R7BA01# |
|        |               |         |       | ±0.25pF | GRM1885C2A4R7CA01# |
|        |               |         | 4.8pF | ±0.05pF | GRM1885C2A4R8WA01# |
|        |               |         |       | ±0.1pF  | GRM1885C2A4R8BA01# |
|        |               |         |       | ±0.25pF | GRM1885C2A4R8CA01# |
|        |               |         | 4.9pF | ±0.05pF | GRM1885C2A4R9WA01# |
|        |               |         |       | ±0.1pF  | GRM1885C2A4R9BA01# |
|        |               |         |       | ±0.25pF | GRM1885C2A4R9CA01# |
|        |               |         | 5.0pF | ±0.05pF | GRM1885C2A5R0WA01# |
|        |               |         |       | ±0.1pF  | GRM1885C2A5R0BA01# |
|        |               |         |       | ±0.25pF | GRM1885C2A5R0CA01# |
|        |               |         | 5.1pF | ±0.05pF | GRM1885C2A5R1WA01# |
|        |               |         |       | ±0.1pF  | GRM1885C2A5R1BA01# |
|        |               |         |       | ±0.25pF | GRM1885C2A5R1CA01# |
|        |               |         |       | ±0.5pF  | GRM1885C2A5R1DA01# |
|        |               |         | 5.2pF | ±0.05pF | GRM1885C2A5R2WA01# |
|        |               |         |       | ±0.1pF  | GRM1885C2A5R2BA01# |
|        |               |         |       | ±0.25pF | GRM1885C2A5R2CA01# |
|        |               |         |       | ±0.5pF  | GRM1885C2A5R2DA01# |
|        |               |         | 5.3pF | ±0.05pF | GRM1885C2A5R3WA01# |
|        |               |         |       | ±0.1pF  | GRM1885C2A5R3BA01# |
|        |               |         |       | ±0.25pF | GRM1885C2A5R3CA01# |
|        |               |         |       | ±0.5pF  | GRM1885C2A5R3DA01# |
|        |               |         | 5.4pF | ±0.05pF | GRM1885C2A5R4WA01# |
|        |               |         |       | ±0.1pF  | GRM1885C2A5R4BA01# |
|        |               |         |       | ±0.25pF | GRM1885C2A5R4CA01# |
|        |               |         |       | ±0.5pF  | GRM1885C2A5R4DA01# |
|        |               |         | 5.5pF | ±0.05pF | GRM1885C2A5R5WA01# |
|        |               |         |       | ±0.1pF  | GRM1885C2A5R5BA01# |
|        |               |         |       | ±0.25pF | GRM1885C2A5R5CA01# |
|        |               |         |       | ±0.5pF  | GRM1885C2A5R5DA01# |
|        |               |         | 5.6pF | ±0.05pF | GRM1885C2A5R6WA01# |
|        |               |         |       | ±0.1pF  | GRM1885C2A5R6BA01# |

| T max. | Rated Voltage | TC Code | Cap.  | Tol.    | Part Number        |
|--------|---------------|---------|-------|---------|--------------------|
| 0.9mm  | 100Vdc        | C0G     | 5.6pF | ±0.25pF | GRM1885C2A5R6CA01# |
|        |               |         |       | ±0.5pF  | GRM1885C2A5R6DA01# |
|        |               |         | 5.7pF | ±0.05pF | GRM1885C2A5R7WA01# |
|        |               |         |       | ±0.1pF  | GRM1885C2A5R7BA01# |
|        |               |         |       | ±0.25pF | GRM1885C2A5R7CA01# |
|        |               |         | 5.8pF | ±0.05pF | GRM1885C2A5R8WA01# |
|        |               |         |       | ±0.1pF  | GRM1885C2A5R8BA01# |
|        |               |         |       | ±0.25pF | GRM1885C2A5R8CA01# |
|        |               |         | 5.9pF | ±0.05pF | GRM1885C2A5R9WA01# |
|        |               |         |       | ±0.1pF  | GRM1885C2A5R9BA01# |
|        |               |         |       | ±0.25pF | GRM1885C2A5R9CA01# |
|        |               |         | 6.0pF | ±0.05pF | GRM1885C2A6R0WA01# |
|        |               |         |       | ±0.1pF  | GRM1885C2A6R0BA01# |
|        |               |         |       | ±0.25pF | GRM1885C2A6R0CA01# |
|        |               |         | 6.1pF | ±0.05pF | GRM1885C2A6R1WA01# |
|        |               |         |       | ±0.1pF  | GRM1885C2A6R1BA01# |
|        |               |         |       | ±0.25pF | GRM1885C2A6R1CA01# |
|        |               |         | 6.2pF | ±0.05pF | GRM1885C2A6R2WA01# |
|        |               |         |       | ±0.1pF  | GRM1885C2A6R2BA01# |
|        |               |         |       | ±0.25pF | GRM1885C2A6R2CA01# |
|        |               |         | 6.3pF | ±0.05pF | GRM1885C2A6R3WA01# |
|        |               |         |       | ±0.1pF  | GRM1885C2A6R3BA01# |
|        |               |         |       | ±0.25pF | GRM1885C2A6R3CA01# |
|        |               |         | 6.4pF | ±0.05pF | GRM1885C2A6R4WA01# |
|        |               |         |       | ±0.1pF  | GRM1885C2A6R4BA01# |
|        |               |         |       | ±0.25pF | GRM1885C2A6R4CA01# |
|        |               |         | 6.5pF | ±0.05pF | GRM1885C2A6R5WA01# |
|        |               |         |       | ±0.1pF  | GRM1885C2A6R5BA01# |
|        |               |         |       | ±0.25pF | GRM1885C2A6R5CA01# |
|        |               |         | 6.6pF | ±0.05pF | GRM1885C2A6R6WA01# |
|        |               |         |       | ±0.1pF  | GRM1885C2A6R6BA01# |
|        |               |         |       | ±0.25pF | GRM1885C2A6R6CA01# |
|        |               |         | 6.7pF | ±0.05pF | GRM1885C2A6R7WA01# |
|        |               |         |       | ±0.1pF  | GRM1885C2A6R7BA01# |
|        |               |         |       | ±0.25pF | GRM1885C2A6R7CA01# |
|        |               |         | 6.8pF | ±0.05pF | GRM1885C2A6R8WA01# |
|        |               |         |       | ±0.1pF  | GRM1885C2A6R8BA01# |
|        |               |         |       | ±0.25pF | GRM1885C2A6R8CA01# |
|        |               |         | 6.9pF | ±0.05pF | GRM1885C2A6R9WA01# |
|        |               |         |       | ±0.1pF  | GRM1885C2A6R9BA01# |
|        |               |         |       | ±0.25pF | GRM1885C2A6R9CA01# |

Part number # indicates the package specification code.

GRM Series  
GJM Series  
GMA Series  
GMD Series  
GQM Series  
GRJ Series  
GR3 Series  
KRM Series  
KR3 Series  
LLA Series  
LLL Series  
LLM Series  
LLR Series  
⚠Caution/ Notice

# GRM Series Temperature Compensating Type Part Number List

(→ ■ 1.6x0.8mm)

| T max. | Rated Voltage | TC Code | Cap.  | Tol.    | Part Number        |
|--------|---------------|---------|-------|---------|--------------------|
| 0.9mm  | 100Vdc        | C0G     | 7.0pF | ±0.05pF | GRM1885C2A7R0WA01# |
|        |               |         |       | ±0.1pF  | GRM1885C2A7R0BA01# |
|        |               |         |       | ±0.25pF | GRM1885C2A7R0CA01# |
|        |               |         |       | ±0.5pF  | GRM1885C2A7R0DA01# |
|        |               |         | 7.1pF | ±0.05pF | GRM1885C2A7R1WA01# |
|        |               |         |       | ±0.1pF  | GRM1885C2A7R1BA01# |
|        |               |         |       | ±0.25pF | GRM1885C2A7R1CA01# |
|        |               |         |       | ±0.5pF  | GRM1885C2A7R1DA01# |
|        |               |         | 7.2pF | ±0.05pF | GRM1885C2A7R2WA01# |
|        |               |         |       | ±0.1pF  | GRM1885C2A7R2BA01# |
|        |               |         |       | ±0.25pF | GRM1885C2A7R2CA01# |
|        |               |         |       | ±0.5pF  | GRM1885C2A7R2DA01# |
|        |               |         | 7.3pF | ±0.05pF | GRM1885C2A7R3WA01# |
|        |               |         |       | ±0.1pF  | GRM1885C2A7R3BA01# |
|        |               |         |       | ±0.25pF | GRM1885C2A7R3CA01# |
|        |               |         |       | ±0.5pF  | GRM1885C2A7R3DA01# |
|        |               |         | 7.4pF | ±0.05pF | GRM1885C2A7R4WA01# |
|        |               |         |       | ±0.1pF  | GRM1885C2A7R4BA01# |
|        |               |         |       | ±0.25pF | GRM1885C2A7R4CA01# |
|        |               |         |       | ±0.5pF  | GRM1885C2A7R4DA01# |
|        |               |         | 7.5pF | ±0.05pF | GRM1885C2A7R5WA01# |
|        |               |         |       | ±0.1pF  | GRM1885C2A7R5BA01# |
|        |               |         |       | ±0.25pF | GRM1885C2A7R5CA01# |
|        |               |         |       | ±0.5pF  | GRM1885C2A7R5DA01# |
|        |               |         | 7.6pF | ±0.05pF | GRM1885C2A7R6WA01# |
|        |               |         |       | ±0.1pF  | GRM1885C2A7R6BA01# |
|        |               |         |       | ±0.25pF | GRM1885C2A7R6CA01# |
|        |               |         |       | ±0.5pF  | GRM1885C2A7R6DA01# |
|        |               |         | 7.7pF | ±0.05pF | GRM1885C2A7R7WA01# |
|        |               |         |       | ±0.1pF  | GRM1885C2A7R7BA01# |
|        |               |         |       | ±0.25pF | GRM1885C2A7R7CA01# |
|        |               |         |       | ±0.5pF  | GRM1885C2A7R7DA01# |
|        |               |         | 7.8pF | ±0.05pF | GRM1885C2A7R8WA01# |
|        |               |         |       | ±0.1pF  | GRM1885C2A7R8BA01# |
|        |               |         |       | ±0.25pF | GRM1885C2A7R8CA01# |
|        |               |         |       | ±0.5pF  | GRM1885C2A7R8DA01# |
|        |               |         | 7.9pF | ±0.05pF | GRM1885C2A7R9WA01# |
|        |               |         |       | ±0.1pF  | GRM1885C2A7R9BA01# |
|        |               |         |       | ±0.25pF | GRM1885C2A7R9CA01# |
|        |               |         |       | ±0.5pF  | GRM1885C2A7R9DA01# |
|        |               |         | 8.0pF | ±0.05pF | GRM1885C2A8R0WA01# |
|        |               |         |       | ±0.1pF  | GRM1885C2A8R0BA01# |
|        |               |         |       | ±0.25pF | GRM1885C2A8R0CA01# |
|        |               |         |       | ±0.5pF  | GRM1885C2A8R0DA01# |
|        |               |         | 8.1pF | ±0.05pF | GRM1885C2A8R1WA01# |
|        |               |         |       | ±0.1pF  | GRM1885C2A8R1BA01# |
|        |               |         |       | ±0.25pF | GRM1885C2A8R1CA01# |
|        |               |         |       | ±0.5pF  | GRM1885C2A8R1DA01# |
|        |               |         | 8.2pF | ±0.05pF | GRM1885C2A8R2WA01# |
|        |               |         |       | ±0.1pF  | GRM1885C2A8R2BA01# |
|        |               |         |       | ±0.25pF | GRM1885C2A8R2CA01# |
|        |               |         |       | ±0.5pF  | GRM1885C2A8R2DA01# |
|        |               |         | 8.3pF | ±0.05pF | GRM1885C2A8R3WA01# |
|        |               |         |       | ±0.1pF  | GRM1885C2A8R3BA01# |

| T max. | Rated Voltage | TC Code | Cap.  | Tol.    | Part Number        |
|--------|---------------|---------|-------|---------|--------------------|
| 0.9mm  | 100Vdc        | C0G     | 8.3pF | ±0.25pF | GRM1885C2A8R3CA01# |
|        |               |         |       | ±0.5pF  | GRM1885C2A8R3DA01# |
|        |               |         | 8.4pF | ±0.05pF | GRM1885C2A8R4WA01# |
|        |               |         |       | ±0.1pF  | GRM1885C2A8R4BA01# |
|        |               |         |       | ±0.25pF | GRM1885C2A8R4CA01# |
|        |               |         | 8.5pF | ±0.05pF | GRM1885C2A8R5WA01# |
|        |               |         |       | ±0.1pF  | GRM1885C2A8R5BA01# |
|        |               |         |       | ±0.25pF | GRM1885C2A8R5CA01# |
|        |               |         | 8.6pF | ±0.05pF | GRM1885C2A8R6WA01# |
|        |               |         |       | ±0.1pF  | GRM1885C2A8R6BA01# |
|        |               |         |       | ±0.25pF | GRM1885C2A8R6CA01# |
|        |               |         | 8.7pF | ±0.05pF | GRM1885C2A8R7WA01# |
|        |               |         |       | ±0.1pF  | GRM1885C2A8R7BA01# |
|        |               |         |       | ±0.25pF | GRM1885C2A8R7CA01# |
|        |               |         | 8.8pF | ±0.05pF | GRM1885C2A8R8WA01# |
|        |               |         |       | ±0.1pF  | GRM1885C2A8R8BA01# |
|        |               |         |       | ±0.25pF | GRM1885C2A8R8CA01# |
|        |               |         | 8.9pF | ±0.05pF | GRM1885C2A8R9WA01# |
|        |               |         |       | ±0.1pF  | GRM1885C2A8R9BA01# |
|        |               |         |       | ±0.25pF | GRM1885C2A8R9CA01# |
|        |               |         | 9.0pF | ±0.05pF | GRM1885C2A9R0WA01# |
|        |               |         |       | ±0.1pF  | GRM1885C2A9R0BA01# |
|        |               |         |       | ±0.25pF | GRM1885C2A9R0CA01# |
|        |               |         | 9.1pF | ±0.05pF | GRM1885C2A9R1WA01# |
|        |               |         |       | ±0.1pF  | GRM1885C2A9R1BA01# |
|        |               |         |       | ±0.25pF | GRM1885C2A9R1CA01# |
|        |               |         | 9.2pF | ±0.05pF | GRM1885C2A9R2WA01# |
|        |               |         |       | ±0.1pF  | GRM1885C2A9R2BA01# |
|        |               |         |       | ±0.25pF | GRM1885C2A9R2CA01# |
|        |               |         | 9.3pF | ±0.05pF | GRM1885C2A9R3WA01# |
|        |               |         |       | ±0.1pF  | GRM1885C2A9R3BA01# |
|        |               |         |       | ±0.25pF | GRM1885C2A9R3CA01# |
|        |               |         | 9.4pF | ±0.05pF | GRM1885C2A9R4WA01# |
|        |               |         |       | ±0.1pF  | GRM1885C2A9R4BA01# |
|        |               |         |       | ±0.25pF | GRM1885C2A9R4CA01# |
|        |               |         | 9.5pF | ±0.05pF | GRM1885C2A9R5WA01# |
|        |               |         |       | ±0.1pF  | GRM1885C2A9R5BA01# |
|        |               |         |       | ±0.25pF | GRM1885C2A9R5CA01# |
|        |               |         | 9.6pF | ±0.05pF | GRM1885C2A9R6WA01# |
|        |               |         |       | ±0.1pF  | GRM1885C2A9R6BA01# |
|        |               |         |       | ±0.25pF | GRM1885C2A9R6CA01# |

Part number # indicates the package specification code.

## GRM Series Temperature Compensating Type Part Number List

(→ ■ 1.6x0.8mm)

| T max.             | Rated Voltage      | TC Code | Cap.   | Tol.    | Part Number        |
|--------------------|--------------------|---------|--------|---------|--------------------|
| 0.9mm              | 100Vdc             | C0G     | 9.7pF  | ±0.05pF | GRM1885C2A9R7WA01# |
|                    |                    |         |        | ±0.1pF  | GRM1885C2A9R7BA01# |
|                    |                    |         |        | ±0.25pF | GRM1885C2A9R7CA01# |
|                    |                    |         |        | ±0.5pF  | GRM1885C2A9R7DA01# |
|                    |                    |         | 9.8pF  | ±0.05pF | GRM1885C2A9R8WA01# |
|                    |                    |         |        | ±0.1pF  | GRM1885C2A9R8BA01# |
|                    |                    |         |        | ±0.25pF | GRM1885C2A9R8CA01# |
|                    |                    |         |        | ±0.5pF  | GRM1885C2A9R8DA01# |
|                    |                    |         | 9.9pF  | ±0.05pF | GRM1885C2A9R9WA01# |
|                    |                    |         |        | ±0.1pF  | GRM1885C2A9R9BA01# |
|                    |                    |         |        | ±0.25pF | GRM1885C2A9R9CA01# |
|                    |                    |         |        | ±0.5pF  | GRM1885C2A9R9DA01# |
|                    |                    |         | 10pF   | ±5%     | GRM1885C2A100JA01# |
|                    |                    |         | 12pF   | ±5%     | GRM1885C2A120JA01# |
|                    |                    |         | 15pF   | ±5%     | GRM1885C2A150JA01# |
|                    |                    |         | 18pF   | ±5%     | GRM1885C2A180JA01# |
|                    |                    |         | 22pF   | ±5%     | GRM1885C2A220JA01# |
|                    |                    |         | 27pF   | ±5%     | GRM1885C2A270JA01# |
|                    |                    |         | 33pF   | ±5%     | GRM1885C2A330JA01# |
|                    |                    |         | 39pF   | ±5%     | GRM1885C2A390JA01# |
|                    |                    |         | 47pF   | ±5%     | GRM1885C2A470JA01# |
|                    |                    |         | 56pF   | ±5%     | GRM1885C2A560JA01# |
|                    |                    |         | 68pF   | ±5%     | GRM1885C2A680JA01# |
|                    |                    |         | 82pF   | ±5%     | GRM1885C2A820JA01# |
|                    |                    |         | 100pF  | ±5%     | GRM1885C2A101JA01# |
|                    |                    |         | 120pF  | ±5%     | GRM1885C2A121JA01# |
|                    |                    |         | 150pF  | ±5%     | GRM1885C2A151JA01# |
|                    |                    |         | 180pF  | ±5%     | GRM1885C2A181JA01# |
|                    |                    |         | 220pF  | ±5%     | GRM1885C2A221JA01# |
|                    |                    |         | 270pF  | ±5%     | GRM1885C2A271JA01# |
|                    |                    |         | 330pF  | ±5%     | GRM1885C2A331JA01# |
|                    |                    |         | 390pF  | ±5%     | GRM1885C2A391JA01# |
|                    |                    |         | 470pF  | ±5%     | GRM1885C2A471JA01# |
|                    |                    |         | 560pF  | ±5%     | GRM1885C2A561JA01# |
|                    |                    |         | 680pF  | ±5%     | GRM1885C2A681JA01# |
|                    |                    |         | 820pF  | ±5%     | GRM1885C2A821JA01# |
|                    |                    |         | 1000pF | ±5%     | GRM1885C2A102JA01# |
|                    |                    |         | 1200pF | ±5%     | GRM1885C2A122JA01# |
|                    |                    |         | 1500pF | ±5%     | GRM1885C2A152JA01# |
|                    |                    |         | 0.50pF | ±0.05pF | GRM1884C2AR50WA01# |
|                    |                    |         |        |         | GRM1884C2AR50BA01# |
|                    |                    |         |        | ±0.1pF  | GRM1884C2AR60WA01# |
|                    |                    |         |        |         | GRM1884C2AR60BA01# |
|                    |                    |         |        | ±0.05pF | GRM1884C2AR70WA01# |
|                    |                    |         |        |         | GRM1884C2AR70BA01# |
|                    |                    |         |        | ±0.1pF  | GRM1884C2AR80WA01# |
|                    |                    |         |        |         | GRM1884C2AR80BA01# |
|                    |                    |         |        | ±0.05pF | GRM1884C2AR90WA01# |
|                    |                    |         |        |         | GRM1884C2AR90BA01# |
|                    |                    |         |        | ±0.1pF  | GRM1884C2A1R0WA01# |
| GRM1884C2A1R0BA01# |                    |         |        |         |                    |
| GRM1884C2A1R0CA01# |                    |         |        |         |                    |
| ±0.05pF            | GRM1884C2A1R1WA01# |         |        |         |                    |
|                    | GRM1884C2A1R1BA01# |         |        |         |                    |

| T max.  | Rated Voltage      | TC Code            | Cap.    | Tol.               | Part Number        |
|---------|--------------------|--------------------|---------|--------------------|--------------------|
| 0.9mm   | 100Vdc             | CK                 | 1.1pF   | ±0.25pF            | GRM1884C2A1R1CA01# |
|         |                    |                    |         | ±0.05pF            | GRM1884C2A1R2WA01# |
|         |                    |                    |         | ±0.1pF             | GRM1884C2A1R2BA01# |
|         |                    |                    |         | ±0.25pF            | GRM1884C2A1R2CA01# |
|         |                    |                    | 1.2pF   | ±0.05pF            | GRM1884C2A1R3WA01# |
|         |                    |                    |         | ±0.1pF             | GRM1884C2A1R3BA01# |
|         |                    |                    |         | ±0.25pF            | GRM1884C2A1R3CA01# |
|         |                    |                    |         | ±0.05pF            | GRM1884C2A1R4WA01# |
|         |                    |                    | 1.3pF   | ±0.05pF            | GRM1884C2A1R4BA01# |
|         |                    |                    |         | ±0.1pF             | GRM1884C2A1R4CA01# |
|         |                    |                    |         | ±0.25pF            | GRM1884C2A1R5WA01# |
|         |                    |                    |         | ±0.05pF            | GRM1884C2A1R5BA01# |
|         |                    |                    | 1.4pF   | ±0.05pF            | GRM1884C2A1R5CA01# |
|         |                    |                    |         | ±0.1pF             | GRM1884C2A1R6WA01# |
|         |                    |                    |         | ±0.25pF            | GRM1884C2A1R6BA01# |
|         |                    |                    |         | ±0.05pF            | GRM1884C2A1R6CA01# |
|         |                    |                    | 1.5pF   | ±0.05pF            | GRM1884C2A1R7WA01# |
|         |                    |                    |         | ±0.1pF             | GRM1884C2A1R7BA01# |
|         |                    |                    |         | ±0.25pF            | GRM1884C2A1R7CA01# |
|         |                    |                    |         | ±0.05pF            | GRM1884C2A1R8WA01# |
|         |                    |                    | 1.6pF   | ±0.05pF            | GRM1884C2A1R8BA01# |
|         |                    |                    |         | ±0.1pF             | GRM1884C2A1R8CA01# |
|         |                    |                    |         | ±0.25pF            | GRM1884C2A1R9WA01# |
|         |                    |                    |         | ±0.05pF            | GRM1884C2A1R9BA01# |
|         |                    |                    | 1.7pF   | ±0.05pF            | GRM1884C2A1R9CA01# |
|         |                    |                    |         | ±0.1pF             | GRM1884C2A2R0WA01# |
|         |                    |                    |         | ±0.25pF            | GRM1884C2A2R0BA01# |
|         |                    |                    |         | ±0.05pF            | GRM1884C2A2R0CA01# |
|         |                    |                    | 1.8pF   | ±0.05pF            | GRM1883C2A2R1WA01# |
|         |                    |                    |         | ±0.1pF             | GRM1883C2A2R1BA01# |
|         |                    |                    |         | ±0.25pF            | GRM1883C2A2R1CA01# |
|         |                    |                    |         | ±0.05pF            | GRM1883C2A2R2WA01# |
|         |                    |                    | 1.9pF   | ±0.05pF            | GRM1883C2A2R2BA01# |
|         |                    |                    |         | ±0.1pF             | GRM1883C2A2R2CA01# |
|         |                    |                    |         | ±0.25pF            | GRM1883C2A2R3WA01# |
|         |                    |                    |         | ±0.05pF            | GRM1883C2A2R3BA01# |
|         |                    |                    | 2.0pF   | ±0.05pF            | GRM1883C2A2R3CA01# |
|         |                    |                    |         | ±0.1pF             | GRM1883C2A2R4WA01# |
|         |                    |                    |         | ±0.25pF            | GRM1883C2A2R4BA01# |
|         |                    |                    |         | ±0.05pF            | GRM1883C2A2R4CA01# |
|         |                    | 2.1pF              | ±0.05pF | GRM1883C2A2R5WA01# |                    |
|         |                    |                    | ±0.1pF  | GRM1883C2A2R5BA01# |                    |
|         |                    |                    | ±0.25pF | GRM1883C2A2R5CA01# |                    |
|         |                    |                    | ±0.05pF | GRM1883C2A2R6WA01# |                    |
|         |                    | 2.2pF              | ±0.05pF | GRM1883C2A2R6BA01# |                    |
|         |                    |                    | ±0.1pF  | GRM1883C2A2R6CA01# |                    |
|         |                    |                    | ±0.25pF | GRM1883C2A2R7WA01# |                    |
|         |                    |                    | ±0.05pF | GRM1883C2A2R7BA01# |                    |
|         |                    | 2.3pF              | ±0.05pF | GRM1883C2A2R7CA01# |                    |
|         |                    |                    | ±0.1pF  | GRM1883C2A2R8WA01# |                    |
| ±0.25pF | GRM1883C2A2R8BA01# |                    |         |                    |                    |
| ±0.05pF | GRM1883C2A2R8CA01# |                    |         |                    |                    |
| 2.4pF   | ±0.05pF            | GRM1883C2A2R9WA01# |         |                    |                    |
|         | ±0.1pF             | GRM1883C2A2R9BA01# |         |                    |                    |
|         | ±0.25pF            | GRM1883C2A2R9CA01# |         |                    |                    |
|         | ±0.05pF            | GRM1883C2A2R9WA01# |         |                    |                    |
| 2.5pF   | ±0.05pF            | GRM1883C2A2R9BA01# |         |                    |                    |
|         | ±0.1pF             | GRM1883C2A2R9CA01# |         |                    |                    |
|         | ±0.25pF            | GRM1883C2A2R9WA01# |         |                    |                    |
|         | ±0.05pF            | GRM1883C2A2R9BA01# |         |                    |                    |
| 2.6pF   | ±0.05pF            | GRM1883C2A2R9CA01# |         |                    |                    |
|         | ±0.1pF             | GRM1883C2A2R9WA01# |         |                    |                    |
|         | ±0.25pF            | GRM1883C2A2R9BA01# |         |                    |                    |
|         | ±0.05pF            | GRM1883C2A2R9WA01# |         |                    |                    |
| 2.7pF   | ±0.05pF            | GRM1883C2A2R9BA01# |         |                    |                    |
|         | ±0.1pF             | GRM1883C2A2R9CA01# |         |                    |                    |
|         | ±0.25pF            | GRM1883C2A2R9WA01# |         |                    |                    |
|         | ±0.05pF            | GRM1883C2A2R9BA01# |         |                    |                    |
| 2.8pF   | ±0.05pF            | GRM1883C2A2R9CA01# |         |                    |                    |
|         | ±0.1pF             | GRM1883C2A2R9WA01# |         |                    |                    |
|         | ±0.25pF            | GRM1883C2A2R9BA01# |         |                    |                    |
|         | ±0.05pF            | GRM1883C2A2R9WA01# |         |                    |                    |
| 2.9pF   | ±0.05pF            | GRM1883C2A2R9BA01# |         |                    |                    |
|         | ±0.1pF             | GRM1883C2A2R9CA01# |         |                    |                    |

Part number # indicates the package specification code.

GRM Series  
GJM Series  
GMA Series  
GMD Series  
GQM Series  
GRJ Series  
GR3 Series  
KRM Series  
KR3 Series  
LLA Series  
LLL Series  
LLM Series  
LLR Series  
⚠Caution/ Notice

# GRM Series Temperature Compensating Type Part Number List

(→ ■ 1.6x0.8mm)

| T max. | Rated Voltage | TC Code | Cap.    | Tol.    | Part Number        |                    |                    |
|--------|---------------|---------|---------|---------|--------------------|--------------------|--------------------|
| 0.9mm  | 100Vdc        | CJ      | 2.9pF   | ±0.25pF | GRM1883C2A2R9CA01# |                    |                    |
|        |               |         |         | ±0.05pF | GRM1883C2A3R0WA01# |                    |                    |
|        |               |         |         |         | ±0.1pF             | GRM1883C2A3R0BA01# |                    |
|        |               |         | ±0.25pF |         | GRM1883C2A3R0CA01# |                    |                    |
|        |               |         | 3.1pF   | ±0.05pF | GRM1883C2A3R1WA01# |                    |                    |
|        |               |         |         | ±0.1pF  | GRM1883C2A3R1BA01# |                    |                    |
|        |               |         |         | ±0.25pF | GRM1883C2A3R1CA01# |                    |                    |
|        |               |         | 3.2pF   | ±0.05pF | GRM1883C2A3R2WA01# |                    |                    |
|        |               |         |         | ±0.1pF  | GRM1883C2A3R2BA01# |                    |                    |
|        |               |         |         | ±0.25pF | GRM1883C2A3R2CA01# |                    |                    |
|        |               |         | 3.3pF   | ±0.05pF | GRM1883C2A3R3WA01# |                    |                    |
|        |               |         |         | ±0.1pF  | GRM1883C2A3R3BA01# |                    |                    |
|        |               |         |         | ±0.25pF | GRM1883C2A3R3CA01# |                    |                    |
|        |               |         | 3.4pF   | ±0.05pF | GRM1883C2A3R4WA01# |                    |                    |
|        |               |         |         | ±0.1pF  | GRM1883C2A3R4BA01# |                    |                    |
|        |               |         |         | ±0.25pF | GRM1883C2A3R4CA01# |                    |                    |
|        |               |         | 3.5pF   | ±0.05pF | GRM1883C2A3R5WA01# |                    |                    |
|        |               |         |         | ±0.1pF  | GRM1883C2A3R5BA01# |                    |                    |
|        |               |         |         | ±0.25pF | GRM1883C2A3R5CA01# |                    |                    |
|        |               |         | 3.6pF   | ±0.05pF | GRM1883C2A3R6WA01# |                    |                    |
|        |               |         |         | ±0.1pF  | GRM1883C2A3R6BA01# |                    |                    |
|        |               |         |         | ±0.25pF | GRM1883C2A3R6CA01# |                    |                    |
|        |               |         | 3.7pF   | ±0.05pF | GRM1883C2A3R7WA01# |                    |                    |
|        |               |         |         | ±0.1pF  | GRM1883C2A3R7BA01# |                    |                    |
|        |               |         |         | ±0.25pF | GRM1883C2A3R7CA01# |                    |                    |
|        |               |         | 3.8pF   | ±0.05pF | GRM1883C2A3R8WA01# |                    |                    |
|        |               |         |         | ±0.1pF  | GRM1883C2A3R8BA01# |                    |                    |
|        |               |         |         | ±0.25pF | GRM1883C2A3R8CA01# |                    |                    |
|        |               |         | 3.9pF   | ±0.05pF | GRM1883C2A3R9WA01# |                    |                    |
|        |               |         |         | ±0.1pF  | GRM1883C2A3R9BA01# |                    |                    |
|        |               |         |         | ±0.25pF | GRM1883C2A3R9CA01# |                    |                    |
|        |               |         | CH      | 100Vdc  | 4.0pF              | ±0.05pF            | GRM1882C2A4R0WA01# |
|        |               |         |         |         |                    | ±0.1pF             | GRM1882C2A4R0BA01# |
|        |               |         |         |         |                    | ±0.25pF            | GRM1882C2A4R0CA01# |
|        |               |         |         |         | 4.1pF              | ±0.05pF            | GRM1882C2A4R1WA01# |
|        |               |         |         |         |                    | ±0.1pF             | GRM1882C2A4R1BA01# |
|        |               | ±0.25pF |         |         |                    | GRM1882C2A4R1CA01# |                    |
|        |               | 4.2pF   |         |         | ±0.05pF            | GRM1882C2A4R2WA01# |                    |
|        |               |         |         |         | ±0.1pF             | GRM1882C2A4R2BA01# |                    |
|        |               |         |         |         | ±0.25pF            | GRM1882C2A4R2CA01# |                    |
|        |               | 4.3pF   |         |         | ±0.05pF            | GRM1882C2A4R3WA01# |                    |
|        |               |         |         |         | ±0.1pF             | GRM1882C2A4R3BA01# |                    |
|        |               |         |         |         | ±0.25pF            | GRM1882C2A4R3CA01# |                    |
|        |               | 4.4pF   |         |         | ±0.05pF            | GRM1882C2A4R4WA01# |                    |
|        |               |         |         |         | ±0.1pF             | GRM1882C2A4R4BA01# |                    |
|        |               |         |         |         | ±0.25pF            | GRM1882C2A4R4CA01# |                    |
|        |               | 4.5pF   |         |         | ±0.05pF            | GRM1882C2A4R5WA01# |                    |
|        |               |         |         |         | ±0.1pF             | GRM1882C2A4R5BA01# |                    |
|        |               |         |         |         | ±0.25pF            | GRM1882C2A4R5CA01# |                    |
|        |               | 4.6pF   |         |         | ±0.05pF            | GRM1882C2A4R6WA01# |                    |
|        |               |         |         |         | ±0.1pF             | GRM1882C2A4R6BA01# |                    |
|        |               |         |         |         | ±0.25pF            | GRM1882C2A4R6CA01# |                    |
|        |               | 4.7pF   |         |         | ±0.05pF            | GRM1882C2A4R7WA01# |                    |
|        |               |         |         |         | ±0.1pF             | GRM1882C2A4R7BA01# |                    |

| T max. | Rated Voltage | TC Code | Cap.    | Tol.               | Part Number        |                    |
|--------|---------------|---------|---------|--------------------|--------------------|--------------------|
| 0.9mm  | 100Vdc        | CH      | 4.7pF   | ±0.25pF            | GRM1882C2A4R7CA01# |                    |
|        |               |         |         | ±0.05pF            | GRM1882C2A4R8WA01# |                    |
|        |               |         |         | ±0.1pF             | GRM1882C2A4R8BA01# |                    |
|        |               |         | ±0.25pF | GRM1882C2A4R8CA01# |                    |                    |
|        |               |         |         | 4.9pF              | ±0.05pF            | GRM1882C2A4R9WA01# |
|        |               |         |         |                    | ±0.1pF             | GRM1882C2A4R9BA01# |
|        |               |         | ±0.25pF |                    | GRM1882C2A4R9CA01# |                    |
|        |               |         | 5.0pF   | ±0.05pF            | GRM1882C2A5R0WA01# |                    |
|        |               |         |         | ±0.1pF             | GRM1882C2A5R0BA01# |                    |
|        |               |         |         | ±0.25pF            | GRM1882C2A5R0CA01# |                    |
|        |               |         | 5.1pF   | ±0.05pF            | GRM1882C2A5R1WA01# |                    |
|        |               |         |         | ±0.1pF             | GRM1882C2A5R1BA01# |                    |
|        |               |         |         | ±0.25pF            | GRM1882C2A5R1CA01# |                    |
|        |               |         | ±0.5pF  | GRM1882C2A5R1DA01# |                    |                    |
|        |               |         |         | 5.2pF              | ±0.05pF            | GRM1882C2A5R2WA01# |
|        |               |         |         |                    | ±0.1pF             | GRM1882C2A5R2BA01# |
|        |               |         | ±0.25pF |                    | GRM1882C2A5R2CA01# |                    |
|        |               |         | ±0.5pF  | GRM1882C2A5R2DA01# |                    |                    |
|        |               |         |         | 5.3pF              | ±0.05pF            | GRM1882C2A5R3WA01# |
|        |               |         |         |                    | ±0.1pF             | GRM1882C2A5R3BA01# |
|        |               |         | ±0.25pF |                    | GRM1882C2A5R3CA01# |                    |
|        |               |         | ±0.5pF  | GRM1882C2A5R3DA01# |                    |                    |
|        |               |         |         | 5.4pF              | ±0.05pF            | GRM1882C2A5R4WA01# |
|        |               |         |         |                    | ±0.1pF             | GRM1882C2A5R4BA01# |
|        |               |         | ±0.25pF |                    | GRM1882C2A5R4CA01# |                    |
|        |               |         | ±0.5pF  | GRM1882C2A5R4DA01# |                    |                    |
|        |               |         |         | 5.5pF              | ±0.05pF            | GRM1882C2A5R5WA01# |
|        |               |         |         |                    | ±0.1pF             | GRM1882C2A5R5BA01# |
|        |               |         | ±0.25pF |                    | GRM1882C2A5R5CA01# |                    |
|        |               |         | ±0.5pF  | GRM1882C2A5R5DA01# |                    |                    |
|        |               |         |         | 5.6pF              | ±0.05pF            | GRM1882C2A5R6WA01# |
|        |               |         |         |                    | ±0.1pF             | GRM1882C2A5R6BA01# |
|        |               |         | ±0.25pF |                    | GRM1882C2A5R6CA01# |                    |
|        |               |         | ±0.5pF  | GRM1882C2A5R6DA01# |                    |                    |
|        |               |         |         | 5.7pF              | ±0.05pF            | GRM1882C2A5R7WA01# |
|        |               |         |         |                    | ±0.1pF             | GRM1882C2A5R7BA01# |
|        |               |         | ±0.25pF |                    | GRM1882C2A5R7CA01# |                    |
|        |               |         | ±0.5pF  | GRM1882C2A5R7DA01# |                    |                    |
|        |               |         |         | 5.8pF              | ±0.05pF            | GRM1882C2A5R8WA01# |
|        |               |         |         |                    | ±0.1pF             | GRM1882C2A5R8BA01# |
|        |               |         | ±0.25pF |                    | GRM1882C2A5R8CA01# |                    |
|        |               |         | ±0.5pF  | GRM1882C2A5R8DA01# |                    |                    |
|        |               |         |         | 5.9pF              | ±0.05pF            | GRM1882C2A5R9WA01# |
|        |               |         |         |                    | ±0.1pF             | GRM1882C2A5R9BA01# |
|        |               |         | ±0.25pF |                    | GRM1882C2A5R9CA01# |                    |
|        |               |         | ±0.5pF  | GRM1882C2A5R9DA01# |                    |                    |
|        |               |         |         | 6.0pF              | ±0.05pF            | GRM1882C2A6R0WA01# |
|        |               |         |         |                    | ±0.1pF             | GRM1882C2A6R0BA01# |
|        |               |         | ±0.25pF |                    | GRM1882C2A6R0CA01# |                    |
|        |               |         | ±0.5pF  | GRM1882C2A6R0DA01# |                    |                    |
|        |               |         |         | 6.1pF              | ±0.05pF            | GRM1882C2A6R1WA01# |
|        |               |         |         |                    | ±0.1pF             | GRM1882C2A6R1BA01# |
|        |               |         | ±0.25pF |                    | GRM1882C2A6R1CA01# |                    |
|        |               |         | ±0.5pF  | GRM1882C2A6R1DA01# |                    |                    |

Part number # indicates the package specification code.

## GRM Series Temperature Compensating Type Part Number List

(→ ■ 1.6x0.8mm)

| T max. | Rated Voltage | TC Code | Cap.  | Tol.    | Part Number        |
|--------|---------------|---------|-------|---------|--------------------|
| 0.9mm  | 100Vdc        | CH      | 6.2pF | ±0.05pF | GRM1882C2A6R2WA01# |
|        |               |         |       | ±0.1pF  | GRM1882C2A6R2BA01# |
|        |               |         |       | ±0.25pF | GRM1882C2A6R2CA01# |
|        |               |         |       | ±0.5pF  | GRM1882C2A6R2DA01# |
|        |               |         | 6.3pF | ±0.05pF | GRM1882C2A6R3WA01# |
|        |               |         |       | ±0.1pF  | GRM1882C2A6R3BA01# |
|        |               |         |       | ±0.25pF | GRM1882C2A6R3CA01# |
|        |               |         |       | ±0.5pF  | GRM1882C2A6R3DA01# |
|        |               |         | 6.4pF | ±0.05pF | GRM1882C2A6R4WA01# |
|        |               |         |       | ±0.1pF  | GRM1882C2A6R4BA01# |
|        |               |         |       | ±0.25pF | GRM1882C2A6R4CA01# |
|        |               |         |       | ±0.5pF  | GRM1882C2A6R4DA01# |
|        |               |         | 6.5pF | ±0.05pF | GRM1882C2A6R5WA01# |
|        |               |         |       | ±0.1pF  | GRM1882C2A6R5BA01# |
|        |               |         |       | ±0.25pF | GRM1882C2A6R5CA01# |
|        |               |         |       | ±0.5pF  | GRM1882C2A6R5DA01# |
|        |               |         | 6.6pF | ±0.05pF | GRM1882C2A6R6WA01# |
|        |               |         |       | ±0.1pF  | GRM1882C2A6R6BA01# |
|        |               |         |       | ±0.25pF | GRM1882C2A6R6CA01# |
|        |               |         |       | ±0.5pF  | GRM1882C2A6R6DA01# |
|        |               |         | 6.7pF | ±0.05pF | GRM1882C2A6R7WA01# |
|        |               |         |       | ±0.1pF  | GRM1882C2A6R7BA01# |
|        |               |         |       | ±0.25pF | GRM1882C2A6R7CA01# |
|        |               |         |       | ±0.5pF  | GRM1882C2A6R7DA01# |
|        |               |         | 6.8pF | ±0.05pF | GRM1882C2A6R8WA01# |
|        |               |         |       | ±0.1pF  | GRM1882C2A6R8BA01# |
|        |               |         |       | ±0.25pF | GRM1882C2A6R8CA01# |
|        |               |         |       | ±0.5pF  | GRM1882C2A6R8DA01# |
|        |               |         | 6.9pF | ±0.05pF | GRM1882C2A6R9WA01# |
|        |               |         |       | ±0.1pF  | GRM1882C2A6R9BA01# |
|        |               |         |       | ±0.25pF | GRM1882C2A6R9CA01# |
|        |               |         |       | ±0.5pF  | GRM1882C2A6R9DA01# |
|        |               |         | 7.0pF | ±0.05pF | GRM1882C2A7R0WA01# |
|        |               |         |       | ±0.1pF  | GRM1882C2A7R0BA01# |
|        |               |         |       | ±0.25pF | GRM1882C2A7R0CA01# |
|        |               |         |       | ±0.5pF  | GRM1882C2A7R0DA01# |
|        |               |         | 7.1pF | ±0.05pF | GRM1882C2A7R1WA01# |
|        |               |         |       | ±0.1pF  | GRM1882C2A7R1BA01# |
|        |               |         |       | ±0.25pF | GRM1882C2A7R1CA01# |
|        |               |         |       | ±0.5pF  | GRM1882C2A7R1DA01# |
|        |               |         | 7.2pF | ±0.05pF | GRM1882C2A7R2WA01# |
|        |               |         |       | ±0.1pF  | GRM1882C2A7R2BA01# |
|        |               |         |       | ±0.25pF | GRM1882C2A7R2CA01# |
|        |               |         |       | ±0.5pF  | GRM1882C2A7R2DA01# |
|        |               |         | 7.3pF | ±0.05pF | GRM1882C2A7R3WA01# |
|        |               |         |       | ±0.1pF  | GRM1882C2A7R3BA01# |
|        |               |         |       | ±0.25pF | GRM1882C2A7R3CA01# |
|        |               |         |       | ±0.5pF  | GRM1882C2A7R3DA01# |
|        |               |         | 7.4pF | ±0.05pF | GRM1882C2A7R4WA01# |
|        |               |         |       | ±0.1pF  | GRM1882C2A7R4BA01# |
|        |               |         |       | ±0.25pF | GRM1882C2A7R4CA01# |
|        |               |         |       | ±0.5pF  | GRM1882C2A7R4DA01# |
|        |               |         | 7.5pF | ±0.05pF | GRM1882C2A7R5WA01# |
|        |               |         |       | ±0.1pF  | GRM1882C2A7R5BA01# |

| T max. | Rated Voltage | TC Code | Cap.  | Tol.    | Part Number        |
|--------|---------------|---------|-------|---------|--------------------|
| 0.9mm  | 100Vdc        | CH      | 7.5pF | ±0.25pF | GRM1882C2A7R5CA01# |
|        |               |         |       | ±0.5pF  | GRM1882C2A7R5DA01# |
|        |               |         | 7.6pF | ±0.05pF | GRM1882C2A7R6WA01# |
|        |               |         |       | ±0.1pF  | GRM1882C2A7R6BA01# |
|        |               |         |       | ±0.25pF | GRM1882C2A7R6CA01# |
|        |               |         | 7.7pF | ±0.05pF | GRM1882C2A7R7WA01# |
|        |               |         |       | ±0.1pF  | GRM1882C2A7R7BA01# |
|        |               |         |       | ±0.25pF | GRM1882C2A7R7CA01# |
|        |               |         | 7.8pF | ±0.05pF | GRM1882C2A7R8WA01# |
|        |               |         |       | ±0.1pF  | GRM1882C2A7R8BA01# |
|        |               |         |       | ±0.25pF | GRM1882C2A7R8CA01# |
|        |               |         | 7.9pF | ±0.05pF | GRM1882C2A7R9WA01# |
|        |               |         |       | ±0.1pF  | GRM1882C2A7R9BA01# |
|        |               |         |       | ±0.25pF | GRM1882C2A7R9CA01# |
|        |               |         | 8.0pF | ±0.05pF | GRM1882C2A8R0WA01# |
|        |               |         |       | ±0.1pF  | GRM1882C2A8R0BA01# |
|        |               |         |       | ±0.25pF | GRM1882C2A8R0CA01# |
|        |               |         | 8.1pF | ±0.05pF | GRM1882C2A8R1WA01# |
|        |               |         |       | ±0.1pF  | GRM1882C2A8R1BA01# |
|        |               |         |       | ±0.25pF | GRM1882C2A8R1CA01# |
|        |               |         | 8.2pF | ±0.05pF | GRM1882C2A8R2WA01# |
|        |               |         |       | ±0.1pF  | GRM1882C2A8R2BA01# |
|        |               |         |       | ±0.25pF | GRM1882C2A8R2CA01# |
|        |               |         | 8.3pF | ±0.05pF | GRM1882C2A8R3WA01# |
|        |               |         |       | ±0.1pF  | GRM1882C2A8R3BA01# |
|        |               |         |       | ±0.25pF | GRM1882C2A8R3CA01# |
|        |               |         | 8.4pF | ±0.05pF | GRM1882C2A8R4WA01# |
|        |               |         |       | ±0.1pF  | GRM1882C2A8R4BA01# |
|        |               |         |       | ±0.25pF | GRM1882C2A8R4CA01# |
|        |               |         | 8.5pF | ±0.05pF | GRM1882C2A8R5WA01# |
|        |               |         |       | ±0.1pF  | GRM1882C2A8R5BA01# |
|        |               |         |       | ±0.25pF | GRM1882C2A8R5CA01# |
|        |               |         | 8.6pF | ±0.05pF | GRM1882C2A8R6WA01# |
|        |               |         |       | ±0.1pF  | GRM1882C2A8R6BA01# |
|        |               |         |       | ±0.25pF | GRM1882C2A8R6CA01# |
|        |               |         | 8.7pF | ±0.05pF | GRM1882C2A8R7WA01# |
|        |               |         |       | ±0.1pF  | GRM1882C2A8R7BA01# |
|        |               |         |       | ±0.25pF | GRM1882C2A8R7CA01# |
|        |               |         | 8.8pF | ±0.05pF | GRM1882C2A8R8WA01# |
|        |               |         |       | ±0.1pF  | GRM1882C2A8R8BA01# |
|        |               |         |       | ±0.25pF | GRM1882C2A8R8CA01# |

Part number # indicates the package specification code.

GRM Series  
GJM Series  
GMA Series  
GMD Series  
GQM Series  
GRJ Series  
GR3 Series  
KRM Series  
KR3 Series  
LLA Series  
LLL Series  
LLM Series  
LLR Series  
⚠Caution/ Notice

## GRM Series Temperature Compensating Type Part Number List

(→ ■ 1.6x0.8mm)

| T max. | Rated Voltage | TC Code | Cap.  | Tol.    | Part Number        |
|--------|---------------|---------|-------|---------|--------------------|
| 0.9mm  | 100Vdc        | CH      | 8.9pF | ±0.05pF | GRM1882C2A8R9WA01# |
|        |               |         |       | ±0.1pF  | GRM1882C2A8R9BA01# |
|        |               |         |       | ±0.25pF | GRM1882C2A8R9CA01# |
|        |               |         |       | ±0.5pF  | GRM1882C2A8R9DA01# |
|        |               |         | 9.0pF | ±0.05pF | GRM1882C2A9R0WA01# |
|        |               |         |       | ±0.1pF  | GRM1882C2A9R0BA01# |
|        |               |         |       | ±0.25pF | GRM1882C2A9R0CA01# |
|        |               |         |       | ±0.5pF  | GRM1882C2A9R0DA01# |
|        |               |         | 9.1pF | ±0.05pF | GRM1882C2A9R1WA01# |
|        |               |         |       | ±0.1pF  | GRM1882C2A9R1BA01# |
|        |               |         |       | ±0.25pF | GRM1882C2A9R1CA01# |
|        |               |         |       | ±0.5pF  | GRM1882C2A9R1DA01# |
|        |               |         | 9.2pF | ±0.05pF | GRM1882C2A9R2WA01# |
|        |               |         |       | ±0.1pF  | GRM1882C2A9R2BA01# |
|        |               |         |       | ±0.25pF | GRM1882C2A9R2CA01# |
|        |               |         |       | ±0.5pF  | GRM1882C2A9R2DA01# |
|        |               |         | 9.3pF | ±0.05pF | GRM1882C2A9R3WA01# |
|        |               |         |       | ±0.1pF  | GRM1882C2A9R3BA01# |
|        |               |         |       | ±0.25pF | GRM1882C2A9R3CA01# |
|        |               |         |       | ±0.5pF  | GRM1882C2A9R3DA01# |
|        |               |         | 9.4pF | ±0.05pF | GRM1882C2A9R4WA01# |
|        |               |         |       | ±0.1pF  | GRM1882C2A9R4BA01# |
|        |               |         |       | ±0.25pF | GRM1882C2A9R4CA01# |
|        |               |         |       | ±0.5pF  | GRM1882C2A9R4DA01# |
|        |               |         | 9.5pF | ±0.05pF | GRM1882C2A9R5WA01# |
|        |               |         |       | ±0.1pF  | GRM1882C2A9R5BA01# |
|        |               |         |       | ±0.25pF | GRM1882C2A9R5CA01# |
|        |               |         |       | ±0.5pF  | GRM1882C2A9R5DA01# |
|        |               |         | 9.6pF | ±0.05pF | GRM1882C2A9R6WA01# |
|        |               |         |       | ±0.1pF  | GRM1882C2A9R6BA01# |
|        |               |         |       | ±0.25pF | GRM1882C2A9R6CA01# |
|        |               |         |       | ±0.5pF  | GRM1882C2A9R6DA01# |
|        |               |         | 9.7pF | ±0.05pF | GRM1882C2A9R7WA01# |
|        |               |         |       | ±0.1pF  | GRM1882C2A9R7BA01# |
|        |               |         |       | ±0.25pF | GRM1882C2A9R7CA01# |
|        |               |         |       | ±0.5pF  | GRM1882C2A9R7DA01# |
|        |               |         | 9.8pF | ±0.05pF | GRM1882C2A9R8WA01# |
|        |               |         |       | ±0.1pF  | GRM1882C2A9R8BA01# |
|        |               |         |       | ±0.25pF | GRM1882C2A9R8CA01# |
|        |               |         |       | ±0.5pF  | GRM1882C2A9R8DA01# |
|        |               |         | 9.9pF | ±0.05pF | GRM1882C2A9R9WA01# |
|        |               |         |       | ±0.1pF  | GRM1882C2A9R9BA01# |
|        |               |         |       | ±0.25pF | GRM1882C2A9R9CA01# |
|        |               |         |       | ±0.5pF  | GRM1882C2A9R9DA01# |
|        |               |         | 10pF  | ±5%     | GRM1882C2A100JA01# |
|        |               |         | 12pF  | ±5%     | GRM1882C2A120JA01# |
|        |               |         | 15pF  | ±5%     | GRM1882C2A150JA01# |
|        |               |         | 18pF  | ±5%     | GRM1882C2A180JA01# |
|        |               |         | 22pF  | ±5%     | GRM1882C2A220JA01# |
|        |               |         | 27pF  | ±5%     | GRM1882C2A270JA01# |
|        |               |         | 33pF  | ±5%     | GRM1882C2A330JA01# |
|        |               |         | 39pF  | ±5%     | GRM1882C2A390JA01# |
|        |               |         | 47pF  | ±5%     | GRM1882C2A470JA01# |
|        |               |         | 56pF  | ±5%     | GRM1882C2A560JA01# |

| T max. | Rated Voltage | TC Code            | Cap.   | Tol.    | Part Number        |
|--------|---------------|--------------------|--------|---------|--------------------|
| 0.9mm  | 100Vdc        | CH                 | 68pF   | ±5%     | GRM1882C2A680JA01# |
|        |               |                    |        | ±5%     | GRM1882C2A820JA01# |
|        |               |                    | 82pF   | ±5%     | GRM1882C2A101JA01# |
|        |               |                    |        | ±5%     | GRM1882C2A121JA01# |
|        |               |                    | 100pF  | ±5%     | GRM1882C2A151JA01# |
|        |               |                    |        | ±5%     | GRM1882C2A181JA01# |
|        |               |                    | 120pF  | ±5%     | GRM1882C2A221JA01# |
|        |               |                    |        | ±5%     | GRM1882C2A271JA01# |
|        |               |                    | 150pF  | ±5%     | GRM1882C2A331JA01# |
|        |               |                    |        | ±5%     | GRM1882C2A391JA01# |
|        |               |                    | 180pF  | ±5%     | GRM1882C2A471JA01# |
|        |               |                    |        | ±5%     | GRM1882C2A561JA01# |
|        |               |                    | 220pF  | ±5%     | GRM1882C2A681JA01# |
|        |               |                    |        | ±5%     | GRM1882C2A821JA01# |
|        |               |                    | 270pF  | ±5%     | GRM1882C2A102JA01# |
|        |               |                    |        | ±5%     | GRM1882C2A122JA01# |
|        |               |                    | 330pF  | ±5%     | GRM1882C2A152JA01# |
|        |               |                    |        | ±5%     | GRM1885C1HR50WA01# |
|        |               |                    | 390pF  | ±0.05pF | GRM1885C1HR50BA01# |
|        |               |                    |        | ±0.1pF  | GRM1885C1HR50CA01# |
|        |               |                    | 470pF  | ±0.05pF | GRM1885C1HR60WA01# |
|        |               |                    |        | ±0.1pF  | GRM1885C1HR60BA01# |
|        |               |                    | 560pF  | ±0.05pF | GRM1885C1HR70WA01# |
|        |               |                    |        | ±0.1pF  | GRM1885C1HR70BA01# |
|        |               |                    | 680pF  | ±0.05pF | GRM1885C1HR80WA01# |
|        |               |                    |        | ±0.1pF  | GRM1885C1HR80BA01# |
|        |               |                    | 820pF  | ±0.05pF | GRM1885C1HR90WA01# |
|        |               |                    |        | ±0.1pF  | GRM1885C1HR90BA01# |
|        |               |                    | 1000pF | ±0.05pF | GRM1885C1H1R0WA01# |
|        |               |                    |        | ±0.1pF  | GRM1885C1H1R0BA01# |
|        |               |                    | 1200pF | ±0.05pF | GRM1885C1H1R0CA01# |
|        |               |                    |        | ±0.1pF  | GRM1885C1H1R1WA01# |
| 1500pF | ±0.05pF       | GRM1885C1H1R1BA01# |        |         |                    |
|        | ±0.1pF        | GRM1885C1H1R1CA01# |        |         |                    |
| 0.50pF | ±0.05pF       | GRM1885C1H1R2WA01# |        |         |                    |
|        | ±0.1pF        | GRM1885C1H1R2BA01# |        |         |                    |
| 0.60pF | ±0.05pF       | GRM1885C1H1R2CA01# |        |         |                    |
|        | ±0.1pF        | GRM1885C1H1R3WA01# |        |         |                    |
| 0.70pF | ±0.05pF       | GRM1885C1H1R3BA01# |        |         |                    |
|        | ±0.1pF        | GRM1885C1H1R3CA01# |        |         |                    |
| 0.80pF | ±0.05pF       | GRM1885C1H1R4WA01# |        |         |                    |
|        | ±0.1pF        | GRM1885C1H1R4BA01# |        |         |                    |
| 0.90pF | ±0.05pF       | GRM1885C1H1R4CA01# |        |         |                    |
|        | ±0.1pF        | GRM1885C1H1R5WA01# |        |         |                    |
| 1.0pF  | ±0.05pF       | GRM1885C1H1R5BA01# |        |         |                    |
|        | ±0.1pF        | GRM1885C1H1R5CA01# |        |         |                    |
| 1.1pF  | ±0.05pF       | GRM1885C1H1R6WA01# |        |         |                    |
|        | ±0.1pF        | GRM1885C1H1R6BA01# |        |         |                    |
| 1.2pF  | ±0.05pF       | GRM1885C1H1R6CA01# |        |         |                    |
|        | ±0.1pF        | GRM1885C1H1R7WA01# |        |         |                    |
| 1.3pF  | ±0.05pF       | GRM1885C1H1R7BA01# |        |         |                    |
|        | ±0.1pF        | GRM1885C1H1R7CA01# |        |         |                    |
| 1.4pF  | ±0.05pF       | GRM1885C1H1R8WA01# |        |         |                    |
|        | ±0.1pF        | GRM1885C1H1R8BA01# |        |         |                    |
| 1.5pF  | ±0.05pF       | GRM1885C1H1R8CA01# |        |         |                    |
|        | ±0.1pF        | GRM1885C1H1R9WA01# |        |         |                    |
| 1.6pF  | ±0.05pF       | GRM1885C1H1R9BA01# |        |         |                    |
|        | ±0.1pF        | GRM1885C1H1R9CA01# |        |         |                    |
| 1.7pF  | ±0.05pF       | GRM1885C1H1R0WA01# |        |         |                    |
|        | ±0.1pF        | GRM1885C1H1R0BA01# |        |         |                    |
| 1.8pF  | ±0.05pF       | GRM1885C1H1R0CA01# |        |         |                    |
|        | ±0.1pF        | GRM1885C1H1R0DA01# |        |         |                    |

Part number # indicates the package specification code.

## GRM Series Temperature Compensating Type Part Number List

(→ ■ 1.6x0.8mm)

| T max. | Rated Voltage | TC Code | Cap.  | Tol.    | Part Number        |
|--------|---------------|---------|-------|---------|--------------------|
| 0.9mm  | 50Vdc         | C0G     | 1.9pF | ±0.05pF | GRM1885C1H1R9WA01# |
|        |               |         |       | ±0.1pF  | GRM1885C1H1R9BA01# |
|        |               |         |       | ±0.25pF | GRM1885C1H1R9CA01# |
|        |               |         | 2.0pF | ±0.05pF | GRM1885C1H2R0WA01# |
|        |               |         |       | ±0.1pF  | GRM1885C1H2R0BA01# |
|        |               |         |       | ±0.25pF | GRM1885C1H2R0CA01# |
|        |               |         | 2.1pF | ±0.05pF | GRM1885C1H2R1WA01# |
|        |               |         |       | ±0.1pF  | GRM1885C1H2R1BA01# |
|        |               |         |       | ±0.25pF | GRM1885C1H2R1CA01# |
|        |               |         | 2.2pF | ±0.05pF | GRM1885C1H2R2WA01# |
|        |               |         |       | ±0.1pF  | GRM1885C1H2R2BA01# |
|        |               |         |       | ±0.25pF | GRM1885C1H2R2CA01# |
|        |               |         | 2.3pF | ±0.05pF | GRM1885C1H2R3WA01# |
|        |               |         |       | ±0.1pF  | GRM1885C1H2R3BA01# |
|        |               |         |       | ±0.25pF | GRM1885C1H2R3CA01# |
|        |               |         | 2.4pF | ±0.05pF | GRM1885C1H2R4WA01# |
|        |               |         |       | ±0.1pF  | GRM1885C1H2R4BA01# |
|        |               |         |       | ±0.25pF | GRM1885C1H2R4CA01# |
|        |               |         | 2.5pF | ±0.05pF | GRM1885C1H2R5WA01# |
|        |               |         |       | ±0.1pF  | GRM1885C1H2R5BA01# |
|        |               |         |       | ±0.25pF | GRM1885C1H2R5CA01# |
|        |               |         | 2.6pF | ±0.05pF | GRM1885C1H2R6WA01# |
|        |               |         |       | ±0.1pF  | GRM1885C1H2R6BA01# |
|        |               |         |       | ±0.25pF | GRM1885C1H2R6CA01# |
|        |               |         | 2.7pF | ±0.05pF | GRM1885C1H2R7WA01# |
|        |               |         |       | ±0.1pF  | GRM1885C1H2R7BA01# |
|        |               |         |       | ±0.25pF | GRM1885C1H2R7CA01# |
|        |               |         | 2.8pF | ±0.05pF | GRM1885C1H2R8WA01# |
|        |               |         |       | ±0.1pF  | GRM1885C1H2R8BA01# |
|        |               |         |       | ±0.25pF | GRM1885C1H2R8CA01# |
|        |               |         | 2.9pF | ±0.05pF | GRM1885C1H2R9WA01# |
|        |               |         |       | ±0.1pF  | GRM1885C1H2R9BA01# |
|        |               |         |       | ±0.25pF | GRM1885C1H2R9CA01# |
|        |               |         | 3.0pF | ±0.05pF | GRM1885C1H3R0WA01# |
|        |               |         |       | ±0.1pF  | GRM1885C1H3R0BA01# |
|        |               |         |       | ±0.25pF | GRM1885C1H3R0CA01# |
|        |               |         | 3.1pF | ±0.05pF | GRM1885C1H3R1WA01# |
|        |               |         |       | ±0.1pF  | GRM1885C1H3R1BA01# |
|        |               |         |       | ±0.25pF | GRM1885C1H3R1CA01# |
|        |               |         | 3.2pF | ±0.05pF | GRM1885C1H3R2WA01# |
|        |               |         |       | ±0.1pF  | GRM1885C1H3R2BA01# |
|        |               |         |       | ±0.25pF | GRM1885C1H3R2CA01# |
|        |               |         | 3.3pF | ±0.05pF | GRM1885C1H3R3WA01# |
|        |               |         |       | ±0.1pF  | GRM1885C1H3R3BA01# |
|        |               |         |       | ±0.25pF | GRM1885C1H3R3CA01# |
|        |               |         | 3.4pF | ±0.05pF | GRM1885C1H3R4WA01# |
|        |               |         |       | ±0.1pF  | GRM1885C1H3R4BA01# |
|        |               |         |       | ±0.25pF | GRM1885C1H3R4CA01# |
|        |               |         | 3.5pF | ±0.05pF | GRM1885C1H3R5WA01# |
|        |               |         |       | ±0.1pF  | GRM1885C1H3R5BA01# |
|        |               |         |       | ±0.25pF | GRM1885C1H3R5CA01# |
|        |               |         | 3.6pF | ±0.05pF | GRM1885C1H3R6WA01# |
|        |               |         |       | ±0.1pF  | GRM1885C1H3R6BA01# |
|        |               |         |       | ±0.25pF | GRM1885C1H3R6CA01# |

| T max. | Rated Voltage | TC Code | Cap.  | Tol.    | Part Number        |        |                    |
|--------|---------------|---------|-------|---------|--------------------|--------|--------------------|
| 0.9mm  | 50Vdc         | C0G     | 3.7pF | ±0.05pF | GRM1885C1H3R7WA01# |        |                    |
|        |               |         |       | ±0.1pF  | GRM1885C1H3R7BA01# |        |                    |
|        |               |         |       | ±0.25pF | GRM1885C1H3R7CA01# |        |                    |
|        |               |         | 3.8pF | ±0.05pF | GRM1885C1H3R8WA01# |        |                    |
|        |               |         |       | ±0.1pF  | GRM1885C1H3R8BA01# |        |                    |
|        |               |         |       | ±0.25pF | GRM1885C1H3R8CA01# |        |                    |
|        |               |         | 3.9pF | ±0.05pF | GRM1885C1H3R9WA01# |        |                    |
|        |               |         |       | ±0.1pF  | GRM1885C1H3R9BA01# |        |                    |
|        |               |         |       | ±0.25pF | GRM1885C1H3R9CA01# |        |                    |
|        |               |         | 4.0pF | ±0.05pF | GRM1885C1H4R0WA01# |        |                    |
|        |               |         |       | ±0.1pF  | GRM1885C1H4R0BA01# |        |                    |
|        |               |         |       | ±0.25pF | GRM1885C1H4R0CA01# |        |                    |
|        |               |         | 4.1pF | ±0.05pF | GRM1885C1H4R1WA01# |        |                    |
|        |               |         |       | ±0.1pF  | GRM1885C1H4R1BA01# |        |                    |
|        |               |         |       | ±0.25pF | GRM1885C1H4R1CA01# |        |                    |
|        |               |         | 4.2pF | ±0.05pF | GRM1885C1H4R2WA01# |        |                    |
|        |               |         |       | ±0.1pF  | GRM1885C1H4R2BA01# |        |                    |
|        |               |         |       | ±0.25pF | GRM1885C1H4R2CA01# |        |                    |
|        |               |         | 4.3pF | ±0.05pF | GRM1885C1H4R3WA01# |        |                    |
|        |               |         |       | ±0.1pF  | GRM1885C1H4R3BA01# |        |                    |
|        |               |         |       | ±0.25pF | GRM1885C1H4R3CA01# |        |                    |
|        |               |         | 4.4pF | ±0.05pF | GRM1885C1H4R4WA01# |        |                    |
|        |               |         |       | ±0.1pF  | GRM1885C1H4R4BA01# |        |                    |
|        |               |         |       | ±0.25pF | GRM1885C1H4R4CA01# |        |                    |
|        |               |         | 4.5pF | ±0.05pF | GRM1885C1H4R5WA01# |        |                    |
|        |               |         |       | ±0.1pF  | GRM1885C1H4R5BA01# |        |                    |
|        |               |         |       | ±0.25pF | GRM1885C1H4R5CA01# |        |                    |
|        |               |         | 4.6pF | ±0.05pF | GRM1885C1H4R6WA01# |        |                    |
|        |               |         |       | ±0.1pF  | GRM1885C1H4R6BA01# |        |                    |
|        |               |         |       | ±0.25pF | GRM1885C1H4R6CA01# |        |                    |
|        |               |         | 4.7pF | ±0.05pF | GRM1885C1H4R7WA01# |        |                    |
|        |               |         |       | ±0.1pF  | GRM1885C1H4R7BA01# |        |                    |
|        |               |         |       | ±0.25pF | GRM1885C1H4R7CA01# |        |                    |
|        |               |         | 4.8pF | ±0.05pF | GRM1885C1H4R8WA01# |        |                    |
|        |               |         |       | ±0.1pF  | GRM1885C1H4R8BA01# |        |                    |
|        |               |         |       | ±0.25pF | GRM1885C1H4R8CA01# |        |                    |
|        |               |         | 4.9pF | ±0.05pF | GRM1885C1H4R9WA01# |        |                    |
|        |               |         |       | ±0.1pF  | GRM1885C1H4R9BA01# |        |                    |
|        |               |         |       | ±0.25pF | GRM1885C1H4R9CA01# |        |                    |
|        |               |         | 5.0pF | ±0.05pF | GRM1885C1H5R0WA01# |        |                    |
|        |               |         |       | ±0.1pF  | GRM1885C1H5R0BA01# |        |                    |
|        |               |         |       | ±0.25pF | GRM1885C1H5R0CA01# |        |                    |
|        |               |         | 5.1pF | ±0.05pF | GRM1885C1H5R1WA01# |        |                    |
|        |               |         |       | ±0.1pF  | GRM1885C1H5R1BA01# |        |                    |
|        |               |         |       | ±0.25pF | GRM1885C1H5R1CA01# |        |                    |
|        |               |         | 5.2pF | ±0.05pF | GRM1885C1H5R2WA01# |        |                    |
|        |               |         |       | ±0.1pF  | GRM1885C1H5R2BA01# |        |                    |
|        |               |         |       | ±0.25pF | GRM1885C1H5R2CA01# |        |                    |
|        |               |         | 5.3pF | ±0.05pF | GRM1885C1H5R3WA01# |        |                    |
|        |               |         |       | ±0.1pF  | GRM1885C1H5R3BA01# |        |                    |
|        |               |         |       | ±0.25pF | GRM1885C1H5R3CA01# |        |                    |
|        |               |         |       |         |                    | ±0.5pF | GRM1885C1H5R3DA01# |

Part number # indicates the package specification code.

GRM Series  
GJM Series  
GMA Series  
GMD Series  
GQM Series  
GRJ Series  
GR3 Series  
KRM Series  
KR3 Series  
LLA Series  
LLL Series  
LLM Series  
LLR Series  
⚠Caution/ Notice

## GRM Series Temperature Compensating Type Part Number List

(→ ■ 1.6x0.8mm)

| T max. | Rated Voltage | TC Code | Cap.  | Tol.    | Part Number        |
|--------|---------------|---------|-------|---------|--------------------|
| 0.9mm  | 50Vdc         | COG     | 5.4pF | ±0.05pF | GRM1885C1H5R4WA01# |
|        |               |         |       | ±0.1pF  | GRM1885C1H5R4BA01# |
|        |               |         |       | ±0.25pF | GRM1885C1H5R4CA01# |
|        |               |         |       | ±0.5pF  | GRM1885C1H5R4DA01# |
|        |               |         | 5.5pF | ±0.05pF | GRM1885C1H5R5WA01# |
|        |               |         |       | ±0.1pF  | GRM1885C1H5R5BA01# |
|        |               |         |       | ±0.25pF | GRM1885C1H5R5CA01# |
|        |               |         |       | ±0.5pF  | GRM1885C1H5R5DA01# |
|        |               |         | 5.6pF | ±0.05pF | GRM1885C1H5R6WA01# |
|        |               |         |       | ±0.1pF  | GRM1885C1H5R6BA01# |
|        |               |         |       | ±0.25pF | GRM1885C1H5R6CA01# |
|        |               |         |       | ±0.5pF  | GRM1885C1H5R6DA01# |
|        |               |         | 5.7pF | ±0.05pF | GRM1885C1H5R7WA01# |
|        |               |         |       | ±0.1pF  | GRM1885C1H5R7BA01# |
|        |               |         |       | ±0.25pF | GRM1885C1H5R7CA01# |
|        |               |         |       | ±0.5pF  | GRM1885C1H5R7DA01# |
|        |               |         | 5.8pF | ±0.05pF | GRM1885C1H5R8WA01# |
|        |               |         |       | ±0.1pF  | GRM1885C1H5R8BA01# |
|        |               |         |       | ±0.25pF | GRM1885C1H5R8CA01# |
|        |               |         |       | ±0.5pF  | GRM1885C1H5R8DA01# |
|        |               |         | 5.9pF | ±0.05pF | GRM1885C1H5R9WA01# |
|        |               |         |       | ±0.1pF  | GRM1885C1H5R9BA01# |
|        |               |         |       | ±0.25pF | GRM1885C1H5R9CA01# |
|        |               |         |       | ±0.5pF  | GRM1885C1H5R9DA01# |
|        |               |         | 6.0pF | ±0.05pF | GRM1885C1H6R0WA01# |
|        |               |         |       | ±0.1pF  | GRM1885C1H6R0BA01# |
|        |               |         |       | ±0.25pF | GRM1885C1H6R0CA01# |
|        |               |         |       | ±0.5pF  | GRM1885C1H6R0DA01# |
|        |               |         | 6.1pF | ±0.05pF | GRM1885C1H6R1WA01# |
|        |               |         |       | ±0.1pF  | GRM1885C1H6R1BA01# |
|        |               |         |       | ±0.25pF | GRM1885C1H6R1CA01# |
|        |               |         |       | ±0.5pF  | GRM1885C1H6R1DA01# |
|        |               |         | 6.2pF | ±0.05pF | GRM1885C1H6R2WA01# |
|        |               |         |       | ±0.1pF  | GRM1885C1H6R2BA01# |
|        |               |         |       | ±0.25pF | GRM1885C1H6R2CA01# |
|        |               |         |       | ±0.5pF  | GRM1885C1H6R2DA01# |
|        |               |         | 6.3pF | ±0.05pF | GRM1885C1H6R3WA01# |
|        |               |         |       | ±0.1pF  | GRM1885C1H6R3BA01# |
|        |               |         |       | ±0.25pF | GRM1885C1H6R3CA01# |
|        |               |         |       | ±0.5pF  | GRM1885C1H6R3DA01# |
|        |               |         | 6.4pF | ±0.05pF | GRM1885C1H6R4WA01# |
|        |               |         |       | ±0.1pF  | GRM1885C1H6R4BA01# |
|        |               |         |       | ±0.25pF | GRM1885C1H6R4CA01# |
|        |               |         |       | ±0.5pF  | GRM1885C1H6R4DA01# |
|        |               |         | 6.5pF | ±0.05pF | GRM1885C1H6R5WA01# |
|        |               |         |       | ±0.1pF  | GRM1885C1H6R5BA01# |
|        |               |         |       | ±0.25pF | GRM1885C1H6R5CA01# |
|        |               |         |       | ±0.5pF  | GRM1885C1H6R5DA01# |
|        |               |         | 6.6pF | ±0.05pF | GRM1885C1H6R6WA01# |
|        |               |         |       | ±0.1pF  | GRM1885C1H6R6BA01# |
|        |               |         |       | ±0.25pF | GRM1885C1H6R6CA01# |
|        |               |         |       | ±0.5pF  | GRM1885C1H6R6DA01# |
|        |               |         | 6.7pF | ±0.05pF | GRM1885C1H6R7WA01# |
|        |               |         |       | ±0.1pF  | GRM1885C1H6R7BA01# |

| T max. | Rated Voltage | TC Code | Cap.  | Tol.    | Part Number        |
|--------|---------------|---------|-------|---------|--------------------|
| 0.9mm  | 50Vdc         | COG     | 6.7pF | ±0.25pF | GRM1885C1H6R7CA01# |
|        |               |         |       | ±0.5pF  | GRM1885C1H6R7DA01# |
|        |               |         | 6.8pF | ±0.05pF | GRM1885C1H6R8WA01# |
|        |               |         |       | ±0.1pF  | GRM1885C1H6R8BA01# |
|        |               |         |       | ±0.25pF | GRM1885C1H6R8CA01# |
|        |               |         | 6.9pF | ±0.05pF | GRM1885C1H6R9WA01# |
|        |               |         |       | ±0.1pF  | GRM1885C1H6R9BA01# |
|        |               |         |       | ±0.25pF | GRM1885C1H6R9CA01# |
|        |               |         | 7.0pF | ±0.05pF | GRM1885C1H7R0WA01# |
|        |               |         |       | ±0.1pF  | GRM1885C1H7R0BA01# |
|        |               |         |       | ±0.25pF | GRM1885C1H7R0CA01# |
|        |               |         | 7.1pF | ±0.05pF | GRM1885C1H7R1WA01# |
|        |               |         |       | ±0.1pF  | GRM1885C1H7R1BA01# |
|        |               |         |       | ±0.25pF | GRM1885C1H7R1CA01# |
|        |               |         | 7.2pF | ±0.05pF | GRM1885C1H7R2WA01# |
|        |               |         |       | ±0.1pF  | GRM1885C1H7R2BA01# |
|        |               |         |       | ±0.25pF | GRM1885C1H7R2CA01# |
|        |               |         | 7.3pF | ±0.05pF | GRM1885C1H7R3WA01# |
|        |               |         |       | ±0.1pF  | GRM1885C1H7R3BA01# |
|        |               |         |       | ±0.25pF | GRM1885C1H7R3CA01# |
|        |               |         | 7.4pF | ±0.05pF | GRM1885C1H7R4WA01# |
|        |               |         |       | ±0.1pF  | GRM1885C1H7R4BA01# |
|        |               |         |       | ±0.25pF | GRM1885C1H7R4CA01# |
|        |               |         | 7.5pF | ±0.05pF | GRM1885C1H7R5WA01# |
|        |               |         |       | ±0.1pF  | GRM1885C1H7R5BA01# |
|        |               |         |       | ±0.25pF | GRM1885C1H7R5CA01# |
|        |               |         | 7.6pF | ±0.05pF | GRM1885C1H7R6WA01# |
|        |               |         |       | ±0.1pF  | GRM1885C1H7R6BA01# |
|        |               |         |       | ±0.25pF | GRM1885C1H7R6CA01# |
|        |               |         | 7.7pF | ±0.05pF | GRM1885C1H7R7WA01# |
|        |               |         |       | ±0.1pF  | GRM1885C1H7R7BA01# |
|        |               |         |       | ±0.25pF | GRM1885C1H7R7CA01# |
|        |               |         | 7.8pF | ±0.05pF | GRM1885C1H7R8WA01# |
|        |               |         |       | ±0.1pF  | GRM1885C1H7R8BA01# |
|        |               |         |       | ±0.25pF | GRM1885C1H7R8CA01# |
|        |               |         | 7.9pF | ±0.05pF | GRM1885C1H7R9WA01# |
|        |               |         |       | ±0.1pF  | GRM1885C1H7R9BA01# |
|        |               |         |       | ±0.25pF | GRM1885C1H7R9CA01# |
|        |               |         | 8.0pF | ±0.05pF | GRM1885C1H8R0WA01# |
|        |               |         |       | ±0.1pF  | GRM1885C1H8R0BA01# |
|        |               |         |       | ±0.25pF | GRM1885C1H8R0CA01# |

Part number # indicates the package specification code.

GRM Series  
 GJM Series  
 GMA Series  
 GMD Series  
 GQM Series  
 GRJ Series  
 GR3 Series  
 KRM Series  
 KR3 Series  
 LLA Series  
 LLL Series  
 LLM Series  
 LLR Series  
 ⚠Caution/  
 Notice



## GRM Series Temperature Compensating Type Part Number List

(→ ■ 1.6x0.8mm)

| T max. | Rated Voltage | TC Code            | Cap.  | Tol.    | Part Number        |
|--------|---------------|--------------------|-------|---------|--------------------|
| 0.9mm  | 50Vdc         | C0G                | 8.1pF | ±0.05pF | GRM1885C1H8R1WA01# |
|        |               |                    |       | ±0.1pF  | GRM1885C1H8R1BA01# |
|        |               |                    |       | ±0.25pF | GRM1885C1H8R1CA01# |
|        |               |                    |       | ±0.5pF  | GRM1885C1H8R1DA01# |
|        |               |                    | 8.2pF | ±0.05pF | GRM1885C1H8R2WA01# |
|        |               |                    |       | ±0.1pF  | GRM1885C1H8R2BA01# |
|        |               |                    |       | ±0.25pF | GRM1885C1H8R2CA01# |
|        |               |                    |       | ±0.5pF  | GRM1885C1H8R2DA01# |
|        |               |                    | 8.3pF | ±0.05pF | GRM1885C1H8R3WA01# |
|        |               |                    |       | ±0.1pF  | GRM1885C1H8R3BA01# |
|        |               |                    |       | ±0.25pF | GRM1885C1H8R3CA01# |
|        |               |                    |       | ±0.5pF  | GRM1885C1H8R3DA01# |
|        |               |                    | 8.4pF | ±0.05pF | GRM1885C1H8R4WA01# |
|        |               |                    |       | ±0.1pF  | GRM1885C1H8R4BA01# |
|        |               |                    |       | ±0.25pF | GRM1885C1H8R4CA01# |
|        |               |                    |       | ±0.5pF  | GRM1885C1H8R4DA01# |
|        |               |                    | 8.5pF | ±0.05pF | GRM1885C1H8R5WA01# |
|        |               |                    |       | ±0.1pF  | GRM1885C1H8R5BA01# |
|        |               |                    |       | ±0.25pF | GRM1885C1H8R5CA01# |
|        |               |                    |       | ±0.5pF  | GRM1885C1H8R5DA01# |
|        |               |                    | 8.6pF | ±0.05pF | GRM1885C1H8R6WA01# |
|        |               |                    |       | ±0.1pF  | GRM1885C1H8R6BA01# |
|        |               |                    |       | ±0.25pF | GRM1885C1H8R6CA01# |
|        |               |                    |       | ±0.5pF  | GRM1885C1H8R6DA01# |
|        |               |                    | 8.7pF | ±0.05pF | GRM1885C1H8R7WA01# |
|        |               |                    |       | ±0.1pF  | GRM1885C1H8R7BA01# |
|        |               |                    |       | ±0.25pF | GRM1885C1H8R7CA01# |
|        |               |                    |       | ±0.5pF  | GRM1885C1H8R7DA01# |
|        |               |                    | 8.8pF | ±0.05pF | GRM1885C1H8R8WA01# |
|        |               |                    |       | ±0.1pF  | GRM1885C1H8R8BA01# |
|        |               |                    |       | ±0.25pF | GRM1885C1H8R8CA01# |
|        |               |                    |       | ±0.5pF  | GRM1885C1H8R8DA01# |
|        |               |                    | 8.9pF | ±0.05pF | GRM1885C1H8R9WA01# |
|        |               |                    |       | ±0.1pF  | GRM1885C1H8R9BA01# |
|        |               |                    |       | ±0.25pF | GRM1885C1H8R9CA01# |
|        |               |                    |       | ±0.5pF  | GRM1885C1H8R9DA01# |
|        |               |                    | 9.0pF | ±0.05pF | GRM1885C1H9R0WA01# |
|        |               |                    |       | ±0.1pF  | GRM1885C1H9R0BA01# |
|        |               |                    |       | ±0.25pF | GRM1885C1H9R0CA01# |
|        |               |                    |       | ±0.5pF  | GRM1885C1H9R0DA01# |
|        |               |                    | 9.1pF | ±0.05pF | GRM1885C1H9R1WA01# |
|        |               |                    |       | ±0.1pF  | GRM1885C1H9R1BA01# |
|        |               |                    |       | ±0.25pF | GRM1885C1H9R1CA01# |
|        |               |                    |       | ±0.5pF  | GRM1885C1H9R1DA01# |
|        |               |                    | 9.2pF | ±0.05pF | GRM1885C1H9R2WA01# |
|        |               |                    |       | ±0.1pF  | GRM1885C1H9R2BA01# |
|        |               |                    |       | ±0.25pF | GRM1885C1H9R2CA01# |
|        |               |                    |       | ±0.5pF  | GRM1885C1H9R2DA01# |
| 9.3pF  | ±0.05pF       | GRM1885C1H9R3WA01# |       |         |                    |
|        | ±0.1pF        | GRM1885C1H9R3BA01# |       |         |                    |
|        | ±0.25pF       | GRM1885C1H9R3CA01# |       |         |                    |
|        | ±0.5pF        | GRM1885C1H9R3DA01# |       |         |                    |
| 9.4pF  | ±0.05pF       | GRM1885C1H9R4WA01# |       |         |                    |
|        | ±0.1pF        | GRM1885C1H9R4BA01# |       |         |                    |

| T max. | Rated Voltage      | TC Code            | Cap.  | Tol.    | Part Number        |
|--------|--------------------|--------------------|-------|---------|--------------------|
| 0.9mm  | 50Vdc              | C0G                | 9.4pF | ±0.25pF | GRM1885C1H9R4CA01# |
|        |                    |                    |       | ±0.5pF  | GRM1885C1H9R4DA01# |
|        |                    |                    | 9.5pF | ±0.05pF | GRM1885C1H9R5WA01# |
|        |                    |                    |       | ±0.1pF  | GRM1885C1H9R5BA01# |
|        |                    |                    |       | ±0.25pF | GRM1885C1H9R5CA01# |
|        |                    |                    | 9.6pF | ±0.05pF | GRM1885C1H9R6WA01# |
|        |                    |                    |       | ±0.1pF  | GRM1885C1H9R6BA01# |
|        |                    |                    |       | ±0.25pF | GRM1885C1H9R6CA01# |
|        |                    |                    | 9.7pF | ±0.05pF | GRM1885C1H9R7WA01# |
|        |                    |                    |       | ±0.1pF  | GRM1885C1H9R7BA01# |
|        |                    |                    |       | ±0.25pF | GRM1885C1H9R7CA01# |
|        |                    |                    | 9.8pF | ±0.05pF | GRM1885C1H9R8WA01# |
|        |                    |                    |       | ±0.1pF  | GRM1885C1H9R8BA01# |
|        |                    |                    |       | ±0.25pF | GRM1885C1H9R8CA01# |
|        |                    |                    | 9.9pF | ±0.05pF | GRM1885C1H9R9WA01# |
|        |                    |                    |       | ±0.1pF  | GRM1885C1H9R9BA01# |
|        |                    |                    |       | ±0.25pF | GRM1885C1H9R9CA01# |
|        |                    |                    | 10pF  | ±5%     | GRM1885C1H100JA01# |
|        |                    |                    |       | ±5%     | GRM1885C1H120JA01# |
|        |                    |                    | 12pF  | ±5%     | GRM1885C1H120JA01# |
|        |                    |                    |       | ±5%     | GRM1885C1H150JA01# |
|        |                    |                    | 15pF  | ±5%     | GRM1885C1H150JA01# |
|        |                    |                    |       | ±5%     | GRM1885C1H180JA01# |
|        |                    |                    | 18pF  | ±5%     | GRM1885C1H180JA01# |
|        |                    |                    |       | ±5%     | GRM1885C1H220JA01# |
|        |                    |                    | 22pF  | ±5%     | GRM1885C1H220JA01# |
|        |                    |                    |       | ±5%     | GRM1885C1H270JA01# |
|        |                    |                    | 27pF  | ±5%     | GRM1885C1H270JA01# |
|        |                    |                    |       | ±5%     | GRM1885C1H330JA01# |
|        |                    |                    | 33pF  | ±5%     | GRM1885C1H330JA01# |
|        |                    |                    |       | ±5%     | GRM1885C1H390JA01# |
|        |                    |                    | 39pF  | ±5%     | GRM1885C1H390JA01# |
|        |                    |                    |       | ±5%     | GRM1885C1H470JA01# |
|        |                    |                    | 47pF  | ±5%     | GRM1885C1H470JA01# |
|        |                    |                    |       | ±5%     | GRM1885C1H560JA01# |
|        |                    |                    | 56pF  | ±5%     | GRM1885C1H560JA01# |
|        |                    |                    |       | ±5%     | GRM1885C1H680JA01# |
|        |                    |                    | 68pF  | ±5%     | GRM1885C1H680JA01# |
|        |                    |                    |       | ±5%     | GRM1885C1H820JA01# |
|        |                    |                    | 82pF  | ±5%     | GRM1885C1H820JA01# |
|        |                    |                    |       | ±5%     | GRM1885C1H101JA01# |
|        |                    |                    | 100pF | ±5%     | GRM1885C1H101JA01# |
|        |                    |                    |       | ±5%     | GRM1885C1H121JA01# |
|        |                    |                    | 120pF | ±5%     | GRM1885C1H121JA01# |
|        |                    |                    |       | ±5%     | GRM1885C1H151JA01# |
|        |                    |                    | 150pF | ±5%     | GRM1885C1H151JA01# |
|        |                    |                    |       | ±5%     | GRM1885C1H181JA01# |
|        |                    |                    | 180pF | ±5%     | GRM1885C1H181JA01# |
| ±5%    | GRM1885C1H221JA01# |                    |       |         |                    |
| 220pF  | ±5%                | GRM1885C1H221JA01# |       |         |                    |
|        | ±5%                | GRM1885C1H271JA01# |       |         |                    |
| 270pF  | ±5%                | GRM1885C1H271JA01# |       |         |                    |
|        | ±5%                | GRM1885C1H331JA01# |       |         |                    |
| 330pF  | ±5%                | GRM1885C1H331JA01# |       |         |                    |
|        | ±5%                | GRM1885C1H391JA01# |       |         |                    |
| 390pF  | ±5%                | GRM1885C1H391JA01# |       |         |                    |
|        | ±5%                | GRM1885C1H471JA01# |       |         |                    |
| 470pF  | ±5%                | GRM1885C1H471JA01# |       |         |                    |
|        | ±5%                | GRM1885C1H561JA01# |       |         |                    |
| 560pF  | ±5%                | GRM1885C1H561JA01# |       |         |                    |
|        | ±5%                | GRM1885C1H681JA01# |       |         |                    |
| 680pF  | ±5%                | GRM1885C1H681JA01# |       |         |                    |
|        | ±5%                | GRM1885C1H821JA01# |       |         |                    |
| 820pF  | ±5%                | GRM1885C1H821JA01# |       |         |                    |
|        | ±5%                | GRM1885C1H102JA01# |       |         |                    |
| 1000pF | ±5%                | GRM1885C1H102JA01# |       |         |                    |
|        | ±5%                | GRM1885C1H122JA01# |       |         |                    |
| 1200pF | ±5%                | GRM1885C1H122JA01# |       |         |                    |
|        | ±5%                | GRM1885C1H152JA01# |       |         |                    |
| 1500pF | ±5%                | GRM1885C1H152JA01# |       |         |                    |
|        | ±5%                | GRM1885C1H182JA01# |       |         |                    |
| 1800pF | ±5%                | GRM1885C1H182JA01# |       |         |                    |
|        | ±5%                | GRM1885C1H222JA01# |       |         |                    |
| 2200pF | ±5%                | GRM1885C1H222JA01# |       |         |                    |
|        | ±5%                | GRM1885C1H272JA01# |       |         |                    |
| 2700pF | ±5%                | GRM1885C1H272JA01# |       |         |                    |
|        | ±5%                | GRM1885C1H332JA01# |       |         |                    |
| 3300pF | ±5%                | GRM1885C1H332JA01# |       |         |                    |
|        | ±5%                | GRM1885C1H392JA01# |       |         |                    |
| 3900pF | ±5%                | GRM1885C1H392JA01# |       |         |                    |

Part number # indicates the package specification code.

GRM Series  
GJM Series  
GMA Series  
GMD Series  
GQM Series  
GRJ Series  
GR3 Series  
KRM Series  
KR3 Series  
LLA Series  
LLL Series  
LLM Series  
LLR Series  
⚠Caution/ Notice

## GRM Series Temperature Compensating Type Part Number List

(→ ■ 1.6x0.8mm)

| T max.  | Rated Voltage      | TC Code            | Cap.    | Tol.    | Part Number        |                    |
|---------|--------------------|--------------------|---------|---------|--------------------|--------------------|
| 0.9mm   | 50Vdc              | COG                | 4700pF  | ±5%     | GRM1885C1H472JA01# |                    |
|         |                    |                    | 5600pF  | ±5%     | GRM1885C1H562JA01# |                    |
|         |                    |                    | 6800pF  | ±5%     | GRM1885C1H682JA01# |                    |
|         |                    |                    | 8200pF  | ±5%     | GRM1885C1H822JA01# |                    |
|         |                    |                    | 10000pF | ±5%     | GRM1885C1H103JA01# |                    |
|         |                    | CK                 | 0.50pF  | ±0.05pF | GRM1884C1HR50WA01# |                    |
|         |                    |                    |         | ±0.1pF  | GRM1884C1HR50BA01# |                    |
|         |                    |                    | 0.60pF  | ±0.05pF | GRM1884C1HR60WA01# |                    |
|         |                    |                    |         | ±0.1pF  | GRM1884C1HR60BA01# |                    |
|         |                    |                    | 0.70pF  | ±0.05pF | GRM1884C1HR70WA01# |                    |
|         |                    |                    |         | ±0.1pF  | GRM1884C1HR70BA01# |                    |
|         |                    |                    | 0.80pF  | ±0.05pF | GRM1884C1HR80WA01# |                    |
|         |                    |                    |         | ±0.1pF  | GRM1884C1HR80BA01# |                    |
|         |                    |                    | 0.90pF  | ±0.05pF | GRM1884C1HR90WA01# |                    |
|         |                    |                    |         | ±0.1pF  | GRM1884C1HR90BA01# |                    |
|         |                    |                    | 1.0pF   | ±0.05pF | GRM1884C1H1R0WA01# |                    |
|         |                    |                    |         | ±0.1pF  | GRM1884C1H1R0BA01# |                    |
|         |                    |                    |         | ±0.25pF | GRM1884C1H1R0CA01# |                    |
|         |                    |                    | 1.1pF   | ±0.05pF | GRM1884C1H1R1WA01# |                    |
|         |                    |                    |         | ±0.1pF  | GRM1884C1H1R1BA01# |                    |
|         |                    |                    |         | ±0.25pF | GRM1884C1H1R1CA01# |                    |
|         |                    |                    | 1.2pF   | ±0.05pF | GRM1884C1H1R2WA01# |                    |
|         |                    |                    |         | ±0.1pF  | GRM1884C1H1R2BA01# |                    |
|         |                    |                    |         | ±0.25pF | GRM1884C1H1R2CA01# |                    |
|         |                    |                    | 1.3pF   | ±0.05pF | GRM1884C1H1R3WA01# |                    |
|         |                    |                    |         | ±0.1pF  | GRM1884C1H1R3BA01# |                    |
|         |                    |                    |         | ±0.25pF | GRM1884C1H1R3CA01# |                    |
|         |                    |                    | 1.4pF   | ±0.05pF | GRM1884C1H1R4WA01# |                    |
|         |                    |                    |         | ±0.1pF  | GRM1884C1H1R4BA01# |                    |
|         |                    |                    |         | ±0.25pF | GRM1884C1H1R4CA01# |                    |
|         |                    |                    | 1.5pF   | ±0.05pF | GRM1884C1H1R5WA01# |                    |
|         |                    |                    |         | ±0.1pF  | GRM1884C1H1R5BA01# |                    |
|         |                    |                    |         | ±0.25pF | GRM1884C1H1R5CA01# |                    |
|         |                    |                    | 1.6pF   | ±0.05pF | GRM1884C1H1R6WA01# |                    |
|         |                    |                    |         | ±0.1pF  | GRM1884C1H1R6BA01# |                    |
|         |                    |                    |         | ±0.25pF | GRM1884C1H1R6CA01# |                    |
|         |                    |                    | 1.7pF   | ±0.05pF | GRM1884C1H1R7WA01# |                    |
|         |                    |                    |         | ±0.1pF  | GRM1884C1H1R7BA01# |                    |
|         |                    |                    |         | ±0.25pF | GRM1884C1H1R7CA01# |                    |
|         |                    |                    | 1.8pF   | ±0.05pF | GRM1884C1H1R8WA01# |                    |
|         |                    |                    |         | ±0.1pF  | GRM1884C1H1R8BA01# |                    |
|         |                    |                    |         | ±0.25pF | GRM1884C1H1R8CA01# |                    |
|         |                    |                    | 1.9pF   | ±0.05pF | GRM1884C1H1R9WA01# |                    |
|         |                    |                    |         | ±0.1pF  | GRM1884C1H1R9BA01# |                    |
|         |                    |                    |         | ±0.25pF | GRM1884C1H1R9CA01# |                    |
|         |                    |                    | 2.0pF   | ±0.05pF | GRM1884C1H2R0WA01# |                    |
|         |                    |                    |         | ±0.1pF  | GRM1884C1H2R0BA01# |                    |
|         |                    |                    |         | ±0.25pF | GRM1884C1H2R0CA01# |                    |
|         |                    |                    | CJ      | 2.1pF   | ±0.05pF            | GRM1883C1H2R1WA01# |
|         |                    |                    |         |         | ±0.1pF             | GRM1883C1H2R1BA01# |
| ±0.25pF | GRM1883C1H2R1CA01# |                    |         |         |                    |                    |
| 2.2pF   | ±0.05pF            | GRM1883C1H2R2WA01# |         |         |                    |                    |
|         | ±0.1pF             | GRM1883C1H2R2BA01# |         |         |                    |                    |
|         | ±0.25pF            | GRM1883C1H2R2CA01# |         |         |                    |                    |

| T max. | Rated Voltage | TC Code            | Cap.               | Tol.    | Part Number        |
|--------|---------------|--------------------|--------------------|---------|--------------------|
| 0.9mm  | 50Vdc         | CJ                 | 2.3pF              | ±0.05pF | GRM1883C1H2R3WA01# |
|        |               |                    |                    | ±0.1pF  | GRM1883C1H2R3BA01# |
|        |               |                    |                    | ±0.25pF | GRM1883C1H2R3CA01# |
|        |               |                    | 2.4pF              | ±0.05pF | GRM1883C1H2R4WA01# |
|        |               |                    |                    | ±0.1pF  | GRM1883C1H2R4BA01# |
|        |               |                    |                    | ±0.25pF | GRM1883C1H2R4CA01# |
|        |               |                    | 2.5pF              | ±0.05pF | GRM1883C1H2R5WA01# |
|        |               |                    |                    | ±0.1pF  | GRM1883C1H2R5BA01# |
|        |               |                    |                    | ±0.25pF | GRM1883C1H2R5CA01# |
|        |               |                    | 2.6pF              | ±0.05pF | GRM1883C1H2R6WA01# |
|        |               |                    |                    | ±0.1pF  | GRM1883C1H2R6BA01# |
|        |               |                    |                    | ±0.25pF | GRM1883C1H2R6CA01# |
|        |               |                    | 2.7pF              | ±0.05pF | GRM1883C1H2R7WA01# |
|        |               |                    |                    | ±0.1pF  | GRM1883C1H2R7BA01# |
|        |               |                    |                    | ±0.25pF | GRM1883C1H2R7CA01# |
|        |               |                    | 2.8pF              | ±0.05pF | GRM1883C1H2R8WA01# |
|        |               |                    |                    | ±0.1pF  | GRM1883C1H2R8BA01# |
|        |               |                    |                    | ±0.25pF | GRM1883C1H2R8CA01# |
|        |               |                    | 2.9pF              | ±0.05pF | GRM1883C1H2R9WA01# |
|        |               |                    |                    | ±0.1pF  | GRM1883C1H2R9BA01# |
|        |               |                    |                    | ±0.25pF | GRM1883C1H2R9CA01# |
|        |               |                    | 3.0pF              | ±0.05pF | GRM1883C1H3R0WA01# |
|        |               |                    |                    | ±0.1pF  | GRM1883C1H3R0BA01# |
|        |               |                    |                    | ±0.25pF | GRM1883C1H3R0CA01# |
|        |               |                    | 3.1pF              | ±0.05pF | GRM1883C1H3R1WA01# |
|        |               |                    |                    | ±0.1pF  | GRM1883C1H3R1BA01# |
|        |               |                    |                    | ±0.25pF | GRM1883C1H3R1CA01# |
|        |               |                    | 3.2pF              | ±0.05pF | GRM1883C1H3R2WA01# |
|        |               |                    |                    | ±0.1pF  | GRM1883C1H3R2BA01# |
|        |               |                    |                    | ±0.25pF | GRM1883C1H3R2CA01# |
|        |               |                    | 3.3pF              | ±0.05pF | GRM1883C1H3R3WA01# |
|        |               |                    |                    | ±0.1pF  | GRM1883C1H3R3BA01# |
|        |               |                    |                    | ±0.25pF | GRM1883C1H3R3CA01# |
|        |               |                    | 3.4pF              | ±0.05pF | GRM1883C1H3R4WA01# |
|        |               |                    |                    | ±0.1pF  | GRM1883C1H3R4BA01# |
|        |               |                    |                    | ±0.25pF | GRM1883C1H3R4CA01# |
|        |               |                    | 3.5pF              | ±0.05pF | GRM1883C1H3R5WA01# |
|        |               |                    |                    | ±0.1pF  | GRM1883C1H3R5BA01# |
|        |               |                    |                    | ±0.25pF | GRM1883C1H3R5CA01# |
|        |               |                    | 3.6pF              | ±0.05pF | GRM1883C1H3R6WA01# |
|        |               |                    |                    | ±0.1pF  | GRM1883C1H3R6BA01# |
|        |               |                    |                    | ±0.25pF | GRM1883C1H3R6CA01# |
|        |               |                    | 3.7pF              | ±0.05pF | GRM1883C1H3R7WA01# |
|        |               |                    |                    | ±0.1pF  | GRM1883C1H3R7BA01# |
|        |               |                    |                    | ±0.25pF | GRM1883C1H3R7CA01# |
| 3.8pF  | ±0.05pF       | GRM1883C1H3R8WA01# |                    |         |                    |
|        | ±0.1pF        | GRM1883C1H3R8BA01# |                    |         |                    |
|        | ±0.25pF       | GRM1883C1H3R8CA01# |                    |         |                    |
| 3.9pF  | ±0.05pF       | GRM1883C1H3R9WA01# |                    |         |                    |
|        | ±0.1pF        | GRM1883C1H3R9BA01# |                    |         |                    |
|        | ±0.25pF       | GRM1883C1H3R9CA01# |                    |         |                    |
| CH     | 4.0pF         | ±0.05pF            | GRM1882C1H4R0WA01# |         |                    |
|        |               | ±0.1pF             | GRM1882C1H4R0BA01# |         |                    |
|        |               | ±0.25pF            | GRM1882C1H4R0CA01# |         |                    |

Part number # indicates the package specification code.

## GRM Series Temperature Compensating Type Part Number List

(→ ■ 1.6x0.8mm)

| T max. | Rated Voltage | TC Code | Cap.  | Tol.    | Part Number        |
|--------|---------------|---------|-------|---------|--------------------|
| 0.9mm  | 50Vdc         | CH      | 4.1pF | ±0.05pF | GRM1882C1H4R1WA01# |
|        |               |         |       | ±0.1pF  | GRM1882C1H4R1BA01# |
|        |               |         |       | ±0.25pF | GRM1882C1H4R1CA01# |
|        |               |         | 4.2pF | ±0.05pF | GRM1882C1H4R2WA01# |
|        |               |         |       | ±0.1pF  | GRM1882C1H4R2BA01# |
|        |               |         |       | ±0.25pF | GRM1882C1H4R2CA01# |
|        |               |         | 4.3pF | ±0.05pF | GRM1882C1H4R3WA01# |
|        |               |         |       | ±0.1pF  | GRM1882C1H4R3BA01# |
|        |               |         |       | ±0.25pF | GRM1882C1H4R3CA01# |
|        |               |         | 4.4pF | ±0.05pF | GRM1882C1H4R4WA01# |
|        |               |         |       | ±0.1pF  | GRM1882C1H4R4BA01# |
|        |               |         |       | ±0.25pF | GRM1882C1H4R4CA01# |
|        |               |         | 4.5pF | ±0.05pF | GRM1882C1H4R5WA01# |
|        |               |         |       | ±0.1pF  | GRM1882C1H4R5BA01# |
|        |               |         |       | ±0.25pF | GRM1882C1H4R5CA01# |
|        |               |         | 4.6pF | ±0.05pF | GRM1882C1H4R6WA01# |
|        |               |         |       | ±0.1pF  | GRM1882C1H4R6BA01# |
|        |               |         |       | ±0.25pF | GRM1882C1H4R6CA01# |
|        |               |         | 4.7pF | ±0.05pF | GRM1882C1H4R7WA01# |
|        |               |         |       | ±0.1pF  | GRM1882C1H4R7BA01# |
|        |               |         |       | ±0.25pF | GRM1882C1H4R7CA01# |
|        |               |         | 4.8pF | ±0.05pF | GRM1882C1H4R8WA01# |
|        |               |         |       | ±0.1pF  | GRM1882C1H4R8BA01# |
|        |               |         |       | ±0.25pF | GRM1882C1H4R8CA01# |
|        |               |         | 4.9pF | ±0.05pF | GRM1882C1H4R9WA01# |
|        |               |         |       | ±0.1pF  | GRM1882C1H4R9BA01# |
|        |               |         |       | ±0.25pF | GRM1882C1H4R9CA01# |
|        |               |         | 5.0pF | ±0.05pF | GRM1882C1H5R0WA01# |
|        |               |         |       | ±0.1pF  | GRM1882C1H5R0BA01# |
|        |               |         |       | ±0.25pF | GRM1882C1H5R0CA01# |
|        |               |         | 5.1pF | ±0.05pF | GRM1882C1H5R1WA01# |
|        |               |         |       | ±0.1pF  | GRM1882C1H5R1BA01# |
|        |               |         |       | ±0.25pF | GRM1882C1H5R1CA01# |
|        |               |         |       | ±0.5pF  | GRM1882C1H5R1DA01# |
|        |               |         | 5.2pF | ±0.05pF | GRM1882C1H5R2WA01# |
|        |               |         |       | ±0.1pF  | GRM1882C1H5R2BA01# |
|        |               |         |       | ±0.25pF | GRM1882C1H5R2CA01# |
|        |               |         |       | ±0.5pF  | GRM1882C1H5R2DA01# |
|        |               |         | 5.3pF | ±0.05pF | GRM1882C1H5R3WA01# |
|        |               |         |       | ±0.1pF  | GRM1882C1H5R3BA01# |
|        |               |         |       | ±0.25pF | GRM1882C1H5R3CA01# |
|        |               |         |       | ±0.5pF  | GRM1882C1H5R3DA01# |
|        |               |         | 5.4pF | ±0.05pF | GRM1882C1H5R4WA01# |
|        |               |         |       | ±0.1pF  | GRM1882C1H5R4BA01# |
|        |               |         |       | ±0.25pF | GRM1882C1H5R4CA01# |
|        |               |         |       | ±0.5pF  | GRM1882C1H5R4DA01# |
|        |               |         | 5.5pF | ±0.05pF | GRM1882C1H5R5WA01# |
|        |               |         |       | ±0.1pF  | GRM1882C1H5R5BA01# |
|        |               |         |       | ±0.25pF | GRM1882C1H5R5CA01# |
|        |               |         |       | ±0.5pF  | GRM1882C1H5R5DA01# |
|        |               |         | 5.6pF | ±0.05pF | GRM1882C1H5R6WA01# |
|        |               |         |       | ±0.1pF  | GRM1882C1H5R6BA01# |
|        |               |         |       | ±0.25pF | GRM1882C1H5R6CA01# |
|        |               |         |       | ±0.5pF  | GRM1882C1H5R6DA01# |

| T max. | Rated Voltage      | TC Code | Cap.  | Tol.    | Part Number        |
|--------|--------------------|---------|-------|---------|--------------------|
| 0.9mm  | 50Vdc              | CH      | 5.7pF | ±0.05pF | GRM1882C1H5R7WA01# |
|        |                    |         |       | ±0.1pF  | GRM1882C1H5R7BA01# |
|        |                    |         |       | ±0.25pF | GRM1882C1H5R7CA01# |
|        |                    |         |       | ±0.5pF  | GRM1882C1H5R7DA01# |
|        |                    |         | 5.8pF | ±0.05pF | GRM1882C1H5R8WA01# |
|        |                    |         |       | ±0.1pF  | GRM1882C1H5R8BA01# |
|        |                    |         |       | ±0.25pF | GRM1882C1H5R8CA01# |
|        |                    |         | 5.9pF | ±0.05pF | GRM1882C1H5R9WA01# |
|        |                    |         |       | ±0.1pF  | GRM1882C1H5R9BA01# |
|        |                    |         |       | ±0.25pF | GRM1882C1H5R9CA01# |
|        |                    |         | 6.0pF | ±0.05pF | GRM1882C1H6R0WA01# |
|        |                    |         |       | ±0.1pF  | GRM1882C1H6R0BA01# |
|        |                    |         |       | ±0.25pF | GRM1882C1H6R0CA01# |
|        |                    |         |       | ±0.5pF  | GRM1882C1H6R0DA01# |
|        |                    |         | 6.1pF | ±0.05pF | GRM1882C1H6R1WA01# |
|        |                    |         |       | ±0.1pF  | GRM1882C1H6R1BA01# |
|        |                    |         |       | ±0.25pF | GRM1882C1H6R1CA01# |
|        |                    |         | 6.2pF | ±0.05pF | GRM1882C1H6R2WA01# |
|        |                    |         |       | ±0.1pF  | GRM1882C1H6R2BA01# |
|        |                    |         |       | ±0.25pF | GRM1882C1H6R2CA01# |
|        |                    |         | 6.3pF | ±0.05pF | GRM1882C1H6R3WA01# |
|        |                    |         |       | ±0.1pF  | GRM1882C1H6R3BA01# |
|        |                    |         |       | ±0.25pF | GRM1882C1H6R3CA01# |
|        |                    |         | 6.4pF | ±0.05pF | GRM1882C1H6R4WA01# |
|        |                    |         |       | ±0.1pF  | GRM1882C1H6R4BA01# |
|        |                    |         |       | ±0.25pF | GRM1882C1H6R4CA01# |
|        |                    |         | 6.5pF | ±0.05pF | GRM1882C1H6R5WA01# |
|        |                    |         |       | ±0.1pF  | GRM1882C1H6R5BA01# |
|        |                    |         |       | ±0.25pF | GRM1882C1H6R5CA01# |
|        |                    |         | 6.6pF | ±0.05pF | GRM1882C1H6R6WA01# |
|        |                    |         |       | ±0.1pF  | GRM1882C1H6R6BA01# |
|        |                    |         |       | ±0.25pF | GRM1882C1H6R6CA01# |
|        |                    |         | 6.7pF | ±0.05pF | GRM1882C1H6R7WA01# |
|        |                    |         |       | ±0.1pF  | GRM1882C1H6R7BA01# |
|        |                    |         |       | ±0.25pF | GRM1882C1H6R7CA01# |
|        |                    |         | 6.8pF | ±0.05pF | GRM1882C1H6R8WA01# |
|        |                    |         |       | ±0.1pF  | GRM1882C1H6R8BA01# |
|        |                    |         |       | ±0.25pF | GRM1882C1H6R8CA01# |
|        |                    |         | 6.9pF | ±0.05pF | GRM1882C1H6R9WA01# |
|        |                    |         |       | ±0.1pF  | GRM1882C1H6R9BA01# |
|        |                    |         |       | ±0.25pF | GRM1882C1H6R9CA01# |
|        |                    |         | 7.0pF | ±0.05pF | GRM1882C1H7R0WA01# |
| ±0.1pF | GRM1882C1H7R0BA01# |         |       |         |                    |

Part number # indicates the package specification code.

GRM Series  
GJM Series  
GMA Series  
GMD Series  
GQM Series  
GRJ Series  
GR3 Series  
KRM Series  
KR3 Series  
LLA Series  
LLL Series  
LLM Series  
LLR Series  
⚠Caution/Notice

# GRM Series Temperature Compensating Type Part Number List

(→ ■ 1.6x0.8mm)

| T max. | Rated Voltage | TC Code | Cap.  | Tol.    | Part Number        |
|--------|---------------|---------|-------|---------|--------------------|
| 0.9mm  | 50Vdc         | CH      | 7.0pF | ±0.25pF | GRM1882C1H7R0CA01# |
|        |               |         |       | ±0.5pF  | GRM1882C1H7R0DA01# |
|        |               |         | 7.1pF | ±0.05pF | GRM1882C1H7R1WA01# |
|        |               |         |       | ±0.1pF  | GRM1882C1H7R1BA01# |
|        |               |         |       | ±0.25pF | GRM1882C1H7R1CA01# |
|        |               |         | 7.2pF | ±0.05pF | GRM1882C1H7R2WA01# |
|        |               |         |       | ±0.1pF  | GRM1882C1H7R2BA01# |
|        |               |         | 7.3pF | ±0.05pF | GRM1882C1H7R3WA01# |
|        |               |         |       | ±0.1pF  | GRM1882C1H7R3BA01# |
|        |               |         |       | ±0.25pF | GRM1882C1H7R3CA01# |
|        |               |         | 7.4pF | ±0.05pF | GRM1882C1H7R4WA01# |
|        |               |         |       | ±0.1pF  | GRM1882C1H7R4BA01# |
|        |               |         |       | ±0.25pF | GRM1882C1H7R4CA01# |
|        |               |         |       | ±0.5pF  | GRM1882C1H7R4DA01# |
|        |               |         | 7.5pF | ±0.05pF | GRM1882C1H7R5WA01# |
|        |               |         |       | ±0.1pF  | GRM1882C1H7R5BA01# |
|        |               |         |       | ±0.25pF | GRM1882C1H7R5CA01# |
|        |               |         |       | ±0.5pF  | GRM1882C1H7R5DA01# |
|        |               |         | 7.6pF | ±0.05pF | GRM1882C1H7R6WA01# |
|        |               |         |       | ±0.1pF  | GRM1882C1H7R6BA01# |
|        |               |         |       | ±0.25pF | GRM1882C1H7R6CA01# |
|        |               |         |       | ±0.5pF  | GRM1882C1H7R6DA01# |
|        |               |         | 7.7pF | ±0.05pF | GRM1882C1H7R7WA01# |
|        |               |         |       | ±0.1pF  | GRM1882C1H7R7BA01# |
|        |               |         |       | ±0.25pF | GRM1882C1H7R7CA01# |
|        |               |         |       | ±0.5pF  | GRM1882C1H7R7DA01# |
|        |               |         | 7.8pF | ±0.05pF | GRM1882C1H7R8WA01# |
|        |               |         |       | ±0.1pF  | GRM1882C1H7R8BA01# |
|        |               |         |       | ±0.25pF | GRM1882C1H7R8CA01# |
|        |               |         |       | ±0.5pF  | GRM1882C1H7R8DA01# |
|        |               |         | 7.9pF | ±0.05pF | GRM1882C1H7R9WA01# |
|        |               |         |       | ±0.1pF  | GRM1882C1H7R9BA01# |
|        |               |         |       | ±0.25pF | GRM1882C1H7R9CA01# |
|        |               |         |       | ±0.5pF  | GRM1882C1H7R9DA01# |
|        |               |         | 8.0pF | ±0.05pF | GRM1882C1H8R0WA01# |
|        |               |         |       | ±0.1pF  | GRM1882C1H8R0BA01# |
|        |               |         |       | ±0.25pF | GRM1882C1H8R0CA01# |
|        |               |         |       | ±0.5pF  | GRM1882C1H8R0DA01# |
|        |               |         | 8.1pF | ±0.05pF | GRM1882C1H8R1WA01# |
|        |               |         |       | ±0.1pF  | GRM1882C1H8R1BA01# |
|        |               |         |       | ±0.25pF | GRM1882C1H8R1CA01# |
|        |               |         |       | ±0.5pF  | GRM1882C1H8R1DA01# |
|        |               |         | 8.2pF | ±0.05pF | GRM1882C1H8R2WA01# |
|        |               |         |       | ±0.1pF  | GRM1882C1H8R2BA01# |
|        |               |         |       | ±0.25pF | GRM1882C1H8R2CA01# |
|        |               |         |       | ±0.5pF  | GRM1882C1H8R2DA01# |
|        |               |         | 8.3pF | ±0.05pF | GRM1882C1H8R3WA01# |
|        |               |         |       | ±0.1pF  | GRM1882C1H8R3BA01# |
|        |               |         |       | ±0.25pF | GRM1882C1H8R3CA01# |
|        |               |         |       | ±0.5pF  | GRM1882C1H8R3DA01# |

| T max. | Rated Voltage | TC Code | Cap.  | Tol.    | Part Number        |
|--------|---------------|---------|-------|---------|--------------------|
| 0.9mm  | 50Vdc         | CH      | 8.4pF | ±0.05pF | GRM1882C1H8R4WA01# |
|        |               |         |       | ±0.1pF  | GRM1882C1H8R4BA01# |
|        |               |         |       | ±0.25pF | GRM1882C1H8R4CA01# |
|        |               |         |       | ±0.5pF  | GRM1882C1H8R4DA01# |
|        |               |         | 8.5pF | ±0.05pF | GRM1882C1H8R5WA01# |
|        |               |         |       | ±0.1pF  | GRM1882C1H8R5BA01# |
|        |               |         |       | ±0.25pF | GRM1882C1H8R5CA01# |
|        |               |         | 8.6pF | ±0.05pF | GRM1882C1H8R6WA01# |
|        |               |         |       | ±0.1pF  | GRM1882C1H8R6BA01# |
|        |               |         |       | ±0.25pF | GRM1882C1H8R6CA01# |
|        |               |         | 8.7pF | ±0.05pF | GRM1882C1H8R7WA01# |
|        |               |         |       | ±0.1pF  | GRM1882C1H8R7BA01# |
|        |               |         |       | ±0.25pF | GRM1882C1H8R7CA01# |
|        |               |         | 8.8pF | ±0.05pF | GRM1882C1H8R8WA01# |
|        |               |         |       | ±0.1pF  | GRM1882C1H8R8BA01# |
|        |               |         |       | ±0.25pF | GRM1882C1H8R8CA01# |
|        |               |         | 8.9pF | ±0.05pF | GRM1882C1H8R9WA01# |
|        |               |         |       | ±0.1pF  | GRM1882C1H8R9BA01# |
|        |               |         |       | ±0.25pF | GRM1882C1H8R9CA01# |
|        |               |         | 9.0pF | ±0.05pF | GRM1882C1H9R0WA01# |
|        |               |         |       | ±0.1pF  | GRM1882C1H9R0BA01# |
|        |               |         |       | ±0.25pF | GRM1882C1H9R0CA01# |
|        |               |         | 9.1pF | ±0.05pF | GRM1882C1H9R1WA01# |
|        |               |         |       | ±0.1pF  | GRM1882C1H9R1BA01# |
|        |               |         |       | ±0.25pF | GRM1882C1H9R1CA01# |
|        |               |         | 9.2pF | ±0.05pF | GRM1882C1H9R2WA01# |
|        |               |         |       | ±0.1pF  | GRM1882C1H9R2BA01# |
|        |               |         |       | ±0.25pF | GRM1882C1H9R2CA01# |
|        |               |         | 9.3pF | ±0.05pF | GRM1882C1H9R3WA01# |
|        |               |         |       | ±0.1pF  | GRM1882C1H9R3BA01# |
|        |               |         |       | ±0.25pF | GRM1882C1H9R3CA01# |
|        |               |         | 9.4pF | ±0.05pF | GRM1882C1H9R4WA01# |
|        |               |         |       | ±0.1pF  | GRM1882C1H9R4BA01# |
|        |               |         |       | ±0.25pF | GRM1882C1H9R4CA01# |
|        |               |         | 9.5pF | ±0.05pF | GRM1882C1H9R5WA01# |
|        |               |         |       | ±0.1pF  | GRM1882C1H9R5BA01# |
|        |               |         |       | ±0.25pF | GRM1882C1H9R5CA01# |
|        |               |         | 9.6pF | ±0.05pF | GRM1882C1H9R6WA01# |
|        |               |         |       | ±0.1pF  | GRM1882C1H9R6BA01# |
|        |               |         |       | ±0.25pF | GRM1882C1H9R6CA01# |
|        |               |         | 9.7pF | ±0.05pF | GRM1882C1H9R7WA01# |
|        |               |         |       | ±0.1pF  | GRM1882C1H9R7BA01# |

Part number # indicates the package specification code.

## GRM Series Temperature Compensating Type Part Number List

(→ ■ 1.6x0.8mm)

| T max. | Rated Voltage | TC Code            | Cap.    | Tol.    | Part Number        |                    |
|--------|---------------|--------------------|---------|---------|--------------------|--------------------|
| 0.9mm  | 50Vdc         | CH                 | 9.7pF   | ±0.25pF | GRM1882C1H9R7CA01# |                    |
|        |               |                    |         | ±0.5pF  | GRM1882C1H9R7DA01# |                    |
|        |               |                    | 9.8pF   | ±0.05pF | GRM1882C1H9R8WA01# |                    |
|        |               |                    |         | ±0.1pF  | GRM1882C1H9R8BA01# |                    |
|        |               |                    |         | ±0.25pF | GRM1882C1H9R8CA01# |                    |
|        |               |                    |         | ±0.5pF  | GRM1882C1H9R8DA01# |                    |
|        |               |                    | 9.9pF   | ±0.05pF | GRM1882C1H9R9WA01# |                    |
|        |               |                    |         | ±0.1pF  | GRM1882C1H9R9BA01# |                    |
|        |               |                    |         | ±0.25pF | GRM1882C1H9R9CA01# |                    |
|        |               |                    |         | ±0.5pF  | GRM1882C1H9R9DA01# |                    |
|        |               |                    | 10pF    | ±5%     | GRM1882C1H100JA01# |                    |
|        |               |                    | 12pF    | ±5%     | GRM1882C1H120JA01# |                    |
|        |               |                    | 15pF    | ±5%     | GRM1882C1H150JA01# |                    |
|        |               |                    | 18pF    | ±5%     | GRM1882C1H180JA01# |                    |
|        |               |                    | 22pF    | ±5%     | GRM1882C1H220JA01# |                    |
|        |               |                    | 27pF    | ±5%     | GRM1882C1H270JA01# |                    |
|        |               |                    | 33pF    | ±5%     | GRM1882C1H330JA01# |                    |
|        |               |                    | 39pF    | ±5%     | GRM1882C1H390JA01# |                    |
|        |               |                    | 47pF    | ±5%     | GRM1882C1H470JA01# |                    |
|        |               |                    | 56pF    | ±5%     | GRM1882C1H560JA01# |                    |
|        |               |                    | 68pF    | ±5%     | GRM1882C1H680JA01# |                    |
|        |               |                    | 82pF    | ±5%     | GRM1882C1H820JA01# |                    |
|        |               |                    | 100pF   | ±5%     | GRM1882C1H101JA01# |                    |
|        |               |                    | 120pF   | ±5%     | GRM1882C1H121JA01# |                    |
|        |               |                    | 150pF   | ±5%     | GRM1882C1H151JA01# |                    |
|        |               |                    | 180pF   | ±5%     | GRM1882C1H181JA01# |                    |
|        |               |                    | 220pF   | ±5%     | GRM1882C1H221JA01# |                    |
|        |               |                    | 270pF   | ±5%     | GRM1882C1H271JA01# |                    |
|        |               |                    | 330pF   | ±5%     | GRM1882C1H331JA01# |                    |
|        |               |                    | 390pF   | ±5%     | GRM1882C1H391JA01# |                    |
|        |               |                    | 470pF   | ±5%     | GRM1882C1H471JA01# |                    |
|        |               |                    | 560pF   | ±5%     | GRM1882C1H561JA01# |                    |
|        |               |                    | 680pF   | ±5%     | GRM1882C1H681JA01# |                    |
|        |               |                    | 820pF   | ±5%     | GRM1882C1H821JA01# |                    |
|        |               |                    | 1000pF  | ±5%     | GRM1882C1H102JA01# |                    |
|        |               |                    | 1200pF  | ±5%     | GRM1882C1H122JA01# |                    |
|        |               |                    | 1500pF  | ±5%     | GRM1882C1H152JA01# |                    |
|        |               |                    | 1800pF  | ±5%     | GRM1882C1H182JA01# |                    |
|        |               |                    | 2200pF  | ±5%     | GRM1882C1H222JA01# |                    |
|        |               |                    | 2700pF  | ±5%     | GRM1882C1H272JA01# |                    |
|        |               |                    | 3300pF  | ±5%     | GRM1882C1H332JA01# |                    |
|        |               |                    | 3900pF  | ±5%     | GRM1882C1H392JA01# |                    |
|        |               |                    | 4700pF  | ±5%     | GRM1882C1H472JA01# |                    |
|        |               |                    | 5600pF  | ±5%     | GRM1882C1H562JA01# |                    |
|        |               |                    | 6800pF  | ±5%     | GRM1882C1H682JA01# |                    |
|        |               |                    | 8200pF  | ±5%     | GRM1882C1H822JA01# |                    |
|        |               |                    | 10000pF | ±5%     | GRM1882C1H103JA01# |                    |
|        |               |                    | SL      | 1200pF  | ±5%                | GRM1881X1H122JA01# |
|        |               |                    |         | 1500pF  | ±5%                | GRM1881X1H152JA01# |
|        |               |                    |         | 1800pF  | ±5%                | GRM1881X1H182JA01# |
| 2200pF | ±5%           | GRM1881X1H222JA01# |         |         |                    |                    |
| 2700pF | ±5%           | GRM1881X1H272JA01# |         |         |                    |                    |
| 3300pF | ±5%           | GRM1881X1H332JA01# |         |         |                    |                    |
| 3900pF | ±5%           | GRM1881X1H392JA01# |         |         |                    |                    |

| T max. | Rated Voltage | TC Code | Cap.    | Tol.   | Part Number        |                    |                    |                    |
|--------|---------------|---------|---------|--------|--------------------|--------------------|--------------------|--------------------|
| 0.9mm  | 50Vdc         | SL      | 4700pF  | ±5%    | GRM1881X1H472JA01# |                    |                    |                    |
|        |               |         | 5600pF  | ±5%    | GRM1881X1H562JA01# |                    |                    |                    |
|        |               |         | 6800pF  | ±5%    | GRM1881X1H682JA01# |                    |                    |                    |
|        |               |         | 8200pF  | ±5%    | GRM1881X1H822JA01# |                    |                    |                    |
|        |               |         | 10000pF | ±5%    | GRM1881X1H103JA01# |                    |                    |                    |
|        |               |         | U2J     | 1200pF | ±5%                | GRM1887U1H122JA01# |                    |                    |
|        |               |         |         | 1500pF | ±5%                | GRM1887U1H152JA01# |                    |                    |
|        |               |         |         | 1800pF | ±5%                | GRM1887U1H182JA01# |                    |                    |
|        |               |         |         | 2200pF | ±5%                | GRM1887U1H222JA01# |                    |                    |
|        |               |         |         | 2700pF | ±5%                | GRM1887U1H272JA01# |                    |                    |
|        |               | 3300pF  |         | ±5%    | GRM1887U1H332JA01# |                    |                    |                    |
|        |               | 3900pF  |         | ±5%    | GRM1887U1H392JA01# |                    |                    |                    |
|        |               | 4700pF  |         | ±5%    | GRM1887U1H472JA01# |                    |                    |                    |
|        |               | 5600pF  |         | ±5%    | GRM1887U1H562JA01# |                    |                    |                    |
|        |               | 6800pF  |         | ±5%    | GRM1887U1H682JA01# |                    |                    |                    |
|        |               | UJ      | 1000pF  | ±5%    | GRM1883U1H102JA01# |                    |                    |                    |
|        |               |         | 1200pF  | ±5%    | GRM1883U1H122JA01# |                    |                    |                    |
|        |               |         | 1500pF  | ±5%    | GRM1883U1H152JA01# |                    |                    |                    |
|        |               |         | 1800pF  | ±5%    | GRM1883U1H182JA01# |                    |                    |                    |
|        |               |         | 2200pF  | ±5%    | GRM1883U1H222JA01# |                    |                    |                    |
|        |               |         | 2700pF  | ±5%    | GRM1883U1H272JA01# |                    |                    |                    |
|        |               |         | 3300pF  | ±5%    | GRM1883U1H332JA01# |                    |                    |                    |
|        |               |         | 3900pF  | ±5%    | GRM1883U1H392JA01# |                    |                    |                    |
|        |               |         | 4700pF  | ±5%    | GRM1883U1H472JA01# |                    |                    |                    |
|        |               |         | 5600pF  | ±5%    | GRM1883U1H562JA01# |                    |                    |                    |
|        |               | SL      | 10Vdc   | SL     | 1200pF             | ±5%                | GRM1881X1A123JA01# |                    |
|        |               |         |         |        | 1500pF             | ±5%                | GRM1881X1A153JA01# |                    |
|        |               |         |         |        | 1800pF             | ±5%                | GRM1881X1A183JA01# |                    |
|        |               |         |         |        | 2200pF             | ±5%                | GRM1881X1A223JA01# |                    |
|        |               |         |         | U2J    | 1200pF             | ±5%                | GRM1887U1A123JA01# |                    |
|        |               |         |         |        | 1500pF             | ±5%                | GRM1887U1A153JA01# |                    |
|        |               |         |         |        | 1800pF             | ±5%                | GRM1887U1A183JA01# |                    |
|        |               |         |         |        | 2200pF             | ±5%                | GRM1887U1A223JA01# |                    |
|        |               |         |         |        | UJ                 | 1200pF             | ±5%                | GRM1883U1A123JA01# |
|        |               |         |         |        |                    | 1500pF             | ±5%                | GRM1883U1A153JA01# |
|        |               | UJ      | 1800pF  | ±5%    | GRM1883U1A183JA01# |                    |                    |                    |
|        |               |         | 2200pF  | ±5%    | GRM1883U1A223JA01# |                    |                    |                    |
|        |               |         | 2700pF  | ±5%    | GRM1883U1A273JA01# |                    |                    |                    |
|        |               |         | 3300pF  | ±5%    | GRM1883U1A333JA01# |                    |                    |                    |
|        |               |         | 3900pF  | ±5%    | GRM1883U1A393JA01# |                    |                    |                    |
|        |               |         | 4700pF  | ±5%    | GRM1883U1A473JA01# |                    |                    |                    |

■ 2.0x1.25mm

| T max. | Rated Voltage | TC Code | Cap.  | Tol. | Part Number        |
|--------|---------------|---------|-------|------|--------------------|
| 0.7mm  | 100Vdc        | C0G     | 100pF | ±5%  | GRM2165C2A101JA01# |
|        |               |         | 120pF | ±5%  | GRM2165C2A121JA01# |
|        |               |         | 150pF | ±5%  | GRM2165C2A151JA01# |
|        |               |         | 180pF | ±5%  | GRM2165C2A181JA01# |
|        |               |         | 220pF | ±5%  | GRM2165C2A221JA01# |
|        |               |         | 270pF | ±5%  | GRM2165C2A271JA01# |
|        |               |         | 330pF | ±5%  | GRM2165C2A331JA01# |

Part number # indicates the package specification code.

GRM Series  
GJM Series  
GMA Series  
GMD Series  
GQM Series  
GRJ Series  
GR3 Series  
KRM Series  
KR3 Series  
LLA Series  
LLL Series  
LLM Series  
LLR Series  
⚠Caution/Notice

# GRM Series Temperature Compensating Type Part Number List

(→ ■ 2.0x1.25mm)

| T max.  | Rated Voltage | TC Code | Cap.               | Tol.   | Part Number        |                    |
|---------|---------------|---------|--------------------|--------|--------------------|--------------------|
| 0.7mm   | 100Vdc        | C0G     | 390pF              | ±5%    | GRM2165C2A391JA01# |                    |
|         |               |         | 470pF              | ±5%    | GRM2165C2A471JA01# |                    |
|         |               |         | 560pF              | ±5%    | GRM2165C2A561JA01# |                    |
|         |               |         | 680pF              | ±5%    | GRM2165C2A681JA01# |                    |
|         |               |         | 820pF              | ±5%    | GRM2165C2A821JA01# |                    |
|         |               |         | 1000pF             | ±5%    | GRM2165C2A102JA01# |                    |
|         |               |         | 1200pF             | ±5%    | GRM2165C2A122JA01# |                    |
|         |               |         | 1500pF             | ±5%    | GRM2165C2A152JA01# |                    |
|         |               |         | 1800pF             | ±5%    | GRM2165C2A182JA01# |                    |
|         |               |         | 2200pF             | ±5%    | GRM2165C2A222JA01# |                    |
|         |               |         | 2700pF             | ±5%    | GRM2165C2A272JA01# |                    |
|         |               |         | 3300pF             | ±5%    | GRM2165C2A332JA01# |                    |
|         |               |         | CH                 | 100pF  | ±5%                | GRM2162C2A101JA01# |
|         |               |         |                    | 120pF  | ±5%                | GRM2162C2A121JA01# |
|         |               |         |                    | 150pF  | ±5%                | GRM2162C2A151JA01# |
|         |               |         |                    | 180pF  | ±5%                | GRM2162C2A181JA01# |
|         |               |         |                    | 220pF  | ±5%                | GRM2162C2A221JA01# |
|         |               |         |                    | 270pF  | ±5%                | GRM2162C2A271JA01# |
|         |               |         |                    | 330pF  | ±5%                | GRM2162C2A331JA01# |
|         |               |         |                    | 390pF  | ±5%                | GRM2162C2A391JA01# |
|         |               |         |                    | 470pF  | ±5%                | GRM2162C2A471JA01# |
|         |               |         |                    | 560pF  | ±5%                | GRM2162C2A561JA01# |
|         |               |         |                    | 680pF  | ±5%                | GRM2162C2A681JA01# |
|         |               |         |                    | 820pF  | ±5%                | GRM2162C2A821JA01# |
|         |               |         | C0G                | 1200pF | ±5%                | GRM2165C1H122JA01# |
|         |               |         |                    | 1500pF | ±5%                | GRM2165C1H152JA01# |
|         |               |         |                    | 1800pF | ±5%                | GRM2165C1H182JA01# |
|         |               |         |                    | 2200pF | ±5%                | GRM2165C1H222JA01# |
|         |               |         |                    | 2700pF | ±5%                | GRM2165C1H272JA01# |
|         |               |         |                    | 3300pF | ±5%                | GRM2165C1H332JA01# |
|         |               |         |                    | 3900pF | ±5%                | GRM2165C1H392JA01# |
|         |               |         |                    | 4700pF | ±5%                | GRM2165C1H472JA01# |
|         |               |         |                    | CH     | 1200pF             | ±5%                |
|         |               | 1500pF  |                    |        | ±5%                | GRM2162C1H152JA01# |
|         |               | 1800pF  |                    |        | ±5%                | GRM2162C1H182JA01# |
|         |               | 2200pF  |                    |        | ±5%                | GRM2162C1H222JA01# |
|         |               | 2700pF  | ±5%                |        | GRM2162C1H272JA01# |                    |
|         |               | 3300pF  | ±5%                |        | GRM2162C1H332JA01# |                    |
|         |               | 3900pF  | ±5%                |        | GRM2162C1H392JA01# |                    |
|         |               | 4700pF  | ±5%                |        | GRM2162C1H472JA01# |                    |
|         |               | SL      | 12000pF            | ±5%    | GRM2161X1H123JA01# |                    |
|         |               |         | 15000pF            | ±5%    | GRM2161X1H153JA01# |                    |
|         |               |         | 18000pF            | ±5%    | GRM2161X1H183JA01# |                    |
|         |               | U2J     | 12000pF            | ±5%    | GRM2167U1H123JA01# |                    |
|         |               |         | 15000pF            | ±5%    | GRM2167U1H153JA01# |                    |
| 18000pF | ±5%           |         | GRM2167U1H183JA01# |        |                    |                    |
| UJ      | 10000pF       | ±5%     | GRM2163U1H103JA01# |        |                    |                    |

| T max. | Rated Voltage | TC Code            | Cap.    | Tol.  | Part Number        |                    |
|--------|---------------|--------------------|---------|-------|--------------------|--------------------|
| 0.7mm  | 50Vdc         | UJ                 | 12000pF | ±5%   | GRM2163U1H123JA01# |                    |
|        |               |                    | 15000pF | ±5%   | GRM2163U1H153JA01# |                    |
|        |               |                    | 18000pF | ±5%   | GRM2163U1H183JA01# |                    |
| 0.95mm | 50Vdc         | C0G                | 5600pF  | ±5%   | GRM2195C1H562JA01# |                    |
|        |               |                    | 6800pF  | ±5%   | GRM2195C1H682JA01# |                    |
|        |               |                    | 8200pF  | ±5%   | GRM2195C1H822JA01# |                    |
|        |               |                    | 10000pF | ±5%   | GRM2195C1H103JA01# |                    |
|        |               |                    | 12000pF | ±5%   | GRM2195C1H123JA01# |                    |
|        |               |                    | 15000pF | ±5%   | GRM2195C1H153JA01# |                    |
|        |               | CH                 | 5600pF  | ±5%   | GRM2192C1H562JA01# |                    |
|        |               |                    | 6800pF  | ±5%   | GRM2192C1H682JA01# |                    |
|        |               |                    | 8200pF  | ±5%   | GRM2192C1H822JA01# |                    |
|        |               |                    | 10000pF | ±5%   | GRM2192C1H103JA01# |                    |
|        |               |                    | 12000pF | ±5%   | GRM2192C1H123JA01# |                    |
|        |               |                    | 15000pF | ±5%   | GRM2192C1H153JA01# |                    |
|        | 10Vdc         | SL                 | 22000pF | ±5%   | GRM2191X1H223JA01# |                    |
|        |               |                    | 27000pF | ±5%   | GRM2191X1H273JA01# |                    |
|        |               | U2J                | 22000pF | ±5%   | GRM2197U1H223JA01# |                    |
|        |               |                    | 27000pF | ±5%   | GRM2197U1H273JA01# |                    |
|        |               | UJ                 | 22000pF | ±5%   | GRM2193U1H223JA01# |                    |
|        |               |                    | 27000pF | ±5%   | GRM2193U1H273JA01# |                    |
| 1.0mm  | 250Vdc        | C0G                | 10pF    | ±5%   | GRM21A5C2E100JW01# |                    |
|        |               |                    | 12pF    | ±5%   | GRM21A5C2E120JW01# |                    |
|        |               |                    | 15pF    | ±5%   | GRM21A5C2E150JW01# |                    |
|        |               |                    | 18pF    | ±5%   | GRM21A5C2E180JW01# |                    |
|        |               |                    | 22pF    | ±5%   | GRM21A5C2E220JW01# |                    |
|        |               |                    | 27pF    | ±5%   | GRM21A5C2E270JW01# |                    |
|        |               |                    | 33pF    | ±5%   | GRM21A5C2E330JW01# |                    |
|        |               |                    | 39pF    | ±5%   | GRM21A5C2E390JW01# |                    |
|        |               |                    | 47pF    | ±5%   | GRM21A5C2E470JW01# |                    |
|        |               |                    | 56pF    | ±5%   | GRM21A5C2E560JW01# |                    |
|        |               |                    | 68pF    | ±5%   | GRM21A5C2E680JW01# |                    |
|        |               |                    | 82pF    | ±5%   | GRM21A5C2E820JW01# |                    |
|        |               |                    | 100pF   | ±5%   | GRM21A5C2E101JW01# |                    |
|        |               |                    | 120pF   | ±5%   | GRM21A5C2E121JW01# |                    |
|        |               |                    | 150pF   | ±5%   | GRM21A5C2E151JW01# |                    |
|        |               |                    | 180pF   | ±5%   | GRM21A5C2E181JW01# |                    |
|        |               |                    | 220pF   | ±5%   | GRM21A5C2E221JW01# |                    |
|        |               |                    | 270pF   | ±5%   | GRM21A5C2E271JW01# |                    |
|        |               |                    | 330pF   | ±5%   | GRM21A5C2E331JW01# |                    |
|        |               |                    | U2J     | 100pF | ±5%                | GRM21A7U2E101JW31# |
|        |               |                    |         | 120pF | ±5%                | GRM21A7U2E121JW31# |
|        |               |                    |         | 150pF | ±5%                | GRM21A7U2E151JW31# |
|        |               |                    |         | 180pF | ±5%                | GRM21A7U2E181JW31# |
|        |               |                    |         | 220pF | ±5%                | GRM21A7U2E221JW31# |
| 270pF  | ±5%           | GRM21A7U2E271JW31# |         |       |                    |                    |
| 330pF  | ±5%           | GRM21A7U2E331JW31# |         |       |                    |                    |
| 390pF  | ±5%           | GRM21A7U2E391JW31# |         |       |                    |                    |
| 470pF  | ±5%           | GRM21A7U2E471JW31# |         |       |                    |                    |
| 560pF  | ±5%           | GRM21A7U2E561JW31# |         |       |                    |                    |
| 680pF  | ±5%           | GRM21A7U2E681JW31# |         |       |                    |                    |

Part number # indicates the package specification code.

## GRM Series Temperature Compensating Type Part Number List

(→ ■ 2.0x1.25mm)

| T max.  | Rated Voltage | TC Code | Cap.               | Tol.               | Part Number        |                    |                    |
|---------|---------------|---------|--------------------|--------------------|--------------------|--------------------|--------------------|
| 1.0mm   | 250Vdc        | U2J     | 820pF              | ±5%                | GRM21A7U2E821JW31# |                    |                    |
|         |               |         | 1000pF             | ±5%                | GRM21A7U2E102JW31# |                    |                    |
|         |               |         | 1200pF             | ±5%                | GRM21A7U2E122JW31# |                    |                    |
|         |               |         | 1500pF             | ±5%                | GRM21A7U2E152JW31# |                    |                    |
|         |               |         | 1800pF             | ±5%                | GRM21A7U2E182JW31# |                    |                    |
|         |               |         | 2200pF             | ±5%                | GRM21A7U2E222JW31# |                    |                    |
|         |               |         | 200Vdc             | C0G                | 10pF               | ±5%                | GRM21A5C2D100JW01# |
|         |               |         |                    |                    | 12pF               | ±5%                | GRM21A5C2D120JW01# |
|         |               |         |                    |                    | 15pF               | ±5%                | GRM21A5C2D150JW01# |
|         |               |         |                    |                    | 18pF               | ±5%                | GRM21A5C2D180JW01# |
|         |               |         |                    |                    | 22pF               | ±5%                | GRM21A5C2D220JW01# |
|         |               |         |                    |                    | 27pF               | ±5%                | GRM21A5C2D270JW01# |
|         | 33pF          | ±5%     |                    |                    | GRM21A5C2D330JW01# |                    |                    |
|         | 39pF          | ±5%     |                    |                    | GRM21A5C2D390JW01# |                    |                    |
|         | 47pF          | ±5%     |                    |                    | GRM21A5C2D470JW01# |                    |                    |
|         | 56pF          | ±5%     |                    |                    | GRM21A5C2D560JW01# |                    |                    |
|         | 68pF          | ±5%     |                    |                    | GRM21A5C2D680JW01# |                    |                    |
|         | 82pF          | ±5%     |                    |                    | GRM21A5C2D820JW01# |                    |                    |
|         | 100pF         | ±5%     |                    |                    | GRM21A5C2D101JW01# |                    |                    |
|         | 120pF         | ±5%     |                    |                    | GRM21A5C2D121JW01# |                    |                    |
|         | 150pF         | ±5%     |                    |                    | GRM21A5C2D151JW01# |                    |                    |
|         | 180pF         | ±5%     |                    |                    | GRM21A5C2D181JW01# |                    |                    |
|         | 220pF         | ±5%     |                    |                    | GRM21A5C2D221JW01# |                    |                    |
|         | 270pF         | ±5%     |                    |                    | GRM21A5C2D271JW01# |                    |                    |
|         | 330pF         | ±5%     |                    |                    | GRM21A5C2D331JW01# |                    |                    |
|         | U2J           | 100pF   |                    |                    | ±5%                | GRM21A7U2D101JW31# |                    |
|         |               | 120pF   |                    |                    | ±5%                | GRM21A7U2D121JW31# |                    |
|         |               | 150pF   | ±5%                | GRM21A7U2D151JW31# |                    |                    |                    |
|         |               | 180pF   | ±5%                | GRM21A7U2D181JW31# |                    |                    |                    |
|         |               | 220pF   | ±5%                | GRM21A7U2D221JW31# |                    |                    |                    |
|         |               | 270pF   | ±5%                | GRM21A7U2D271JW31# |                    |                    |                    |
|         |               | 330pF   | ±5%                | GRM21A7U2D331JW31# |                    |                    |                    |
|         |               | 390pF   | ±5%                | GRM21A7U2D391JW31# |                    |                    |                    |
| 470pF   |               | ±5%     | GRM21A7U2D471JW31# |                    |                    |                    |                    |
| 560pF   |               | ±5%     | GRM21A7U2D561JW31# |                    |                    |                    |                    |
| 680pF   |               | ±5%     | GRM21A7U2D681JW31# |                    |                    |                    |                    |
| 820pF   |               | ±5%     | GRM21A7U2D821JW31# |                    |                    |                    |                    |
| 1000pF  |               | ±5%     | GRM21A7U2D102JW31# |                    |                    |                    |                    |
| 1200pF  |               | ±5%     | GRM21A7U2D122JW31# |                    |                    |                    |                    |
| 1500pF  |               | ±5%     | GRM21A7U2D152JW31# |                    |                    |                    |                    |
| 1800pF  |               | ±5%     | GRM21A7U2D182JW31# |                    |                    |                    |                    |
| 2200pF  |               | ±5%     | GRM21A7U2D222JW31# |                    |                    |                    |                    |
| 50Vdc   |               | SL      | 33000pF            | ±5%                | GRM21A1X1H333JA39# |                    |                    |
|         | U2J           |         | 33000pF            | ±5%                | GRM21A7U1H333JA39# |                    |                    |
|         | UJ            |         | 33000pF            | ±5%                | GRM21A3U1H333JA39# |                    |                    |
|         | 1.35mm        | 50Vdc   | C0G                | 18000pF            | ±5%                | GRM21B5C1H183JA01# |                    |
|         |               |         |                    | 22000pF            | ±5%                | GRM21B5C1H223JA01# |                    |
|         |               |         | CH                 | 18000pF            | ±5%                | GRM21B2C1H183JA01# |                    |
| 22000pF |               |         |                    | ±5%                | GRM21B2C1H223JA01# |                    |                    |
| SL      |               |         | 39000pF            | ±5%                | GRM21B1X1H393JA01# |                    |                    |
|         |               |         | 47000pF            | ±5%                | GRM21B1X1H473JA01# |                    |                    |
| U2J     | 39000pF       | ±5%     | GRM21B7U1H393JA01# |                    |                    |                    |                    |
|         | 47000pF       | ±5%     | GRM21B7U1H473JA01# |                    |                    |                    |                    |
| UJ      | 39000pF       | ±5%     | GRM21B3U1H393JA01# |                    |                    |                    |                    |

| T max. | Rated Voltage | TC Code | Cap.    | Tol.               | Part Number        |                    |                    |
|--------|---------------|---------|---------|--------------------|--------------------|--------------------|--------------------|
| 1.35mm | 50Vdc         | UJ      | 47000pF | ±5%                | GRM21B3U1H473JA01# |                    |                    |
|        |               |         | SL      | 68000pF            | ±5%                | GRM21B1X1A683JA01# |                    |
|        |               |         |         | 82000pF            | ±5%                | GRM21B1X1A823JA01# |                    |
|        |               | 0.10μF  |         | ±5%                | GRM21B1X1A104JA01# |                    |                    |
|        |               | U2J     | 68000pF | ±5%                | GRM21B7U1A683JA01# |                    |                    |
|        |               |         | 82000pF | ±5%                | GRM21B7U1A823JA01# |                    |                    |
|        | 0.10μF        |         | ±5%     | GRM21B7U1A104JA01# |                    |                    |                    |
|        | UJ            |         | 68000pF | ±5%                | GRM21B3U1A683JA01# |                    |                    |
|        |               |         | 82000pF | ±5%                | GRM21B3U1A823JA01# |                    |                    |
|        |               |         | 0.10μF  | ±5%                | GRM21B3U1A104JA01# |                    |                    |
|        | 1.45mm        | 250Vdc  | U2J     | 2700pF             | ±5%                | GRM21B7U2E272JW32# |                    |
|        |               |         |         | 3300pF             | ±5%                | GRM21B7U2E332JW32# |                    |
| 3900pF |               |         |         | ±5%                | GRM21B7U2E392JW32# |                    |                    |
| 4700pF |               |         |         | ±5%                | GRM21B7U2E472JW32# |                    |                    |
| 5600pF |               |         |         | ±5%                | GRM21B7U2E562JW32# |                    |                    |
| 200Vdc |               |         |         | U2J                | 2700pF             | ±5%                | GRM21B7U2D272JW32# |
|        |               |         |         |                    | 3300pF             | ±5%                | GRM21B7U2D332JW32# |
|        |               |         |         |                    | 3900pF             | ±5%                | GRM21B7U2D392JW32# |
|        |               |         |         |                    | 4700pF             | ±5%                | GRM21B7U2D472JW32# |
|        |               |         |         |                    | 5600pF             | ±5%                | GRM21B7U2D562JW32# |

■ 3.2x1.6mm

| T max. | Rated Voltage | TC Code | Cap.    | Tol.    | Part Number        |                    |
|--------|---------------|---------|---------|---------|--------------------|--------------------|
| 0.95mm | 100Vdc        | C0G     | 1800pF  | ±5%     | GRM3195C2A182JA01# |                    |
|        |               |         | 2200pF  | ±5%     | GRM3195C2A222JA01# |                    |
|        |               |         | 2700pF  | ±5%     | GRM3195C2A272JA01# |                    |
|        |               |         | 3300pF  | ±5%     | GRM3195C2A332JA01# |                    |
|        |               |         | 3900pF  | ±5%     | GRM3195C2A392JA01# |                    |
|        |               |         | 4700pF  | ±5%     | GRM3195C2A472JA01# |                    |
|        |               |         | 5600pF  | ±5%     | GRM3195C2A562JA01# |                    |
|        |               |         | 6800pF  | ±5%     | GRM3195C2A682JA01# |                    |
|        |               |         | 8200pF  | ±5%     | GRM3195C2A822JA01# |                    |
|        |               |         | 10000pF | ±5%     | GRM3195C2A103JA01# |                    |
|        |               |         | 12000pF | ±5%     | GRM3195C2A123JA01# |                    |
|        |               |         | 15000pF | ±5%     | GRM3195C2A153JA01# |                    |
|        |               |         | 18000pF | ±5%     | GRM3195C2A183JA01# |                    |
|        |               |         | 22000pF | ±5%     | GRM3195C2A223JA01# |                    |
|        |               |         | CH      | 1800pF  | ±5%                | GRM3192C2A182JA01# |
|        |               |         |         | 2200pF  | ±5%                | GRM3192C2A222JA01# |
|        |               |         |         | 2700pF  | ±5%                | GRM3192C2A272JA01# |
|        |               |         |         | 3300pF  | ±5%                | GRM3192C2A332JA01# |
|        |               |         |         | 3900pF  | ±5%                | GRM3192C2A392JA01# |
|        |               |         |         | 4700pF  | ±5%                | GRM3192C2A472JA01# |
|        |               |         |         | 5600pF  | ±5%                | GRM3192C2A562JA01# |
|        |               |         |         | 6800pF  | ±5%                | GRM3192C2A682JA01# |
|        |               |         |         | 8200pF  | ±5%                | GRM3192C2A822JA01# |
|        |               |         |         | 10000pF | ±5%                | GRM3192C2A103JA01# |
|        |               | 12000pF |         | ±5%     | GRM3192C2A123JA01# |                    |
|        |               | 15000pF |         | ±5%     | GRM3192C2A153JA01# |                    |
|        |               | 50Vdc   | C0G     | 12000pF | ±5%                | GRM3195C1H123JA01# |

Part number # indicates the package specification code.

GRM Series  
GJM Series  
GMA Series  
GMD Series  
GQM Series  
GRJ Series  
GR3 Series  
KRM Series  
KR3 Series  
LLA Series  
LLL Series  
LLM Series  
LLR Series  
⚠Caution/Notice

# GRM Series Temperature Compensating Type Part Number List

(→ ■ 3.2x1.6mm)

| T max.  | Rated Voltage | TC Code            | Cap.    | Tol.    | Part Number        |                    |                    |
|---------|---------------|--------------------|---------|---------|--------------------|--------------------|--------------------|
| 0.95mm  | 50Vdc         | COG                | 15000pF | ±5%     | GRM3195C1H153JA01# |                    |                    |
|         |               |                    | 18000pF | ±5%     | GRM3195C1H183JA01# |                    |                    |
|         |               |                    | 22000pF | ±5%     | GRM3195C1H223JA01# |                    |                    |
|         |               |                    | 27000pF | ±5%     | GRM3195C1H273JA01# |                    |                    |
|         |               |                    | 33000pF | ±5%     | GRM3195C1H333JA01# |                    |                    |
|         |               |                    | 39000pF | ±5%     | GRM3195C1H393JA01# |                    |                    |
|         |               |                    | CH      | 12000pF | ±5%                | GRM3192C1H123JA01# |                    |
|         |               |                    |         | 15000pF | ±5%                | GRM3192C1H153JA01# |                    |
|         |               |                    |         | 18000pF | ±5%                | GRM3192C1H183JA01# |                    |
|         |               | 22000pF            |         | ±5%     | GRM3192C1H223JA01# |                    |                    |
|         |               | 27000pF            |         | ±5%     | GRM3192C1H273JA01# |                    |                    |
|         |               | 33000pF            |         | ±5%     | GRM3192C1H333JA01# |                    |                    |
|         |               | 39000pF            |         | ±5%     | GRM3192C1H393JA01# |                    |                    |
|         |               | SL                 |         | 56000pF | ±5%                | GRM3191X1H563JA01# |                    |
|         |               | U2J                |         | 56000pF | ±5%                | GRM3197U1H563JA01# |                    |
|         |               | UJ                 | 56000pF | ±5%     | GRM3193U1H563JA01# |                    |                    |
|         |               | 1.0mm              | 2000Vdc | U2J     | 10pF               | ±5%                | GRM31A7U3D100JW31# |
|         |               |                    |         |         | 12pF               | ±5%                | GRM31A7U3D120JW31# |
|         |               |                    |         |         | 15pF               | ±5%                | GRM31A7U3D150JW31# |
|         |               |                    |         |         | 18pF               | ±5%                | GRM31A7U3D180JW31# |
|         |               |                    |         |         | 22pF               | ±5%                | GRM31A7U3D220JW31# |
| 27pF    | ±5%           |                    |         |         | GRM31A7U3D270JW31# |                    |                    |
| 33pF    | ±5%           |                    |         |         | GRM31A7U3D330JW31# |                    |                    |
| 39pF    | ±5%           |                    |         |         | GRM31A7U3D390JW31# |                    |                    |
| 47pF    | ±5%           |                    |         |         | GRM31A7U3D470JW31# |                    |                    |
| 56pF    | ±5%           |                    |         |         | GRM31A7U3D560JW31# |                    |                    |
| 68pF    | ±5%           |                    |         |         | GRM31A7U3D680JW31# |                    |                    |
| 1000Vdc | COG           |                    |         |         | 10pF               | ±5%                | GRM31A5C3A100JW01# |
|         |               |                    |         |         | 12pF               | ±5%                | GRM31A5C3A120JW01# |
|         |               |                    |         |         | 15pF               | ±5%                | GRM31A5C3A150JW01# |
|         |               |                    |         |         | 18pF               | ±5%                | GRM31A5C3A180JW01# |
|         |               |                    |         |         | 22pF               | ±5%                | GRM31A5C3A220JW01# |
|         |               |                    |         |         | 27pF               | ±5%                | GRM31A5C3A270JW01# |
|         |               |                    |         |         | 33pF               | ±5%                | GRM31A5C3A330JW01# |
|         |               |                    | 39pF    | ±5%     | GRM31A5C3A390JW01# |                    |                    |
|         |               |                    | 47pF    | ±5%     | GRM31A5C3A470JW01# |                    |                    |
|         |               |                    | 56pF    | ±5%     | GRM31A5C3A560JW01# |                    |                    |
|         |               |                    | 68pF    | ±5%     | GRM31A5C3A680JW01# |                    |                    |
|         |               |                    | 82pF    | ±5%     | GRM31A5C3A820JW01# |                    |                    |
|         |               |                    | 100pF   | ±5%     | GRM31A5C3A101JW01# |                    |                    |
|         |               |                    | 120pF   | ±5%     | GRM31A5C3A121JW01# |                    |                    |
|         |               |                    | 150pF   | ±5%     | GRM31A5C3A151JW01# |                    |                    |
|         |               |                    | 180pF   | ±5%     | GRM31A5C3A181JW01# |                    |                    |
|         |               |                    | 220pF   | ±5%     | GRM31A5C3A221JW01# |                    |                    |
|         |               |                    | U2J     | U2J     | 10pF               | ±5%                | GRM31A7U3A100JW31# |
| 12pF    | ±5%           |                    |         |         | GRM31A7U3A120JW31# |                    |                    |
| 15pF    | ±5%           |                    |         |         | GRM31A7U3A150JW31# |                    |                    |
| 18pF    | ±5%           |                    |         |         | GRM31A7U3A180JW31# |                    |                    |
| 22pF    | ±5%           |                    |         |         | GRM31A7U3A220JW31# |                    |                    |
| 27pF    | ±5%           |                    |         |         | GRM31A7U3A270JW31# |                    |                    |
| 33pF    | ±5%           |                    |         |         | GRM31A7U3A330JW31# |                    |                    |
| 39pF    | ±5%           |                    |         |         | GRM31A7U3A390JW31# |                    |                    |
| 47pF    | ±5%           | GRM31A7U3A470JW31# |         |         |                    |                    |                    |
| 56pF    | ±5%           | GRM31A7U3A560JW31# |         |         |                    |                    |                    |
| 68pF    | ±5%           | GRM31A7U3A680JW31# |         |         |                    |                    |                    |
| 82pF    | ±5%           | GRM31A7U3A820JW31# |         |         |                    |                    |                    |
| 100pF   | ±5%           | GRM31A7U3A101JW31# |         |         |                    |                    |                    |
| 120pF   | ±5%           | GRM31A7U3A121JW31# |         |         |                    |                    |                    |
| 150pF   | ±5%           | GRM31A7U3A151JW31# |         |         |                    |                    |                    |
| 180pF   | ±5%           | GRM31A7U3A181JW31# |         |         |                    |                    |                    |

| T max. | Rated Voltage | TC Code            | Cap.               | Tol.               | Part Number        |     |                    |
|--------|---------------|--------------------|--------------------|--------------------|--------------------|-----|--------------------|
| 1.0mm  | 1000Vdc       | U2J                | 68pF               | ±5%                | GRM31A7U3A680JW31# |     |                    |
|        |               |                    | 82pF               | ±5%                | GRM31A7U3A820JW31# |     |                    |
|        |               |                    | 100pF              | ±5%                | GRM31A7U3A101JW31# |     |                    |
|        |               |                    | 120pF              | ±5%                | GRM31A7U3A121JW31# |     |                    |
|        |               |                    | 150pF              | ±5%                | GRM31A7U3A151JW31# |     |                    |
|        |               |                    | 180pF              | ±5%                | GRM31A7U3A181JW31# |     |                    |
|        |               |                    | 220pF              | ±5%                | GRM31A7U3A221JW31# |     |                    |
|        |               |                    | 270pF              | ±5%                | GRM31A7U3A271JW31# |     |                    |
|        |               |                    | 330pF              | ±5%                | GRM31A7U3A331JW31# |     |                    |
|        |               |                    | 630Vdc             | COG                | 10pF               | ±5% | GRM31A5C2J100JW01# |
|        |               |                    |                    |                    | 12pF               | ±5% | GRM31A5C2J120JW01# |
|        |               |                    |                    |                    | 15pF               | ±5% | GRM31A5C2J150JW01# |
|        |               |                    |                    |                    | 18pF               | ±5% | GRM31A5C2J180JW01# |
|        |               |                    |                    |                    | 22pF               | ±5% | GRM31A5C2J220JW01# |
|        |               |                    |                    |                    | 27pF               | ±5% | GRM31A5C2J270JW01# |
|        |               |                    |                    |                    | 33pF               | ±5% | GRM31A5C2J330JW01# |
|        |               |                    |                    |                    | 39pF               | ±5% | GRM31A5C2J390JW01# |
|        |               |                    |                    |                    | 47pF               | ±5% | GRM31A5C2J470JW01# |
|        | 56pF          | ±5%                |                    |                    | GRM31A5C2J560JW01# |     |                    |
|        | 68pF          | ±5%                |                    |                    | GRM31A5C2J680JW01# |     |                    |
|        | 82pF          | ±5%                |                    |                    | GRM31A5C2J820JW01# |     |                    |
|        | 100pF         | ±5%                |                    |                    | GRM31A5C2J101JW01# |     |                    |
|        | 120pF         | ±5%                |                    |                    | GRM31A5C2J121JW01# |     |                    |
|        | 150pF         | ±5%                |                    |                    | GRM31A5C2J151JW01# |     |                    |
|        | 180pF         | ±5%                |                    |                    | GRM31A5C2J181JW01# |     |                    |
|        | 220pF         | ±5%                |                    |                    | GRM31A5C2J221JW01# |     |                    |
|        | 270pF         | ±5%                |                    |                    | GRM31A5C2J271JW01# |     |                    |
|        | 330pF         | ±5%                | GRM31A5C2J331JW01# |                    |                    |     |                    |
|        | 390pF         | ±5%                | GRM31A5C2J391JW01# |                    |                    |     |                    |
|        | 470pF         | ±5%                | GRM31A5C2J471JW01# |                    |                    |     |                    |
|        | 560pF         | ±5%                | GRM31A5C2J561JW01# |                    |                    |     |                    |
|        | U2J           | U2J                | 10pF               | ±5%                | GRM31A7U2J100JW31# |     |                    |
|        |               |                    | 12pF               | ±5%                | GRM31A7U2J120JW31# |     |                    |
|        |               |                    | 15pF               | ±5%                | GRM31A7U2J150JW31# |     |                    |
|        |               |                    | 18pF               | ±5%                | GRM31A7U2J180JW31# |     |                    |
|        |               |                    | 22pF               | ±5%                | GRM31A7U2J220JW31# |     |                    |
| 27pF   |               |                    | ±5%                | GRM31A7U2J270JW31# |                    |     |                    |
| 33pF   |               |                    | ±5%                | GRM31A7U2J330JW31# |                    |     |                    |
| 39pF   |               |                    | ±5%                | GRM31A7U2J390JW31# |                    |     |                    |
| 47pF   |               |                    | ±5%                | GRM31A7U2J470JW31# |                    |     |                    |
| 56pF   |               |                    | ±5%                | GRM31A7U2J560JW31# |                    |     |                    |
| 68pF   |               |                    | ±5%                | GRM31A7U2J680JW31# |                    |     |                    |
| 82pF   |               |                    | ±5%                | GRM31A7U2J820JW31# |                    |     |                    |
| 100pF  |               |                    | ±5%                | GRM31A7U2J101JW31# |                    |     |                    |
| 120pF  |               |                    | ±5%                | GRM31A7U2J121JW31# |                    |     |                    |
| 150pF  |               |                    | ±5%                | GRM31A7U2J151JW31# |                    |     |                    |
| 180pF  |               |                    | ±5%                | GRM31A7U2J181JW31# |                    |     |                    |
| 220pF  |               |                    | ±5%                | GRM31A7U2J221JW31# |                    |     |                    |
| 270pF  |               |                    | ±5%                | GRM31A7U2J271JW31# |                    |     |                    |
| 330pF  | ±5%           | GRM31A7U2J331JW31# |                    |                    |                    |     |                    |
| 390pF  | ±5%           | GRM31A7U2J391JW31# |                    |                    |                    |     |                    |
| 470pF  | ±5%           | GRM31A7U2J471JW31# |                    |                    |                    |     |                    |
| 560pF  | ±5%           | GRM31A7U2J561JW31# |                    |                    |                    |     |                    |
| 680pF  | ±5%           | GRM31A7U2J681JW31# |                    |                    |                    |     |                    |

Part number # indicates the package specification code.



## GRM Series Temperature Compensating Type Part Number List

(→ ■ 3.2x1.6mm)

| T max. | Rated Voltage | TC Code            | Cap.   | Tol. | Part Number        |     |                    |
|--------|---------------|--------------------|--------|------|--------------------|-----|--------------------|
| 1.0mm  | 630Vdc        | U2J                | 820pF  | ±5%  | GRM31A7U2J821JW31# |     |                    |
|        |               |                    | 1000pF | ±5%  | GRM31A7U2J102JW31# |     |                    |
|        |               |                    | 1200pF | ±5%  | GRM31A7U2J122JW31# |     |                    |
|        |               |                    | 1500pF | ±5%  | GRM31A7U2J152JW31# |     |                    |
|        |               |                    | 1800pF | ±5%  | GRM31A7U2J182JW31# |     |                    |
|        |               |                    | 2200pF | ±5%  | GRM31A7U2J222JW31# |     |                    |
|        | 500Vdc        | C0G                | 10pF   | ±5%  | GRM31A5C2H100JW01# |     |                    |
|        |               |                    | 12pF   | ±5%  | GRM31A5C2H120JW01# |     |                    |
|        |               |                    | 15pF   | ±5%  | GRM31A5C2H150JW01# |     |                    |
|        |               |                    | 18pF   | ±5%  | GRM31A5C2H180JW01# |     |                    |
|        |               |                    | 22pF   | ±5%  | GRM31A5C2H220JW01# |     |                    |
|        |               |                    | 27pF   | ±5%  | GRM31A5C2H270JW01# |     |                    |
|        |               |                    | 33pF   | ±5%  | GRM31A5C2H330JW01# |     |                    |
|        |               |                    | 39pF   | ±5%  | GRM31A5C2H390JW01# |     |                    |
|        |               |                    | 47pF   | ±5%  | GRM31A5C2H470JW01# |     |                    |
|        |               |                    | 56pF   | ±5%  | GRM31A5C2H560JW01# |     |                    |
|        |               |                    | 68pF   | ±5%  | GRM31A5C2H680JW01# |     |                    |
|        |               |                    | 82pF   | ±5%  | GRM31A5C2H820JW01# |     |                    |
|        |               |                    | 100pF  | ±5%  | GRM31A5C2H101JW01# |     |                    |
|        |               |                    | 120pF  | ±5%  | GRM31A5C2H121JW01# |     |                    |
|        |               |                    | 150pF  | ±5%  | GRM31A5C2H151JW01# |     |                    |
|        |               |                    | 180pF  | ±5%  | GRM31A5C2H181JW01# |     |                    |
|        |               |                    | 220pF  | ±5%  | GRM31A5C2H221JW01# |     |                    |
|        |               |                    | 270pF  | ±5%  | GRM31A5C2H271JW01# |     |                    |
|        |               |                    | 330pF  | ±5%  | GRM31A5C2H331JW01# |     |                    |
|        |               |                    | 390pF  | ±5%  | GRM31A5C2H391JW01# |     |                    |
|        |               |                    | 470pF  | ±5%  | GRM31A5C2H471JW01# |     |                    |
|        |               |                    | 560pF  | ±5%  | GRM31A5C2H561JW01# |     |                    |
|        |               |                    | U2J    | U2J  | 10pF               | ±5% | GRM31A7U2H100JW31# |
|        |               |                    |        |      | 12pF               | ±5% | GRM31A7U2H120JW31# |
|        |               |                    |        |      | 15pF               | ±5% | GRM31A7U2H150JW31# |
|        |               |                    |        |      | 18pF               | ±5% | GRM31A7U2H180JW31# |
|        |               |                    |        |      | 22pF               | ±5% | GRM31A7U2H220JW31# |
|        |               |                    |        |      | 27pF               | ±5% | GRM31A7U2H270JW31# |
|        |               |                    |        |      | 33pF               | ±5% | GRM31A7U2H330JW31# |
|        |               |                    |        |      | 39pF               | ±5% | GRM31A7U2H390JW31# |
|        |               |                    |        |      | 47pF               | ±5% | GRM31A7U2H470JW31# |
|        |               |                    |        |      | 56pF               | ±5% | GRM31A7U2H560JW31# |
|        |               |                    |        |      | 68pF               | ±5% | GRM31A7U2H680JW31# |
|        |               |                    |        |      | 82pF               | ±5% | GRM31A7U2H820JW31# |
|        |               |                    |        |      | 100pF              | ±5% | GRM31A7U2H101JW31# |
|        |               |                    |        |      | 120pF              | ±5% | GRM31A7U2H121JW31# |
| 150pF  | ±5%           | GRM31A7U2H151JW31# |        |      |                    |     |                    |
| 180pF  | ±5%           | GRM31A7U2H181JW31# |        |      |                    |     |                    |
| 220pF  | ±5%           | GRM31A7U2H221JW31# |        |      |                    |     |                    |
| 270pF  | ±5%           | GRM31A7U2H271JW31# |        |      |                    |     |                    |
| 330pF  | ±5%           | GRM31A7U2H331JW31# |        |      |                    |     |                    |
| 390pF  | ±5%           | GRM31A7U2H391JW31# |        |      |                    |     |                    |
| 470pF  | ±5%           | GRM31A7U2H471JW31# |        |      |                    |     |                    |
| 560pF  | ±5%           | GRM31A7U2H561JW31# |        |      |                    |     |                    |
| 680pF  | ±5%           | GRM31A7U2H681JW31# |        |      |                    |     |                    |
| 820pF  | ±5%           | GRM31A7U2H821JW31# |        |      |                    |     |                    |
| 1000pF | ±5%           | GRM31A7U2H102JW31# |        |      |                    |     |                    |
| 1200pF | ±5%           | GRM31A7U2H122JW31# |        |      |                    |     |                    |

| T max. | Rated Voltage | TC Code | Cap.               | Tol.               | Part Number        |                    |
|--------|---------------|---------|--------------------|--------------------|--------------------|--------------------|
| 1.0mm  | 500Vdc        | U2J     | 1500pF             | ±5%                | GRM31A7U2H152JW31# |                    |
|        |               |         | 1800pF             | ±5%                | GRM31A7U2H182JW31# |                    |
|        |               |         | 2200pF             | ±5%                | GRM31A7U2H222JW31# |                    |
|        | 250Vdc        | U2J     | 2700pF             | ±5%                | GRM31A7U2E272JW31# |                    |
|        |               |         | 3300pF             | ±5%                | GRM31A7U2E332JW31# |                    |
|        |               |         | 3900pF             | ±5%                | GRM31A7U2E392JW31# |                    |
|        |               |         | 4700pF             | ±5%                | GRM31A7U2E472JW31# |                    |
|        |               |         | 5600pF             | ±5%                | GRM31A7U2E562JW31# |                    |
|        |               |         | 200Vdc             | U2J                | 2700pF             | ±5%                |
|        | 3300pF        | ±5%     | GRM31A7U2D332JW31# |                    |                    |                    |
|        | 3900pF        | ±5%     | GRM31A7U2D392JW31# |                    |                    |                    |
|        | 4700pF        | ±5%     | GRM31A7U2D472JW31# |                    |                    |                    |
|        | 5600pF        | ±5%     | GRM31A7U2D562JW31# |                    |                    |                    |
|        | 1.25mm        | 1000Vdc | U2J                |                    | 390pF              | ±5%                |
|        |               |         |                    | 470pF              | ±5%                | GRM31B7U3A471JW31# |
|        |               |         |                    | 560pF              | ±5%                | GRM31B7U3A561JW31# |
|        |               |         |                    | 680pF              | ±5%                | GRM31B7U3A681JW31# |
|        |               | 630Vdc  | C0G                | 680pF              | ±5%                | GRM31B5C2J681JW01# |
| 820pF  |               |         |                    | ±5%                | GRM31B5C2J821JW01# |                    |
| U2J    |               |         | 1000pF             | ±5%                | GRM31B5C2J102JW01# |                    |
|        |               |         | 2700pF             | ±5%                | GRM31B7U2J272JW31# |                    |
| 500Vdc |               | C0G     | 680pF              | ±5%                | GRM31B5C2H681JW01# |                    |
|        |               |         | 820pF              | ±5%                | GRM31B5C2H821JW01# |                    |
|        |               | U2J     | 1000pF             | ±5%                | GRM31B5C2H102JW01# |                    |
|        |               |         | 2700pF             | ±5%                | GRM31B7U2H272JW31# |                    |
| 250Vdc | U2J           | 3300pF  | ±5%                | GRM31B7U2J332JW31# |                    |                    |
|        |               | 6800pF  | ±5%                | GRM31B7U2E682JW31# |                    |                    |
|        |               | 8200pF  | ±5%                | GRM31B7U2E822JW31# |                    |                    |
|        |               | 10000pF | ±5%                | GRM31B7U2E103JW31# |                    |                    |
| 200Vdc | U2J           | 12000pF | ±5%                | GRM31B7U2E123JW31# |                    |                    |
|        |               | 6800pF  | ±5%                | GRM31B7U2D682JW31# |                    |                    |
|        |               | 8200pF  | ±5%                | GRM31B7U2D822JW31# |                    |                    |
|        |               | 10000pF | ±5%                | GRM31B7U2D103JW31# |                    |                    |
| 50Vdc  | C0G           | 47000pF | ±5%                | GRM31M5C1H473JA01# |                    |                    |
|        |               | 56000pF | ±5%                | GRM31M5C1H563JA01# |                    |                    |
|        | CH            | 47000pF | ±5%                | GRM31M2C1H473JA01# |                    |                    |
|        |               | 56000pF | ±5%                | GRM31M2C1H563JA01# |                    |                    |
|        | SL            | 68000pF | ±5%                | GRM31M1X1H683JA01# |                    |                    |
|        |               | 82000pF | ±5%                | GRM31M1X1H823JA01# |                    |                    |
|        | U2J           | 0.10μF  | ±5%                | GRM31M1X1H104JA01# |                    |                    |
|        |               | 68000pF | ±5%                | GRM31M7U1H683JA01# |                    |                    |
| UJ     | 82000pF       | ±5%     | GRM31M7U1H823JA01# |                    |                    |                    |
|        | 0.10μF        | ±5%     | GRM31M7U1H104JA01# |                    |                    |                    |
| 1.8mm  | 1000Vdc       | U2J     | 68000pF            | ±5%                | GRM31M3U1H683JA01# |                    |
|        |               |         | 82000pF            | ±5%                | GRM31M3U1H823JA01# |                    |
|        | 630Vdc        | U2J     | 0.10μF             | ±5%                | GRM31M3U1H104JA01# |                    |
|        |               |         | 82000pF            | ±5%                | GRM31M3U1H823JA01# |                    |
|        | 500Vdc        | U2J     | 820pF              | ±5%                | GRM31C7U3A821JW32# |                    |
|        |               |         | 1000pF             | ±5%                | GRM31C7U3A102JW32# |                    |
|        | 250Vdc        | U2J     | 3900pF             | ±5%                | GRM31C7U2J392JW32# |                    |
|        |               |         | 4700pF             | ±5%                | GRM31C7U2J472JW32# |                    |
|        | 500Vdc        | U2J     | 3900pF             | ±5%                | GRM31C7U2H392JW32# |                    |
|        |               |         | 4700pF             | ±5%                | GRM31C7U2H472JW32# |                    |
|        | 250Vdc        | U2J     | 15000pF            | ±5%                | GRM31C7U2E153JW32# |                    |

Part number # indicates the package specification code.

GRM Series  
GJM Series  
GMA Series  
GMD Series  
GQM Series  
GRJ Series  
GR3 Series  
KRM Series  
KR3 Series  
LLA Series  
LLL Series  
LLM Series  
LLR Series  
⚠Caution/ Notice

# GRM Series Temperature Compensating Type Part Number List

(→ ■ 3.2x1.6mm)

| T max. | Rated Voltage | TC Code | Cap.    | Tol.               | Part Number        |                    |
|--------|---------------|---------|---------|--------------------|--------------------|--------------------|
| 1.8mm  | 250Vdc        | U2J     | 18000pF | ±5%                | GRM31C7U2E183JW32# |                    |
|        |               |         | 22000pF | ±5%                | GRM31C7U2E223JW32# |                    |
|        |               | C0G     | 68000pF | ±5%                | GRM31C5C1H683JA01# |                    |
|        |               |         | 82000pF | ±5%                | GRM31C5C1H823JA01# |                    |
|        |               |         | 0.10μF  | ±5%                | GRM31C5C1H104JA01# |                    |
|        |               |         | CH      | 68000pF            | ±5%                | GRM31C2C1H683JA01# |
|        | 82000pF       | ±5%     |         | GRM31C2C1H823JA01# |                    |                    |
|        | 25Vdc         | C0G     | 0.12μF  | ±5%                | GRM31C5C1E124JA01# |                    |
|        |               |         | CH      | 0.12μF             | ±5%                | GRM31C2C1E124JA01# |
|        |               |         |         | C0G                | 0.12μF             | ±5%                |
|        |               | CH      | 0.12μF  | ±5%                | GRM31C2C1C124JA01# |                    |

■ 3.2x2.5mm

| T max. | Rated Voltage | TC Code | Cap.    | Tol.    | Part Number        |                    |
|--------|---------------|---------|---------|---------|--------------------|--------------------|
| 1.0mm  | 2000Vdc       | U2J     | 82pF    | ±5%     | GRM32A7U3D820JW31# |                    |
|        |               |         | 100pF   | ±5%     | GRM32A7U3D101JW31# |                    |
|        |               |         | 120pF   | ±5%     | GRM32A7U3D121JW31# |                    |
|        |               |         | 150pF   | ±5%     | GRM32A7U3D151JW31# |                    |
|        | 630Vdc        | U2J     | 1200pF  | ±5%     | GRM32A7U2J122JW31# |                    |
|        |               |         | 1500pF  | ±5%     | GRM32A7U2J152JW31# |                    |
|        |               |         | 1800pF  | ±5%     | GRM32A7U2J182JW31# |                    |
|        |               |         | 2200pF  | ±5%     | GRM32A7U2J222JW31# |                    |
|        | 500Vdc        | U2J     | 1200pF  | ±5%     | GRM32A7U2H122JW31# |                    |
|        |               |         | 1500pF  | ±5%     | GRM32A7U2H152JW31# |                    |
|        |               |         | 1800pF  | ±5%     | GRM32A7U2H182JW31# |                    |
|        |               |         | 2200pF  | ±5%     | GRM32A7U2H222JW31# |                    |
|        | 1.25mm        | 2000Vdc | U2J     | 180pF   | ±5%                | GRM32B7U3D181JW31# |
|        |               |         |         | 220pF   | ±5%                | GRM32B7U3D221JW31# |
|        |               | 1000Vdc | U2J     | 1200pF  | ±5%                | GRM32B7U3A122JW31# |
|        |               |         |         | 630Vdc  | U2J                | 5600pF             |
| 500Vdc |               | U2J     | 5600pF  | ±5%     | GRM32B7U2H562JW31# |                    |
|        |               |         | 1.5mm   | 1000Vdc | U2J                | 1500pF             |
| 630Vdc | U2J           | 6800pF  |         |         |                    | ±5%                |
| 500Vdc | U2J           | 6800pF  |         | ±5%     | GRM32Q7U2H682JW31# |                    |
|        |               | 250Vdc  |         | U2J     | 27000pF            | ±5%                |
| 2.0mm  | 1000Vdc       |         | U2J     |         | 1800pF             | ±5%                |
|        |               | 2200pF  |         | ±5%     | GRM32D7U3A222JW31# |                    |
|        | 630Vdc        | U2J     | 8200pF  | ±5%     | GRM32D7U2J822JW31# |                    |
|        |               |         | 10000pF | ±5%     | GRM32D7U2J103JW31# |                    |
|        | 500Vdc        | U2J     | 8200pF  | ±5%     | GRM32D7U2H822JW31# |                    |
|        |               |         | 10000pF | ±5%     | GRM32D7U2H103JW31# |                    |
|        | 250Vdc        | U2J     | 33000pF | ±5%     | GRM32D7U2E333JW31# |                    |
|        |               |         | 39000pF | ±5%     | GRM32D7U2E393JW31# |                    |
|        |               |         | 47000pF | ±5%     | GRM32D7U2E473JW31# |                    |

■ 4.5x2.0mm

| T max. | Rated Voltage | TC Code | Cap.  | Tol.   | Part Number        |
|--------|---------------|---------|-------|--------|--------------------|
| 1.0mm  | 3150Vdc       | C0G     | 5.0pF | ±0.5pF | GRM42A5C3F050DW01# |
|        |               |         | 10pF  | ±5%    | GRM42A5C3F100JW01# |

| T max. | Rated Voltage | TC Code            | Cap.               | Tol.               | Part Number        |                    |
|--------|---------------|--------------------|--------------------|--------------------|--------------------|--------------------|
| 1.0mm  | 3150Vdc       | C0G                | 12pF               | ±5%                | GRM42A5C3F120JW01# |                    |
|        |               |                    | 15pF               | ±5%                | GRM42A5C3F150JW01# |                    |
|        |               |                    | 18pF               | ±5%                | GRM42A5C3F180JW01# |                    |
|        |               |                    | 22pF               | ±5%                | GRM42A5C3F220JW01# |                    |
|        |               |                    | 27pF               | ±5%                | GRM42A5C3F270JW01# |                    |
|        |               |                    | 33pF               | ±5%                | GRM42A5C3F330JW01# |                    |
|        |               |                    | 39pF               | ±5%                | GRM42A5C3F390JW01# |                    |
|        |               |                    | 47pF               | ±5%                | GRM42A5C3F470JW01# |                    |
|        |               |                    | U2J                | 10pF               | ±5%                | GRM42A7U3F100JW31# |
|        |               |                    |                    | 12pF               | ±5%                | GRM42A7U3F120JW31# |
|        | 15pF          | ±5%                |                    | GRM42A7U3F150JW31# |                    |                    |
|        | 18pF          | ±5%                |                    | GRM42A7U3F180JW31# |                    |                    |
|        | 22pF          | ±5%                |                    | GRM42A7U3F220JW31# |                    |                    |
|        | 27pF          | ±5%                |                    | GRM42A7U3F270JW31# |                    |                    |
|        | 33pF          | ±5%                |                    | GRM42A7U3F330JW31# |                    |                    |
|        | 39pF          | ±5%                |                    | GRM42A7U3F390JW31# |                    |                    |
|        | 47pF          | ±5%                |                    | GRM42A7U3F470JW31# |                    |                    |
|        | 56pF          | ±5%                |                    | GRM42A7U3F560JW31# |                    |                    |
|        | 68pF          | ±5%                | GRM42A7U3F680JW31# |                    |                    |                    |
|        | 82pF          | ±5%                | GRM42A7U3F820JW31# |                    |                    |                    |
| 100pF  | ±5%           | GRM42A7U3F101JW31# |                    |                    |                    |                    |

■ 4.5x3.2mm

| T max.  | Rated Voltage | TC Code            | Cap.               | Tol.   | Part Number        |                    |
|---------|---------------|--------------------|--------------------|--------|--------------------|--------------------|
| 1.5mm   | 1000Vdc       | U2J                | 2700pF             | ±5%    | GRM43Q7U3A272JW31# |                    |
|         |               |                    | 3300pF             | ±5%    | GRM43Q7U3A332JW31# |                    |
|         | 630Vdc        | U2J                | 12000pF            | ±5%    | GRM43Q7U2J123JW31# |                    |
|         |               |                    | 500Vdc             | U2J    | 12000pF            | ±5%                |
|         | 2.0mm         | 1000Vdc            | U2J                | 3900pF | ±5%                | GRM43D7U3A392JW31# |
|         |               |                    |                    | 4700pF | ±5%                | GRM43D7U3A472JW31# |
| 630Vdc  |               | U2J                | 15000pF            | ±5%    | GRM43D7U2J153JW31# |                    |
|         |               |                    | 18000pF            | ±5%    | GRM43D7U2J183JW31# |                    |
| 22000pF |               | ±5%                | GRM43D7U2J223JW31# |        |                    |                    |
|         |               |                    | 500Vdc             | U2J    | 15000pF            | ±5%                |
| 18000pF | ±5%           | GRM43D7U2H183JW31# |                    |        |                    |                    |
| 22000pF | ±5%           | GRM43D7U2H223JW31# |                    |        |                    |                    |

■ 5.7x5.0mm

| T max.  | Rated Voltage | TC Code            | Cap.               | Tol.    | Part Number        |                    |
|---------|---------------|--------------------|--------------------|---------|--------------------|--------------------|
| 1.5mm   | 1000Vdc       | U2J                | 5600pF             | ±5%     | GRM55Q7U3A562JW31# |                    |
|         |               |                    | 6800pF             | ±5%     | GRM55Q7U3A682JW31# |                    |
|         | 630Vdc        | U2J                | 27000pF            | ±5%     | GRM55Q7U2J273JW31# |                    |
|         |               |                    | 500Vdc             | U2J     | 27000pF            | ±5%                |
|         | 2.0mm         | 1000Vdc            | U2J                | 8200pF  | ±5%                | GRM55D7U3A822JW31# |
|         |               |                    |                    | 10000pF | ±5%                | GRM55D7U3A103JW31# |
| 630Vdc  |               | U2J                | 33000pF            | ±5%     | GRM55D7U2J333JW31# |                    |
|         |               |                    | 39000pF            | ±5%     | GRM55D7U2J393JW31# |                    |
| 47000pF |               | ±5%                | GRM55D7U2J473JW31# |         |                    |                    |
|         |               |                    | 500Vdc             | U2J     | 33000pF            | ±5%                |
| 39000pF | ±5%           | GRM55D7U2H393JW31# |                    |         |                    |                    |

Part number # indicates the package specification code.

GRM Series  
 GJM Series  
 GMA Series  
 GMD Series  
 GQM Series  
 GRJ Series  
 GR3 Series  
 KRM Series  
 KR3 Series  
 LLA Series  
 LLL Series  
 LLM Series  
 LLR Series  
 ⚠Caution/  
 Notice

⚠Note • Please read rating and ⚠CAUTION (for storage, operating, rating, soldering, mounting and handling) in this catalog to prevent smoking and/or burning, etc.  
 • This catalog has only typical specifications. Therefore, please approve our product specifications or transact the approval sheet for product specifications before ordering.

## GRM Series Temperature Compensating Type Part Number List

(→ ■ 5.7×5.0mm)

| T max. | Rated Voltage | TC Code | Cap.    | Tol. | Part Number               |
|--------|---------------|---------|---------|------|---------------------------|
| 2.0mm  | 500Vdc        | U2J     | 47000pF | ±5%  | <b>GRM55D7U2H473JW31#</b> |

GRM Series

GJM Series

GMA Series

GMD Series

GQM Series

GRJ Series

GR3 Series

KRM Series

KR3 Series

LLA Series

LLL Series

LLM Series

LLR Series

⚠Caution/  
Notice

Part number # indicates the package specification code.

# GRM Series High Dielectric Constant Type Part Number List

■ 0.4x0.2mm **Ultra-compact**

| T max. | Rated Voltage | TC Code            | Cap.   | Tol.               | Part Number        |                 |
|--------|---------------|--------------------|--------|--------------------|--------------------|-----------------|
| 0.22mm | 16Vdc         | X7R                | 100pF  | ±10%               | GRM022R71C101KE14# | <b>Derating</b> |
|        |               |                    |        | ±20%               | GRM022R71C101ME14# | <b>Derating</b> |
|        |               |                    | 150pF  | ±10%               | GRM022R71C151KE14# | <b>Derating</b> |
|        |               |                    |        | ±20%               | GRM022R71C151ME14# | <b>Derating</b> |
|        |               |                    | 220pF  | ±10%               | GRM022R71C221KE14# | <b>Derating</b> |
|        |               |                    |        | ±20%               | GRM022R71C221ME14# | <b>Derating</b> |
|        |               |                    | 330pF  | ±10%               | GRM022R71C331KE14# | <b>Derating</b> |
|        |               |                    |        | ±20%               | GRM022R71C331ME14# | <b>Derating</b> |
|        |               |                    | 470pF  | ±10%               | GRM022R71C471KE14# | <b>Derating</b> |
|        |               |                    |        | ±20%               | GRM022R71C471ME14# | <b>Derating</b> |
|        |               |                    | 1000pF | ±10%               | GRM022R71C102KE14# | <b>Derating</b> |
|        |               |                    |        | ±20%               | GRM022R71C102ME14# | <b>Derating</b> |
|        | 10Vdc         | X7R                | 100pF  | ±10%               | GRM022R71A101KA01# |                 |
|        |               |                    |        | ±20%               | GRM022R71A101MA01# |                 |
|        |               |                    | 150pF  | ±10%               | GRM022R71A151KA01# |                 |
|        |               |                    |        | ±20%               | GRM022R71A151MA01# |                 |
|        |               |                    | 220pF  | ±10%               | GRM022R71A221KA01# |                 |
|        |               |                    |        | ±20%               | GRM022R71A221MA01# |                 |
|        |               |                    | 330pF  | ±10%               | GRM022R71A331KA01# |                 |
|        |               |                    |        | ±20%               | GRM022R71A331MA01# |                 |
|        |               |                    | 470pF  | ±10%               | GRM022R71A471KA01# |                 |
|        |               |                    |        | ±20%               | GRM022R71A471MA01# |                 |
|        |               |                    | 680pF  | ±10%               | GRM022R71A681KA12# |                 |
|        |               |                    |        | ±20%               | GRM022R71A681MA12# |                 |
| 820pF  | ±10%          | GRM022R71A821KA12# |        |                    |                    |                 |
|        | ±20%          | GRM022R71A821MA12# |        |                    |                    |                 |
| 1000pF | ±10%          | GRM022R71A102KA12# |        |                    |                    |                 |
|        | ±20%          | GRM022R71A102MA12# |        |                    |                    |                 |
| X5R    | X5R           | 100pF              | ±10%   | GRM022R61A101KA01# |                    |                 |
|        |               |                    | ±20%   | GRM022R61A101MA01# |                    |                 |
|        |               | 150pF              | ±10%   | GRM022R61A151KA01# |                    |                 |
|        |               |                    | ±20%   | GRM022R61A151MA01# |                    |                 |
|        |               | 220pF              | ±10%   | GRM022R61A221KA01# |                    |                 |
|        |               |                    | ±20%   | GRM022R61A221MA01# |                    |                 |
|        |               | 330pF              | ±10%   | GRM022R61A331KA01# |                    |                 |
|        |               |                    | ±20%   | GRM022R61A331MA01# |                    |                 |
|        |               | 470pF              | ±10%   | GRM022R61A471KA01# |                    |                 |
|        |               |                    | ±20%   | GRM022R61A471MA01# |                    |                 |
|        |               | 680pF              | ±10%   | GRM022R61A681KE19# |                    |                 |
|        |               |                    | ±20%   | GRM022R61A681ME19# |                    |                 |
| 1000pF | ±10%          | GRM022R61A102KE19# |        |                    |                    |                 |
|        | ±20%          | GRM022R61A102ME19# |        |                    |                    |                 |
| 1500pF | ±10%          | GRM022R61A152KE19# |        |                    |                    |                 |
|        | ±20%          | GRM022R61A152ME19# |        |                    |                    |                 |
| 2200pF | ±10%          | GRM022R61A222KE19# |        |                    |                    |                 |
|        | ±20%          | GRM022R61A222ME19# |        |                    |                    |                 |
| 3300pF | ±10%          | GRM022R61A332KE19# |        |                    |                    |                 |
|        | ±20%          | GRM022R61A332ME19# |        |                    |                    |                 |
| 4700pF | ±10%          | GRM022R61A472KE19# |        |                    |                    |                 |
|        | ±20%          | GRM022R61A472ME19# |        |                    |                    |                 |
| 6800pF | ±10%          | GRM022R61A682KE19# |        |                    |                    |                 |
|        | ±20%          | GRM022R61A682ME19# |        |                    |                    |                 |

| T max.  | Rated Voltage | TC Code            | Cap.               | Tol.               | Part Number        |                    |  |
|---------|---------------|--------------------|--------------------|--------------------|--------------------|--------------------|--|
| 0.22mm  | 10Vdc         | X5R                | 1000pF             | ±10%               | GRM022R61A103KE19# |                    |  |
|         |               |                    |                    | ±20%               | GRM022R61A103ME19# |                    |  |
|         |               |                    | B                  | 100pF              | ±10%               | GRM022B11A101KA01# |  |
|         |               |                    |                    |                    | ±20%               | GRM022B11A101MA01# |  |
|         |               |                    | 150pF              | ±10%               | GRM022B11A151KA01# |                    |  |
|         |               |                    |                    | ±20%               | GRM022B11A151MA01# |                    |  |
|         |               |                    | 220pF              | ±10%               | GRM022B11A221KA01# |                    |  |
|         |               |                    |                    | ±20%               | GRM022B11A221MA01# |                    |  |
|         |               |                    | 330pF              | ±10%               | GRM022B11A331KA01# |                    |  |
|         |               |                    |                    | ±20%               | GRM022B11A331MA01# |                    |  |
|         |               |                    | 470pF              | ±10%               | GRM022B11A471KA01# |                    |  |
|         |               |                    |                    | ±20%               | GRM022B11A471MA01# |                    |  |
|         | 680pF         | ±10%               | GRM022B31A681KE19# |                    |                    |                    |  |
|         |               | ±20%               | GRM022B31A681ME19# |                    |                    |                    |  |
|         | 1000pF        | ±10%               | GRM022B31A102KE19# |                    |                    |                    |  |
|         |               | ±20%               | GRM022B31A102ME19# |                    |                    |                    |  |
|         | 1500pF        | ±10%               | GRM022B31A152KE19# |                    |                    |                    |  |
|         |               | ±20%               | GRM022B31A152ME19# |                    |                    |                    |  |
|         | 2200pF        | ±10%               | GRM022B31A222KE19# |                    |                    |                    |  |
|         |               | ±20%               | GRM022B31A222ME19# |                    |                    |                    |  |
|         | 3300pF        | ±10%               | GRM022B31A332KE19# |                    |                    |                    |  |
|         |               | ±20%               | GRM022B31A332ME19# |                    |                    |                    |  |
|         | 4700pF        | ±10%               | GRM022B31A472KE19# |                    |                    |                    |  |
|         |               | ±20%               | GRM022B31A472ME19# |                    |                    |                    |  |
| 6800pF  | ±10%          | GRM022B31A682KE19# |                    |                    |                    |                    |  |
|         | ±20%          | GRM022B31A682ME19# |                    |                    |                    |                    |  |
| 10000pF | ±10%          | GRM022B31A103KE19# |                    |                    |                    |                    |  |
|         | ±20%          | GRM022B31A103ME19# |                    |                    |                    |                    |  |
| 6.3Vdc  | X5R           | 1000pF             | ±20%               | GRM022R60J102ME19# |                    |                    |  |
|         |               |                    | ±20%               | GRM022R60J152ME19# |                    |                    |  |
|         |               | 2200pF             | ±20%               | GRM022R60J222ME19# |                    |                    |  |
|         |               |                    | ±20%               | GRM022R60J332ME19# |                    |                    |  |
|         |               | 3300pF             | ±20%               | GRM022R60J472ME19# |                    |                    |  |
|         |               |                    | ±20%               | GRM022R60J682ME19# |                    |                    |  |
|         |               | 4700pF             | ±20%               | GRM022R60J103ME19# |                    |                    |  |
|         |               |                    | ±20%               | GRM022R60J153ME15# | <b>Derating</b>    |                    |  |
|         |               | 22000pF            | ±10%               | GRM022R60J223KE15# | <b>Derating</b>    |                    |  |
|         |               |                    | ±20%               | GRM022R60J223ME15# | <b>Derating</b>    |                    |  |
|         |               | 33000pF            | ±20%               | GRM022R60J333ME15# | <b>Derating</b>    |                    |  |
|         |               |                    | ±20%               | GRM022R60J473ME15# | <b>Derating</b>    |                    |  |
| 47000pF | ±20%          | GRM022R60J683ME15# | <b>Derating</b>    |                    |                    |                    |  |
|         | ±20%          | GRM022R60J104ME15# | <b>Derating</b>    |                    |                    |                    |  |
| 4Vdc    | X6T           | 0.10μF             | ±20%               | GRM022D80G104ME15# | <b>Derating</b>    |                    |  |
|         |               |                    | ±20%               | GRM022R60G153KE15# |                    |                    |  |
|         |               | X5R                | 15000pF            | ±10%               | GRM022R60G153ME15# |                    |  |
|         |               |                    |                    | ±20%               | GRM022R60G153ME15# |                    |  |
|         |               | 22000pF            | ±10%               | GRM022R60G223KE15# |                    |                    |  |
|         |               |                    | ±20%               | GRM022R60G223ME15# |                    |                    |  |

Part number # indicates the package specification code.

## GRM Series High Dielectric Constant Type Part Number List

(→ ■ 0.4x0.2mm)

| T max. | Rated Voltage | TC Code | Cap.    | Tol.   | Part Number        |                    |
|--------|---------------|---------|---------|--------|--------------------|--------------------|
| 0.22mm | 4Vdc          | X5R     | 33000pF | ±10%   | GRM022R60G333KE15# |                    |
|        |               |         |         | ±20%   | GRM022R60G333ME15# |                    |
|        |               |         | 47000pF | ±10%   | GRM022R60G473KE15# |                    |
|        |               |         |         | ±20%   | GRM022R60G473ME15# |                    |
|        |               |         | 68000pF | ±20%   | GRM022R60G683ME15# |                    |
|        |               |         |         | 0.10μF | ±20%               | GRM022R60G104ME15# |
|        | 2.5Vdc        | X6T     | 0.10μF  | ±20%   | GRM022D80E104ME15# |                    |

■ 0.6x0.3mm Ultra-compact

| T max. | Rated Voltage | TC Code | Cap.   | Tol.  | Part Number        |                    |  |  |  |
|--------|---------------|---------|--------|-------|--------------------|--------------------|--|--|--|
| 0.33mm | 50Vdc         | X7R     | 100pF  | ±10%  | GRM033R71H101KA12# |                    |  |  |  |
|        |               |         |        | ±20%  | GRM033R71H101MA12# |                    |  |  |  |
|        |               |         | 150pF  | ±10%  | GRM033R71H151KA12# |                    |  |  |  |
|        |               |         |        | ±20%  | GRM033R71H151MA12# |                    |  |  |  |
|        |               |         | 220pF  | ±10%  | GRM033R71H221KA12# |                    |  |  |  |
|        |               |         |        | ±20%  | GRM033R71H221MA12# |                    |  |  |  |
|        |               |         | 330pF  | ±10%  | GRM033R71H331KA12# |                    |  |  |  |
|        |               |         |        | ±20%  | GRM033R71H331MA12# |                    |  |  |  |
|        |               |         | 470pF  | ±10%  | GRM033R71H471KA12# |                    |  |  |  |
|        |               |         |        | ±20%  | GRM033R71H471MA12# |                    |  |  |  |
|        |               |         | 680pF  | ±10%  | GRM033R71H681KA12# |                    |  |  |  |
|        |               |         |        | ±20%  | GRM033R71H681MA12# |                    |  |  |  |
|        |               |         | 1000pF | ±10%  | GRM033R71H102KA12# |                    |  |  |  |
|        |               |         |        | ±20%  | GRM033R71H102MA12# |                    |  |  |  |
|        |               |         | 1500pF | ±10%  | GRM033R71H152KA12# |                    |  |  |  |
|        |               |         |        | ±20%  | GRM033R71H152MA12# |                    |  |  |  |
|        |               |         | B      | 100pF | ±10%               | GRM033B31H101KA12# |  |  |  |
|        |               |         |        |       | ±20%               | GRM033B31H101MA12# |  |  |  |
|        |               |         |        | 150pF | ±10%               | GRM033B31H151KA12# |  |  |  |
|        |               |         |        |       | ±20%               | GRM033B31H151MA12# |  |  |  |
|        |               |         |        | 220pF | ±10%               | GRM033B31H221KA12# |  |  |  |
|        |               |         |        |       | ±20%               | GRM033B31H221MA12# |  |  |  |
|        |               |         |        | 330pF | ±10%               | GRM033B31H331KA12# |  |  |  |
|        |               |         |        |       | ±20%               | GRM033B31H331MA12# |  |  |  |
|        |               |         |        | 470pF | ±10%               | GRM033B31H471KA12# |  |  |  |
|        |               |         |        |       | ±20%               | GRM033B31H471MA12# |  |  |  |
|        |               |         |        | 680pF | ±10%               | GRM033B31H681KA12# |  |  |  |
|        |               |         |        |       | ±20%               | GRM033B31H681MA12# |  |  |  |
|        |               |         | 1000pF | ±10%  | GRM033B31H102KA12# |                    |  |  |  |
|        |               |         |        | ±20%  | GRM033B31H102MA12# |                    |  |  |  |
|        |               |         | 1500pF | ±10%  | GRM033B31H152KA12# |                    |  |  |  |
|        |               |         |        | ±20%  | GRM033B31H152MA12# |                    |  |  |  |
|        |               |         | 35Vdc  | X5R   | 0.10μF             | ±10%               | GRM033R6YA104KE14#   | <span style="border: 1px solid black; padding: 1px;">Derating</span> |  |
|        |               |         |        |       |                    | ±20%               | GRM033R6YA104ME14#   | <span style="border: 1px solid black; padding: 1px;">Derating</span> |  |
|        |               |         |        | 25Vdc | X7R                | 1000pF             | ±10%   | GRM033R71E102KA01#   |  |
|        |               |         |        |       |                    | 1500pF             | ±10%   | GRM033R71E152KA01#   |  |
|        |               |         | 2200pF | ±10%  |                    | GRM033R71E222KA12# |  |  |  |
|        |               |         |        | ±20%  |                    | GRM033R71E222MA12# |  |  |  |
|        |               |         | 3300pF | ±10%  |                    | GRM033R71E332KA12# |  |  |  |
|        |               |         |        | ±20%  |                    | GRM033R71E332MA12# |  |  |  |
|        |               |         | 4700pF | ±10%  |                    | GRM033R71E472KE14# | <span style="border: 1px solid black; padding: 1px;">Derating</span> |  |  |
|        |               |         |        | ±20%  |                    | GRM033R71E472ME14# | <span style="border: 1px solid black; padding: 1px;">Derating</span> |  |  |

| T max.  | Rated Voltage | TC Code            | Cap.   | Tol.               | Part Number  |  |  |
|---------|---------------|--------------------|--|--------------------|--|--|--|
| 0.33mm  | 25Vdc         | X7R                | 6800pF   | ±10%               | GRM033R71E682KE14#   | <span style="border: 1px solid black; padding: 1px;">Derating</span> |  |
|         |               |                    |  | ±20%               | GRM033R71E682ME14#   | <span style="border: 1px solid black; padding: 1px;">Derating</span> |  |
|         |               |                    | 10000pF  | ±10%               | GRM033R71E103KE14#   | <span style="border: 1px solid black; padding: 1px;">Derating</span> |  |
|         |               |                    |  | ±20%               | GRM033R71E103ME14#   | <span style="border: 1px solid black; padding: 1px;">Derating</span> |  |
|         |               |                    | R  | 100pF              | ±10%   | GRM033R11E101KA01#   |  |
|         |               |                    |  | 150pF              | ±10%   | GRM033R11E151KA01#   |  |
|         |               |                    |  | 220pF              | ±10%   | GRM033R11E221KA01#   |  |
|         |               |                    |  | 330pF              | ±10%   | GRM033R11E331KA01#   |  |
|         |               |                    |  | 470pF              | ±10%   | GRM033R11E471KA01#   |  |
|         |               |                    |  | 680pF              | ±10%   | GRM033R11E681KA01#   |  |
|         |               |                    | 1000pF   | ±10%               | GRM033R11E102KA01#   |  |  |
|         |               |                    | 1500pF   | ±10%               | GRM033R11E152KA01#   |  |  |
|         |               | X6S                | 0.10μF   | ±10%               | GRM033C81E104KE14#   | <span style="border: 1px solid black; padding: 1px;">Derating</span> |  |
|         |               |                    |  | ±20%               | GRM033C81E104ME14#   | <span style="border: 1px solid black; padding: 1px;">Derating</span> |  |
|         |               |                    | X5R  | 4700pF             | ±10%   | GRM033R61E472KA12#   | <span style="border: 1px solid black; padding: 1px;">Derating</span> |
|         |               |                    |  |                    | ±20%   | GRM033R61E472MA12#   | <span style="border: 1px solid black; padding: 1px;">Derating</span> |
|         |               |                    |  | 6800pF             | ±10%   | GRM033R61E682KA12#   | <span style="border: 1px solid black; padding: 1px;">Derating</span> |
|         |               |                    |  |                    | ±20%   | GRM033R61E682MA12#   | <span style="border: 1px solid black; padding: 1px;">Derating</span> |
|         |               | 10000pF            | ±10%   | GRM033R61E103KA12# | <span style="border: 1px solid black; padding: 1px;">Derating</span> |  |  |
|         |               |                    | ±20%   | GRM033R61E103MA12# | <span style="border: 1px solid black; padding: 1px;">Derating</span> |  |  |
|         |               | B                  | 1000pF   | ±10%               | GRM033B11E102KA01#   |  |  |
|         |               |                    |  | ±20%               | GRM033B11E102MA01#   |  |  |
|         |               |                    | 1500pF   | ±10%               | GRM033B11E152KA01#   |  |  |
|         |               |                    |  | ±20%               | GRM033B11E152MA01#   |  |  |
|         |               |                    | 2200pF   | ±10%               | GRM033B31E222KA12#   |  |  |
|         |               |                    |  | ±20%               | GRM033B31E222MA12#   |  |  |
|         |               | 3300pF             | ±10%   | GRM033B31E332KA12# |  |  |  |
|         |               |                    | ±20%   | GRM033B31E332MA12# |  |  |  |
|         |               | X7R                | 10000pF  | ±10%               | GRM033B31E103KA12#   | <span style="border: 1px solid black; padding: 1px;">Derating</span> |  |
|         |               |                    |  | ±20%               | GRM033B31E103MA12#   | <span style="border: 1px solid black; padding: 1px;">Derating</span> |  |
|         |               |                    | 16Vdc  | 2200pF             | ±10%   | GRM033R71C222KA88#   |  |
|         |               |                    |  |                    | ±20%   | GRM033R71C222MA88#   |  |
|         |               |                    |  | 3300pF             | ±10%   | GRM033R71C332KA88#   |  |
|         |               |                    |  |                    | ±20%   | GRM033R71C332MA88#   |  |
|         |               | 4700pF             | ±10%   | GRM033R71C472KE14# |  |  |  |
|         |               |                    | ±20%   | GRM033R71C472ME14# |  |  |  |
|         | X7S           | 6800pF             | ±10%   | GRM033R71C682KE14# |  |  |  |
|         |               |                    | ±20%   | GRM033R71C682ME14# |  |  |  |
|         |               | 10000pF            | ±10%   | GRM033R71C103KE14# |  |  |  |
|         |               |                    | ±20%   | GRM033R71C103ME14# |  |  |  |
|         |               | 0.10μF             | ±10%   | GRM033C71C104KE14# | <span style="border: 1px solid black; padding: 1px;">Derating</span> |  |  |
|         |               |                    | ±20%   | GRM033C71C104ME14# | <span style="border: 1px solid black; padding: 1px;">Derating</span> |  |  |
|         | R             | 2200pF             | ±10%   | GRM033R11C222KA88# |  |  |  |
|         |               |                    | ±20%   | GRM033R11C222MA88# |  |  |  |
|         |               | 3300pF             | ±10%   | GRM033R11C332KA88# |  |  |  |
|         |               |                    | ±20%   | GRM033R11C332MA88# |  |  |  |
|         | X6S           | 0.10μF             | ±10%   | GRM033C81C104KE14# |  |  |  |
|         |               |                    | ±20%   | GRM033C81C104ME14# |  |  |  |
| X5R     |               | 10000pF            | ±10%   | GRM033R61C103KA12# |  |  |  |
|         |               |                    | ±20%   | GRM033R61C103MA12# |  |  |  |
|         |               | 15000pF            | ±10%   | GRM033R61C153KE84# | <span style="border: 1px solid black; padding: 1px;">Derating</span> |  |  |
|         |               |                    | ±20%   | GRM033R61C153ME84# | <span style="border: 1px solid black; padding: 1px;">Derating</span> |  |  |
| 22000pF | ±10%          | GRM033R61C223KE84# | <span style="border: 1px solid black; padding: 1px;">Derating</span> |                    |  |  |  |
|         | ±20%          | GRM033R61C223ME84# | <span style="border: 1px solid black; padding: 1px;">Derating</span> |                    |  |  |  |
| 33000pF | ±10%          | GRM033R61C333KE84# | <span style="border: 1px solid black; padding: 1px;">Derating</span> |                    |  |  |  |
|         | ±20%          | GRM033R61C333ME84# | <span style="border: 1px solid black; padding: 1px;">Derating</span> |                    |  |  |  |

Part number # indicates the package specification code.

GRM Series  
GJM Series  
GMA Series  
GMD Series  
GQM Series  
GRJ Series  
GR3 Series  
KRM Series  
KR3 Series  
LLA Series  
LLL Series  
LLM Series  
LLR Series  
⚠Caution/Notice

# GRM Series High Dielectric Constant Type Part Number List

(→ ■ 0.6x0.3mm)

| T max.  | Rated Voltage | TC Code            | Cap.               | Tol.               | Part Number        |                    |  |
|---------|---------------|--------------------|--------------------|--------------------|--------------------|--------------------|--|
| 0.33mm  | 16Vdc         | X5R                | 47000pF            | ±10%               | GRM033R61C473KE84# |                    |  |
|         |               |                    |                    | ±20%               | GRM033R61C473ME84# |                    |  |
|         |               |                    | 68000pF            | ±10%               | GRM033R61C683KE84# |                    |  |
|         |               |                    |                    | ±20%               | GRM033R61C683ME84# |                    |  |
|         |               |                    | 0.10µF             | ±10%               | GRM033R61C104KE14# |                    |  |
|         |               |                    |                    | ±20%               | GRM033R61C104ME14# |                    |  |
|         |               |                    | B                  | 2200pF             | ±10%               | GRM033B31C222KA87# |  |
|         |               |                    |                    |                    | ±20%               | GRM033B31C222MA87# |  |
|         |               |                    |                    | 3300pF             | ±10%               | GRM033B31C332KA87# |  |
|         |               |                    |                    |                    | ±20%               | GRM033B31C332MA87# |  |
|         |               |                    |                    | 10000pF            | ±10%               | GRM033B31C103KA12# |  |
|         |               |                    |                    |                    | ±20%               | GRM033B31C103MA12# |  |
|         |               | 15000pF            |                    | ±10%               | GRM033B31C153KE84# |                    |  |
|         |               |                    |                    | ±20%               | GRM033B31C153ME84# |                    |  |
|         |               | 22000pF            |                    | ±10%               | GRM033B31C223KE84# |                    |  |
|         |               |                    |                    | ±20%               | GRM033B31C223ME84# |                    |  |
|         |               | 33000pF            |                    | ±10%               | GRM033B31C333KE84# |                    |  |
|         |               |                    |                    | ±20%               | GRM033B31C333ME84# |                    |  |
|         |               | 47000pF            | ±10%               | GRM033B31C473KE84# |                    |                    |  |
|         |               |                    | ±20%               | GRM033B31C473ME84# |                    |                    |  |
|         |               | 68000pF            | ±10%               | GRM033B31C683KE84# |                    |                    |  |
|         |               |                    | ±20%               | GRM033B31C683ME84# |                    |                    |  |
|         |               | 0.10µF             | ±10%               | GRM033B31C104KE84# |                    |                    |  |
|         |               |                    | ±20%               | GRM033B31C104ME84# |                    |                    |  |
|         | 10Vdc         | X7R                | 4700pF             | ±10%               | GRM033R71A472KA01# |                    |  |
|         |               |                    |                    | ±20%               | GRM033R71A472MA01# |                    |  |
|         |               |                    | 6800pF             | ±10%               | GRM033R71A682KA01# |                    |  |
|         |               |                    |                    | ±20%               | GRM033R71A682MA01# |                    |  |
|         |               |                    | 10000pF            | ±10%               | GRM033R71A103KA01# |                    |  |
|         |               |                    |                    | ±20%               | GRM033R71A103MA01# |                    |  |
|         |               |                    | X7S                | 0.10µF             | ±10%               | GRM033C71A104KE14# |  |
|         |               |                    |                    |                    | ±20%               | GRM033C71A104ME14# |  |
|         |               |                    | R                  | 4700pF             | ±10%               | GRM033R11A472KA01# |  |
|         |               |                    |                    |                    | ±20%               | GRM033R11A472MA01# |  |
|         |               |                    |                    | 6800pF             | ±10%               | GRM033R11A682KA01# |  |
|         |               |                    |                    |                    | ±20%               | GRM033R11A682MA01# |  |
|         |               | 10000pF            | ±10%               | GRM033R11A103KA01# |                    |                    |  |
|         |               |                    | ±20%               | GRM033R11A103MA01# |                    |                    |  |
|         |               | X5R                | 4700pF             | ±10%               | GRM033R61A472KA01# |                    |  |
|         |               |                    |                    | ±20%               | GRM033R61A472MA01# |                    |  |
|         |               |                    | 6800pF             | ±10%               | GRM033R61A682KA01# |                    |  |
|         |               |                    |                    | ±20%               | GRM033R61A682MA01# |                    |  |
|         |               |                    | 15000pF            | ±10%               | GRM033R61A153KE84# |                    |  |
|         |               |                    |                    | ±20%               | GRM033R61A153ME84# |                    |  |
|         |               |                    | 22000pF            | ±10%               | GRM033R61A223KE84# |                    |  |
|         |               |                    |                    | ±20%               | GRM033R61A223ME84# |                    |  |
|         |               |                    | 33000pF            | ±10%               | GRM033R61A333KE84# |                    |  |
|         |               |                    |                    | ±20%               | GRM033R61A333ME84# |                    |  |
| 47000pF | ±10%          |                    | GRM033R61A473KE84# |                    |                    |                    |  |
|         | ±20%          |                    | GRM033R61A473ME84# |                    |                    |                    |  |
| 68000pF | ±10%          | GRM033R61A683KE84# |                    |                    |                    |                    |  |
|         | ±20%          | GRM033R61A683ME84# |                    |                    |                    |                    |  |
| 0.10µF  | ±10%          | GRM033R61A104KE84# |                    |                    |                    |                    |  |
|         | ±20%          | GRM033R61A104ME84# |                    |                    |                    |                    |  |

| T max.  | Rated Voltage | TC Code | Cap.               | Tol.               | Part Number        |                    |                    |
|---------|---------------|---------|--------------------|--------------------|--------------------|--------------------|--------------------|
| 0.33mm  | 10Vdc         | X5R     | 0.22µF             | ±20%               | GRM033R61A224ME90# |                    |                    |
|         |               |         |                    | B                  | 4700pF             | ±10%               | GRM033B11A472KA01# |
|         |               |         | ±20%               |                    |                    | GRM033B11A472MA01# |                    |
|         |               |         | 6800pF             | ±10%               | GRM033B11A682KA01# |                    |                    |
|         |               |         |                    | ±20%               | GRM033B11A682MA01# |                    |                    |
|         |               |         | 15000pF            | ±10%               | GRM033B31A153KE84# |                    |                    |
|         |               |         |                    | ±20%               | GRM033B31A153ME84# |                    |                    |
|         |               |         | 22000pF            | ±10%               | GRM033B31A223KE84# |                    |                    |
|         |               |         |                    | ±20%               | GRM033B31A223ME84# |                    |                    |
|         |               |         | 33000pF            | ±10%               | GRM033B31A333KE84# |                    |                    |
|         |               |         |                    | ±20%               | GRM033B31A333ME84# |                    |                    |
|         |               |         | 47000pF            | ±10%               | GRM033B31A473KE84# |                    |                    |
|         |               | ±20%    |                    | GRM033B31A473ME84# |                    |                    |                    |
|         |               | 68000pF | ±10%               | GRM033B31A683KE84# |                    |                    |                    |
|         |               |         | ±20%               | GRM033B31A683ME84# |                    |                    |                    |
|         |               | 0.10µF  | ±10%               | GRM033B31A104KE84# |                    |                    |                    |
|         |               |         | ±20%               | GRM033B31A104ME84# |                    |                    |                    |
|         |               | 6.3Vdc  | X7R                | 4700pF             | ±10%               | GRM033R70J472KA01# |                    |
|         |               |         |                    |                    | ±20%               | GRM033R70J472MA01# |                    |
|         |               |         |                    | 6800pF             | ±10%               | GRM033R70J682KA01# |                    |
|         |               |         |                    |                    | ±20%               | GRM033R70J682MA01# |                    |
|         |               |         | 10000pF            | ±10%               | GRM033R70J103KA01# |                    |                    |
|         |               |         |                    | ±20%               | GRM033R70J103MA01# |                    |                    |
|         |               |         | R                  | 4700pF             | ±10%               | GRM033R10J472KA01# |                    |
|         | ±20%          |         |                    |                    | GRM033R10J472MA01# |                    |                    |
|         | 6800pF        |         |                    | ±10%               | GRM033R10J682KA01# |                    |                    |
|         |               |         |                    | ±20%               | GRM033R10J682MA01# |                    |                    |
|         | 10000pF       |         | ±10%               | GRM033R10J103KA01# |                    |                    |                    |
|         |               |         | ±20%               | GRM033R10J103MA01# |                    |                    |                    |
|         | X6S           | 15000pF | ±10%               | GRM033C80J153KE01# |                    |                    |                    |
|         |               |         | ±20%               | GRM033C80J153ME01# |                    |                    |                    |
|         |               | 22000pF | ±10%               | GRM033C80J223KE01# |                    |                    |                    |
|         |               |         | ±20%               | GRM033C80J223ME01# |                    |                    |                    |
|         |               | 33000pF | ±10%               | GRM033C80J333KE01# |                    |                    |                    |
|         |               |         | ±20%               | GRM033C80J333ME01# |                    |                    |                    |
|         |               | 47000pF | ±10%               | GRM033C80J473KE19# |                    |                    |                    |
|         |               |         | ±20%               | GRM033C80J473ME19# |                    |                    |                    |
|         | 68000pF       | ±10%    | GRM033C80J683KE84# |                    |                    |                    |                    |
|         | 0.10µF        | ±10%    | GRM033C80J104KE84# |                    |                    |                    |                    |
|         |               | ±20%    | GRM033C80J104ME84# |                    |                    |                    |                    |
|         | 0.22µF        | ±20%    | GRM033C80J224ME90# |                    |                    |                    |                    |
|         | 4Vdc          | X5R     | 0.22µF             | ±20%               | GRM033R60J224ME90# |                    |                    |
|         |               |         |                    | B                  | 4700pF             | ±10%               | GRM033B10J472KA01# |
|         |               |         | ±20%               |                    |                    | GRM033B10J472MA01# |                    |
|         |               |         | 6800pF             | ±10%               | GRM033B10J682KA01# |                    |                    |
|         |               | ±20%    |                    | GRM033B10J682MA01# |                    |                    |                    |
|         |               | 15000pF | ±10%               | GRM033B10J153KE01# |                    |                    |                    |
|         |               |         | ±20%               | GRM033B10J153ME01# |                    |                    |                    |
| 22000pF |               | ±10%    | GRM033B10J223KE01# |                    |                    |                    |                    |
|         |               | ±20%    | GRM033B10J223ME01# |                    |                    |                    |                    |
| 33000pF |               | ±10%    | GRM033B10J333KE01# |                    |                    |                    |                    |
|         |               | ±20%    | GRM033B10J333ME01# |                    |                    |                    |                    |
| X6S     |               | 0.22µF  | ±20%               | GRM033C80G224ME90# |                    |                    |                    |

■ 1.0x0.5mm

| T max. | Rated Voltage | TC Code | Cap.   | Tol. | Part Number        |  |
|--------|---------------|---------|--------|------|--------------------|--|
| 0.22mm | 10Vdc         | X5R     | 0.10µF | ±10% | GRM152R61A104KE19# |  |
|        |               |         |        | ±20% | GRM152R61A104ME19# |  |
|        |               |         | 0.22µF | ±10% | GRM152R61A224KE19# |  |

Part number # indicates the package specification code.

## GRM Series High Dielectric Constant Type Part Number List

(→ ■ 1.0x0.5mm)

| T max. | Rated Voltage | TC Code | Cap.               | Tol.               | Part Number        |                    |                    |
|--------|---------------|---------|--------------------|--------------------|--------------------|--------------------|--------------------|
| 0.22mm | 10Vdc         | X5R     | 0.22μF             | ±20%               | GRM152R61A224ME19# |                    |                    |
|        |               |         | B                  | 0.10μF             | ±10%               | GRM152B31A104KE19# |                    |
|        |               |         |                    |                    | ±20%               | GRM152B31A104ME19# |                    |
|        |               |         |                    | 0.22μF             | ±10%               | GRM152B31A224KE19# |                    |
|        |               |         |                    | ±20%               | GRM152B31A224ME19# |                    |                    |
|        |               |         | 6.3Vdc             | X6S                | 0.10μF             | ±10%               | GRM152C80J104KE19# |
|        |               |         |                    |                    | ±20%               | GRM152C80J104ME19# |                    |
|        |               | 0.22μF  |                    |                    | ±10%               | GRM152C80J224KE19# |                    |
|        |               |         |                    | ±20%               | GRM152C80J224ME19# |                    |                    |
|        |               | X5R     |                    | 0.10μF             | ±10%               | GRM152R60J104KE19# |                    |
|        |               |         |                    |                    | ±20%               | GRM152R60J104ME19# |                    |
|        |               |         | 0.22μF             | ±10%               | GRM152R60J224KE19# |                    |                    |
|        |               |         | ±20%               | GRM152R60J224ME19# |                    |                    |                    |
|        | 0.47μF        |         | ±20%               | GRM152R60J474ME15# |                    |                    |                    |
|        | 1.0μF         |         | ±20%               | GRM152R60J105ME15# |                    |                    |                    |
|        | 4Vdc          | X7T     | 0.10μF             | ±10%               | GRM152D70G104KE15# |                    |                    |
|        |               |         |                    | ±20%               | GRM152D70G104ME15# |                    |                    |
|        |               |         | 0.22μF             | ±10%               | GRM152D70G224KE15# |                    |                    |
|        |               |         |                    | ±20%               | GRM152D70G224ME15# |                    |                    |
|        |               |         | X6S                | 0.10μF             | ±10%               | GRM152C80G104KE19# |                    |
|        |               |         |                    |                    | ±20%               | GRM152C80G104ME19# |                    |
|        |               | 0.22μF  |                    | ±10%               | GRM152C80G224KE19# |                    |                    |
|        |               |         | ±20%               | GRM152C80G224ME19# |                    |                    |                    |
|        |               | X6T     | 0.47μF             | ±20%               | GRM152D80G474ME15# |                    |                    |
|        |               |         | 1.0μF              | ±20%               | GRM152D80G105ME15# |                    |                    |
|        |               | 2.5Vdc  | X5R                | 1.0μF              | ±20%               | GRM152R60G105ME15# |                    |
|        |               |         |                    | X7T                | 0.10μF             | ±10%               | GRM152D70E104KE19# |
|        |               |         |                    |                    | ±20%               | GRM152D70E104ME19# |                    |
|        | 0.22μF        |         |                    |                    | ±10%               | GRM152D70E224KE19# |                    |
|        |               |         |                    | ±20%               | GRM152D70E224ME19# |                    |                    |
|        | 0.3mm         |         |                    | 50Vdc              | X7R                | 220pF              | ±10%               |
|        |               | 330pF   | ±10%               |                    |                    | GRM15XR71H331KA86# |                    |
|        |               | 470pF   | ±10%               |                    |                    | GRM15XR71H471KA86# |                    |
|        |               | 680pF   | ±10%               |                    |                    | GRM15XR71H681KA86# |                    |
|        |               | 1000pF  | ±10%               |                    |                    | GRM15XR71H102KA86# |                    |
|        |               | 1500pF  | ±10%               |                    |                    | GRM15XR71H152KA86# |                    |
| R      |               | 220pF   | ±10%               |                    | GRM15XR11H221KA86# |                    |                    |
|        |               | 330pF   | ±10%               |                    | GRM15XR11H331KA86# |                    |                    |
|        |               | 470pF   | ±10%               |                    | GRM15XR11H471KA86# |                    |                    |
|        |               | 680pF   | ±10%               |                    | GRM15XR11H681KA86# |                    |                    |
|        |               | 1000pF  | ±10%               |                    | GRM15XR11H102KA86# |                    |                    |
|        |               | 1500pF  | ±10%               |                    | GRM15XR11H152KA86# |                    |                    |
| B      |               | 220pF   | ±10%               | GRM15XB11H221KA86# |                    |                    |                    |
|        |               |         | ±20%               | GRM15XB11H221MA86# |                    |                    |                    |
|        |               | 330pF   | ±10%               | GRM15XB11H331KA86# |                    |                    |                    |
|        |               |         | ±20%               | GRM15XB11H331MA86# |                    |                    |                    |
|        |               | 470pF   | ±10%               | GRM15XB11H471KA86# |                    |                    |                    |
|        |               |         | ±20%               | GRM15XB11H471MA86# |                    |                    |                    |
|        |               | ±10%    | GRM15XB11H681KA86# |                    |                    |                    |                    |

| T max. | Rated Voltage | TC Code | Cap.               | Tol.               | Part Number        |                    |                    |                    |  |
|--------|---------------|---------|--------------------|--------------------|--------------------|--------------------|--------------------|--------------------|--|
| 0.3mm  | 50Vdc         | B       | 680pF              | ±20%               | GRM15XB11H681MA86# |                    |                    |                    |  |
|        |               |         | 1000pF             | ±10%               | GRM15XB11H102KA86# |                    |                    |                    |  |
|        |               |         |                    | ±20%               | GRM15XB11H102MA86# |                    |                    |                    |  |
|        |               |         | 1500pF             | ±10%               | GRM15XB11H152KA86# |                    |                    |                    |  |
|        |               |         |                    | ±20%               | GRM15XB11H152MA86# |                    |                    |                    |  |
|        |               |         | 25Vdc              | X7R                | 2200pF             | ±10%               | GRM15XR71E222KA86# |                    |  |
|        |               |         |                    |                    | ±20%               | GRM15XR71E222MA86# |                    |                    |  |
|        |               | B       |                    |                    | 2200pF             | ±10%               | GRM15XB11E222KA86# |                    |  |
|        |               |         |                    | ±20%               | GRM15XB11E222MA86# |                    |                    |                    |  |
|        |               | 16Vdc   |                    | X7R                | 3300pF             | ±10%               | GRM15XR71C332KA86# |                    |  |
|        |               |         |                    |                    |                    | ±20%               | GRM15XR71C332MA86# |                    |  |
|        |               |         | 4700pF             |                    | ±10%               | GRM15XR71C472KA86# |                    |                    |  |
|        |               |         | ±20%               | GRM15XR71C472MA86# |                    |                    |                    |                    |  |
|        | 6800pF        |         | ±10%               | GRM15XR71C682KA86# |                    |                    |                    |                    |  |
|        |               |         | ±20%               | GRM15XR71C682MA86# |                    |                    |                    |                    |  |
|        | 10Vdc         | X5R     | 15000pF            | ±10%               | GRM15XR61A153KA86# |                    |                    |                    |  |
|        |               |         |                    | ±20%               | GRM15XR61A153MA86# |                    |                    |                    |  |
|        |               |         | 22000pF            | ±10%               | GRM15XR61A223KA86# |                    |                    |                    |  |
|        |               |         | ±20%               | GRM15XR61A223MA86# |                    |                    |                    |                    |  |
|        |               | 33000pF | ±10%               | GRM15XR61A333KA86# |                    |                    |                    |                    |  |
|        |               |         | ±20%               | GRM15XR61A333MA86# |                    |                    |                    |                    |  |
|        | 0.33mm        | 10Vdc   | X5R                | 1.0μF              | ±20%               | GRM153R61A105ME95# |                    |                    |  |
|        |               |         |                    |                    | ±20%               | GRM153B31A105ME95# |                    |                    |  |
|        |               |         |                    | B                  | 1.0μF              | ±20%               | GRM153D80J105ME95# |                    |  |
|        |               |         | 6.3Vdc             | X6T                | 1.0μF              | ±20%               | GRM153R60J105ME95# |                    |  |
|        |               |         |                    |                    | X5R                | 1.0μF              | ±20%               | GRM153R60J105ME95# |  |
|        |               |         |                    |                    | B                  | 1.0μF              | ±20%               | GRM153B30J105ME95# |  |
|        |               | 4Vdc    | X6T                | 1.0μF              | ±20%               | GRM153D80G105ME95# |                    |                    |  |
|        |               | 0.55mm  | 100Vdc             | X7R                | 220pF              | ±10%               | GRM155R72A221KA01# |                    |  |
|        |               |         |                    |                    | 330pF              | ±10%               | GRM155R72A331KA01# |                    |  |
|        |               |         |                    |                    | 470pF              | ±10%               | GRM155R72A471KA01# |                    |  |
|        |               |         |                    |                    | 680pF              | ±10%               | GRM155R72A681KA01# |                    |  |
|        |               |         |                    |                    | 1000pF             | ±10%               | GRM155R72A102KA01# |                    |  |
|        | 1500pF        |         |                    |                    | ±10%               | GRM155R72A152KA01# |                    |                    |  |
|        | R             |         |                    | 220pF              | ±10%               | GRM155R72A222KA01# |                    |                    |  |
|        |               |         |                    | 330pF              | ±10%               | GRM155R72A332KA01# |                    |                    |  |
| 470pF  |               |         |                    | ±10%               | GRM155R72A472KA01# |                    |                    |                    |  |
| 680pF  |               |         |                    | ±10%               | GRM155R71H221KA01# |                    |                    |                    |  |
| 1000pF |               |         |                    | ±10%               | GRM155R71H331KA01# |                    |                    |                    |  |
| 1500pF |               |         |                    | ±10%               | GRM155R71H471KA01# |                    |                    |                    |  |
| 50Vdc  | X7R           |         | 220pF              | ±10%               | GRM155R71H221KA01# |                    |                    |                    |  |
|        |               |         | 330pF              | ±10%               | GRM155R71H331KA01# |                    |                    |                    |  |
|        |               |         | 470pF              | ±10%               | GRM155R71H471KA01# |                    |                    |                    |  |
|        |               |         | 680pF              | ±10%               | GRM155R71H681KA01# |                    |                    |                    |  |
|        |               |         | 1000pF             | ±10%               | GRM155R71H102KA01# |                    |                    |                    |  |
|        |               |         | 1500pF             | ±10%               | GRM155R71H152KA01# |                    |                    |                    |  |
| 2200pF | ±10%          |         | GRM155R71H222KA01# |                    |                    |                    |                    |                    |  |
| 3300pF | ±10%          |         | GRM155R71H332KA01# |                    |                    |                    |                    |                    |  |

Part number # indicates the package specification code.

GRM Series  
GJM Series  
GMA Series  
GMD Series  
GQM Series  
GRJ Series  
GR3 Series  
KRM Series  
KR3 Series  
LLA Series  
LLL Series  
LLM Series  
LLR Series  
⚠Caution/ Notice

# GRM Series High Dielectric Constant Type Part Number List

(→ ■ 1.0x0.5mm)

| T max. | Rated Voltage | TC Code | Cap.    | Tol.               | Part Number        |                    |
|--------|---------------|---------|---------|--------------------|--------------------|--------------------|
| 0.55mm | 50Vdc         | X7R     | 4700pF  | ±10%               | GRM155R71H472KA01# |                    |
|        |               |         | 6800pF  | ±10%               | GRM155R71H682KA88# |                    |
|        |               |         | 10000pF | ±10%               | GRM155R71H103KA88# |                    |
|        |               |         | 15000pF | ±10%               | GRM155R71H153KA12# |                    |
|        |               |         | 22000pF | ±10%               | GRM155R71H223KA12# |                    |
|        |               |         | 33000pF | ±10%               | GRM155R71H333KE14# |                    |
|        |               |         |         | ±20%               | GRM155R71H333ME14# |                    |
|        |               |         | 47000pF | ±10%               | GRM155R71H473KE14# |                    |
|        |               |         |         | ±20%               | GRM155R71H473ME14# |                    |
|        |               |         | 68000pF | ±10%               | GRM155R71H683KE14# |                    |
|        |               |         |         | ±20%               | GRM155R71H683ME14# |                    |
|        |               |         | 0.10μF  | ±10%               | GRM155R71H104KE14# |                    |
|        |               |         |         | ±20%               | GRM155R71H104ME14# |                    |
|        |               |         | R       | 220pF              | ±10%               | GRM155R11H221KA01# |
|        |               |         |         | 330pF              | ±10%               | GRM155R11H331KA01# |
|        |               |         |         | 470pF              | ±10%               | GRM155R11H471KA01# |
|        |               |         |         | 680pF              | ±10%               | GRM155R11H681KA01# |
|        |               |         |         | 1000pF             | ±10%               | GRM155R11H102KA01# |
|        |               | 1500pF  |         | ±10%               | GRM155R11H152KA01# |                    |
|        |               | 2200pF  |         | ±10%               | GRM155R11H222KA01# |                    |
|        |               | 3300pF  |         | ±10%               | GRM155R11H332KA01# |                    |
|        |               | 4700pF  |         | ±10%               | GRM155R11H472KA01# |                    |
|        |               | 6800pF  |         | ±10%               | GRM155R11H682KA88# |                    |
|        |               | 10000pF |         | ±10%               | GRM155R11H103KA88# |                    |
|        |               | X6S     |         | 33000pF            | ±10%               | GRM155C81H333KE14# |
|        |               |         |         |                    | ±20%               | GRM155C81H333ME14# |
|        |               |         |         | 47000pF            | ±10%               | GRM155C81H473KE14# |
|        |               |         |         |                    | ±20%               | GRM155C81H473ME14# |
|        |               |         |         | 68000pF            | ±10%               | GRM155C81H683KE14# |
|        |               |         |         |                    | ±20%               | GRM155C81H683ME14# |
|        |               | X5R     |         | 33000pF            | ±10%               | GRM155R61H333KE14# |
|        |               |         |         | ±20%               | GRM155R61H333ME14# |                    |
|        |               |         | 47000pF | ±10%               | GRM155R61H473KE14# |                    |
|        |               |         |         | ±20%               | GRM155R61H473ME14# |                    |
|        |               |         | 68000pF | ±10%               | GRM155R61H683KE14# |                    |
|        |               |         |         | ±20%               | GRM155R61H683ME14# |                    |
|        |               | 0.10μF  | ±10%    | GRM155R61H104KE14# |                    |                    |
|        |               |         |         | ±20%               | GRM155R61H104ME14# |                    |
|        |               |         | B       | 220pF              | ±10%               | GRM155B11H221KA01# |
|        |               |         |         |                    | ±20%               | GRM155B11H221MA01# |
|        |               |         |         | 330pF              | ±10%               | GRM155B11H331KA01# |
|        |               |         |         |                    | ±20%               | GRM155B11H331MA01# |
|        |               | 470pF   |         | ±10%               | GRM155B11H471KA01# |                    |
|        |               |         |         | ±20%               | GRM155B11H471MA01# |                    |
|        |               | 680pF   |         | ±10%               | GRM155B11H681KA01# |                    |
|        |               |         |         | ±20%               | GRM155B11H681MA01# |                    |
|        |               | 1000pF  |         | ±10%               | GRM155B11H102KA01# |                    |
|        |               |         |         | ±20%               | GRM155B11H102MA01# |                    |
|        |               | 1500pF  |         | ±10%               | GRM155B11H152KA01# |                    |
|        |               |         |         | ±20%               | GRM155B11H152MA01# |                    |
|        |               | 2200pF  |         | ±10%               | GRM155B11H222KA01# |                    |
|        |               |         |         | ±20%               | GRM155B11H222MA01# |                    |
|        |               | 3300pF  |         | ±10%               | GRM155B11H332KA01# |                    |
|        |               |         |         | ±20%               | GRM155B11H332MA01# |                    |

| T max. | Rated Voltage | TC Code | Cap.               | Tol.               | Part Number        |                    |                    |                    |
|--------|---------------|---------|--------------------|--------------------|--------------------|--------------------|--------------------|--------------------|
| 0.55mm | 50Vdc         | B       | 4700pF             | ±10%               | GRM155B11H472KA01# |                    |                    |                    |
|        |               |         |                    | ±20%               | GRM155B11H472MA01# |                    |                    |                    |
|        |               |         | 6800pF             | ±10%               | GRM155B31H682KA88# |                    |                    |                    |
|        |               |         |                    | ±20%               | GRM155B31H682MA88# |                    |                    |                    |
|        |               |         | 10000pF            | ±10%               | GRM155B31H103KA88# |                    |                    |                    |
|        |               |         |                    | ±20%               | GRM155B31H103MA88# |                    |                    |                    |
|        |               |         | 15000pF            | ±10%               | GRM155B31H153KA12# |                    |                    |                    |
|        |               |         |                    | ±20%               | GRM155B31H153MA12# |                    |                    |                    |
|        |               |         | 22000pF            | ±10%               | GRM155B31H223KA12# |                    |                    |                    |
|        |               |         |                    | ±20%               | GRM155B31H223MA12# |                    |                    |                    |
|        |               |         | 0.10μF             | ±10%               | GRM155B31H104KE14# |                    |                    |                    |
|        |               |         |                    | ±20%               | GRM155B31H104ME14# |                    |                    |                    |
|        |               |         | 35Vdc              | X6S                | 0.22μF             | ±10%               | GRM155C8YA224KE01# |                    |
|        |               |         |                    |                    |                    | ±20%               | GRM155C8YA224ME01# |                    |
|        |               |         |                    |                    | 0.22μF             | ±10%               | GRM155R6YA224KE01# |                    |
|        |               |         |                    |                    |                    | ±20%               | GRM155R6YA224ME01# |                    |
|        |               |         |                    |                    | 0.47μF             | ±10%               | GRM155R6YA474KE01# |                    |
|        |               |         |                    |                    |                    | ±20%               | GRM155R6YA474ME01# |                    |
|        |               | 25Vdc   |                    | X7R                | 10000pF            | ±10%               | GRM155R71E103KA01# |                    |
|        |               |         |                    |                    | 15000pF            | ±10%               | GRM155R71E153KA61# |                    |
|        |               |         |                    |                    | 22000pF            | ±10%               | GRM155R71E223KA61# |                    |
|        |               |         |                    |                    | 33000pF            | ±10%               | GRM155R71E333KA88# |                    |
|        |               |         |                    |                    | 47000pF            | ±10%               | GRM155R71E473KA88# |                    |
|        |               |         |                    |                    | 68000pF            | ±10%               | GRM155R71E683KE14# |                    |
|        |               |         |                    |                    | ±20%               | GRM155R71E683ME14# |                    |                    |
|        |               |         |                    | 0.10μF             | ±10%               | GRM155R71E104KE14# |                    |                    |
|        |               |         |                    |                    |                    | ±20%               | GRM155R71E104ME14# |                    |
|        |               |         |                    |                    | R                  | 6800pF             | ±10%               | GRM155R11E682KA01# |
|        |               |         |                    |                    |                    | 10000pF            | ±10%               | GRM155R11E103KA01# |
|        |               |         |                    |                    |                    | 15000pF            | ±10%               | GRM155R11E153KA61# |
|        |               | 22000pF | ±10%               |                    |                    | GRM155R11E223KA61# |                    |                    |
|        |               | 33000pF | ±10%               | GRM155R11E333KA88# |                    |                    |                    |                    |
|        |               | 47000pF | ±10%               | GRM155R11E473KA88# |                    |                    |                    |                    |
|        |               | X6S     | 0.22μF             | ±10%               | GRM155C81E224KE01# |                    |                    |                    |
|        |               |         |                    | ±20%               | GRM155C81E224ME01# |                    |                    |                    |
|        |               |         | X5R                | 68000pF            | ±10%               | GRM155R61E683KA87# |                    |                    |
|        |               |         |                    | ±20%               | GRM155R61E683MA87# |                    |                    |                    |
|        | 0.10μF        |         |                    | ±10%               | GRM155R61E104KA87# |                    |                    |                    |
|        |               |         |                    | ±20%               | GRM155R61E104MA87# |                    |                    |                    |
|        | 0.22μF        | ±10%    | GRM155R61E224KE01# |                    |                    |                    |                    |                    |
|        |               |         | ±20%               | GRM155R61E224ME01# |                    |                    |                    |                    |
|        |               | 0.47μF  | ±10%               | GRM155R61E474KE01# |                    |                    |                    |                    |
|        |               |         | ±20%               | GRM155R61E474ME01# |                    |                    |                    |                    |
|        |               | 1.0μF   | ±10%               | GRM155R61E105KA12# |                    |                    |                    |                    |
|        |               |         | ±20%               | GRM155R61E105MA12# |                    |                    |                    |                    |
|        | B             | 10000pF | ±10%               | GRM155B11E103KA01# |                    |                    |                    |                    |
|        |               |         | ±20%               | GRM155B11E103MA01# |                    |                    |                    |                    |
|        |               | 15000pF | ±10%               | GRM155B11E153KA61# |                    |                    |                    |                    |
|        |               |         | ±20%               | GRM155B11E153MA61# |                    |                    |                    |                    |
|        |               | 22000pF | ±10%               | GRM155B11E223KA61# |                    |                    |                    |                    |
|        |               |         | ±20%               | GRM155B11E223MA61# |                    |                    |                    |                    |
|        |               | 33000pF | ±10%               | GRM155B31E333KA87# |                    |                    |                    |                    |
|        |               |         | ±20%               | GRM155B31E333MA87# |                    |                    |                    |                    |
|        |               | 47000pF | ±10%               | GRM155B31E473KA87# |                    |                    |                    |                    |

Part number # indicates the package specification code.

- GRM Series
- GJM Series
- GMA Series
- GMD Series
- GQM Series
- GRJ Series
- GR3 Series
- KRM Series
- KR3 Series
- LLA Series
- LLL Series
- LLM Series
- LLR Series
- ⚠Caution/ Notice



## GRM Series High Dielectric Constant Type Part Number List

(→ ■ 1.0x0.5mm)

| T max. | Rated Voltage | TC Code | Cap.               | Tol.               | Part Number        |                    |                    |                    |
|--------|---------------|---------|--------------------|--------------------|--------------------|--------------------|--------------------|--------------------|
| 0.55mm | 25Vdc         | B       | 47000pF            | ±20%               | GRM155B31E473MA87# |                    |                    |                    |
|        |               |         |                    | ±10%               | GRM155B31E683KA87# |                    |                    |                    |
|        |               |         |                    |                    | ±20%               | GRM155B31E683MA87# |                    |                    |
|        |               |         | 0.10μF             | ±10%               | GRM155B31E104KA87# |                    |                    |                    |
|        |               |         |                    | ±20%               | GRM155B31E104MA87# |                    |                    |                    |
|        |               |         |                    |                    | ±10%               | GRM155B31E105KA12# |                    |                    |
|        |               | ±20%    | GRM155B31E105MA12# |                    |                    |                    |                    |                    |
|        |               |         | 16Vdc              | X7R                | 68000pF            | ±10%               | GRM155R71C683KA88# |                    |
|        |               | ±10%    |                    |                    |                    | GRM155R71C154KA12# |                    |                    |
|        |               | ±10%    |                    |                    |                    | GRM155R71C224KA12# |                    |                    |
|        |               | R       |                    | 68000pF            | ±10%               | GRM155R11C683KA88# |                    |                    |
|        |               |         |                    |                    | X6S                | 0.47μF             | ±10%               | GRM155C81C474KE01# |
|        | ±20%          |         |                    |                    |                    |                    | GRM155C81C474ME01# |                    |
|        | X5R           | 0.22μF  | ±10%               | GRM155R61C224KA12# |                    |                    |                    |                    |
|        |               |         | ±20%               | GRM155R61C224MA12# |                    |                    |                    |                    |
|        |               |         |                    | ±10%               | GRM155R61C474KE01# |                    |                    |                    |
|        |               | ±20%    | GRM155R61C474ME01# |                    |                    |                    |                    |                    |
|        |               |         | 1.0μF              | ±10%               | GRM155R61C105KA12# |                    |                    |                    |
|        |               |         |                    | ±20%               | GRM155R61C105MA12# |                    |                    |                    |
|        | B             | 1.0μF   | ±10%               | GRM155B31C105KA12# |                    |                    |                    |                    |
|        |               |         | ±20%               | GRM155B31C105MA12# |                    |                    |                    |                    |
|        | 10Vdc         | X7R     | 0.22μF             | ±10%               | GRM155R71A224KE01# |                    |                    |                    |
|        |               |         |                    | ±20%               | GRM155R71A224ME01# |                    |                    |                    |
|        |               |         |                    |                    | ±10%               | GRM155R71A474KE01# |                    |                    |
|        |               |         |                    | ±20%               | GRM155R71A474ME01# |                    |                    |                    |
|        |               |         |                    |                    | X6S                | 1.0μF              | ±10%               | GRM155C81A105KA12# |
|        |               |         |                    | ±20%               |                    |                    | GRM155C81A105MA12# |                    |
|        |               |         | X5R                | 0.15μF             | ±10%               | GRM155R61A154KE19# |                    |                    |
|        |               |         |                    |                    | ±20%               | GRM155R61A154ME19# |                    |                    |
|        |               |         |                    |                    |                    | ±10%               | GRM155R61A224KE19# |                    |
|        |               |         |                    | ±20%               | GRM155R61A224ME19# |                    |                    |                    |
|        |               |         |                    |                    | 0.33μF             | ±10%               | GRM155R61A334KE15# |                    |
|        |               |         |                    |                    |                    | ±20%               | GRM155R61A334ME15# |                    |
|        |               | 0.47μF  | ±10%               | GRM155R61A474KE15# |                    |                    |                    |                    |
|        |               |         | ±20%               | GRM155R61A474ME15# |                    |                    |                    |                    |
|        |               | 0.68μF  | ±10%               | GRM155R61A684KE15# |                    |                    |                    |                    |
|        |               |         |                    | ±20%               | GRM155R61A684ME15# |                    |                    |                    |
|        |               |         |                    |                    | B                  | 0.15μF             | ±10%               | GRM155B31A154KE18# |
|        |               |         | ±20%               | GRM155B31A154ME18# |                    |                    |                    |                    |
|        |               |         | 0.22μF             | ±10%               |                    | GRM155B31A224KE18# |                    |                    |
|        |               |         |                    | ±20%               | GRM155B31A224ME18# |                    |                    |                    |
|        |               | 0.33μF  | ±10%               | GRM155B31A334KE14# |                    |                    |                    |                    |
| ±20%   |               |         | GRM155B31A334ME14# |                    |                    |                    |                    |                    |
| 0.47μF |               | ±10%    | GRM155B31A474KE14# |                    |                    |                    |                    |                    |
|        |               | ±20%    | GRM155B31A474ME14# |                    |                    |                    |                    |                    |
| 0.68μF |               | ±10%    | GRM155B31A684KE15# |                    |                    |                    |                    |                    |
|        |               | ±20%    | GRM155B31A684ME15# |                    |                    |                    |                    |                    |
| 2.2μF  |               | ±10%    | GRM155B31A225KE95# |                    |                    |                    |                    |                    |
|        |               | ±20%    | GRM155B31A225ME95# |                    |                    |                    |                    |                    |
| 6.3Vdc |               | X7R     | 1.0μF              | ±10%               | GRM155R70J105KA12# |                    |                    |                    |
|        |               |         |                    | ±20%               | GRM155R70J105MA12# |                    |                    |                    |
|        |               | X6S     | 2.2μF              | ±10%               | GRM155C80J225KE95# |                    |                    |                    |
|        |               |         |                    | ±20%               | GRM155C80J225ME95# |                    |                    |                    |
|        |               | X5R     | 0.15μF             | ±10%               | GRM155R60J154KE01# |                    |                    |                    |

| T max. | Rated Voltage | TC Code            | Cap.   | Tol.               | Part Number        |                    |                    |                    |
|--------|---------------|--------------------|--------|--------------------|--------------------|--------------------|--------------------|--------------------|
| 0.55mm | 6.3Vdc        | X5R                | 0.15μF | ±20%               | GRM155R60J154ME01# |                    |                    |                    |
|        |               |                    |        | ±10%               | GRM155R60J224KE01# |                    |                    |                    |
|        |               |                    |        |                    | ±20%               | GRM155R60J224ME01# |                    |                    |
|        |               |                    | 0.33μF | ±10%               | GRM155R60J334KE01# |                    |                    |                    |
|        |               |                    |        | ±20%               | GRM155R60J334ME01# |                    |                    |                    |
|        |               |                    |        |                    | ±10%               | GRM155R60J474KE19# |                    |                    |
|        |               |                    | ±20%   | GRM155R60J474ME19# |                    |                    |                    |                    |
|        |               |                    |        | 0.68μF             | ±10%               | GRM155R60J684KE19# |                    |                    |
|        |               |                    | ±20%   |                    | GRM155R60J684ME19# |                    |                    |                    |
|        |               |                    | B      | 0.15μF             | ±10%               | GRM155B10J154KE01# |                    |                    |
|        |               |                    |        |                    | ±20%               | GRM155B10J154ME01# |                    |                    |
|        |               |                    |        |                    |                    | ±10%               | GRM155B10J224KE01# |                    |
|        |               | ±20%               |        | GRM155B10J224ME01# |                    |                    |                    |                    |
|        |               |                    |        | 0.33μF             | ±10%               | GRM155B10J334KE01# |                    |                    |
|        |               | ±20%               |        |                    | GRM155B10J334ME01# |                    |                    |                    |
|        |               | 0.47μF             |        | ±10%               | GRM155B30J474KE18# |                    |                    |                    |
|        |               |                    |        | ±20%               | GRM155B30J474ME18# |                    |                    |                    |
|        |               | 0.68μF             |        | ±10%               | GRM155B30J684KE18# |                    |                    |                    |
|        |               |                    |        | ±20%               | GRM155B30J684ME18# |                    |                    |                    |
|        |               | 2.2μF              |        | ±10%               | GRM155B30J225KE95# |                    |                    |                    |
|        |               |                    |        | ±20%               | GRM155B30J225ME95# |                    |                    |                    |
|        |               | 4Vdc               | X7R    | 1.0μF              | ±10%               | GRM155R70G105KA12# |                    |                    |
|        |               |                    |        |                    | ±20%               | GRM155R70G105MA12# |                    |                    |
|        |               |                    | 0.6mm  | 35Vdc              | X5R                | 1.0μF              | ±10%               | GRM155R6YA105KE11# |
|        | ±20%          |                    |        |                    |                    |                    | GRM155R6YA105ME11# |                    |
|        | 25Vdc         |                    |        | X6S                | 1.0μF              | ±10%               | GRM155C81E105KE11# |                    |
|        |               |                    |        |                    |                    | ±20%               | GRM155C81E105ME11# |                    |
|        | 16Vdc         | X6S                | 1.0μF  | ±10%               | GRM155C81C105KE11# |                    |                    |                    |
|        |               |                    |        | ±20%               | GRM155C81C105ME11# |                    |                    |                    |
|        | 6.3Vdc        | X5R                | 4.7μF  | ±20%               | GRM155R60J475ME47# |                    |                    |                    |
|        |               |                    |        | B                  | ±20%               | GRM155B30J475ME47# |                    |                    |
|        | 4Vdc          | X5R                | 4.7μF  | ±20%               | GRM155R60G475ME47# |                    |                    |                    |
|        |               |                    |        | B                  | ±20%               | GRM155B30G475ME47# |                    |                    |
|        | 2.5Vdc        | X6T                | 4.7μF  | ±20%               | GRM155D80E475ME47# |                    |                    |                    |
|        |               |                    |        | 0.65mm             | 6.3Vdc             | X6S                | 4.7μF              | ±20%               |
|        | 0.7mm         | 25Vdc              | X5R    | 2.2μF              | ±10%               | GRM155R61E225KE11# |                    |                    |
|        |               |                    |        |                    | ±20%               | GRM155R61E225ME11# |                    |                    |
|        |               |                    |        | 16Vdc              | X6S                | 2.2μF              | ±10%               | GRM155C81C225KE11# |
|        |               |                    | ±20%   |                    |                    |                    | GRM155C81C225ME11# |                    |
|        |               |                    | X5R    | 2.2μF              | ±10%               | GRM155R61C225KE11# |                    |                    |
|        |               |                    |        |                    | ±20%               | GRM155R61C225ME11# |                    |                    |
|        |               | 10Vdc              | X7S    | 2.2μF              | ±10%               | GRM155C71A225KE11# |                    |                    |
| ±20%   |               |                    |        |                    | GRM155C71A225ME11# |                    |                    |                    |
| X6S    |               |                    | 2.2μF  | ±10%               | GRM155C81A225KE11# |                    |                    |                    |
| ±20%   |               | GRM155C81A225ME11# |        |                    |                    |                    |                    |                    |
| 6.3Vdc |               | X7S                | 2.2μF  | ±10%               | GRM155C70J225KE11# |                    |                    |                    |
|        |               |                    |        | ±20%               | GRM155C70J225ME11# |                    |                    |                    |
| 4Vdc   | X5R           | 10μF               | ±20%   | GRM155R60G106ME44# |                    |                    |                    |                    |
|        |               |                    | 2.5Vdc | X5R                | 10μF               | ±20%               | GRM155R60E106ME16# |                    |

Part number # indicates the package specification code.

GRM Series  
GJM Series  
GMA Series  
GMD Series  
GQM Series  
GRJ Series  
GR3 Series  
KRM Series  
KR3 Series  
LLA Series  
LLL Series  
LLM Series  
LLR Series  
⚠Caution/ Notice

# GRM Series High Dielectric Constant Type Part Number List

## ■ 1.6x0.8mm

| T max. | Rated Voltage | TC Code             | Cap.               | Tol.               | Part Number        |                    |                    |
|--------|---------------|---------------------|--------------------|--------------------|--------------------|--------------------|--------------------|
| 0.5mm  | 25Vdc         | X5R                 | 1.0μF              | ±10%               | GRM185R61E105KA12# |                    |                    |
|        |               |                     |                    | ±20%               | GRM185R61E105MA12# |                    |                    |
|        |               |                     | B                  | 1.0μF              | ±10%               | GRM185B31E105KA12# |                    |
|        |               | ±20%                |                    |                    | GRM185B31E105MA12# |                    |                    |
|        |               | 16Vdc               |                    | X5R                | 1.0μF              | ±10%               | GRM185R61C105KE44# |
|        |               |                     | ±20%               |                    |                    | GRM185R61C105ME44# |                    |
|        | B             |                     | 1.0μF              |                    | ±10%               | GRM185B31C105KE43# |                    |
|        |               |                     |                    | ±20%               | GRM185B31C105ME43# |                    |                    |
|        |               |                     | 6.3Vdc             | X5R                | 10μF               | ±20%               | GRM185R60J106ME15# |
|        | 4Vdc          |                     | X5R                | 10μF               | ±20%               | GRM185R60G106ME15# |                    |
|        | 0.55mm        | 16Vdc               | X5R                | 4.7μF              | ±10%               | GRM185R61C475KE11# |                    |
|        |               |                     |                    |                    | ±20%               | GRM185R61C475ME11# |                    |
| X6S    |               |                     |                    | 4.7μF              | ±10%               | GRM185C81A475KE11# |                    |
|        |               |                     | ±20%               |                    | GRM185C81A475ME11# |                    |                    |
|        |               |                     | X5R                | 4.7μF              | ±10%               | GRM185R61A475KE11# |                    |
| ±20%   |               |                     |                    |                    | GRM185R61A475ME11# |                    |                    |
| 6.3Vdc |               | X7T                 |                    | 4.7μF              | ±20%               | GRM185D70J475ME11# |                    |
|        |               | X6S                 | 4.7μF              | ±20%               | GRM185C80J475ME11# |                    |                    |
| 0.9mm  |               | 250Vdc              | X7R                | 220pF              | ±10%               | GRM188R72E221KW07# |                    |
|        |               |                     |                    |                    | ±20%               | GRM188R72E222KW07# |                    |
|        |               |                     |                    | 330pF              | ±10%               | GRM188R72E331KW07# |                    |
|        |               |                     |                    |                    | ±20%               | GRM188R72E332KW07# |                    |
|        | 470pF         |                     |                    | ±10%               | GRM188R72E471KW07# |                    |                    |
|        |               |                     |                    | ±20%               | GRM188R72E472KW07# |                    |                    |
|        | 680pF         |                     |                    | ±10%               | GRM188R72E681KW07# |                    |                    |
|        |               |                     |                    | ±20%               | GRM188R72E682KW07# |                    |                    |
|        | 1000pF        |                     |                    | ±10%               | GRM188R72E102KW07# |                    |                    |
|        |               |                     |                    | ±20%               | GRM188R72E103KW07# |                    |                    |
|        | 1500pF        |                     |                    | ±10%               | GRM188R72E152KW07# |                    |                    |
|        |               |                     |                    | ±20%               | GRM188R72E153KW07# |                    |                    |
|        | 2200pF        |                     | ±10%               | GRM188R72E222KW07# |                    |                    |                    |
|        |               |                     | ±20%               | GRM188R72E223KW07# |                    |                    |                    |
|        | 200Vdc        |                     | X7R                | 220pF              | ±10%               | GRM188R72D221KW07# |                    |
|        |               |                     |                    |                    | ±20%               | GRM188R72D222KW07# |                    |
|        |               |                     |                    | 330pF              | ±10%               | GRM188R72D331KW07# |                    |
|        |               |                     | ±20%               |                    | GRM188R72D332KW07# |                    |                    |
|        |               | 470pF               | ±10%               |                    | GRM188R72D471KW07# |                    |                    |
|        |               |                     | ±20%               | GRM188R72D472KW07# |                    |                    |                    |
|        | 680pF         |                     | ±10%               | GRM188R72D681KW07# |                    |                    |                    |
|        |               | ±20%                | GRM188R72D682KW07# |                    |                    |                    |                    |
|        |               | 1000pF              | ±10%               | GRM188R72D102KW07# |                    |                    |                    |
|        | ±20%          |                     | GRM188R72D103KW07# |                    |                    |                    |                    |
|        | 1500pF        |                     | ±10%               | GRM188R72D152KW07# |                    |                    |                    |
|        |               | ±20%                | GRM188R72D153KW07# |                    |                    |                    |                    |
|        |               | 2200pF              | ±10%               | GRM188R72D222KW07# |                    |                    |                    |
|        | ±20%          |                     | GRM188R72D223KW07# |                    |                    |                    |                    |
|        | 100Vdc        |                     | X7R                | 220pF              | ±10%               | GRM188R72A221KA01# |                    |
|        |               | ±20%                |                    |                    | GRM188R72A222KA01# |                    |                    |
|        |               | 330pF               |                    | ±10%               | GRM188R72A331KA01# |                    |                    |
|        |               |                     |                    | ±20%               | GRM188R72A332KA01# |                    |                    |
|        |               | 470pF               |                    | ±10%               | GRM188R72A471KA01# |                    |                    |
|        |               |                     |                    | ±20%               | GRM188R72A472KA01# |                    |                    |
|        |               | 680pF               |                    | ±10%               | GRM188R72A681KA01# |                    |                    |
|        |               |                     |                    | ±20%               | GRM188R72A682KA01# |                    |                    |
|        |               | 1000pF              |                    | ±10%               | GRM188R72A102KA01# |                    |                    |
|        |               |                     | ±20%               | GRM188R72A103KA01# |                    |                    |                    |
|        |               | 1500pF              | ±10%               | GRM188R72A152KA01# |                    |                    |                    |
|        |               |                     | ±20%               | GRM188R72A153KA01# |                    |                    |                    |
|        |               |                     | ±20%               | GRM188R72A153MAC4# |                    |                    |                    |
|        |               | 2200pF              | ±10%               | GRM188R72A222KA01# |                    |                    |                    |
| ±20%   |               |                     | GRM188R72A223KA01# |                    |                    |                    |                    |
| ±20%   |               |                     | GRM188R72A223MAC4# |                    |                    |                    |                    |
| 0.10μF |               | ±10%                | GRM188R72A104KA35# |                    |                    |                    |                    |
|        |               | ±20%                | GRM188R72A104MA35# |                    |                    |                    |                    |
|        | ±20%          | GRM188R72A104MAC35# |                    |                    |                    |                    |                    |
| 50Vdc  | X7R           | 220pF               | ±10%               | GRM188R71H221KA01# |                    |                    |                    |
|        |               |                     | ±20%               | GRM188R71H222KA01# |                    |                    |                    |
|        |               | 330pF               | ±10%               | GRM188R71H331KA01# |                    |                    |                    |
|        |               |                     | ±20%               | GRM188R71H332KA01# |                    |                    |                    |
|        |               | 470pF               | ±10%               | GRM188R71H471KA01# |                    |                    |                    |
|        |               |                     | ±20%               | GRM188R71H472KA01# |                    |                    |                    |
| 680pF  | ±10%          | GRM188R71H681KA01#  |                    |                    |                    |                    |                    |
|        | ±20%          | GRM188R71H682KA01#  |                    |                    |                    |                    |                    |

| T max. | Rated Voltage | TC Code            | Cap.               | Tol.               | Part Number        |                    |  |
|--------|---------------|--------------------|--------------------|--------------------|--------------------|--------------------|--|
| 0.9mm  | 50Vdc         | X7R                | 1000pF             | ±10%               | GRM188R71H102KA01# |                    |  |
|        |               |                    |                    | ±20%               | GRM188R71H103KA01# |                    |  |
|        |               |                    | 1500pF             | ±10%               | GRM188R71H152KA01# |                    |  |
|        |               |                    |                    | ±20%               | GRM188R71H153KA01# |                    |  |
|        |               |                    | 2200pF             | ±10%               | GRM188R71H222KA01# |                    |  |
|        |               |                    |                    | ±20%               | GRM188R71H223KA01# |                    |  |
|        |               |                    | 3300pF             | ±10%               | GRM188R71H332KA01# |                    |  |
|        |               |                    |                    | ±20%               | GRM188R71H333KA01# |                    |  |
|        |               |                    | 4700pF             | ±10%               | GRM188R71H472KA01# |                    |  |
|        |               |                    |                    | ±20%               | GRM188R71H473KA01# |                    |  |
|        |               |                    | 6800pF             | ±10%               | GRM188R71H682KA01# |                    |  |
|        |               |                    |                    | ±20%               | GRM188R71H683KA01# |                    |  |
|        |               |                    | 10000pF            | ±10%               | GRM188R71H103KA01# |                    |  |
|        |               |                    |                    | ±20%               | GRM188R71H104KA01# |                    |  |
|        |               |                    | 15000pF            | ±10%               | GRM188R71H153KA01# |                    |  |
|        |               |                    |                    | ±20%               | GRM188R71H154KA01# |                    |  |
|        |               |                    | 22000pF            | ±10%               | GRM188R71H223KA01# |                    |  |
|        |               |                    |                    | ±20%               | GRM188R71H224KA01# |                    |  |
|        |               | 33000pF            | ±10%               | GRM188R71H333KA61# |                    |                    |  |
|        |               |                    | ±20%               | GRM188R71H334KA61# |                    |                    |  |
|        |               | 47000pF            | ±10%               | GRM188R71H473KA61# |                    |                    |  |
|        |               |                    | ±20%               | GRM188R71H474KA61# |                    |                    |  |
|        |               | 68000pF            | ±10%               | GRM188R71H683KA93# |                    |                    |  |
|        |               |                    | ±20%               | GRM188R71H684KA93# |                    |                    |  |
|        |               | R                  | 0.10μF             | ±10%               | GRM188R71H104KA93# |                    |  |
|        |               |                    |                    |                    | GRM188R71H105KA93# |                    |  |
|        |               |                    |                    | 0.15μF             | ±10%               | GRM188R71H154KAC4# |  |
|        |               |                    |                    |                    | ±20%               | GRM188R71H154MAC4# |  |
|        |               |                    |                    | 0.22μF             | ±10%               | GRM188R71H224KAC4# |  |
|        |               |                    |                    |                    | ±20%               | GRM188R71H224MAC4# |  |
|        |               |                    | 220pF              | ±10%               | GRM188R11H221KA01# |                    |  |
|        |               |                    |                    | ±20%               | GRM188R11H222KA01# |                    |  |
|        |               |                    |                    | 330pF              | ±10%               | GRM188R11H331KA01# |  |
|        |               |                    |                    | 470pF              | ±10%               | GRM188R11H471KA01# |  |
|        |               |                    |                    | 680pF              | ±10%               | GRM188R11H681KA01# |  |
|        |               |                    |                    | 1000pF             | ±10%               | GRM188R11H102KA01# |  |
| X5R    | 0.22μF        | ±10%               | GRM188R61H224KAC4# |                    |                    |                    |  |
|        |               |                    | GRM188R61H224MAC4# |                    |                    |                    |  |
|        |               | 0.47μF             | ±10%               | GRM188R61H474KA12# |                    |                    |  |
|        |               |                    | ±20%               | GRM188R61H474MA12# |                    |                    |  |
|        |               | 1.0μF              | ±10%               | GRM188R61H105KAAL# |                    |                    |  |
|        |               |                    | ±20%               | GRM188R61H105MAAL# |                    |                    |  |
|        | 220pF         | ±10%               | GRM188B11H221KA01# |                    |                    |                    |  |
|        |               | ±20%               | GRM188B11H221MA01# |                    |                    |                    |  |
|        |               | 330pF              | ±10%               | GRM188B11H331KA01# |                    |                    |  |
|        |               | ±20%               | GRM188B11H331MA01# |                    |                    |                    |  |
|        |               | 470pF              | ±10%               | GRM188B11H471KA01# |                    |                    |  |
|        |               |                    | ±20%               | GRM188B11H471MA01# |                    |                    |  |
| 680pF  | ±10%          | GRM188B11H681KA01# |                    |                    |                    |                    |  |
|        | ±20%          | GRM188B11H681MA01# |                    |                    |                    |                    |  |
| 1000pF | ±10%          | GRM188B11H102KA01# |                    |                    |                    |                    |  |
|        | ±20%          | GRM188B11H102MA01# |                    |                    |                    |                    |  |
| 1500pF | ±10%          | GRM188B11H152KA01# |                    |                    |                    |                    |  |
|        | ±20%          | GRM188B11H152MA01# |                    |                    |                    |                    |  |
| 2200pF | ±10%          | GRM188B11H222KA01# |                    |                    |                    |                    |  |
|        | ±20%          | GRM188B11H222MA01# |                    |                    |                    |                    |  |
| 3300pF | ±10%          | GRM188B11H332KA01# |                    |                    |                    |                    |  |
|        | ±20%          | GRM188B11H332MA01# |                    |                    |                    |                    |  |

Part number # indicates the package specification code.

## GRM Series High Dielectric Constant Type Part Number List

(→ ■ 1.6x0.8mm)

| T max. | Rated Voltage | TC Code            | Cap.               | Tol.               | Part Number        |                    |                    |  |
|--------|---------------|--------------------|--------------------|--------------------|--------------------|--------------------|--------------------|--|
| 0.9mm  | 50Vdc         | B                  | 3300pF             | ±20%               | GRM188B11H332MA01# |                    |                    |  |
|        |               |                    | 4700pF             | ±10%               | GRM188B11H472KA01# |                    |                    |  |
|        |               |                    |                    | ±20%               | GRM188B11H472MA01# |                    |                    |  |
|        |               |                    | 6800pF             | ±10%               | GRM188B11H682KA01# |                    |                    |  |
|        |               |                    |                    | ±20%               | GRM188B11H682MA01# |                    |                    |  |
|        |               |                    | 10000pF            | ±10%               | GRM188B11H103KA01# |                    |                    |  |
|        |               |                    |                    | ±20%               | GRM188B11H103MA01# |                    |                    |  |
|        |               |                    | 15000pF            | ±10%               | GRM188B11H153KA01# |                    |                    |  |
|        |               |                    |                    | ±20%               | GRM188B11H153MA01# |                    |                    |  |
|        |               |                    | 22000pF            | ±10%               | GRM188B11H223KA01# |                    |                    |  |
|        |               |                    |                    | ±20%               | GRM188B11H223MA01# |                    |                    |  |
|        |               |                    | 33000pF            | ±10%               | GRM188B11H333KA61# |                    |                    |  |
|        |               |                    |                    | ±20%               | GRM188B11H333MA61# |                    |                    |  |
|        |               |                    | 47000pF            | ±10%               | GRM188B11H473KA61# |                    |                    |  |
|        |               |                    |                    | ±20%               | GRM188B11H473MA61# |                    |                    |  |
|        |               |                    | 68000pF            | ±10%               | GRM188B31H683KA92# |                    |                    |  |
|        |               |                    |                    | ±20%               | GRM188B31H683MA92# |                    |                    |  |
|        |               |                    | 0.10μF             | ±10%               | GRM188B31H104KA92# |                    |                    |  |
|        |               |                    |                    | ±20%               | GRM188B31H104MA92# |                    |                    |  |
|        |               |                    | 0.15μF             | ±10%               | GRM188B31H154KAC4# |                    |                    |  |
|        |               |                    |                    | ±20%               | GRM188B31H154MAC4# |                    |                    |  |
|        |               |                    | 0.22μF             | ±10%               | GRM188B31H224KAC4# |                    |                    |  |
|        |               |                    |                    | ±20%               | GRM188B31H224MAC4# |                    |                    |  |
|        |               |                    | 1.0μF              | ±10%               | GRM188B31H105KAAL# |                    |                    |  |
|        | ±20%          | GRM188B31H105MAAL# |                    |                    |                    |                    |                    |  |
|        | 25Vdc         | X7R                | 33000pF            | ±10%               | GRM188R71E333KA01# |                    |                    |  |
|        |               |                    | 47000pF            | ±10%               | GRM188R71E473KA01# |                    |                    |  |
|        |               |                    | 68000pF            | ±10%               | GRM188R71E683KA01# |                    |                    |  |
|        |               |                    | 0.15μF             | ±10%               | GRM188R71E154KA01# |                    |                    |  |
|        |               |                    | 0.22μF             | ±10%               | GRM188R71E224KA88# |                    |                    |  |
|        |               |                    |                    | ±20%               | GRM188R71E224MA12# |                    |                    |  |
|        |               |                    | 0.47μF             | ±10%               | GRM188R71E474KA12# |                    |                    |  |
|        |               |                    |                    | ±20%               | GRM188R71E474MA12# |                    |                    |  |
|        |               |                    | 1.0μF              | ±10%               | GRM188R71E105KA12# |                    |                    |  |
|        |               |                    |                    | ±20%               | GRM188R71E105MA12# |                    |                    |  |
|        |               |                    | R                  | 33000pF            | ±10%               | GRM188R11E333KA01# |                    |  |
|        |               |                    |                    | 47000pF            | ±10%               | GRM188R11E473KA01# |                    |  |
|        |               | 68000pF            |                    | ±10%               | GRM188R11E683KA01# |                    |                    |  |
|        |               | 0.15μF             |                    | ±10%               | GRM188R11E154KA01# |                    |                    |  |
|        |               | 0.22μF             |                    | ±10%               | GRM188R11E224KA88# |                    |                    |  |
|        |               |                    |                    | ±20%               | GRM188R11E224MA12# |                    |                    |  |
|        |               | X5R                | 0.22μF             | ±10%               | GRM188R61E224KA88# |                    |                    |  |
|        |               |                    | 0.47μF             | ±10%               | GRM188R61E474KA12# |                    |                    |  |
|        |               |                    |                    | ±20%               | GRM188R61E474MA12# |                    |                    |  |
|        |               |                    | 0.68μF             | ±10%               | GRM188R61E684KA75# |                    |                    |  |
|        |               |                    |                    | ±20%               | GRM188R61E684MA75# |                    |                    |  |
|        |               |                    | 1.0μF              | ±10%               | GRM188R61E105KA12# |                    |                    |  |
|        |               | ±20%               |                    | GRM188R61E105MA12# |                    |                    |                    |  |
| B      |               | 10000pF            | ±10%               | GRM188B11E103KA01# |                    |                    |                    |  |
|        | ±20%          |                    | GRM188B11E103MA01# |                    |                    |                    |                    |  |
|        | 15000pF       | ±10%               | GRM188B11E153KA01# |                    |                    |                    |                    |  |
|        |               | ±20%               | GRM188B11E153MA01# |                    |                    |                    |                    |  |
|        | 22000pF       | ±10%               | GRM188B11E223KA01# |                    |                    |                    |                    |  |
|        |               | ±20%               | GRM188B11E223MA01# |                    |                    |                    |                    |  |
| 0.9mm  | 25Vdc         | B                  | 33000pF            | ±10%               | GRM188B11E333KA01# |                    |                    |  |
|        |               |                    | 47000pF            | ±20%               | GRM188B11E333MA01# |                    |                    |  |
|        |               |                    |                    | ±10%               | GRM188B11E473KA01# |                    |                    |  |
|        |               |                    | 68000pF            | ±10%               | GRM188B11E683KA01# |                    |                    |  |
|        |               |                    |                    | ±20%               | GRM188B11E683MA01# |                    |                    |  |
|        |               |                    | 0.10μF             | ±10%               | GRM188B11E104KA01# |                    |                    |  |
|        |               |                    |                    | ±20%               | GRM188B11E104MA01# |                    |                    |  |
|        |               |                    | 0.15μF             | ±10%               | GRM188B11E154KA01# |                    |                    |  |
|        |               |                    |                    | ±20%               | GRM188B11E154MA01# |                    |                    |  |
|        |               |                    | 0.22μF             | ±10%               | GRM188B31E224KA87# |                    |                    |  |
|        |               |                    |                    | ±10%               | GRM188B31E474KA75# |                    |                    |  |
|        |               |                    | 0.47μF             | ±10%               | GRM188B31E474MA75# |                    |                    |  |
|        |               |                    |                    | ±20%               | GRM188B31E474MA75# |                    |                    |  |
|        |               |                    | 0.68μF             | ±10%               | GRM188B31E684KA75# |                    |                    |  |
|        |               |                    |                    | ±20%               | GRM188B31E684MA75# |                    |                    |  |
|        |               |                    | 1.0μF              | ±10%               | GRM188B31E105KA75# |                    |                    |  |
|        |               |                    |                    | ±20%               | GRM188B31E105MA75# |                    |                    |  |
|        |               |                    | 2.2μF              | ±10%               | GRM188B31E225KA12# |                    |                    |  |
|        |               |                    |                    | ±20%               | GRM188B31E225MA12# |                    |                    |  |
|        |               |                    | 16Vdc              | X7R                | 0.15μF             | ±10%               | GRM188R71C154KA01# |  |
|        |               |                    |                    |                    | 0.22μF             | ±10%               | GRM188R71C224KA01# |  |
|        |               |                    |                    |                    | 0.33μF             | ±10%               | GRM188R71C334KA01# |  |
|        |               |                    |                    |                    | 0.47μF             | ±10%               | GRM188R71C474KA88# |  |
|        |               |                    |                    |                    |                    | ±10%               | GRM188R71C105KE15# |  |
|        | ±20%          | GRM188R71C105ME15# |                    |                    |                    |                    |                    |  |
|        | X7S           | 0.68μF             |                    | ±10%               | GRM188C71C684KA12# |                    |                    |  |
|        |               | ±20%               |                    | GRM188C71C684MA12# |                    |                    |                    |  |
|        | R             | 0.33μF             |                    | ±10%               | GRM188R11C334KA01# |                    |                    |  |
|        |               | 0.47μF             |                    | ±10%               | GRM188R11C474KA88# |                    |                    |  |
|        | X6S           | 2.2μF              |                    | ±10%               | GRM188C81C225KA12# |                    |                    |  |
|        |               |                    |                    | ±20%               | GRM188C81C225MA12# |                    |                    |  |
|        | X5R           | 0.68μF             | ±10%               | GRM188R61C684KA75# |                    |                    |                    |  |
|        |               |                    | ±20%               | GRM188R61C684MA75# |                    |                    |                    |  |
|        |               | 2.2μF              | ±10%               | GRM188R61C225KE15# |                    |                    |                    |  |
|        |               |                    | ±10%               | GRM188B11C334KA01# |                    |                    |                    |  |
|        | B             | 0.33μF             | ±10%               | GRM188B11C334MA01# |                    |                    |                    |  |
|        |               |                    | ±20%               | GRM188B11C334MA01# |                    |                    |                    |  |
|        | 0.68μF        | ±10%               | GRM188B31C684KA75# |                    |                    |                    |                    |  |
|        |               | ±20%               | GRM188B31C684MA75# |                    |                    |                    |                    |  |
|        | 2.2μF         | ±10%               | GRM188B31C225KE14# |                    |                    |                    |                    |  |
|        |               | ±10%               | GRM188R71A334KA61# |                    |                    |                    |                    |  |
|        | 10Vdc         | X7R                | 0.33μF             | ±10%               | GRM188R71A334MA61# |                    |                    |  |
|        |               |                    |                    | ±20%               | GRM188R71A334MA61# |                    |                    |  |
|        | 0.68μF        | ±10%               | GRM188R71A684KA61# |                    |                    |                    |                    |  |
|        |               |                    | ±20%               | GRM188R71A684MA61# |                    |                    |                    |  |
|        | 2.2μF         | ±10%               | GRM188R71A225KE15# |                    |                    |                    |                    |  |
|        |               |                    | ±20%               | GRM188R71A225ME15# |                    |                    |                    |  |
|        | X7T           | 2.2μF              | ±10%               | GRM188D71A225KE34# |                    |                    |                    |  |
| ±20%   |               |                    | GRM188D71A225ME34# |                    |                    |                    |                    |  |
| X5R    | 0.33μF        | ±10%               | GRM188R61A334KA61# |                    |                    |                    |                    |  |
|        |               | ±20%               | GRM188R61A334MA61# |                    |                    |                    |                    |  |
| B      | 0.33μF        | ±10%               | GRM188B11A334KA61# |                    |                    |                    |                    |  |
|        |               | ±20%               | GRM188B11A334MA61# |                    |                    |                    |                    |  |
| 6.3Vdc | B             | 10μF               | ±20%               | GRM188B30J106ME47# |                    |                    |                    |  |
|        |               |                    |                    |                    |                    |                    |                    |  |
| 0.95mm | 25Vdc         | X5R                | 4.7μF              | ±10%               | GRM188R61E475KE11# |                    |                    |  |
|        |               |                    | ±20%               | GRM188R61E475ME11# |                    |                    |                    |  |
|        | 16Vdc         | X6S                | 4.7μF              | ±10%               | GRM188C81C475KE11# |                    |                    |  |
|        |               |                    |                    |                    |                    |                    |                    |  |

Part number # indicates the package specification code.

GRM Series  
GJM Series  
GMA Series  
GMD Series  
GQM Series  
GRJ Series  
GR3 Series  
KRM Series  
KR3 Series  
LLA Series  
LLL Series  
LLM Series  
LLR Series  
⚠Caution/ Notice

# GRM Series High Dielectric Constant Type Part Number List

(→ ■ 1.6x0.8mm)

| T max. | Rated Voltage | TC Code | Cap.  | Tol. | Part Number        |                    |                    |          |                    |      |
|--------|---------------|---------|-------|------|--------------------|--------------------|--------------------|----------|--------------------|------|
| 0.95mm | 16Vdc         | X6S     | 4.7μF | ±20% | GRM188C81C475ME11# |                    |                    |          |                    |      |
|        |               |         |       | X5R  | 4.7μF              | ±10%               | GRM188R61C475KE11# |          |                    |      |
|        |               |         |       |      |                    | ±20%               | GRM188R61C475ME11# |          |                    |      |
|        |               | B       | 4.7μF | ±10% | GRM188R61C106KAAL# |                    |                    |          |                    |      |
|        |               |         |       | ±20% | GRM188R61C106MAAL# |                    |                    |          |                    |      |
|        |               |         |       | ±10% | GRM188B31C475KAAJ# | Derating           |                    |          |                    |      |
|        | 10Vdc         | X7S     | 4.7μF | ±10% | GRM188C71A475KE11# |                    |                    |          |                    |      |
|        |               |         |       | ±20% | GRM188C71A475ME11# |                    |                    |          |                    |      |
|        |               |         |       | X5R  | 10μF               | ±10%               | GRM188R61A106KAAL# |          |                    |      |
|        |               | B       | 10μF  | ±20% | GRM188R61A106MAAL# |                    |                    |          |                    |      |
|        |               |         |       | ±10% | GRM188B31A106ME69# | Derating           |                    |          |                    |      |
|        |               |         |       |      |                    |                    |                    |          |                    |      |
| 1.0mm  | 50Vdc         | X5R     | 2.2μF | ±10% | GRM188R61H225KE11# |                    |                    |          |                    |      |
|        |               |         |       | ±20% | GRM188R61H225ME11# |                    |                    |          |                    |      |
|        |               |         |       | X6S  | 2.2μF              | ±10%               | GRM188C8YA225KE11# |          |                    |      |
|        |               | X5R     | 4.7μF | ±10% | GRM188R6YA475KE15# |                    |                    |          |                    |      |
|        |               |         |       | ±20% | GRM188R6YA475ME15# |                    |                    |          |                    |      |
|        |               |         |       | ±10% | GRM188C71E225KE11# |                    |                    |          |                    |      |
|        | 25Vdc         | X7S     | 2.2μF | ±10% | GRM188C71E225KE11# |                    |                    |          |                    |      |
|        |               |         |       | ±20% | GRM188C71E225ME11# |                    |                    |          |                    |      |
|        |               |         |       | X6S  | 2.2μF              | ±10%               | GRM188C81E225KE11# |          |                    |      |
|        |               | B       | 4.7μF | ±10% | GRM188C81E475KE11# | Derating           |                    |          |                    |      |
|        |               |         |       | ±20% | GRM188C81E475ME11# | Derating           |                    |          |                    |      |
|        |               |         |       | X5R  | 10μF               | ±20%               | GRM188R61E106MA73# |          |                    |      |
|        | 16Vdc         | X7S     | 2.2μF | ±10% | GRM188C71C225KE11# |                    |                    |          |                    |      |
|        |               |         |       | ±20% | GRM188C71C225ME11# |                    |                    |          |                    |      |
|        |               |         |       | X6S  | 10μF               | ±20%               | GRM188C81C106MA73# |          |                    |      |
|        |               | 10Vdc   | X7T   | 10μF | ±20%               | GRM188D71A106MA73# |                    |          |                    |      |
|        |               |         |       |      | 6.3Vdc             | X7T                | 10μF               | ±20%     | GRM188D70J106MA73# |      |
|        |               |         |       |      |                    |                    |                    | X5R      | 22μF               | ±20% |
|        | 4Vdc          | X6S     | 22μF  | ±20% | GRM188C80G226MEA0# | Derating           |                    |          |                    |      |
|        |               |         |       | X5R  | 22μF               | ±20%               | GRM188R60G226MEA0# |          |                    |      |
|        |               |         |       | B    | 22μF               | ±20%               | GRM188B30G226MEA0# | Derating |                    |      |

■ 2.0x1.25mm

| T max. | Rated Voltage      | TC Code | Cap.               | Tol.               | Part Number        |                    |
|--------|--------------------|---------|--------------------|--------------------|--------------------|--------------------|
| 0.7mm  | 16Vdc              | X6S     | 1.0μF              | ±10%               | GRM216C81C105KA12# |                    |
| 0.95mm | 100Vdc             | X7R     | 10000pF            | ±10%               | GRM219R72A103KA01# |                    |
|        |                    |         |                    | ±20%               | GRM219R72A103MA01# |                    |
|        |                    |         |                    | X7R                | 10000pF            | ±10%               |
|        |                    | ±20%    | GRM219R71H103MA01# |                    |                    |                    |
|        |                    | 15000pF | ±10%               |                    |                    | GRM219R71H153KA01# |
|        |                    |         |                    | ±20%               | GRM219R71H153MA01# |                    |
|        | 33000pF            |         |                    | ±10%               | GRM219R71H333KA01# |                    |
|        |                    | 0.33μF  | ±10%               |                    | GRM219R71H334KA88# |                    |
|        |                    |         |                    |                    | R                  | 33000pF            |
|        | X5R                | 1.0μF   | ±10%               | GRM219R61H105KA73# |                    |                    |
|        |                    |         | ±20%               | GRM219R61H105MA73# |                    |                    |
|        |                    |         | 2.2μF              | ±10%               | GRM219R61H225KE15# |                    |
| ±20%   | GRM219R61H225ME15# |         |                    |                    |                    |                    |

| T max. | Rated Voltage | TC Code            | Cap.               | Tol.               | Part Number        |                    |                    |                    |                    |
|--------|---------------|--------------------|--------------------|--------------------|--------------------|--------------------|--------------------|--------------------|--------------------|
| 0.95mm | 50Vdc         | B                  | 0.33μF             | ±10%               | GRM219B31H334KA87# |                    |                    |                    |                    |
|        |               |                    |                    | ±20%               | GRM219B31H334MA87# |                    |                    |                    |                    |
|        |               |                    |                    | 1.0μF              | ±10%               | GRM219B31H105KA73# |                    |                    |                    |
|        |               |                    | ±20%               |                    | GRM219B31H105MA73# |                    |                    |                    |                    |
|        |               |                    | 2.2μF              |                    | ±10%               | GRM219B31H225KE15# |                    |                    |                    |
|        |               |                    |                    | ±20%               | GRM219B31H225ME15# |                    |                    |                    |                    |
|        |               | 35Vdc              |                    | X6S                | 2.2μF              | ±10%               | GRM219C8YA225KE15# |                    |                    |
|        |               |                    | ±20%               |                    |                    | GRM219C8YA225ME15# |                    |                    |                    |
|        |               |                    | X5R                |                    |                    | 4.7μF              | ±10%               | GRM219R6YA475KA73# | Derating           |
|        |               |                    |                    | ±20%               | GRM219R6YA475MA73# |                    | Derating           |                    |                    |
|        |               |                    |                    | 25Vdc              | X7R                |                    | 0.10μF             | ±10%               | GRM219R71E104KA01# |
|        |               |                    | ±20%               |                    |                    | GRM219R71E104MA01# |                    |                    |                    |
|        | R             | 6800pF             | ±10%               |                    |                    | GRM219R11E683KA01# |                    |                    |                    |
|        |               |                    | X6S                |                    | 2.2μF              | ±10%               | GRM219C81E225KE15# |                    |                    |
|        |               |                    |                    |                    |                    | ±20%               | GRM219C81E225ME15# |                    |                    |
|        | X5R           | 2.2μF              | ±10%               |                    | GRM219R61E225KA12# |                    |                    |                    |                    |
|        |               |                    | ±20%               | GRM219R61E225MA12# |                    |                    |                    |                    |                    |
|        |               |                    | 4.7μF              | ±10%               | GRM219R61E475KA73# |                    |                    |                    |                    |
|        | ±20%          | GRM219R61E475MA73# |                    |                    |                    |                    |                    |                    |                    |
|        | 10μF          | ±10%               |                    |                    | GRM219R61E106KA12# | Derating           |                    |                    |                    |
|        |               |                    | ±20%               | GRM219R61E106MA12# | Derating           |                    |                    |                    |                    |
|        |               |                    | B                  | 2.2μF              | ±10%               | GRM219B31E225KA75# |                    |                    |                    |
|        | ±20%          | GRM219B31E225MA75# |                    |                    |                    |                    |                    |                    |                    |
|        | 10μF          | ±10%               |                    |                    | GRM219B31E106KA12# | Derating           |                    |                    |                    |
|        |               |                    | ±20%               | GRM219B31E106MA12# | Derating           |                    |                    |                    |                    |
|        |               |                    | 16Vdc              | X7R                | 0.33μF             | ±10%               | GRM219R71C334KA88# |                    |                    |
|        | ±20%          | GRM219R71C225KE15# |                    |                    |                    |                    |                    |                    |                    |
|        | ±20%          | GRM219R71C225ME15# |                    |                    |                    |                    |                    |                    |                    |
|        | R             | 0.68μF             |                    |                    | ±10%               | GRM219R11C684KA01# |                    |                    |                    |
|        |               |                    |                    |                    | X6S                | 4.7μF              | ±10%               | GRM219C81C475KA73# |                    |
|        |               |                    |                    |                    |                    |                    | ±20%               | GRM219C81C475MA73# |                    |
|        | X5R           | 4.7μF              |                    | ±10%               | GRM219R61C475KE15# |                    |                    |                    |                    |
|        |               |                    |                    | 10μF               | ±10%               | GRM219R61C106KA73# |                    |                    |                    |
|        |               |                    |                    |                    |                    | ±20%               | GRM219R61C106MA73# |                    |                    |
|        | B             | 4.7μF              |                    | ±10%               | GRM219B31C475KE15# |                    |                    |                    |                    |
|        |               |                    |                    | 10μF               | ±10%               | GRM219B31C106KA73# |                    |                    |                    |
|        |               |                    |                    |                    |                    | ±20%               | GRM219B31C106MA73# |                    |                    |
|        | 10Vdc         | X7R                | 2.2μF              | ±10%               | GRM219R71A225KE15# |                    |                    |                    |                    |
|        |               |                    |                    | ±20%               | GRM219R71A225ME15# |                    |                    |                    |                    |
|        |               |                    |                    | X7T                | 4.7μF              | ±10%               | GRM219D71A475KE15# | Derating           |                    |
|        |               |                    | ±20%               |                    |                    | GRM219D71A475ME15# | Derating           |                    |                    |
|        |               |                    | X5R                |                    |                    | 22μF               | ±20%               | GRM219R61A226MEA0# | Derating           |
|        |               |                    |                    | B                  | 22μF               |                    | ±20%               | GRM219B31A226MEA0# | Derating           |
|        |               | 6.3Vdc             |                    |                    |                    |                    | X6S                | 10μF               | ±10%               |
|        |               |                    | ±20%               | GRM219C80J106ME39# |                    |                    |                    |                    |                    |
|        |               |                    | X5R                | 22μF               | ±20%               | GRM219R60J226ME47# |                    |                    | Derating           |
|        |               |                    |                    |                    | B                  | 22μF               | ±20%               | GRM219B30J226ME47# | Derating           |
|        |               |                    |                    |                    |                    |                    | 4Vdc               | X6S                | 10μF               |
| ±20%   |               |                    | GRM219C80G106ME19# |                    |                    |                    |                    |                    |                    |
| X5R    | 47μF          | ±20%               | GRM219R60G476ME44# | Derating           |                    |                    |                    |                    |                    |
|        |               | 2.5Vdc             | X6T                | 47μF               | ±20%               | GRM219D80E476ME44# |                    |                    |                    |
|        |               |                    |                    |                    | 1.0mm              | 250Vdc             | X7R                | 1000pF             | ±10%               |

Part number # indicates the package specification code.

## GRM Series High Dielectric Constant Type Part Number List

(→ ■ 2.0x1.25mm)

| T max.  | Rated Voltage | TC Code | Cap.    | Tol.               | Part Number        |                    |                    |  |
|---------|---------------|---------|---------|--------------------|--------------------|--------------------|--------------------|--|
| 1.0mm   | 250Vdc        | X7R     | 1500pF  | ±10%               | GRM21AR72E152KW01# |                    |                    |  |
|         |               |         | 2200pF  | ±10%               | GRM21AR72E222KW01# |                    |                    |  |
|         |               |         | 3300pF  | ±10%               | GRM21AR72E332KW01# |                    |                    |  |
|         |               |         | 4700pF  | ±10%               | GRM21AR72E472KW01# |                    |                    |  |
|         |               |         | 6800pF  | ±10%               | GRM21AR72E682KW01# |                    |                    |  |
|         | 200Vdc        | X7R     | 1000pF  | ±10%               | GRM21AR72D102KW01# |                    |                    |  |
|         |               |         | 1500pF  | ±10%               | GRM21AR72D152KW01# |                    |                    |  |
|         |               |         | 2200pF  | ±10%               | GRM21AR72D222KW01# |                    |                    |  |
|         |               |         | 3300pF  | ±10%               | GRM21AR72D332KW01# |                    |                    |  |
|         |               |         | 4700pF  | ±10%               | GRM21AR72D472KW01# |                    |                    |  |
|         | 100Vdc        | X7R     | 0.22μF  | ±10%               | GRM21AR72A224KAC5# |                    |                    |  |
|         |               |         | 0.33μF  | ±10%               | GRM21AR72A334KAC5# |                    |                    |  |
|         | 50Vdc         | X7R     | 22000pF | ±10%               | GRM219R71H223KA17# |                    |                    |  |
|         |               |         |         | ±20%               | GRM219R71H223MA17# |                    |                    |  |
|         | 35Vdc         | X6S     | 4.7μF   | ±10%               | GRM219C8YA475KE21# | Derating           |                    |  |
|         |               |         |         | ±20%               | GRM219C8YA475ME21# | Derating           |                    |  |
|         | 25Vdc         | X7S     | 4.7μF   | ±10%               | GRM219C71E475KE21# | Derating           |                    |  |
|         |               |         |         | ±20%               | GRM219C71E475ME21# | Derating           |                    |  |
|         |               | X6S     | 4.7μF   | ±10%               | GRM219C81E475KE21# | Derating           |                    |  |
|         |               |         |         | ±20%               | GRM219C81E475ME21# | Derating           |                    |  |
|         | 16Vdc         | X7S     | 4.7μF   | ±10%               | GRM219C71C475KE21# |                    |                    |  |
|         |               |         |         | ±20%               | GRM219C71C475ME21# |                    |                    |  |
|         |               | X5R     | 22μF    | ±20%               | GRM219R61C226ME15# | Derating           |                    |  |
|         | 1.35mm        | 100Vdc  | X7R     | 10000pF            | ±10%               | GRM21BR72A103KA01# |                    |  |
| 15000pF |               |         |         | ±10%               | GRM21BR72A153KA01# |                    |                    |  |
| 22000pF |               |         |         | ±10%               | GRM21BR72A223KA01# |                    |                    |  |
| 33000pF |               |         |         | ±10%               | GRM21BR72A333KA01# |                    |                    |  |
| 47000pF |               |         |         | ±10%               | GRM21BR72A473KA01# |                    |                    |  |
| 68000pF |               |         |         | ±10%               | GRM21BR72A683KAC4# |                    |                    |  |
|         |               |         |         | ±20%               | GRM21BR72A683MAC4# |                    |                    |  |
| 0.10μF  |               |         |         | ±10%               | GRM21BR72A104KAC4# |                    |                    |  |
|         |               |         |         | ±20%               | GRM21BR72A104MAC4# |                    |                    |  |
| 50Vdc   |               |         |         | X7R                | 47000pF            | ±10%               | GRM21BR71H473KA01# |  |
|         |               |         |         |                    | 68000pF            | ±10%               | GRM21BR71H683KA01# |  |
|         |               |         |         |                    | 0.10μF             | ±10%               | GRM21BR71H104KA01# |  |
|         |               |         |         |                    |                    | ±20%               | GRM21BR71H104MA01# |  |
|         |               |         |         |                    | 0.15μF             | ±10%               | GRM21BR71H154KA01# |  |
|         |               |         |         |                    |                    | ±20%               | GRM21BR71H154MA01# |  |
| R       |               | 0.10μF  | ±10%    | GRM21BR11H104KA01# |                    |                    |                    |  |
|         |               |         | ±20%    | GRM21BR11H104MA01# |                    |                    |                    |  |
| X5R     |               | 1.0μF   | ±10%    | GRM21BR61H105KA12# |                    |                    |                    |  |
|         |               |         | ±20%    | GRM21BR61H105MA12# |                    |                    |                    |  |
| B       |               | 0.15μF  | ±10%    | GRM21BB31H154KA88# |                    |                    |                    |  |
|         |               |         | ±20%    | GRM21BB31H154MA88# |                    |                    |                    |  |
|         |               |         | 0.22μF  | ±10%               | GRM21BB31H224KA88# |                    |                    |  |
|         |               |         |         | ±20%               | GRM21BB31H224MA88# |                    |                    |  |
|         |               |         | 0.47μF  | ±10%               | GRM21BB31H474KA87# |                    |                    |  |
|         |               | ±20%    |         | GRM21BB31H474MA87# |                    |                    |                    |  |
|         |               | 0.68μF  | ±10%    | GRM21BB31H684KAC4# |                    |                    |                    |  |
|         |               |         | ±20%    | GRM21BB31H684MAC4# |                    |                    |                    |  |
|         |               | 1.0μF   | ±10%    | GRM21BB31H105KA12# |                    |                    |                    |  |
|         |               |         | ±20%    | GRM21BB31H105MA12# |                    |                    |                    |  |
| 25Vdc   |               | R       | 0.15μF  | ±10%               | GRM21BR11E154KA01# |                    |                    |  |

| T max.  | Rated Voltage      | TC Code            | Cap.               | Tol.               | Part Number        |                    |                    |       |                    |                    |  |
|---------|--------------------|--------------------|--------------------|--------------------|--------------------|--------------------|--------------------|-------|--------------------|--------------------|--|
| 1.35mm  | 25Vdc              | R                  | 0.15μF             | ±20%               | GRM21BR11E154MA01# |                    |                    |       |                    |                    |  |
|         |                    |                    | X6S                | 4.7μF              | ±10%               | GRM21BC81E475KA12# |                    |       |                    |                    |  |
|         |                    |                    |                    |                    | ±20%               | GRM21BC81E475MA12# |                    |       |                    |                    |  |
|         |                    | X5R                | 4.7μF              | ±10%               | GRM21BR61E475KA12# |                    |                    |       |                    |                    |  |
|         |                    |                    |                    | ±20%               | GRM21BR61E475MA12# |                    |                    |       |                    |                    |  |
|         |                    |                    |                    | B                  | 2.2μF              | ±10%               | GRM21BB31E225KA75# |       |                    |                    |  |
|         |                    | ±20%               | GRM21BB31E225MA75# |                    |                    |                    |                    |       |                    |                    |  |
|         |                    | 4.7μF              | ±10%               |                    |                    | GRM21BB31E475KA75# |                    |       |                    |                    |  |
|         |                    |                    | ±20%               | GRM21BB31E475MA75# |                    |                    |                    |       |                    |                    |  |
|         | 16Vdc              | X7R                | 2.2μF              | ±10%               | GRM21BR71C225KA12# |                    |                    |       |                    |                    |  |
|         |                    |                    |                    | ±20%               | GRM21BR71C225MA12# |                    |                    |       |                    |                    |  |
|         |                    |                    |                    | X5R                | 10μF               | ±10%               | GRM21BR61C106KE15# |       |                    |                    |  |
|         |                    | ±20%               | GRM21BR61C106ME15# |                    |                    |                    |                    |       |                    |                    |  |
|         |                    | B                  | 10μF               |                    |                    | ±10%               | GRM21BB31C106KE15# |       |                    |                    |  |
|         |                    |                    |                    | ±20%               | GRM21BB31C106ME15# |                    |                    |       |                    |                    |  |
|         |                    |                    |                    | 1.4mm              | 100Vdc             | X7R                | 0.47μF             | ±10%  | GRM21BR72A474KA73# |                    |  |
|         |                    | 50Vdc              | X5R                |                    |                    |                    |                    | 2.2μF | ±10%               | GRM21BR61H225KA73# |  |
|         |                    |                    |                    |                    |                    |                    |                    |       | ±20%               | GRM21BR61H225MA73# |  |
| B       | 2.2μF              | ±10%               | GRM21BR61H475KE51# |                    |                    |                    |                    |       |                    |                    |  |
|         |                    | ±20%               | GRM21BR61H475ME51# |                    |                    |                    |                    |       |                    |                    |  |
|         |                    | 4.7μF              | ±10%               |                    | GRM21BB31H225KA73# |                    |                    |       |                    |                    |  |
| ±20%    | GRM21BB31H225MA73# |                    |                    |                    |                    |                    |                    |       |                    |                    |  |
| ±10%    | GRM21BB31H475KE51# |                    |                    |                    |                    |                    |                    |       |                    |                    |  |
| ±20%    | GRM21BB31H475ME51# |                    |                    |                    |                    |                    |                    |       |                    |                    |  |
| 25Vdc   | X7R                | 1.0μF              | ±10%               | GRM21BR71E105KA99# |                    |                    |                    |       |                    |                    |  |
|         |                    |                    | ±20%               | GRM21BR71E225KE11# |                    |                    |                    |       |                    |                    |  |
|         |                    |                    | ±20%               | GRM21BR71E225ME11# |                    |                    |                    |       |                    |                    |  |
|         |                    | 4.7μF              | ±10%               | GRM21BR71E475KA73# | Derating           |                    |                    |       |                    |                    |  |
|         |                    |                    | ±20%               | GRM21BR71E475MA73# | Derating           |                    |                    |       |                    |                    |  |
|         |                    |                    | R                  | 1.0μF              | ±10%               | GRM21BR11E105KA99# |                    |       |                    |                    |  |
|         | X5R                | 10μF               | ±10%               | GRM21BR61E106KA73# |                    |                    |                    |       |                    |                    |  |
|         |                    |                    | ±20%               | GRM21BR61E106MA73# |                    |                    |                    |       |                    |                    |  |
|         |                    |                    | B                  | 10μF               | ±10%               | GRM21BB31E106KA73# |                    |       |                    |                    |  |
|         | ±20%               | GRM21BB31E106MA73# |                    |                    |                    |                    |                    |       |                    |                    |  |
|         | 16Vdc              | X7R                |                    |                    | 4.7μF              | ±10%               | GRM21BR71C475KA73# |       |                    |                    |  |
|         |                    |                    | ±20%               | GRM21BR71C475MA73# |                    |                    |                    |       |                    |                    |  |
| X6S     |                    |                    | 10μF               | ±10%               |                    | GRM21BC81C106KA73# |                    |       |                    |                    |  |
|         |                    | ±20%               |                    | GRM21BC81C106MA73# |                    |                    |                    |       |                    |                    |  |
|         |                    | 10Vdc              |                    | X7R                | 4.7μF              | ±10%               | GRM21BR71A475KA73# |       |                    |                    |  |
| ±20%    |                    |                    | GRM21BR71A475MA73# |                    |                    |                    |                    |       |                    |                    |  |
| 10μF    | ±10%               |                    | GRM21BR71A106KE51# |                    |                    |                    |                    |       |                    |                    |  |
|         | ±20%               |                    | GRM21BR71A106ME51# |                    |                    |                    |                    |       |                    |                    |  |
|         | B                  |                    | 22μF               | ±20%               | GRM21BB31A226ME51# | Derating           |                    |       |                    |                    |  |
| 6.3Vdc  |                    |                    |                    | X7R                | 10μF               | ±10%               | GRM21BR70J106KE76# |       |                    |                    |  |
|         |                    | ±20%               |                    |                    |                    | GRM21BR70J106ME76# |                    |       |                    |                    |  |
| X6S     | 22μF               | ±20%               | GRM21BC80J226ME51# | Derating           |                    |                    |                    |       |                    |                    |  |
|         |                    | 4Vdc               | X7U                | 22μF               | ±20%               | GRM21BE70G226ME51# |                    |       |                    |                    |  |
| X6S     | 22μF               |                    |                    |                    | ±20%               | GRM21BC80G226ME39# |                    |       |                    |                    |  |
|         |                    | 1.45mm             | 250Vdc             | X7R                | 10000pF            | ±10%               | GRM21BR72E103KW03# |       |                    |                    |  |
| 15000pF | ±10%               |                    |                    |                    | GRM21BR72E153KW03# |                    |                    |       |                    |                    |  |
| 22000pF | ±10%               |                    |                    |                    | GRM21BR72E223KW03# |                    |                    |       |                    |                    |  |
| 200Vdc  | X7R                |                    | 10000pF            | ±10%               | GRM21BR72D103KW03# |                    |                    |       |                    |                    |  |
|         |                    |                    | 15000pF            | ±10%               | GRM21BR72D153KW03# |                    |                    |       |                    |                    |  |
|         |                    |                    | 22000pF            | ±10%               | GRM21BR72D223KW03# |                    |                    |       |                    |                    |  |

Part number # indicates the package specification code.

GRM Series  
GJM Series  
GMA Series  
GMD Series  
GQM Series  
GRJ Series  
GR3 Series  
KRM Series  
KR3 Series  
LLA Series  
LLL Series  
LLM Series  
LLR Series  
⚠Caution/Notice

# GRM Series High Dielectric Constant Type Part Number List

(→ ■ 2.0x1.25mm)

| T max. | Rated Voltage | TC Code            | Cap.               | Tol.               | Part Number        |                    |                    |
|--------|---------------|--------------------|--------------------|--------------------|--------------------|--------------------|--------------------|
| 1.45mm | 50Vdc         | X7S                | 4.7μF              | ±10%               | GRM21BC71H475KE11# |                    |                    |
|        |               |                    |                    | ±20%               | GRM21BC71H475ME11# |                    |                    |
|        |               | X6S                | 4.7μF              | ±10%               | GRM21BC81H475KE11# |                    |                    |
|        |               |                    |                    | ±20%               | GRM21BC81H475ME11# |                    |                    |
|        |               | 35Vdc              | X7S                | 4.7μF              | ±10%               | GRM21BC7YA475KE11# |                    |
|        |               |                    |                    |                    | ±20%               | GRM21BC7YA475ME11# |                    |
|        | X6S           |                    | 10μF               | ±10%               | GRM21BC8YA106KE11# | Derating           |                    |
|        |               |                    |                    | ±20%               | GRM21BC8YA106ME11# | Derating           |                    |
|        | X5R           |                    | 10μF               | ±10%               | GRM21BR6YA106KE43# | Derating           |                    |
|        |               |                    |                    | ±20%               | GRM21BR6YA106ME43# | Derating           |                    |
|        | 25Vdc         | X7S                | 4.7μF              | ±10%               | GRM21BC71E475KE11# |                    |                    |
|        |               |                    |                    | ±20%               | GRM21BC71E475ME11# |                    |                    |
|        |               | 10μF               | ±10%               | GRM21BC71E106KE11# | Derating           |                    |                    |
|        |               |                    | ±20%               | GRM21BC71E106ME11# | Derating           |                    |                    |
|        |               | X6S                | 10μF               | ±10%               | GRM21BC81E106KE11# | Derating           |                    |
|        |               |                    |                    | ±20%               | GRM21BC81E106ME11# | Derating           |                    |
|        | X5R           | 22μF               | ±20%               | GRM21BR61E226ME44# |                    |                    |                    |
|        |               |                    | 16Vdc              | X7S                | 10μF               | ±10%               | GRM21BC71C106KE11# |
|        | ±20%          | GRM21BC71C106ME11# |                    |                    |                    |                    |                    |
|        | X6S           | 22μF               | ±20%               | GRM21BC81C226ME44# | Derating           |                    |                    |
|        |               |                    | X5R                | 22μF               | ±20%               | GRM21BR61C226ME44# |                    |
|        | 10Vdc         | X7T                |                    |                    | 22μF               | ±20%               | GRM21BD71A226ME44# |
|        |               |                    | X6S                | 22μF               |                    | ±20%               | GRM21BC81A226ME44# |
|        |               | X5R                |                    |                    | 22μF               | ±20%               | GRM21BR61A226ME44# |
| 47μF   | ±20%          |                    | GRM21BR61A476ME15# | Derating           |                    |                    |                    |
|        | 6.3Vdc        | X7T                | 22μF               | ±20%               | GRM21BD70J226ME44# |                    |                    |
| X5R    |               |                    |                    | 47μF               | ±20%               | GRM21BR60J476ME15# | Derating           |
|        |               | B                  | 47μF               |                    | ±20%               | GRM21BB30J476ME15# | Derating           |
| 4Vdc   | X6S           | 47μF               | ±20%               | GRM21BC80G476ME15# | Derating           |                    |                    |
|        |               |                    | X5R                | 47μF               | ±20%               | GRM21BR60G476ME15# |                    |
|        | B             | 47μF               |                    |                    | ±20%               | GRM21BB30G476ME15# |                    |

■ 3.2x1.6mm

| T max. | Rated Voltage | TC Code            | Cap.               | Tol.               | Part Number        |                    |                    |
|--------|---------------|--------------------|--------------------|--------------------|--------------------|--------------------|--------------------|
| 0.95mm | 35Vdc         | X5R                | 10μF               | ±10%               | GRM319R6YA106KA12# | Derating           |                    |
|        |               |                    |                    | ±20%               | GRM319R6YA106MA12# | Derating           |                    |
|        | 25Vdc         | R                  | 0.33μF             | ±10%               | GRM319R11E334KA01# |                    |                    |
|        |               |                    |                    | 16Vdc              | X5R                | 10μF               | ±10%               |
|        | ±20%          | GRM319R61C106ME15# |                    |                    |                    |                    |                    |
|        | 22μF          | ±20%               | GRM319R61C226ME15# | Derating           |                    |                    |                    |
|        |               | B                  | 10μF               | ±10%               | GRM319B31C106KE15# |                    |                    |
|        | ±20%          |                    |                    | GRM319B31C106ME15# |                    |                    |                    |
|        | 22μF          | ±20%               | GRM319B31C226ME15# | Derating           |                    |                    |                    |
|        |               | 10Vdc              | X5R                | 22μF               | ±20%               | GRM319R61A226ME15# |                    |
|        | B             |                    |                    |                    | 22μF               | ±20%               | GRM319B31A226ME15# |
|        |               | 6.3Vdc             | X6S                | 22μF               |                    | ±20%               | GRM319C80J226ME15# |
|        | X5R           |                    |                    |                    | 22μF               | ±20%               | GRM319R60J226ME15# |
|        |               |                    | B                  | 22μF               |                    | ±20%               | GRM319B30J226ME15# |
|        | 1.0mm         | 630Vdc             | X7R                | 1000pF             | ±10%               | GRM31AR72J102KW01# |                    |
|        |               |                    |                    |                    | ±10%               | GRM31AR72J152KW01# |                    |
|        |               |                    |                    |                    | ±10%               | GRM31AR72J222KW01# |                    |
|        |               |                    |                    |                    | ±10%               | GRM31AR72J332KW01# |                    |

| T max.  | Rated Voltage      | TC Code            | Cap.               | Tol.               | Part Number        |                    |         |                    |                    |                    |      |                    |
|---------|--------------------|--------------------|--------------------|--------------------|--------------------|--------------------|---------|--------------------|--------------------|--------------------|------|--------------------|
| 1.0mm   | 630Vdc             | X7R                | 4700pF             | ±10%               | GRM31AR72J472KW01# |                    |         |                    |                    |                    |      |                    |
|         |                    |                    | 6800pF             | ±10%               | GRM31AR72J682KW01# |                    |         |                    |                    |                    |      |                    |
|         |                    |                    | 10000pF            | ±10%               | GRM31AR72J103KW01# |                    |         |                    |                    |                    |      |                    |
| 1.25mm  | 1000Vdc            | X7R                | 470pF              | ±10%               | GRM31BR73A471KW01# |                    |         |                    |                    |                    |      |                    |
|         |                    |                    | 680pF              | ±10%               | GRM31BR73A681KW01# |                    |         |                    |                    |                    |      |                    |
|         |                    |                    | 1000pF             | ±10%               | GRM31BR73A102KW01# |                    |         |                    |                    |                    |      |                    |
|         |                    |                    | 1500pF             | ±10%               | GRM31BR73A152KW01# |                    |         |                    |                    |                    |      |                    |
|         |                    |                    | 2200pF             | ±10%               | GRM31BR73A222KW01# |                    |         |                    |                    |                    |      |                    |
|         |                    |                    | 3300pF             | ±10%               | GRM31BR73A332KW01# |                    |         |                    |                    |                    |      |                    |
|         | 630Vdc             | X7R                | 6800pF             | ±10%               | GRM31BR72E153KW01# |                    |         |                    |                    |                    |      |                    |
|         |                    |                    |                    | 250Vdc             | X7R                | 15000pF            | ±10%    | GRM31BR72E153KW01# |                    |                    |      |                    |
|         |                    |                    |                    |                    |                    |                    | 22000pF | ±10%               | GRM31BR72E223KW01# |                    |      |                    |
|         |                    |                    |                    |                    |                    |                    |         | 68000pF            | ±10%               | GRM31BR72E683KW01# |      |                    |
|         |                    |                    |                    |                    |                    |                    | 200Vdc  |                    | X7R                | 15000pF            | ±10% | GRM31BR72D153KW01# |
|         |                    |                    |                    |                    |                    |                    |         | 22000pF            |                    |                    | ±10% | GRM31BR72D223KW01# |
| 68000pF | ±10%               | GRM31BR72D683KW01# |                    |                    |                    |                    |         |                    |                    |                    |      |                    |
| 50Vdc   | X7R                | 0.47μF             | ±10%               | GRM31MR71H474KA01# |                    |                    |         |                    |                    |                    |      |                    |
|         |                    |                    | 0.68μF             | ±10%               | GRM31MR71H684KA88# |                    |         |                    |                    |                    |      |                    |
|         |                    |                    |                    | 1.0μF              | ±10%               | GRM31MR71H105KA88# |         |                    |                    |                    |      |                    |
| B       | 1.0μF              | ±10%               | GRM31MB31H105KA87# |                    |                    |                    |         |                    |                    |                    |      |                    |
|         |                    | 25Vdc              | X5R                | 10μF               | ±20%               | GRM31MR61E106MA12# |         |                    |                    |                    |      |                    |
|         |                    |                    |                    |                    | 1.3mm              | 100Vdc             | X7R     | 0.47μF             | ±10%               | GRM31MR72A474KA35# |      |                    |
| ±20%    | GRM31MR72A474MA35# |                    |                    |                    |                    |                    |         |                    |                    |                    |      |                    |
| 0.68μF  | ±10%               | GRM31MR72A684KA35# |                    |                    |                    |                    |         |                    |                    |                    |      |                    |
| 1.8mm   | 1000Vdc            | X7R                | 6800pF             | ±10%               | GRM31CR73A682KW03# |                    |         |                    |                    |                    |      |                    |
|         |                    |                    |                    | ±10%               | GRM31CR73A103KW03# |                    |         |                    |                    |                    |      |                    |
|         | 630Vdc             | X7R                | 15000pF            | ±10%               | GRM31CR72J153KW03# |                    |         |                    |                    |                    |      |                    |
|         |                    |                    |                    | ±10%               | GRM31CR72J223KW03# |                    |         |                    |                    |                    |      |                    |
|         | 250Vdc             | X7R                | 33000pF            | ±10%               | GRM31CR72E333KW03# |                    |         |                    |                    |                    |      |                    |
|         |                    |                    |                    | ±10%               | GRM31CR72E473KW03# |                    |         |                    |                    |                    |      |                    |
|         |                    |                    |                    | ±10%               | GRM31CR72E104KW03# |                    |         |                    |                    |                    |      |                    |
|         |                    |                    |                    | ±10%               | GRM31CR72D333KW03# |                    |         |                    |                    |                    |      |                    |
|         | 47000pF            | ±10%               | GRM31CR72D473KW03# |                    |                    |                    |         |                    |                    |                    |      |                    |
|         |                    | 0.10μF             | ±10%               | GRM31CR72D104KW03# |                    |                    |         |                    |                    |                    |      |                    |
|         | 100Vdc             | X7R                | 1.0μF              | ±10%               | GRM31CR72A105KA01# |                    |         |                    |                    |                    |      |                    |
|         |                    |                    |                    | 50Vdc              | X7R                | 2.2μF              | ±10%    | GRM31CR71H225KA88# |                    |                    |      |                    |
| 4.7μF   | ±10%               | GRM31CR71H475KA12# |                    |                    |                    |                    |         |                    |                    |                    |      |                    |
|         | ±20%               | GRM31CR71H475MA12# |                    |                    |                    |                    |         |                    |                    |                    |      |                    |
| X5R     | 10μF               | ±10%               | GRM31CR61H106KA12# |                    |                    |                    |         |                    |                    |                    |      |                    |
|         |                    | ±20%               | GRM31CR61H106MA12# |                    |                    |                    |         |                    |                    |                    |      |                    |
| B       | 2.2μF              | ±10%               | GRM31CB31H225KA87# |                    |                    |                    |         |                    |                    |                    |      |                    |
|         |                    | ±20%               | GRM31CB31H225MA87# |                    |                    |                    |         |                    |                    |                    |      |                    |
| 4.7μF   | ±10%               | GRM31CB31H475KA12# |                    |                    |                    |                    |         |                    |                    |                    |      |                    |
|         | ±20%               | GRM31CB31H475MA12# |                    |                    |                    |                    |         |                    |                    |                    |      |                    |
| 10μF    | ±10%               | GRM31CB31H106KA12# |                    |                    |                    |                    |         |                    |                    |                    |      |                    |
|         | ±20%               | GRM31CB31H106MA12# |                    |                    |                    |                    |         |                    |                    |                    |      |                    |
| 25Vdc   | X7R                | 4.7μF              | ±10%               | GRM31CR71E475KA88# |                    |                    |         |                    |                    |                    |      |                    |
|         |                    |                    | 10μF               | ±10%               | GRM31CR71E106KA12# |                    |         |                    |                    |                    |      |                    |
|         |                    |                    |                    | ±20%               | GRM31CR71E106MA12# |                    |         |                    |                    |                    |      |                    |
| X5R     | 22μF               | ±20%               | GRM31CR61E226ME15# |                    |                    |                    |         |                    |                    |                    |      |                    |
|         |                    | B                  | 10μF               | ±10%               | GRM31CB31E106KA75# |                    |         |                    |                    |                    |      |                    |
| ±20%    | GRM31CB31E226ME15# |                    |                    |                    |                    |                    |         |                    |                    |                    |      |                    |
| 16Vdc   | X7R                | 4.7μF              | ±20%               | GRM31CR71C475MA01# |                    |                    |         |                    |                    |                    |      |                    |

Part number # indicates the package specification code.

## GRM Series High Dielectric Constant Type Part Number List

(→ ■ 3.2x1.6mm)

| T max. | Rated Voltage | TC Code | Cap.  | Tol.               | Part Number        |                    |
|--------|---------------|---------|-------|--------------------|--------------------|--------------------|
| 1.8mm  | 16Vdc         | X6S     | 22μF  | ±20%               | GRM31CC81C226ME15# |                    |
|        |               | X5R     | 22μF  | ±20%               | GRM31CR61C226ME15# |                    |
|        |               | B       | 22μF  | ±20%               | GRM31CB31C226ME15# |                    |
|        | 10Vdc         | X7R     | 22μF  | ±20%               | GRM31CR71A226ME15# |                    |
|        |               | X5R     | 47μF  | ±20%               | GRM31CR61A476ME15# |                    |
|        |               | B       | 47μF  | ±20%               | GRM31CB31A476ME15# |                    |
|        | 6.3Vdc        | X7R     | 22μF  | ±20%               | GRM31CR70J226ME19# |                    |
|        |               | X7U     | 47μF  | ±20%               | GRM31CE70J476ME15# | Derating           |
|        |               | X6S     | 47μF  | ±20%               | GRM31CC80J476ME18# |                    |
|        |               | X5R     | 47μF  | ±20%               | GRM31CR60J476ME19# |                    |
|        |               | B       | 47μF  | ±20%               | GRM31CB30J476ME18# |                    |
|        | 4Vdc          | X7U     | 47μF  | ±20%               | GRM31CE70G476ME15# |                    |
| X6S    |               | 47μF    | ±20%  | GRM31CC80G476ME19# |                    |                    |
| 1.9mm  | 100Vdc        | X7R     | 2.2μF | ±10%               | GRM31CR72A225KA73# |                    |
|        |               |         | ±20%  | GRM31CR72A225MA73# |                    |                    |
|        | 25Vdc         | X6S     | 22μF  | ±20%               | GRM31CC81E226ME11# |                    |
|        | 16Vdc         | X7S     | 22μF  | ±20%               | GRM31CC71C226ME11# |                    |
|        | 6.3Vdc        | X6T     | 100μF | ±20%               | GRM31CD80J107ME39# | Derating           |
|        |               |         | X5R   | 100μF              | ±20%               | GRM31CR60J107ME39# |
|        | 4Vdc          | X7U     | 100μF | ±20%               | GRM31CE70G107ME39# | Derating           |
|        |               |         | X6T   | 100μF              | ±20%               | GRM31CD80G107ME39# |
|        |               | X5R     | 100μF | ±20%               | GRM31CR60G107ME39# |                    |
|        |               |         | 220μF | ±20%               | GRM31CR60G227ME11# | Derating           |

■ 3.2x2.5mm

| T max. | Rated Voltage | TC Code | Cap.    | Tol.               | Part Number        |          |
|--------|---------------|---------|---------|--------------------|--------------------|----------|
| 1.5mm  | 1000Vdc       | X7R     | 6800pF  | ±10%               | GRM32QR73A682KW01# |          |
|        |               |         | 10000pF | ±10%               | GRM32QR73A103KW01# |          |
|        | 630Vdc        | X7R     | 22000pF | ±10%               | GRM32QR72J223KW01# |          |
|        | 250Vdc        | X7R     | 68000pF | ±10%               | GRM32QR72E683KW01# |          |
|        |               |         | 0.15μF  | ±10%               | GRM32QR72E154KW01# |          |
|        | 200Vdc        | X7R     | 68000pF | ±10%               | GRM32QR72D683KW01# |          |
| 0.15μF |               |         | ±10%    | GRM32QR72D154KW01# |                    |          |
| 1.8mm  | 100Vdc        | X7R     | 1.0μF   | ±10%               | GRM32CR72A105KA35# |          |
|        |               |         |         | ±20%               | GRM32CR72A105MA35# |          |
| 2.0mm  | 1000Vdc       | X7R     | 15000pF | ±10%               | GRM32DR73A153KW01# |          |
|        |               |         | 22000pF | ±10%               | GRM32DR73A223KW01# |          |
|        | 630Vdc        | X7R     | 33000pF | ±10%               | GRM32DR72J333KW01# |          |
|        |               |         | 47000pF | ±10%               | GRM32DR72J473KW01# |          |
|        | 250Vdc        | X7R     | 0.10μF  | ±10%               | GRM32DR72E104KW01# |          |
|        |               |         | 0.22μF  | ±10%               | GRM32DR72E224KW01# |          |
| 200Vdc | X7R           | 0.10μF  | ±10%    | GRM32DR72D104KW01# |                    |          |
|        |               | 0.22μF  | ±10%    | GRM32DR72D224KW01# |                    |          |
| 2.2mm  | 25Vdc         | X7R     | 10μF    | ±10%               | GRM32DR71E106KA12# |          |
| 2.7mm  | 100Vdc        | X7R     | 2.2μF   | ±10%               | GRM32ER72A225KA35# |          |
|        |               |         | ±20%    | GRM32ER72A225MA35# |                    |          |
|        | 80Vdc         | X7R     | 4.7μF   | ±10%               | GRM32ER71K475KE14# | Derating |
|        |               |         | ±20%    | GRM32ER71K475ME14# | Derating           |          |
|        | 63Vdc         | X7R     | 10μF    | ±10%               | GRM32ER71J106KA12# | Derating |
|        |               |         | ±20%    | GRM32ER71J106MA12# | Derating           |          |
| 50Vdc  | X7R           | 4.7μF   | ±10%    | GRM32ER71H475KA88# |                    |          |
|        |               | 10μF    | ±10%    | GRM32ER71H106KA12# |                    |          |

| T max. | Rated Voltage | TC Code | Cap.               | Tol.               | Part Number        |                    |                    |
|--------|---------------|---------|--------------------|--------------------|--------------------|--------------------|--------------------|
| 2.7mm  | 50Vdc         | X7R     | 10μF               | ±20%               | GRM32ER71H106MA12# |                    |                    |
|        |               |         | X5R                | 10μF               | ±10%               | GRM32ER61H106KA12# |                    |
|        |               |         |                    |                    | ±20%               | GRM32ER61H106MA12# |                    |
|        |               | B       | 10μF               | ±10%               | GRM32EB31H106KA12# |                    |                    |
|        |               |         |                    | ±20%               | GRM32EB31H106MA12# |                    |                    |
|        |               | 35Vdc   | X7R                | 10μF               | ±10%               | GRM32ER7YA106KA12# |                    |
|        | ±20%          |         |                    | GRM32ER7YA106MA12# |                    |                    |                    |
|        | X5R           |         | 10μF               | ±10%               | GRM32ER6YA106KA12# |                    |                    |
|        |               |         |                    | ±20%               | GRM32ER6YA106MA12# |                    |                    |
|        | B             |         | 10μF               | ±10%               | GRM32EB3YA106KA12# |                    |                    |
|        |               |         |                    | ±20%               | GRM32EB3YA106MA12# |                    |                    |
|        | 25Vdc         | X7R     | 22μF               | ±20%               | GRM32ER71E226ME15# |                    |                    |
|        |               |         | X5R                | 22μF               | ±20%               | GRM32ER61E226ME15# |                    |
|        |               | B       | 22μF               | ±20%               | GRM32EB31E226ME15# |                    |                    |
|        | 16Vdc         | X7R     | 22μF               | ±20%               | GRM32ER71C226MEA8# |                    |                    |
|        |               |         | X6S                | 47μF               | ±20%               | GRM32EC81C476ME15# | Derating           |
|        |               | X5R     | 47μF               | ±20%               | GRM32ER61C476ME15# |                    |                    |
|        |               |         |                    | B                  | 47μF               | ±20%               | GRM32EB31C476ME15# |
| 10Vdc  |               | X7R     | 47μF               | ±20%               | GRM32ER71A476ME15# |                    |                    |
|        |               |         | X5R                | 47μF               | ±20%               | GRM32ER61A476ME20# |                    |
|        |               |         | 100μF              | ±20%               | GRM32ER61A107ME20# | Derating           |                    |
| B      | 47μF          | ±20%    | GRM32EB31A476ME20# |                    |                    |                    |                    |
|        |               | ±20%    | GRM32EB31A476ME20# |                    |                    |                    |                    |
| 6.3Vdc | X7R           | 47μF    | ±20%               | GRM32ER70J476ME20# |                    |                    |                    |
|        |               | X7U     | 100μF              | ±20%               | GRM32EE70J107ME15# | Derating           |                    |
|        | X5R           | 100μF   | ±20%               | GRM32ER60J107ME20# |                    |                    |                    |
| B      | 100μF         | ±20%    | GRM32EB30J107ME16# |                    |                    |                    |                    |
|        |               | ±20%    | GRM32EB30J107ME16# |                    |                    |                    |                    |
| 4Vdc   | X7U           | 100μF   | ±20%               | GRM32EE70G107ME19# |                    |                    |                    |

■ 4.5x3.2mm

| T max. | Rated Voltage | TC Code | Cap.    | Tol.               | Part Number        |  |
|--------|---------------|---------|---------|--------------------|--------------------|--|
| 1.5mm  | 630Vdc        | X7R     | 68000pF | ±10%               | GRM43QR72J683KW01# |  |
|        | 250Vdc        | X7R     | 0.15μF  | ±10%               | GRM43QR72E154KW01# |  |
|        | 200Vdc        | X7R     | 0.15μF  | ±10%               | GRM43QR72D154KW01# |  |
| 2.0mm  | 1000Vdc       | X7R     | 33000pF | ±10%               | GRM43DR73A333KW01# |  |
|        |               |         | 47000pF | ±10%               | GRM43DR73A473KW01# |  |
|        | 630Vdc        | X7R     | 0.10μF  | ±10%               | GRM43DR72J104KW01# |  |
|        |               |         | 0.22μF  | ±10%               | GRM43DR72E224KW01# |  |
|        | 250Vdc        | X7R     | 0.33μF  | ±10%               | GRM43DR72E334KW01# |  |
|        |               |         | 0.47μF  | ±10%               | GRM43DR72E474KW01# |  |
| 0.22μF |               |         | ±10%    | GRM43DR72D224KW01# |                    |  |
| 200Vdc | X7R           | 0.33μF  | ±10%    | GRM43DR72D334KW01# |                    |  |
|        |               | 0.47μF  | ±10%    | GRM43DR72D474KW01# |                    |  |

■ 5.7x5.0mm

| T max. | Rated Voltage | TC Code | Cap.    | Tol. | Part Number        |  |
|--------|---------------|---------|---------|------|--------------------|--|
| 2.0mm  | 1000Vdc       | X7R     | 68000pF | ±10% | GRM55DR73A683KW01# |  |
|        |               |         | 0.10μF  | ±10% | GRM55DR73A104KW01# |  |
|        | 630Vdc        | X7R     | 0.15μF  | ±10% | GRM55DR72J154KW01# |  |
|        |               |         | 0.22μF  | ±10% | GRM55DR72J224KW01# |  |
|        | 250Vdc        | X7R     | 0.33μF  | ±10% | GRM55DR72E334KW01# |  |

Part number # indicates the package specification code.

GRM Series  
GJM Series  
GMA Series  
GMD Series  
GQM Series  
GRJ Series  
GR3 Series  
KRM Series  
KR3 Series  
LLA Series  
LLL Series  
LLM Series  
LLR Series  
⚠Caution/Notice

## GRM Series High Dielectric Constant Type Part Number List

(→ ■ 5.7×5.0mm)

| T max. | Rated Voltage | TC Code | Cap.   | Tol. | Part Number        |
|--------|---------------|---------|--------|------|--------------------|
| 2.0mm  | 250Vdc        | X7R     | 0.47μF | ±10% | GRM55DR72E474KW01# |
|        |               |         | 0.68μF | ±10% | GRM55DR72E684KW01# |
|        |               |         | 1.0μF  | ±10% | GRM55DR72E105KW01# |
|        | 200Vdc        | X7R     | 0.33μF | ±10% | GRM55DR72D334KW01# |
|        |               |         | 0.47μF | ±10% | GRM55DR72D474KW01# |
|        |               |         | 0.68μF | ±10% | GRM55DR72D684KW01# |
|        |               |         | 1.0μF  | ±10% | GRM55DR72D105KW01# |

GRM Series

GJM Series

GMA Series

GMD Series

GQM Series

GRJ Series

GR3 Series

KRM Series

KR3 Series

LLA Series

LLL Series

LLM Series

LLR Series

⚠Caution/  
Notice



High Frequency High Q Type 1005(in mm)/0402(in inch) Size Max.

# GJM Series **High Q**

This product improves the high frequency characteristics and contributes to a reduction of power consumption by the High Q and low ESR.

## Features

### ① Mainly ideal for mobile communication devices and temperature compensation of related modules.

This product is ideal for temperature compensation of high frequency circuits, such as resonant circuits, tuning circuits, and impedance matching circuits where the operating characteristics of the device are greatly affected by the capacitance fluctuation.

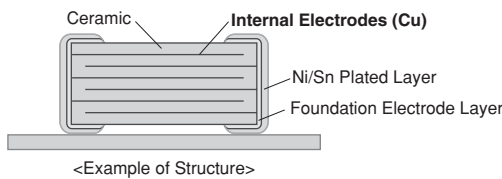

### ② High Q and low ESR in VHF, UHF and microwave frequency bands.

High Q and low ESR were achieved at a high frequency by adopting ceramic material as the dielectric material which enables an extremely low loss at high frequency, and base metal electrodes as the internal electrodes.

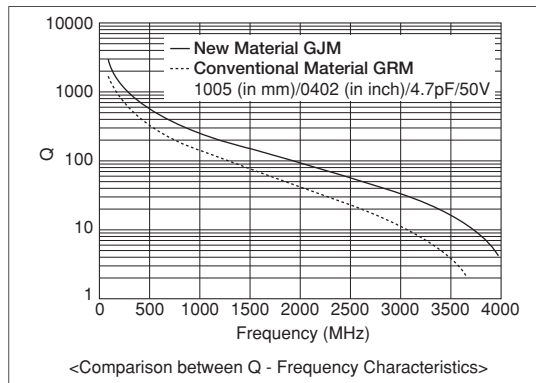
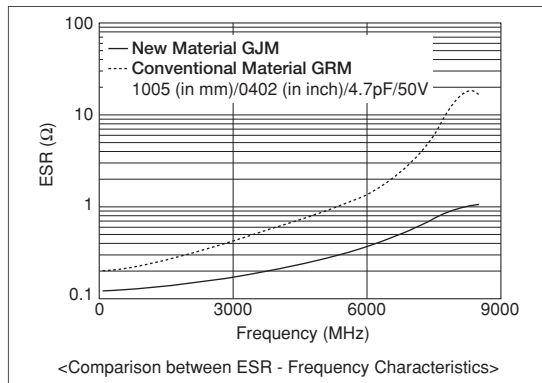

### ③ Can be used for tight tolerance.

In addition to standard tolerance, the allowable range of this product is also suitable for the following tight tolerance.

| Capacitance Range | Standard Capacitance Tolerance<br>(Capacitance Tolerance Symbol) | Narrow Capacitance Tolerance<br>(Capacitance Tolerance Symbol) |
|-------------------|--|--|
| <=0.9pF           | ±0.1pF (B)   | ±0.05pF (W)  |
| 1.0 to 5.0pF      | ±0.25pF (C)  | ±0.05pF (W), ±0.1pF (B)  |
| 5.1 to 9.9pF      | ±0.5pF (D)   | ±0.05pF (W), ±0.1pF (B), ±0.25pF (C)                           |
| >=10pF            | ±5% (J)  | ±2% (G)  |

## Specifications

|                   |   |
|-------------------|---|
| Size              | 0.4×0.2mm to 1.0×0.5mm  |
| Rated Voltage     | DC6.3V to 50V   |
| Capacitance       | 0.1pF to 47pF   |
| Main Applications | Small communication devices, such as mobile phones and high frequency communication modules |

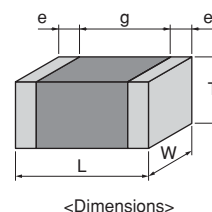

This catalog contains only a portion of the product lineup.  
 Please refer to the capacitor search tool on the Murata Web site for details.

GRM Series  
GJM Series  
GMA Series  
GMD Series  
GQM Series  
GRJ Series  
GR3 Series  
KRM Series  
KR3 Series  
LLA Series  
LLL Series  
LLM Series  
LLR Series  
⚠Caution/Notice

# GJM Series Temperature Compensating Type High Q Part Number List

■ 0.4x0.2mm Ultra-compact

| T max.  | Rated Voltage      | TC Code            | Cap.   | Tol.    | Part Number        |
|---------|--------------------|--------------------|--------|---------|--------------------|
| 0.22mm  | 25Vdc              | C0G                | 0.20pF | ±0.05pF | GJM0225C1ER20WB01# |
|         |                    |                    |        | ±0.1pF  | GJM0225C1ER20BB01# |
|         |                    |                    | 0.30pF | ±0.05pF | GJM0225C1ER30WB01# |
|         |                    |                    |        | ±0.1pF  | GJM0225C1ER30BB01# |
|         |                    |                    | 0.40pF | ±0.05pF | GJM0225C1ER40WB01# |
|         |                    |                    |        | ±0.1pF  | GJM0225C1ER40BB01# |
|         |                    |                    | 0.50pF | ±0.05pF | GJM0225C1ER50WB01# |
|         |                    |                    |        | ±0.1pF  | GJM0225C1ER50BB01# |
|         |                    |                    | 0.60pF | ±0.05pF | GJM0225C1ER60WB01# |
|         |                    |                    |        | ±0.1pF  | GJM0225C1ER60BB01# |
|         |                    |                    | 0.70pF | ±0.05pF | GJM0225C1ER70WB01# |
|         |                    |                    |        | ±0.1pF  | GJM0225C1ER70BB01# |
|         |                    |                    | 0.80pF | ±0.05pF | GJM0225C1ER80WB01# |
|         |                    |                    |        | ±0.1pF  | GJM0225C1ER80BB01# |
|         |                    |                    | 0.90pF | ±0.05pF | GJM0225C1ER90WB01# |
|         |                    |                    |        | ±0.1pF  | GJM0225C1ER90BB01# |
|         |                    |                    | 1.0pF  | ±0.05pF | GJM0225C1E1R0WB01# |
|         |                    |                    |        | ±0.1pF  | GJM0225C1E1R0BB01# |
|         |                    |                    |        | ±0.25pF | GJM0225C1E1R0CB01# |
|         |                    |                    | 1.1pF  | ±0.05pF | GJM0225C1E1R1WB01# |
|         |                    |                    |        | ±0.1pF  | GJM0225C1E1R1BB01# |
|         |                    |                    |        | ±0.25pF | GJM0225C1E1R1CB01# |
|         |                    |                    | 1.2pF  | ±0.05pF | GJM0225C1E1R2WB01# |
|         |                    |                    |        | ±0.1pF  | GJM0225C1E1R2BB01# |
|         |                    |                    |        | ±0.25pF | GJM0225C1E1R2CB01# |
|         |                    |                    | 1.3pF  | ±0.05pF | GJM0225C1E1R3WB01# |
|         |                    |                    |        | ±0.1pF  | GJM0225C1E1R3BB01# |
|         |                    |                    |        | ±0.25pF | GJM0225C1E1R3CB01# |
|         |                    |                    | 1.4pF  | ±0.05pF | GJM0225C1E1R4WB01# |
|         |                    |                    |        | ±0.1pF  | GJM0225C1E1R4BB01# |
|         |                    |                    |        | ±0.25pF | GJM0225C1E1R4CB01# |
|         |                    |                    | 1.5pF  | ±0.05pF | GJM0225C1E1R5WB01# |
|         |                    |                    |        | ±0.1pF  | GJM0225C1E1R5BB01# |
|         |                    |                    |        | ±0.25pF | GJM0225C1E1R5CB01# |
|         |                    |                    | 1.6pF  | ±0.05pF | GJM0225C1E1R6WB01# |
|         |                    |                    |        | ±0.1pF  | GJM0225C1E1R6BB01# |
|         |                    |                    |        | ±0.25pF | GJM0225C1E1R6CB01# |
|         |                    |                    | 1.7pF  | ±0.05pF | GJM0225C1E1R7WB01# |
|         |                    |                    |        | ±0.1pF  | GJM0225C1E1R7BB01# |
|         |                    |                    |        | ±0.25pF | GJM0225C1E1R7CB01# |
|         |                    |                    | 1.8pF  | ±0.05pF | GJM0225C1E1R8WB01# |
|         |                    |                    |        | ±0.1pF  | GJM0225C1E1R8BB01# |
|         |                    |                    |        | ±0.25pF | GJM0225C1E1R8CB01# |
|         |                    |                    | 1.9pF  | ±0.05pF | GJM0225C1E1R9WB01# |
|         |                    |                    |        | ±0.1pF  | GJM0225C1E1R9BB01# |
|         |                    |                    |        | ±0.25pF | GJM0225C1E1R9CB01# |
|         |                    |                    | 2.0pF  | ±0.05pF | GJM0225C1E2R0WB01# |
|         |                    |                    |        | ±0.1pF  | GJM0225C1E2R0BB01# |
| ±0.25pF | GJM0225C1E2R0CB01# |                    |        |         |                    |
| 2.1pF   | ±0.05pF            | GJM0225C1E2R1WB01# |        |         |                    |
|         | ±0.1pF             | GJM0225C1E2R1BB01# |        |         |                    |
|         | ±0.25pF            | GJM0225C1E2R1CB01# |        |         |                    |

| T max. | Rated Voltage | TC Code            | Cap.  | Tol.    | Part Number        |
|--------|---------------|--------------------|-------|---------|--------------------|
| 0.22mm | 25Vdc         | C0G                | 2.2pF | ±0.05pF | GJM0225C1E2R2WB01# |
|        |               |                    |       | ±0.1pF  | GJM0225C1E2R2BB01# |
|        |               |                    |       | ±0.25pF | GJM0225C1E2R2CB01# |
|        |               |                    | 2.3pF | ±0.05pF | GJM0225C1E2R3WB01# |
|        |               |                    |       | ±0.1pF  | GJM0225C1E2R3BB01# |
|        |               |                    |       | ±0.25pF | GJM0225C1E2R3CB01# |
|        |               |                    | 2.4pF | ±0.05pF | GJM0225C1E2R4WB01# |
|        |               |                    |       | ±0.1pF  | GJM0225C1E2R4BB01# |
|        |               |                    |       | ±0.25pF | GJM0225C1E2R4CB01# |
|        |               |                    | 2.5pF | ±0.05pF | GJM0225C1E2R5WB01# |
|        |               |                    |       | ±0.1pF  | GJM0225C1E2R5BB01# |
|        |               |                    |       | ±0.25pF | GJM0225C1E2R5CB01# |
|        |               |                    | 2.6pF | ±0.05pF | GJM0225C1E2R6WB01# |
|        |               |                    |       | ±0.1pF  | GJM0225C1E2R6BB01# |
|        |               |                    |       | ±0.25pF | GJM0225C1E2R6CB01# |
|        |               |                    | 2.7pF | ±0.05pF | GJM0225C1E2R7WB01# |
|        |               |                    |       | ±0.1pF  | GJM0225C1E2R7BB01# |
|        |               |                    |       | ±0.25pF | GJM0225C1E2R7CB01# |
|        |               |                    | 2.8pF | ±0.05pF | GJM0225C1E2R8WB01# |
|        |               |                    |       | ±0.1pF  | GJM0225C1E2R8BB01# |
|        |               |                    |       | ±0.25pF | GJM0225C1E2R8CB01# |
|        |               |                    | 2.9pF | ±0.05pF | GJM0225C1E2R9WB01# |
|        |               |                    |       | ±0.1pF  | GJM0225C1E2R9BB01# |
|        |               |                    |       | ±0.25pF | GJM0225C1E2R9CB01# |
|        |               |                    | 3.0pF | ±0.05pF | GJM0225C1E3R0WB01# |
|        |               |                    |       | ±0.1pF  | GJM0225C1E3R0BB01# |
|        |               |                    |       | ±0.25pF | GJM0225C1E3R0CB01# |
|        |               |                    | 3.1pF | ±0.05pF | GJM0225C1E3R1WB01# |
|        |               |                    |       | ±0.1pF  | GJM0225C1E3R1BB01# |
|        |               |                    |       | ±0.25pF | GJM0225C1E3R1CB01# |
|        |               |                    | 3.2pF | ±0.05pF | GJM0225C1E3R2WB01# |
|        |               |                    |       | ±0.1pF  | GJM0225C1E3R2BB01# |
|        |               |                    |       | ±0.25pF | GJM0225C1E3R2CB01# |
|        |               |                    | 3.3pF | ±0.05pF | GJM0225C1E3R3WB01# |
|        |               |                    |       | ±0.1pF  | GJM0225C1E3R3BB01# |
|        |               |                    |       | ±0.25pF | GJM0225C1E3R3CB01# |
|        |               |                    | 3.4pF | ±0.05pF | GJM0225C1E3R4WB01# |
|        |               |                    |       | ±0.1pF  | GJM0225C1E3R4BB01# |
|        |               |                    |       | ±0.25pF | GJM0225C1E3R4CB01# |
|        |               |                    | 3.5pF | ±0.05pF | GJM0225C1E3R5WB01# |
|        |               |                    |       | ±0.1pF  | GJM0225C1E3R5BB01# |
|        |               |                    |       | ±0.25pF | GJM0225C1E3R5CB01# |
|        |               |                    | 3.6pF | ±0.05pF | GJM0225C1E3R6WB01# |
|        |               |                    |       | ±0.1pF  | GJM0225C1E3R6BB01# |
|        |               |                    |       | ±0.25pF | GJM0225C1E3R6CB01# |
|        |               |                    | 3.7pF | ±0.05pF | GJM0225C1E3R7WB01# |
|        |               |                    |       | ±0.1pF  | GJM0225C1E3R7BB01# |
|        |               |                    |       | ±0.25pF | GJM0225C1E3R7CB01# |
| 3.8pF  | ±0.05pF       | GJM0225C1E3R8WB01# |       |         |                    |
|        | ±0.1pF        | GJM0225C1E3R8BB01# |       |         |                    |
|        | ±0.25pF       | GJM0225C1E3R8CB01# |       |         |                    |
| 3.9pF  | ±0.05pF       | GJM0225C1E3R9WB01# |       |         |                    |
|        | ±0.1pF        | GJM0225C1E3R9BB01# |       |         |                    |
|        | ±0.25pF       | GJM0225C1E3R9CB01# |       |         |                    |

Part number # indicates the package specification code.

GRM Series  
 GJM Series  
 GMA Series  
 GMD Series  
 GQM Series  
 GRJ Series  
 GR3 Series  
 KRM Series  
 KR3 Series  
 LLA Series  
 LLL Series  
 LLM Series  
 LLR Series  
 ⚠Caution/  
 Notice

# GJM Series Temperature Compensating Type High Q Part Number List

(→ ■ 0.4x0.2mm)

| T max. | Rated Voltage | TC Code | Cap.  | Tol.    | Part Number               |
|--------|---------------|---------|-------|---------|---------------------------|
| 0.22mm | 25Vdc         | C0G     | 4.0pF | ±0.05pF | <b>GJM0225C1E4R0WB01#</b> |
|        |               |         |       | ±0.1pF  | <b>GJM0225C1E4R0BB01#</b> |
|        |               |         |       | ±0.25pF | <b>GJM0225C1E4R0CB01#</b> |
|        |               |         | 4.1pF | ±0.05pF | <b>GJM0225C1E4R1WB01#</b> |
|        |               |         |       | ±0.1pF  | <b>GJM0225C1E4R1BB01#</b> |
|        |               |         |       | ±0.25pF | <b>GJM0225C1E4R1CB01#</b> |
|        |               |         | 4.2pF | ±0.05pF | <b>GJM0225C1E4R2WB01#</b> |
|        |               |         |       | ±0.1pF  | <b>GJM0225C1E4R2BB01#</b> |
|        |               |         |       | ±0.25pF | <b>GJM0225C1E4R2CB01#</b> |
|        |               |         | 4.3pF | ±0.05pF | <b>GJM0225C1E4R3WB01#</b> |
|        |               |         |       | ±0.1pF  | <b>GJM0225C1E4R3BB01#</b> |
|        |               |         |       | ±0.25pF | <b>GJM0225C1E4R3CB01#</b> |
|        |               |         | 4.4pF | ±0.05pF | <b>GJM0225C1E4R4WB01#</b> |
|        |               |         |       | ±0.1pF  | <b>GJM0225C1E4R4BB01#</b> |
|        |               |         |       | ±0.25pF | <b>GJM0225C1E4R4CB01#</b> |
|        |               |         | 4.5pF | ±0.05pF | <b>GJM0225C1E4R5WB01#</b> |
|        |               |         |       | ±0.1pF  | <b>GJM0225C1E4R5BB01#</b> |
|        |               |         |       | ±0.25pF | <b>GJM0225C1E4R5CB01#</b> |
|        |               |         | 4.6pF | ±0.05pF | <b>GJM0225C1E4R6WB01#</b> |
|        |               |         |       | ±0.1pF  | <b>GJM0225C1E4R6BB01#</b> |
|        |               |         |       | ±0.25pF | <b>GJM0225C1E4R6CB01#</b> |
|        |               |         | 4.7pF | ±0.05pF | <b>GJM0225C1E4R7WB01#</b> |
|        |               |         |       | ±0.1pF  | <b>GJM0225C1E4R7BB01#</b> |
|        |               |         |       | ±0.25pF | <b>GJM0225C1E4R7CB01#</b> |
|        |               |         | 4.8pF | ±0.05pF | <b>GJM0225C1E4R8WB01#</b> |
|        |               |         |       | ±0.1pF  | <b>GJM0225C1E4R8BB01#</b> |
|        |               |         |       | ±0.25pF | <b>GJM0225C1E4R8CB01#</b> |
|        |               |         | 4.9pF | ±0.05pF | <b>GJM0225C1E4R9WB01#</b> |
|        |               |         |       | ±0.1pF  | <b>GJM0225C1E4R9BB01#</b> |
|        |               |         |       | ±0.25pF | <b>GJM0225C1E4R9CB01#</b> |
|        |               |         | 5.0pF | ±0.05pF | <b>GJM0225C1E5R0WB01#</b> |
|        |               |         |       | ±0.1pF  | <b>GJM0225C1E5R0BB01#</b> |
|        |               |         |       | ±0.25pF | <b>GJM0225C1E5R0CB01#</b> |
|        |               |         | 5.1pF | ±0.05pF | <b>GJM0225C1E5R1WB01#</b> |
|        |               |         |       | ±0.1pF  | <b>GJM0225C1E5R1BB01#</b> |
|        |               |         |       | ±0.25pF | <b>GJM0225C1E5R1CB01#</b> |
|        |               |         |       | ±0.5pF  | <b>GJM0225C1E5R1DB01#</b> |
|        |               |         | 5.2pF | ±0.05pF | <b>GJM0225C1E5R2WB01#</b> |
|        |               |         |       | ±0.1pF  | <b>GJM0225C1E5R2BB01#</b> |
|        |               |         |       | ±0.25pF | <b>GJM0225C1E5R2CB01#</b> |
|        |               |         |       | ±0.5pF  | <b>GJM0225C1E5R2DB01#</b> |
|        |               |         | 5.3pF | ±0.05pF | <b>GJM0225C1E5R3WB01#</b> |
|        |               |         |       | ±0.1pF  | <b>GJM0225C1E5R3BB01#</b> |
|        |               |         |       | ±0.25pF | <b>GJM0225C1E5R3CB01#</b> |
|        |               |         |       | ±0.5pF  | <b>GJM0225C1E5R3DB01#</b> |
|        |               |         | 5.4pF | ±0.05pF | <b>GJM0225C1E5R4WB01#</b> |
|        |               |         |       | ±0.1pF  | <b>GJM0225C1E5R4BB01#</b> |
|        |               |         |       | ±0.25pF | <b>GJM0225C1E5R4CB01#</b> |
|        |               |         |       | ±0.5pF  | <b>GJM0225C1E5R4DB01#</b> |
|        |               |         | 5.5pF | ±0.05pF | <b>GJM0225C1E5R5WB01#</b> |
|        |               |         |       | ±0.1pF  | <b>GJM0225C1E5R5BB01#</b> |
|        |               |         |       | ±0.25pF | <b>GJM0225C1E5R5CB01#</b> |
|        |               |         |       | ±0.5pF  | <b>GJM0225C1E5R5DB01#</b> |
|        |               |         | 5.6pF | ±0.05pF | <b>GJM0225C1E5R6WB01#</b> |

| T max. | Rated Voltage | TC Code | Cap.  | Tol.    | Part Number               |
|--------|---------------|---------|-------|---------|---------------------------|
| 0.22mm | 25Vdc         | C0G     | 5.6pF | ±0.1pF  | <b>GJM0225C1E5R6BB01#</b> |
|        |               |         |       | ±0.25pF | <b>GJM0225C1E5R6CB01#</b> |
|        |               |         |       | ±0.5pF  | <b>GJM0225C1E5R6DB01#</b> |
|        |               |         | 5.7pF | ±0.05pF | <b>GJM0225C1E5R7WB01#</b> |
|        |               |         |       | ±0.1pF  | <b>GJM0225C1E5R7BB01#</b> |
|        |               |         |       | ±0.25pF | <b>GJM0225C1E5R7CB01#</b> |
|        |               |         | 5.8pF | ±0.05pF | <b>GJM0225C1E5R8WB01#</b> |
|        |               |         |       | ±0.1pF  | <b>GJM0225C1E5R8BB01#</b> |
|        |               |         |       | ±0.25pF | <b>GJM0225C1E5R8CB01#</b> |
|        |               |         | 5.9pF | ±0.05pF | <b>GJM0225C1E5R9WB01#</b> |
|        |               |         |       | ±0.1pF  | <b>GJM0225C1E5R9BB01#</b> |
|        |               |         |       | ±0.25pF | <b>GJM0225C1E5R9CB01#</b> |
|        |               |         | 6.0pF | ±0.05pF | <b>GJM0225C1E6R0WB01#</b> |
|        |               |         |       | ±0.1pF  | <b>GJM0225C1E6R0BB01#</b> |
|        |               |         |       | ±0.25pF | <b>GJM0225C1E6R0CB01#</b> |
|        |               |         | 6.1pF | ±0.05pF | <b>GJM0225C1E6R1WB01#</b> |
|        |               |         |       | ±0.1pF  | <b>GJM0225C1E6R1BB01#</b> |
|        |               |         |       | ±0.25pF | <b>GJM0225C1E6R1CB01#</b> |
|        |               |         | 6.2pF | ±0.05pF | <b>GJM0225C1E6R2WB01#</b> |
|        |               |         |       | ±0.1pF  | <b>GJM0225C1E6R2BB01#</b> |
|        |               |         |       | ±0.25pF | <b>GJM0225C1E6R2CB01#</b> |
|        |               |         | 6.3pF | ±0.05pF | <b>GJM0225C1E6R3WB01#</b> |
|        |               |         |       | ±0.1pF  | <b>GJM0225C1E6R3BB01#</b> |
|        |               |         |       | ±0.25pF | <b>GJM0225C1E6R3CB01#</b> |
|        |               |         | 6.4pF | ±0.05pF | <b>GJM0225C1E6R4WB01#</b> |
|        |               |         |       | ±0.1pF  | <b>GJM0225C1E6R4BB01#</b> |
|        |               |         |       | ±0.25pF | <b>GJM0225C1E6R4CB01#</b> |
|        |               |         | 6.5pF | ±0.05pF | <b>GJM0225C1E6R5WB01#</b> |
|        |               |         |       | ±0.1pF  | <b>GJM0225C1E6R5BB01#</b> |
|        |               |         |       | ±0.25pF | <b>GJM0225C1E6R5CB01#</b> |
|        |               |         | 6.6pF | ±0.05pF | <b>GJM0225C1E6R6WB01#</b> |
|        |               |         |       | ±0.1pF  | <b>GJM0225C1E6R6BB01#</b> |
|        |               |         |       | ±0.25pF | <b>GJM0225C1E6R6CB01#</b> |
|        |               |         | 6.7pF | ±0.05pF | <b>GJM0225C1E6R7WB01#</b> |
|        |               |         |       | ±0.1pF  | <b>GJM0225C1E6R7BB01#</b> |
|        |               |         |       | ±0.25pF | <b>GJM0225C1E6R7CB01#</b> |
|        |               |         | 6.8pF | ±0.05pF | <b>GJM0225C1E6R8WB01#</b> |
|        |               |         |       | ±0.1pF  | <b>GJM0225C1E6R8BB01#</b> |
|        |               |         |       | ±0.25pF | <b>GJM0225C1E6R8CB01#</b> |
|        |               |         | 6.9pF | ±0.05pF | <b>GJM0225C1E6R9WB01#</b> |
|        |               |         |       | ±0.1pF  | <b>GJM0225C1E6R9BB01#</b> |
|        |               |         |       | ±0.25pF | <b>GJM0225C1E6R9CB01#</b> |

Part number # indicates the package specification code.

GRM Series  
 GJM Series  
 GMA Series  
 GMD Series  
 GQM Series  
 GRJ Series  
 GR3 Series  
 KRM Series  
 KR3 Series  
 LLA Series  
 LLL Series  
 LLM Series  
 LLR Series  
 ⚠Caution/ Notice

# GJM Series Temperature Compensating Type High Q Part Number List

(→ ■ 0.4x0.2mm)

| T max. | Rated Voltage | TC Code | Cap.    | Tol.    | Part Number        |                    |
|--------|---------------|---------|---------|---------|--------------------|--------------------|
| 0.22mm | 25Vdc         | COG     | 6.9pF   | ±0.5pF  | GJM0225C1E6R9DB01# |                    |
|        |               |         |         | 7.0pF   | ±0.05pF            | GJM0225C1E7R0WB01# |
|        |               |         |         |         | ±0.1pF             | GJM0225C1E7R0BB01# |
|        |               |         | ±0.25pF |         | GJM0225C1E7R0CB01# |                    |
|        |               |         | ±0.5pF  |         | GJM0225C1E7R0DB01# |                    |
|        |               |         | 7.1pF   | ±0.05pF | GJM0225C1E7R1WB01# |                    |
|        |               |         |         | ±0.1pF  | GJM0225C1E7R1BB01# |                    |
|        |               |         |         | ±0.25pF | GJM0225C1E7R1CB01# |                    |
|        |               |         | 7.2pF   | ±0.05pF | GJM0225C1E7R2WB01# |                    |
|        |               |         |         | ±0.1pF  | GJM0225C1E7R2BB01# |                    |
|        |               |         |         | ±0.25pF | GJM0225C1E7R2CB01# |                    |
|        |               |         | 7.3pF   | ±0.05pF | GJM0225C1E7R3WB01# |                    |
|        |               |         |         | ±0.1pF  | GJM0225C1E7R3BB01# |                    |
|        |               |         |         | ±0.25pF | GJM0225C1E7R3CB01# |                    |
|        |               |         | 7.4pF   | ±0.05pF | GJM0225C1E7R4WB01# |                    |
|        |               |         |         | ±0.1pF  | GJM0225C1E7R4BB01# |                    |
|        |               |         |         | ±0.25pF | GJM0225C1E7R4CB01# |                    |
|        |               |         | 7.5pF   | ±0.05pF | GJM0225C1E7R5WB01# |                    |
|        |               |         |         | ±0.1pF  | GJM0225C1E7R5BB01# |                    |
|        |               |         |         | ±0.25pF | GJM0225C1E7R5CB01# |                    |
|        |               |         | 7.6pF   | ±0.05pF | GJM0225C1E7R6WB01# |                    |
|        |               |         |         | ±0.1pF  | GJM0225C1E7R6BB01# |                    |
|        |               |         |         | ±0.25pF | GJM0225C1E7R6CB01# |                    |
|        |               |         | 7.7pF   | ±0.05pF | GJM0225C1E7R7WB01# |                    |
|        |               |         |         | ±0.1pF  | GJM0225C1E7R7BB01# |                    |
|        |               |         |         | ±0.25pF | GJM0225C1E7R7CB01# |                    |
|        |               |         | 7.8pF   | ±0.05pF | GJM0225C1E7R8WB01# |                    |
|        |               |         |         | ±0.1pF  | GJM0225C1E7R8BB01# |                    |
|        |               |         |         | ±0.25pF | GJM0225C1E7R8CB01# |                    |
|        |               |         | 7.9pF   | ±0.05pF | GJM0225C1E7R9WB01# |                    |
|        |               |         |         | ±0.1pF  | GJM0225C1E7R9BB01# |                    |
|        |               |         |         | ±0.25pF | GJM0225C1E7R9CB01# |                    |
|        |               |         | 8.0pF   | ±0.05pF | GJM0225C1E8R0WB01# |                    |
|        |               |         |         | ±0.1pF  | GJM0225C1E8R0BB01# |                    |
|        |               |         |         | ±0.25pF | GJM0225C1E8R0CB01# |                    |
|        |               |         | 8.1pF   | ±0.05pF | GJM0225C1E8R1WB01# |                    |
|        |               |         |         | ±0.1pF  | GJM0225C1E8R1BB01# |                    |
|        |               |         |         | ±0.25pF | GJM0225C1E8R1CB01# |                    |
|        |               |         | 8.2pF   | ±0.05pF | GJM0225C1E8R2WB01# |                    |
|        |               |         |         | ±0.1pF  | GJM0225C1E8R2BB01# |                    |
|        |               |         |         | ±0.25pF | GJM0225C1E8R2CB01# |                    |
|        |               |         | 8.3pF   | ±0.05pF | GJM0225C1E8R3WB01# |                    |
|        |               |         |         | ±0.1pF  | GJM0225C1E8R3BB01# |                    |
|        |               |         |         | ±0.25pF | GJM0225C1E8R3CB01# |                    |

| T max. | Rated Voltage | TC Code | Cap.  | Tol.    | Part Number        |
|--------|---------------|---------|-------|---------|--------------------|
| 0.22mm | 25Vdc         | COG     | 8.3pF | ±0.1pF  | GJM0225C1E8R3BB01# |
|        |               |         |       | ±0.25pF | GJM0225C1E8R3CB01# |
|        |               |         |       | ±0.5pF  | GJM0225C1E8R3DB01# |
|        |               |         | 8.4pF | ±0.05pF | GJM0225C1E8R4WB01# |
|        |               |         |       | ±0.1pF  | GJM0225C1E8R4BB01# |
|        |               |         |       | ±0.25pF | GJM0225C1E8R4CB01# |
|        |               |         | 8.5pF | ±0.05pF | GJM0225C1E8R5WB01# |
|        |               |         |       | ±0.1pF  | GJM0225C1E8R5BB01# |
|        |               |         |       | ±0.25pF | GJM0225C1E8R5CB01# |
|        |               |         | 8.6pF | ±0.05pF | GJM0225C1E8R6WB01# |
|        |               |         |       | ±0.1pF  | GJM0225C1E8R6BB01# |
|        |               |         |       | ±0.25pF | GJM0225C1E8R6CB01# |
|        |               |         | 8.7pF | ±0.05pF | GJM0225C1E8R7WB01# |
|        |               |         |       | ±0.1pF  | GJM0225C1E8R7BB01# |
|        |               |         |       | ±0.25pF | GJM0225C1E8R7CB01# |
|        |               |         | 8.8pF | ±0.05pF | GJM0225C1E8R8WB01# |
|        |               |         |       | ±0.1pF  | GJM0225C1E8R8BB01# |
|        |               |         |       | ±0.25pF | GJM0225C1E8R8CB01# |
|        |               |         | 8.9pF | ±0.05pF | GJM0225C1E8R9WB01# |
|        |               |         |       | ±0.1pF  | GJM0225C1E8R9BB01# |
|        |               |         |       | ±0.25pF | GJM0225C1E8R9CB01# |
|        |               |         | 9.0pF | ±0.05pF | GJM0225C1E9R0WB01# |
|        |               |         |       | ±0.1pF  | GJM0225C1E9R0BB01# |
|        |               |         |       | ±0.25pF | GJM0225C1E9R0CB01# |
|        |               |         | 9.1pF | ±0.05pF | GJM0225C1E9R1WB01# |
|        |               |         |       | ±0.1pF  | GJM0225C1E9R1BB01# |
|        |               |         |       | ±0.25pF | GJM0225C1E9R1CB01# |
|        |               |         | 9.2pF | ±0.05pF | GJM0225C1E9R2WB01# |
|        |               |         |       | ±0.1pF  | GJM0225C1E9R2BB01# |
|        |               |         |       | ±0.25pF | GJM0225C1E9R2CB01# |
|        |               |         | 9.3pF | ±0.05pF | GJM0225C1E9R3WB01# |
|        |               |         |       | ±0.1pF  | GJM0225C1E9R3BB01# |
|        |               |         |       | ±0.25pF | GJM0225C1E9R3CB01# |
|        |               |         | 9.4pF | ±0.05pF | GJM0225C1E9R4WB01# |
|        |               |         |       | ±0.1pF  | GJM0225C1E9R4BB01# |
|        |               |         |       | ±0.25pF | GJM0225C1E9R4CB01# |
|        |               |         | 9.5pF | ±0.05pF | GJM0225C1E9R5WB01# |
|        |               |         |       | ±0.1pF  | GJM0225C1E9R5BB01# |
|        |               |         |       | ±0.25pF | GJM0225C1E9R5CB01# |
|        |               |         | 9.6pF | ±0.05pF | GJM0225C1E9R6WB01# |
|        |               |         |       | ±0.1pF  | GJM0225C1E9R6BB01# |
|        |               |         |       | ±0.25pF | GJM0225C1E9R6CB01# |

Part number # indicates the package specification code.

GRM Series  
 GJM Series  
 GMA Series  
 GMD Series  
 GQM Series  
 GRJ Series  
 GR3 Series  
 KRM Series  
 KR3 Series  
 LLA Series  
 LLL Series  
 LLM Series  
 LLR Series  
 ⚠Caution/  
 Notice

# GJM Series Temperature Compensating Type High Q Part Number List

(→ ■ 0.4x0.2mm)

| T max. | Rated Voltage | TC Code            | Cap.    | Tol.               | Part Number        |
|--------|---------------|--------------------|---------|--------------------|--------------------|
| 0.22mm | 25Vdc         | COG                | 9.6pF   | ±0.5pF             | GJM0225C1E9R6DB01# |
|        |               |                    |         | ±0.05pF            | GJM0225C1E9R7WB01# |
|        |               |                    | 9.7pF   | ±0.1pF             | GJM0225C1E9R7BB01# |
|        |               |                    |         | ±0.25pF            | GJM0225C1E9R7CB01# |
|        |               |                    |         | ±0.5pF             | GJM0225C1E9R7DB01# |
|        |               |                    | 9.8pF   | ±0.05pF            | GJM0225C1E9R8WB01# |
|        |               |                    |         | ±0.1pF             | GJM0225C1E9R8BB01# |
|        |               |                    |         | ±0.25pF            | GJM0225C1E9R8CB01# |
|        |               |                    |         | ±0.5pF             | GJM0225C1E9R8DB01# |
|        |               |                    | 9.9pF   | ±0.05pF            | GJM0225C1E9R9WB01# |
|        |               |                    |         | ±0.1pF             | GJM0225C1E9R9BB01# |
|        |               |                    |         | ±0.25pF            | GJM0225C1E9R9CB01# |
|        |               |                    |         | ±0.5pF             | GJM0225C1E9R9DB01# |
|        |               |                    | 10pF    | ±2%                | GJM0225C1E100GB01# |
|        |               |                    |         | ±5%                | GJM0225C1E100JB01# |
|        |               |                    | 11pF    | ±2%                | GJM0225C1E110GB01# |
|        |               |                    |         | ±5%                | GJM0225C1E110JB01# |
|        |               |                    | 12pF    | ±2%                | GJM0225C1E120GB01# |
|        |               |                    |         | ±5%                | GJM0225C1E120JB01# |
|        |               |                    | 13pF    | ±2%                | GJM0225C1E130GB01# |
|        |               |                    |         | ±5%                | GJM0225C1E130JB01# |
|        |               |                    | 15pF    | ±2%                | GJM0225C1E150GB01# |
|        |               |                    |         | ±5%                | GJM0225C1E150JB01# |
|        |               |                    | 16pF    | ±2%                | GJM0225C1E160GB01# |
|        |               |                    |         | ±5%                | GJM0225C1E160JB01# |
|        |               |                    | 18pF    | ±2%                | GJM0225C1E180GB01# |
|        |               |                    |         | ±5%                | GJM0225C1E180JB01# |
|        |               |                    | 20pF    | ±2%                | GJM0225C1E200GB01# |
|        |               |                    |         | ±5%                | GJM0225C1E200JB01# |
|        |               |                    | 22pF    | ±2%                | GJM0225C1E220GB01# |
|        |               | ±5%                |         | GJM0225C1E220JB01# |                    |
|        |               | CK                 | 0.20pF  | ±0.05pF            | GJM0224C1ER20WB01# |
|        |               |                    |         | ±0.1pF             | GJM0224C1ER20BB01# |
|        |               |                    | 0.30pF  | ±0.05pF            | GJM0224C1ER30WB01# |
|        |               |                    |         | ±0.1pF             | GJM0224C1ER30BB01# |
|        |               |                    | 0.40pF  | ±0.05pF            | GJM0224C1ER40WB01# |
|        |               |                    |         | ±0.1pF             | GJM0224C1ER40BB01# |
|        |               |                    | 0.50pF  | ±0.05pF            | GJM0224C1ER50WB01# |
|        |               |                    |         | ±0.1pF             | GJM0224C1ER50BB01# |
|        |               |                    | 0.60pF  | ±0.05pF            | GJM0224C1ER60WB01# |
|        |               |                    |         | ±0.1pF             | GJM0224C1ER60BB01# |
|        |               |                    | 0.70pF  | ±0.05pF            | GJM0224C1ER70WB01# |
|        |               |                    |         | ±0.1pF             | GJM0224C1ER70BB01# |
|        |               |                    | 0.80pF  | ±0.05pF            | GJM0224C1ER80WB01# |
|        |               |                    |         | ±0.1pF             | GJM0224C1ER80BB01# |
|        |               | 0.90pF             | ±0.05pF | GJM0224C1ER90WB01# |                    |
|        |               |                    | ±0.1pF  | GJM0224C1ER90BB01# |                    |
|        |               | 1.0pF              | ±0.05pF | GJM0224C1E1R0WB01# |                    |
|        |               |                    | ±0.1pF  | GJM0224C1E1R0BB01# |                    |
|        |               |                    | ±0.25pF | GJM0224C1E1R0CB01# |                    |
| 1.1pF  | ±0.05pF       | GJM0224C1E1R1WB01# |         |                    |                    |
|        | ±0.1pF        | GJM0224C1E1R1BB01# |         |                    |                    |
|        | ±0.25pF       | GJM0224C1E1R1CB01# |         |                    |                    |
| 1.2pF  | ±0.05pF       | GJM0224C1E1R2WB01# |         |                    |                    |

| T max. | Rated Voltage | TC Code            | Cap.    | Tol.               | Part Number        |
|--------|---------------|--------------------|---------|--------------------|--------------------|
| 0.22mm | 25Vdc         | CK                 | 1.2pF   | ±0.1pF             | GJM0224C1E1R2BB01# |
|        |               |                    |         | ±0.25pF            | GJM0224C1E1R2CB01# |
|        |               |                    | 1.3pF   | ±0.05pF            | GJM0224C1E1R3WB01# |
|        |               |                    |         | ±0.1pF             | GJM0224C1E1R3BB01# |
|        |               |                    |         | ±0.25pF            | GJM0224C1E1R3CB01# |
|        |               |                    | 1.4pF   | ±0.05pF            | GJM0224C1E1R4WB01# |
|        |               |                    |         | ±0.1pF             | GJM0224C1E1R4BB01# |
|        |               |                    |         | ±0.25pF            | GJM0224C1E1R4CB01# |
|        |               |                    | 1.5pF   | ±0.05pF            | GJM0224C1E1R5WB01# |
|        |               |                    |         | ±0.1pF             | GJM0224C1E1R5BB01# |
|        |               |                    |         | ±0.25pF            | GJM0224C1E1R5CB01# |
|        |               |                    | 1.6pF   | ±0.05pF            | GJM0224C1E1R6WB01# |
|        |               |                    |         | ±0.1pF             | GJM0224C1E1R6BB01# |
|        |               |                    |         | ±0.25pF            | GJM0224C1E1R6CB01# |
|        |               |                    | 1.7pF   | ±0.05pF            | GJM0224C1E1R7WB01# |
|        |               |                    |         | ±0.1pF             | GJM0224C1E1R7BB01# |
|        |               |                    |         | ±0.25pF            | GJM0224C1E1R7CB01# |
|        |               |                    | 1.8pF   | ±0.05pF            | GJM0224C1E1R8WB01# |
|        |               |                    |         | ±0.1pF             | GJM0224C1E1R8BB01# |
|        |               |                    |         | ±0.25pF            | GJM0224C1E1R8CB01# |
|        |               |                    | 1.9pF   | ±0.05pF            | GJM0224C1E1R9WB01# |
|        |               |                    |         | ±0.1pF             | GJM0224C1E1R9BB01# |
|        |               |                    |         | ±0.25pF            | GJM0224C1E1R9CB01# |
|        |               |                    | 2.0pF   | ±0.05pF            | GJM0224C1E2R0WB01# |
|        |               |                    |         | ±0.1pF             | GJM0224C1E2R0BB01# |
|        |               |                    |         | ±0.25pF            | GJM0224C1E2R0CB01# |
|        |               |                    | 2.1pF   | ±0.05pF            | GJM0223C1E2R1WB01# |
|        |               |                    |         | ±0.1pF             | GJM0223C1E2R1BB01# |
|        |               |                    |         | ±0.25pF            | GJM0223C1E2R1CB01# |
|        |               |                    | 2.2pF   | ±0.05pF            | GJM0223C1E2R2WB01# |
|        |               | ±0.1pF             |         | GJM0223C1E2R2BB01# |                    |
|        |               | ±0.25pF            |         | GJM0223C1E2R2CB01# |                    |
|        |               | 2.3pF              | ±0.05pF | GJM0223C1E2R3WB01# |                    |
|        |               |                    | ±0.1pF  | GJM0223C1E2R3BB01# |                    |
|        |               |                    | ±0.25pF | GJM0223C1E2R3CB01# |                    |
|        |               | 2.4pF              | ±0.05pF | GJM0223C1E2R4WB01# |                    |
|        |               |                    | ±0.1pF  | GJM0223C1E2R4BB01# |                    |
|        |               |                    | ±0.25pF | GJM0223C1E2R4CB01# |                    |
|        |               | 2.5pF              | ±0.05pF | GJM0223C1E2R5WB01# |                    |
|        |               |                    | ±0.1pF  | GJM0223C1E2R5BB01# |                    |
|        |               |                    | ±0.25pF | GJM0223C1E2R5CB01# |                    |
|        |               | 2.6pF              | ±0.05pF | GJM0223C1E2R6WB01# |                    |
|        |               |                    | ±0.1pF  | GJM0223C1E2R6BB01# |                    |
|        |               |                    | ±0.25pF | GJM0223C1E2R6CB01# |                    |
|        |               | 2.7pF              | ±0.05pF | GJM0223C1E2R7WB01# |                    |
|        |               |                    | ±0.1pF  | GJM0223C1E2R7BB01# |                    |
|        |               |                    | ±0.25pF | GJM0223C1E2R7CB01# |                    |
|        |               | 2.8pF              | ±0.05pF | GJM0223C1E2R8WB01# |                    |
|        |               |                    | ±0.1pF  | GJM0223C1E2R8BB01# |                    |
|        |               |                    | ±0.25pF | GJM0223C1E2R8CB01# |                    |
| 2.9pF  | ±0.05pF       | GJM0223C1E2R9WB01# |         |                    |                    |
|        | ±0.1pF        | GJM0223C1E2R9BB01# |         |                    |                    |
|        | ±0.25pF       | GJM0223C1E2R9CB01# |         |                    |                    |
| 3.0pF  | ±0.05pF       | GJM0223C1E3R0WB01# |         |                    |                    |
| CJ     | 25Vdc         | CJ                 | 2.1pF   | ±0.05pF            | GJM0223C1E2R1WB01# |
|        |               |                    |         | ±0.1pF             | GJM0223C1E2R1BB01# |
|        |               |                    | 2.2pF   | ±0.05pF            | GJM0223C1E2R2WB01# |
|        |               |                    |         | ±0.1pF             | GJM0223C1E2R2BB01# |
|        |               |                    |         | ±0.25pF            | GJM0223C1E2R2CB01# |
|        |               |                    | 2.3pF   | ±0.05pF            | GJM0223C1E2R3WB01# |
|        |               |                    |         | ±0.1pF             | GJM0223C1E2R3BB01# |
|        |               |                    |         | ±0.25pF            | GJM0223C1E2R3CB01# |
|        |               |                    | 2.4pF   | ±0.05pF            | GJM0223C1E2R4WB01# |
|        |               |                    |         | ±0.1pF             | GJM0223C1E2R4BB01# |
|        |               |                    |         | ±0.25pF            | GJM0223C1E2R4CB01# |
|        |               |                    | 2.5pF   | ±0.05pF            | GJM0223C1E2R5WB01# |
|        |               |                    |         | ±0.1pF             | GJM0223C1E2R5BB01# |
|        |               |                    |         | ±0.25pF            | GJM0223C1E2R5CB01# |
| 2.6pF  | ±0.05pF       | GJM0223C1E2R6WB01# |         |                    |                    |
|        | ±0.1pF        | GJM0223C1E2R6BB01# |         |                    |                    |
|        | ±0.25pF       | GJM0223C1E2R6CB01# |         |                    |                    |
| 2.7pF  | ±0.05pF       | GJM0223C1E2R7WB01# |         |                    |                    |
|        | ±0.1pF        | GJM0223C1E2R7BB01# |         |                    |                    |
|        | ±0.25pF       | GJM0223C1E2R7CB01# |         |                    |                    |
| 2.8pF  | ±0.05pF       | GJM0223C1E2R8WB01# |         |                    |                    |
|        | ±0.1pF        | GJM0223C1E2R8BB01# |         |                    |                    |
|        | ±0.25pF       | GJM0223C1E2R8CB01# |         |                    |                    |
| 2.9pF  | ±0.05pF       | GJM0223C1E2R9WB01# |         |                    |                    |
|        | ±0.1pF        | GJM0223C1E2R9BB01# |         |                    |                    |
|        | ±0.25pF       | GJM0223C1E2R9CB01# |         |                    |                    |

Part number # indicates the package specification code.

GRM Series  
 GJM Series  
 GMA Series  
 GMD Series  
 GQM Series  
 GRJ Series  
 GR3 Series  
 KRM Series  
 KR3 Series  
 LLA Series  
 LLL Series  
 LLM Series  
 LLR Series  
 ⚠Caution/ Notice

# GJM Series Temperature Compensating Type High Q Part Number List

(→ ■ 0.4x0.2mm)

| T max.  | Rated Voltage      | TC Code            | Cap.  | Tol.    | Part Number        |                    |
|---------|--------------------|--------------------|-------|---------|--------------------|--------------------|
| 0.22mm  | 25Vdc              | CJ                 | 3.0pF | ±0.1pF  | GJM0223C1E3R0BB01# |                    |
|         |                    |                    |       | ±0.25pF | GJM0223C1E3R0CB01# |                    |
|         |                    |                    | 3.1pF | ±0.05pF | GJM0223C1E3R1WB01# |                    |
|         |                    |                    |       | ±0.1pF  | GJM0223C1E3R1BB01# |                    |
|         |                    |                    |       | ±0.25pF | GJM0223C1E3R1CB01# |                    |
|         |                    |                    | 3.2pF | ±0.05pF | GJM0223C1E3R2WB01# |                    |
|         |                    |                    |       | ±0.1pF  | GJM0223C1E3R2BB01# |                    |
|         |                    |                    |       | ±0.25pF | GJM0223C1E3R2CB01# |                    |
|         |                    |                    | 3.3pF | ±0.05pF | GJM0223C1E3R3WB01# |                    |
|         |                    |                    |       | ±0.1pF  | GJM0223C1E3R3BB01# |                    |
|         |                    |                    |       | ±0.25pF | GJM0223C1E3R3CB01# |                    |
|         |                    |                    | 3.4pF | ±0.05pF | GJM0223C1E3R4WB01# |                    |
|         |                    |                    |       | ±0.1pF  | GJM0223C1E3R4BB01# |                    |
|         |                    |                    |       | ±0.25pF | GJM0223C1E3R4CB01# |                    |
|         |                    |                    | 3.5pF | ±0.05pF | GJM0223C1E3R5WB01# |                    |
|         |                    |                    |       | ±0.1pF  | GJM0223C1E3R5BB01# |                    |
|         |                    |                    |       | ±0.25pF | GJM0223C1E3R5CB01# |                    |
|         |                    |                    | 3.6pF | ±0.05pF | GJM0223C1E3R6WB01# |                    |
|         |                    |                    |       | ±0.1pF  | GJM0223C1E3R6BB01# |                    |
|         |                    |                    |       | ±0.25pF | GJM0223C1E3R6CB01# |                    |
|         |                    |                    | 3.7pF | ±0.05pF | GJM0223C1E3R7WB01# |                    |
|         |                    |                    |       | ±0.1pF  | GJM0223C1E3R7BB01# |                    |
|         |                    |                    |       | ±0.25pF | GJM0223C1E3R7CB01# |                    |
|         |                    |                    | 3.8pF | ±0.05pF | GJM0223C1E3R8WB01# |                    |
|         |                    |                    |       | ±0.1pF  | GJM0223C1E3R8BB01# |                    |
|         |                    |                    |       | ±0.25pF | GJM0223C1E3R8CB01# |                    |
|         |                    |                    | 3.9pF | ±0.05pF | GJM0223C1E3R9WB01# |                    |
|         |                    |                    |       | ±0.1pF  | GJM0223C1E3R9BB01# |                    |
|         |                    |                    |       | ±0.25pF | GJM0223C1E3R9CB01# |                    |
|         |                    |                    | CH    | 4.0pF   | ±0.05pF            | GJM0222C1E4R0WB01# |
|         |                    |                    |       |         | ±0.1pF             | GJM0222C1E4R0BB01# |
|         |                    |                    |       |         | ±0.25pF            | GJM0222C1E4R0CB01# |
|         |                    |                    |       | 4.1pF   | ±0.05pF            | GJM0222C1E4R1WB01# |
|         |                    |                    |       |         | ±0.1pF             | GJM0222C1E4R1BB01# |
|         |                    |                    |       |         | ±0.25pF            | GJM0222C1E4R1CB01# |
|         |                    |                    |       | 4.2pF   | ±0.05pF            | GJM0222C1E4R2WB01# |
|         |                    | ±0.1pF             |       |         | GJM0222C1E4R2BB01# |                    |
|         |                    | ±0.25pF            |       |         | GJM0222C1E4R2CB01# |                    |
|         |                    | 4.3pF              |       | ±0.05pF | GJM0222C1E4R3WB01# |                    |
|         |                    |                    |       | ±0.1pF  | GJM0222C1E4R3BB01# |                    |
|         |                    |                    |       | ±0.25pF | GJM0222C1E4R3CB01# |                    |
|         |                    | 4.4pF              |       | ±0.05pF | GJM0222C1E4R4WB01# |                    |
|         |                    |                    |       | ±0.1pF  | GJM0222C1E4R4BB01# |                    |
|         |                    |                    |       | ±0.25pF | GJM0222C1E4R4CB01# |                    |
|         |                    | 4.5pF              |       | ±0.05pF | GJM0222C1E4R5WB01# |                    |
|         |                    |                    |       | ±0.1pF  | GJM0222C1E4R5BB01# |                    |
|         |                    |                    |       | ±0.25pF | GJM0222C1E4R5CB01# |                    |
|         |                    | 4.6pF              |       | ±0.05pF | GJM0222C1E4R6WB01# |                    |
| ±0.1pF  | GJM0222C1E4R6BB01# |                    |       |         |                    |                    |
| ±0.25pF | GJM0222C1E4R6CB01# |                    |       |         |                    |                    |
| 4.7pF   | ±0.05pF            | GJM0222C1E4R7WB01# |       |         |                    |                    |
|         | ±0.1pF             | GJM0222C1E4R7BB01# |       |         |                    |                    |
|         | ±0.25pF            | GJM0222C1E4R7CB01# |       |         |                    |                    |
| 4.8pF   | ±0.05pF            | GJM0222C1E4R8WB01# |       |         |                    |                    |

| T max. | Rated Voltage | TC Code | Cap.  | Tol.    | Part Number        |
|--------|---------------|---------|-------|---------|--------------------|
| 0.22mm | 25Vdc         | CH      | 4.8pF | ±0.1pF  | GJM0222C1E4R8BB01# |
|        |               |         |       | ±0.25pF | GJM0222C1E4R8CB01# |
|        |               |         | 4.9pF | ±0.05pF | GJM0222C1E4R9WB01# |
|        |               |         |       | ±0.1pF  | GJM0222C1E4R9BB01# |
|        |               |         |       | ±0.25pF | GJM0222C1E4R9CB01# |
|        |               |         | 5.0pF | ±0.05pF | GJM0222C1E5R0WB01# |
|        |               |         |       | ±0.1pF  | GJM0222C1E5R0BB01# |
|        |               |         |       | ±0.25pF | GJM0222C1E5R0CB01# |
|        |               |         | 5.1pF | ±0.05pF | GJM0222C1E5R1WB01# |
|        |               |         |       | ±0.1pF  | GJM0222C1E5R1BB01# |
|        |               |         |       | ±0.25pF | GJM0222C1E5R1CB01# |
|        |               |         | 5.2pF | ±0.05pF | GJM0222C1E5R2WB01# |
|        |               |         |       | ±0.1pF  | GJM0222C1E5R2BB01# |
|        |               |         |       | ±0.25pF | GJM0222C1E5R2CB01# |
|        |               |         | 5.3pF | ±0.05pF | GJM0222C1E5R3WB01# |
|        |               |         |       | ±0.1pF  | GJM0222C1E5R3BB01# |
|        |               |         |       | ±0.25pF | GJM0222C1E5R3CB01# |
|        |               |         | 5.4pF | ±0.05pF | GJM0222C1E5R4WB01# |
|        |               |         |       | ±0.1pF  | GJM0222C1E5R4BB01# |
|        |               |         |       | ±0.25pF | GJM0222C1E5R4CB01# |
|        |               |         | 5.5pF | ±0.05pF | GJM0222C1E5R5WB01# |
|        |               |         |       | ±0.1pF  | GJM0222C1E5R5BB01# |
|        |               |         |       | ±0.25pF | GJM0222C1E5R5CB01# |
|        |               |         | 5.6pF | ±0.05pF | GJM0222C1E5R6WB01# |
|        |               |         |       | ±0.1pF  | GJM0222C1E5R6BB01# |
|        |               |         |       | ±0.25pF | GJM0222C1E5R6CB01# |
|        |               |         | 5.7pF | ±0.05pF | GJM0222C1E5R7WB01# |
|        |               |         |       | ±0.1pF  | GJM0222C1E5R7BB01# |
|        |               |         |       | ±0.25pF | GJM0222C1E5R7CB01# |
|        |               |         | 5.8pF | ±0.05pF | GJM0222C1E5R8WB01# |
|        |               |         |       | ±0.1pF  | GJM0222C1E5R8BB01# |
|        |               |         |       | ±0.25pF | GJM0222C1E5R8CB01# |
|        |               |         | 5.9pF | ±0.05pF | GJM0222C1E5R9WB01# |
|        |               |         |       | ±0.1pF  | GJM0222C1E5R9BB01# |
|        |               |         |       | ±0.25pF | GJM0222C1E5R9CB01# |
|        |               |         | 6.0pF | ±0.05pF | GJM0222C1E6R0WB01# |
|        |               |         |       | ±0.1pF  | GJM0222C1E6R0BB01# |
|        |               |         |       | ±0.25pF | GJM0222C1E6R0CB01# |
|        |               |         | 6.1pF | ±0.05pF | GJM0222C1E6R1WB01# |
|        |               |         |       | ±0.1pF  | GJM0222C1E6R1BB01# |
|        |               |         |       | ±0.25pF | GJM0222C1E6R1CB01# |
|        |               |         | 6.2pF | ±0.05pF | GJM0222C1E6R2WB01# |
|        |               |         |       | ±0.1pF  | GJM0222C1E6R2BB01# |

Part number # indicates the package specification code.

GRM Series  
 GJM Series  
 GMA Series  
 GMD Series  
 GQM Series  
 GRJ Series  
 GR3 Series  
 KRM Series  
 KR3 Series  
 LLA Series  
 LLL Series  
 LLM Series  
 LLR Series  
 ⚠Caution/  
 Notice

# GJM Series Temperature Compensating Type High Q Part Number List

(→ ■ 0.4x0.2mm)

| T max. | Rated Voltage | TC Code | Cap.  | Tol.    | Part Number               |
|--------|---------------|---------|-------|---------|---------------------------|
| 0.22mm | 25Vdc         | CH      | 6.2pF | ±0.25pF | <b>GJM0222C1E6R2CB01#</b> |
|        |               |         |       | ±0.5pF  | <b>GJM0222C1E6R2DB01#</b> |
|        |               |         | 6.3pF | ±0.05pF | <b>GJM0222C1E6R3WB01#</b> |
|        |               |         |       | ±0.1pF  | <b>GJM0222C1E6R3BB01#</b> |
|        |               |         |       | ±0.25pF | <b>GJM0222C1E6R3CB01#</b> |
|        |               |         |       | ±0.5pF  | <b>GJM0222C1E6R3DB01#</b> |
|        |               |         | 6.4pF | ±0.05pF | <b>GJM0222C1E6R4WB01#</b> |
|        |               |         |       | ±0.1pF  | <b>GJM0222C1E6R4BB01#</b> |
|        |               |         |       | ±0.25pF | <b>GJM0222C1E6R4CB01#</b> |
|        |               |         |       | ±0.5pF  | <b>GJM0222C1E6R4DB01#</b> |
|        |               |         | 6.5pF | ±0.05pF | <b>GJM0222C1E6R5WB01#</b> |
|        |               |         |       | ±0.1pF  | <b>GJM0222C1E6R5BB01#</b> |
|        |               |         |       | ±0.25pF | <b>GJM0222C1E6R5CB01#</b> |
|        |               |         |       | ±0.5pF  | <b>GJM0222C1E6R5DB01#</b> |
|        |               |         | 6.6pF | ±0.05pF | <b>GJM0222C1E6R6WB01#</b> |
|        |               |         |       | ±0.1pF  | <b>GJM0222C1E6R6BB01#</b> |
|        |               |         |       | ±0.25pF | <b>GJM0222C1E6R6CB01#</b> |
|        |               |         |       | ±0.5pF  | <b>GJM0222C1E6R6DB01#</b> |
|        |               |         | 6.7pF | ±0.05pF | <b>GJM0222C1E6R7WB01#</b> |
|        |               |         |       | ±0.1pF  | <b>GJM0222C1E6R7BB01#</b> |
|        |               |         |       | ±0.25pF | <b>GJM0222C1E6R7CB01#</b> |
|        |               |         |       | ±0.5pF  | <b>GJM0222C1E6R7DB01#</b> |
|        |               |         | 6.8pF | ±0.05pF | <b>GJM0222C1E6R8WB01#</b> |
|        |               |         |       | ±0.1pF  | <b>GJM0222C1E6R8BB01#</b> |
|        |               |         |       | ±0.25pF | <b>GJM0222C1E6R8CB01#</b> |
|        |               |         |       | ±0.5pF  | <b>GJM0222C1E6R8DB01#</b> |
|        |               |         | 6.9pF | ±0.05pF | <b>GJM0222C1E6R9WB01#</b> |
|        |               |         |       | ±0.1pF  | <b>GJM0222C1E6R9BB01#</b> |
|        |               |         |       | ±0.25pF | <b>GJM0222C1E6R9CB01#</b> |
|        |               |         |       | ±0.5pF  | <b>GJM0222C1E6R9DB01#</b> |
|        |               |         | 7.0pF | ±0.05pF | <b>GJM0222C1E7R0WB01#</b> |
|        |               |         |       | ±0.1pF  | <b>GJM0222C1E7R0BB01#</b> |
|        |               |         |       | ±0.25pF | <b>GJM0222C1E7R0CB01#</b> |
|        |               |         |       | ±0.5pF  | <b>GJM0222C1E7R0DB01#</b> |
|        |               |         | 7.1pF | ±0.05pF | <b>GJM0222C1E7R1WB01#</b> |
|        |               |         |       | ±0.1pF  | <b>GJM0222C1E7R1BB01#</b> |
|        |               |         |       | ±0.25pF | <b>GJM0222C1E7R1CB01#</b> |
|        |               |         |       | ±0.5pF  | <b>GJM0222C1E7R1DB01#</b> |
|        |               |         | 7.2pF | ±0.05pF | <b>GJM0222C1E7R2WB01#</b> |
|        |               |         |       | ±0.1pF  | <b>GJM0222C1E7R2BB01#</b> |
|        |               |         |       | ±0.25pF | <b>GJM0222C1E7R2CB01#</b> |
|        |               |         |       | ±0.5pF  | <b>GJM0222C1E7R2DB01#</b> |
|        |               |         | 7.3pF | ±0.05pF | <b>GJM0222C1E7R3WB01#</b> |
|        |               |         |       | ±0.1pF  | <b>GJM0222C1E7R3BB01#</b> |
|        |               |         |       | ±0.25pF | <b>GJM0222C1E7R3CB01#</b> |
|        |               |         |       | ±0.5pF  | <b>GJM0222C1E7R3DB01#</b> |
|        |               |         | 7.4pF | ±0.05pF | <b>GJM0222C1E7R4WB01#</b> |
|        |               |         |       | ±0.1pF  | <b>GJM0222C1E7R4BB01#</b> |
|        |               |         |       | ±0.25pF | <b>GJM0222C1E7R4CB01#</b> |
|        |               |         |       | ±0.5pF  | <b>GJM0222C1E7R4DB01#</b> |
|        |               |         | 7.5pF | ±0.05pF | <b>GJM0222C1E7R5WB01#</b> |
|        |               |         |       | ±0.1pF  | <b>GJM0222C1E7R5BB01#</b> |
|        |               |         |       | ±0.25pF | <b>GJM0222C1E7R5CB01#</b> |
|        |               |         |       | ±0.5pF  | <b>GJM0222C1E7R5DB01#</b> |

| T max. | Rated Voltage | TC Code | Cap.  | Tol.    | Part Number               |
|--------|---------------|---------|-------|---------|---------------------------|
| 0.22mm | 25Vdc         | CH      | 7.6pF | ±0.05pF | <b>GJM0222C1E7R6WB01#</b> |
|        |               |         |       | ±0.1pF  | <b>GJM0222C1E7R6BB01#</b> |
|        |               |         |       | ±0.25pF | <b>GJM0222C1E7R6CB01#</b> |
|        |               |         |       | ±0.5pF  | <b>GJM0222C1E7R6DB01#</b> |
|        |               |         | 7.7pF | ±0.05pF | <b>GJM0222C1E7R7WB01#</b> |
|        |               |         |       | ±0.1pF  | <b>GJM0222C1E7R7BB01#</b> |
|        |               |         |       | ±0.25pF | <b>GJM0222C1E7R7CB01#</b> |
|        |               |         |       | ±0.5pF  | <b>GJM0222C1E7R7DB01#</b> |
|        |               |         | 7.8pF | ±0.05pF | <b>GJM0222C1E7R8WB01#</b> |
|        |               |         |       | ±0.1pF  | <b>GJM0222C1E7R8BB01#</b> |
|        |               |         |       | ±0.25pF | <b>GJM0222C1E7R8CB01#</b> |
|        |               |         |       | ±0.5pF  | <b>GJM0222C1E7R8DB01#</b> |
|        |               |         | 7.9pF | ±0.05pF | <b>GJM0222C1E7R9WB01#</b> |
|        |               |         |       | ±0.1pF  | <b>GJM0222C1E7R9BB01#</b> |
|        |               |         |       | ±0.25pF | <b>GJM0222C1E7R9CB01#</b> |
|        |               |         |       | ±0.5pF  | <b>GJM0222C1E7R9DB01#</b> |
|        |               |         | 8.0pF | ±0.05pF | <b>GJM0222C1E8R0WB01#</b> |
|        |               |         |       | ±0.1pF  | <b>GJM0222C1E8R0BB01#</b> |
|        |               |         |       | ±0.25pF | <b>GJM0222C1E8R0CB01#</b> |
|        |               |         |       | ±0.5pF  | <b>GJM0222C1E8R0DB01#</b> |
|        |               |         | 8.1pF | ±0.05pF | <b>GJM0222C1E8R1WB01#</b> |
|        |               |         |       | ±0.1pF  | <b>GJM0222C1E8R1BB01#</b> |
|        |               |         |       | ±0.25pF | <b>GJM0222C1E8R1CB01#</b> |
|        |               |         |       | ±0.5pF  | <b>GJM0222C1E8R1DB01#</b> |
|        |               |         | 8.2pF | ±0.05pF | <b>GJM0222C1E8R2WB01#</b> |
|        |               |         |       | ±0.1pF  | <b>GJM0222C1E8R2BB01#</b> |
|        |               |         |       | ±0.25pF | <b>GJM0222C1E8R2CB01#</b> |
|        |               |         |       | ±0.5pF  | <b>GJM0222C1E8R2DB01#</b> |
|        |               |         | 8.3pF | ±0.05pF | <b>GJM0222C1E8R3WB01#</b> |
|        |               |         |       | ±0.1pF  | <b>GJM0222C1E8R3BB01#</b> |
|        |               |         |       | ±0.25pF | <b>GJM0222C1E8R3CB01#</b> |
|        |               |         |       | ±0.5pF  | <b>GJM0222C1E8R3DB01#</b> |
|        |               |         | 8.4pF | ±0.05pF | <b>GJM0222C1E8R4WB01#</b> |
|        |               |         |       | ±0.1pF  | <b>GJM0222C1E8R4BB01#</b> |
|        |               |         |       | ±0.25pF | <b>GJM0222C1E8R4CB01#</b> |
|        |               |         |       | ±0.5pF  | <b>GJM0222C1E8R4DB01#</b> |
|        |               |         | 8.5pF | ±0.05pF | <b>GJM0222C1E8R5WB01#</b> |
|        |               |         |       | ±0.1pF  | <b>GJM0222C1E8R5BB01#</b> |
|        |               |         |       | ±0.25pF | <b>GJM0222C1E8R5CB01#</b> |
|        |               |         |       | ±0.5pF  | <b>GJM0222C1E8R5DB01#</b> |
|        |               |         | 8.6pF | ±0.05pF | <b>GJM0222C1E8R6WB01#</b> |
|        |               |         |       | ±0.1pF  | <b>GJM0222C1E8R6BB01#</b> |
|        |               |         |       | ±0.25pF | <b>GJM0222C1E8R6CB01#</b> |
|        |               |         |       | ±0.5pF  | <b>GJM0222C1E8R6DB01#</b> |
|        |               |         | 8.7pF | ±0.05pF | <b>GJM0222C1E8R7WB01#</b> |
|        |               |         |       | ±0.1pF  | <b>GJM0222C1E8R7BB01#</b> |
|        |               |         |       | ±0.25pF | <b>GJM0222C1E8R7CB01#</b> |
|        |               |         |       | ±0.5pF  | <b>GJM0222C1E8R7DB01#</b> |
|        |               |         | 8.8pF | ±0.05pF | <b>GJM0222C1E8R8WB01#</b> |
|        |               |         |       | ±0.1pF  | <b>GJM0222C1E8R8BB01#</b> |
|        |               |         |       | ±0.25pF | <b>GJM0222C1E8R8CB01#</b> |
|        |               |         |       | ±0.5pF  | <b>GJM0222C1E8R8DB01#</b> |
|        |               |         | 8.9pF | ±0.05pF | <b>GJM0222C1E8R9WB01#</b> |
|        |               |         |       | ±0.1pF  | <b>GJM0222C1E8R9BB01#</b> |

Part number # indicates the package specification code.

GRM Series  
 GJM Series  
 GMA Series  
 GMD Series  
 GQM Series  
 GRJ Series  
 GR3 Series  
 KRM Series  
 KR3 Series  
 LLA Series  
 LLL Series  
 LLM Series  
 LLR Series  
 ⚠Caution/ Notice

# GJM Series Temperature Compensating Type High Q Part Number List

(→ ■ 0.4x0.2mm)

| T max. | Rated Voltage | TC Code | Cap.  | Tol.    | Part Number               |
|--------|---------------|---------|-------|---------|---------------------------|
| 0.22mm | 25Vdc         | CH      | 8.9pF | ±0.25pF | <b>GJM0222C1E8R9CB01#</b> |
|        |               |         |       | ±0.5pF  | <b>GJM0222C1E8R9DB01#</b> |
|        |               |         | 9.0pF | ±0.05pF | <b>GJM0222C1E9R0WB01#</b> |
|        |               |         |       | ±0.1pF  | <b>GJM0222C1E9R0BB01#</b> |
|        |               |         |       | ±0.25pF | <b>GJM0222C1E9R0CB01#</b> |
|        |               |         |       | ±0.5pF  | <b>GJM0222C1E9R0DB01#</b> |
|        |               |         | 9.1pF | ±0.05pF | <b>GJM0222C1E9R1WB01#</b> |
|        |               |         |       | ±0.1pF  | <b>GJM0222C1E9R1BB01#</b> |
|        |               |         |       | ±0.25pF | <b>GJM0222C1E9R1CB01#</b> |
|        |               |         |       | ±0.5pF  | <b>GJM0222C1E9R1DB01#</b> |
|        |               |         | 9.2pF | ±0.05pF | <b>GJM0222C1E9R2WB01#</b> |
|        |               |         |       | ±0.1pF  | <b>GJM0222C1E9R2BB01#</b> |
|        |               |         |       | ±0.25pF | <b>GJM0222C1E9R2CB01#</b> |
|        |               |         |       | ±0.5pF  | <b>GJM0222C1E9R2DB01#</b> |
|        |               |         | 9.3pF | ±0.05pF | <b>GJM0222C1E9R3WB01#</b> |
|        |               |         |       | ±0.1pF  | <b>GJM0222C1E9R3BB01#</b> |
|        |               |         |       | ±0.25pF | <b>GJM0222C1E9R3CB01#</b> |
|        |               |         |       | ±0.5pF  | <b>GJM0222C1E9R3DB01#</b> |
|        |               |         | 9.4pF | ±0.05pF | <b>GJM0222C1E9R4WB01#</b> |
|        |               |         |       | ±0.1pF  | <b>GJM0222C1E9R4BB01#</b> |
|        |               |         |       | ±0.25pF | <b>GJM0222C1E9R4CB01#</b> |
|        |               |         |       | ±0.5pF  | <b>GJM0222C1E9R4DB01#</b> |
|        |               |         | 9.5pF | ±0.05pF | <b>GJM0222C1E9R5WB01#</b> |
|        |               |         |       | ±0.1pF  | <b>GJM0222C1E9R5BB01#</b> |
|        |               |         |       | ±0.25pF | <b>GJM0222C1E9R5CB01#</b> |
|        |               |         |       | ±0.5pF  | <b>GJM0222C1E9R5DB01#</b> |
|        |               |         | 9.6pF | ±0.05pF | <b>GJM0222C1E9R6WB01#</b> |
|        |               |         |       | ±0.1pF  | <b>GJM0222C1E9R6BB01#</b> |
|        |               |         |       | ±0.25pF | <b>GJM0222C1E9R6CB01#</b> |
|        |               |         |       | ±0.5pF  | <b>GJM0222C1E9R6DB01#</b> |
|        |               |         | 9.7pF | ±0.05pF | <b>GJM0222C1E9R7WB01#</b> |
|        |               |         |       | ±0.1pF  | <b>GJM0222C1E9R7BB01#</b> |
|        |               |         |       | ±0.25pF | <b>GJM0222C1E9R7CB01#</b> |
|        |               |         |       | ±0.5pF  | <b>GJM0222C1E9R7DB01#</b> |
|        |               |         | 9.8pF | ±0.05pF | <b>GJM0222C1E9R8WB01#</b> |
|        |               |         |       | ±0.1pF  | <b>GJM0222C1E9R8BB01#</b> |
|        |               |         |       | ±0.25pF | <b>GJM0222C1E9R8CB01#</b> |
|        |               |         |       | ±0.5pF  | <b>GJM0222C1E9R8DB01#</b> |
|        |               |         | 9.9pF | ±0.05pF | <b>GJM0222C1E9R9WB01#</b> |
|        |               |         |       | ±0.1pF  | <b>GJM0222C1E9R9BB01#</b> |
|        |               |         |       | ±0.25pF | <b>GJM0222C1E9R9CB01#</b> |
|        |               |         |       | ±0.5pF  | <b>GJM0222C1E9R9DB01#</b> |
|        |               |         | 10pF  | ±2%     | <b>GJM0222C1E100GB01#</b> |
|        |               |         |       | ±5%     | <b>GJM0222C1E100JB01#</b> |
|        |               |         | 11pF  | ±2%     | <b>GJM0222C1E110GB01#</b> |
|        |               |         |       | ±5%     | <b>GJM0222C1E110JB01#</b> |
|        |               |         | 12pF  | ±2%     | <b>GJM0222C1E120GB01#</b> |
|        |               |         |       | ±5%     | <b>GJM0222C1E120JB01#</b> |
|        |               |         | 13pF  | ±2%     | <b>GJM0222C1E130GB01#</b> |
|        |               |         |       | ±5%     | <b>GJM0222C1E130JB01#</b> |
|        |               |         | 15pF  | ±2%     | <b>GJM0222C1E150GB01#</b> |
|        |               |         |       | ±5%     | <b>GJM0222C1E150JB01#</b> |
|        |               |         | 16pF  | ±2%     | <b>GJM0222C1E160GB01#</b> |
|        |               |         |       | ±5%     | <b>GJM0222C1E160JB01#</b> |

| T max. | Rated Voltage | TC Code | Cap. | Tol. | Part Number               |
|--------|---------------|---------|------|------|---------------------------|
| 0.22mm | 25Vdc         | CH      | 18pF | ±2%  | <b>GJM0222C1E180GB01#</b> |
|        |               |         |      | ±5%  | <b>GJM0222C1E180JB01#</b> |
|        |               |         | 20pF | ±2%  | <b>GJM0222C1E200GB01#</b> |
|        |               |         |      | ±5%  | <b>GJM0222C1E200JB01#</b> |
|        |               |         | 22pF | ±2%  | <b>GJM0222C1E220GB01#</b> |
|        |               |         |      | ±5%  | <b>GJM0222C1E220JB01#</b> |

■ 0.6x0.3mm Ultra-compact

| T max. | Rated Voltage | TC Code | Cap.   | Tol.    | Part Number               |
|--------|---------------|---------|--------|---------|---------------------------|
| 0.33mm | 25Vdc         | COG     | 0.20pF | ±0.05pF | <b>GJM0335C1ER20WB01#</b> |
|        |               |         |        | ±0.1pF  | <b>GJM0335C1ER20BB01#</b> |
|        |               |         | 0.30pF | ±0.05pF | <b>GJM0335C1ER30WB01#</b> |
|        |               |         |        | ±0.1pF  | <b>GJM0335C1ER30BB01#</b> |
|        |               |         | 0.40pF | ±0.05pF | <b>GJM0335C1ER40WB01#</b> |
|        |               |         |        | ±0.1pF  | <b>GJM0335C1ER40BB01#</b> |
|        |               |         | 0.50pF | ±0.05pF | <b>GJM0335C1ER50WB01#</b> |
|        |               |         |        | ±0.1pF  | <b>GJM0335C1ER50BB01#</b> |
|        |               |         | 0.60pF | ±0.05pF | <b>GJM0335C1ER60WB01#</b> |
|        |               |         |        | ±0.1pF  | <b>GJM0335C1ER60BB01#</b> |
|        |               |         | 0.70pF | ±0.05pF | <b>GJM0335C1ER70WB01#</b> |
|        |               |         |        | ±0.1pF  | <b>GJM0335C1ER70BB01#</b> |
|        |               |         | 0.80pF | ±0.05pF | <b>GJM0335C1ER80WB01#</b> |
|        |               |         |        | ±0.1pF  | <b>GJM0335C1ER80BB01#</b> |
|        |               |         | 0.90pF | ±0.05pF | <b>GJM0335C1ER90WB01#</b> |
|        |               |         |        | ±0.1pF  | <b>GJM0335C1ER90BB01#</b> |
|        |               |         | 1.0pF  | ±0.05pF | <b>GJM0335C1E1R0WB01#</b> |
|        |               |         |        | ±0.1pF  | <b>GJM0335C1E1R0BB01#</b> |
|        |               |         |        | ±0.25pF | <b>GJM0335C1E1R0CB01#</b> |
|        |               |         | 1.1pF  | ±0.05pF | <b>GJM0335C1E1R1WB01#</b> |
|        |               |         |        | ±0.1pF  | <b>GJM0335C1E1R1BB01#</b> |
|        |               |         |        | ±0.25pF | <b>GJM0335C1E1R1CB01#</b> |
|        |               |         | 1.2pF  | ±0.05pF | <b>GJM0335C1E1R2WB01#</b> |
|        |               |         |        | ±0.1pF  | <b>GJM0335C1E1R2BB01#</b> |
|        |               |         |        | ±0.25pF | <b>GJM0335C1E1R2CB01#</b> |
|        |               |         | 1.3pF  | ±0.05pF | <b>GJM0335C1E1R3WB01#</b> |
|        |               |         |        | ±0.1pF  | <b>GJM0335C1E1R3BB01#</b> |
|        |               |         |        | ±0.25pF | <b>GJM0335C1E1R3CB01#</b> |
|        |               |         | 1.4pF  | ±0.05pF | <b>GJM0335C1E1R4WB01#</b> |
|        |               |         |        | ±0.1pF  | <b>GJM0335C1E1R4BB01#</b> |
|        |               |         |        | ±0.25pF | <b>GJM0335C1E1R4CB01#</b> |
|        |               |         | 1.5pF  | ±0.05pF | <b>GJM0335C1E1R5WB01#</b> |
|        |               |         |        | ±0.1pF  | <b>GJM0335C1E1R5BB01#</b> |
|        |               |         |        | ±0.25pF | <b>GJM0335C1E1R5CB01#</b> |
|        |               |         | 1.6pF  | ±0.05pF | <b>GJM0335C1E1R6WB01#</b> |
|        |               |         |        | ±0.1pF  | <b>GJM0335C1E1R6BB01#</b> |
|        |               |         |        | ±0.25pF | <b>GJM0335C1E1R6CB01#</b> |
|        |               |         | 1.7pF  | ±0.05pF | <b>GJM0335C1E1R7WB01#</b> |
|        |               |         |        | ±0.1pF  | <b>GJM0335C1E1R7BB01#</b> |
|        |               |         |        | ±0.25pF | <b>GJM0335C1E1R7CB01#</b> |
|        |               |         | 1.8pF  | ±0.05pF | <b>GJM0335C1E1R8WB01#</b> |
|        |               |         |        | ±0.1pF  | <b>GJM0335C1E1R8BB01#</b> |
|        |               |         |        | ±0.25pF | <b>GJM0335C1E1R8CB01#</b> |

Part number # indicates the package specification code.

GRM Series  
 GJM Series  
 GMA Series  
 GMD Series  
 GQM Series  
 GRJ Series  
 GR3 Series  
 KRM Series  
 KR3 Series  
 LLA Series  
 LLL Series  
 LLM Series  
 LLR Series  
 ⚠Caution/  
 Notice



# GJM Series Temperature Compensating Type High Q Part Number List

(→ ■ 0.6x0.3mm)

| T max. | Rated Voltage | TC Code | Cap.  | Tol.    | Part Number               |
|--------|---------------|---------|-------|---------|---------------------------|
| 0.33mm | 25Vdc         | C0G     | 1.9pF | ±0.05pF | <b>GJM0335C1E1R9WB01#</b> |
|        |               |         |       | ±0.1pF  | <b>GJM0335C1E1R9BB01#</b> |
|        |               |         |       | ±0.25pF | <b>GJM0335C1E1R9CB01#</b> |
|        |               |         | 2.0pF | ±0.05pF | <b>GJM0335C1E2R0WB01#</b> |
|        |               |         |       | ±0.1pF  | <b>GJM0335C1E2R0BB01#</b> |
|        |               |         |       | ±0.25pF | <b>GJM0335C1E2R0CB01#</b> |
|        |               |         | 2.1pF | ±0.05pF | <b>GJM0335C1E2R1WB01#</b> |
|        |               |         |       | ±0.1pF  | <b>GJM0335C1E2R1BB01#</b> |
|        |               |         |       | ±0.25pF | <b>GJM0335C1E2R1CB01#</b> |
|        |               |         | 2.2pF | ±0.05pF | <b>GJM0335C1E2R2WB01#</b> |
|        |               |         |       | ±0.1pF  | <b>GJM0335C1E2R2BB01#</b> |
|        |               |         |       | ±0.25pF | <b>GJM0335C1E2R2CB01#</b> |
|        |               |         | 2.3pF | ±0.05pF | <b>GJM0335C1E2R3WB01#</b> |
|        |               |         |       | ±0.1pF  | <b>GJM0335C1E2R3BB01#</b> |
|        |               |         |       | ±0.25pF | <b>GJM0335C1E2R3CB01#</b> |
|        |               |         | 2.4pF | ±0.05pF | <b>GJM0335C1E2R4WB01#</b> |
|        |               |         |       | ±0.1pF  | <b>GJM0335C1E2R4BB01#</b> |
|        |               |         |       | ±0.25pF | <b>GJM0335C1E2R4CB01#</b> |
|        |               |         | 2.5pF | ±0.05pF | <b>GJM0335C1E2R5WB01#</b> |
|        |               |         |       | ±0.1pF  | <b>GJM0335C1E2R5BB01#</b> |
|        |               |         |       | ±0.25pF | <b>GJM0335C1E2R5CB01#</b> |
|        |               |         | 2.6pF | ±0.05pF | <b>GJM0335C1E2R6WB01#</b> |
|        |               |         |       | ±0.1pF  | <b>GJM0335C1E2R6BB01#</b> |
|        |               |         |       | ±0.25pF | <b>GJM0335C1E2R6CB01#</b> |
|        |               |         | 2.7pF | ±0.05pF | <b>GJM0335C1E2R7WB01#</b> |
|        |               |         |       | ±0.1pF  | <b>GJM0335C1E2R7BB01#</b> |
|        |               |         |       | ±0.25pF | <b>GJM0335C1E2R7CB01#</b> |
|        |               |         | 2.8pF | ±0.05pF | <b>GJM0335C1E2R8WB01#</b> |
|        |               |         |       | ±0.1pF  | <b>GJM0335C1E2R8BB01#</b> |
|        |               |         |       | ±0.25pF | <b>GJM0335C1E2R8CB01#</b> |
|        |               |         | 2.9pF | ±0.05pF | <b>GJM0335C1E2R9WB01#</b> |
|        |               |         |       | ±0.1pF  | <b>GJM0335C1E2R9BB01#</b> |
|        |               |         |       | ±0.25pF | <b>GJM0335C1E2R9CB01#</b> |
|        |               |         | 3.0pF | ±0.05pF | <b>GJM0335C1E3R0WB01#</b> |
|        |               |         |       | ±0.1pF  | <b>GJM0335C1E3R0BB01#</b> |
|        |               |         |       | ±0.25pF | <b>GJM0335C1E3R0CB01#</b> |
|        |               |         | 3.1pF | ±0.05pF | <b>GJM0335C1E3R1WB01#</b> |
|        |               |         |       | ±0.1pF  | <b>GJM0335C1E3R1BB01#</b> |
|        |               |         |       | ±0.25pF | <b>GJM0335C1E3R1CB01#</b> |
|        |               |         | 3.2pF | ±0.05pF | <b>GJM0335C1E3R2WB01#</b> |
|        |               |         |       | ±0.1pF  | <b>GJM0335C1E3R2BB01#</b> |
|        |               |         |       | ±0.25pF | <b>GJM0335C1E3R2CB01#</b> |
|        |               |         | 3.3pF | ±0.05pF | <b>GJM0335C1E3R3WB01#</b> |
|        |               |         |       | ±0.1pF  | <b>GJM0335C1E3R3BB01#</b> |
|        |               |         |       | ±0.25pF | <b>GJM0335C1E3R3CB01#</b> |
|        |               |         | 3.4pF | ±0.05pF | <b>GJM0335C1E3R4WB01#</b> |
|        |               |         |       | ±0.1pF  | <b>GJM0335C1E3R4BB01#</b> |
|        |               |         |       | ±0.25pF | <b>GJM0335C1E3R4CB01#</b> |
|        |               |         | 3.5pF | ±0.05pF | <b>GJM0335C1E3R5WB01#</b> |
|        |               |         |       | ±0.1pF  | <b>GJM0335C1E3R5BB01#</b> |
|        |               |         |       | ±0.25pF | <b>GJM0335C1E3R5CB01#</b> |
|        |               |         | 3.6pF | ±0.05pF | <b>GJM0335C1E3R6WB01#</b> |
|        |               |         |       | ±0.1pF  | <b>GJM0335C1E3R6BB01#</b> |
|        |               |         |       | ±0.25pF | <b>GJM0335C1E3R6CB01#</b> |

| T max. | Rated Voltage | TC Code | Cap.  | Tol.    | Part Number               |        |                           |
|--------|---------------|---------|-------|---------|---------------------------|--------|---------------------------|
| 0.33mm | 25Vdc         | C0G     | 3.7pF | ±0.05pF | <b>GJM0335C1E3R7WB01#</b> |        |                           |
|        |               |         |       | ±0.1pF  | <b>GJM0335C1E3R7BB01#</b> |        |                           |
|        |               |         |       | ±0.25pF | <b>GJM0335C1E3R7CB01#</b> |        |                           |
|        |               |         | 3.8pF | ±0.05pF | <b>GJM0335C1E3R8WB01#</b> |        |                           |
|        |               |         |       | ±0.1pF  | <b>GJM0335C1E3R8BB01#</b> |        |                           |
|        |               |         |       | ±0.25pF | <b>GJM0335C1E3R8CB01#</b> |        |                           |
|        |               |         | 3.9pF | ±0.05pF | <b>GJM0335C1E3R9WB01#</b> |        |                           |
|        |               |         |       | ±0.1pF  | <b>GJM0335C1E3R9BB01#</b> |        |                           |
|        |               |         |       | ±0.25pF | <b>GJM0335C1E3R9CB01#</b> |        |                           |
|        |               |         | 4.0pF | ±0.05pF | <b>GJM0335C1E4R0WB01#</b> |        |                           |
|        |               |         |       | ±0.1pF  | <b>GJM0335C1E4R0BB01#</b> |        |                           |
|        |               |         |       | ±0.25pF | <b>GJM0335C1E4R0CB01#</b> |        |                           |
|        |               |         | 4.1pF | ±0.05pF | <b>GJM0335C1E4R1WB01#</b> |        |                           |
|        |               |         |       | ±0.1pF  | <b>GJM0335C1E4R1BB01#</b> |        |                           |
|        |               |         |       | ±0.25pF | <b>GJM0335C1E4R1CB01#</b> |        |                           |
|        |               |         | 4.2pF | ±0.05pF | <b>GJM0335C1E4R2WB01#</b> |        |                           |
|        |               |         |       | ±0.1pF  | <b>GJM0335C1E4R2BB01#</b> |        |                           |
|        |               |         |       | ±0.25pF | <b>GJM0335C1E4R2CB01#</b> |        |                           |
|        |               |         | 4.3pF | ±0.05pF | <b>GJM0335C1E4R3WB01#</b> |        |                           |
|        |               |         |       | ±0.1pF  | <b>GJM0335C1E4R3BB01#</b> |        |                           |
|        |               |         |       | ±0.25pF | <b>GJM0335C1E4R3CB01#</b> |        |                           |
|        |               |         | 4.4pF | ±0.05pF | <b>GJM0335C1E4R4WB01#</b> |        |                           |
|        |               |         |       | ±0.1pF  | <b>GJM0335C1E4R4BB01#</b> |        |                           |
|        |               |         |       | ±0.25pF | <b>GJM0335C1E4R4CB01#</b> |        |                           |
|        |               |         | 4.5pF | ±0.05pF | <b>GJM0335C1E4R5WB01#</b> |        |                           |
|        |               |         |       | ±0.1pF  | <b>GJM0335C1E4R5BB01#</b> |        |                           |
|        |               |         |       | ±0.25pF | <b>GJM0335C1E4R5CB01#</b> |        |                           |
|        |               |         | 4.6pF | ±0.05pF | <b>GJM0335C1E4R6WB01#</b> |        |                           |
|        |               |         |       | ±0.1pF  | <b>GJM0335C1E4R6BB01#</b> |        |                           |
|        |               |         |       | ±0.25pF | <b>GJM0335C1E4R6CB01#</b> |        |                           |
|        |               |         | 4.7pF | ±0.05pF | <b>GJM0335C1E4R7WB01#</b> |        |                           |
|        |               |         |       | ±0.1pF  | <b>GJM0335C1E4R7BB01#</b> |        |                           |
|        |               |         |       | ±0.25pF | <b>GJM0335C1E4R7CB01#</b> |        |                           |
|        |               |         | 4.8pF | ±0.05pF | <b>GJM0335C1E4R8WB01#</b> |        |                           |
|        |               |         |       | ±0.1pF  | <b>GJM0335C1E4R8BB01#</b> |        |                           |
|        |               |         |       | ±0.25pF | <b>GJM0335C1E4R8CB01#</b> |        |                           |
|        |               |         | 4.9pF | ±0.05pF | <b>GJM0335C1E4R9WB01#</b> |        |                           |
|        |               |         |       | ±0.1pF  | <b>GJM0335C1E4R9BB01#</b> |        |                           |
|        |               |         |       | ±0.25pF | <b>GJM0335C1E4R9CB01#</b> |        |                           |
|        |               |         | 5.0pF | ±0.05pF | <b>GJM0335C1E5R0WB01#</b> |        |                           |
|        |               |         |       | ±0.1pF  | <b>GJM0335C1E5R0BB01#</b> |        |                           |
|        |               |         |       | ±0.25pF | <b>GJM0335C1E5R0CB01#</b> |        |                           |
|        |               |         | 5.1pF | ±0.05pF | <b>GJM0335C1E5R1WB01#</b> |        |                           |
|        |               |         |       | ±0.1pF  | <b>GJM0335C1E5R1BB01#</b> |        |                           |
|        |               |         |       | ±0.25pF | <b>GJM0335C1E5R1CB01#</b> |        |                           |
|        |               |         | 5.2pF | ±0.05pF | <b>GJM0335C1E5R2WB01#</b> |        |                           |
|        |               |         |       | ±0.1pF  | <b>GJM0335C1E5R2BB01#</b> |        |                           |
|        |               |         |       | ±0.25pF | <b>GJM0335C1E5R2CB01#</b> |        |                           |
|        |               |         | 5.3pF | ±0.05pF | <b>GJM0335C1E5R3WB01#</b> |        |                           |
|        |               |         |       | ±0.1pF  | <b>GJM0335C1E5R3BB01#</b> |        |                           |
|        |               |         |       | ±0.25pF | <b>GJM0335C1E5R3CB01#</b> |        |                           |
|        |               |         |       |         |                           | ±0.5pF | <b>GJM0335C1E5R3DB01#</b> |

Part number # indicates the package specification code.

GRM Series  
 GJM Series  
 GMA Series  
 GMD Series  
 GQM Series  
 GRJ Series  
 GR3 Series  
 KRM Series  
 KR3 Series  
 LLA Series  
 LLL Series  
 LLM Series  
 LLR Series  
 ⚠Caution/ Notice

# GJM Series Temperature Compensating Type High Q Part Number List

(→ ■ 0.6x0.3mm)

| T max. | Rated Voltage | TC Code | Cap.  | Tol.    | Part Number               |
|--------|---------------|---------|-------|---------|---------------------------|
| 0.33mm | 25Vdc         | COG     | 5.4pF | ±0.05pF | <b>GJM0335C1E5R4WB01#</b> |
|        |               |         |       | ±0.1pF  | <b>GJM0335C1E5R4BB01#</b> |
|        |               |         |       | ±0.25pF | <b>GJM0335C1E5R4CB01#</b> |
|        |               |         |       | ±0.5pF  | <b>GJM0335C1E5R4DB01#</b> |
|        |               |         | 5.5pF | ±0.05pF | <b>GJM0335C1E5R5WB01#</b> |
|        |               |         |       | ±0.1pF  | <b>GJM0335C1E5R5BB01#</b> |
|        |               |         |       | ±0.25pF | <b>GJM0335C1E5R5CB01#</b> |
|        |               |         |       | ±0.5pF  | <b>GJM0335C1E5R5DB01#</b> |
|        |               |         | 5.6pF | ±0.05pF | <b>GJM0335C1E5R6WB01#</b> |
|        |               |         |       | ±0.1pF  | <b>GJM0335C1E5R6BB01#</b> |
|        |               |         |       | ±0.25pF | <b>GJM0335C1E5R6CB01#</b> |
|        |               |         |       | ±0.5pF  | <b>GJM0335C1E5R6DB01#</b> |
|        |               |         | 5.7pF | ±0.05pF | <b>GJM0335C1E5R7WB01#</b> |
|        |               |         |       | ±0.1pF  | <b>GJM0335C1E5R7BB01#</b> |
|        |               |         |       | ±0.25pF | <b>GJM0335C1E5R7CB01#</b> |
|        |               |         |       | ±0.5pF  | <b>GJM0335C1E5R7DB01#</b> |
|        |               |         | 5.8pF | ±0.05pF | <b>GJM0335C1E5R8WB01#</b> |
|        |               |         |       | ±0.1pF  | <b>GJM0335C1E5R8BB01#</b> |
|        |               |         |       | ±0.25pF | <b>GJM0335C1E5R8CB01#</b> |
|        |               |         |       | ±0.5pF  | <b>GJM0335C1E5R8DB01#</b> |
|        |               |         | 5.9pF | ±0.05pF | <b>GJM0335C1E5R9WB01#</b> |
|        |               |         |       | ±0.1pF  | <b>GJM0335C1E5R9BB01#</b> |
|        |               |         |       | ±0.25pF | <b>GJM0335C1E5R9CB01#</b> |
|        |               |         |       | ±0.5pF  | <b>GJM0335C1E5R9DB01#</b> |
|        |               |         | 6.0pF | ±0.05pF | <b>GJM0335C1E6R0WB01#</b> |
|        |               |         |       | ±0.1pF  | <b>GJM0335C1E6R0BB01#</b> |
|        |               |         |       | ±0.25pF | <b>GJM0335C1E6R0CB01#</b> |
|        |               |         |       | ±0.5pF  | <b>GJM0335C1E6R0DB01#</b> |
|        |               |         | 6.1pF | ±0.05pF | <b>GJM0335C1E6R1WB01#</b> |
|        |               |         |       | ±0.1pF  | <b>GJM0335C1E6R1BB01#</b> |
|        |               |         |       | ±0.25pF | <b>GJM0335C1E6R1CB01#</b> |
|        |               |         |       | ±0.5pF  | <b>GJM0335C1E6R1DB01#</b> |
|        |               |         | 6.2pF | ±0.05pF | <b>GJM0335C1E6R2WB01#</b> |
|        |               |         |       | ±0.1pF  | <b>GJM0335C1E6R2BB01#</b> |
|        |               |         |       | ±0.25pF | <b>GJM0335C1E6R2CB01#</b> |
|        |               |         |       | ±0.5pF  | <b>GJM0335C1E6R2DB01#</b> |
|        |               |         | 6.3pF | ±0.05pF | <b>GJM0335C1E6R3WB01#</b> |
|        |               |         |       | ±0.1pF  | <b>GJM0335C1E6R3BB01#</b> |
|        |               |         |       | ±0.25pF | <b>GJM0335C1E6R3CB01#</b> |
|        |               |         |       | ±0.5pF  | <b>GJM0335C1E6R3DB01#</b> |
|        |               |         | 6.4pF | ±0.05pF | <b>GJM0335C1E6R4WB01#</b> |
|        |               |         |       | ±0.1pF  | <b>GJM0335C1E6R4BB01#</b> |
|        |               |         |       | ±0.25pF | <b>GJM0335C1E6R4CB01#</b> |
|        |               |         |       | ±0.5pF  | <b>GJM0335C1E6R4DB01#</b> |
|        |               |         | 6.5pF | ±0.05pF | <b>GJM0335C1E6R5WB01#</b> |
|        |               |         |       | ±0.1pF  | <b>GJM0335C1E6R5BB01#</b> |
|        |               |         |       | ±0.25pF | <b>GJM0335C1E6R5CB01#</b> |
|        |               |         |       | ±0.5pF  | <b>GJM0335C1E6R5DB01#</b> |
|        |               |         | 6.6pF | ±0.05pF | <b>GJM0335C1E6R6WB01#</b> |
|        |               |         |       | ±0.1pF  | <b>GJM0335C1E6R6BB01#</b> |
|        |               |         |       | ±0.25pF | <b>GJM0335C1E6R6CB01#</b> |
|        |               |         |       | ±0.5pF  | <b>GJM0335C1E6R6DB01#</b> |
|        |               |         | 6.7pF | ±0.05pF | <b>GJM0335C1E6R7WB01#</b> |
|        |               |         |       | ±0.1pF  | <b>GJM0335C1E6R7BB01#</b> |

| T max. | Rated Voltage | TC Code | Cap.  | Tol.    | Part Number               |
|--------|---------------|---------|-------|---------|---------------------------|
| 0.33mm | 25Vdc         | COG     | 6.7pF | ±0.25pF | <b>GJM0335C1E6R7CB01#</b> |
|        |               |         |       | ±0.5pF  | <b>GJM0335C1E6R7DB01#</b> |
|        |               |         | 6.8pF | ±0.05pF | <b>GJM0335C1E6R8WB01#</b> |
|        |               |         |       | ±0.1pF  | <b>GJM0335C1E6R8BB01#</b> |
|        |               |         |       | ±0.25pF | <b>GJM0335C1E6R8CB01#</b> |
|        |               |         | 6.9pF | ±0.05pF | <b>GJM0335C1E6R9WB01#</b> |
|        |               |         |       | ±0.1pF  | <b>GJM0335C1E6R9BB01#</b> |
|        |               |         |       | ±0.25pF | <b>GJM0335C1E6R9CB01#</b> |
|        |               |         | 7.0pF | ±0.05pF | <b>GJM0335C1E7R0WB01#</b> |
|        |               |         |       | ±0.1pF  | <b>GJM0335C1E7R0BB01#</b> |
|        |               |         |       | ±0.25pF | <b>GJM0335C1E7R0CB01#</b> |
|        |               |         | 7.1pF | ±0.05pF | <b>GJM0335C1E7R1WB01#</b> |
|        |               |         |       | ±0.1pF  | <b>GJM0335C1E7R1BB01#</b> |
|        |               |         |       | ±0.25pF | <b>GJM0335C1E7R1CB01#</b> |
|        |               |         | 7.2pF | ±0.05pF | <b>GJM0335C1E7R2WB01#</b> |
|        |               |         |       | ±0.1pF  | <b>GJM0335C1E7R2BB01#</b> |
|        |               |         |       | ±0.25pF | <b>GJM0335C1E7R2CB01#</b> |
|        |               |         | 7.3pF | ±0.05pF | <b>GJM0335C1E7R3WB01#</b> |
|        |               |         |       | ±0.1pF  | <b>GJM0335C1E7R3BB01#</b> |
|        |               |         |       | ±0.25pF | <b>GJM0335C1E7R3CB01#</b> |
|        |               |         | 7.4pF | ±0.05pF | <b>GJM0335C1E7R4WB01#</b> |
|        |               |         |       | ±0.1pF  | <b>GJM0335C1E7R4BB01#</b> |
|        |               |         |       | ±0.25pF | <b>GJM0335C1E7R4CB01#</b> |
|        |               |         | 7.5pF | ±0.05pF | <b>GJM0335C1E7R5WB01#</b> |
|        |               |         |       | ±0.1pF  | <b>GJM0335C1E7R5BB01#</b> |
|        |               |         |       | ±0.25pF | <b>GJM0335C1E7R5CB01#</b> |
|        |               |         | 7.6pF | ±0.05pF | <b>GJM0335C1E7R6WB01#</b> |
|        |               |         |       | ±0.1pF  | <b>GJM0335C1E7R6BB01#</b> |
|        |               |         |       | ±0.25pF | <b>GJM0335C1E7R6CB01#</b> |
|        |               |         | 7.7pF | ±0.05pF | <b>GJM0335C1E7R7WB01#</b> |
|        |               |         |       | ±0.1pF  | <b>GJM0335C1E7R7BB01#</b> |
|        |               |         |       | ±0.25pF | <b>GJM0335C1E7R7CB01#</b> |
|        |               |         | 7.8pF | ±0.05pF | <b>GJM0335C1E7R8WB01#</b> |
|        |               |         |       | ±0.1pF  | <b>GJM0335C1E7R8BB01#</b> |
|        |               |         |       | ±0.25pF | <b>GJM0335C1E7R8CB01#</b> |
|        |               |         | 7.9pF | ±0.05pF | <b>GJM0335C1E7R9WB01#</b> |
|        |               |         |       | ±0.1pF  | <b>GJM0335C1E7R9BB01#</b> |
|        |               |         |       | ±0.25pF | <b>GJM0335C1E7R9CB01#</b> |
|        |               |         | 8.0pF | ±0.05pF | <b>GJM0335C1E8R0WB01#</b> |
|        |               |         |       | ±0.1pF  | <b>GJM0335C1E8R0BB01#</b> |
|        |               |         |       | ±0.25pF | <b>GJM0335C1E8R0CB01#</b> |

Part number # indicates the package specification code.

GRM Series  
**GJM Series**  
 GMA Series  
 GMD Series  
 GQM Series  
 GRJ Series  
 GR3 Series  
 KRM Series  
 KR3 Series  
 LLA Series  
 LLL Series  
 LLM Series  
 LLR Series  
 ⚠Caution/  
 Notice

# GJM Series Temperature Compensating Type High Q Part Number List

(→ ■ 0.6x0.3mm)

| T max. | Rated Voltage | TC Code                   | Cap.  | Tol.    | Part Number               |
|--------|---------------|---------------------------|-------|---------|---------------------------|
| 0.33mm | 25Vdc         | COG                       | 8.1pF | ±0.05pF | <b>GJM0335C1E8R1WB01#</b> |
|        |               |                           |       | ±0.1pF  | <b>GJM0335C1E8R1BB01#</b> |
|        |               |                           |       | ±0.25pF | <b>GJM0335C1E8R1CB01#</b> |
|        |               |                           |       | ±0.5pF  | <b>GJM0335C1E8R1DB01#</b> |
|        |               |                           | 8.2pF | ±0.05pF | <b>GJM0335C1E8R2WB01#</b> |
|        |               |                           |       | ±0.1pF  | <b>GJM0335C1E8R2BB01#</b> |
|        |               |                           |       | ±0.25pF | <b>GJM0335C1E8R2CB01#</b> |
|        |               |                           |       | ±0.5pF  | <b>GJM0335C1E8R2DB01#</b> |
|        |               |                           | 8.3pF | ±0.05pF | <b>GJM0335C1E8R3WB01#</b> |
|        |               |                           |       | ±0.1pF  | <b>GJM0335C1E8R3BB01#</b> |
|        |               |                           |       | ±0.25pF | <b>GJM0335C1E8R3CB01#</b> |
|        |               |                           |       | ±0.5pF  | <b>GJM0335C1E8R3DB01#</b> |
|        |               |                           | 8.4pF | ±0.05pF | <b>GJM0335C1E8R4WB01#</b> |
|        |               |                           |       | ±0.1pF  | <b>GJM0335C1E8R4BB01#</b> |
|        |               |                           |       | ±0.25pF | <b>GJM0335C1E8R4CB01#</b> |
|        |               |                           |       | ±0.5pF  | <b>GJM0335C1E8R4DB01#</b> |
|        |               |                           | 8.5pF | ±0.05pF | <b>GJM0335C1E8R5WB01#</b> |
|        |               |                           |       | ±0.1pF  | <b>GJM0335C1E8R5BB01#</b> |
|        |               |                           |       | ±0.25pF | <b>GJM0335C1E8R5CB01#</b> |
|        |               |                           |       | ±0.5pF  | <b>GJM0335C1E8R5DB01#</b> |
|        |               |                           | 8.6pF | ±0.05pF | <b>GJM0335C1E8R6WB01#</b> |
|        |               |                           |       | ±0.1pF  | <b>GJM0335C1E8R6BB01#</b> |
|        |               |                           |       | ±0.25pF | <b>GJM0335C1E8R6CB01#</b> |
|        |               |                           |       | ±0.5pF  | <b>GJM0335C1E8R6DB01#</b> |
|        |               |                           | 8.7pF | ±0.05pF | <b>GJM0335C1E8R7WB01#</b> |
|        |               |                           |       | ±0.1pF  | <b>GJM0335C1E8R7BB01#</b> |
|        |               |                           |       | ±0.25pF | <b>GJM0335C1E8R7CB01#</b> |
|        |               |                           |       | ±0.5pF  | <b>GJM0335C1E8R7DB01#</b> |
|        |               |                           | 8.8pF | ±0.05pF | <b>GJM0335C1E8R8WB01#</b> |
|        |               |                           |       | ±0.1pF  | <b>GJM0335C1E8R8BB01#</b> |
|        |               |                           |       | ±0.25pF | <b>GJM0335C1E8R8CB01#</b> |
|        |               |                           |       | ±0.5pF  | <b>GJM0335C1E8R8DB01#</b> |
|        |               |                           | 8.9pF | ±0.05pF | <b>GJM0335C1E8R9WB01#</b> |
|        |               |                           |       | ±0.1pF  | <b>GJM0335C1E8R9BB01#</b> |
|        |               |                           |       | ±0.25pF | <b>GJM0335C1E8R9CB01#</b> |
|        |               |                           |       | ±0.5pF  | <b>GJM0335C1E8R9DB01#</b> |
|        |               |                           | 9.0pF | ±0.05pF | <b>GJM0335C1E9R0WB01#</b> |
|        |               |                           |       | ±0.1pF  | <b>GJM0335C1E9R0BB01#</b> |
|        |               |                           |       | ±0.25pF | <b>GJM0335C1E9R0CB01#</b> |
|        |               |                           |       | ±0.5pF  | <b>GJM0335C1E9R0DB01#</b> |
|        |               |                           | 9.1pF | ±0.05pF | <b>GJM0335C1E9R1WB01#</b> |
|        |               |                           |       | ±0.1pF  | <b>GJM0335C1E9R1BB01#</b> |
|        |               |                           |       | ±0.25pF | <b>GJM0335C1E9R1CB01#</b> |
|        |               |                           |       | ±0.5pF  | <b>GJM0335C1E9R1DB01#</b> |
|        |               |                           | 9.2pF | ±0.05pF | <b>GJM0335C1E9R2WB01#</b> |
|        |               |                           |       | ±0.1pF  | <b>GJM0335C1E9R2BB01#</b> |
|        |               |                           |       | ±0.25pF | <b>GJM0335C1E9R2CB01#</b> |
|        |               |                           |       | ±0.5pF  | <b>GJM0335C1E9R2DB01#</b> |
|        |               |                           | 9.3pF | ±0.05pF | <b>GJM0335C1E9R3WB01#</b> |
|        |               |                           |       | ±0.1pF  | <b>GJM0335C1E9R3BB01#</b> |
|        |               |                           |       | ±0.25pF | <b>GJM0335C1E9R3CB01#</b> |
|        |               |                           |       | ±0.5pF  | <b>GJM0335C1E9R3DB01#</b> |
| 9.4pF  | ±0.05pF       | <b>GJM0335C1E9R4WB01#</b> |       |         |                           |
|        | ±0.1pF        | <b>GJM0335C1E9R4BB01#</b> |       |         |                           |

| T max. | Rated Voltage | TC Code | Cap.   | Tol.                      | Part Number               |  |  |
|--------|---------------|---------|--------|---------------------------|---------------------------|--|--|
| 0.33mm | 25Vdc         | COG     | 9.4pF  | ±0.25pF                   | <b>GJM0335C1E9R4CB01#</b> |  |  |
|        |               |         |        | ±0.5pF                    | <b>GJM0335C1E9R4DB01#</b> |  |  |
|        |               |         | 9.5pF  | ±0.05pF                   | <b>GJM0335C1E9R5WB01#</b> |  |  |
|        |               |         |        | ±0.1pF                    | <b>GJM0335C1E9R5BB01#</b> |  |  |
|        |               |         |        | ±0.25pF                   | <b>GJM0335C1E9R5CB01#</b> |  |  |
|        |               |         | 9.6pF  | ±0.05pF                   | <b>GJM0335C1E9R6WB01#</b> |  |  |
|        |               |         |        | ±0.1pF                    | <b>GJM0335C1E9R6BB01#</b> |  |  |
|        |               |         |        | ±0.25pF                   | <b>GJM0335C1E9R6CB01#</b> |  |  |
|        |               |         | 9.7pF  | ±0.05pF                   | <b>GJM0335C1E9R7WB01#</b> |  |  |
|        |               |         |        | ±0.1pF                    | <b>GJM0335C1E9R7BB01#</b> |  |  |
|        |               |         |        | ±0.25pF                   | <b>GJM0335C1E9R7CB01#</b> |  |  |
|        |               |         | 9.8pF  | ±0.05pF                   | <b>GJM0335C1E9R8WB01#</b> |  |  |
|        |               |         |        | ±0.1pF                    | <b>GJM0335C1E9R8BB01#</b> |  |  |
|        |               |         |        | ±0.25pF                   | <b>GJM0335C1E9R8CB01#</b> |  |  |
|        |               |         | 9.9pF  | ±0.05pF                   | <b>GJM0335C1E9R9WB01#</b> |  |  |
|        |               |         |        | ±0.1pF                    | <b>GJM0335C1E9R9BB01#</b> |  |  |
|        |               |         |        | ±0.25pF                   | <b>GJM0335C1E9R9CB01#</b> |  |  |
|        |               |         | 10pF   | ±2%                       | <b>GJM0335C1E100GB01#</b> |  |  |
|        |               |         |        | ±5%                       | <b>GJM0335C1E100JB01#</b> |  |  |
|        |               |         | 11pF   | ±2%                       | <b>GJM0335C1E110GB01#</b> |  |  |
|        |               |         |        | ±5%                       | <b>GJM0335C1E110JB01#</b> |  |  |
|        |               |         | 12pF   | ±2%                       | <b>GJM0335C1E120GB01#</b> |  |  |
|        |               |         |        | ±5%                       | <b>GJM0335C1E120JB01#</b> |  |  |
|        |               |         | 13pF   | ±2%                       | <b>GJM0335C1E130GB01#</b> |  |  |
|        |               |         |        | ±5%                       | <b>GJM0335C1E130JB01#</b> |  |  |
|        |               |         | 15pF   | ±2%                       | <b>GJM0335C1E150GB01#</b> |  |  |
|        |               |         |        | ±5%                       | <b>GJM0335C1E150JB01#</b> |  |  |
|        |               |         | 16pF   | ±2%                       | <b>GJM0335C1E160GB01#</b> |  |  |
|        |               |         |        | ±5%                       | <b>GJM0335C1E160JB01#</b> |  |  |
|        |               |         | 18pF   | ±2%                       | <b>GJM0335C1E180GB01#</b> |  |  |
|        |               |         |        | ±5%                       | <b>GJM0335C1E180JB01#</b> |  |  |
|        |               |         | 20pF   | ±2%                       | <b>GJM0335C1E200GB01#</b> |  |  |
|        |               |         |        | ±5%                       | <b>GJM0335C1E200JB01#</b> |  |  |
|        |               |         | 22pF   | ±2%                       | <b>GJM0335C1E220GB01#</b> |  |  |
|        |               |         |        | ±5%                       | <b>GJM0335C1E220JB01#</b> |  |  |
|        |               |         | 24pF   | ±2%                       | <b>GJM0335C1E240GB01#</b> |  |  |
|        |               |         |        | ±5%                       | <b>GJM0335C1E240JB01#</b> |  |  |
|        |               |         | 27pF   | ±2%                       | <b>GJM0335C1E270GB01#</b> |  |  |
|        |               |         |        | ±5%                       | <b>GJM0335C1E270JB01#</b> |  |  |
|        |               |         | 30pF   | ±2%                       | <b>GJM0335C1E300GB01#</b> |  |  |
|        |               |         |        | ±5%                       | <b>GJM0335C1E300JB01#</b> |  |  |
|        |               |         | 33pF   | ±2%                       | <b>GJM0335C1E330GB01#</b> |  |  |
|        |               |         |        | ±5%                       | <b>GJM0335C1E330JB01#</b> |  |  |
|        |               |         | 0.20pF | ±0.05pF                   | <b>GJM0334C1ER20WB01#</b> |  |  |
|        |               |         |        | ±0.1pF                    | <b>GJM0334C1ER20BB01#</b> |  |  |
|        |               |         | 0.30pF | ±0.05pF                   | <b>GJM0334C1ER30WB01#</b> |  |  |
|        |               |         |        | ±0.1pF                    | <b>GJM0334C1ER30BB01#</b> |  |  |
|        |               |         | 0.40pF | ±0.05pF                   | <b>GJM0334C1ER40WB01#</b> |  |  |
|        |               | ±0.1pF  |        | <b>GJM0334C1ER40BB01#</b> |                           |  |  |
|        |               |         |        | CK                        |                           |  |  |

Part number # indicates the package specification code.

GRM Series  
GJM Series  
GMA Series  
GMD Series  
GQM Series  
GRJ Series  
GR3 Series  
KRM Series  
KR3 Series  
LLA Series  
LLL Series  
LLM Series  
LLR Series  
⚠Caution/ Notice

# GJM Series Temperature Compensating Type High Q Part Number List

(→ ■ 0.6x0.3mm)

| T max.  | Rated Voltage             | TC Code | Cap.                      | Tol.                      | Part Number                |
|---------|---------------------------|---------|---------------------------|---------------------------|----------------------------|
| 0.33mm  | 25Vdc                     | CK      | 0.50pF                    | ±0.05pF                   | <b>GJM0334C1E1R50WB01#</b> |
|         |                           |         |                           | ±0.1pF                    | <b>GJM0334C1E1R50BB01#</b> |
|         |                           |         | 0.60pF                    | ±0.05pF                   | <b>GJM0334C1E1R60WB01#</b> |
|         |                           |         |                           | ±0.1pF                    | <b>GJM0334C1E1R60BB01#</b> |
|         |                           |         | 0.70pF                    | ±0.05pF                   | <b>GJM0334C1E1R70WB01#</b> |
|         |                           |         |                           | ±0.1pF                    | <b>GJM0334C1E1R70BB01#</b> |
|         |                           |         | 0.80pF                    | ±0.05pF                   | <b>GJM0334C1E1R80WB01#</b> |
|         |                           |         |                           | ±0.1pF                    | <b>GJM0334C1E1R80BB01#</b> |
|         |                           |         | 0.90pF                    | ±0.05pF                   | <b>GJM0334C1E1R90WB01#</b> |
|         |                           |         |                           | ±0.1pF                    | <b>GJM0334C1E1R90BB01#</b> |
|         |                           |         | 1.0pF                     | ±0.05pF                   | <b>GJM0334C1E1R0WB01#</b>  |
|         |                           |         |                           | ±0.1pF                    | <b>GJM0334C1E1R0BB01#</b>  |
|         |                           |         |                           | ±0.25pF                   | <b>GJM0334C1E1R0CB01#</b>  |
|         |                           |         | 1.1pF                     | ±0.05pF                   | <b>GJM0334C1E1R1WB01#</b>  |
|         |                           |         |                           | ±0.1pF                    | <b>GJM0334C1E1R1BB01#</b>  |
|         |                           |         |                           | ±0.25pF                   | <b>GJM0334C1E1R1CB01#</b>  |
|         |                           |         | 1.2pF                     | ±0.05pF                   | <b>GJM0334C1E1R2WB01#</b>  |
|         |                           |         |                           | ±0.1pF                    | <b>GJM0334C1E1R2BB01#</b>  |
|         |                           |         |                           | ±0.25pF                   | <b>GJM0334C1E1R2CB01#</b>  |
|         |                           |         | 1.3pF                     | ±0.05pF                   | <b>GJM0334C1E1R3WB01#</b>  |
|         |                           |         |                           | ±0.1pF                    | <b>GJM0334C1E1R3BB01#</b>  |
|         |                           |         |                           | ±0.25pF                   | <b>GJM0334C1E1R3CB01#</b>  |
|         |                           |         | 1.4pF                     | ±0.05pF                   | <b>GJM0334C1E1R4WB01#</b>  |
|         |                           |         |                           | ±0.1pF                    | <b>GJM0334C1E1R4BB01#</b>  |
|         |                           | ±0.25pF |                           | <b>GJM0334C1E1R4CB01#</b> |                            |
|         |                           | 1.5pF   | ±0.05pF                   | <b>GJM0334C1E1R5WB01#</b> |                            |
|         |                           |         | ±0.1pF                    | <b>GJM0334C1E1R5BB01#</b> |                            |
|         |                           |         | ±0.25pF                   | <b>GJM0334C1E1R5CB01#</b> |                            |
|         |                           | 1.6pF   | ±0.05pF                   | <b>GJM0334C1E1R6WB01#</b> |                            |
|         |                           |         | ±0.1pF                    | <b>GJM0334C1E1R6BB01#</b> |                            |
|         |                           |         | ±0.25pF                   | <b>GJM0334C1E1R6CB01#</b> |                            |
|         |                           | 1.7pF   | ±0.05pF                   | <b>GJM0334C1E1R7WB01#</b> |                            |
|         |                           |         | ±0.1pF                    | <b>GJM0334C1E1R7BB01#</b> |                            |
|         |                           |         | ±0.25pF                   | <b>GJM0334C1E1R7CB01#</b> |                            |
|         |                           | 1.8pF   | ±0.05pF                   | <b>GJM0334C1E1R8WB01#</b> |                            |
|         |                           |         | ±0.1pF                    | <b>GJM0334C1E1R8BB01#</b> |                            |
|         |                           |         | ±0.25pF                   | <b>GJM0334C1E1R8CB01#</b> |                            |
|         |                           | 1.9pF   | ±0.05pF                   | <b>GJM0334C1E1R9WB01#</b> |                            |
|         |                           |         | ±0.1pF                    | <b>GJM0334C1E1R9BB01#</b> |                            |
|         |                           |         | ±0.25pF                   | <b>GJM0334C1E1R9CB01#</b> |                            |
|         |                           | 2.0pF   | ±0.05pF                   | <b>GJM0334C1E2R0WB01#</b> |                            |
|         |                           |         | ±0.1pF                    | <b>GJM0334C1E2R0BB01#</b> |                            |
|         |                           |         | ±0.25pF                   | <b>GJM0334C1E2R0CB01#</b> |                            |
|         |                           | CJ      | 2.1pF                     | ±0.05pF                   | <b>GJM0333C1E2R1WB01#</b>  |
|         |                           |         |                           | ±0.1pF                    | <b>GJM0333C1E2R1BB01#</b>  |
|         |                           |         |                           | ±0.25pF                   | <b>GJM0333C1E2R1CB01#</b>  |
|         |                           |         | 2.2pF                     | ±0.05pF                   | <b>GJM0333C1E2R2WB01#</b>  |
|         |                           |         |                           | ±0.1pF                    | <b>GJM0333C1E2R2BB01#</b>  |
| ±0.25pF | <b>GJM0333C1E2R2CB01#</b> |         |                           |                           |                            |
| 2.3pF   | ±0.05pF                   |         | <b>GJM0333C1E2R3WB01#</b> |                           |                            |
|         | ±0.1pF                    |         | <b>GJM0333C1E2R3BB01#</b> |                           |                            |
|         | ±0.25pF                   |         | <b>GJM0333C1E2R3CB01#</b> |                           |                            |
| 2.4pF   | ±0.05pF                   |         | <b>GJM0333C1E2R4WB01#</b> |                           |                            |
|         | ±0.1pF                    |         | <b>GJM0333C1E2R4BB01#</b> |                           |                            |

| T max.  | Rated Voltage             | TC Code                   | Cap.    | Tol.                      | Part Number               |
|---------|---------------------------|---------------------------|---------|---------------------------|---------------------------|
| 0.33mm  | 25Vdc                     | CJ                        | 2.4pF   | ±0.25pF                   | <b>GJM0333C1E2R4CB01#</b> |
|         |                           |                           |         | ±0.05pF                   | <b>GJM0333C1E2R5WB01#</b> |
|         |                           |                           | 2.5pF   | ±0.05pF                   | <b>GJM0333C1E2R5WB01#</b> |
|         |                           |                           |         | ±0.1pF                    | <b>GJM0333C1E2R5BB01#</b> |
|         |                           |                           | 2.6pF   | ±0.25pF                   | <b>GJM0333C1E2R5CB01#</b> |
|         |                           |                           |         | ±0.05pF                   | <b>GJM0333C1E2R6WB01#</b> |
|         |                           |                           |         | ±0.1pF                    | <b>GJM0333C1E2R6BB01#</b> |
|         |                           |                           | 2.7pF   | ±0.25pF                   | <b>GJM0333C1E2R6CB01#</b> |
|         |                           |                           |         | ±0.05pF                   | <b>GJM0333C1E2R7WB01#</b> |
|         |                           |                           | 2.8pF   | ±0.1pF                    | <b>GJM0333C1E2R7BB01#</b> |
|         |                           |                           |         | ±0.25pF                   | <b>GJM0333C1E2R7CB01#</b> |
|         |                           |                           |         | ±0.05pF                   | <b>GJM0333C1E2R8WB01#</b> |
|         |                           |                           | 2.9pF   | ±0.1pF                    | <b>GJM0333C1E2R8BB01#</b> |
|         |                           |                           |         | ±0.25pF                   | <b>GJM0333C1E2R8CB01#</b> |
|         |                           |                           |         | ±0.05pF                   | <b>GJM0333C1E2R9WB01#</b> |
|         |                           |                           | 3.0pF   | ±0.1pF                    | <b>GJM0333C1E2R9BB01#</b> |
|         |                           |                           |         | ±0.25pF                   | <b>GJM0333C1E2R9CB01#</b> |
|         |                           |                           |         | ±0.05pF                   | <b>GJM0333C1E3R0WB01#</b> |
|         |                           |                           | 3.1pF   | ±0.1pF                    | <b>GJM0333C1E3R0BB01#</b> |
|         |                           |                           |         | ±0.25pF                   | <b>GJM0333C1E3R0CB01#</b> |
|         |                           |                           |         | ±0.05pF                   | <b>GJM0333C1E3R1WB01#</b> |
|         |                           |                           | 3.2pF   | ±0.1pF                    | <b>GJM0333C1E3R1BB01#</b> |
|         |                           |                           |         | ±0.25pF                   | <b>GJM0333C1E3R1CB01#</b> |
|         |                           |                           |         | ±0.05pF                   | <b>GJM0333C1E3R2WB01#</b> |
|         |                           | 3.3pF                     | ±0.1pF  | <b>GJM0333C1E3R2BB01#</b> |                           |
|         |                           |                           | ±0.25pF | <b>GJM0333C1E3R2CB01#</b> |                           |
|         |                           |                           | ±0.05pF | <b>GJM0333C1E3R3WB01#</b> |                           |
|         |                           | 3.4pF                     | ±0.1pF  | <b>GJM0333C1E3R3BB01#</b> |                           |
|         |                           |                           | ±0.25pF | <b>GJM0333C1E3R3CB01#</b> |                           |
|         |                           |                           | ±0.05pF | <b>GJM0333C1E3R4WB01#</b> |                           |
|         |                           | 3.5pF                     | ±0.1pF  | <b>GJM0333C1E3R4BB01#</b> |                           |
|         |                           |                           | ±0.25pF | <b>GJM0333C1E3R4CB01#</b> |                           |
|         |                           |                           | ±0.05pF | <b>GJM0333C1E3R5WB01#</b> |                           |
|         |                           | 3.6pF                     | ±0.1pF  | <b>GJM0333C1E3R5BB01#</b> |                           |
|         |                           |                           | ±0.25pF | <b>GJM0333C1E3R5CB01#</b> |                           |
|         |                           |                           | ±0.05pF | <b>GJM0333C1E3R6WB01#</b> |                           |
|         |                           | 3.7pF                     | ±0.1pF  | <b>GJM0333C1E3R6BB01#</b> |                           |
|         |                           |                           | ±0.25pF | <b>GJM0333C1E3R6CB01#</b> |                           |
|         |                           |                           | ±0.05pF | <b>GJM0333C1E3R7WB01#</b> |                           |
|         |                           | 3.8pF                     | ±0.1pF  | <b>GJM0333C1E3R7BB01#</b> |                           |
|         |                           |                           | ±0.25pF | <b>GJM0333C1E3R7CB01#</b> |                           |
|         |                           |                           | ±0.05pF | <b>GJM0333C1E3R8WB01#</b> |                           |
|         |                           | 3.9pF                     | ±0.1pF  | <b>GJM0333C1E3R8BB01#</b> |                           |
|         |                           |                           | ±0.25pF | <b>GJM0333C1E3R8CB01#</b> |                           |
|         |                           |                           | ±0.05pF | <b>GJM0333C1E3R9WB01#</b> |                           |
|         |                           | 4.0pF                     | ±0.1pF  | <b>GJM0333C1E3R9BB01#</b> |                           |
|         |                           |                           | ±0.25pF | <b>GJM0333C1E3R9CB01#</b> |                           |
|         |                           |                           | CH      | ±0.05pF                   | <b>GJM0332C1E4R0WB01#</b> |
| ±0.1pF  | <b>GJM0332C1E4R0BB01#</b> |                           |         |                           |                           |
| ±0.25pF | <b>GJM0332C1E4R0CB01#</b> |                           |         |                           |                           |
| 4.1pF   | ±0.05pF                   | <b>GJM0332C1E4R1WB01#</b> |         |                           |                           |
|         | ±0.1pF                    | <b>GJM0332C1E4R1BB01#</b> |         |                           |                           |
|         | ±0.25pF                   | <b>GJM0332C1E4R1CB01#</b> |         |                           |                           |
| 4.2pF   | ±0.05pF                   | <b>GJM0332C1E4R2WB01#</b> |         |                           |                           |
|         | ±0.1pF                    | <b>GJM0332C1E4R2BB01#</b> |         |                           |                           |

Part number # indicates the package specification code.

GRM Series  
 GJM Series  
 GMA Series  
 GMD Series  
 GQM Series  
 GRJ Series  
 GR3 Series  
 KRM Series  
 KR3 Series  
 LLA Series  
 LLL Series  
 LLM Series  
 LLR Series  
 △Caution/  
 Notice

# GJM Series Temperature Compensating Type High Q Part Number List

(→ ■ 0.6x0.3mm)

| T max. | Rated Voltage | TC Code | Cap.    | Tol.               | Part Number        |                    |
|--------|---------------|---------|---------|--------------------|--------------------|--------------------|
| 0.33mm | 25Vdc         | CH      | 4.2pF   | ±0.25pF            | GJM0332C1E4R2CB01# |                    |
|        |               |         |         | ±0.05pF            | GJM0332C1E4R3WB01# |                    |
|        |               |         |         |                    | ±0.1pF             | GJM0332C1E4R3BB01# |
|        |               |         | ±0.25pF | GJM0332C1E4R3CB01# |                    |                    |
|        |               |         |         | 4.4pF              | ±0.05pF            | GJM0332C1E4R4WB01# |
|        |               |         |         |                    | ±0.1pF             | GJM0332C1E4R4BB01# |
|        |               |         | ±0.25pF |                    | GJM0332C1E4R4CB01# |                    |
|        |               |         | 4.5pF   | ±0.05pF            | GJM0332C1E4R5WB01# |                    |
|        |               |         |         | ±0.1pF             | GJM0332C1E4R5BB01# |                    |
|        |               |         |         | ±0.25pF            | GJM0332C1E4R5CB01# |                    |
|        |               |         | 4.6pF   | ±0.05pF            | GJM0332C1E4R6WB01# |                    |
|        |               |         |         | ±0.1pF             | GJM0332C1E4R6BB01# |                    |
|        |               |         |         | ±0.25pF            | GJM0332C1E4R6CB01# |                    |
|        |               |         | 4.7pF   | ±0.05pF            | GJM0332C1E4R7WB01# |                    |
|        |               |         |         | ±0.1pF             | GJM0332C1E4R7BB01# |                    |
|        |               |         |         | ±0.25pF            | GJM0332C1E4R7CB01# |                    |
|        |               |         | 4.8pF   | ±0.05pF            | GJM0332C1E4R8WB01# |                    |
|        |               |         |         | ±0.1pF             | GJM0332C1E4R8BB01# |                    |
|        |               |         |         | ±0.25pF            | GJM0332C1E4R8CB01# |                    |
|        |               |         | 4.9pF   | ±0.05pF            | GJM0332C1E4R9WB01# |                    |
|        |               |         |         | ±0.1pF             | GJM0332C1E4R9BB01# |                    |
|        |               |         |         | ±0.25pF            | GJM0332C1E4R9CB01# |                    |
|        |               |         | 5.0pF   | ±0.05pF            | GJM0332C1E5R0WB01# |                    |
|        |               |         |         | ±0.1pF             | GJM0332C1E5R0BB01# |                    |
|        |               |         |         | ±0.25pF            | GJM0332C1E5R0CB01# |                    |
|        |               |         | 5.1pF   | ±0.05pF            | GJM0332C1E5R1WB01# |                    |
|        |               |         |         | ±0.1pF             | GJM0332C1E5R1BB01# |                    |
|        |               |         |         | ±0.25pF            | GJM0332C1E5R1CB01# |                    |
|        |               |         |         | ±0.5pF             | GJM0332C1E5R1DB01# |                    |
|        |               |         | 5.2pF   | ±0.05pF            | GJM0332C1E5R2WB01# |                    |
|        |               |         |         | ±0.1pF             | GJM0332C1E5R2BB01# |                    |
|        |               |         |         | ±0.25pF            | GJM0332C1E5R2CB01# |                    |
|        |               |         |         | ±0.5pF             | GJM0332C1E5R2DB01# |                    |
|        |               |         | 5.3pF   | ±0.05pF            | GJM0332C1E5R3WB01# |                    |
|        |               |         |         | ±0.1pF             | GJM0332C1E5R3BB01# |                    |
|        |               |         |         | ±0.25pF            | GJM0332C1E5R3CB01# |                    |
|        |               |         |         | ±0.5pF             | GJM0332C1E5R3DB01# |                    |
|        |               |         | 5.4pF   | ±0.05pF            | GJM0332C1E5R4WB01# |                    |
|        |               |         |         | ±0.1pF             | GJM0332C1E5R4BB01# |                    |
|        |               |         |         | ±0.25pF            | GJM0332C1E5R4CB01# |                    |
|        |               |         |         | ±0.5pF             | GJM0332C1E5R4DB01# |                    |
|        |               |         | 5.5pF   | ±0.05pF            | GJM0332C1E5R5WB01# |                    |
|        |               |         |         | ±0.1pF             | GJM0332C1E5R5BB01# |                    |
|        |               |         |         | ±0.25pF            | GJM0332C1E5R5CB01# |                    |
|        |               |         |         | ±0.5pF             | GJM0332C1E5R5DB01# |                    |
|        |               |         | 5.6pF   | ±0.05pF            | GJM0332C1E5R6WB01# |                    |
|        |               |         |         | ±0.1pF             | GJM0332C1E5R6BB01# |                    |
|        |               |         |         | ±0.25pF            | GJM0332C1E5R6CB01# |                    |
|        |               |         |         | ±0.5pF             | GJM0332C1E5R6DB01# |                    |
|        |               |         | 5.7pF   | ±0.05pF            | GJM0332C1E5R7WB01# |                    |
|        |               |         |         | ±0.1pF             | GJM0332C1E5R7BB01# |                    |
|        |               |         |         | ±0.25pF            | GJM0332C1E5R7CB01# |                    |
|        |               |         |         | ±0.5pF             | GJM0332C1E5R7DB01# |                    |
|        |               |         | 5.8pF   | ±0.05pF            | GJM0332C1E5R8WB01# |                    |

| T max. | Rated Voltage | TC Code | Cap.    | Tol.               | Part Number        |                    |
|--------|---------------|---------|---------|--------------------|--------------------|--------------------|
| 0.33mm | 25Vdc         | CH      | 5.8pF   | ±0.1pF             | GJM0332C1E5R8BB01# |                    |
|        |               |         |         | ±0.25pF            | GJM0332C1E5R8CB01# |                    |
|        |               |         |         | ±0.5pF             | GJM0332C1E5R8DB01# |                    |
|        |               |         | 5.9pF   | ±0.05pF            | GJM0332C1E5R9WB01# |                    |
|        |               |         |         | ±0.1pF             | GJM0332C1E5R9BB01# |                    |
|        |               |         |         | ±0.25pF            | GJM0332C1E5R9CB01# |                    |
|        |               |         | ±0.5pF  | GJM0332C1E5R9DB01# |                    |                    |
|        |               |         |         | 6.0pF              | ±0.05pF            | GJM0332C1E6R0WB01# |
|        |               |         |         |                    | ±0.1pF             | GJM0332C1E6R0BB01# |
|        |               |         | ±0.25pF |                    | GJM0332C1E6R0CB01# |                    |
|        |               |         | ±0.5pF  | GJM0332C1E6R0DB01# |                    |                    |
|        |               |         |         | 6.1pF              | ±0.05pF            | GJM0332C1E6R1WB01# |
|        |               |         |         |                    | ±0.1pF             | GJM0332C1E6R1BB01# |
|        |               |         | ±0.25pF |                    | GJM0332C1E6R1CB01# |                    |
|        |               |         | ±0.5pF  | GJM0332C1E6R1DB01# |                    |                    |
|        |               |         |         | 6.2pF              | ±0.05pF            | GJM0332C1E6R2WB01# |
|        |               |         |         |                    | ±0.1pF             | GJM0332C1E6R2BB01# |
|        |               |         | ±0.25pF |                    | GJM0332C1E6R2CB01# |                    |
|        |               |         | ±0.5pF  | GJM0332C1E6R2DB01# |                    |                    |
|        |               |         |         | 6.3pF              | ±0.05pF            | GJM0332C1E6R3WB01# |
|        |               |         |         |                    | ±0.1pF             | GJM0332C1E6R3BB01# |
|        |               |         | ±0.25pF |                    | GJM0332C1E6R3CB01# |                    |
|        |               |         | ±0.5pF  | GJM0332C1E6R3DB01# |                    |                    |
|        |               |         |         | 6.4pF              | ±0.05pF            | GJM0332C1E6R4WB01# |
|        |               |         |         |                    | ±0.1pF             | GJM0332C1E6R4BB01# |
|        |               |         | ±0.25pF |                    | GJM0332C1E6R4CB01# |                    |
|        |               |         | ±0.5pF  | GJM0332C1E6R4DB01# |                    |                    |
|        |               |         |         | 6.5pF              | ±0.05pF            | GJM0332C1E6R5WB01# |
|        |               |         |         |                    | ±0.1pF             | GJM0332C1E6R5BB01# |
|        |               |         | ±0.25pF |                    | GJM0332C1E6R5CB01# |                    |
|        |               |         | ±0.5pF  | GJM0332C1E6R5DB01# |                    |                    |
|        |               |         |         | 6.6pF              | ±0.05pF            | GJM0332C1E6R6WB01# |
|        |               |         |         |                    | ±0.1pF             | GJM0332C1E6R6BB01# |
|        |               |         | ±0.25pF |                    | GJM0332C1E6R6CB01# |                    |
|        |               |         | ±0.5pF  | GJM0332C1E6R6DB01# |                    |                    |
|        |               |         |         | 6.7pF              | ±0.05pF            | GJM0332C1E6R7WB01# |
|        |               |         |         |                    | ±0.1pF             | GJM0332C1E6R7BB01# |
|        |               |         | ±0.25pF |                    | GJM0332C1E6R7CB01# |                    |
|        |               |         | ±0.5pF  | GJM0332C1E6R7DB01# |                    |                    |
|        |               |         |         | 6.8pF              | ±0.05pF            | GJM0332C1E6R8WB01# |
|        |               |         |         |                    | ±0.1pF             | GJM0332C1E6R8BB01# |
|        |               |         | ±0.25pF |                    | GJM0332C1E6R8CB01# |                    |
|        |               |         | ±0.5pF  | GJM0332C1E6R8DB01# |                    |                    |
|        |               |         |         | 6.9pF              | ±0.05pF            | GJM0332C1E6R9WB01# |
|        |               |         |         |                    | ±0.1pF             | GJM0332C1E6R9BB01# |
|        |               |         | ±0.25pF |                    | GJM0332C1E6R9CB01# |                    |
|        |               |         | ±0.5pF  | GJM0332C1E6R9DB01# |                    |                    |
|        |               |         |         | 7.0pF              | ±0.05pF            | GJM0332C1E7R0WB01# |
|        |               |         |         |                    | ±0.1pF             | GJM0332C1E7R0BB01# |
|        |               |         | ±0.25pF |                    | GJM0332C1E7R0CB01# |                    |
|        |               |         | ±0.5pF  | GJM0332C1E7R0DB01# |                    |                    |
|        |               |         |         | 7.1pF              | ±0.05pF            | GJM0332C1E7R1WB01# |
|        |               |         |         |                    | ±0.1pF             | GJM0332C1E7R1BB01# |
|        |               |         | ±0.25pF |                    | GJM0332C1E7R1CB01# |                    |

Part number # indicates the package specification code.

GRM Series  
 GJM Series  
 GMA Series  
 GMD Series  
 GQM Series  
 GRJ Series  
 GR3 Series  
 KRM Series  
 KR3 Series  
 LLA Series  
 LLL Series  
 LLM Series  
 LLR Series  
 ⚠Caution/ Notice

# GJM Series Temperature Compensating Type High Q Part Number List

(→ ■ 0.6x0.3mm)

| T max.  | Rated Voltage      | TC Code            | Cap.    | Tol.    | Part Number        |
|---------|--------------------|--------------------|---------|---------|--------------------|
| 0.33mm  | 25Vdc              | CH                 | 7.1pF   | ±0.5pF  | GJM0332C1E7R1DB01# |
|         |                    |                    |         | ±0.05pF | GJM0332C1E7R2WB01# |
|         |                    |                    | 7.2pF   | ±0.1pF  | GJM0332C1E7R2BB01# |
|         |                    |                    |         | ±0.25pF | GJM0332C1E7R2CB01# |
|         |                    |                    |         | ±0.5pF  | GJM0332C1E7R2DB01# |
|         |                    |                    |         | 7.3pF   | ±0.05pF            |
|         |                    |                    | ±0.1pF  |         | GJM0332C1E7R3BB01# |
|         |                    |                    | ±0.25pF |         | GJM0332C1E7R3CB01# |
|         |                    |                    | ±0.5pF  |         | GJM0332C1E7R3DB01# |
|         |                    |                    | 7.4pF   | ±0.05pF | GJM0332C1E7R4WB01# |
|         |                    |                    |         | ±0.1pF  | GJM0332C1E7R4BB01# |
|         |                    |                    |         | ±0.25pF | GJM0332C1E7R4CB01# |
|         |                    |                    |         | ±0.5pF  | GJM0332C1E7R4DB01# |
|         |                    |                    | 7.5pF   | ±0.05pF | GJM0332C1E7R5WB01# |
|         |                    |                    |         | ±0.1pF  | GJM0332C1E7R5BB01# |
|         |                    |                    |         | ±0.25pF | GJM0332C1E7R5CB01# |
|         |                    |                    |         | ±0.5pF  | GJM0332C1E7R5DB01# |
|         |                    |                    | 7.6pF   | ±0.05pF | GJM0332C1E7R6WB01# |
|         |                    |                    |         | ±0.1pF  | GJM0332C1E7R6BB01# |
|         |                    |                    |         | ±0.25pF | GJM0332C1E7R6CB01# |
|         |                    |                    |         | ±0.5pF  | GJM0332C1E7R6DB01# |
|         |                    |                    | 7.7pF   | ±0.05pF | GJM0332C1E7R7WB01# |
|         |                    |                    |         | ±0.1pF  | GJM0332C1E7R7BB01# |
|         |                    |                    |         | ±0.25pF | GJM0332C1E7R7CB01# |
|         |                    |                    |         | ±0.5pF  | GJM0332C1E7R7DB01# |
|         |                    |                    | 7.8pF   | ±0.05pF | GJM0332C1E7R8WB01# |
|         |                    |                    |         | ±0.1pF  | GJM0332C1E7R8BB01# |
|         |                    |                    |         | ±0.25pF | GJM0332C1E7R8CB01# |
|         |                    |                    |         | ±0.5pF  | GJM0332C1E7R8DB01# |
|         |                    |                    | 7.9pF   | ±0.05pF | GJM0332C1E7R9WB01# |
|         |                    |                    |         | ±0.1pF  | GJM0332C1E7R9BB01# |
|         |                    |                    |         | ±0.25pF | GJM0332C1E7R9CB01# |
|         |                    |                    |         | ±0.5pF  | GJM0332C1E7R9DB01# |
|         |                    |                    | 8.0pF   | ±0.05pF | GJM0332C1E8R0WB01# |
|         |                    |                    |         | ±0.1pF  | GJM0332C1E8R0BB01# |
|         |                    |                    |         | ±0.25pF | GJM0332C1E8R0CB01# |
|         |                    |                    |         | ±0.5pF  | GJM0332C1E8R0DB01# |
|         |                    |                    | 8.1pF   | ±0.05pF | GJM0332C1E8R1WB01# |
|         |                    |                    |         | ±0.1pF  | GJM0332C1E8R1BB01# |
|         |                    |                    |         | ±0.25pF | GJM0332C1E8R1CB01# |
|         |                    |                    |         | ±0.5pF  | GJM0332C1E8R1DB01# |
|         |                    |                    | 8.2pF   | ±0.05pF | GJM0332C1E8R2WB01# |
|         |                    |                    |         | ±0.1pF  | GJM0332C1E8R2BB01# |
|         |                    |                    |         | ±0.25pF | GJM0332C1E8R2CB01# |
|         |                    |                    |         | ±0.5pF  | GJM0332C1E8R2DB01# |
|         |                    |                    | 8.3pF   | ±0.05pF | GJM0332C1E8R3WB01# |
|         |                    |                    |         | ±0.1pF  | GJM0332C1E8R3BB01# |
|         |                    |                    |         | ±0.25pF | GJM0332C1E8R3CB01# |
|         |                    |                    |         | ±0.5pF  | GJM0332C1E8R3DB01# |
|         |                    |                    | 8.4pF   | ±0.05pF | GJM0332C1E8R4WB01# |
| ±0.1pF  | GJM0332C1E8R4BB01# |                    |         |         |                    |
| ±0.25pF | GJM0332C1E8R4CB01# |                    |         |         |                    |
| ±0.5pF  | GJM0332C1E8R4DB01# |                    |         |         |                    |
| 8.5pF   | ±0.05pF            | GJM0332C1E8R5WB01# |         |         |                    |

| T max. | Rated Voltage | TC Code | Cap.  | Tol.    | Part Number        |
|--------|---------------|---------|-------|---------|--------------------|
| 0.33mm | 25Vdc         | CH      | 8.5pF | ±0.1pF  | GJM0332C1E8R5BB01# |
|        |               |         |       | ±0.25pF | GJM0332C1E8R5CB01# |
|        |               |         |       | ±0.5pF  | GJM0332C1E8R5DB01# |
|        |               |         | 8.6pF | ±0.05pF | GJM0332C1E8R6WB01# |
|        |               |         |       | ±0.1pF  | GJM0332C1E8R6BB01# |
|        |               |         |       | ±0.25pF | GJM0332C1E8R6CB01# |
|        |               |         | 8.7pF | ±0.05pF | GJM0332C1E8R7WB01# |
|        |               |         |       | ±0.1pF  | GJM0332C1E8R7BB01# |
|        |               |         |       | ±0.25pF | GJM0332C1E8R7CB01# |
|        |               |         | 8.8pF | ±0.05pF | GJM0332C1E8R8WB01# |
|        |               |         |       | ±0.1pF  | GJM0332C1E8R8BB01# |
|        |               |         |       | ±0.25pF | GJM0332C1E8R8CB01# |
|        |               |         | 8.9pF | ±0.05pF | GJM0332C1E8R9WB01# |
|        |               |         |       | ±0.1pF  | GJM0332C1E8R9BB01# |
|        |               |         |       | ±0.25pF | GJM0332C1E8R9CB01# |
|        |               |         | 9.0pF | ±0.05pF | GJM0332C1E9R0WB01# |
|        |               |         |       | ±0.1pF  | GJM0332C1E9R0BB01# |
|        |               |         |       | ±0.25pF | GJM0332C1E9R0CB01# |
|        |               |         | 9.1pF | ±0.05pF | GJM0332C1E9R1WB01# |
|        |               |         |       | ±0.1pF  | GJM0332C1E9R1BB01# |
|        |               |         |       | ±0.25pF | GJM0332C1E9R1CB01# |
|        |               |         | 9.2pF | ±0.05pF | GJM0332C1E9R2WB01# |
|        |               |         |       | ±0.1pF  | GJM0332C1E9R2BB01# |
|        |               |         |       | ±0.25pF | GJM0332C1E9R2CB01# |
|        |               |         | 9.3pF | ±0.05pF | GJM0332C1E9R3WB01# |
|        |               |         |       | ±0.1pF  | GJM0332C1E9R3BB01# |
|        |               |         |       | ±0.25pF | GJM0332C1E9R3CB01# |
|        |               |         | 9.4pF | ±0.05pF | GJM0332C1E9R4WB01# |
|        |               |         |       | ±0.1pF  | GJM0332C1E9R4BB01# |
|        |               |         |       | ±0.25pF | GJM0332C1E9R4CB01# |
|        |               |         | 9.5pF | ±0.05pF | GJM0332C1E9R5WB01# |
|        |               |         |       | ±0.1pF  | GJM0332C1E9R5BB01# |
|        |               |         |       | ±0.25pF | GJM0332C1E9R5CB01# |
|        |               |         | 9.6pF | ±0.05pF | GJM0332C1E9R6WB01# |
|        |               |         |       | ±0.1pF  | GJM0332C1E9R6BB01# |
|        |               |         |       | ±0.25pF | GJM0332C1E9R6CB01# |
|        |               |         | 9.7pF | ±0.05pF | GJM0332C1E9R7WB01# |
|        |               |         |       | ±0.1pF  | GJM0332C1E9R7BB01# |
|        |               |         |       | ±0.25pF | GJM0332C1E9R7CB01# |
|        |               |         | 9.8pF | ±0.05pF | GJM0332C1E9R8WB01# |
|        |               |         |       | ±0.1pF  | GJM0332C1E9R8BB01# |
|        |               |         |       | ±0.25pF | GJM0332C1E9R8CB01# |

Part number # indicates the package specification code.

GRM Series  
**GJM Series**  
 GMA Series  
 GMD Series  
 GQM Series  
 GRJ Series  
 GR3 Series  
 KRM Series  
 KR3 Series  
 LLA Series  
 LLL Series  
 LLM Series  
 LLR Series  
 ⚠Caution/  
 Notice

# GJM Series Temperature Compensating Type High Q Part Number List

(→ ■ 0.6×0.3mm)

| T max. | Rated Voltage | TC Code | Cap.  | Tol.    | Part Number        |
|--------|---------------|---------|-------|---------|--------------------|
| 0.33mm | 25Vdc         | CH      | 9.8pF | ±0.5pF  | GJM0332C1E9R8DB01# |
|        |               |         |       | ±0.05pF | GJM0332C1E9R9WB01# |
|        |               |         | 9.9pF | ±0.1pF  | GJM0332C1E9R9BB01# |
|        |               |         |       | ±0.25pF | GJM0332C1E9R9CB01# |
|        |               |         |       | ±0.5pF  | GJM0332C1E9R9DB01# |
|        |               |         | 10pF  | ±2%     | GJM0332C1E100GB01# |
|        |               |         |       | ±5%     | GJM0332C1E100JB01# |
|        |               |         | 11pF  | ±2%     | GJM0332C1E110GB01# |
|        |               |         |       | ±5%     | GJM0332C1E110JB01# |
|        |               |         | 12pF  | ±2%     | GJM0332C1E120GB01# |
|        |               |         |       | ±5%     | GJM0332C1E120JB01# |
|        |               |         | 13pF  | ±2%     | GJM0332C1E130GB01# |
|        |               |         |       | ±5%     | GJM0332C1E130JB01# |
|        |               |         | 15pF  | ±2%     | GJM0332C1E150GB01# |
|        |               |         |       | ±5%     | GJM0332C1E150JB01# |
|        |               |         | 16pF  | ±2%     | GJM0332C1E160GB01# |
|        |               |         |       | ±5%     | GJM0332C1E160JB01# |
|        |               |         | 18pF  | ±2%     | GJM0332C1E180GB01# |
|        |               |         |       | ±5%     | GJM0332C1E180JB01# |
|        |               |         | 20pF  | ±2%     | GJM0332C1E200GB01# |
|        |               |         |       | ±5%     | GJM0332C1E200JB01# |
|        |               |         | 22pF  | ±2%     | GJM0332C1E220GB01# |
|        |               |         |       | ±5%     | GJM0332C1E220JB01# |
|        |               |         | 24pF  | ±2%     | GJM0332C1E240GB01# |
|        |               |         |       | ±5%     | GJM0332C1E240JB01# |
|        |               |         | 27pF  | ±2%     | GJM0332C1E270GB01# |
|        |               |         |       | ±5%     | GJM0332C1E270JB01# |
|        |               |         | 30pF  | ±2%     | GJM0332C1E300GB01# |
|        |               |         |       | ±5%     | GJM0332C1E300JB01# |
|        |               |         | 33pF  | ±2%     | GJM0332C1E330GB01# |
|        |               |         |       | ±5%     | GJM0332C1E330JB01# |

■ 1.0×0.5mm

| T max. | Rated Voltage | TC Code | Cap.   | Tol.    | Part Number        |
|--------|---------------|---------|--------|---------|--------------------|
| 0.55mm | 50Vdc         | C0G     | 0.10pF | ±0.05pF | GJM1555C1HR10WB01# |
|        |               |         |        | ±0.1pF  | GJM1555C1HR10BB01# |
|        |               |         | 0.20pF | ±0.05pF | GJM1555C1HR20WB01# |
|        |               |         |        | ±0.1pF  | GJM1555C1HR20BB01# |
|        |               |         | 0.30pF | ±0.05pF | GJM1555C1HR30WB01# |
|        |               |         |        | ±0.1pF  | GJM1555C1HR30BB01# |
|        |               |         | 0.40pF | ±0.05pF | GJM1555C1HR40WB01# |
|        |               |         |        | ±0.1pF  | GJM1555C1HR40BB01# |
|        |               |         | 0.50pF | ±0.05pF | GJM1555C1HR50WB01# |
|        |               |         |        | ±0.1pF  | GJM1555C1HR50BB01# |
|        |               |         | 0.60pF | ±0.05pF | GJM1555C1HR60WB01# |
|        |               |         |        | ±0.1pF  | GJM1555C1HR60BB01# |
|        |               |         | 0.70pF | ±0.05pF | GJM1555C1HR70WB01# |
|        |               |         |        | ±0.1pF  | GJM1555C1HR70BB01# |
|        |               |         | 0.80pF | ±0.05pF | GJM1555C1HR80WB01# |
|        |               |         |        | ±0.1pF  | GJM1555C1HR80BB01# |
|        |               |         | 0.90pF | ±0.05pF | GJM1555C1HR90WB01# |
|        |               |         |        | ±0.1pF  | GJM1555C1HR90BB01# |

| T max. | Rated Voltage | TC Code | Cap.  | Tol.    | Part Number        |
|--------|---------------|---------|-------|---------|--------------------|
| 0.55mm | 50Vdc         | C0G     | 1.0pF | ±0.05pF | GJM1555C1H1R0WB01# |
|        |               |         |       | ±0.1pF  | GJM1555C1H1R0BB01# |
|        |               |         |       | ±0.25pF | GJM1555C1H1R0CB01# |
|        |               |         | 1.1pF | ±0.05pF | GJM1555C1H1R1WB01# |
|        |               |         |       | ±0.1pF  | GJM1555C1H1R1BB01# |
|        |               |         |       | ±0.25pF | GJM1555C1H1R1CB01# |
|        |               |         | 1.2pF | ±0.05pF | GJM1555C1H1R2WB01# |
|        |               |         |       | ±0.1pF  | GJM1555C1H1R2BB01# |
|        |               |         |       | ±0.25pF | GJM1555C1H1R2CB01# |
|        |               |         | 1.3pF | ±0.05pF | GJM1555C1H1R3WB01# |
|        |               |         |       | ±0.1pF  | GJM1555C1H1R3BB01# |
|        |               |         |       | ±0.25pF | GJM1555C1H1R3CB01# |
|        |               |         | 1.4pF | ±0.05pF | GJM1555C1H1R4WB01# |
|        |               |         |       | ±0.1pF  | GJM1555C1H1R4BB01# |
|        |               |         |       | ±0.25pF | GJM1555C1H1R4CB01# |
|        |               |         | 1.5pF | ±0.05pF | GJM1555C1H1R5WB01# |
|        |               |         |       | ±0.1pF  | GJM1555C1H1R5BB01# |
|        |               |         |       | ±0.25pF | GJM1555C1H1R5CB01# |
|        |               |         | 1.6pF | ±0.05pF | GJM1555C1H1R6WB01# |
|        |               |         |       | ±0.1pF  | GJM1555C1H1R6BB01# |
|        |               |         |       | ±0.25pF | GJM1555C1H1R6CB01# |
|        |               |         | 1.7pF | ±0.05pF | GJM1555C1H1R7WB01# |
|        |               |         |       | ±0.1pF  | GJM1555C1H1R7BB01# |
|        |               |         |       | ±0.25pF | GJM1555C1H1R7CB01# |
|        |               |         | 1.8pF | ±0.05pF | GJM1555C1H1R8WB01# |
|        |               |         |       | ±0.1pF  | GJM1555C1H1R8BB01# |
|        |               |         |       | ±0.25pF | GJM1555C1H1R8CB01# |
|        |               |         | 1.9pF | ±0.05pF | GJM1555C1H1R9WB01# |
|        |               |         |       | ±0.1pF  | GJM1555C1H1R9BB01# |
|        |               |         |       | ±0.25pF | GJM1555C1H1R9CB01# |
|        |               |         | 2.0pF | ±0.05pF | GJM1555C1H2R0WB01# |
|        |               |         |       | ±0.1pF  | GJM1555C1H2R0BB01# |
|        |               |         |       | ±0.25pF | GJM1555C1H2R0CB01# |
|        |               |         | 2.1pF | ±0.05pF | GJM1555C1H2R1WB01# |
|        |               |         |       | ±0.1pF  | GJM1555C1H2R1BB01# |
|        |               |         |       | ±0.25pF | GJM1555C1H2R1CB01# |
|        |               |         | 2.2pF | ±0.05pF | GJM1555C1H2R2WB01# |
|        |               |         |       | ±0.1pF  | GJM1555C1H2R2BB01# |
|        |               |         |       | ±0.25pF | GJM1555C1H2R2CB01# |
|        |               |         | 2.3pF | ±0.05pF | GJM1555C1H2R3WB01# |
|        |               |         |       | ±0.1pF  | GJM1555C1H2R3BB01# |
|        |               |         |       | ±0.25pF | GJM1555C1H2R3CB01# |
|        |               |         | 2.4pF | ±0.05pF | GJM1555C1H2R4WB01# |
|        |               |         |       | ±0.1pF  | GJM1555C1H2R4BB01# |
|        |               |         |       | ±0.25pF | GJM1555C1H2R4CB01# |
|        |               |         | 2.5pF | ±0.05pF | GJM1555C1H2R5WB01# |
|        |               |         |       | ±0.1pF  | GJM1555C1H2R5BB01# |
|        |               |         |       | ±0.25pF | GJM1555C1H2R5CB01# |
|        |               |         | 2.6pF | ±0.05pF | GJM1555C1H2R6WB01# |
|        |               |         |       | ±0.1pF  | GJM1555C1H2R6BB01# |
|        |               |         |       | ±0.25pF | GJM1555C1H2R6CB01# |
|        |               |         | 2.7pF | ±0.05pF | GJM1555C1H2R7WB01# |
|        |               |         |       | ±0.1pF  | GJM1555C1H2R7BB01# |
|        |               |         |       | ±0.25pF | GJM1555C1H2R7CB01# |

Part number # indicates the package specification code.

GRM Series  
GJM Series  
GMA Series  
GMD Series  
GQM Series  
GRJ Series  
GR3 Series  
KRM Series  
KR3 Series  
LLA Series  
LLL Series  
LLM Series  
LLR Series  
⚠Caution/Notice

# GJM Series Temperature Compensating Type High Q Part Number List

(→ ■ 1.0x0.5mm)

| T max. | Rated Voltage | TC Code                   | Cap.  | Tol.    | Part Number               |
|--------|---------------|---------------------------|-------|---------|---------------------------|
| 0.55mm | 50Vdc         | COG                       | 2.8pF | ±0.05pF | <b>GJM1555C1H2R8WB01#</b> |
|        |               |                           |       | ±0.1pF  | <b>GJM1555C1H2R8BB01#</b> |
|        |               |                           |       | ±0.25pF | <b>GJM1555C1H2R8CB01#</b> |
|        |               |                           | 2.9pF | ±0.05pF | <b>GJM1555C1H2R9WB01#</b> |
|        |               |                           |       | ±0.1pF  | <b>GJM1555C1H2R9BB01#</b> |
|        |               |                           |       | ±0.25pF | <b>GJM1555C1H2R9CB01#</b> |
|        |               |                           | 3.0pF | ±0.05pF | <b>GJM1555C1H3R0WB01#</b> |
|        |               |                           |       | ±0.1pF  | <b>GJM1555C1H3R0BB01#</b> |
|        |               |                           |       | ±0.25pF | <b>GJM1555C1H3R0CB01#</b> |
|        |               |                           | 3.1pF | ±0.05pF | <b>GJM1555C1H3R1WB01#</b> |
|        |               |                           |       | ±0.1pF  | <b>GJM1555C1H3R1BB01#</b> |
|        |               |                           |       | ±0.25pF | <b>GJM1555C1H3R1CB01#</b> |
|        |               |                           | 3.2pF | ±0.05pF | <b>GJM1555C1H3R2WB01#</b> |
|        |               |                           |       | ±0.1pF  | <b>GJM1555C1H3R2BB01#</b> |
|        |               |                           |       | ±0.25pF | <b>GJM1555C1H3R2CB01#</b> |
|        |               |                           | 3.3pF | ±0.05pF | <b>GJM1555C1H3R3WB01#</b> |
|        |               |                           |       | ±0.1pF  | <b>GJM1555C1H3R3BB01#</b> |
|        |               |                           |       | ±0.25pF | <b>GJM1555C1H3R3CB01#</b> |
|        |               |                           | 3.4pF | ±0.05pF | <b>GJM1555C1H3R4WB01#</b> |
|        |               |                           |       | ±0.1pF  | <b>GJM1555C1H3R4BB01#</b> |
|        |               |                           |       | ±0.25pF | <b>GJM1555C1H3R4CB01#</b> |
|        |               |                           | 3.5pF | ±0.05pF | <b>GJM1555C1H3R5WB01#</b> |
|        |               |                           |       | ±0.1pF  | <b>GJM1555C1H3R5BB01#</b> |
|        |               |                           |       | ±0.25pF | <b>GJM1555C1H3R5CB01#</b> |
|        |               |                           | 3.6pF | ±0.05pF | <b>GJM1555C1H3R6WB01#</b> |
|        |               |                           |       | ±0.1pF  | <b>GJM1555C1H3R6BB01#</b> |
|        |               |                           |       | ±0.25pF | <b>GJM1555C1H3R6CB01#</b> |
|        |               |                           | 3.7pF | ±0.05pF | <b>GJM1555C1H3R7WB01#</b> |
|        |               |                           |       | ±0.1pF  | <b>GJM1555C1H3R7BB01#</b> |
|        |               |                           |       | ±0.25pF | <b>GJM1555C1H3R7CB01#</b> |
|        |               |                           | 3.8pF | ±0.05pF | <b>GJM1555C1H3R8WB01#</b> |
|        |               |                           |       | ±0.1pF  | <b>GJM1555C1H3R8BB01#</b> |
|        |               |                           |       | ±0.25pF | <b>GJM1555C1H3R8CB01#</b> |
|        |               |                           | 3.9pF | ±0.05pF | <b>GJM1555C1H3R9WB01#</b> |
|        |               |                           |       | ±0.1pF  | <b>GJM1555C1H3R9BB01#</b> |
|        |               |                           |       | ±0.25pF | <b>GJM1555C1H3R9CB01#</b> |
|        |               |                           | 4.0pF | ±0.05pF | <b>GJM1555C1H4R0WB01#</b> |
|        |               |                           |       | ±0.1pF  | <b>GJM1555C1H4R0BB01#</b> |
|        |               |                           |       | ±0.25pF | <b>GJM1555C1H4R0CB01#</b> |
|        |               |                           | 4.1pF | ±0.05pF | <b>GJM1555C1H4R1WB01#</b> |
|        |               |                           |       | ±0.1pF  | <b>GJM1555C1H4R1BB01#</b> |
|        |               |                           |       | ±0.25pF | <b>GJM1555C1H4R1CB01#</b> |
|        |               |                           | 4.2pF | ±0.05pF | <b>GJM1555C1H4R2WB01#</b> |
|        |               |                           |       | ±0.1pF  | <b>GJM1555C1H4R2BB01#</b> |
|        |               |                           |       | ±0.25pF | <b>GJM1555C1H4R2CB01#</b> |
| 4.3pF  | ±0.05pF       | <b>GJM1555C1H4R3WB01#</b> |       |         |                           |
|        | ±0.1pF        | <b>GJM1555C1H4R3BB01#</b> |       |         |                           |
|        | ±0.25pF       | <b>GJM1555C1H4R3CB01#</b> |       |         |                           |
| 4.4pF  | ±0.05pF       | <b>GJM1555C1H4R4WB01#</b> |       |         |                           |
|        | ±0.1pF        | <b>GJM1555C1H4R4BB01#</b> |       |         |                           |
|        | ±0.25pF       | <b>GJM1555C1H4R4CB01#</b> |       |         |                           |
| 4.5pF  | ±0.05pF       | <b>GJM1555C1H4R5WB01#</b> |       |         |                           |
|        | ±0.1pF        | <b>GJM1555C1H4R5BB01#</b> |       |         |                           |
|        | ±0.25pF       | <b>GJM1555C1H4R5CB01#</b> |       |         |                           |

| T max. | Rated Voltage | TC Code | Cap.  | Tol.    | Part Number               |
|--------|---------------|---------|-------|---------|---------------------------|
| 0.55mm | 50Vdc         | COG     | 4.6pF | ±0.05pF | <b>GJM1555C1H4R6WB01#</b> |
|        |               |         |       | ±0.1pF  | <b>GJM1555C1H4R6BB01#</b> |
|        |               |         |       | ±0.25pF | <b>GJM1555C1H4R6CB01#</b> |
|        |               |         | 4.7pF | ±0.05pF | <b>GJM1555C1H4R7WB01#</b> |
|        |               |         |       | ±0.1pF  | <b>GJM1555C1H4R7BB01#</b> |
|        |               |         |       | ±0.25pF | <b>GJM1555C1H4R7CB01#</b> |
|        |               |         | 4.8pF | ±0.05pF | <b>GJM1555C1H4R8WB01#</b> |
|        |               |         |       | ±0.1pF  | <b>GJM1555C1H4R8BB01#</b> |
|        |               |         |       | ±0.25pF | <b>GJM1555C1H4R8CB01#</b> |
|        |               |         | 4.9pF | ±0.05pF | <b>GJM1555C1H4R9WB01#</b> |
|        |               |         |       | ±0.1pF  | <b>GJM1555C1H4R9BB01#</b> |
|        |               |         |       | ±0.25pF | <b>GJM1555C1H4R9CB01#</b> |
|        |               |         | 5.0pF | ±0.05pF | <b>GJM1555C1H5R0WB01#</b> |
|        |               |         |       | ±0.1pF  | <b>GJM1555C1H5R0BB01#</b> |
|        |               |         |       | ±0.25pF | <b>GJM1555C1H5R0CB01#</b> |
|        |               |         | 5.1pF | ±0.05pF | <b>GJM1555C1H5R1WB01#</b> |
|        |               |         |       | ±0.1pF  | <b>GJM1555C1H5R1BB01#</b> |
|        |               |         |       | ±0.25pF | <b>GJM1555C1H5R1CB01#</b> |
|        |               |         | 5.2pF | ±0.05pF | <b>GJM1555C1H5R2WB01#</b> |
|        |               |         |       | ±0.1pF  | <b>GJM1555C1H5R2BB01#</b> |
|        |               |         |       | ±0.25pF | <b>GJM1555C1H5R2CB01#</b> |
|        |               |         | 5.3pF | ±0.05pF | <b>GJM1555C1H5R3WB01#</b> |
|        |               |         |       | ±0.1pF  | <b>GJM1555C1H5R3BB01#</b> |
|        |               |         |       | ±0.25pF | <b>GJM1555C1H5R3CB01#</b> |
|        |               |         | 5.4pF | ±0.05pF | <b>GJM1555C1H5R4WB01#</b> |
|        |               |         |       | ±0.1pF  | <b>GJM1555C1H5R4BB01#</b> |
|        |               |         |       | ±0.25pF | <b>GJM1555C1H5R4CB01#</b> |
|        |               |         | 5.5pF | ±0.05pF | <b>GJM1555C1H5R5WB01#</b> |
|        |               |         |       | ±0.1pF  | <b>GJM1555C1H5R5BB01#</b> |
|        |               |         |       | ±0.25pF | <b>GJM1555C1H5R5CB01#</b> |
|        |               |         | 5.6pF | ±0.05pF | <b>GJM1555C1H5R6WB01#</b> |
|        |               |         |       | ±0.1pF  | <b>GJM1555C1H5R6BB01#</b> |
|        |               |         |       | ±0.25pF | <b>GJM1555C1H5R6CB01#</b> |
|        |               |         | 5.7pF | ±0.05pF | <b>GJM1555C1H5R7WB01#</b> |
|        |               |         |       | ±0.1pF  | <b>GJM1555C1H5R7BB01#</b> |
|        |               |         |       | ±0.25pF | <b>GJM1555C1H5R7CB01#</b> |
|        |               |         | 5.8pF | ±0.05pF | <b>GJM1555C1H5R8WB01#</b> |
|        |               |         |       | ±0.1pF  | <b>GJM1555C1H5R8BB01#</b> |
|        |               |         |       | ±0.25pF | <b>GJM1555C1H5R8CB01#</b> |
|        |               |         | 5.9pF | ±0.05pF | <b>GJM1555C1H5R9WB01#</b> |
|        |               |         |       | ±0.1pF  | <b>GJM1555C1H5R9BB01#</b> |
|        |               |         |       | ±0.25pF | <b>GJM1555C1H5R9CB01#</b> |
|        |               |         | 6.0pF | ±0.05pF | <b>GJM1555C1H6R0WB01#</b> |
|        |               |         |       | ±0.1pF  | <b>GJM1555C1H6R0BB01#</b> |
|        |               |         |       | ±0.25pF | <b>GJM1555C1H6R0CB01#</b> |

Part number # indicates the package specification code.

GRM Series  
 GJM Series  
 GMA Series  
 GMD Series  
 GQM Series  
 GRJ Series  
 GR3 Series  
 KRM Series  
 KR3 Series  
 LLA Series  
 LLL Series  
 LLM Series  
 LLR Series  
 ⚠Caution/  
 Notice



## GJM Series Temperature Compensating Type High Q Part Number List

(→ ■ 1.0x0.5mm)

| T max. | Rated Voltage | TC Code | Cap.    | Tol.    | Part Number        |
|--------|---------------|---------|---------|---------|--------------------|
| 0.55mm | 50Vdc         | C0G     | 6.0pF   | ±0.5pF  | GJM1555C1H6R0DB01# |
|        |               |         |         | ±0.05pF | GJM1555C1H6R1WB01# |
|        |               |         | 6.1pF   | ±0.1pF  | GJM1555C1H6R1BB01# |
|        |               |         |         | ±0.25pF | GJM1555C1H6R1CB01# |
|        |               |         |         | ±0.5pF  | GJM1555C1H6R1DB01# |
|        |               |         |         | 6.2pF   | ±0.05pF            |
|        |               |         | ±0.1pF  |         | GJM1555C1H6R2BB01# |
|        |               |         | ±0.25pF |         | GJM1555C1H6R2CB01# |
|        |               |         | ±0.5pF  |         | GJM1555C1H6R2DB01# |
|        |               |         | 6.3pF   | ±0.05pF | GJM1555C1H6R3WB01# |
|        |               |         |         | ±0.1pF  | GJM1555C1H6R3BB01# |
|        |               |         |         | ±0.25pF | GJM1555C1H6R3CB01# |
|        |               |         |         | ±0.5pF  | GJM1555C1H6R3DB01# |
|        |               |         | 6.4pF   | ±0.05pF | GJM1555C1H6R4WB01# |
|        |               |         |         | ±0.1pF  | GJM1555C1H6R4BB01# |
|        |               |         |         | ±0.25pF | GJM1555C1H6R4CB01# |
|        |               |         |         | ±0.5pF  | GJM1555C1H6R4DB01# |
|        |               |         | 6.5pF   | ±0.05pF | GJM1555C1H6R5WB01# |
|        |               |         |         | ±0.1pF  | GJM1555C1H6R5BB01# |
|        |               |         |         | ±0.25pF | GJM1555C1H6R5CB01# |
|        |               |         |         | ±0.5pF  | GJM1555C1H6R5DB01# |
|        |               |         | 6.6pF   | ±0.05pF | GJM1555C1H6R6WB01# |
|        |               |         |         | ±0.1pF  | GJM1555C1H6R6BB01# |
|        |               |         |         | ±0.25pF | GJM1555C1H6R6CB01# |
|        |               |         |         | ±0.5pF  | GJM1555C1H6R6DB01# |
|        |               |         | 6.7pF   | ±0.05pF | GJM1555C1H6R7WB01# |
|        |               |         |         | ±0.1pF  | GJM1555C1H6R7BB01# |
|        |               |         |         | ±0.25pF | GJM1555C1H6R7CB01# |
|        |               |         |         | ±0.5pF  | GJM1555C1H6R7DB01# |
|        |               |         | 6.8pF   | ±0.05pF | GJM1555C1H6R8WB01# |
|        |               |         |         | ±0.1pF  | GJM1555C1H6R8BB01# |
|        |               |         |         | ±0.25pF | GJM1555C1H6R8CB01# |
|        |               |         |         | ±0.5pF  | GJM1555C1H6R8DB01# |
|        |               |         | 6.9pF   | ±0.05pF | GJM1555C1H6R9WB01# |
|        |               |         |         | ±0.1pF  | GJM1555C1H6R9BB01# |
|        |               |         |         | ±0.25pF | GJM1555C1H6R9CB01# |
|        |               |         |         | ±0.5pF  | GJM1555C1H6R9DB01# |
|        |               |         | 7.0pF   | ±0.05pF | GJM1555C1H7R0WB01# |
|        |               |         |         | ±0.1pF  | GJM1555C1H7R0BB01# |
|        |               |         |         | ±0.25pF | GJM1555C1H7R0CB01# |
|        |               |         |         | ±0.5pF  | GJM1555C1H7R0DB01# |
|        |               |         | 7.1pF   | ±0.05pF | GJM1555C1H7R1WB01# |
|        |               |         |         | ±0.1pF  | GJM1555C1H7R1BB01# |
|        |               |         |         | ±0.25pF | GJM1555C1H7R1CB01# |
|        |               |         |         | ±0.5pF  | GJM1555C1H7R1DB01# |
|        |               |         | 7.2pF   | ±0.05pF | GJM1555C1H7R2WB01# |
|        |               |         |         | ±0.1pF  | GJM1555C1H7R2BB01# |
|        |               |         |         | ±0.25pF | GJM1555C1H7R2CB01# |
|        |               |         |         | ±0.5pF  | GJM1555C1H7R2DB01# |
|        |               |         | 7.3pF   | ±0.05pF | GJM1555C1H7R3WB01# |
|        |               |         |         | ±0.1pF  | GJM1555C1H7R3BB01# |
|        |               |         |         | ±0.25pF | GJM1555C1H7R3CB01# |
|        |               |         |         | ±0.5pF  | GJM1555C1H7R3DB01# |
|        |               |         | 7.4pF   | ±0.05pF | GJM1555C1H7R4WB01# |

| T max. | Rated Voltage | TC Code | Cap.  | Tol.    | Part Number        |
|--------|---------------|---------|-------|---------|--------------------|
| 0.55mm | 50Vdc         | C0G     | 7.4pF | ±0.1pF  | GJM1555C1H7R4BB01# |
|        |               |         |       | ±0.25pF | GJM1555C1H7R4CB01# |
|        |               |         |       | ±0.5pF  | GJM1555C1H7R4DB01# |
|        |               |         | 7.5pF | ±0.05pF | GJM1555C1H7R5WB01# |
|        |               |         |       | ±0.1pF  | GJM1555C1H7R5BB01# |
|        |               |         |       | ±0.25pF | GJM1555C1H7R5CB01# |
|        |               |         | 7.6pF | ±0.05pF | GJM1555C1H7R6WB01# |
|        |               |         |       | ±0.1pF  | GJM1555C1H7R6BB01# |
|        |               |         |       | ±0.25pF | GJM1555C1H7R6CB01# |
|        |               |         | 7.7pF | ±0.05pF | GJM1555C1H7R7WB01# |
|        |               |         |       | ±0.1pF  | GJM1555C1H7R7BB01# |
|        |               |         |       | ±0.25pF | GJM1555C1H7R7CB01# |
|        |               |         | 7.8pF | ±0.05pF | GJM1555C1H7R8WB01# |
|        |               |         |       | ±0.1pF  | GJM1555C1H7R8BB01# |
|        |               |         |       | ±0.25pF | GJM1555C1H7R8CB01# |
|        |               |         | 7.9pF | ±0.05pF | GJM1555C1H7R9WB01# |
|        |               |         |       | ±0.1pF  | GJM1555C1H7R9BB01# |
|        |               |         |       | ±0.25pF | GJM1555C1H7R9CB01# |
|        |               |         | 8.0pF | ±0.05pF | GJM1555C1H8R0WB01# |
|        |               |         |       | ±0.1pF  | GJM1555C1H8R0BB01# |
|        |               |         |       | ±0.25pF | GJM1555C1H8R0CB01# |
|        |               |         | 8.1pF | ±0.05pF | GJM1555C1H8R1WB01# |
|        |               |         |       | ±0.1pF  | GJM1555C1H8R1BB01# |
|        |               |         |       | ±0.25pF | GJM1555C1H8R1CB01# |
|        |               |         | 8.2pF | ±0.05pF | GJM1555C1H8R2WB01# |
|        |               |         |       | ±0.1pF  | GJM1555C1H8R2BB01# |
|        |               |         |       | ±0.25pF | GJM1555C1H8R2CB01# |
|        |               |         | 8.3pF | ±0.05pF | GJM1555C1H8R3WB01# |
|        |               |         |       | ±0.1pF  | GJM1555C1H8R3BB01# |
|        |               |         |       | ±0.25pF | GJM1555C1H8R3CB01# |
|        |               |         | 8.4pF | ±0.05pF | GJM1555C1H8R4WB01# |
|        |               |         |       | ±0.1pF  | GJM1555C1H8R4BB01# |
|        |               |         |       | ±0.25pF | GJM1555C1H8R4CB01# |
|        |               |         | 8.5pF | ±0.05pF | GJM1555C1H8R5WB01# |
|        |               |         |       | ±0.1pF  | GJM1555C1H8R5BB01# |
|        |               |         |       | ±0.25pF | GJM1555C1H8R5CB01# |
|        |               |         | 8.6pF | ±0.05pF | GJM1555C1H8R6WB01# |
|        |               |         |       | ±0.1pF  | GJM1555C1H8R6BB01# |
|        |               |         |       | ±0.25pF | GJM1555C1H8R6CB01# |
|        |               |         | 8.7pF | ±0.05pF | GJM1555C1H8R7WB01# |
|        |               |         |       | ±0.1pF  | GJM1555C1H8R7BB01# |
|        |               |         |       | ±0.25pF | GJM1555C1H8R7CB01# |

Part number # indicates the package specification code.

# GJM Series Temperature Compensating Type High Q Part Number List

(→ ■ 1.0x0.5mm)

| T max. | Rated Voltage | TC Code | Cap.  | Tol.    | Part Number               |                           |
|--------|---------------|---------|-------|---------|---------------------------|---------------------------|
| 0.55mm | 50Vdc         | COG     | 8.7pF | ±0.5pF  | <b>GJM1555C1H8R7DB01#</b> |                           |
|        |               |         |       | 8.8pF   | ±0.05pF                   | <b>GJM1555C1H8R8WB01#</b> |
|        |               |         |       |         | ±0.1pF                    | <b>GJM1555C1H8R8BB01#</b> |
|        |               |         |       |         | ±0.25pF                   | <b>GJM1555C1H8R8CB01#</b> |
|        |               |         |       |         | ±0.5pF                    | <b>GJM1555C1H8R8DB01#</b> |
|        |               |         | 8.9pF | ±0.05pF | <b>GJM1555C1H8R9WB01#</b> |                           |
|        |               |         |       | ±0.1pF  | <b>GJM1555C1H8R9BB01#</b> |                           |
|        |               |         |       | ±0.25pF | <b>GJM1555C1H8R9CB01#</b> |                           |
|        |               |         |       | ±0.5pF  | <b>GJM1555C1H8R9DB01#</b> |                           |
|        |               |         | 9.0pF | ±0.05pF | <b>GJM1555C1H9R0WB01#</b> |                           |
|        |               |         |       | ±0.1pF  | <b>GJM1555C1H9R0BB01#</b> |                           |
|        |               |         |       | ±0.25pF | <b>GJM1555C1H9R0CB01#</b> |                           |
|        |               |         |       | ±0.5pF  | <b>GJM1555C1H9R0DB01#</b> |                           |
|        |               |         | 9.1pF | ±0.05pF | <b>GJM1555C1H9R1WB01#</b> |                           |
|        |               |         |       | ±0.1pF  | <b>GJM1555C1H9R1BB01#</b> |                           |
|        |               |         |       | ±0.25pF | <b>GJM1555C1H9R1CB01#</b> |                           |
|        |               |         |       | ±0.5pF  | <b>GJM1555C1H9R1DB01#</b> |                           |
|        |               |         | 9.2pF | ±0.05pF | <b>GJM1555C1H9R2WB01#</b> |                           |
|        |               |         |       | ±0.1pF  | <b>GJM1555C1H9R2BB01#</b> |                           |
|        |               |         |       | ±0.25pF | <b>GJM1555C1H9R2CB01#</b> |                           |
|        |               |         |       | ±0.5pF  | <b>GJM1555C1H9R2DB01#</b> |                           |
|        |               |         | 9.3pF | ±0.05pF | <b>GJM1555C1H9R3WB01#</b> |                           |
|        |               |         |       | ±0.1pF  | <b>GJM1555C1H9R3BB01#</b> |                           |
|        |               |         |       | ±0.25pF | <b>GJM1555C1H9R3CB01#</b> |                           |
|        |               |         |       | ±0.5pF  | <b>GJM1555C1H9R3DB01#</b> |                           |
|        |               |         | 9.4pF | ±0.05pF | <b>GJM1555C1H9R4WB01#</b> |                           |
|        |               |         |       | ±0.1pF  | <b>GJM1555C1H9R4BB01#</b> |                           |
|        |               |         |       | ±0.25pF | <b>GJM1555C1H9R4CB01#</b> |                           |
|        |               |         |       | ±0.5pF  | <b>GJM1555C1H9R4DB01#</b> |                           |
|        |               |         | 9.5pF | ±0.05pF | <b>GJM1555C1H9R5WB01#</b> |                           |
|        |               |         |       | ±0.1pF  | <b>GJM1555C1H9R5BB01#</b> |                           |
|        |               |         |       | ±0.25pF | <b>GJM1555C1H9R5CB01#</b> |                           |
|        |               |         |       | ±0.5pF  | <b>GJM1555C1H9R5DB01#</b> |                           |
|        |               |         | 9.6pF | ±0.05pF | <b>GJM1555C1H9R6WB01#</b> |                           |
|        |               |         |       | ±0.1pF  | <b>GJM1555C1H9R6BB01#</b> |                           |
|        |               |         |       | ±0.25pF | <b>GJM1555C1H9R6CB01#</b> |                           |
|        |               |         |       | ±0.5pF  | <b>GJM1555C1H9R6DB01#</b> |                           |
|        |               |         | 9.7pF | ±0.05pF | <b>GJM1555C1H9R7WB01#</b> |                           |
|        |               |         |       | ±0.1pF  | <b>GJM1555C1H9R7BB01#</b> |                           |
|        |               |         |       | ±0.25pF | <b>GJM1555C1H9R7CB01#</b> |                           |
|        |               |         |       | ±0.5pF  | <b>GJM1555C1H9R7DB01#</b> |                           |
|        |               |         | 9.8pF | ±0.05pF | <b>GJM1555C1H9R8WB01#</b> |                           |
|        |               |         |       | ±0.1pF  | <b>GJM1555C1H9R8BB01#</b> |                           |
|        |               |         |       | ±0.25pF | <b>GJM1555C1H9R8CB01#</b> |                           |
|        |               |         |       | ±0.5pF  | <b>GJM1555C1H9R8DB01#</b> |                           |
|        |               |         | 9.9pF | ±0.05pF | <b>GJM1555C1H9R9WB01#</b> |                           |
|        |               |         |       | ±0.1pF  | <b>GJM1555C1H9R9BB01#</b> |                           |
|        |               |         |       | ±0.25pF | <b>GJM1555C1H9R9CB01#</b> |                           |
|        |               |         |       | ±0.5pF  | <b>GJM1555C1H9R9DB01#</b> |                           |
|        |               |         | 10pF  | ±2%     | <b>GJM1555C1H100GB01#</b> |                           |
|        |               |         |       | ±5%     | <b>GJM1555C1H100JB01#</b> |                           |
|        |               |         | 11pF  | ±2%     | <b>GJM1555C1H110GB01#</b> |                           |
|        |               |         |       | ±5%     | <b>GJM1555C1H110JB01#</b> |                           |
|        |               |         | 12pF  | ±2%     | <b>GJM1555C1H120GB01#</b> |                           |

| T max. | Rated Voltage | TC Code | Cap.   | Tol.    | Part Number               |                           |  |  |
|--------|---------------|---------|--------|---------|---------------------------|---------------------------|--|--|
| 0.55mm | 50Vdc         | COG     | 12pF   | ±5%     | <b>GJM1555C1H120JB01#</b> |                           |  |  |
|        |               |         |        | ±2%     | <b>GJM1555C1H130GB01#</b> |                           |  |  |
|        |               |         | 13pF   | ±5%     | <b>GJM1555C1H130JB01#</b> |                           |  |  |
|        |               |         |        | ±2%     | <b>GJM1555C1H150GB01#</b> |                           |  |  |
|        |               |         | 15pF   | ±5%     | <b>GJM1555C1H150JB01#</b> |                           |  |  |
|        |               |         |        | ±2%     | <b>GJM1555C1H160GB01#</b> |                           |  |  |
|        |               |         | 16pF   | ±5%     | <b>GJM1555C1H160JB01#</b> |                           |  |  |
|        |               |         |        | ±2%     | <b>GJM1555C1H180GB01#</b> |                           |  |  |
|        |               |         | 18pF   | ±5%     | <b>GJM1555C1H180JB01#</b> |                           |  |  |
|        |               |         |        | ±2%     | <b>GJM1555C1H200GB01#</b> |                           |  |  |
|        |               |         | 20pF   | ±5%     | <b>GJM1555C1H200JB01#</b> |                           |  |  |
|        |               |         |        | ±1%     | <b>GJM1555C1H220FB01#</b> |                           |  |  |
|        |               |         | 22pF   | ±2%     | <b>GJM1555C1H220GB01#</b> |                           |  |  |
|        |               |         |        | ±5%     | <b>GJM1555C1H220JB01#</b> |                           |  |  |
|        |               |         |        | ±1%     | <b>GJM1555C1H240FB01#</b> |                           |  |  |
|        |               |         | 24pF   | ±2%     | <b>GJM1555C1H240GB01#</b> |                           |  |  |
|        |               |         |        | ±5%     | <b>GJM1555C1H240JB01#</b> |                           |  |  |
|        |               |         |        | ±1%     | <b>GJM1555C1H270FB01#</b> |                           |  |  |
|        |               |         | 27pF   | ±2%     | <b>GJM1555C1H270GB01#</b> |                           |  |  |
|        |               |         |        | ±5%     | <b>GJM1555C1H270JB01#</b> |                           |  |  |
|        |               |         |        | ±1%     | <b>GJM1555C1H300FB01#</b> |                           |  |  |
|        |               |         | 30pF   | ±2%     | <b>GJM1555C1H300GB01#</b> |                           |  |  |
|        |               |         |        | ±5%     | <b>GJM1555C1H300JB01#</b> |                           |  |  |
|        |               |         |        | ±1%     | <b>GJM1555C1H330FB01#</b> |                           |  |  |
|        |               |         | 33pF   | ±2%     | <b>GJM1555C1H330GB01#</b> |                           |  |  |
|        |               |         |        | ±5%     | <b>GJM1555C1H330JB01#</b> |                           |  |  |
|        |               |         |        | ±1%     | <b>GJM1555C1H360FB01#</b> |                           |  |  |
|        |               |         | 36pF   | ±2%     | <b>GJM1555C1H360GB01#</b> |                           |  |  |
|        |               |         |        | ±5%     | <b>GJM1555C1H360JB01#</b> |                           |  |  |
|        |               |         |        | ±1%     | <b>GJM1555C1H390FB01#</b> |                           |  |  |
|        |               |         | 39pF   | ±2%     | <b>GJM1555C1H390GB01#</b> |                           |  |  |
|        |               |         |        | ±5%     | <b>GJM1555C1H390JB01#</b> |                           |  |  |
|        |               |         |        | ±1%     | <b>GJM1555C1H430FB01#</b> |                           |  |  |
|        |               |         | 43pF   | ±2%     | <b>GJM1555C1H430GB01#</b> |                           |  |  |
|        |               |         |        | ±5%     | <b>GJM1555C1H430JB01#</b> |                           |  |  |
|        |               |         |        | ±1%     | <b>GJM1555C1H470FB01#</b> |                           |  |  |
|        |               |         | 47pF   | ±2%     | <b>GJM1555C1H470GB01#</b> |                           |  |  |
|        |               |         |        | ±5%     | <b>GJM1555C1H470JB01#</b> |                           |  |  |
|        |               |         |        | 0.10pF  | ±0.05pF                   | <b>GJM1554C1HR10WB01#</b> |  |  |
|        |               |         | ±0.1pF |         | <b>GJM1554C1HR10BB01#</b> |                           |  |  |
|        |               |         | 0.20pF | ±0.05pF | <b>GJM1554C1HR20WB01#</b> |                           |  |  |
|        |               |         |        | ±0.1pF  | <b>GJM1554C1HR20BB01#</b> |                           |  |  |
|        |               |         | 0.30pF | ±0.05pF | <b>GJM1554C1HR30WB01#</b> |                           |  |  |
|        |               |         |        | ±0.1pF  | <b>GJM1554C1HR30BB01#</b> |                           |  |  |
|        |               |         | 0.40pF | ±0.05pF | <b>GJM1554C1HR40WB01#</b> |                           |  |  |
|        |               |         |        | ±0.1pF  | <b>GJM1554C1HR40BB01#</b> |                           |  |  |
|        |               |         | 0.50pF | ±0.05pF | <b>GJM1554C1HR50WB01#</b> |                           |  |  |
|        |               |         |        | ±0.1pF  | <b>GJM1554C1HR50BB01#</b> |                           |  |  |
|        |               |         | 0.60pF | ±0.05pF | <b>GJM1554C1HR60WB01#</b> |                           |  |  |
|        |               |         |        | ±0.1pF  | <b>GJM1554C1HR60BB01#</b> |                           |  |  |
|        |               |         | 0.70pF | ±0.05pF | <b>GJM1554C1HR70WB01#</b> |                           |  |  |
|        |               |         |        | ±0.1pF  | <b>GJM1554C1HR70BB01#</b> |                           |  |  |
|        |               |         | 0.80pF | ±0.05pF | <b>GJM1554C1HR80WB01#</b> |                           |  |  |
|        |               |         |        | ±0.1pF  | <b>GJM1554C1HR80BB01#</b> |                           |  |  |
|        |               |         |        |         | CK                        |                           |  |  |

Part number # indicates the package specification code.

GRM Series  
**GJM Series**  
 GMA Series  
 GMD Series  
 GQM Series  
 GRJ Series  
 GR3 Series  
 KRM Series  
 KR3 Series  
 LLA Series  
 LLL Series  
 LLM Series  
 LLR Series  
 ⚠Caution/  
 Notice

# GJM Series Temperature Compensating Type High Q Part Number List

(→ ■ 1.0x0.5mm)

| T max. | Rated Voltage | TC Code | Cap.    | Tol.                      | Part Number               |
|--------|---------------|---------|---------|---------------------------|---------------------------|
| 0.55mm | 50Vdc         | CK      | 0.90pF  | ±0.05pF                   | <b>GJM1554C1HR90WB01#</b> |
|        |               |         |         | ±0.1pF                    | <b>GJM1554C1HR90BB01#</b> |
|        |               |         | 1.0pF   | ±0.05pF                   | <b>GJM1554C1H1R0WB01#</b> |
|        |               |         |         | ±0.1pF                    | <b>GJM1554C1H1R0BB01#</b> |
|        |               |         |         | ±0.25pF                   | <b>GJM1554C1H1R0CB01#</b> |
|        |               |         | 1.1pF   | ±0.05pF                   | <b>GJM1554C1H1R1WB01#</b> |
|        |               |         |         | ±0.1pF                    | <b>GJM1554C1H1R1BB01#</b> |
|        |               |         |         | ±0.25pF                   | <b>GJM1554C1H1R1CB01#</b> |
|        |               |         | 1.2pF   | ±0.05pF                   | <b>GJM1554C1H1R2WB01#</b> |
|        |               |         |         | ±0.1pF                    | <b>GJM1554C1H1R2BB01#</b> |
|        |               |         |         | ±0.25pF                   | <b>GJM1554C1H1R2CB01#</b> |
|        |               |         | 1.3pF   | ±0.05pF                   | <b>GJM1554C1H1R3WB01#</b> |
|        |               |         |         | ±0.1pF                    | <b>GJM1554C1H1R3BB01#</b> |
|        |               |         |         | ±0.25pF                   | <b>GJM1554C1H1R3CB01#</b> |
|        |               |         | 1.4pF   | ±0.05pF                   | <b>GJM1554C1H1R4WB01#</b> |
|        |               |         |         | ±0.1pF                    | <b>GJM1554C1H1R4BB01#</b> |
|        |               |         |         | ±0.25pF                   | <b>GJM1554C1H1R4CB01#</b> |
|        |               |         | 1.5pF   | ±0.05pF                   | <b>GJM1554C1H1R5WB01#</b> |
|        |               |         |         | ±0.1pF                    | <b>GJM1554C1H1R5BB01#</b> |
|        |               |         |         | ±0.25pF                   | <b>GJM1554C1H1R5CB01#</b> |
|        |               |         | 1.6pF   | ±0.05pF                   | <b>GJM1554C1H1R6WB01#</b> |
|        |               |         |         | ±0.1pF                    | <b>GJM1554C1H1R6BB01#</b> |
|        |               |         |         | ±0.25pF                   | <b>GJM1554C1H1R6CB01#</b> |
|        |               |         | 1.7pF   | ±0.05pF                   | <b>GJM1554C1H1R7WB01#</b> |
|        |               |         |         | ±0.1pF                    | <b>GJM1554C1H1R7BB01#</b> |
|        |               |         |         | ±0.25pF                   | <b>GJM1554C1H1R7CB01#</b> |
|        |               |         | 1.8pF   | ±0.05pF                   | <b>GJM1554C1H1R8WB01#</b> |
|        |               | ±0.1pF  |         | <b>GJM1554C1H1R8BB01#</b> |                           |
|        |               | ±0.25pF |         | <b>GJM1554C1H1R8CB01#</b> |                           |
|        |               | 1.9pF   | ±0.05pF | <b>GJM1554C1H1R9WB01#</b> |                           |
|        |               |         | ±0.1pF  | <b>GJM1554C1H1R9BB01#</b> |                           |
|        |               |         | ±0.25pF | <b>GJM1554C1H1R9CB01#</b> |                           |
|        |               | 2.0pF   | ±0.05pF | <b>GJM1554C1H2R0WB01#</b> |                           |
|        |               |         | ±0.1pF  | <b>GJM1554C1H2R0BB01#</b> |                           |
|        |               |         | ±0.25pF | <b>GJM1554C1H2R0CB01#</b> |                           |
|        |               | CJ      | 2.1pF   | ±0.05pF                   | <b>GJM1553C1H2R1WB01#</b> |
|        |               |         |         | ±0.1pF                    | <b>GJM1553C1H2R1BB01#</b> |
|        |               |         |         | ±0.25pF                   | <b>GJM1553C1H2R1CB01#</b> |
|        |               |         | 2.2pF   | ±0.05pF                   | <b>GJM1553C1H2R2WB01#</b> |
|        |               |         |         | ±0.1pF                    | <b>GJM1553C1H2R2BB01#</b> |
|        |               |         |         | ±0.25pF                   | <b>GJM1553C1H2R2CB01#</b> |
|        |               |         | 2.3pF   | ±0.05pF                   | <b>GJM1553C1H2R3WB01#</b> |
|        |               |         |         | ±0.1pF                    | <b>GJM1553C1H2R3BB01#</b> |
|        |               |         |         | ±0.25pF                   | <b>GJM1553C1H2R3CB01#</b> |
|        |               |         | 2.4pF   | ±0.05pF                   | <b>GJM1553C1H2R4WB01#</b> |
|        |               |         |         | ±0.1pF                    | <b>GJM1553C1H2R4BB01#</b> |
|        |               |         |         | ±0.25pF                   | <b>GJM1553C1H2R4CB01#</b> |
|        |               |         | 2.5pF   | ±0.05pF                   | <b>GJM1553C1H2R5WB01#</b> |
|        |               |         |         | ±0.1pF                    | <b>GJM1553C1H2R5BB01#</b> |
|        |               |         |         | ±0.25pF                   | <b>GJM1553C1H2R5CB01#</b> |
|        |               |         | 2.6pF   | ±0.05pF                   | <b>GJM1553C1H2R6WB01#</b> |
|        |               |         |         | ±0.1pF                    | <b>GJM1553C1H2R6BB01#</b> |
|        |               |         |         | ±0.25pF                   | <b>GJM1553C1H2R6CB01#</b> |
|        |               |         | 2.7pF   | ±0.05pF                   | <b>GJM1553C1H2R7WB01#</b> |

| T max. | Rated Voltage | TC Code | Cap.    | Tol.                      | Part Number               |
|--------|---------------|---------|---------|---------------------------|---------------------------|
| 0.55mm | 50Vdc         | CJ      | 2.7pF   | ±0.1pF                    | <b>GJM1553C1H2R7BB01#</b> |
|        |               |         |         | ±0.25pF                   | <b>GJM1553C1H2R7CB01#</b> |
|        |               |         | 2.8pF   | ±0.05pF                   | <b>GJM1553C1H2R8WB01#</b> |
|        |               |         |         | ±0.1pF                    | <b>GJM1553C1H2R8BB01#</b> |
|        |               |         |         | ±0.25pF                   | <b>GJM1553C1H2R8CB01#</b> |
|        |               |         | 2.9pF   | ±0.05pF                   | <b>GJM1553C1H2R9WB01#</b> |
|        |               |         |         | ±0.1pF                    | <b>GJM1553C1H2R9BB01#</b> |
|        |               |         |         | ±0.25pF                   | <b>GJM1553C1H2R9CB01#</b> |
|        |               |         | 3.0pF   | ±0.05pF                   | <b>GJM1553C1H3R0WB01#</b> |
|        |               |         |         | ±0.1pF                    | <b>GJM1553C1H3R0BB01#</b> |
|        |               |         |         | ±0.25pF                   | <b>GJM1553C1H3R0CB01#</b> |
|        |               |         | 3.1pF   | ±0.05pF                   | <b>GJM1553C1H3R1WB01#</b> |
|        |               |         |         | ±0.1pF                    | <b>GJM1553C1H3R1BB01#</b> |
|        |               |         |         | ±0.25pF                   | <b>GJM1553C1H3R1CB01#</b> |
|        |               |         | 3.2pF   | ±0.05pF                   | <b>GJM1553C1H3R2WB01#</b> |
|        |               |         |         | ±0.1pF                    | <b>GJM1553C1H3R2BB01#</b> |
|        |               |         |         | ±0.25pF                   | <b>GJM1553C1H3R2CB01#</b> |
|        |               |         | 3.3pF   | ±0.05pF                   | <b>GJM1553C1H3R3WB01#</b> |
|        |               |         |         | ±0.1pF                    | <b>GJM1553C1H3R3BB01#</b> |
|        |               |         |         | ±0.25pF                   | <b>GJM1553C1H3R3CB01#</b> |
|        |               |         | 3.4pF   | ±0.05pF                   | <b>GJM1553C1H3R4WB01#</b> |
|        |               |         |         | ±0.1pF                    | <b>GJM1553C1H3R4BB01#</b> |
|        |               |         |         | ±0.25pF                   | <b>GJM1553C1H3R4CB01#</b> |
|        |               |         | 3.5pF   | ±0.05pF                   | <b>GJM1553C1H3R5WB01#</b> |
|        |               |         |         | ±0.1pF                    | <b>GJM1553C1H3R5BB01#</b> |
|        |               |         |         | ±0.25pF                   | <b>GJM1553C1H3R5CB01#</b> |
|        |               |         | 3.6pF   | ±0.05pF                   | <b>GJM1553C1H3R6WB01#</b> |
|        |               | ±0.1pF  |         | <b>GJM1553C1H3R6BB01#</b> |                           |
|        |               | ±0.25pF |         | <b>GJM1553C1H3R6CB01#</b> |                           |
|        |               | 3.7pF   | ±0.05pF | <b>GJM1553C1H3R7WB01#</b> |                           |
|        |               |         | ±0.1pF  | <b>GJM1553C1H3R7BB01#</b> |                           |
|        |               |         | ±0.25pF | <b>GJM1553C1H3R7CB01#</b> |                           |
|        |               | 3.8pF   | ±0.05pF | <b>GJM1553C1H3R8WB01#</b> |                           |
|        |               |         | ±0.1pF  | <b>GJM1553C1H3R8BB01#</b> |                           |
|        |               |         | ±0.25pF | <b>GJM1553C1H3R8CB01#</b> |                           |
|        |               | 3.9pF   | ±0.05pF | <b>GJM1553C1H3R9WB01#</b> |                           |
|        |               |         | ±0.1pF  | <b>GJM1553C1H3R9BB01#</b> |                           |
|        |               |         | ±0.25pF | <b>GJM1553C1H3R9CB01#</b> |                           |
|        |               | CH      | 4.0pF   | ±0.05pF                   | <b>GJM1552C1H4R0WB01#</b> |
|        |               |         |         | ±0.1pF                    | <b>GJM1552C1H4R0BB01#</b> |
|        |               |         |         | ±0.25pF                   | <b>GJM1552C1H4R0CB01#</b> |
|        |               |         | 4.1pF   | ±0.05pF                   | <b>GJM1552C1H4R1WB01#</b> |
|        |               |         |         | ±0.1pF                    | <b>GJM1552C1H4R1BB01#</b> |
|        |               |         |         | ±0.25pF                   | <b>GJM1552C1H4R1CB01#</b> |
|        |               |         | 4.2pF   | ±0.05pF                   | <b>GJM1552C1H4R2WB01#</b> |
|        |               |         |         | ±0.1pF                    | <b>GJM1552C1H4R2BB01#</b> |
|        |               |         |         | ±0.25pF                   | <b>GJM1552C1H4R2CB01#</b> |
|        |               |         | 4.3pF   | ±0.05pF                   | <b>GJM1552C1H4R3WB01#</b> |
|        |               |         |         | ±0.1pF                    | <b>GJM1552C1H4R3BB01#</b> |
|        |               |         |         | ±0.25pF                   | <b>GJM1552C1H4R3CB01#</b> |
|        |               |         | 4.4pF   | ±0.05pF                   | <b>GJM1552C1H4R4WB01#</b> |
|        |               |         |         | ±0.1pF                    | <b>GJM1552C1H4R4BB01#</b> |
|        |               |         |         | ±0.25pF                   | <b>GJM1552C1H4R4CB01#</b> |
|        |               |         | 4.5pF   | ±0.05pF                   | <b>GJM1552C1H4R5WB01#</b> |

Part number # indicates the package specification code.

GRM Series  
 GJM Series  
 GMA Series  
 GMD Series  
 GQM Series  
 GRJ Series  
 GR3 Series  
 KRM Series  
 KR3 Series  
 LLA Series  
 LLL Series  
 LLM Series  
 LLR Series  
 ⚠Caution/ Notice

# GJM Series Temperature Compensating Type High Q Part Number List

(→ ■ 1.0x0.5mm)

| T max. | Rated Voltage | TC Code | Cap.  | Tol.    | Part Number        |
|--------|---------------|---------|-------|---------|--------------------|
| 0.55mm | 50Vdc         | CH      | 4.5pF | ±0.1pF  | GJM1552C1H4R5BB01# |
|        |               |         |       | ±0.25pF | GJM1552C1H4R5CB01# |
|        |               |         | 4.6pF | ±0.05pF | GJM1552C1H4R6WB01# |
|        |               |         |       | ±0.1pF  | GJM1552C1H4R6BB01# |
|        |               |         | 4.7pF | ±0.05pF | GJM1552C1H4R7WB01# |
|        |               |         |       | ±0.1pF  | GJM1552C1H4R7BB01# |
|        |               |         | 4.8pF | ±0.05pF | GJM1552C1H4R8WB01# |
|        |               |         |       | ±0.1pF  | GJM1552C1H4R8BB01# |
|        |               |         | 4.9pF | ±0.05pF | GJM1552C1H4R9WB01# |
|        |               |         |       | ±0.1pF  | GJM1552C1H4R9BB01# |
|        |               |         | 5.0pF | ±0.05pF | GJM1552C1H5R0WB01# |
|        |               |         |       | ±0.1pF  | GJM1552C1H5R0BB01# |
|        |               |         | 5.1pF | ±0.05pF | GJM1552C1H5R1WB01# |
|        |               |         |       | ±0.1pF  | GJM1552C1H5R1BB01# |
|        |               |         | 5.2pF | ±0.05pF | GJM1552C1H5R2WB01# |
|        |               |         |       | ±0.1pF  | GJM1552C1H5R2BB01# |
|        |               |         | 5.3pF | ±0.05pF | GJM1552C1H5R3WB01# |
|        |               |         |       | ±0.1pF  | GJM1552C1H5R3BB01# |
|        |               |         | 5.4pF | ±0.05pF | GJM1552C1H5R4WB01# |
|        |               |         |       | ±0.1pF  | GJM1552C1H5R4BB01# |
|        |               |         | 5.5pF | ±0.05pF | GJM1552C1H5R5WB01# |
|        |               |         |       | ±0.1pF  | GJM1552C1H5R5BB01# |
|        |               |         | 5.6pF | ±0.05pF | GJM1552C1H5R6WB01# |
|        |               |         |       | ±0.1pF  | GJM1552C1H5R6BB01# |
|        |               |         | 5.7pF | ±0.05pF | GJM1552C1H5R7WB01# |
|        |               |         |       | ±0.1pF  | GJM1552C1H5R7BB01# |
|        |               |         | 5.8pF | ±0.05pF | GJM1552C1H5R8WB01# |
|        |               |         |       | ±0.1pF  | GJM1552C1H5R8BB01# |
|        |               |         | 5.9pF | ±0.05pF | GJM1552C1H5R9WB01# |
|        |               |         |       | ±0.1pF  | GJM1552C1H5R9BB01# |
|        |               |         | 6.0pF | ±0.05pF | GJM1552C1H6R0WB01# |
|        |               |         |       | ±0.1pF  | GJM1552C1H6R0BB01# |

| T max. | Rated Voltage | TC Code | Cap.  | Tol.    | Part Number        |
|--------|---------------|---------|-------|---------|--------------------|
| 0.55mm | 50Vdc         | CH      | 6.0pF | ±0.1pF  | GJM1552C1H6R0BB01# |
|        |               |         |       | ±0.25pF | GJM1552C1H6R0CB01# |
|        |               |         |       | ±0.5pF  | GJM1552C1H6R0DB01# |
|        |               |         | 6.1pF | ±0.05pF | GJM1552C1H6R1WB01# |
|        |               |         |       | ±0.1pF  | GJM1552C1H6R1BB01# |
|        |               |         |       | ±0.25pF | GJM1552C1H6R1CB01# |
|        |               |         | 6.2pF | ±0.05pF | GJM1552C1H6R2WB01# |
|        |               |         |       | ±0.1pF  | GJM1552C1H6R2BB01# |
|        |               |         |       | ±0.25pF | GJM1552C1H6R2CB01# |
|        |               |         | 6.3pF | ±0.05pF | GJM1552C1H6R3WB01# |
|        |               |         |       | ±0.1pF  | GJM1552C1H6R3BB01# |
|        |               |         |       | ±0.25pF | GJM1552C1H6R3CB01# |
|        |               |         | 6.4pF | ±0.05pF | GJM1552C1H6R4WB01# |
|        |               |         |       | ±0.1pF  | GJM1552C1H6R4BB01# |
|        |               |         |       | ±0.25pF | GJM1552C1H6R4CB01# |
|        |               |         | 6.5pF | ±0.05pF | GJM1552C1H6R5WB01# |
|        |               |         |       | ±0.1pF  | GJM1552C1H6R5BB01# |
|        |               |         |       | ±0.25pF | GJM1552C1H6R5CB01# |
|        |               |         | 6.6pF | ±0.05pF | GJM1552C1H6R6WB01# |
|        |               |         |       | ±0.1pF  | GJM1552C1H6R6BB01# |
|        |               |         |       | ±0.25pF | GJM1552C1H6R6CB01# |
|        |               |         | 6.7pF | ±0.05pF | GJM1552C1H6R7WB01# |
|        |               |         |       | ±0.1pF  | GJM1552C1H6R7BB01# |
|        |               |         |       | ±0.25pF | GJM1552C1H6R7CB01# |
|        |               |         | 6.8pF | ±0.05pF | GJM1552C1H6R8WB01# |
|        |               |         |       | ±0.1pF  | GJM1552C1H6R8BB01# |
|        |               |         |       | ±0.25pF | GJM1552C1H6R8CB01# |
|        |               |         | 6.9pF | ±0.05pF | GJM1552C1H6R9WB01# |
|        |               |         |       | ±0.1pF  | GJM1552C1H6R9BB01# |
|        |               |         |       | ±0.25pF | GJM1552C1H6R9CB01# |
|        |               |         | 7.0pF | ±0.05pF | GJM1552C1H7R0WB01# |
|        |               |         |       | ±0.1pF  | GJM1552C1H7R0BB01# |
|        |               |         |       | ±0.25pF | GJM1552C1H7R0CB01# |
|        |               |         | 7.1pF | ±0.05pF | GJM1552C1H7R1WB01# |
|        |               |         |       | ±0.1pF  | GJM1552C1H7R1BB01# |
|        |               |         |       | ±0.25pF | GJM1552C1H7R1CB01# |
|        |               |         | 7.2pF | ±0.05pF | GJM1552C1H7R2WB01# |
|        |               |         |       | ±0.1pF  | GJM1552C1H7R2BB01# |
|        |               |         |       | ±0.25pF | GJM1552C1H7R2CB01# |
|        |               |         | 7.3pF | ±0.05pF | GJM1552C1H7R3WB01# |
|        |               |         |       | ±0.1pF  | GJM1552C1H7R3BB01# |
|        |               |         |       | ±0.25pF | GJM1552C1H7R3CB01# |

Part number # indicates the package specification code.

GRM Series  
 GJM Series  
 GMA Series  
 GMD Series  
 GQM Series  
 GRJ Series  
 GR3 Series  
 KRM Series  
 KR3 Series  
 LLA Series  
 LLL Series  
 LLM Series  
 LLR Series  
 ⚠Caution/  
 Notice

## GJM Series Temperature Compensating Type High Q Part Number List

(→ ■ 1.0x0.5mm)

| T max. | Rated Voltage | TC Code | Cap.    | Tol.    | Part Number        |
|--------|---------------|---------|---------|---------|--------------------|
| 0.55mm | 50Vdc         | CH      | 7.3pF   | ±0.5pF  | GJM1552C1H7R3DB01# |
|        |               |         |         | ±0.05pF | GJM1552C1H7R4WB01# |
|        |               |         | 7.4pF   | ±0.1pF  | GJM1552C1H7R4BB01# |
|        |               |         |         | ±0.25pF | GJM1552C1H7R4CB01# |
|        |               |         |         | ±0.5pF  | GJM1552C1H7R4DB01# |
|        |               |         |         | 7.5pF   | ±0.05pF            |
|        |               |         | ±0.1pF  |         | GJM1552C1H7R5BB01# |
|        |               |         | ±0.25pF |         | GJM1552C1H7R5CB01# |
|        |               |         | ±0.5pF  |         | GJM1552C1H7R5DB01# |
|        |               |         | 7.6pF   | ±0.05pF | GJM1552C1H7R6WB01# |
|        |               |         |         | ±0.1pF  | GJM1552C1H7R6BB01# |
|        |               |         |         | ±0.25pF | GJM1552C1H7R6CB01# |
|        |               |         |         | ±0.5pF  | GJM1552C1H7R6DB01# |
|        |               |         | 7.7pF   | ±0.05pF | GJM1552C1H7R7WB01# |
|        |               |         |         | ±0.1pF  | GJM1552C1H7R7BB01# |
|        |               |         |         | ±0.25pF | GJM1552C1H7R7CB01# |
|        |               |         |         | ±0.5pF  | GJM1552C1H7R7DB01# |
|        |               |         | 7.8pF   | ±0.05pF | GJM1552C1H7R8WB01# |
|        |               |         |         | ±0.1pF  | GJM1552C1H7R8BB01# |
|        |               |         |         | ±0.25pF | GJM1552C1H7R8CB01# |
|        |               |         |         | ±0.5pF  | GJM1552C1H7R8DB01# |
|        |               |         | 7.9pF   | ±0.05pF | GJM1552C1H7R9WB01# |
|        |               |         |         | ±0.1pF  | GJM1552C1H7R9BB01# |
|        |               |         |         | ±0.25pF | GJM1552C1H7R9CB01# |
|        |               |         |         | ±0.5pF  | GJM1552C1H7R9DB01# |
|        |               |         | 8.0pF   | ±0.05pF | GJM1552C1H8R0WB01# |
|        |               |         |         | ±0.1pF  | GJM1552C1H8R0BB01# |
|        |               |         |         | ±0.25pF | GJM1552C1H8R0CB01# |
|        |               |         |         | ±0.5pF  | GJM1552C1H8R0DB01# |
|        |               |         | 8.1pF   | ±0.05pF | GJM1552C1H8R1WB01# |
|        |               |         |         | ±0.1pF  | GJM1552C1H8R1BB01# |
|        |               |         |         | ±0.25pF | GJM1552C1H8R1CB01# |
|        |               |         |         | ±0.5pF  | GJM1552C1H8R1DB01# |
|        |               |         | 8.2pF   | ±0.05pF | GJM1552C1H8R2WB01# |
|        |               |         |         | ±0.1pF  | GJM1552C1H8R2BB01# |
|        |               |         |         | ±0.25pF | GJM1552C1H8R2CB01# |
|        |               |         |         | ±0.5pF  | GJM1552C1H8R2DB01# |
|        |               |         | 8.3pF   | ±0.05pF | GJM1552C1H8R3WB01# |
|        |               |         |         | ±0.1pF  | GJM1552C1H8R3BB01# |
|        |               |         |         | ±0.25pF | GJM1552C1H8R3CB01# |
|        |               |         |         | ±0.5pF  | GJM1552C1H8R3DB01# |
|        |               |         | 8.4pF   | ±0.05pF | GJM1552C1H8R4WB01# |
|        |               |         |         | ±0.1pF  | GJM1552C1H8R4BB01# |
|        |               |         |         | ±0.25pF | GJM1552C1H8R4CB01# |
|        |               |         |         | ±0.5pF  | GJM1552C1H8R4DB01# |
|        |               |         | 8.5pF   | ±0.05pF | GJM1552C1H8R5WB01# |
|        |               |         |         | ±0.1pF  | GJM1552C1H8R5BB01# |
|        |               |         |         | ±0.25pF | GJM1552C1H8R5CB01# |
|        |               |         |         | ±0.5pF  | GJM1552C1H8R5DB01# |
|        |               |         | 8.6pF   | ±0.05pF | GJM1552C1H8R6WB01# |
|        |               |         |         | ±0.1pF  | GJM1552C1H8R6BB01# |
|        |               |         |         | ±0.25pF | GJM1552C1H8R6CB01# |
|        |               |         |         | ±0.5pF  | GJM1552C1H8R6DB01# |
|        |               |         | 8.7pF   | ±0.05pF | GJM1552C1H8R7WB01# |

| T max. | Rated Voltage | TC Code | Cap.  | Tol.    | Part Number        |
|--------|---------------|---------|-------|---------|--------------------|
| 0.55mm | 50Vdc         | CH      | 8.7pF | ±0.1pF  | GJM1552C1H8R7BB01# |
|        |               |         |       | ±0.25pF | GJM1552C1H8R7CB01# |
|        |               |         |       | ±0.5pF  | GJM1552C1H8R7DB01# |
|        |               |         | 8.8pF | ±0.05pF | GJM1552C1H8R8WB01# |
|        |               |         |       | ±0.1pF  | GJM1552C1H8R8BB01# |
|        |               |         |       | ±0.25pF | GJM1552C1H8R8CB01# |
|        |               |         | 8.9pF | ±0.05pF | GJM1552C1H8R9WB01# |
|        |               |         |       | ±0.1pF  | GJM1552C1H8R9BB01# |
|        |               |         |       | ±0.25pF | GJM1552C1H8R9CB01# |
|        |               |         | 9.0pF | ±0.05pF | GJM1552C1H9R0WB01# |
|        |               |         |       | ±0.1pF  | GJM1552C1H9R0BB01# |
|        |               |         |       | ±0.25pF | GJM1552C1H9R0CB01# |
|        |               |         | 9.1pF | ±0.05pF | GJM1552C1H9R1WB01# |
|        |               |         |       | ±0.1pF  | GJM1552C1H9R1BB01# |
|        |               |         |       | ±0.25pF | GJM1552C1H9R1CB01# |
|        |               |         | 9.2pF | ±0.05pF | GJM1552C1H9R2WB01# |
|        |               |         |       | ±0.1pF  | GJM1552C1H9R2BB01# |
|        |               |         |       | ±0.25pF | GJM1552C1H9R2CB01# |
|        |               |         | 9.3pF | ±0.05pF | GJM1552C1H9R3WB01# |
|        |               |         |       | ±0.1pF  | GJM1552C1H9R3BB01# |
|        |               |         |       | ±0.25pF | GJM1552C1H9R3CB01# |
|        |               |         | 9.4pF | ±0.05pF | GJM1552C1H9R4WB01# |
|        |               |         |       | ±0.1pF  | GJM1552C1H9R4BB01# |
|        |               |         |       | ±0.25pF | GJM1552C1H9R4CB01# |
|        |               |         | 9.5pF | ±0.05pF | GJM1552C1H9R5WB01# |
|        |               |         |       | ±0.1pF  | GJM1552C1H9R5BB01# |
|        |               |         |       | ±0.25pF | GJM1552C1H9R5CB01# |
|        |               |         | 9.6pF | ±0.05pF | GJM1552C1H9R6WB01# |
|        |               |         |       | ±0.1pF  | GJM1552C1H9R6BB01# |
|        |               |         |       | ±0.25pF | GJM1552C1H9R6CB01# |
|        |               |         | 9.7pF | ±0.05pF | GJM1552C1H9R7WB01# |
|        |               |         |       | ±0.1pF  | GJM1552C1H9R7BB01# |
|        |               |         |       | ±0.25pF | GJM1552C1H9R7CB01# |
|        |               |         | 9.8pF | ±0.05pF | GJM1552C1H9R8WB01# |
|        |               |         |       | ±0.1pF  | GJM1552C1H9R8BB01# |
|        |               |         |       | ±0.25pF | GJM1552C1H9R8CB01# |
|        |               |         | 9.9pF | ±0.05pF | GJM1552C1H9R9WB01# |
|        |               |         |       | ±0.1pF  | GJM1552C1H9R9BB01# |
|        |               |         |       | ±0.25pF | GJM1552C1H9R9CB01# |
|        |               |         | 10pF  | ±2%     | GJM1552C1H100GB01# |
|        |               |         |       | ±5%     | GJM1552C1H100JB01# |
|        |               |         | 11pF  | ±2%     | GJM1552C1H110GB01# |

Part number # indicates the package specification code.

# GJM Series Temperature Compensating Type High Q Part Number List

(→ ■ 1.0x0.5mm)

| T max. | Rated Voltage | TC Code | Cap. | Tol. | Part Number        |
|--------|---------------|---------|------|------|--------------------|
| 0.55mm | 50Vdc         | CH      | 11pF | ±5%  | GJM1552C1H110JB01# |
|        |               |         |      | ±2%  | GJM1552C1H120GB01# |
|        |               |         | 12pF | ±5%  | GJM1552C1H120JB01# |
|        |               |         |      | ±2%  | GJM1552C1H130GB01# |
|        |               |         | 13pF | ±5%  | GJM1552C1H130JB01# |
|        |               |         |      | ±2%  | GJM1552C1H150GB01# |
|        |               |         | 15pF | ±5%  | GJM1552C1H150JB01# |
|        |               |         |      | ±2%  | GJM1552C1H160GB01# |
|        |               |         | 16pF | ±5%  | GJM1552C1H160JB01# |
|        |               |         |      | ±2%  | GJM1552C1H180GB01# |
|        |               |         | 18pF | ±5%  | GJM1552C1H180JB01# |
|        |               |         |      | ±2%  | GJM1552C1H200GB01# |
|        |               |         | 20pF | ±5%  | GJM1552C1H200JB01# |
|        |               |         |      | ±1%  | GJM1552C1H220FB01# |
|        |               |         | 22pF | ±2%  | GJM1552C1H220GB01# |
|        |               |         |      | ±5%  | GJM1552C1H220JB01# |
|        |               |         |      | ±1%  | GJM1552C1H240FB01# |
|        |               |         | 24pF | ±2%  | GJM1552C1H240GB01# |
|        |               |         |      | ±5%  | GJM1552C1H240JB01# |
|        |               |         |      | ±1%  | GJM1552C1H270FB01# |
|        |               |         | 27pF | ±2%  | GJM1552C1H270GB01# |
|        |               |         |      | ±5%  | GJM1552C1H270JB01# |
|        |               |         |      | ±1%  | GJM1552C1H300FB01# |
|        |               |         | 30pF | ±2%  | GJM1552C1H300GB01# |
|        |               |         |      | ±5%  | GJM1552C1H300JB01# |
|        |               |         |      | ±1%  | GJM1552C1H330FB01# |
|        |               |         | 33pF | ±2%  | GJM1552C1H330GB01# |
|        |               |         |      | ±5%  | GJM1552C1H330JB01# |
|        |               |         |      | ±1%  | GJM1552C1H360FB01# |
|        |               |         | 36pF | ±2%  | GJM1552C1H360GB01# |
|        |               |         |      | ±5%  | GJM1552C1H360JB01# |
|        |               |         |      | ±1%  | GJM1552C1H390FB01# |
|        |               |         | 39pF | ±2%  | GJM1552C1H390GB01# |
|        |               |         |      | ±5%  | GJM1552C1H390JB01# |
|        |               |         |      | ±1%  | GJM1552C1H430FB01# |
|        |               |         | 43pF | ±2%  | GJM1552C1H430GB01# |
|        |               |         |      | ±5%  | GJM1552C1H430JB01# |
|        |               |         |      | ±1%  | GJM1552C1H470FB01# |
|        |               |         | 47pF | ±2%  | GJM1552C1H470GB01# |
|        |               |         |      | ±5%  | GJM1552C1H470JB01# |

GRM Series

GJM Series

GMA Series

GMD Series

GQM Series

GRJ Series

GR3 Series

KRM Series

KR3 Series

LLA Series

LLL Series

LLM Series

LLR Series

⚠Caution/  
Notice

Top & Bottom Electrode Type for Bonding

# GMA Series

This capacitor is suitable for wire bonding mounting by the external electrodes of Au plating.  
 Mounting in IC packages is also possible with the upper/lower electrode structure!

## Features

① **Allows for high density mounting.**

Noise can be reduced by eliminating the routing of the wire, and high efficiency can be achieved with a built-in capacitor in a package, such as IC. Miniaturization of the set is also possible.

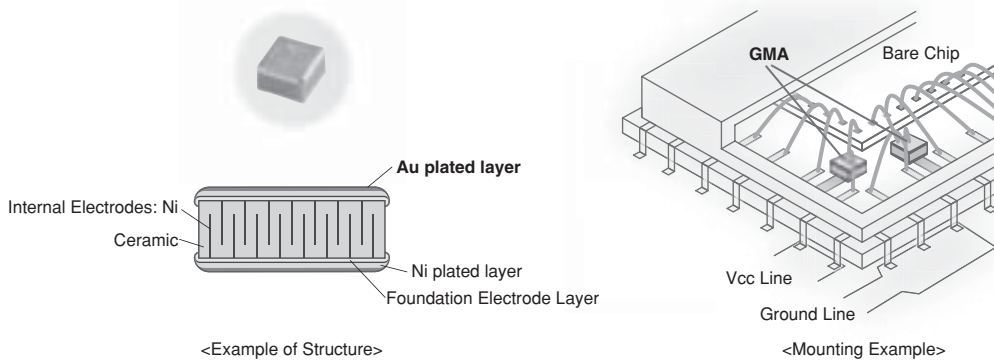

② **Ideal for bypass applications.**

Achieved small size and large capacity with a multilayer structure.

③ **Excellent in high frequency characteristics.**

Since the capacitor consists of an upper/lower electrode structure, the current path becomes shorter and lowers the ESL. Compared with the general purpose GRM series of the same capacity, the impedance of this product becomes lower at high frequencies.

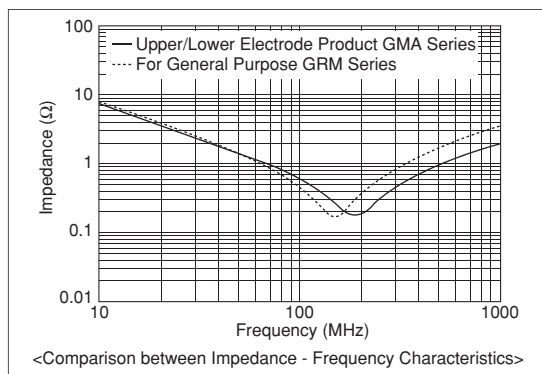

## Specifications

|                   |  |
|-------------------|--|
| Size              | 0.38×0.38mm to 0.8×0.8mm   |
| Rated Voltage     | DC6.3V to 100V   |
| Capacitance       | 100pF to 0.47μF  |
| Main Applications | 1. Optical communication related equipment<br>2. Various device related, such as GaAsIC (mounted in IC packages)<br>3. Measuring instruments, other ultra compact/thin devices |

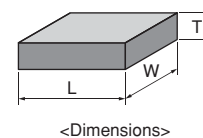

This catalog contains only a portion of the product lineup.  
 Please refer to the capacitor search tool on the Murata Web site for details.

# GMA Series High Dielectric Constant Type Part Number List

## ■ 0.38x0.38mm Ultra-compact

| T max. | Rated Voltage | TC Code | Cap.    | Tol.   | Part Number        |                    |
|--------|---------------|---------|---------|--------|--------------------|--------------------|
| 0.35mm | 10Vdc         | X7R     | 1000pF  | ±20%   | GMA0D3R71A102MA01# |                    |
|        |               |         | 1500pF  | ±20%   | GMA0D3R71A152MA01# |                    |
|        |               |         | 1800pF  | ±20%   | GMA0D3R71A182MA01# |                    |
|        |               |         | 10000pF | ±20%   | GMA0D3R71A103MA01# |                    |
|        |               |         | R       | 1000pF | ±20%               | GMA0D3R11A102MA01# |
|        |               |         |         | 1500pF | ±20%               | GMA0D3R11A152MA01# |
|        |               | 1800pF  |         | ±20%   | GMA0D3R11A182MA01# |                    |
|        |               | B       | 1000pF  | ±20%   | GMA0D3B11A102MA01# |                    |
|        |               |         | 1500pF  | ±20%   | GMA0D3B11A152MA01# |                    |
|        |               |         | 1800pF  | ±20%   | GMA0D3B11A182MA01# |                    |

## ■ 0.5x0.5mm

| T max. | Rated Voltage | TC Code | Cap.    | Tol.               | Part Number        |                    |                    |
|--------|---------------|---------|---------|--------------------|--------------------|--------------------|--------------------|
| 0.4mm  | 100Vdc        | X7R     | 100pF   | ±20%               | GMA05XR72A101MA01# |                    |                    |
|        |               |         | 150pF   | ±20%               | GMA05XR72A151MA01# |                    |                    |
|        |               |         | 220pF   | ±20%               | GMA05XR72A221MA01# |                    |                    |
|        |               |         | 330pF   | ±20%               | GMA05XR72A331MA01# |                    |                    |
|        |               |         | 470pF   | ±20%               | GMA05XR72A471MA01# |                    |                    |
|        |               |         | 680pF   | ±20%               | GMA05XR72A681MA01# |                    |                    |
|        |               |         | 1000pF  | ±20%               | GMA05XR72A102MA01# |                    |                    |
|        |               |         | X7R     | 1500pF             | ±20%               | GMA05XR71E152MA11# |                    |
|        |               |         |         | 2200pF             | ±20%               | GMA05XR71E222MA11# |                    |
|        |               | 3300pF  |         | ±20%               | GMA05XR71E332MA11# |                    |                    |
|        |               | B       | 1500pF  | ±20%               | GMA05XB31E152MA11# |                    |                    |
|        |               |         | 2200pF  | ±20%               | GMA05XB31E222MA11# |                    |                    |
|        |               |         | 3300pF  | ±20%               | GMA05XB31E332MA11# |                    |                    |
|        |               | 25Vdc   | X7R     | 4700pF             | ±20%               | GMA05XR71E472MA11# |                    |
|        |               |         |         | X7R                | 6800pF             | ±20%               | GMA05XR71A682MA01# |
|        |               |         |         |                    | 10000pF            | ±20%               | GMA05XR71A103MA01# |
|        |               |         |         |                    | 15000pF            | ±20%               | GMA05XR71A153MA01# |
|        |               |         |         |                    | 22000pF            | ±20%               | GMA05XR71A223MA01# |
|        | R             |         |         | 6800pF             | ±20%               | GMA05XR11A682MA01# |                    |
|        |               |         | 10000pF | ±20%               | GMA05XR11A103MA01# |                    |                    |
|        |               |         | 15000pF | ±20%               | GMA05XR11A153MA01# |                    |                    |
|        | B             |         | 22000pF | ±20%               | GMA05XR11A223MA01# |                    |                    |
|        |               |         | 6800pF  | ±20%               | GMA05XB11A682MA01# |                    |                    |
|        |               |         | 10000pF | ±20%               | GMA05XB11A103MA01# |                    |                    |
|        | 15000pF       |         | ±20%    | GMA05XB11A153MA01# |                    |                    |                    |
|        |               | 22000pF | ±20%    | GMA05XB11A223MA01# |                    |                    |                    |
|        |               | 6.3Vdc  | X5R     | 0.10μF             | ±20%               | GMA05XR60J104ME12# |                    |
|        | B             |         | 0.10μF  | ±20%               | GMA05XB30J104ME12# |                    |                    |

## ■ 0.8x0.8mm

| T max. | Rated Voltage | TC Code | Cap.   | Tol. | Part Number       |
|--------|---------------|---------|--------|------|-------------------|
| 0.6mm  | 100Vdc        | X7R     | 1500pF | ±20% | GMA08R72A152MA01# |
|        |               |         | 2200pF | ±20% | GMA08R72A222MA01# |

| T max. | Rated Voltage | TC Code | Cap.    | Tol.              | Part Number       |                   |
|--------|---------------|---------|---------|-------------------|-------------------|-------------------|
| 0.6mm  | 100Vdc        | X7R     | 3300pF  | ±20%              | GMA08R72A332MA01# |                   |
|        |               |         | 4700pF  | ±20%              | GMA08R72A472MA01# |                   |
|        |               |         | 6800pF  | ±20%              | GMA08R72A682MA01# |                   |
|        |               | 25Vdc   | X7R     | 10000pF           | ±20%              | GMA08R71E103MA11# |
|        |               |         |         | 15000pF           | ±20%              | GMA08R71E153MA11# |
|        |               |         |         | 22000pF           | ±20%              | GMA08R71E223MA11# |
|        | B             |         | 10000pF | ±20%              | GMA08B31E103MA11# |                   |
|        |               |         | 15000pF | ±20%              | GMA08B31E153MA11# |                   |
|        |               |         | 22000pF | ±20%              | GMA08B31E223MA11# |                   |
|        | 10Vdc         | X7R     | 33000pF | ±20%              | GMA08R71A333MA01# |                   |
|        |               |         | 47000pF | ±20%              | GMA08R71A473MA01# |                   |
|        |               |         | 68000pF | ±20%              | GMA08R71A683MA01# |                   |
|        |               |         | 0.10μF  | ±20%              | GMA08R71A104MA01# |                   |
|        |               |         | R       | 33000pF           | ±20%              | GMA08R11A333MA01# |
|        |               |         |         | 47000pF           | ±20%              | GMA08R11A473MA01# |
|        |               | 68000pF |         | ±20%              | GMA08R11A683MA01# |                   |
|        |               | B       | 0.10μF  | ±20%              | GMA08R11A104MA01# |                   |
|        |               |         | 33000pF | ±20%              | GMA08B11A333MA01# |                   |
|        |               |         | 47000pF | ±20%              | GMA08B11A473MA01# |                   |
|        |               | 68000pF | ±20%    | GMA08B11A683MA01# |                   |                   |
|        |               |         | 0.10μF  | ±20%              | GMA08B11A104MA01# |                   |
|        | 6.3Vdc        |         | X5R     | 0.47μF            | ±20%              | GMA08R60J474ME12# |
|        |               | B       | 0.47μF  | ±20%              | GMA08B30J474ME12# |                   |

Part number # indicates the package specification code.

GRM Series  
 GJM Series  
 GMA Series  
 GMD Series  
 GQM Series  
 GRJ Series  
 GR3 Series  
 KRM Series  
 KR3 Series  
 LLA Series  
 LLL Series  
 LLM Series  
 LLR Series  
 ⚠Caution/  
 Notice



Product for Bonding/AuSn Soldering

# GMD Series

This capacitor is compatible to wire bonding mounting by the external electrodes of Au plating.

## Features

① **Can be mounted by wire bonding and AuSn soldering.**

Since the external electrodes are based on the Au plating specification, mounting by wire/die bonding is possible.

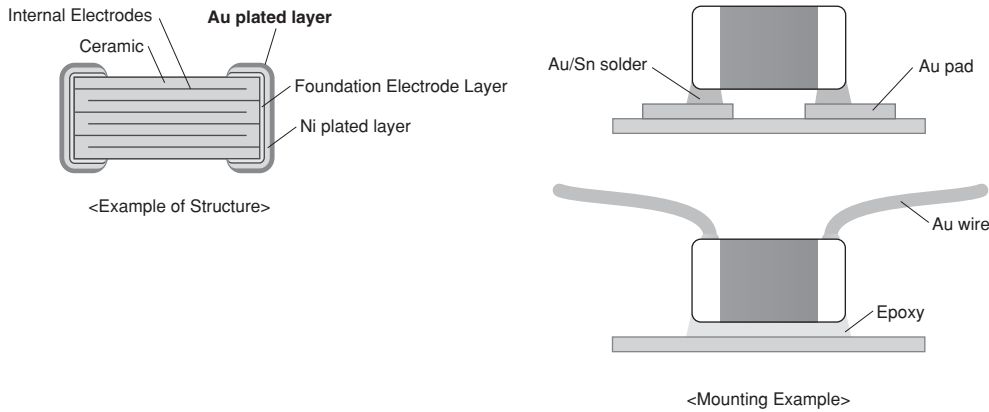

② **Ideal for mounting in packages, such as optical communication related devices , IC and etc.**

Noise can be reduced by eliminating the routing of the wire, and high efficiency can be achieved with a built-in capacitor in the package, such as TO-CAN, IC and etc. by wire bonding mounting.

③ **Contributes to the miniaturization of the set.**

Murata offers a lineup of small size products, such as the 0603 (0201) and 1005 (0402) in mm (inch).

## Specifications

|                   |  |
|-------------------|--|
| Size              | 0.6×0.3mm to 1.0×0.5mm   |
| Rated Voltage     | DC6.3V to 50V  |
| Capacitance       | 100pF to 1.0μF   |
| Main Applications | 1. Optical communication related equipment<br>2. Mounting in IC packages |

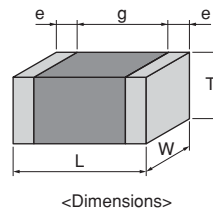

This catalog contains only a portion of the product lineup.  
 Please refer to the capacitor search tool on the Murata Web site for details.

GRM Series  
 GJM Series  
 GMA Series  
**GMD Series**  
 GQM Series  
 GRJ Series  
 GR3 Series  
 KRM Series  
 KR3 Series  
 LLA Series  
 LLL Series  
 LLM Series  
 LLR Series  
 ⚠Caution/Notice

# GMD Series High Dielectric Constant Type Part Number List

## 0.6x0.3mm Ultra-compact

| T max. | Rated Voltage | TC Code | Cap.   | Tol.   | Part Number        |                    |                    |                    |
|--------|---------------|---------|--------|--------|--------------------|--------------------|--------------------|--------------------|
| 0.33mm | 25Vdc         | X7R     | 100pF  | ±10%   | GMD033R71E101KA01# |                    |                    |                    |
|        |               |         | 120pF  | ±10%   | GMD033R71E121KA01# |                    |                    |                    |
|        |               |         | 150pF  | ±10%   | GMD033R71E151KA01# |                    |                    |                    |
|        |               |         | 180pF  | ±10%   | GMD033R71E181KA01# |                    |                    |                    |
|        |               |         | 220pF  | ±10%   | GMD033R71E221KA01# |                    |                    |                    |
|        |               |         | 270pF  | ±10%   | GMD033R71E271KA01# |                    |                    |                    |
|        |               |         | 330pF  | ±10%   | GMD033R71E331KA01# |                    |                    |                    |
|        |               |         | 390pF  | ±10%   | GMD033R71E391KA01# |                    |                    |                    |
|        |               |         | 470pF  | ±10%   | GMD033R71E471KA01# |                    |                    |                    |
|        |               |         | 560pF  | ±10%   | GMD033R71E561KA01# |                    |                    |                    |
|        |               |         | 680pF  | ±10%   | GMD033R71E681KA01# |                    |                    |                    |
|        |               |         | 820pF  | ±10%   | GMD033R71E821KA01# |                    |                    |                    |
|        |               |         | 1000pF | ±10%   | GMD033R71E102KA01# |                    |                    |                    |
|        |               |         | 1200pF | ±10%   | GMD033R71E122KA01# |                    |                    |                    |
|        |               |         | 1500pF | ±10%   | GMD033R71E152KA01# |                    |                    |                    |
|        |               |         | R      | 100pF  | ±10%               | GMD033R11E101KA01# |                    |                    |
|        |               |         |        | 120pF  | ±10%               | GMD033R11E121KA01# |                    |                    |
|        |               |         |        | 150pF  | ±10%               | GMD033R11E151KA01# |                    |                    |
|        |               |         |        | 180pF  | ±10%               | GMD033R11E181KA01# |                    |                    |
|        |               |         |        | 220pF  | ±10%               | GMD033R11E221KA01# |                    |                    |
|        |               |         |        | 270pF  | ±10%               | GMD033R11E271KA01# |                    |                    |
|        |               |         |        | 330pF  | ±10%               | GMD033R11E331KA01# |                    |                    |
|        |               |         |        | 390pF  | ±10%               | GMD033R11E391KA01# |                    |                    |
|        |               |         |        | 470pF  | ±10%               | GMD033R11E471KA01# |                    |                    |
|        |               |         |        | 560pF  | ±10%               | GMD033R11E561KA01# |                    |                    |
|        |               |         |        | 680pF  | ±10%               | GMD033R11E681KA01# |                    |                    |
|        |               |         |        | 820pF  | ±10%               | GMD033R11E821KA01# |                    |                    |
|        |               |         |        | 1000pF | ±10%               | GMD033R11E102KA01# |                    |                    |
|        |               |         |        | 1200pF | ±10%               | GMD033R11E122KA01# |                    |                    |
|        |               |         |        | 1500pF | ±10%               | GMD033R11E152KA01# |                    |                    |
|        |               | B       |        | 100pF  | ±10%               | GMD033B11E101KA01# |                    |                    |
|        |               |         |        | 120pF  | ±10%               | GMD033B11E121KA01# |                    |                    |
|        |               |         |        | 150pF  | ±10%               | GMD033B11E151KA01# |                    |                    |
|        |               |         |        | 180pF  | ±10%               | GMD033B11E181KA01# |                    |                    |
|        |               |         |        | 220pF  | ±10%               | GMD033B11E221KA01# |                    |                    |
|        |               |         |        | 270pF  | ±10%               | GMD033B11E271KA01# |                    |                    |
|        |               |         |        | 330pF  | ±10%               | GMD033B11E331KA01# |                    |                    |
|        |               |         |        | 390pF  | ±10%               | GMD033B11E391KA01# |                    |                    |
|        |               |         |        | 470pF  | ±10%               | GMD033B11E471KA01# |                    |                    |
|        |               |         |        | 560pF  | ±10%               | GMD033B11E561KA01# |                    |                    |
|        |               |         |        | 680pF  | ±10%               | GMD033B11E681KA01# |                    |                    |
|        |               |         |        | 820pF  | ±10%               | GMD033B11E821KA01# |                    |                    |
|        |               |         |        | 1000pF | ±10%               | GMD033B11E102KA01# |                    |                    |
|        |               |         |        | 1200pF | ±10%               | GMD033B11E122KA01# |                    |                    |
|        |               |         |        | 1500pF | ±10%               | GMD033B11E152KA01# |                    |                    |
|        |               |         | 16Vdc  | X7R    | 1800pF             | ±10%               | GMD033R71C182KA11# |                    |
|        |               |         |        |        | 2200pF             | ±10%               | GMD033R71C222KA11# |                    |
|        |               |         |        |        | 2700pF             | ±10%               | GMD033R71C272KA11# |                    |
|        |               |         |        |        | 3300pF             | ±10%               | GMD033R71C332KA11# |                    |
|        |               |         |        |        | R                  | 1800pF             | ±10%               | GMD033R11C182KA11# |
|        |               |         |        |        |                    | 2200pF             | ±10%               | GMD033R11C222KA11# |
|        |               |         |        | 2700pF |                    | ±10%               | GMD033R11C272KA11# |                    |

| T max. | Rated Voltage | TC Code            | Cap.               | Tol.               | Part Number        |                    |
|--------|---------------|--------------------|--------------------|--------------------|--------------------|--------------------|
| 0.33mm | 16Vdc         | R                  | 3300pF             | ±10%               | GMD033R11C332KA11# |                    |
|        |               |                    | B                  | 1800pF             | ±10%               | GMD033B31C182KA11# |
|        |               |                    | 2200pF             | ±10%               | GMD033B31C222KA11# |                    |
|        |               |                    | 2700pF             | ±10%               | GMD033B31C272KA11# |                    |
|        |               | 3300pF             | ±10%               | GMD033B31C332KA11# |                    |                    |
|        |               | 10Vdc              | X7R                | 3900pF             | ±10%               | GMD033R71A392KA01# |
|        |               |                    |                    | 4700pF             | ±10%               | GMD033R71A472KA01# |
|        |               |                    |                    | 5600pF             | ±10%               | GMD033R71A562KA01# |
|        |               |                    |                    | 6800pF             | ±10%               | GMD033R71A682KA01# |
|        |               |                    |                    | 8200pF             | ±10%               | GMD033R71A822KA01# |
|        |               |                    |                    | 10000pF            | ±10%               | GMD033R71A103KA01# |
|        |               |                    |                    | R                  | 3900pF             | ±10%               |
|        | 4700pF        |                    |                    |                    | ±10%               | GMD033R11A472KA01# |
|        | 5600pF        |                    |                    |                    | ±10%               | GMD033R11A562KA01# |
|        | 6800pF        |                    | ±10%               |                    | GMD033R11A682KA01# |                    |
|        | 8200pF        |                    | ±10%               |                    | GMD033R11A822KA01# |                    |
|        | 10000pF       |                    | ±10%               |                    | GMD033R11A103KA01# |                    |
|        | B             |                    | 3900pF             |                    | ±10%               | GMD033B11A392KA01# |
|        |               |                    | 4700pF             |                    | ±10%               | GMD033B11A472KA01# |
|        |               |                    | 5600pF             |                    | ±10%               | GMD033B11A562KA01# |
|        |               |                    | 6800pF             | ±10%               | GMD033B11A682KA01# |                    |
|        |               |                    | 8200pF             | ±10%               | GMD033B11A822KA01# |                    |
|        |               |                    | 10000pF            | ±10%               | GMD033B11A103KA01# |                    |
|        |               | 6.3Vdc             | X5R                | 56000pF            | ±10%               | GMD033R60J563KE11# |
|        |               |                    |                    | 68000pF            | ±10%               | GMD033R60J683KE11# |
|        |               |                    |                    | 82000pF            | ±10%               | GMD033R60J823KE11# |
|        | B             |                    | 0.10μF             | ±10%               | GMD033R60J104KE11# |                    |
|        |               |                    | 56000pF            | ±10%               | GMD033B30J563KE11# |                    |
|        |               |                    | 68000pF            | ±10%               | GMD033B30J683KE11# |                    |
|        | 82000pF       | ±10%               | GMD033B30J823KE11# |                    |                    |                    |
| 0.10μF | ±10%          | GMD033B30J104KE11# |                    |                    |                    |                    |

## 1.0x0.5mm

| T max. | Rated Voltage | TC Code | Cap.   | Tol.  | Part Number        |                    |
|--------|---------------|---------|--------|-------|--------------------|--------------------|
| 0.55mm | 50Vdc         | X7R     | 220pF  | ±10%  | GMD155R71H221KA01# |                    |
|        |               |         | 270pF  | ±10%  | GMD155R71H271KA01# |                    |
|        |               |         | 330pF  | ±10%  | GMD155R71H331KA01# |                    |
|        |               |         | 390pF  | ±10%  | GMD155R71H391KA01# |                    |
|        |               |         | 470pF  | ±10%  | GMD155R71H471KA01# |                    |
|        |               |         | 560pF  | ±10%  | GMD155R71H561KA01# |                    |
|        |               |         | 680pF  | ±10%  | GMD155R71H681KA01# |                    |
|        |               |         | 820pF  | ±10%  | GMD155R71H821KA01# |                    |
|        |               |         | 1000pF | ±10%  | GMD155R71H102KA01# |                    |
|        |               |         | 1200pF | ±10%  | GMD155R71H122KA01# |                    |
|        |               |         | 1500pF | ±10%  | GMD155R71H152KA01# |                    |
|        |               |         | 1800pF | ±10%  | GMD155R71H182KA01# |                    |
|        |               |         | 2200pF | ±10%  | GMD155R71H222KA01# |                    |
|        |               |         | 2700pF | ±10%  | GMD155R71H272KA01# |                    |
|        |               |         | 3300pF | ±10%  | GMD155R71H332KA01# |                    |
|        |               |         | 3900pF | ±10%  | GMD155R71H392KA01# |                    |
|        |               |         | 4700pF | ±10%  | GMD155R71H472KA01# |                    |
|        |               |         | R      | 220pF | ±10%               | GMD155R11H221KA01# |

Part number # indicates the package specification code.

- GRM Series
- GJM Series
- GMA Series
- GMD Series
- GQM Series
- GRJ Series
- GR3 Series
- KRM Series
- KR3 Series
- LLA Series
- LLL Series
- LLM Series
- LLR Series
- ⚠Caution/Notice

## GMD Series High Dielectric Constant Type Part Number List

(→ ■ 1.0x0.5mm)

| T max.  | Rated Voltage | TC Code | Cap.               | Tol.               | Part Number        |                    |
|---------|---------------|---------|--------------------|--------------------|--------------------|--------------------|
| 0.55mm  | 50Vdc         | R       | 270pF              | ±10%               | GMD155R11H271KA01# |                    |
|         |               |         | 330pF              | ±10%               | GMD155R11H331KA01# |                    |
|         |               |         | 390pF              | ±10%               | GMD155R11H391KA01# |                    |
|         |               |         | 470pF              | ±10%               | GMD155R11H471KA01# |                    |
|         |               |         | 560pF              | ±10%               | GMD155R11H561KA01# |                    |
|         |               |         | 680pF              | ±10%               | GMD155R11H681KA01# |                    |
|         |               |         | 820pF              | ±10%               | GMD155R11H821KA01# |                    |
|         |               |         | 1000pF             | ±10%               | GMD155R11H102KA01# |                    |
|         |               |         | 1200pF             | ±10%               | GMD155R11H122KA01# |                    |
|         |               |         | 1500pF             | ±10%               | GMD155R11H152KA01# |                    |
|         |               |         | 1800pF             | ±10%               | GMD155R11H182KA01# |                    |
|         |               |         | 2200pF             | ±10%               | GMD155R11H222KA01# |                    |
|         |               |         | 2700pF             | ±10%               | GMD155R11H272KA01# |                    |
|         |               |         | 3300pF             | ±10%               | GMD155R11H332KA01# |                    |
|         |               | 3900pF  | ±10%               | GMD155R11H392KA01# |                    |                    |
|         |               | 4700pF  | ±10%               | GMD155R11H472KA01# |                    |                    |
|         |               | B       | 220pF              | ±10%               | GMD155B11H221KA01# |                    |
|         |               |         | 270pF              | ±10%               | GMD155B11H271KA01# |                    |
|         |               |         | 330pF              | ±10%               | GMD155B11H331KA01# |                    |
|         |               |         | 390pF              | ±10%               | GMD155B11H391KA01# |                    |
|         |               |         | 470pF              | ±10%               | GMD155B11H471KA01# |                    |
|         |               |         | 560pF              | ±10%               | GMD155B11H561KA01# |                    |
|         |               |         | 680pF              | ±10%               | GMD155B11H681KA01# |                    |
|         |               |         | 820pF              | ±10%               | GMD155B11H821KA01# |                    |
|         |               |         | 1000pF             | ±10%               | GMD155B11H102KA01# |                    |
|         |               |         | 1200pF             | ±10%               | GMD155B11H122KA01# |                    |
|         |               |         | 1500pF             | ±10%               | GMD155B11H152KA01# |                    |
|         |               |         | 1800pF             | ±10%               | GMD155B11H182KA01# |                    |
|         | 2200pF        |         | ±10%               | GMD155B11H222KA01# |                    |                    |
|         | 2700pF        | ±10%    | GMD155B11H272KA01# |                    |                    |                    |
|         | 3300pF        | ±10%    | GMD155B11H332KA01# |                    |                    |                    |
|         | 3900pF        | ±10%    | GMD155B11H392KA01# |                    |                    |                    |
|         | 4700pF        | ±10%    | GMD155B11H472KA01# |                    |                    |                    |
|         | 25Vdc         | X7R     | 5600pF             | ±10%               | GMD155R71E562KA01# |                    |
|         |               |         | 6800pF             | ±10%               | GMD155R71E682KA01# |                    |
|         |               |         | 8200pF             | ±10%               | GMD155R71E822KA01# |                    |
|         |               |         | 10000pF            | ±10%               | GMD155R71E103KA01# |                    |
|         |               |         | 12000pF            | ±10%               | GMD155R71E123KA01# |                    |
|         |               |         | 15000pF            | ±10%               | GMD155R71E153KA01# |                    |
|         |               |         | 18000pF            | ±10%               | GMD155R71E183KA01# |                    |
|         |               |         | 22000pF            | ±10%               | GMD155R71E223KA01# |                    |
|         |               |         | 27000pF            | ±10%               | GMD155R71E273KA11# |                    |
|         |               |         | 33000pF            | ±10%               | GMD155R71E333KA11# |                    |
|         |               |         | 39000pF            | ±10%               | GMD155R71E393KA11# |                    |
|         |               |         | 47000pF            | ±10%               | GMD155R71E473KA11# |                    |
|         |               |         | R                  | 5600pF             | ±10%               | GMD155R11E562KA01# |
|         |               |         |                    | 6800pF             | ±10%               | GMD155R11E682KA01# |
| 8200pF  |               | ±10%    |                    | GMD155R11E822KA01# |                    |                    |
| 10000pF |               | ±10%    |                    | GMD155R11E103KA01# |                    |                    |
| 12000pF |               | ±10%    |                    | GMD155R11E123KA01# |                    |                    |
| 15000pF |               | ±10%    |                    | GMD155R11E153KA01# |                    |                    |
| 18000pF |               | ±10%    |                    | GMD155R11E183KA01# |                    |                    |
| 22000pF |               | ±10%    |                    | GMD155R11E223KA01# |                    |                    |
| 27000pF |               | ±10%    |                    | GMD155R11E273KA11# |                    |                    |

| T max. | Rated Voltage | TC Code | Cap.               | Tol.               | Part Number        |                    |
|--------|---------------|---------|--------------------|--------------------|--------------------|--------------------|
| 0.55mm | 25Vdc         | R       | 3300pF             | ±10%               | GMD155R11E333KA11# |                    |
|        |               |         | 3900pF             | ±10%               | GMD155R11E393KA11# |                    |
|        |               |         | 4700pF             | ±10%               | GMD155R11E473KA11# |                    |
|        |               |         | B                  | 5600pF             | ±10%               | GMD155B11E562KA01# |
|        |               | 6800pF  |                    | ±10%               | GMD155B11E682KA01# |                    |
|        |               | 8200pF  |                    | ±10%               | GMD155B11E822KA01# |                    |
|        |               | 10000pF |                    | ±10%               | GMD155B11E103KA01# |                    |
|        |               | 12000pF |                    | ±10%               | GMD155B11E123KA01# |                    |
|        |               | 15000pF |                    | ±10%               | GMD155B11E153KA01# |                    |
|        |               | 18000pF |                    | ±10%               | GMD155B11E183KA01# |                    |
|        |               | 22000pF |                    | ±10%               | GMD155B11E223KA01# |                    |
|        |               | 27000pF |                    | ±10%               | GMD155B31E273KA11# |                    |
|        |               | 33000pF |                    | ±10%               | GMD155B31E333KA11# |                    |
|        |               | 39000pF | ±10%               | GMD155B31E393KA11# |                    |                    |
|        | 47000pF       | ±10%    | GMD155B31E473KA11# |                    |                    |                    |
|        | 16Vdc         | X7R     | 5600pF             | ±10%               | GMD155R71C563KA11# |                    |
|        |               |         | 6800pF             | ±10%               | GMD155R71C683KA11# |                    |
|        |               |         | 8200pF             | ±10%               | GMD155R71C823KA11# |                    |
|        |               |         | 0.10μF             | ±10%               | GMD155R71C104KA11# |                    |
|        |               | R       | 56000pF            | ±10%               | GMD155R11C563KA11# |                    |
|        |               |         | 68000pF            | ±10%               | GMD155R11C683KA11# |                    |
|        |               |         | 82000pF            | ±10%               | GMD155R11C823KA11# |                    |
|        |               |         | 0.10μF             | ±10%               | GMD155R11C104KA11# |                    |
|        |               |         | B                  | 56000pF            | ±10%               | GMD155B31C563KA11# |
|        |               | 68000pF |                    | ±10%               | GMD155B31C683KA11# |                    |
|        |               | 82000pF |                    | ±10%               | GMD155B31C823KA11# |                    |
|        |               | 0.10μF  |                    | ±10%               | GMD155B31C104KA11# |                    |
|        |               | 10Vdc   | X5R                | 0.12μF             | ±10%               | GMD155R61A124KE12# |
|        | 0.15μF        |         |                    | ±10%               | GMD155R61A154KE12# |                    |
|        | 0.18μF        |         |                    | ±10%               | GMD155R61A184KE12# |                    |
|        | 0.22μF        |         |                    | ±10%               | GMD155R61A224KE12# |                    |
|        | 0.27μF        |         |                    | ±10%               | GMD155R61A274KE11# |                    |
|        | 0.33μF        |         |                    | ±10%               | GMD155R61A334KE11# |                    |
|        | 0.39μF        |         |                    | ±10%               | GMD155R61A394KE11# |                    |
|        | 0.47μF        |         |                    | ±10%               | GMD155R61A474KE11# |                    |
|        | B             |         |                    | 0.12μF             | ±10%               | GMD155B31A124KE12# |
|        |               |         |                    | 0.15μF             | ±10%               | GMD155B31A154KE12# |
|        | 0.18μF        | ±10%    | GMD155B31A184KE12# |                    |                    |                    |
|        | 0.22μF        | ±10%    | GMD155B31A224KE12# |                    |                    |                    |
|        | 0.27μF        | ±10%    | GMD155B31A274KE11# |                    |                    |                    |
|        | 0.33μF        | ±10%    | GMD155B31A334KE11# |                    |                    |                    |
|        | 0.39μF        | ±10%    | GMD155B31A394KE11# |                    |                    |                    |
|        | 0.47μF        | ±10%    | GMD155B31A474KE11# |                    |                    |                    |

Part number # indicates the package specification code.

GRM Series  
GJM Series  
GMA Series  
GMD Series  
GQM Series  
GRJ Series  
GR3 Series  
KRM Series  
KR3 Series  
LLA Series  
LLL Series  
LLM Series  
LLR Series  
⚠Caution/Notice

GRM Series  
 GJM Series  
 GMA Series  
 GMD Series  
**GQM Series**  
 GRJ Series  
 GR3 Series  
 KRM Series  
 KR3 Series  
 LLA Series  
 LLL Series  
 LLM Series  
 LLR Series  
 ⚠Caution/  
 Notice

High Frequency High Q Type 1608(in mm)/0603(in inch) Size Min.

# GQM Series



## High Frequency Capacitor Ideal for PA Design of Base Stations

### Features

- 1 **Mainly ideal for base stations of mobile communication devices and temperature compensation of related modules.**

This product is ideal for temperature compensation of high frequency circuits, such as resonant circuits, tuning circuits, and impedance matching circuits where the operating characteristics of the device are greatly affected by the capacitance fluctuation.

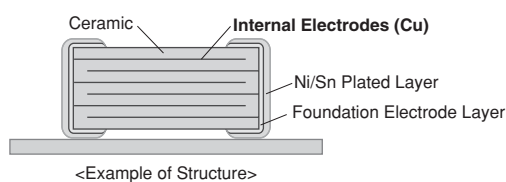

- 2 **High Q and low ESR in VHF, UHF and microwave frequency bands.**

High Q and low ESR were achieved at a high frequency by adopting ceramic material as the dielectric material which enables an extremely low loss at high frequency, and base metal electrodes as the internal electrodes.

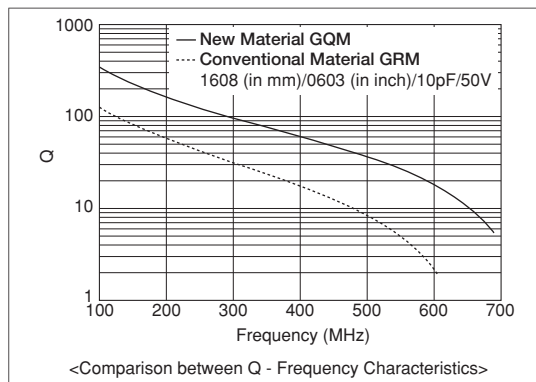
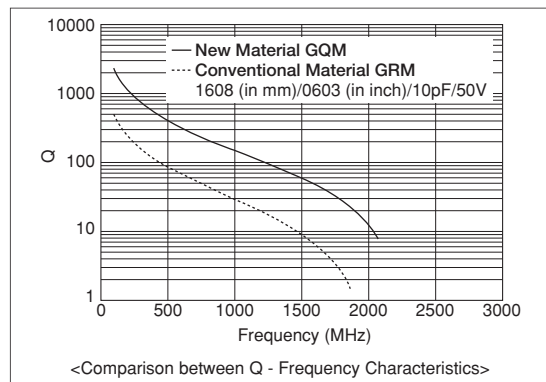

- 3 **Can be used for tight tolerance.**

In addition to standard tolerance, the allowable range of this product is also suitable for the following narrow tolerance.

| Capacitance Range | Standard Capacitance Tolerance<br>(Capacitance Tolerance Symbol) | Narrow Capacitance Tolerance<br>(Capacitance Tolerance Symbol) |
|-------------------|--|--|
| ≤0.9pF            | ±0.1pF (B)   | ±0.05pF (W)  |
| 1.0 to 5.0pF      | ±0.25pF (C)  | ±0.05pF (W), ±0.1pF (B)  |
| 5.1 to 9.9pF      | ±0.5pF (D)   | ±0.05pF (W), ±0.1pF (B), ±0.25pF (C)                           |
| ≥10pF             | ±5% (J)  | ±2% (G)  |

### Specifications

|                   |                            |
|-------------------|----------------------------|
| Size              | 1.0×0.5mm to 2.8×2.8mm     |
| Rated Voltage     | DC50V to 500V              |
| Capacitance       | 0.1pF to 200pF             |
| Main Applications | Mobile phone base stations |

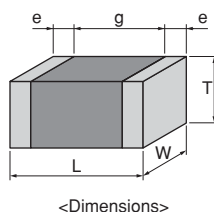

This catalog contains only a portion of the product lineup.  
 Please refer to the capacitor search tool on the Murata Web site for details.

# GQM Series Temperature Compensating Type High Q Part Number List

## ■ 1.6×0.8mm

| T max. | Rated Voltage | TC Code | Cap.  | Tol.    | Part Number        |
|--------|---------------|---------|-------|---------|--------------------|
| 0.8mm  | 250Vdc        | C0G     | 1.0pF | ±0.1pF  | GQM1875C2E1R0BB12# |
|        |               |         |       | ±0.25pF | GQM1875C2E1R0CB12# |
|        |               |         | 1.1pF | ±0.1pF  | GQM1875C2E1R1BB12# |
|        |               |         |       | ±0.25pF | GQM1875C2E1R1CB12# |
|        |               |         | 1.2pF | ±0.1pF  | GQM1875C2E1R2BB12# |
|        |               |         |       | ±0.25pF | GQM1875C2E1R2CB12# |
|        |               |         | 1.3pF | ±0.1pF  | GQM1875C2E1R3BB12# |
|        |               |         |       | ±0.25pF | GQM1875C2E1R3CB12# |
|        |               |         | 1.5pF | ±0.1pF  | GQM1875C2E1R5BB12# |
|        |               |         |       | ±0.25pF | GQM1875C2E1R5CB12# |
|        |               |         | 1.6pF | ±0.1pF  | GQM1875C2E1R6BB12# |
|        |               |         |       | ±0.25pF | GQM1875C2E1R6CB12# |
|        |               |         | 1.8pF | ±0.1pF  | GQM1875C2E1R8BB12# |
|        |               |         |       | ±0.25pF | GQM1875C2E1R8CB12# |
|        |               |         | 2.0pF | ±0.1pF  | GQM1875C2E2R0BB12# |
|        |               |         |       | ±0.25pF | GQM1875C2E2R0CB12# |
|        |               |         | 2.2pF | ±0.1pF  | GQM1875C2E2R2BB12# |
|        |               |         |       | ±0.25pF | GQM1875C2E2R2CB12# |
|        |               |         | 2.4pF | ±0.1pF  | GQM1875C2E2R4BB12# |
|        |               |         |       | ±0.25pF | GQM1875C2E2R4CB12# |
|        |               |         | 2.7pF | ±0.1pF  | GQM1875C2E2R7BB12# |
|        |               |         |       | ±0.25pF | GQM1875C2E2R7CB12# |
|        |               |         | 3.0pF | ±0.1pF  | GQM1875C2E3R0BB12# |
|        |               |         |       | ±0.25pF | GQM1875C2E3R0CB12# |
|        |               |         | 3.3pF | ±0.1pF  | GQM1875C2E3R3BB12# |
|        |               |         |       | ±0.25pF | GQM1875C2E3R3CB12# |
|        |               |         | 3.6pF | ±0.1pF  | GQM1875C2E3R6BB12# |
|        |               |         |       | ±0.25pF | GQM1875C2E3R6CB12# |
|        |               |         | 3.9pF | ±0.1pF  | GQM1875C2E3R9BB12# |
|        |               |         |       | ±0.25pF | GQM1875C2E3R9CB12# |
|        |               |         | 4.0pF | ±0.1pF  | GQM1875C2E4R0BB12# |
|        |               |         |       | ±0.25pF | GQM1875C2E4R0CB12# |
|        |               |         | 4.3pF | ±0.1pF  | GQM1875C2E4R3BB12# |
|        |               |         |       | ±0.25pF | GQM1875C2E4R3CB12# |
|        |               |         | 4.7pF | ±0.1pF  | GQM1875C2E4R7BB12# |
|        |               |         |       | ±0.25pF | GQM1875C2E4R7CB12# |
|        |               |         | 5.0pF | ±0.1pF  | GQM1875C2E5R0BB12# |
|        |               |         |       | ±0.25pF | GQM1875C2E5R0CB12# |
|        |               |         | 5.1pF | ±0.25pF | GQM1875C2E5R1CB12# |
|        |               |         |       | ±0.5pF  | GQM1875C2E5R1DB12# |
|        |               |         | 5.6pF | ±0.25pF | GQM1875C2E5R6CB12# |
|        |               |         |       | ±0.5pF  | GQM1875C2E5R6DB12# |
|        |               |         | 6.0pF | ±0.25pF | GQM1875C2E6R0CB12# |
|        |               |         |       | ±0.5pF  | GQM1875C2E6R0DB12# |
|        |               |         | 6.2pF | ±0.25pF | GQM1875C2E6R2CB12# |
|        |               |         |       | ±0.5pF  | GQM1875C2E6R2DB12# |
|        |               |         | 6.8pF | ±0.25pF | GQM1875C2E6R8CB12# |
|        |               |         |       | ±0.5pF  | GQM1875C2E6R8DB12# |
|        |               |         | 7.0pF | ±0.25pF | GQM1875C2E7R0CB12# |
|        |               |         |       | ±0.5pF  | GQM1875C2E7R0DB12# |
|        |               |         | 7.5pF | ±0.25pF | GQM1875C2E7R5CB12# |
|        |               |         |       | ±0.5pF  | GQM1875C2E7R5DB12# |

| T max. | Rated Voltage | TC Code            | Cap.  | Tol.    | Part Number        |
|--------|---------------|--------------------|-------|---------|--------------------|
| 0.8mm  | 250Vdc        | C0G                | 8.0pF | ±0.25pF | GQM1875C2E8R0CB12# |
|        |               |                    |       | ±0.5pF  | GQM1875C2E8R0DB12# |
|        |               |                    | 8.2pF | ±0.25pF | GQM1875C2E8R2CB12# |
|        |               |                    |       | ±0.5pF  | GQM1875C2E8R2DB12# |
|        |               |                    | 9.0pF | ±0.25pF | GQM1875C2E9R0CB12# |
|        |               |                    |       | ±0.5pF  | GQM1875C2E9R0DB12# |
|        |               |                    | 9.1pF | ±0.25pF | GQM1875C2E9R1CB12# |
|        |               |                    |       | ±0.5pF  | GQM1875C2E9R1DB12# |
|        |               |                    | 10pF  | ±2%     | GQM1875C2E100GB12# |
|        |               |                    |       | ±5%     | GQM1875C2E100JB12# |
|        |               |                    | 11pF  | ±2%     | GQM1875C2E110GB12# |
|        |               |                    |       | ±5%     | GQM1875C2E110JB12# |
|        |               |                    | 12pF  | ±2%     | GQM1875C2E120GB12# |
|        |               |                    |       | ±5%     | GQM1875C2E120JB12# |
|        |               |                    | 13pF  | ±2%     | GQM1875C2E130GB12# |
|        |               |                    |       | ±5%     | GQM1875C2E130JB12# |
|        |               |                    | 15pF  | ±2%     | GQM1875C2E150GB12# |
|        |               |                    |       | ±5%     | GQM1875C2E150JB12# |
|        |               |                    | 16pF  | ±2%     | GQM1875C2E160GB12# |
|        |               |                    |       | ±5%     | GQM1875C2E160JB12# |
|        |               |                    | 18pF  | ±2%     | GQM1875C2E180GB12# |
|        |               |                    |       | ±5%     | GQM1875C2E180JB12# |
|        |               |                    | 20pF  | ±2%     | GQM1875C2E200GB12# |
|        |               |                    |       | ±5%     | GQM1875C2E200JB12# |
| 22pF   | ±2%           | GQM1875C2E220GB12# |       |         |                    |
|        | ±5%           | GQM1875C2E220JB12# |       |         |                    |
| 24pF   | ±2%           | GQM1875C2E240GB12# |       |         |                    |
|        | ±5%           | GQM1875C2E240JB12# |       |         |                    |
| 27pF   | ±2%           | GQM1875C2E270GB12# |       |         |                    |
|        | ±5%           | GQM1875C2E270JB12# |       |         |                    |
| 30pF   | ±2%           | GQM1875C2E300GB12# |       |         |                    |
|        | ±5%           | GQM1875C2E300JB12# |       |         |                    |
| 33pF   | ±2%           | GQM1875C2E330GB12# |       |         |                    |
|        | ±5%           | GQM1875C2E330JB12# |       |         |                    |
| 36pF   | ±2%           | GQM1875C2E360GB12# |       |         |                    |
|        | ±5%           | GQM1875C2E360JB12# |       |         |                    |
| 39pF   | ±2%           | GQM1875C2E390GB12# |       |         |                    |
|        | ±5%           | GQM1875C2E390JB12# |       |         |                    |
| 43pF   | ±2%           | GQM1875C2E430GB12# |       |         |                    |
|        | ±5%           | GQM1875C2E430JB12# |       |         |                    |
| 47pF   | ±2%           | GQM1875C2E470GB12# |       |         |                    |
|        | ±5%           | GQM1875C2E470JB12# |       |         |                    |
| 0.9mm  | 100Vdc        | C0G                | 1.0pF | ±0.1pF  | GQM1885C2A1R0BB01# |
|        |               |                    |       | ±0.25pF | GQM1885C2A1R0CB01# |
|        |               |                    | 1.1pF | ±0.1pF  | GQM1885C2A1R1BB01# |
|        |               |                    |       | ±0.25pF | GQM1885C2A1R1CB01# |
|        |               |                    | 1.2pF | ±0.1pF  | GQM1885C2A1R2BB01# |
|        |               |                    |       | ±0.25pF | GQM1885C2A1R2CB01# |
|        |               |                    | 1.3pF | ±0.1pF  | GQM1885C2A1R3BB01# |
|        |               |                    |       | ±0.25pF | GQM1885C2A1R3CB01# |
|        |               |                    | 1.5pF | ±0.1pF  | GQM1885C2A1R5BB01# |
|        |               |                    |       | ±0.25pF | GQM1885C2A1R5CB01# |
|        |               |                    | 1.6pF | ±0.1pF  | GQM1885C2A1R6BB01# |
|        |               |                    |       | ±0.25pF | GQM1885C2A1R6CB01# |

Part number # indicates the package specification code.

GRM Series  
 GJM Series  
 GMA Series  
 GMD Series  
 GQM Series  
 GRJ Series  
 GR3 Series  
 KRM Series  
 KR3 Series  
 LLA Series  
 LLL Series  
 LLM Series  
 LLR Series  
 ⚠Caution/ Notice

# GQM Series Temperature Compensating Type High Q Part Number List

(→ ■ 1.6x0.8mm)

| T max. | Rated Voltage | TC Code | Cap.    | Tol.               | Part Number        |
|--------|---------------|---------|---------|--------------------|--------------------|
| 0.9mm  | 100Vdc        | C0G     | 1.8pF   | ±0.1pF             | GQM1885C2A1R8BB01# |
|        |               |         |         | ±0.25pF            | GQM1885C2A1R8CB01# |
|        |               |         | 2.0pF   | ±0.1pF             | GQM1885C2A2R0BB01# |
|        |               |         |         | ±0.25pF            | GQM1885C2A2R0CB01# |
|        |               |         | 2.2pF   | ±0.1pF             | GQM1885C2A2R2BB01# |
|        |               |         |         | ±0.25pF            | GQM1885C2A2R2CB01# |
|        |               |         | 2.4pF   | ±0.1pF             | GQM1885C2A2R4BB01# |
|        |               |         |         | ±0.25pF            | GQM1885C2A2R4CB01# |
|        |               |         | 2.7pF   | ±0.1pF             | GQM1885C2A2R7BB01# |
|        |               |         |         | ±0.25pF            | GQM1885C2A2R7CB01# |
|        |               |         | 3.0pF   | ±0.1pF             | GQM1885C2A3R0BB01# |
|        |               |         |         | ±0.25pF            | GQM1885C2A3R0CB01# |
|        |               |         | 3.3pF   | ±0.1pF             | GQM1885C2A3R3BB01# |
|        |               |         |         | ±0.25pF            | GQM1885C2A3R3CB01# |
|        |               |         | 3.6pF   | ±0.1pF             | GQM1885C2A3R6BB01# |
|        |               |         |         | ±0.25pF            | GQM1885C2A3R6CB01# |
|        |               |         | 3.9pF   | ±0.1pF             | GQM1885C2A3R9BB01# |
|        |               |         |         | ±0.25pF            | GQM1885C2A3R9CB01# |
|        |               |         | 4.0pF   | ±0.1pF             | GQM1885C2A4R0BB01# |
|        |               |         |         | ±0.25pF            | GQM1885C2A4R0CB01# |
|        |               |         | 4.3pF   | ±0.1pF             | GQM1885C2A4R3BB01# |
|        |               |         |         | ±0.25pF            | GQM1885C2A4R3CB01# |
|        |               |         | 4.7pF   | ±0.1pF             | GQM1885C2A4R7BB01# |
|        |               |         |         | ±0.25pF            | GQM1885C2A4R7CB01# |
|        |               |         | 5.0pF   | ±0.1pF             | GQM1885C2A5R0BB01# |
|        |               |         |         | ±0.25pF            | GQM1885C2A5R0CB01# |
|        |               |         | 5.1pF   | ±0.25pF            | GQM1885C2A5R1CB01# |
|        |               |         |         | ±0.5pF             | GQM1885C2A5R1DB01# |
|        |               |         | 5.6pF   | ±0.25pF            | GQM1885C2A5R6CB01# |
|        |               |         |         | ±0.5pF             | GQM1885C2A5R6DB01# |
|        |               | 6.0pF   | ±0.25pF | GQM1885C2A6R0CB01# |                    |
|        |               |         | ±0.5pF  | GQM1885C2A6R0DB01# |                    |
|        |               | 6.2pF   | ±0.25pF | GQM1885C2A6R2CB01# |                    |
|        |               |         | ±0.5pF  | GQM1885C2A6R2DB01# |                    |
|        |               | 6.8pF   | ±0.25pF | GQM1885C2A6R8CB01# |                    |
|        |               |         | ±0.5pF  | GQM1885C2A6R8DB01# |                    |
|        |               | CK      | 1.0pF   | ±0.1pF             | GQM1884C2A1R0BB01# |
|        |               |         |         | ±0.25pF            | GQM1884C2A1R0CB01# |
|        |               |         | 1.1pF   | ±0.1pF             | GQM1884C2A1R1BB01# |
|        |               |         |         | ±0.25pF            | GQM1884C2A1R1CB01# |
|        |               |         | 1.2pF   | ±0.1pF             | GQM1884C2A1R2BB01# |
|        |               |         |         | ±0.25pF            | GQM1884C2A1R2CB01# |
|        |               |         | 1.3pF   | ±0.1pF             | GQM1884C2A1R3BB01# |
|        |               |         |         | ±0.25pF            | GQM1884C2A1R3CB01# |
|        |               |         | 1.5pF   | ±0.1pF             | GQM1884C2A1R5BB01# |
|        |               |         |         | ±0.25pF            | GQM1884C2A1R5CB01# |
|        |               |         | 1.6pF   | ±0.1pF             | GQM1884C2A1R6BB01# |
|        |               |         |         | ±0.25pF            | GQM1884C2A1R6CB01# |
|        |               | 1.8pF   | ±0.1pF  | GQM1884C2A1R8BB01# |                    |
|        |               |         | ±0.25pF | GQM1884C2A1R8CB01# |                    |
|        |               | 2.0pF   | ±0.1pF  | GQM1884C2A2R0BB01# |                    |
|        |               |         | ±0.25pF | GQM1884C2A2R0CB01# |                    |
|        |               | CJ      | 2.2pF   | ±0.1pF             | GQM1883C2A2R2BB01# |
|        |               |         |         | ±0.25pF            | GQM1883C2A2R2CB01# |

| T max. | Rated Voltage | TC Code | Cap.  | Tol.               | Part Number        |                    |
|--------|---------------|---------|-------|--------------------|--------------------|--------------------|
| 0.9mm  | 100Vdc        | CJ      | 2.4pF | ±0.1pF             | GQM1883C2A2R4BB01# |                    |
|        |               |         |       | ±0.25pF            | GQM1883C2A2R4CB01# |                    |
|        |               |         | 2.7pF | ±0.1pF             | GQM1883C2A2R7BB01# |                    |
|        |               |         |       | ±0.25pF            | GQM1883C2A2R7CB01# |                    |
|        |               |         | 3.0pF | ±0.1pF             | GQM1883C2A3R0BB01# |                    |
|        |               |         |       | ±0.25pF            | GQM1883C2A3R0CB01# |                    |
|        |               |         | 3.3pF | ±0.1pF             | GQM1883C2A3R3BB01# |                    |
|        |               |         |       | ±0.25pF            | GQM1883C2A3R3CB01# |                    |
|        |               |         | 3.6pF | ±0.1pF             | GQM1883C2A3R6BB01# |                    |
|        |               |         |       | ±0.25pF            | GQM1883C2A3R6CB01# |                    |
|        |               |         | 3.9pF | ±0.1pF             | GQM1883C2A3R9BB01# |                    |
|        |               |         |       | ±0.25pF            | GQM1883C2A3R9CB01# |                    |
|        |               |         | CH    | 4.0pF              | ±0.1pF             | GQM1882C2A4R0BB01# |
|        |               |         |       |                    | ±0.25pF            | GQM1882C2A4R0CB01# |
|        |               |         |       | 4.3pF              | ±0.1pF             | GQM1882C2A4R3BB01# |
|        |               |         |       |                    | ±0.25pF            | GQM1882C2A4R3CB01# |
|        |               |         |       | 4.7pF              | ±0.1pF             | GQM1882C2A4R7BB01# |
|        |               |         |       |                    | ±0.25pF            | GQM1882C2A4R7CB01# |
|        |               |         |       | 5.0pF              | ±0.1pF             | GQM1882C2A5R0BB01# |
|        |               |         |       |                    | ±0.25pF            | GQM1882C2A5R0CB01# |
|        |               |         |       | 5.1pF              | ±0.25pF            | GQM1882C2A5R1CB01# |
|        |               |         |       |                    | ±0.5pF             | GQM1882C2A5R1DB01# |
|        |               |         |       | 5.6pF              | ±0.25pF            | GQM1882C2A5R6CB01# |
|        |               |         |       |                    | ±0.5pF             | GQM1882C2A5R6DB01# |
|        |               |         | 6.0pF | ±0.25pF            | GQM1882C2A6R0CB01# |                    |
|        |               |         |       | ±0.5pF             | GQM1882C2A6R0DB01# |                    |
|        |               |         | 6.2pF | ±0.25pF            | GQM1882C2A6R2CB01# |                    |
|        |               |         |       | ±0.5pF             | GQM1882C2A6R2DB01# |                    |
|        |               |         | 6.8pF | ±0.25pF            | GQM1882C2A6R8CB01# |                    |
|        |               |         |       | ±0.5pF             | GQM1882C2A6R8DB01# |                    |
|        |               | 50Vdc   | C0G   | 7.0pF              | ±0.25pF            | GQM1885C1H7R0CB01# |
|        |               |         |       |                    | ±0.5pF             | GQM1885C1H7R0DB01# |
|        |               |         |       | 7.5pF              | ±0.25pF            | GQM1885C1H7R5CB01# |
|        |               |         |       |                    | ±0.5pF             | GQM1885C1H7R5DB01# |
|        |               |         |       | 8.0pF              | ±0.25pF            | GQM1885C1H8R0CB01# |
|        |               |         |       |                    | ±0.5pF             | GQM1885C1H8R0DB01# |
|        |               |         |       | 8.2pF              | ±0.25pF            | GQM1885C1H8R2CB01# |
|        |               |         |       |                    | ±0.5pF             | GQM1885C1H8R2DB01# |
|        |               |         |       | 9.0pF              | ±0.25pF            | GQM1885C1H9R0CB01# |
|        |               |         |       |                    | ±0.5pF             | GQM1885C1H9R0DB01# |
|        |               |         |       | 9.1pF              | ±0.25pF            | GQM1885C1H9R1CB01# |
|        |               |         |       |                    | ±0.5pF             | GQM1885C1H9R1DB01# |
|        |               | 10pF    | ±2%   | GQM1885C1H100GB01# |                    |                    |
|        |               |         | ±5%   | GQM1885C1H100JB01# |                    |                    |
|        |               | 11pF    | ±2%   | GQM1885C1H110GB01# |                    |                    |
|        |               |         | ±5%   | GQM1885C1H110JB01# |                    |                    |
|        |               | 12pF    | ±2%   | GQM1885C1H120GB01# |                    |                    |
|        |               |         | ±5%   | GQM1885C1H120JB01# |                    |                    |
|        |               | 13pF    | ±2%   | GQM1885C1H130GB01# |                    |                    |
|        |               |         | ±5%   | GQM1885C1H130JB01# |                    |                    |
|        |               | 15pF    | ±2%   | GQM1885C1H150GB01# |                    |                    |
|        |               |         | ±5%   | GQM1885C1H150JB01# |                    |                    |
|        |               | 16pF    | ±2%   | GQM1885C1H160GB01# |                    |                    |
|        |               |         | ±5%   | GQM1885C1H160JB01# |                    |                    |

Part number # indicates the package specification code.

# GQM Series Temperature Compensating Type High Q Part Number List

(→ ■ 1.6x0.8mm)

| T max. | Rated Voltage | TC Code            | Cap.               | Tol.               | Part Number        |
|--------|---------------|--------------------|--------------------|--------------------|--------------------|
| 0.9mm  | 50Vdc         | COG                | 18pF               | ±2%                | GQM1885C1H180GB01# |
|        |               |                    |                    | ±5%                | GQM1885C1H180JB01# |
|        |               |                    | 20pF               | ±2%                | GQM1885C1H200GB01# |
|        |               |                    |                    | ±5%                | GQM1885C1H200JB01# |
|        |               |                    | 22pF               | ±2%                | GQM1885C1H220GB01# |
|        |               |                    |                    | ±5%                | GQM1885C1H220JB01# |
|        |               |                    | 24pF               | ±2%                | GQM1885C1H240GB01# |
|        |               |                    |                    | ±5%                | GQM1885C1H240JB01# |
|        |               |                    | 27pF               | ±2%                | GQM1885C1H270GB01# |
|        |               |                    |                    | ±5%                | GQM1885C1H270JB01# |
|        |               |                    | 30pF               | ±2%                | GQM1885C1H300GB01# |
|        |               |                    |                    | ±5%                | GQM1885C1H300JB01# |
|        |               |                    | 33pF               | ±2%                | GQM1885C1H330GB01# |
|        |               |                    |                    | ±5%                | GQM1885C1H330JB01# |
|        |               |                    | 36pF               | ±2%                | GQM1885C1H360GB01# |
|        |               |                    |                    | ±5%                | GQM1885C1H360JB01# |
|        |               |                    | 39pF               | ±2%                | GQM1885C1H390GB01# |
|        |               |                    |                    | ±5%                | GQM1885C1H390JB01# |
|        |               |                    | 43pF               | ±2%                | GQM1885C1H430GB01# |
|        |               |                    |                    | ±5%                | GQM1885C1H430JB01# |
|        |               |                    | 47pF               | ±2%                | GQM1885C1H470GB01# |
|        |               | ±5%                |                    | GQM1885C1H470JB01# |                    |
|        |               | 51pF               | ±2%                | GQM1885C1H510GB01# |                    |
|        |               |                    | ±5%                | GQM1885C1H510JB01# |                    |
|        |               | 56pF               | ±2%                | GQM1885C1H560GB01# |                    |
|        |               |                    | ±5%                | GQM1885C1H560JB01# |                    |
|        |               | 62pF               | ±2%                | GQM1885C1H620GB01# |                    |
|        |               |                    | ±5%                | GQM1885C1H620JB01# |                    |
|        |               | 68pF               | ±2%                | GQM1885C1H680GB01# |                    |
|        |               |                    | ±5%                | GQM1885C1H680JB01# |                    |
|        |               | 75pF               | ±2%                | GQM1885C1H750GB01# |                    |
|        |               |                    | ±5%                | GQM1885C1H750JB01# |                    |
|        |               | 82pF               | ±2%                | GQM1885C1H820GB01# |                    |
|        |               |                    | ±5%                | GQM1885C1H820JB01# |                    |
|        |               | 91pF               | ±2%                | GQM1885C1H910GB01# |                    |
|        |               |                    | ±5%                | GQM1885C1H910JB01# |                    |
|        |               | 100pF              | ±2%                | GQM1885C1H101GB01# |                    |
|        |               |                    | ±5%                | GQM1885C1H101JB01# |                    |
|        |               | CH                 | 7.0pF              | ±0.25pF            | GQM1882C1H7R0CB01# |
|        |               |                    |                    | ±0.5pF             | GQM1882C1H7R0DB01# |
|        |               |                    | 7.5pF              | ±0.25pF            | GQM1882C1H7R5CB01# |
|        |               |                    |                    | ±0.5pF             | GQM1882C1H7R5DB01# |
| 8.0pF  | ±0.25pF       |                    | GQM1882C1H8R0CB01# |                    |                    |
|        | ±0.5pF        |                    | GQM1882C1H8R0DB01# |                    |                    |
| 8.2pF  | ±0.25pF       |                    | GQM1882C1H8R2CB01# |                    |                    |
|        | ±0.5pF        |                    | GQM1882C1H8R2DB01# |                    |                    |
| 9.0pF  | ±0.25pF       |                    | GQM1882C1H9R0CB01# |                    |                    |
|        | ±0.5pF        |                    | GQM1882C1H9R0DB01# |                    |                    |
| 9.1pF  | ±0.25pF       |                    | GQM1882C1H9R1CB01# |                    |                    |
|        | ±0.5pF        |                    | GQM1882C1H9R1DB01# |                    |                    |
| 10pF   | ±2%           |                    | GQM1882C1H100GB01# |                    |                    |
|        | ±5%           |                    | GQM1882C1H100JB01# |                    |                    |
| 11pF   | ±2%           |                    | GQM1882C1H110GB01# |                    |                    |
|        | ±5%           | GQM1882C1H110JB01# |                    |                    |                    |

| T max. | Rated Voltage | TC Code            | Cap. | Tol. | Part Number        |
|--------|---------------|--------------------|------|------|--------------------|
| 0.9mm  | 50Vdc         | CH                 | 12pF | ±2%  | GQM1882C1H120GB01# |
|        |               |                    |      | ±5%  | GQM1882C1H120JB01# |
|        |               |                    | 13pF | ±2%  | GQM1882C1H130GB01# |
|        |               |                    |      | ±5%  | GQM1882C1H130JB01# |
|        |               |                    | 15pF | ±2%  | GQM1882C1H150GB01# |
|        |               |                    |      | ±5%  | GQM1882C1H150JB01# |
|        |               |                    | 16pF | ±2%  | GQM1882C1H160GB01# |
|        |               |                    |      | ±5%  | GQM1882C1H160JB01# |
|        |               |                    | 18pF | ±2%  | GQM1882C1H180GB01# |
|        |               |                    |      | ±5%  | GQM1882C1H180JB01# |
|        |               |                    | 20pF | ±2%  | GQM1882C1H200GB01# |
|        |               |                    |      | ±5%  | GQM1882C1H200JB01# |
|        |               |                    | 22pF | ±2%  | GQM1882C1H220GB01# |
|        |               |                    |      | ±5%  | GQM1882C1H220JB01# |
|        |               |                    | 24pF | ±2%  | GQM1882C1H240GB01# |
|        |               |                    |      | ±5%  | GQM1882C1H240JB01# |
|        |               |                    | 27pF | ±2%  | GQM1882C1H270GB01# |
|        |               |                    |      | ±5%  | GQM1882C1H270JB01# |
|        |               |                    | 30pF | ±2%  | GQM1882C1H300GB01# |
|        |               |                    |      | ±5%  | GQM1882C1H300JB01# |
|        |               |                    | 33pF | ±2%  | GQM1882C1H330GB01# |
|        |               |                    |      | ±5%  | GQM1882C1H330JB01# |
|        |               |                    | 36pF | ±2%  | GQM1882C1H360GB01# |
|        |               |                    |      | ±5%  | GQM1882C1H360JB01# |
|        |               |                    | 39pF | ±2%  | GQM1882C1H390GB01# |
|        |               |                    |      | ±5%  | GQM1882C1H390JB01# |
|        |               |                    | 43pF | ±2%  | GQM1882C1H430GB01# |
|        |               |                    |      | ±5%  | GQM1882C1H430JB01# |
|        |               |                    | 47pF | ±2%  | GQM1882C1H470GB01# |
|        |               |                    |      | ±5%  | GQM1882C1H470JB01# |
|        |               |                    | 51pF | ±2%  | GQM1882C1H510GB01# |
|        |               |                    |      | ±5%  | GQM1882C1H510JB01# |
|        |               |                    | 56pF | ±2%  | GQM1882C1H560GB01# |
|        |               |                    |      | ±5%  | GQM1882C1H560JB01# |
|        |               |                    | 62pF | ±2%  | GQM1882C1H620GB01# |
|        |               |                    |      | ±5%  | GQM1882C1H620JB01# |
|        |               |                    | 68pF | ±2%  | GQM1882C1H680GB01# |
|        |               |                    |      | ±5%  | GQM1882C1H680JB01# |
|        |               |                    | 75pF | ±2%  | GQM1882C1H750GB01# |
|        |               |                    |      | ±5%  | GQM1882C1H750JB01# |
|        |               |                    | 82pF | ±2%  | GQM1882C1H820GB01# |
|        |               |                    |      | ±5%  | GQM1882C1H820JB01# |
| 91pF   | ±2%           | GQM1882C1H910GB01# |      |      |                    |
|        | ±5%           | GQM1882C1H910JB01# |      |      |                    |
| 100pF  | ±2%           | GQM1882C1H101GB01# |      |      |                    |
|        | ±5%           | GQM1882C1H101JB01# |      |      |                    |

■ 2.0x1.25mm

| T max. | Rated Voltage | TC Code | Cap.  | Tol.    | Part Number        |
|--------|---------------|---------|-------|---------|--------------------|
| 0.95mm | 100Vdc        | COG     | 1.0pF | ±0.1pF  | GQM2195C2A1R0BB01# |
|        |               |         |       | ±0.25pF | GQM2195C2A1R0CB01# |
|        |               |         | 1.1pF | ±0.1pF  | GQM2195C2A1R1BB01# |

Part number # indicates the package specification code.

GRM Series  
 GJM Series  
 GMA Series  
 GMD Series  
 GQM Series  
 GRJ Series  
 GR3 Series  
 KRM Series  
 KR3 Series  
 LLA Series  
 LLL Series  
 LLM Series  
 LLR Series  
 ⚠Caution/ Notice

# GQM Series Temperature Compensating Type High Q Part Number List

(→ ■ 2.0x1.25mm)

| T max. | Rated Voltage | TC Code | Cap.  | Tol.    | Part Number        |
|--------|---------------|---------|-------|---------|--------------------|
| 0.95mm | 100Vdc        | C0G     | 1.1pF | ±0.25pF | GQM2195C2A1R1CB01# |
|        |               |         |       | ±0.1pF  | GQM2195C2A1R2BB01# |
|        |               |         | 1.2pF | ±0.25pF | GQM2195C2A1R2CB01# |
|        |               |         |       | ±0.1pF  | GQM2195C2A1R3BB01# |
|        |               |         | 1.3pF | ±0.25pF | GQM2195C2A1R3CB01# |
|        |               |         |       | ±0.1pF  | GQM2195C2A1R5BB01# |
|        |               |         | 1.5pF | ±0.25pF | GQM2195C2A1R5CB01# |
|        |               |         |       | ±0.1pF  | GQM2195C2A1R6BB01# |
|        |               |         | 1.6pF | ±0.25pF | GQM2195C2A1R6CB01# |
|        |               |         |       | ±0.1pF  | GQM2195C2A1R8BB01# |
|        |               |         | 1.8pF | ±0.25pF | GQM2195C2A1R8CB01# |
|        |               |         |       | ±0.1pF  | GQM2195C2A2R0BB01# |
|        |               |         | 2.0pF | ±0.25pF | GQM2195C2A2R0CB01# |
|        |               |         |       | ±0.1pF  | GQM2195C2A2R2BB01# |
|        |               |         | 2.2pF | ±0.25pF | GQM2195C2A2R2CB01# |
|        |               |         |       | ±0.1pF  | GQM2195C2A2R4BB01# |
|        |               |         | 2.4pF | ±0.25pF | GQM2195C2A2R4CB01# |
|        |               |         |       | ±0.1pF  | GQM2195C2A2R7BB01# |
|        |               |         | 2.7pF | ±0.25pF | GQM2195C2A2R7CB01# |
|        |               |         |       | ±0.1pF  | GQM2195C2A3R0BB01# |
|        |               |         | 3.0pF | ±0.25pF | GQM2195C2A3R0CB01# |
|        |               |         |       | ±0.1pF  | GQM2195C2A3R3BB01# |
|        |               |         | 3.3pF | ±0.25pF | GQM2195C2A3R3CB01# |
|        |               |         |       | ±0.1pF  | GQM2195C2A3R6BB01# |
|        |               |         | 3.6pF | ±0.25pF | GQM2195C2A3R6CB01# |
|        |               |         |       | ±0.1pF  | GQM2195C2A3R9BB01# |
|        |               |         | 3.9pF | ±0.25pF | GQM2195C2A3R9CB01# |
|        |               |         |       | ±0.1pF  | GQM2195C2A4R0BB01# |
|        |               |         | 4.0pF | ±0.25pF | GQM2195C2A4R0CB01# |
|        |               |         |       | ±0.1pF  | GQM2195C2A4R3BB01# |
|        |               |         | 4.3pF | ±0.25pF | GQM2195C2A4R3CB01# |
|        |               |         |       | ±0.1pF  | GQM2195C2A4R7BB01# |
|        |               |         | 4.7pF | ±0.25pF | GQM2195C2A4R7CB01# |
|        |               |         |       | ±0.1pF  | GQM2195C2A5R0BB01# |
|        |               |         | 5.0pF | ±0.25pF | GQM2195C2A5R0CB01# |
|        |               |         |       | ±0.1pF  | GQM2195C2A5R1CB01# |
|        |               |         | 5.1pF | ±0.5pF  | GQM2195C2A5R1DB01# |
|        |               |         |       | ±0.25pF | GQM2195C2A5R6CB01# |
|        |               |         | 5.6pF | ±0.5pF  | GQM2195C2A5R6DB01# |
|        |               |         |       | ±0.25pF | GQM2195C2A6R0CB01# |
|        |               |         | 6.0pF | ±0.5pF  | GQM2195C2A6R0DB01# |
|        |               |         |       | ±0.25pF | GQM2195C2A6R2CB01# |
|        |               |         | 6.2pF | ±0.5pF  | GQM2195C2A6R2DB01# |
|        |               |         |       | ±0.25pF | GQM2195C2A6R8CB01# |
|        |               |         | 6.8pF | ±0.5pF  | GQM2195C2A6R8DB01# |
|        |               |         |       | ±0.25pF | GQM2195C2A7R0CB01# |
|        |               |         | 7.0pF | ±0.5pF  | GQM2195C2A7R0DB01# |
|        |               |         |       | ±0.25pF | GQM2195C2A7R5CB01# |
|        |               |         | 7.5pF | ±0.5pF  | GQM2195C2A7R5DB01# |
|        |               |         |       | ±0.25pF | GQM2195C2A8R0CB01# |
|        |               |         | 8.0pF | ±0.5pF  | GQM2195C2A8R0DB01# |
|        |               |         |       | ±0.25pF | GQM2195C2A8R2CB01# |
|        |               |         | 8.2pF | ±0.5pF  | GQM2195C2A8R2DB01# |
|        |               |         |       | ±0.25pF | GQM2195C2A9R0CB01# |

| T max. | Rated Voltage | TC Code            | Cap.    | Tol.               | Part Number        |
|--------|---------------|--------------------|---------|--------------------|--------------------|
| 0.95mm | 100Vdc        | C0G                | 9.0pF   | ±0.5pF             | GQM2195C2A9R0DB01# |
|        |               |                    |         | ±0.25pF            | GQM2195C2A9R1CB01# |
|        |               |                    | 9.1pF   | ±0.5pF             | GQM2195C2A9R1DB01# |
|        |               |                    |         | ±2%                | GQM2195C2A100GB01# |
|        |               |                    | 10pF    | ±5%                | GQM2195C2A100JB01# |
|        |               |                    |         | ±2%                | GQM2195C2A110GB01# |
|        |               |                    | 11pF    | ±5%                | GQM2195C2A110JB01# |
|        |               |                    |         | ±2%                | GQM2195C2A120GB01# |
|        |               |                    | 12pF    | ±5%                | GQM2195C2A120JB01# |
|        |               |                    |         | ±2%                | GQM2195C2A130GB01# |
|        |               |                    | 13pF    | ±5%                | GQM2195C2A130JB01# |
|        |               |                    |         | ±2%                | GQM2195C2A150GB01# |
|        |               |                    | 15pF    | ±5%                | GQM2195C2A150JB01# |
|        |               |                    |         | ±2%                | GQM2195C2A160GB01# |
|        |               |                    | 16pF    | ±5%                | GQM2195C2A160JB01# |
|        |               |                    |         | ±2%                | GQM2195C2A180GB01# |
|        |               |                    | 18pF    | ±5%                | GQM2195C2A180JB01# |
|        |               |                    |         | ±0.1pF             | GQM2194C2A1R0BB01# |
|        |               |                    | 1.0pF   | ±0.25pF            | GQM2194C2A1R0CB01# |
|        |               |                    |         | ±0.1pF             | GQM2194C2A1R1BB01# |
|        |               |                    | 1.1pF   | ±0.25pF            | GQM2194C2A1R1CB01# |
|        |               |                    |         | ±0.1pF             | GQM2194C2A1R2BB01# |
|        |               |                    | 1.2pF   | ±0.25pF            | GQM2194C2A1R2CB01# |
|        |               |                    |         | ±0.1pF             | GQM2194C2A1R3BB01# |
|        |               |                    | 1.3pF   | ±0.25pF            | GQM2194C2A1R3CB01# |
|        |               |                    |         | ±0.1pF             | GQM2194C2A1R5BB01# |
|        |               |                    | 1.5pF   | ±0.25pF            | GQM2194C2A1R5CB01# |
|        |               |                    |         | ±0.1pF             | GQM2194C2A1R6BB01# |
|        |               |                    | 1.6pF   | ±0.25pF            | GQM2194C2A1R6CB01# |
|        |               |                    |         | ±0.1pF             | GQM2194C2A1R8BB01# |
|        |               |                    | 1.8pF   | ±0.25pF            | GQM2194C2A1R8CB01# |
|        |               |                    |         | ±0.1pF             | GQM2194C2A2R0BB01# |
|        |               |                    | 2.0pF   | ±0.25pF            | GQM2194C2A2R0CB01# |
|        |               |                    |         | ±0.1pF             | GQM2193C2A2R2BB01# |
|        |               |                    | 2.2pF   | ±0.25pF            | GQM2193C2A2R2CB01# |
|        |               |                    |         | ±0.1pF             | GQM2193C2A2R4BB01# |
|        |               | 2.4pF              | ±0.25pF | GQM2193C2A2R4CB01# |                    |
|        |               |                    | ±0.1pF  | GQM2193C2A2R7BB01# |                    |
|        |               | 2.7pF              | ±0.25pF | GQM2193C2A2R7CB01# |                    |
|        |               |                    | ±0.1pF  | GQM2193C2A3R0BB01# |                    |
|        |               | 3.0pF              | ±0.25pF | GQM2193C2A3R0CB01# |                    |
|        |               |                    | ±0.1pF  | GQM2193C2A3R3BB01# |                    |
|        |               | 3.3pF              | ±0.25pF | GQM2193C2A3R3CB01# |                    |
|        |               |                    | ±0.1pF  | GQM2193C2A3R6BB01# |                    |
|        |               | 3.6pF              | ±0.25pF | GQM2193C2A3R6CB01# |                    |
|        |               |                    | ±0.1pF  | GQM2193C2A3R9BB01# |                    |
|        |               | 3.9pF              | ±0.25pF | GQM2193C2A3R9CB01# |                    |
|        |               |                    | ±0.1pF  | GQM2192C2A4R0BB01# |                    |
|        |               | 4.0pF              | ±0.25pF | GQM2192C2A4R0CB01# |                    |
|        |               |                    | ±0.1pF  | GQM2192C2A4R3BB01# |                    |
|        |               | 4.3pF              | ±0.25pF | GQM2192C2A4R3CB01# |                    |
|        |               |                    | ±0.1pF  | GQM2192C2A4R3DB01# |                    |
|        |               | 4.7pF              | ±0.25pF | GQM2192C2A4R7BB01# |                    |
|        |               |                    | ±0.1pF  | GQM2192C2A4R7CB01# |                    |
| 5.0pF  | ±0.1pF        | GQM2192C2A5R0BB01# |         |                    |                    |

Part number # indicates the package specification code.



# GQM Series Temperature Compensating Type High Q Part Number List

(→ ■ 2.0x1.25mm)

| T max. | Rated Voltage | TC Code            | Cap.               | Tol.               | Part Number        |
|--------|---------------|--------------------|--------------------|--------------------|--------------------|
| 0.95mm | 100Vdc        | CH                 | 5.0pF              | ±0.25pF            | GQM2192C2A5R0CB01# |
|        |               |                    |                    | ±0.25pF            | GQM2192C2A5R1CB01# |
|        |               |                    | 5.1pF              | ±0.25pF            | GQM2192C2A5R1CB01# |
|        |               |                    |                    | ±0.5pF             | GQM2192C2A5R1DB01# |
|        |               |                    | 5.6pF              | ±0.25pF            | GQM2192C2A5R6CB01# |
|        |               |                    |                    | ±0.5pF             | GQM2192C2A5R6DB01# |
|        |               |                    | 6.0pF              | ±0.25pF            | GQM2192C2A6R0CB01# |
|        |               |                    |                    | ±0.5pF             | GQM2192C2A6R0DB01# |
|        |               |                    | 6.2pF              | ±0.25pF            | GQM2192C2A6R2CB01# |
|        |               |                    |                    | ±0.5pF             | GQM2192C2A6R2DB01# |
|        |               |                    | 6.8pF              | ±0.25pF            | GQM2192C2A6R8CB01# |
|        |               |                    |                    | ±0.5pF             | GQM2192C2A6R8DB01# |
|        |               |                    | 7.0pF              | ±0.25pF            | GQM2192C2A7R0CB01# |
|        |               |                    |                    | ±0.5pF             | GQM2192C2A7R0DB01# |
|        |               |                    | 7.5pF              | ±0.25pF            | GQM2192C2A7R5CB01# |
|        |               |                    |                    | ±0.5pF             | GQM2192C2A7R5DB01# |
|        |               |                    | 8.0pF              | ±0.25pF            | GQM2192C2A8R0CB01# |
|        |               |                    |                    | ±0.5pF             | GQM2192C2A8R0DB01# |
|        |               |                    | 8.2pF              | ±0.25pF            | GQM2192C2A8R2CB01# |
|        |               |                    |                    | ±0.5pF             | GQM2192C2A8R2DB01# |
|        |               |                    | 9.0pF              | ±0.25pF            | GQM2192C2A9R0CB01# |
|        |               |                    |                    | ±0.5pF             | GQM2192C2A9R0DB01# |
|        |               |                    | 9.1pF              | ±0.25pF            | GQM2192C2A9R1CB01# |
|        |               |                    |                    | ±0.5pF             | GQM2192C2A9R1DB01# |
|        | 10pF          | ±2%                | GQM2192C2A100GB01# |                    |                    |
|        |               | ±5%                | GQM2192C2A100JB01# |                    |                    |
|        | 11pF          | ±2%                | GQM2192C2A110GB01# |                    |                    |
|        |               | ±5%                | GQM2192C2A110JB01# |                    |                    |
|        | 12pF          | ±2%                | GQM2192C2A120GB01# |                    |                    |
|        |               | ±5%                | GQM2192C2A120JB01# |                    |                    |
|        | 13pF          | ±2%                | GQM2192C2A130GB01# |                    |                    |
|        |               | ±5%                | GQM2192C2A130JB01# |                    |                    |
|        | 15pF          | ±2%                | GQM2192C2A150GB01# |                    |                    |
|        |               | ±5%                | GQM2192C2A150JB01# |                    |                    |
|        | 16pF          | ±2%                | GQM2192C2A160GB01# |                    |                    |
|        |               | ±5%                | GQM2192C2A160JB01# |                    |                    |
|        | 18pF          | ±2%                | GQM2192C2A180GB01# |                    |                    |
|        |               | ±5%                | GQM2192C2A180JB01# |                    |                    |
|        | 50Vdc         | COG                | 20pF               | ±2%                | GQM2195C1H200GB01# |
|        |               |                    |                    | ±5%                | GQM2195C1H200JB01# |
|        |               |                    | 22pF               | ±2%                | GQM2195C1H220GB01# |
|        |               |                    |                    | ±5%                | GQM2195C1H220JB01# |
|        |               |                    | 24pF               | ±2%                | GQM2195C1H240GB01# |
|        |               |                    |                    | ±5%                | GQM2195C1H240JB01# |
|        |               |                    | 27pF               | ±2%                | GQM2195C1H270GB01# |
|        |               |                    |                    | ±5%                | GQM2195C1H270JB01# |
|        |               |                    | 30pF               | ±2%                | GQM2195C1H300GB01# |
|        |               |                    |                    | ±5%                | GQM2195C1H300JB01# |
| 33pF   |               |                    | ±2%                | GQM2195C1H330GB01# |                    |
|        |               |                    | ±5%                | GQM2195C1H330JB01# |                    |
| 36pF   |               |                    | ±2%                | GQM2195C1H360GB01# |                    |
|        |               |                    | ±5%                | GQM2195C1H360JB01# |                    |
| 39pF   |               |                    | ±2%                | GQM2195C1H390GB01# |                    |
|        |               |                    | ±5%                | GQM2195C1H390JB01# |                    |
| 43pF   | ±2%           | GQM2195C1H430GB01# |                    |                    |                    |
|        | ±5%           | GQM2195C1H430JB01# |                    |                    |                    |

| T max. | Rated Voltage | TC Code            | Cap.               | Tol. | Part Number        |     |                    |
|--------|---------------|--------------------|--------------------|------|--------------------|-----|--------------------|
| 0.95mm | 50Vdc         | COG                | 43pF               | ±5%  | GQM2195C1H430JB01# |     |                    |
|        |               |                    |                    | ±2%  | GQM2195C1H470GB01# |     |                    |
|        |               |                    | 47pF               | ±2%  | GQM2195C1H470GB01# |     |                    |
|        |               |                    |                    | ±5%  | GQM2195C1H470JB01# |     |                    |
|        |               |                    | 51pF               | ±2%  | GQM2195C1H510GB01# |     |                    |
|        |               |                    |                    | ±5%  | GQM2195C1H510JB01# |     |                    |
|        |               |                    | 56pF               | ±2%  | GQM2195C1H560GB01# |     |                    |
|        |               |                    |                    | ±5%  | GQM2195C1H560JB01# |     |                    |
|        |               |                    | 62pF               | ±2%  | GQM2195C1H620GB01# |     |                    |
|        |               |                    |                    | ±5%  | GQM2195C1H620JB01# |     |                    |
|        |               |                    | 68pF               | ±2%  | GQM2195C1H680GB01# |     |                    |
|        |               |                    |                    | ±5%  | GQM2195C1H680JB01# |     |                    |
|        |               |                    | 75pF               | ±2%  | GQM2195C1H750GB01# |     |                    |
|        |               |                    |                    | ±5%  | GQM2195C1H750JB01# |     |                    |
|        |               |                    | 82pF               | ±2%  | GQM2195C1H820GB01# |     |                    |
|        |               |                    |                    | ±5%  | GQM2195C1H820JB01# |     |                    |
|        |               |                    | 91pF               | ±2%  | GQM2195C1H910GB01# |     |                    |
|        |               |                    |                    | ±5%  | GQM2195C1H910JB01# |     |                    |
|        |               |                    | 100pF              | ±2%  | GQM2195C1H101GB01# |     |                    |
|        |               |                    |                    | ±5%  | GQM2195C1H101JB01# |     |                    |
|        |               |                    | CH                 | CH   | 20pF               | ±2% | GQM2192C1H200GB01# |
|        |               |                    |                    |      |                    | ±5% | GQM2192C1H200JB01# |
|        |               |                    |                    |      | 22pF               | ±2% | GQM2192C1H220GB01# |
|        |               |                    |                    |      |                    | ±5% | GQM2192C1H220JB01# |
|        | 24pF          | ±2%                |                    |      | GQM2192C1H240GB01# |     |                    |
|        |               | ±5%                |                    |      | GQM2192C1H240JB01# |     |                    |
|        | 27pF          | ±2%                |                    |      | GQM2192C1H270GB01# |     |                    |
|        |               | ±5%                |                    |      | GQM2192C1H270JB01# |     |                    |
|        | 30pF          | ±2%                |                    |      | GQM2192C1H300GB01# |     |                    |
|        |               | ±5%                |                    |      | GQM2192C1H300JB01# |     |                    |
|        | 33pF          | ±2%                |                    |      | GQM2192C1H330GB01# |     |                    |
|        |               | ±5%                |                    |      | GQM2192C1H330JB01# |     |                    |
|        | 36pF          | ±2%                |                    |      | GQM2192C1H360GB01# |     |                    |
|        |               | ±5%                |                    |      | GQM2192C1H360JB01# |     |                    |
|        | 39pF          | ±2%                |                    |      | GQM2192C1H390GB01# |     |                    |
|        |               | ±5%                |                    |      | GQM2192C1H390JB01# |     |                    |
|        | 43pF          | ±2%                | GQM2192C1H430GB01# |      |                    |     |                    |
|        |               | ±5%                | GQM2192C1H430JB01# |      |                    |     |                    |
|        | 47pF          | ±2%                | GQM2192C1H470GB01# |      |                    |     |                    |
|        |               | ±5%                | GQM2192C1H470JB01# |      |                    |     |                    |
|        | 51pF          | ±2%                | GQM2192C1H510GB01# |      |                    |     |                    |
|        |               | ±5%                | GQM2192C1H510JB01# |      |                    |     |                    |
|        | 56pF          | ±2%                | GQM2192C1H560GB01# |      |                    |     |                    |
|        |               | ±5%                | GQM2192C1H560JB01# |      |                    |     |                    |
|        | 62pF          | ±2%                | GQM2192C1H620GB01# |      |                    |     |                    |
|        |               | ±5%                | GQM2192C1H620JB01# |      |                    |     |                    |
|        | 68pF          | ±2%                | GQM2192C1H680GB01# |      |                    |     |                    |
|        |               | ±5%                | GQM2192C1H680JB01# |      |                    |     |                    |
| 75pF   | ±2%           | GQM2192C1H750GB01# |                    |      |                    |     |                    |
|        | ±5%           | GQM2192C1H750JB01# |                    |      |                    |     |                    |
| 82pF   | ±2%           | GQM2192C1H820GB01# |                    |      |                    |     |                    |
|        | ±5%           | GQM2192C1H820JB01# |                    |      |                    |     |                    |
| 91pF   | ±2%           | GQM2192C1H910GB01# |                    |      |                    |     |                    |
|        | ±5%           | GQM2192C1H910JB01# |                    |      |                    |     |                    |
| 100pF  | ±2%           | GQM2192C1H101GB01# |                    |      |                    |     |                    |

Part number # indicates the package specification code.

GRM Series  
 GJM Series  
 GMA Series  
 GMD Series  
 GQM Series  
 GRJ Series  
 GR3 Series  
 KRM Series  
 KR3 Series  
 LLA Series  
 LLL Series  
 LLM Series  
 LLR Series  
 ⚠Caution/ Notice

# GQM Series Temperature Compensating Type High Q Part Number List

(→ ■ 2.0x1.25mm)

| T max. | Rated Voltage | TC Code            | Cap.  | Tol.    | Part Number        |
|--------|---------------|--------------------|-------|---------|--------------------|
| 0.95mm | 50Vdc         | CH                 | 100pF | ±5%     | GQM2192C1H101JB01# |
| 1.0mm  | 250Vdc        | C0G                | 1.0pF | ±0.1pF  | GQM2195C2E1R0BB12# |
|        |               |                    |       | ±0.25pF | GQM2195C2E1R0CB12# |
|        |               |                    | 1.1pF | ±0.1pF  | GQM2195C2E1R1BB12# |
|        |               |                    |       | ±0.25pF | GQM2195C2E1R1CB12# |
|        |               |                    | 1.2pF | ±0.1pF  | GQM2195C2E1R2BB12# |
|        |               |                    |       | ±0.25pF | GQM2195C2E1R2CB12# |
|        |               |                    | 1.3pF | ±0.1pF  | GQM2195C2E1R3BB12# |
|        |               |                    |       | ±0.25pF | GQM2195C2E1R3CB12# |
|        |               |                    | 1.5pF | ±0.1pF  | GQM2195C2E1R5BB12# |
|        |               |                    |       | ±0.25pF | GQM2195C2E1R5CB12# |
|        |               |                    | 1.6pF | ±0.1pF  | GQM2195C2E1R6BB12# |
|        |               |                    |       | ±0.25pF | GQM2195C2E1R6CB12# |
|        |               |                    | 1.8pF | ±0.1pF  | GQM2195C2E1R8BB12# |
|        |               |                    |       | ±0.25pF | GQM2195C2E1R8CB12# |
|        |               |                    | 2.0pF | ±0.1pF  | GQM2195C2E2R0BB12# |
|        |               |                    |       | ±0.25pF | GQM2195C2E2R0CB12# |
|        |               |                    | 2.2pF | ±0.1pF  | GQM2195C2E2R2BB12# |
|        |               |                    |       | ±0.25pF | GQM2195C2E2R2CB12# |
|        |               |                    | 2.4pF | ±0.1pF  | GQM2195C2E2R4BB12# |
|        |               |                    |       | ±0.25pF | GQM2195C2E2R4CB12# |
|        |               |                    | 2.7pF | ±0.1pF  | GQM2195C2E2R7BB12# |
|        |               |                    |       | ±0.25pF | GQM2195C2E2R7CB12# |
|        |               |                    | 3.0pF | ±0.1pF  | GQM2195C2E3R0BB12# |
|        |               |                    |       | ±0.25pF | GQM2195C2E3R0CB12# |
|        |               |                    | 3.3pF | ±0.1pF  | GQM2195C2E3R3BB12# |
|        |               |                    |       | ±0.25pF | GQM2195C2E3R3CB12# |
|        |               |                    | 3.6pF | ±0.1pF  | GQM2195C2E3R6BB12# |
|        |               |                    |       | ±0.25pF | GQM2195C2E3R6CB12# |
|        |               |                    | 3.9pF | ±0.1pF  | GQM2195C2E3R9BB12# |
|        |               |                    |       | ±0.25pF | GQM2195C2E3R9CB12# |
|        |               |                    | 4.0pF | ±0.1pF  | GQM2195C2E4R0BB12# |
|        |               |                    |       | ±0.25pF | GQM2195C2E4R0CB12# |
|        |               |                    | 4.3pF | ±0.1pF  | GQM2195C2E4R3BB12# |
|        |               |                    |       | ±0.25pF | GQM2195C2E4R3CB12# |
|        |               |                    | 4.7pF | ±0.1pF  | GQM2195C2E4R7BB12# |
|        |               |                    |       | ±0.25pF | GQM2195C2E4R7CB12# |
|        |               |                    | 5.0pF | ±0.1pF  | GQM2195C2E5R0BB12# |
|        |               |                    |       | ±0.25pF | GQM2195C2E5R0CB12# |
|        |               |                    | 5.1pF | ±0.25pF | GQM2195C2E5R1CB12# |
|        |               |                    |       | ±0.5pF  | GQM2195C2E5R1DB12# |
|        |               |                    | 5.6pF | ±0.25pF | GQM2195C2E5R6CB12# |
|        |               |                    |       | ±0.5pF  | GQM2195C2E5R6DB12# |
|        |               |                    | 6.0pF | ±0.25pF | GQM2195C2E6R0CB12# |
|        |               |                    |       | ±0.5pF  | GQM2195C2E6R0DB12# |
|        |               |                    | 6.2pF | ±0.25pF | GQM2195C2E6R2CB12# |
|        |               |                    |       | ±0.5pF  | GQM2195C2E6R2DB12# |
|        |               |                    | 6.8pF | ±0.25pF | GQM2195C2E6R8CB12# |
|        |               |                    |       | ±0.5pF  | GQM2195C2E6R8DB12# |
| 7.0pF  | ±0.25pF       | GQM2195C2E7R0CB12# |       |         |                    |
|        | ±0.5pF        | GQM2195C2E7R0DB12# |       |         |                    |
| 7.5pF  | ±0.25pF       | GQM2195C2E7R5CB12# |       |         |                    |
|        | ±0.5pF        | GQM2195C2E7R5DB12# |       |         |                    |
| 8.0pF  | ±0.25pF       | GQM2195C2E8R0CB12# |       |         |                    |

| T max. | Rated Voltage      | TC Code            | Cap.  | Tol.    | Part Number        |
|--------|--------------------|--------------------|-------|---------|--------------------|
| 1.0mm  | 250Vdc             | C0G                | 8.0pF | ±0.5pF  | GQM2195C2E8R0DB12# |
|        |                    |                    | 8.2pF | ±0.25pF | GQM2195C2E8R2CB12# |
|        |                    |                    |       | ±0.5pF  | GQM2195C2E8R2DB12# |
|        |                    |                    | 9.0pF | ±0.25pF | GQM2195C2E9R0CB12# |
|        |                    |                    |       | ±0.5pF  | GQM2195C2E9R0DB12# |
|        |                    |                    | 9.1pF | ±0.25pF | GQM2195C2E9R1CB12# |
|        |                    |                    |       | ±0.5pF  | GQM2195C2E9R1DB12# |
|        |                    |                    | 10pF  | ±2%     | GQM2195C2E100GB12# |
|        |                    |                    |       | ±5%     | GQM2195C2E100JB12# |
|        |                    |                    | 11pF  | ±2%     | GQM2195C2E110GB12# |
|        |                    |                    |       | ±5%     | GQM2195C2E110JB12# |
|        |                    |                    | 12pF  | ±2%     | GQM2195C2E120GB12# |
|        |                    |                    |       | ±5%     | GQM2195C2E120JB12# |
|        |                    |                    | 13pF  | ±2%     | GQM2195C2E130GB12# |
|        |                    |                    |       | ±5%     | GQM2195C2E130JB12# |
|        |                    |                    | 15pF  | ±2%     | GQM2195C2E150GB12# |
|        |                    |                    |       | ±5%     | GQM2195C2E150JB12# |
|        |                    |                    | 16pF  | ±2%     | GQM2195C2E160GB12# |
|        |                    |                    |       | ±5%     | GQM2195C2E160JB12# |
|        |                    |                    | 18pF  | ±2%     | GQM2195C2E180GB12# |
|        |                    |                    |       | ±5%     | GQM2195C2E180JB12# |
|        |                    |                    | 20pF  | ±2%     | GQM2195C2E200GB12# |
|        |                    |                    |       | ±5%     | GQM2195C2E200JB12# |
|        |                    |                    | 22pF  | ±2%     | GQM2195C2E220GB12# |
| ±5%    | GQM2195C2E220JB12# |                    |       |         |                    |
| 24pF   | ±2%                | GQM2195C2E240GB12# |       |         |                    |
|        | ±5%                | GQM2195C2E240JB12# |       |         |                    |
| 27pF   | ±2%                | GQM2195C2E270GB12# |       |         |                    |
|        | ±5%                | GQM2195C2E270JB12# |       |         |                    |
| 30pF   | ±2%                | GQM2195C2E300GB12# |       |         |                    |
|        | ±5%                | GQM2195C2E300JB12# |       |         |                    |
| 33pF   | ±2%                | GQM2195C2E330GB12# |       |         |                    |
|        | ±5%                | GQM2195C2E330JB12# |       |         |                    |
| 36pF   | ±2%                | GQM2195C2E360GB12# |       |         |                    |
|        | ±5%                | GQM2195C2E360JB12# |       |         |                    |
| 39pF   | ±2%                | GQM2195C2E390GB12# |       |         |                    |
|        | ±5%                | GQM2195C2E390JB12# |       |         |                    |
| 43pF   | ±2%                | GQM2195C2E430GB12# |       |         |                    |
|        | ±5%                | GQM2195C2E430JB12# |       |         |                    |
| 47pF   | ±2%                | GQM2195C2E470GB12# |       |         |                    |
|        | ±5%                | GQM2195C2E470JB12# |       |         |                    |
| 51pF   | ±2%                | GQM2195C2E510GB12# |       |         |                    |
|        | ±5%                | GQM2195C2E510JB12# |       |         |                    |
| 56pF   | ±2%                | GQM2195C2E560GB12# |       |         |                    |
|        | ±5%                | GQM2195C2E560JB12# |       |         |                    |
| 62pF   | ±2%                | GQM2195C2E620GB12# |       |         |                    |
|        | ±5%                | GQM2195C2E620JB12# |       |         |                    |
| 68pF   | ±2%                | GQM2195C2E680GB12# |       |         |                    |
|        | ±5%                | GQM2195C2E680JB12# |       |         |                    |
| 75pF   | ±2%                | GQM2195C2E750GB12# |       |         |                    |
|        | ±5%                | GQM2195C2E750JB12# |       |         |                    |
| 82pF   | ±2%                | GQM2195C2E820GB12# |       |         |                    |
|        | ±5%                | GQM2195C2E820JB12# |       |         |                    |
| 91pF   | ±2%                | GQM2195C2E910GB12# |       |         |                    |

Part number # indicates the package specification code.

- GMR Series
- GJM Series
- GMA Series
- GMD Series
- GQM Series**
- GRJ Series
- GR3 Series
- KRM Series
- KR3 Series
- LLA Series
- LLL Series
- LLM Series
- LLR Series
- ⚠Caution/ Notice

# GQM Series Temperature Compensating Type High Q Part Number List

(→ ■ 2.0x1.25mm)

| T max. | Rated Voltage | TC Code | Cap.  | Tol. | Part Number        |
|--------|---------------|---------|-------|------|--------------------|
| 1.0mm  | 250Vdc        | C0G     | 91pF  | ±5%  | GQM2195C2E910JB12# |
|        |               |         | 100pF | ±2%  | GQM2195C2E101GB12# |
|        |               |         |       | ±5%  | GQM2195C2E101JB12# |

■ 2.8x2.8mm

| T max. | Rated Voltage | TC Code | Cap.  | Tol.    | Part Number        |
|--------|---------------|---------|-------|---------|--------------------|
| 1.35mm | 500Vdc        | C0G     | 1.0pF | ±0.1pF  | GQM22M5C2H1R0BB01# |
|        |               |         |       | ±0.25pF | GQM22M5C2H1R0CB01# |
|        |               |         | 1.1pF | ±0.1pF  | GQM22M5C2H1R1BB01# |
|        |               |         |       | ±0.25pF | GQM22M5C2H1R1CB01# |
|        |               |         | 1.2pF | ±0.1pF  | GQM22M5C2H1R2BB01# |
|        |               |         |       | ±0.25pF | GQM22M5C2H1R2CB01# |
|        |               |         | 1.3pF | ±0.1pF  | GQM22M5C2H1R3BB01# |
|        |               |         |       | ±0.25pF | GQM22M5C2H1R3CB01# |
|        |               |         | 1.5pF | ±0.1pF  | GQM22M5C2H1R5BB01# |
|        |               |         |       | ±0.25pF | GQM22M5C2H1R5CB01# |
|        |               |         | 1.6pF | ±0.1pF  | GQM22M5C2H1R6BB01# |
|        |               |         |       | ±0.25pF | GQM22M5C2H1R6CB01# |
|        |               |         | 1.8pF | ±0.1pF  | GQM22M5C2H1R8BB01# |
|        |               |         |       | ±0.25pF | GQM22M5C2H1R8CB01# |
|        |               |         | 2.0pF | ±0.1pF  | GQM22M5C2H2R0BB01# |
|        |               |         |       | ±0.25pF | GQM22M5C2H2R0CB01# |
|        |               |         | 2.2pF | ±0.1pF  | GQM22M5C2H2R2BB01# |
|        |               |         |       | ±0.25pF | GQM22M5C2H2R2CB01# |
|        |               |         | 2.4pF | ±0.1pF  | GQM22M5C2H2R4BB01# |
|        |               |         |       | ±0.25pF | GQM22M5C2H2R4CB01# |
|        |               |         | 2.7pF | ±0.1pF  | GQM22M5C2H2R7BB01# |
|        |               |         |       | ±0.25pF | GQM22M5C2H2R7CB01# |
|        |               |         | 3.0pF | ±0.1pF  | GQM22M5C2H3R0BB01# |
|        |               |         |       | ±0.25pF | GQM22M5C2H3R0CB01# |
|        |               |         | 3.3pF | ±0.1pF  | GQM22M5C2H3R3BB01# |
|        |               |         |       | ±0.25pF | GQM22M5C2H3R3CB01# |
|        |               |         | 3.6pF | ±0.1pF  | GQM22M5C2H3R6BB01# |
|        |               |         |       | ±0.25pF | GQM22M5C2H3R6CB01# |
|        |               |         | 3.9pF | ±0.1pF  | GQM22M5C2H3R9BB01# |
|        |               |         |       | ±0.25pF | GQM22M5C2H3R9CB01# |
|        |               |         | 4.0pF | ±0.1pF  | GQM22M5C2H4R0BB01# |
|        |               |         |       | ±0.25pF | GQM22M5C2H4R0CB01# |
|        |               |         | 4.3pF | ±0.1pF  | GQM22M5C2H4R3BB01# |
|        |               |         |       | ±0.25pF | GQM22M5C2H4R3CB01# |
|        |               |         | 4.7pF | ±0.1pF  | GQM22M5C2H4R7BB01# |
|        |               |         |       | ±0.25pF | GQM22M5C2H4R7CB01# |
|        |               |         | 5.0pF | ±0.1pF  | GQM22M5C2H5R0BB01# |
|        |               |         |       | ±0.25pF | GQM22M5C2H5R0CB01# |
|        |               |         | 5.1pF | ±0.25pF | GQM22M5C2H5R1CB01# |
|        |               |         |       | ±0.5pF  | GQM22M5C2H5R1DB01# |
|        |               |         | 5.6pF | ±0.25pF | GQM22M5C2H5R6CB01# |
|        |               |         |       | ±0.5pF  | GQM22M5C2H5R6DB01# |
|        |               |         | 6.0pF | ±0.25pF | GQM22M5C2H6R0CB01# |
|        |               |         |       | ±0.5pF  | GQM22M5C2H6R0DB01# |
|        |               |         | 6.2pF | ±0.25pF | GQM22M5C2H6R2CB01# |
|        |               |         |       | ±0.5pF  | GQM22M5C2H6R2DB01# |

| T max. | Rated Voltage | TC Code            | Cap.  | Tol.    | Part Number        |
|--------|---------------|--------------------|-------|---------|--------------------|
| 1.35mm | 500Vdc        | C0G                | 6.8pF | ±0.25pF | GQM22M5C2H6R8CB01# |
|        |               |                    |       | ±0.5pF  | GQM22M5C2H6R8DB01# |
|        |               |                    | 7.0pF | ±0.25pF | GQM22M5C2H7R0CB01# |
|        |               |                    |       | ±0.5pF  | GQM22M5C2H7R0DB01# |
|        |               |                    | 7.5pF | ±0.25pF | GQM22M5C2H7R5CB01# |
|        |               |                    |       | ±0.5pF  | GQM22M5C2H7R5DB01# |
|        |               |                    | 8.0pF | ±0.25pF | GQM22M5C2H8R0CB01# |
|        |               |                    |       | ±0.5pF  | GQM22M5C2H8R0DB01# |
|        |               |                    | 8.2pF | ±0.25pF | GQM22M5C2H8R2CB01# |
|        |               |                    |       | ±0.5pF  | GQM22M5C2H8R2DB01# |
|        |               |                    | 9.0pF | ±0.25pF | GQM22M5C2H9R0CB01# |
|        |               |                    |       | ±0.5pF  | GQM22M5C2H9R0DB01# |
|        |               |                    | 9.1pF | ±0.25pF | GQM22M5C2H9R1CB01# |
|        |               |                    |       | ±0.5pF  | GQM22M5C2H9R1DB01# |
|        |               |                    | 10pF  | ±2%     | GQM22M5C2H100GB01# |
|        |               |                    |       | ±5%     | GQM22M5C2H100JB01# |
|        |               |                    | 11pF  | ±2%     | GQM22M5C2H110GB01# |
|        |               |                    |       | ±5%     | GQM22M5C2H110JB01# |
|        |               |                    | 12pF  | ±2%     | GQM22M5C2H120GB01# |
|        |               |                    |       | ±5%     | GQM22M5C2H120JB01# |
|        |               |                    | 13pF  | ±2%     | GQM22M5C2H130GB01# |
|        |               |                    |       | ±5%     | GQM22M5C2H130JB01# |
|        |               |                    | 15pF  | ±2%     | GQM22M5C2H150GB01# |
|        |               |                    |       | ±5%     | GQM22M5C2H150JB01# |
|        |               |                    | 16pF  | ±2%     | GQM22M5C2H160GB01# |
|        |               |                    |       | ±5%     | GQM22M5C2H160JB01# |
|        |               |                    | 18pF  | ±2%     | GQM22M5C2H180GB01# |
|        |               |                    |       | ±5%     | GQM22M5C2H180JB01# |
|        |               |                    | 20pF  | ±2%     | GQM22M5C2H200GB01# |
|        |               |                    |       | ±5%     | GQM22M5C2H200JB01# |
|        |               |                    | 22pF  | ±2%     | GQM22M5C2H220GB01# |
|        |               |                    |       | ±5%     | GQM22M5C2H220JB01# |
|        |               |                    | 24pF  | ±2%     | GQM22M5C2H240GB01# |
|        |               |                    |       | ±5%     | GQM22M5C2H240JB01# |
|        |               |                    | 27pF  | ±2%     | GQM22M5C2H270GB01# |
|        |               |                    |       | ±5%     | GQM22M5C2H270JB01# |
| 30pF   | ±2%           | GQM22M5C2H300GB01# |       |         |                    |
|        | ±5%           | GQM22M5C2H300JB01# |       |         |                    |
| 33pF   | ±2%           | GQM22M5C2H330GB01# |       |         |                    |
|        | ±5%           | GQM22M5C2H330JB01# |       |         |                    |
| 36pF   | ±2%           | GQM22M5C2H360GB01# |       |         |                    |
|        | ±5%           | GQM22M5C2H360JB01# |       |         |                    |
| 39pF   | ±2%           | GQM22M5C2H390GB01# |       |         |                    |
|        | ±5%           | GQM22M5C2H390JB01# |       |         |                    |
| 43pF   | ±2%           | GQM22M5C2H430GB01# |       |         |                    |
|        | ±5%           | GQM22M5C2H430JB01# |       |         |                    |
| 47pF   | ±2%           | GQM22M5C2H470GB01# |       |         |                    |
|        | ±5%           | GQM22M5C2H470JB01# |       |         |                    |
| 51pF   | ±2%           | GQM22M5C2H510GB01# |       |         |                    |
|        | ±5%           | GQM22M5C2H510JB01# |       |         |                    |
| 56pF   | ±2%           | GQM22M5C2H560GB01# |       |         |                    |
|        | ±5%           | GQM22M5C2H560JB01# |       |         |                    |
| 62pF   | ±2%           | GQM22M5C2H620GB01# |       |         |                    |
|        | ±5%           | GQM22M5C2H620JB01# |       |         |                    |

Part number # indicates the package specification code.

GRM Series  
GJM Series  
GMA Series  
GMD Series  
GQM Series  
GRJ Series  
GR3 Series  
KRM Series  
KR3 Series  
LLA Series  
LLL Series  
LLM Series  
LLR Series  
⚠Caution/ Notice

## GQM Series Temperature Compensating Type High Q Part Number List

(→ ■ 2.8x2.8mm)

| T max. | Rated Voltage | TC Code | Cap.  | Tol. | Part Number        |
|--------|---------------|---------|-------|------|--------------------|
| 1.35mm | 500Vdc        | C0G     | 68pF  | ±2%  | GQM22M5C2H680GB01# |
|        |               |         |       | ±5%  | GQM22M5C2H680JB01# |
|        |               |         | 75pF  | ±2%  | GQM22M5C2H750GB01# |
|        |               |         |       | ±5%  | GQM22M5C2H750JB01# |
|        |               |         | 82pF  | ±2%  | GQM22M5C2H820GB01# |
|        |               |         |       | ±5%  | GQM22M5C2H820JB01# |
|        |               |         | 91pF  | ±2%  | GQM22M5C2H910GB01# |
|        |               |         |       | ±5%  | GQM22M5C2H910JB01# |
|        |               |         | 100pF | ±2%  | GQM22M5C2H101GB01# |
|        |               |         |       | ±5%  | GQM22M5C2H101JB01# |

GRM Series

GJM Series

GMA Series

GMD Series

GQM Series

GRJ Series

GR3 Series

KRM Series

KR3 Series

LLA Series

LLL Series

LLM Series

LLR Series

⚠Caution/  
Notice

Part number # indicates the package specification code.

## Resin External Electrode Type

# GRJ Series



Deflecting crack

The resin external electrodes prevent the occurrence of cracking caused by deflection stress after board mounting!

### Features

#### 1 The resin external electrodes suppress cracks by board deflection.

Cracking of the ceramic element is suppressed by the resin of the external electrodes, which releases the stress.

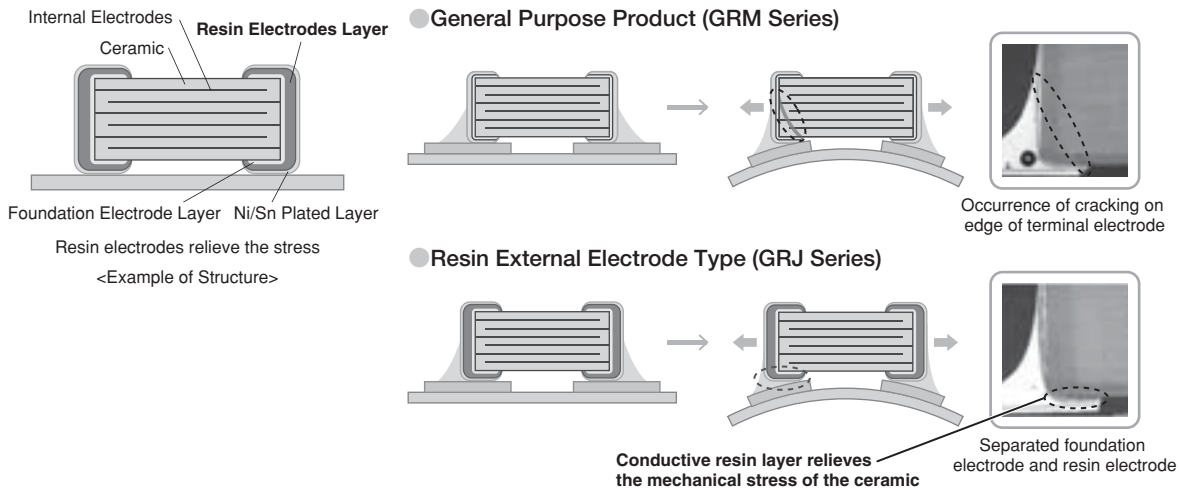

#### 2 Suppresses the occurrence of cracking caused by deflection stress at the time of board mounting, etc.

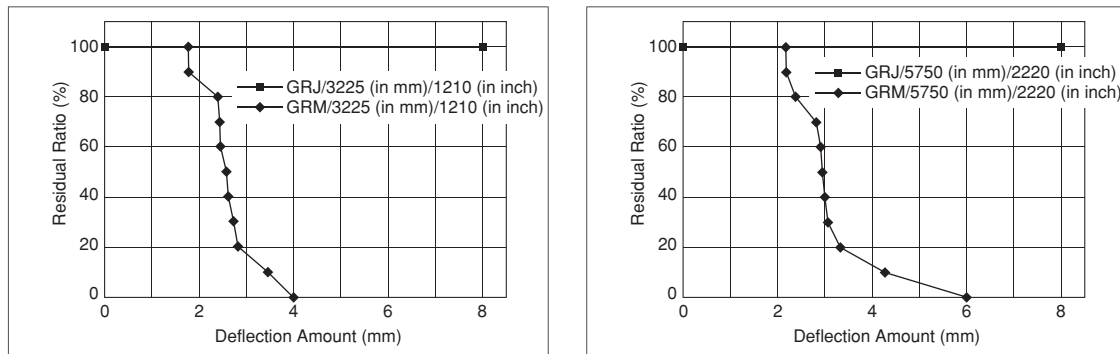

Due to the specification of the measuring instrument, measurements can be performed up to 8mm.

#### 3 Ideal for consumer and industrial electronic equipment, etc. where there heat stress, vibration and impact are applied.

### Specifications

|                   |  |
|-------------------|--|
| Size              | 2.0×1.25mm to 5.7×5.0mm                    |
| Rated Voltage     | DC6.3V to 1kV                              |
| Capacitance       | 470pF to 47μF                              |
| Main Applications | Consumer & Industrial Electronic Equipment |

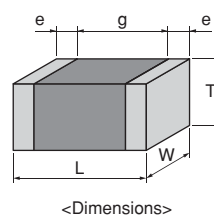

This catalog contains only a portion of the product lineup.  
 Please refer to the capacitor search tool on the Murata Web site for details.

# GRJ Series High Dielectric Constant Type Part Number List

## ■ 2.0x1.25mm

| T max. | Rated Voltage | TC Code | Cap.    | Tol. | Part Number        |
|--------|---------------|---------|---------|------|--------------------|
| 1.0mm  | 250Vdc        | X7R     | 1000pF  | ±10% | GRJ21AR72E102KWJ1# |
|        |               |         | 1500pF  | ±10% | GRJ21AR72E152KWJ1# |
|        |               |         | 2200pF  | ±10% | GRJ21AR72E222KWJ1# |
|        |               |         | 3300pF  | ±10% | GRJ21AR72E332KWJ1# |
|        |               |         | 4700pF  | ±10% | GRJ21AR72E472KWJ1# |
|        |               |         | 6800pF  | ±10% | GRJ21AR72E682KWJ1# |
| 1.45mm | 250Vdc        | X7R     | 10000pF | ±10% | GRJ21BR72E103KWJ3# |
|        |               |         | 15000pF | ±10% | GRJ21BR72E153KWJ3# |
|        |               |         | 22000pF | ±10% | GRJ21BR72E223KWJ3# |

## ■ 3.2x1.6mm

| T max. | Rated Voltage | TC Code | Cap.    | Tol.               | Part Number        |
|--------|---------------|---------|---------|--------------------|--------------------|
| 1.25mm | 1000Vdc       | X7R     | 470pF   | ±10%               | GRJ31BR73A471KWJ1# |
|        |               |         | 680pF   | ±10%               | GRJ31BR73A681KWJ1# |
|        |               |         | 1000pF  | ±10%               | GRJ31BR73A102KWJ1# |
|        |               |         | 1500pF  | ±10%               | GRJ31BR73A152KWJ1# |
|        |               |         | 2200pF  | ±10%               | GRJ31BR73A222KWJ1# |
|        |               |         | 3300pF  | ±10%               | GRJ31BR73A332KWJ1# |
|        |               |         | 4700pF  | ±10%               | GRJ31BR73A472KWJ1# |
|        | 630Vdc        | X7R     | 1000pF  | ±10%               | GRJ31BR72J102KWJ1# |
|        |               |         | 1500pF  | ±10%               | GRJ31BR72J152KWJ1# |
|        |               |         | 2200pF  | ±10%               | GRJ31BR72J222KWJ1# |
|        |               |         | 3300pF  | ±10%               | GRJ31BR72J332KWJ1# |
|        |               |         | 4700pF  | ±10%               | GRJ31BR72J472KWJ1# |
|        |               |         | 6800pF  | ±10%               | GRJ31BR72J682KWJ1# |
|        |               |         | 10000pF | ±10%               | GRJ31BR72J103KWJ1# |
| 250Vdc | X7R           | 15000pF | ±10%    | GRJ31BR72E153KWJ1# |                    |
|        |               | 22000pF | ±10%    | GRJ31BR72E223KWJ1# |                    |
|        |               | 68000pF | ±10%    | GRJ31BR72E683KWJ1# |                    |
| 1.8mm  | 1000Vdc       | X7R     | 6800pF  | ±10%               | GRJ31CR73A682KWJ3# |
|        |               |         | 10000pF | ±10%               | GRJ31CR73A103KWJ3# |
|        |               |         | 15000pF | ±10%               | GRJ31CR72J153KWJ3# |
|        | 630Vdc        | X7R     | 22000pF | ±10%               | GRJ31CR72J223KWJ3# |
|        |               |         | 33000pF | ±10%               | GRJ31CR72E333KWJ3# |
|        |               |         | 47000pF | ±10%               | GRJ31CR72E473KWJ3# |
|        |               |         | 0.10μF  | ±10%               | GRJ31CR72E104KWJ3# |

## ■ 3.2x2.5mm

| T max. | Rated Voltage | TC Code | Cap.    | Tol. | Part Number        |                    |                    |
|--------|---------------|---------|---------|------|--------------------|--------------------|--------------------|
| 1.5mm  | 1000Vdc       | X7R     | 6800pF  | ±10% | GRJ32QR73A682KWJ1# |                    |                    |
|        |               |         | 10000pF | ±10% | GRJ32QR73A103KWJ1# |                    |                    |
|        | 630Vdc        | X7R     | 22000pF | ±10% | GRJ32QR72J223KWJ1# |                    |                    |
|        |               |         | 250Vdc  | X7R  | 68000pF            | ±10%               | GRJ32QR72E683KWJ1# |
|        |               |         | 0.15μF  |      | ±10%               | GRJ32QR72E154KWJ1# |                    |
| 2.0mm  | 1000Vdc       | X7R     | 15000pF | ±10% | GRJ32DR73A153KWJ1# |                    |                    |
|        |               |         | 22000pF | ±10% | GRJ32DR73A223KWJ1# |                    |                    |
|        | 630Vdc        | X7R     | 33000pF | ±10% | GRJ32DR72J333KWJ1# |                    |                    |
|        |               |         | 47000pF | ±10% | GRJ32DR72J473KWJ1# |                    |                    |

| T max. | Rated Voltage | TC Code            | Cap.   | Tol.  | Part Number        |      |                    |
|--------|---------------|--------------------|--------|-------|--------------------|------|--------------------|
| 2.0mm  | 250Vdc        | X7R                | 0.10μF | ±10%  | GRJ32DR72E104KWJ1# |      |                    |
|        |               |                    | 0.22μF | ±10%  | GRJ32DR72E224KWJ1# |      |                    |
| 2.3mm  | 100Vdc        | X7R                | 2.2μF  | ±10%  | GRJ32DR72A225KE11# |      |                    |
|        |               |                    |        | ±20%  | GRJ32DR72A225ME11# |      |                    |
| 2.8mm  | 50Vdc         | X7R                | 4.7μF  | ±10%  | GRJ32ER71H475KE11# |      |                    |
|        |               |                    |        | ±20%  | GRJ32ER71H475ME11# |      |                    |
|        |               |                    |        | X7S   | 10μF               | ±10% | GRJ32EC71H106KE11# |
|        |               |                    |        |       |                    | ±20% | GRJ32EC71H106ME11# |
|        |               |                    |        | 25Vdc | X7R                | 10μF | ±10%               |
|        | ±20%          | GRJ32ER71E106ME11# |        |       |                    |      |                    |
|        | 16Vdc         | X7R                | 22μF   |       |                    |      | ±10%               |
|        |               |                    |        | ±20%  | GRJ32ER71C226ME11# |      |                    |
|        | 10Vdc         | X7R                | 22μF   | ±10%  | GRJ32ER71A226KE11# |      |                    |
|        |               |                    |        | ±20%  | GRJ32ER71A226ME11# |      |                    |
| 6.3Vdc |               |                    |        | X7R   | 47μF               | ±10% | GRJ32ER70J476KE11# |
|        |               |                    |        |       |                    | ±20% | GRJ32ER70J476ME11# |

## ■ 4.5x3.2mm

| T max. | Rated Voltage | TC Code | Cap.    | Tol. | Part Number        |
|--------|---------------|---------|---------|------|--------------------|
| 1.5mm  | 630Vdc        | X7R     | 68000pF | ±10% | GRJ43QR72J683KWJ1# |
|        | 250Vdc        | X7R     | 0.15μF  | ±10% | GRJ43QR72E154KWJ1# |
| 2.0mm  | 1000Vdc       | X7R     | 33000pF | ±10% | GRJ43DR73A333KWJ1# |
|        |               |         | 47000pF | ±10% | GRJ43DR73A473KWJ1# |
|        | 630Vdc        | X7R     | 0.10μF  | ±10% | GRJ43DR72J104KWJ1# |
|        |               |         |         | ±20% | GRJ43DR72E224KWJ1# |
|        | 250Vdc        | X7R     | 0.33μF  | ±10% | GRJ43DR72E334KWJ1# |
|        |               |         |         | ±20% | GRJ43DR72E474KWJ1# |

## ■ 5.7x5.0mm

| T max. | Rated Voltage | TC Code | Cap.    | Tol. | Part Number        |
|--------|---------------|---------|---------|------|--------------------|
| 2.0mm  | 1000Vdc       | X7R     | 68000pF | ±10% | GRJ55DR73A683KWJ1# |
|        |               |         | 0.10μF  | ±10% | GRJ55DR73A104KWJ1# |
|        | 630Vdc        | X7R     | 0.15μF  | ±10% | GRJ55DR72J154KWJ1# |
|        |               |         | 0.22μF  | ±10% | GRJ55DR72J224KWJ1# |
|        | 250Vdc        | X7R     | 0.33μF  | ±10% | GRJ55DR72E334KWJ1# |
|        |               |         |         | ±20% | GRJ55DR72E474KWJ1# |
|        |               |         | 0.47μF  | ±10% | GRJ55DR72E474KWJ1# |
|        |               |         |         | ±20% | GRJ55DR72E684KWJ1# |
|        |               |         | 1.0μF   | ±10% | GRJ55DR72E105KWJ1# |
|        |               |         |         | ±20% | GRJ55DR72E105KWJ1# |

Part number # indicates the package specification code.

GRM Series  
GJM Series  
GMA Series  
GMD Series  
GQM Series  
GRJ Series  
GR3 Series  
KRM Series  
KR3 Series  
LLA Series  
LLL Series  
LLM Series  
LLR Series  
⚠Caution/ Notice

High Effective Capacitance & High Allowable Ripple Current

**GR3 Series**  **Anti-noise**

This is a general purpose high ripple resistance product excellent in DC bias characteristics.

Features

① When a DC bias is applied, a capacitance higher than conventional products (X7R characteristics) can be acquired.

About twice the capacitance can be secured when DC200V is applied.

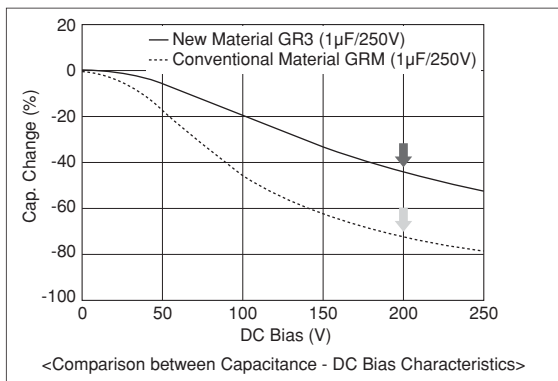

② Improved ripple resistance performance compared to conventional products (X7R characteristics).

In the case of a product with a capacitance of 1μF, when the exothermic temperature reaches 20°C at frequency f=300kHz, the amount of resistance of a product with conventional material is 2.9Ar.m.s.; however, the new material is 4.7Ar.m.s..

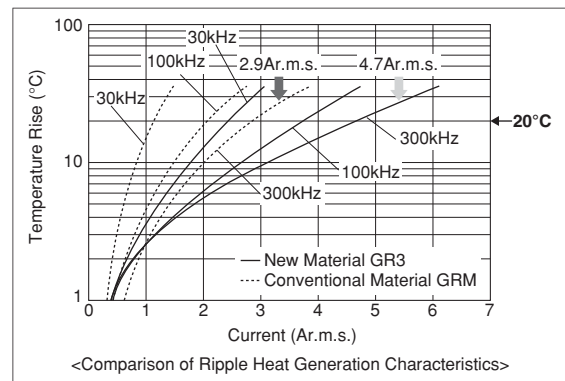

③ This product has a noise reduction effect.

Since dielectric materials which enable a reduction of noise are used, this product is more effective for reducing noise compared to the general purpose GRM series.

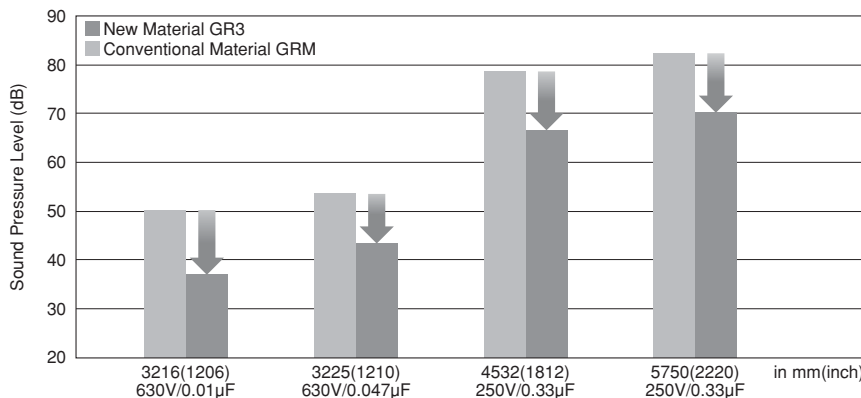

Specifications

|                   |  |
|-------------------|--|
| Size              | 2.0×1.25mm to 5.7×5.0mm  |
| Rated Voltage     | DC250V to 630V   |
| Capacitance       | 0.01μF to 1.0μF  |
| Main Applications | For PFC (Power Factor Correction) Circuits of Power Supplies, EMI Suppression and Smoothing Circuits |

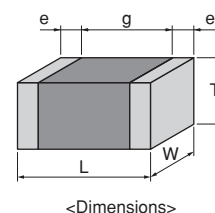

This catalog contains only a portion of the product lineup. Please refer to the capacitor search tool on the Murata Web site for details.

GRM Series  
GJM Series  
GMA Series  
GMD Series  
GQM Series  
GRJ Series  
GR3 Series  
KRM Series  
KR3 Series  
LLA Series  
LLL Series  
LLM Series  
LLR Series  
⚠Caution/Notice

## GR3 Series High Dielectric Constant Type Anti-noise Part Number List

### ■ 2.0×1.25mm

| T max. | Rated Voltage | TC Code | Cap.    | Tol. | Part Number        |
|--------|---------------|---------|---------|------|--------------------|
| 1.0mm  | 250Vdc        | X7T     | 10000pF | ±10% | GR321AD72E103KW01# |
|        |               |         | 15000pF | ±10% | GR321AD72E153KW01# |
| 1.45mm | 250Vdc        | X7T     | 22000pF | ±10% | GR321BD72E223KW03# |

### ■ 3.2×1.6mm

| T max. | Rated Voltage | TC Code | Cap.    | Tol. | Part Number        |
|--------|---------------|---------|---------|------|--------------------|
| 1.0mm  | 450Vdc        | X7T     | 10000pF | ±10% | GR331AD72W103KW01# |
|        |               |         | 15000pF | ±10% | GR331AD72W153KW01# |
|        | 250Vdc        | X7T     | 33000pF | ±10% | GR331AD72E333KW01# |
| 1.25mm | 630Vdc        | X7T     | 10000pF | ±10% | GR331BD72J103KW01# |
|        |               |         | 22000pF | ±10% | GR331BD72W223KW01# |
|        | 250Vdc        | X7T     | 33000pF | ±10% | GR331BD72W333KW01# |
|        |               |         | 47000pF | ±10% | GR331BD72E473KW01# |
| 1.8mm  | 630Vdc        | X7T     | 15000pF | ±10% | GR331CD72J153KW03# |
|        |               |         | 47000pF | ±10% | GR331CD72W473KW03# |
|        | 250Vdc        | X7T     | 68000pF | ±10% | GR331CD72E683KW03# |

### ■ 3.2×2.5mm

| T max. | Rated Voltage | TC Code | Cap.    | Tol. | Part Number        |
|--------|---------------|---------|---------|------|--------------------|
| 1.5mm  | 630Vdc        | X7T     | 22000pF | ±10% | GR332QD72J223KW01# |
|        |               |         | 0.10μF  | ±10% | GR332QD72E104KW01# |
| 2.0mm  | 630Vdc        | X7T     | 33000pF | ±10% | GR332DD72J333KW01# |
|        |               |         | 47000pF | ±10% | GR332DD72J473KW01# |
|        | 450Vdc        | X7T     | 68000pF | ±10% | GR332DD72W683KW01# |
|        |               |         | 0.10μF  | ±10% | GR332DD72W104KW01# |
|        | 250Vdc        | X7T     | 0.15μF  | ±10% | GR332DD72E154KW01# |

### ■ 4.5×3.2mm

| T max. | Rated Voltage | TC Code | Cap.    | Tol. | Part Number        |
|--------|---------------|---------|---------|------|--------------------|
| 1.5mm  | 250Vdc        | X7T     | 0.22μF  | ±10% | GR343QD72E224KW01# |
| 2.0mm  | 630Vdc        | X7T     | 68000pF | ±10% | GR343DD72J683KW01# |
|        |               |         | 0.15μF  | ±10% | GR343DD72W154KW01# |
|        | 250Vdc        | X7T     | 0.33μF  | ±10% | GR343DD72E334KW01# |

### ■ 5.7×5.0mm

| T max. | Rated Voltage | TC Code | Cap.   | Tol.               | Part Number        |
|--------|---------------|---------|--------|--------------------|--------------------|
| 2.0mm  | 630Vdc        | X7T     | 0.10μF | ±10%               | GR355DD72J104KW01# |
|        |               |         | 0.15μF | ±10%               | GR355DD72J154KW01# |
|        | 450Vdc        | X7T     | 0.22μF | ±10%               | GR355DD72W224KW01# |
|        |               |         | 0.33μF | ±10%               | GR355DD72W334KW01# |
|        |               |         | 0.47μF | ±10%               | GR355DD72W474KW01# |
|        | 250Vdc        | X7T     | 0.47μF | ±10%               | GR355DD72E474KW01# |
| 0.68μF |               |         | ±10%   | GR355DD72E684KW01# |                    |
| 2.7mm  | 630Vdc        | X7T     | 0.22μF | ±10%               | GR355XD72J224KW05# |

| T max. | Rated Voltage | TC Code | Cap.   | Tol. | Part Number        |
|--------|---------------|---------|--------|------|--------------------|
| 2.7mm  | 630Vdc        | X7T     | 0.27μF | ±10% | GR355XD72J274KW05# |
|        | 450Vdc        | X7T     | 0.56μF | ±10% | GR355XD72W564KW05# |
|        | 250Vdc        | X7T     | 1.0μF  | ±10% | GR355XD72E105KW05# |

Part number # indicates the package specification code.

GRM Series  
 GJM Series  
 GMA Series  
 GMD Series  
 GQM Series  
 GRJ Series  
 GR3 Series  
 KRM Series  
 KR3 Series  
 LLA Series  
 LLL Series  
 LLM Series  
 LLR Series  
 ⚠Caution/  
 Notice



## Metal Terminal Type For General Purpose

# KRM Series



**Anti-noise** **Deflecting crack** **Soldering crack**

**Bonding the metal terminals to external electrodes solves design issues by mounting large size MLCC!**

### Features

#### ① Bond metal terminals to the external electrodes of chips.

The stress applied to the chip is relieved by the elastic action of the metal terminal.

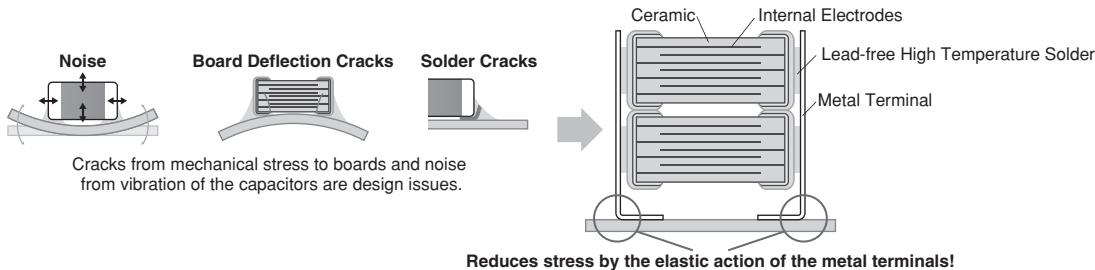

#### ② Substantially reduces noise, board deflection cracks and soldering cracks.

This product is not damaged even with a board deflection of 6 mm.

Solder cracks do not occur even with 2,000 cycles of heat stress.

##### ● Acoustic Noise is Reduced with Metal Terminals

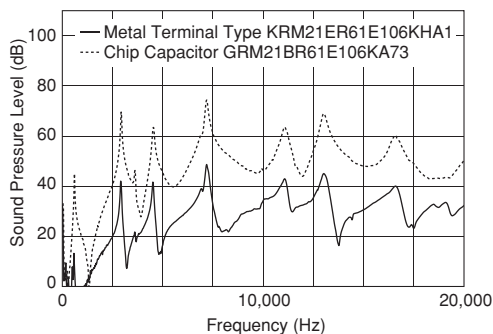

##### ● Reduces Stress Caused by Board Deflection

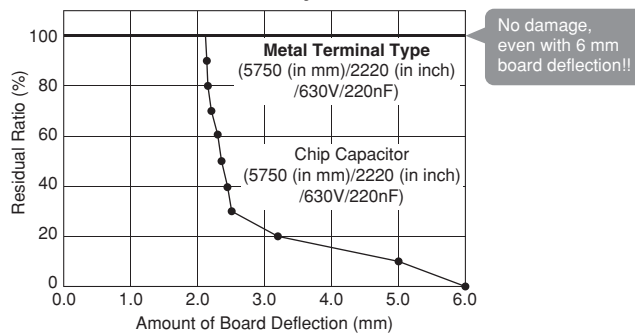

##### ● Suppresses Solder Cracks Caused by Heat Stress

| Chip Size  | Chip Only<br>(5750 (in mm)/2220 (in inch) size) | Metal Terminal Type<br>(5750 (in mm)/2220 (in inch) size) |
|------------|---|---|
| 1000 Cycle | <br>↑Solder Crack                               |   |
| 2000 Cycle | <br>↑Solder Crack                               |   |

Compared with chips only, this product is excellent in solder cracking resistance.

Test Condition: -55 to +125°C, 5min.,(Tank)  
 Board Used: Glass Epoxy Board (FR-4)

Demonstrates replacement value of low noise capacitors Experience the effectiveness of the KRM Series.

▶ Examples of Noise Countermeasures

GRM Series

GJM Series

GMA Series

GMD Series

GQM Series

GRJ Series

GR3 Series

KRM Series

KR3 Series

LLA Series

LLL Series

LLM Series

LLR Series

⚠Caution/  
Notice

③ **2 chips can be stacked.**

Realize large capacity by stacking 2 capacitors.

Specifications

|                   |   |
|-------------------|---|
| Size              | 2.2×1.25mm to 6.1×5.3mm                                 |
| Rated Voltage     | DC16V to 1kV  |
| Capacitance       | 0.068μF to 68μF   |
| Main Applications | For smoothing and noise suppression of DC-DC converters |

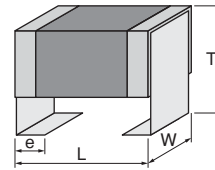

<Dimensions>

This catalog contains only a portion of the product lineup.  
 Please refer to the capacitor search tool on the Murata Web site for details.

# KRM Series High Dielectric Constant Type Anti-noise Deflecting crack Soldering crack Part Number List

## ■ 3.5×1.7mm

| T max. | Rated Voltage | TC Code | Cap.  | Tol. | Part Number        |
|--------|---------------|---------|-------|------|--------------------|
| 2.0mm  | 25Vdc         | X5R     | 10μF  | ±10% | KRM31FR61E106KH01# |
| 2.9mm  | 100Vdc        | X7R     | 1.0μF | ±10% | KRM31KR72A105KH01# |
|        | 50Vdc         | X7R     | 4.7μF | ±10% | KRM31KR71H475KH01# |
|        | 35Vdc         | X6S     | 10μF  | ±10% | KRM31KC8YA106KH01# |
|        | 25Vdc         | X6S     | 10μF  | ±10% | KRM31KC81E106KH01# |

| T max. | Rated Voltage | TC Code | Cap. | Tol. | Part Number        |
|--------|---------------|---------|------|------|--------------------|
| 5.0mm  | 25Vdc         | X7R     | 33μF | ±20% | KRM55TR71E336MH01# |
| 6.7mm  | 100Vdc        | X7R     | 15μF | ±20% | KRM55WR72A156MH01# |
|        | 63Vdc         | X7R     | 22μF | ±20% | KRM55WR71J226MH01# |
|        | 50Vdc         | X7R     | 33μF | ±20% | KRM55WR71H336MH01# |
|        | 35Vdc         | X7R     | 47μF | ±20% | KRM55WR7YA476MH01# |
|        | 25Vdc         | X7R     | 47μF | ±20% | KRM55WR71E476MH01# |
|        |               |         | 68μF | ±20% | KRM55WR71E686MH01# |

## ■ 3.6×1.7mm

| T max. | Rated Voltage | TC Code | Cap.  | Tol. | Part Number        |
|--------|---------------|---------|-------|------|--------------------|
| 2.9mm  | 50Vdc         | X7R     | 2.2μF | ±10% | KRM31KR71H225KH01# |

## ■ 3.7×1.85mm

| T max. | Rated Voltage | TC Code | Cap.  | Tol. | Part Number        |
|--------|---------------|---------|-------|------|--------------------|
| 2.9mm  | 100Vdc        | X7R     | 2.2μF | ±10% | KRM31KR72A225KH01# |

## ■ 6.1×5.3mm

| T max. | Rated Voltage | TC Code | Cap.    | Tol.               | Part Number        |
|--------|---------------|---------|---------|--------------------|--------------------|
| 3.0mm  | 1000Vdc       | X7R     | 68000pF | ±10%               | KRM55LR73A683KH01# |
|        |               |         | 0.10μF  | ±10%               | KRM55LR73A104KH01# |
|        | 630Vdc        | X7R     | 0.15μF  | ±10%               | KRM55LR72J154KH01# |
|        |               |         | 0.22μF  | ±10%               | KRM55LR72J224KH01# |
|        | 250Vdc        | X7R     | 0.68μF  | ±10%               | KRM55LR72E684KH01# |
|        |               |         | 1.0μF   | ±10%               | KRM55LR72E105KH01# |
|        | 100Vdc        | X7R     | 4.7μF   | ±10%               | KRM55LR72A475KH01# |
|        | 63Vdc         | X7R     | 4.7μF   | ±10%               | KRM55LR71J475KH01# |
|        | 50Vdc         | X7R     | 4.7μF   | ±10%               | KRM55LR71H475KH01# |
|        |               |         | 10μF    | ±10%               | KRM55LR71H106KH01# |
|        | 35Vdc         | X7R     | 10μF    | ±10%               | KRM55LR7YA106KH01# |
|        |               |         | 15μF    | ±10%               | KRM55LR7YA156KH01# |
| 25Vdc  | X7R           | 15μF    | ±10%    | KRM55LR71E156KH01# |                    |
| 3.9mm  | 100Vdc        | X7R     | 6.8μF   | ±10%               | KRM55QR72A685KH01# |
|        | 63Vdc         | X7R     | 10μF    | ±10%               | KRM55QR71J106KH01# |
|        | 50Vdc         | X7R     | 17μF    | ±10%               | KRM55QR71H176KH01# |
|        | 35Vdc         | X7R     | 17μF    | ±10%               | KRM55QR7YA176KH01# |
|        |               |         | 22μF    | ±10%               | KRM55QR7YA226KH01# |
|        | 25Vdc         | X7R     | 22μF    | ±10%               | KRM55QR71E226KH01# |
| 33μF   |               |         | ±10%    | KRM55QR71E336KH01# |                    |
| 5.0mm  | 1000Vdc       | X7R     | 0.15μF  | ±20%               | KRM55TR73A154MH01# |
|        |               |         | 0.22μF  | ±20%               | KRM55TR73A224MH01# |
|        | 630Vdc        | X7R     | 0.33μF  | ±20%               | KRM55TR72J334MH01# |
|        |               |         | 0.47μF  | ±20%               | KRM55TR72J474MH01# |
|        |               |         | 1.5μF   | ±20%               | KRM55TR72E155MH01# |
|        | 250Vdc        | X7R     | 2.2μF   | ±20%               | KRM55TR72E225MH01# |
|        |               |         | 10μF    | ±20%               | KRM55TR72A106MH01# |
|        | 100Vdc        | X7R     | 10μF    | ±20%               | KRM55TR72A106MH01# |
|        | 50Vdc         | X7R     | 22μF    | ±20%               | KRM55TR71H226MH01# |
|        | 35Vdc         | X7R     | 22μF    | ±20%               | KRM55TR7YA226MH01# |
| 33μF   |               |         | ±20%    | KRM55TR7YA336MH01# |                    |

Part number # indicates the package specification code.

GRM Series  
GJM Series  
GMA Series  
GMD Series  
GQM Series  
GRJ Series  
GR3 Series  
KRM Series  
KR3 Series  
LLA Series  
LLL Series  
LLM Series  
LLR Series  
⚠Caution/Notice

GRM Series

GJM Series

GMA Series

GMD Series

GQM Series

GRJ Series

GR3 Series

KRM Series

KR3 Series

LLA Series

LLL Series

LLM Series

LLR Series

⚠Caution/  
Notice

## Metal Terminal Type High Effective Capacitance & High Allowable Ripple Current

# KR3 Series



**Anti-noise** **Deflecting crack** **Soldering crack**

**Bonding the metal terminals to external electrodes solves design issues by mounting large size MLCC!**

### Features

#### 1 Bond metal terminals to the external electrodes of chips.

The stress applied to the chip is relieved by the elastic action of the metal terminal.

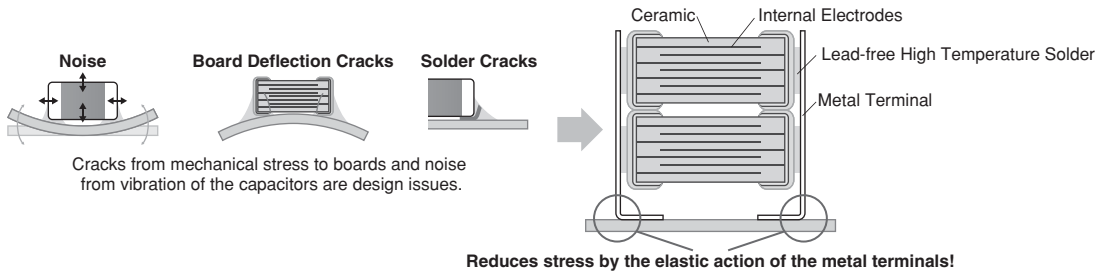

#### 2 Substantially reduces noise, board deflection cracks and soldering cracks.

This product is not damaged even with a board deflection of 6 mm.

Solder cracks do not occur even with 2,000 cycles of heat stress.

##### ● Comparison of Noise Reduction Effects

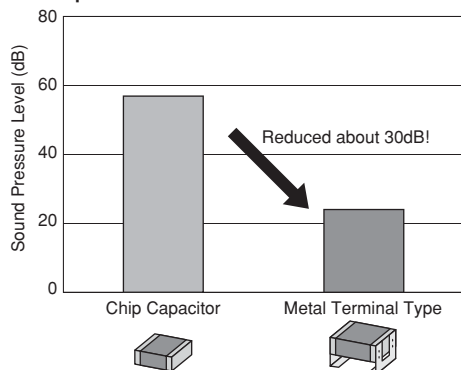

Evaluation Items: 5750 (in mm)/2220 (in inch) size/DC630V/220nF  
 Test Method: DC50V, AC10Vp-p/3kHz  
 Test Board: Glass Epoxy Board (T: 1.6mm)  
 Test Quantity: 3pc  
 Distance Between Microphone and Board: 3mm

Note: Results Using Murata's Evaluation Board

##### ● Reduces Stress Caused by Board Deflection

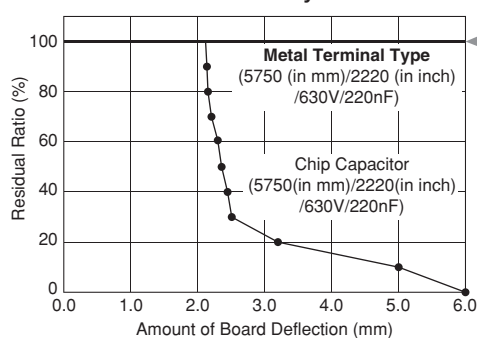

##### ● Suppresses Solder Cracks Caused by Heat Stress

| Chip Size  | Chip Only<br>(5750 (in mm)/2220 (in inch) size) | Metal Terminal Type<br>(5750 (in mm)/2220 (in inch) size) |
|------------|---|---|
| 1000 Cycle | <br>↑Solder Crack                               |   |
| 2000 Cycle | <br>↑Solder Crack                               |   |

Compared with chips only, this product is excellent in solder cracking resistance.

Test Condition: -55 to +125°C, 5min.,(Tank)  
 Board Used: Glass Epoxy Board (FR-4)

### 3 Adopted Low Dielectric Constant Materials

Improved effective capacity and ripple resistant performance, compared to conventional products (X7R characteristics).

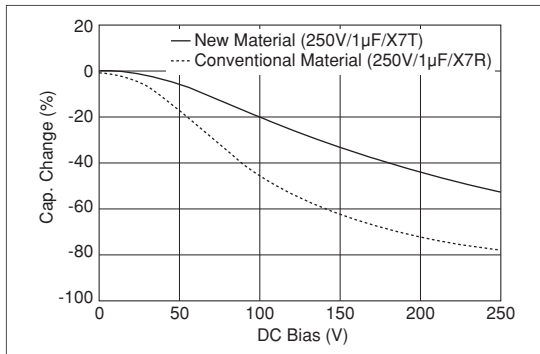

### Specifications

|                   |  |
|-------------------|--|
| Size              | 6.1×5.3mm  |
| Rated Voltage     | DC250V to 630V                                       |
| Capacitance       | 0.1µF to 2.2µF                                       |
| Main Applications | For DC-DC converters of general electronic equipment |

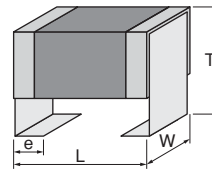

<Dimensions>

This catalog contains only a portion of the product lineup.  
 Please refer to the capacitor search tool on the Murata Web site for details.

- GRM Series
- GJM Series
- GMA Series
- GMD Series
- GQM Series
- GRJ Series
- GR3 Series
- KRM Series
- KR3 Series
- LLA Series
- LLL Series
- LLM Series
- LLR Series
- ⚠Caution/Notice

# KR3 Series High Dielectric Constant Type Anti-noise Deflecting crack Soldering crack Part Number List

## ■ 6.1×5.3mm

| T max. | Rated Voltage | TC Code | Cap.   | Tol.               | Part Number        |
|--------|---------------|---------|--------|--------------------|--------------------|
| 3.0mm  | 630Vdc        | X7T     | 0.10μF | ±10%               | KR355LD72J104KH01# |
|        |               |         | 0.15μF | ±10%               | KR355LD72J154KH01# |
|        | 450Vdc        | X7T     | 0.22μF | ±10%               | KR355LD72W224KH01# |
|        |               |         | 0.33μF | ±10%               | KR355LD72W334KH01# |
|        |               |         | 0.47μF | ±10%               | KR355LD72W474KH01# |
|        | 250Vdc        | X7T     | 0.47μF | ±10%               | KR355LD72E474KH01# |
| 0.68μF |               |         | ±10%   | KR355LD72E684KH01# |                    |
| 3.9mm  | 630Vdc        | X7T     | 0.22μF | ±10%               | KR355QD72J224KH01# |
|        |               |         | 0.27μF | ±10%               | KR355QD72J274KH01# |
|        | 450Vdc        | X7T     | 0.56μF | ±10%               | KR355QD72W564KH01# |
|        |               |         | 1.0μF  | ±10%               | KR355QD72E105KH01# |
|        | 250Vdc        | X7T     | 1.0μF  | ±10%               | KR355QD72E105KH01# |
|        |               |         | 1.5μF  | ±20%               | KR355TD72E155MH01# |
| 5.0mm  | 450Vdc        | X7T     | 0.68μF | ±20%               | KR355TD72W684MH01# |
|        |               |         | 1.0μF  | ±20%               | KR355TD72W105MH01# |
|        | 250Vdc        | X7T     | 1.5μF  | ±20%               | KR355TD72E155MH01# |
|        |               |         | 2.2μF  | ±20%               | KR355WD72E225MH01# |
| 6.7mm  | 630Vdc        | X7T     | 0.47μF | ±20%               | KR355WD72J474MH01# |
|        |               |         | 0.56μF | ±20%               | KR355WD72J564MH01# |
|        | 450Vdc        | X7T     | 1.2μF  | ±20%               | KR355WD72W125MH01# |
|        |               |         | 2.2μF  | ±20%               | KR355WD72E225MH01# |
|        | 250Vdc        | X7T     | 2.2μF  | ±20%               | KR355WD72E225MH01# |

GRM Series

GJM Series

GMA Series

GMD Series

GQM Series

GRJ Series

GR3 Series

KRM Series

KR3 Series

LLA Series

LLL Series

LLM Series

LLR Series

⚠Caution/  
Notice

8-Terminal Low ESL Type

LLA Series



8-Terminal Type Low ESL Capacitor Ideal for Power Supply Decoupling of High-speed Operation IC

Features

① Ultra-low ESL

Since the equivalent series inductance (ESL) is very low with excellent high frequency characteristics due to the design structure, this capacitor is ideal for power supply decoupling of high-speed operation IC.

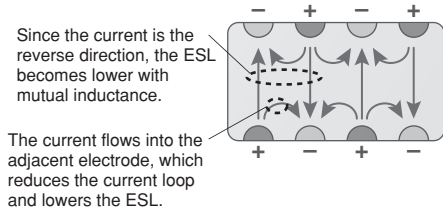
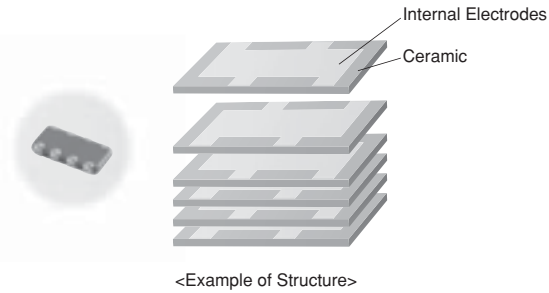

<Effectiveness of Cancelling Out Inductance by Mutual Inductance>

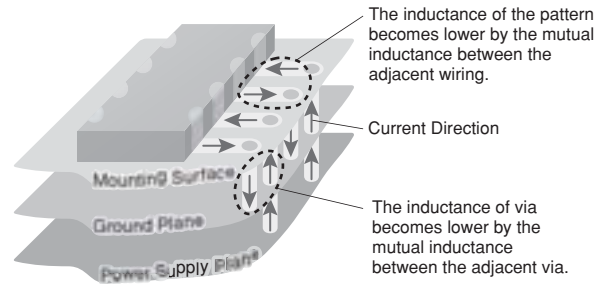

<Effectiveness of Suppressing Inductance when Mounting a Multi-terminal Capacitor>

The inductance for the boards also becomes lower, not only the capacitor.

② A maximum operating temperature up to 125°C.

This product is applicable to high temperatures (X7\* characteristics); however, Murata also offers numerous thin type products, which are ideal as decoupling capacitors on IC package.

Specifications

|                   |                               |
|-------------------|-------------------------------|
| Size              | 1.6×0.8mm to 3.2×1.6mm        |
| Rated Voltage     | DC4V to 25V                   |
| Capacitance       | 0.01μF to 4.7μF               |
| Main Applications | Application processor/CPU/GPU |

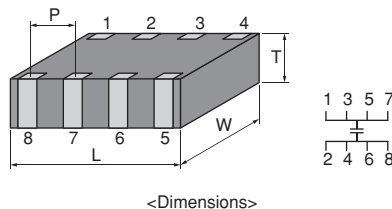

This catalog contains only a portion of the product lineup. Please refer to the capacitor search tool on the Murata Web site for details.

- GRM Series
- GJM Series
- GMA Series
- GMD Series
- GQM Series
- GRJ Series
- GR3 Series
- KRM Series
- KR3 Series
- LLA Series
- LLL Series
- LLM Series
- LLR Series
- ⚠Caution/Notice

# LLA Series High Dielectric Constant Type Low ESL Part Number List

## ■ 1.6×0.8mm

| T max. | Rated Voltage | TC Code | Cap.   | Tol. | Part Number        |
|--------|---------------|---------|--------|------|--------------------|
| 0.55mm | 4Vdc          | X7S     | 0.10μF | ±20% | LLA185C70G104MA01# |
|        |               |         | 0.22μF | ±20% | LLA185C70G224MA01# |
|        |               |         | 0.47μF | ±20% | LLA185C70G474MA01# |
|        |               |         | 2.2μF  | ±20% | LLA185C70G225ME16# |

## ■ 2.0×1.25mm

| T max. | Rated Voltage | TC Code | Cap.    | Tol. | Part Number        |
|--------|---------------|---------|---------|------|--------------------|
| 0.55mm | 25Vdc         | X7R     | 10000pF | ±20% | LLA215R71E103MA14# |
|        |               |         | 22000pF | ±20% | LLA215R71E223MA14# |
|        | 16Vdc         | X7R     | 47000pF | ±20% | LLA215R71C473MA14# |
|        |               |         | 0.10μF  | ±20% | LLA215R71C104MA14# |
|        | 10Vdc         | X7R     | 0.22μF  | ±20% | LLA215R71A224MA14# |
|        | 6.3Vdc        | X7R     | 0.47μF  | ±20% | LLA215R70J474MA14# |
|        | 4Vdc          | X7S     | 1.0μF   | ±20% | LLA215C70G105MA14# |
|        |               |         | 4.7μF   | ±20% | LLA215C70G475ME19# |
| 0.95mm | 25Vdc         | X7R     | 10000pF | ±20% | LLA219R71E103MA01# |
|        |               |         | 22000pF | ±20% | LLA219R71E223MA01# |
|        |               |         | 47000pF | ±20% | LLA219R71E473MA01# |
|        | 16Vdc         | X7R     | 0.10μF  | ±20% | LLA219R71C104MA01# |
|        |               |         | 0.22μF  | ±20% | LLA219R71C224MA01# |
|        | 10Vdc         | X7R     | 0.47μF  | ±20% | LLA219R71A474MA01# |
|        | 6.3Vdc        | X7R     | 1.0μF   | ±20% | LLA219R70J105MA01# |
|        | 4Vdc          | X7S     | 2.2μF   | ±20% | LLA219C70G225MA01# |

## ■ 3.2×1.6mm

| T max. | Rated Voltage | TC Code | Cap.   | Tol. | Part Number        |
|--------|---------------|---------|--------|------|--------------------|
| 0.55mm | 16Vdc         | X7R     | 0.22μF | ±20% | LLA315R71C224MA14# |
|        |               |         | 10Vdc  | X7R  | 0.47μF             |
|        | 6.3Vdc        | X7R     | 1.0μF  | ±20% | LLA315R70J105MA14# |
|        |               |         | 2.2μF  | ±20% | LLA315R70J225MA14# |
| 0.95mm | 16Vdc         | X7R     | 0.47μF | ±20% | LLA319R71C474MA01# |
|        | 10Vdc         | X7R     | 1.0μF  | ±20% | LLA319R71A105MA01# |
| 1.25mm | 16Vdc         | X7R     | 1.0μF  | ±20% | LLA31MR71C105MA01# |
|        | 10Vdc         | X7R     | 2.2μF  | ±20% | LLA31MR71A225MA01# |

GRM Series  
 GJM Series  
 GMA Series  
 GMD Series  
 GQM Series  
 GRJ Series  
 GR3 Series  
 KRM Series  
 KR3 Series  
 LLA Series  
 LLL Series  
 LLM Series  
 LLR Series  
 ⚠Caution/  
 Notice



## LW Reversed Low ESL Type

# LLL Series



Low  
ESL

This low ESL capacitor is ideal for power supply decoupling of high-speed operation electronic equipment.

### Features

#### 1 Low ESL

Since the equivalent series inductance (ESL) is low and excellent in high frequency characteristics, this capacitor is suitable for power supply decoupling of high-speed operation electronic equipment.

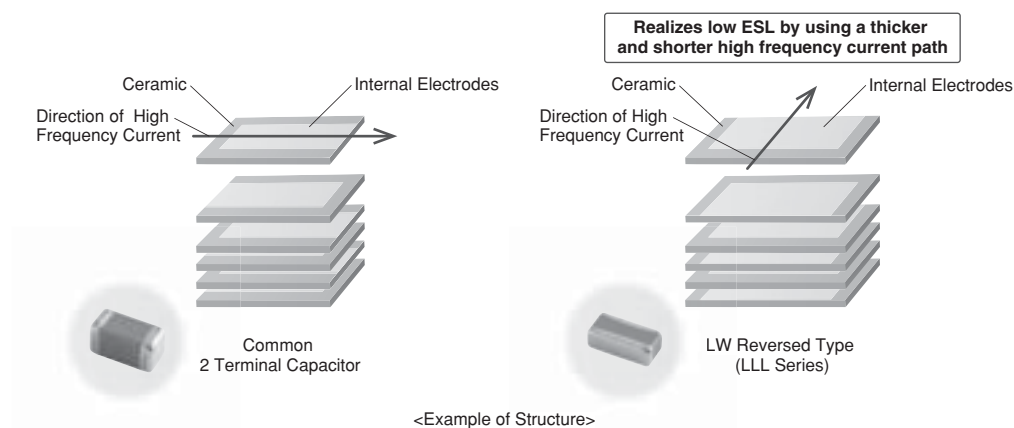

#### 2 Contributes to a reduction in the number of components.

The number of components can be reduced by using low ESL capacitors, while maintaining functions equivalent to general purpose capacitors (GRM Series).

Murata proposes the use of the LLL series to reduce the number of components and high costs. Simulation is also possible.

Proposal for Cost Reductions

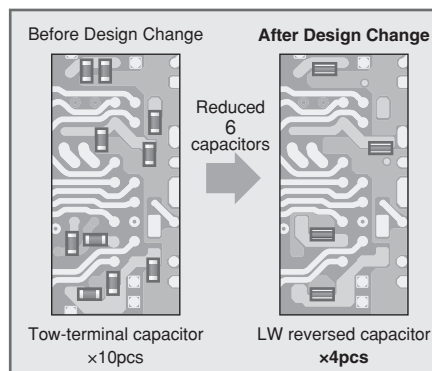

#### 3 A maximum operating temperature up to 125°C.

We also offer an abundant lineup of X7\* characteristics that can be used in high temperature locations, such as IC packages.

### Specifications

|                   |                               |
|-------------------|-------------------------------|
| Size              | 0.5×1.0mm to 1.6×3.2mm        |
| Rated Voltage     | DC2.5V to 50V                 |
| Capacitance       | 2,200pF to 10μF               |
| Main Applications | Application processor/CPU/GPU |

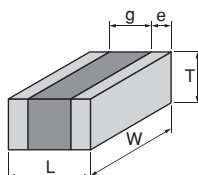

<Dimensions>

This catalog contains only a portion of the product lineup.  
 Please refer to the capacitor search tool on the Murata Web site for details.

# LLL Series High Dielectric Constant Type Low ESL Part Number List

## ■ 0.5×1.0mm

| T max. | Rated Voltage | TC Code | Cap.   | Tol. | Part Number        |
|--------|---------------|---------|--------|------|--------------------|
| 0.35mm | 6.3Vdc        | X6S     | 0.10μF | ±20% | LLL153C80J104ME01# |
|        |               |         | 0.22μF | ±20% | LLL153C80J224ME14# |
|        | 4Vdc          | X7S     | 0.47μF | ±20% | LLL153C70G474ME17# |
|        |               | X6S     | 1.0μF  | ±20% | LLL153C80G105ME21# |

## ■ 0.6×1.0mm

| T max. | Rated Voltage | TC Code | Cap.  | Tol. | Part Number  |
|--------|---------------|---------|-------|------|--|
| 0.45mm | 4Vdc          | X5R     | 4.3μF | ±20% | LLL1U4R60G435ME22# <span style="font-size: small;">Derating</span> |

## ■ 0.8×1.6mm

| T max. | Rated Voltage | TC Code | Cap.    | Tol.    | Part Number        |
|--------|---------------|---------|---------|---------|--------------------|
| 0.5mm  | 25Vdc         | X7R     | 10000pF | ±20%    | LLL185R71E103MA11# |
|        |               |         | 22000pF | ±20%    | LLL185R71C223MA11# |
|        |               |         |         | 47000pF | ±20%               |
|        | 10Vdc         | X7R     | 0.10μF  | ±20%    | LLL185R71A104MA11# |
|        |               |         | X7S     | 0.22μF  | ±20%               |
| 0.55mm | 4Vdc          | X7S     | 2.2μF   | ±20%    | LLL185C70G225ME01# |
| 0.6mm  | 50Vdc         | X7R     | 2200pF  | ±20%    | LLL185R71H222MA01# |
|        |               |         | 4700pF  | ±20%    | LLL185R71H472MA01# |
|        | 25Vdc         | X7R     | 10000pF | ±20%    | LLL185R71E103MA01# |
|        |               |         | 22000pF | ±20%    | LLL185R71E223MA01# |
|        |               |         | 47000pF | ±20%    | LLL185R71C473MA01# |
|        | 10Vdc         | X7R     | 0.10μF  | ±20%    | LLL185R71A104MA01# |
|        |               |         | 0.22μF  | ±20%    | LLL185R71A224MA01# |
|        | 4Vdc          | X7S     | 0.47μF  | ±20%    | LLL185C70G474MA01# |

## ■ 1.25×2.0mm

| T max.  | Rated Voltage | TC Code            | Cap.    | Tol.               | Part Number        |
|---------|---------------|--------------------|---------|--------------------|--------------------|
| 0.5mm   | 50Vdc         | X7R                | 10000pF | ±20%               | LLL215R71H103MA11# |
|         |               |                    | 22000pF | ±20%               | LLL215R71E223MA11# |
|         | 16Vdc         | X7R                | 47000pF | ±20%               | LLL215R71C473MA11# |
|         |               |                    | 0.10μF  | ±20%               | LLL215R71C104MA11# |
|         | 10Vdc         | X7R                | 0.22μF  | ±20%               | LLL215R71A224MA11# |
|         | 6.3Vdc        | X7R                | 0.47μF  | ±20%               | LLL215R70J474MA11# |
|         | 4Vdc          | X7S                | 1.0μF   | ±20%               | LLL215C70G105MA11# |
| 50Vdc   |               |                    | X7R     | 10000pF            | ±20%               |
| 22000pF | ±20%          | LLL216R71H223MA01# |         |                    |                    |
| 25Vdc   | 47000pF       | ±20%               |         | LLL216R71E473MA01# |                    |
| 0.7mm   | 10Vdc         | X7R                | 0.10μF  | ±20%               | LLL216R71E104MA01# |
|         |               |                    | 0.22μF  | ±20%               | LLL216R71A224MA01# |
|         | 16Vdc         | X7R                | 0.22μF  | ±20%               | LLL219R71C224MA01# |
|         |               |                    | 0.47μF  | ±20%               | LLL219R71A474MA01# |
|         | 10Vdc         | X7R                | 1.0μF   | ±20%               | LLL219R71A105MA01# |
| 4Vdc    |               |                    | X7S     | 2.2μF              | ±20%               |

## ■ 1.6×3.2mm

| T max. | Rated Voltage | TC Code            | Cap.               | Tol.               | Part Number        |                    |
|--------|---------------|--------------------|--------------------|--------------------|--------------------|--------------------|
| 0.5mm  | 50Vdc         | X7R                | 10000pF            | ±20%               | LLL315R71H103MA11# |                    |
|        |               |                    | 22000pF            | ±20%               | LLL315R71H223MA11# |                    |
|        |               |                    | 25Vdc              | X7R                | 47000pF            | ±20%               |
|        | 0.10μF        | ±20%               | LLL315R71E104MA11# |                    |                    |                    |
|        | 0.8mm         | 16Vdc              | X7R                | 0.22μF             | ±20%               | LLL315R71C224MA11# |
|        |               |                    |                    | 10Vdc              | X7R                | 0.47μF             |
| 50Vdc  |               | X7R                | 10000pF            | ±20%               | LLL317R71H103MA01# |                    |
|        |               |                    | 22000pF            | ±20%               | LLL317R71H223MA01# |                    |
|        |               |                    | 47000pF            | ±20%               | LLL317R71H473MA01# |                    |
| 25Vdc  | X7R           | 0.10μF             | ±20%               | LLL317R71E104MA01# |                    |                    |
|        |               | 16Vdc              | X7R                | 0.22μF             | ±20%               | LLL317R71C224MA01# |
| 0.47μF | ±20%          | LLL317R71C474MA01# |                    |                    |                    |                    |
| 1.25mm | 10Vdc         | X7R                | 1.0μF              | ±20%               | LLL317R71A105MA01# |                    |
|        |               |                    | 6.3Vdc             | X7R                | 2.2μF              | ±20%               |
|        | 50Vdc         | X7R                | 0.10μF             | ±20%               | LLL31MR71H104MA01# |                    |
|        |               |                    | 25Vdc              | X7R                | 0.22μF             | ±20%               |
|        | 0.47μF        | ±20%               | LLL31MR71E474MA01# |                    |                    |                    |
|        | 16Vdc         | X7R                | 1.0μF              | ±20%               | LLL31MR71C105MA01# |                    |
|        |               |                    | 10Vdc              | X7R                | 2.2μF              | ±20%               |
| 6.3Vdc | X7R           | 4.7μF              | ±20%               | LLL31MR70J475MA01# |                    |                    |
|        |               | X5R                | 10μF               | ±20%               | LLL31MR60J106ME01# |                    |

GRM Series  
 GJM Series  
 GMA Series  
 GMD Series  
 GQM Series  
 GRJ Series  
 GR3 Series  
 KRM Series  
 KR3 Series  
 LLA Series  
 LLL Series  
 LLM Series  
 LLR Series  
 ⚠Caution/  
 Notice

## 10-Terminal Low ESL Type

# LLM Series **Low ESL**

**10-Terminal Type Low ESL Capacitor Ideal for Power Supply Decoupling of High-speed Operation IC**

### Features

**① This is the lowest ESL LW reversed type capacitor.**

Since the equivalent series inductance (ESL) of this product is even lower than the LLA series (8-terminal product) with excellent high frequency characteristics, this capacitor is ideal for power supply decoupling of high-speed operation IC.

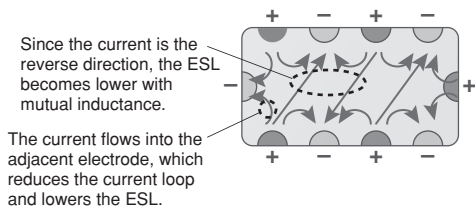
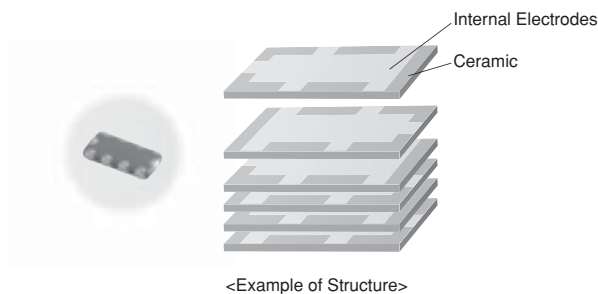

<Effectiveness of Cancelling Out Inductance by Mutual Inductance>

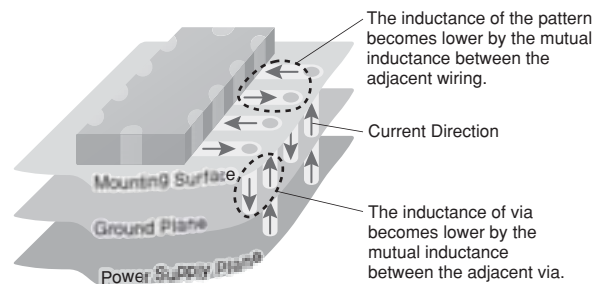

<Effectiveness of Suppressing Inductance when Mounting a Multi-terminal Capacitor>

**The inductance for the boards also becomes lower, not only the capacitor.**

**② A maximum operating temperature up to 125°C.**

This product is applicable to high temperatures (X7\* characteristics); however, Murata also offers numerous thin type products, which are ideal as decoupling capacitors on IC package.

### Specifications

|                   |                               |
|-------------------|-------------------------------|
| Size              | 2.0×1.25mm to 3.2×1.6mm       |
| Rated Voltage     | DC4V to 16V                   |
| Capacitance       | 0.1μF to 2.2μF                |
| Main Applications | Application processor/CPU/GPU |

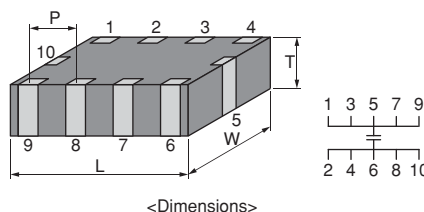

This catalog contains only a portion of the product lineup. Please refer to the capacitor search tool on the Murata Web site for details.

GRM Series  
GJM Series  
GMA Series  
GMD Series  
GQM Series  
GRJ Series  
GR3 Series  
KRM Series  
KR3 Series  
LLA Series  
LLL Series  
LLM Series  
LLR Series  
△Caution/Notice

GRM Series

GJM Series

GMA Series

GMD Series

GQM Series

GRJ Series

GR3 Series

KRM Series

KR3 Series

LLA Series

LLL Series

LLM Series

LLR Series

⚠Caution/  
Notice

## LLM Series High Dielectric Constant Type Part Number List

### ■ 2.0×1.25mm

| T max. | Rated Voltage | TC Code | Cap.   | Tol. | Part Number        |  |
|--------|---------------|---------|--------|------|--------------------|--|
| 0.55mm | 6.3Vdc        | X7R     | 0.22μF | ±20% | LLM215R70J224MA11# |  |
|        |               |         | 0.47μF | ±20% | LLM215R70J474MA11# |  |
|        | 4Vdc          | X7S     | 1.0μF  | ±20% | LLM215C70G105MA11# |  |

### ■ 3.2×1.6mm

| T max. | Rated Voltage | TC Code | Cap.   | Tol. | Part Number        |  |
|--------|---------------|---------|--------|------|--------------------|--|
| 0.55mm | 16Vdc         | X7R     | 0.10μF | ±20% | LLM315R71C104MA11# |  |
|        |               |         | 0.22μF | ±20% | LLM315R71C224MA11# |  |
|        | 10Vdc         | X7R     | 0.47μF | ±20% | LLM315R71A474MA11# |  |
|        | 6.3Vdc        | X7R     | 2.2μF  | ±20% | LLM315R70J225MA11# |  |

ESR Controlled Low ESL Type

# LLR Series



**Low  
ESL**

## ESR Controlled Type Low ESL Capacitors Equipped with Anti-resonance Control Function

### Features

#### ① Reduces Anti-resonance

This capacitor is controlled so that the equivalent series resistance (ESR) becomes slightly higher, and is effective in reducing the anti-resonance that occurs when capacitor arrays are used.

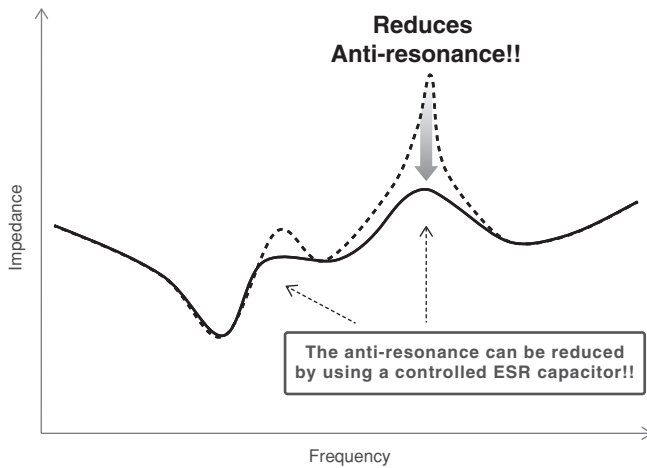

#### ② Lineup of capacitors with ESR values from 100 to 1,000mΩ.

According to the conditions of the anti-resonance, the most suitable ESR value can be selected from 4 types.

#### ③ Low ESL

This ESR controlled type capacitor has excellent high frequency characteristics, with low equivalent series inductance (ESL). This is also ideal as a decoupling component.

### Specifications

|                   |                             |
|-------------------|-----------------------------|
| Size              | 0.8×1.6mm                   |
| Rated Voltage     | DC4V                        |
| Capacitance       | 1.0μF                       |
| Main Applications | Network processor/ASIC/PMIC |

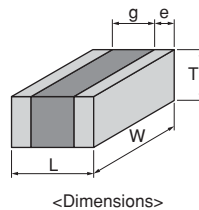

This catalog contains only a portion of the product lineup.  
 Please refer to the capacitor search tool on the Murata Web site for details.

GRM Series

GJM Series

GMA Series

GMD Series

GQM Series

GRJ Series

GR3 Series

KRM Series

KR3 Series

LLA Series

LLL Series

LLM Series

LLR Series

⚠Caution/  
Notice

GRM Series

GJM Series

GMA Series

GMD Series

GQM Series

GRJ Series

GR3 Series

KRM Series

KR3 Series

LLA Series

LLL Series

LLM Series

LLR Series

⚠Caution/  
Notice

## LLR Series High Dielectric Constant Type Part Number List

### ■ 0.8×1.6mm

| T max. | Rated Voltage | TC Code | Cap.  | Tol. | Part Number        |  |
|--------|---------------|---------|-------|------|--------------------|--|
| 0.55mm | 4Vdc          | X7S     | 1.0μF | ±20% | LLR185C70G105ME01# |  |
|        |               |         |       | ±20% | LLR185C70G105ME03# |  |
|        |               |         |       | ±20% | LLR185C70G105ME05# |  |
|        |               |         |       | ±20% | LLR185C70G105ME07# |  |

## ⚠Caution/Notice

### ⚠Caution

- Storage and Operation Conditions ..... 142
- Rating ..... 142
  - 1. Temperature Dependent Characteristics ..... 142
  - 2. Measurement of Capacitance ..... 142
  - 3. Applied Voltage ..... 143
  - 4. Type of Applied Voltage and Self-heating Temperature ..... 143
  - 5. DC Voltage and AC Voltage Characteristics ..... 146
  - 6. Capacitance Aging ..... 146
  - 7. Vibration and Shock ..... 147
- Soldering and Mounting ..... 147
  - 1. Mounting Position ..... 147
  - 2. Information before Mounting ..... 148
  - 3. Maintenance of the Mounting (pick and place) Machine ..... 148
    - 4-1. Reflow Soldering ..... 149
    - 4-2. Flow Soldering ..... 150
    - 4-3. Correction of Soldered Portion ..... 151
  - 5. Washing ..... 152
  - 6. Electrical Test on Printed Circuit Board ..... 152
  - 7. Printed Circuit Board Cropping ..... 152
  - 8. Assembly ..... 155
  - 9. Die Bonding/Wire Bonding ..... 156
- Other ..... 156
  - 1. Under Operation of Equipment ..... 156
  - 2. Other ..... 156

### Notice

- Rating ..... 157
  - 1. Operating Temperature ..... 157
  - 2. Atmosphere Surroundings (gaseous and liquid) ..... 157
  - 3. Piezo-electric Phenomenon ..... 157
- Soldering and Mounting ..... 157
  - 1. PCB Design ..... 157
    - 1. Notice for Pattern Forms ..... 157
    - 2. Land Dimensions ..... 158
    - 3. Board Design ..... 160
  - 2. Adhesive Application ..... 160
  - 3. Adhesive Curing ..... 160
  - 4. Flux for Reflow and Flow Soldering ..... 161
  - 5. Flow Soldering ..... 161
  - 6. Washing ..... 161
  - 7. Coating ..... 161
- Other ..... 162
  - 1. Transportation ..... 162
  - 2. Characteristics Evaluation in the Actual System ..... 162

GRM Series

GJM Series

GMA Series

GMD Series

GQM Series

GRJ Series

GR3 Series

KRM Series

KR3 Series

LLA Series

LLL Series

LLM Series

LLR Series

⚠Caution/  
Notice

## ⚠Caution

### ■ Storage and Operation Conditions

1. The performance of chip monolithic ceramic capacitors may be affected by the storage conditions.

1-1. Store the capacitors in the following conditions:

Room Temperature of +5°C to +40°C and a Relative Humidity of 20% to 70%.

(1) Sunlight, dust, rapid temperature changes, corrosive gas atmosphere, or high temperature and humidity conditions during storage may affect solderability and packaging performance.

Therefore, please maintain the storage temperature and humidity. Use the product within six months, as prolonged storage may cause oxidation of the electrodes.

(2) Please confirm solderability before using after six months. Store the capacitors without opening the original bag. Even if the storage period is short, do not exceed the specified atmospheric conditions.

1-2. Corrosive gas can react with the termination (external) electrodes or lead wires of capacitors, and result in poor solderability. Do not store the capacitors in an atmosphere consisting of corrosive gas (e.g., hydrogen sulfide, sulfur dioxide, chlorine, ammonia gas, etc.).

1-3. Due to moisture condensation caused by rapid humidity changes, or the photochemical change caused by direct sunlight on the terminal electrodes and/or the resin/epoxy coatings, the solderability and electrical performance may deteriorate. Do not store capacitors under direct sunlight or in high humidity conditions.

### ■ Rating

#### 1. Temperature Dependent Characteristics

1. The electrical characteristics of a capacitor can change with temperature.

1-1. For capacitors having larger temperature dependency, the capacitance may change with temperature changes.

The following actions are recommended in order to ensure suitable capacitance values.

(1) Select a suitable capacitance for the operating temperature range.

(2) The capacitance may change within the rated temperature.

When you use a high dielectric constant type capacitor in a circuit that needs a tight (narrow) capacitance tolerance (e.g., a time-constant circuit), please carefully consider the temperature characteristics, and carefully confirm the various characteristics in actual use conditions and the actual system.

[Typical Temperature Characteristics X7R (R7)]

Sample: 0.1μF, Rated Voltage 50VDC

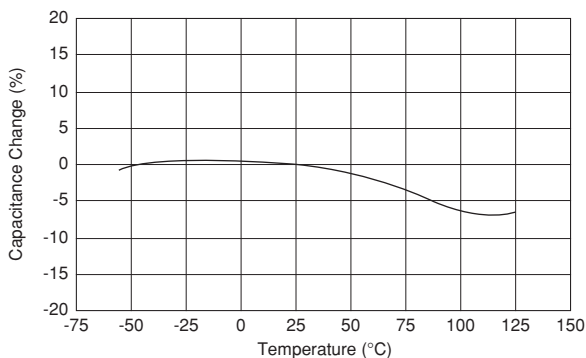

[Typical Temperature Characteristics X5R (R6)]

Sample: 22μF, Rated Voltage 4VDC

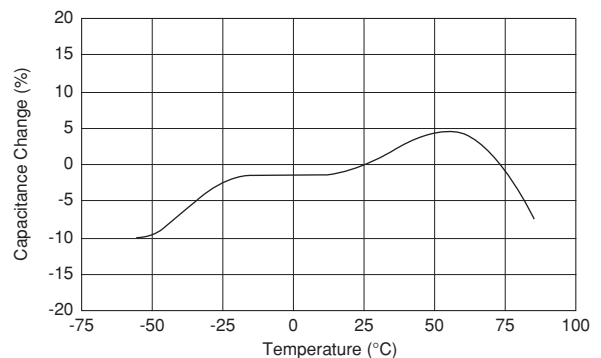

#### 2. Measurement of Capacitance

1. Measure capacitance with the voltage and frequency specified in the product specifications.

1-1. The output voltage of the measuring equipment may decrease occasionally when capacitance is high. Please confirm whether a prescribed measured voltage is impressed to the capacitor.

1-2. The capacitance values of high dielectric constant type capacitors change depending on the AC voltage applied. Please consider the AC voltage characteristics when selecting a capacitor to be used in an AC circuit.



☐ Continued from the preceding page.

### 3. Applied Voltage

1. Do not apply a voltage to the capacitor that exceeds the rated voltage as called out in the specifications.
  - 1-1. Applied voltage between the terminals of a capacitor shall be less than or equal to the rated voltage.
    - (1) When AC voltage is superimposed on DC voltage, the zero-to-peak voltage shall not exceed the rated DC voltage.  
 When AC voltage or pulse voltage is applied, the peak-to-peak voltage shall not exceed the rated DC voltage.
    - (2) Abnormal voltages (surge voltage, static electricity, pulse voltage, etc.) shall not exceed the rated DC voltage.

Typical Voltage Applied to the DC Capacitor

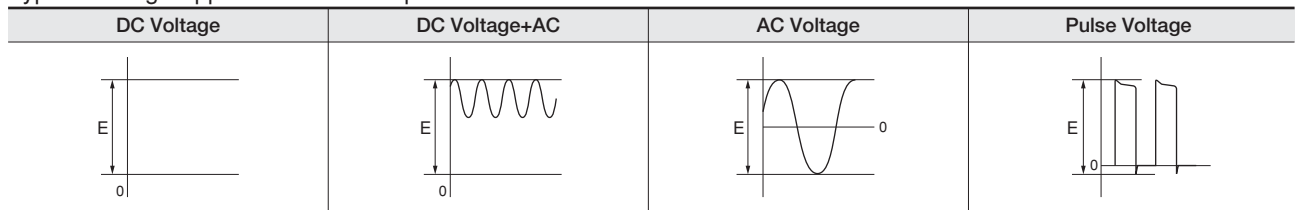

(E: Maximum possible applied voltage.)

- 1-2. Influence of over voltage
 

Over voltage that is applied to the capacitor may result in an electrical short circuit caused by the breakdown of the internal dielectric layers.  
 The time duration until breakdown depends on the applied voltage and the ambient temperature.
2. Use a safety standard certified capacitor in a power supply input circuit (AC filter), as it is also necessary to consider the withstand voltage and impulse withstand voltage defined for each device.

### 4. Type of Applied Voltage and Self-heating Temperature

1. Confirm the operating conditions to make sure that no large current is flowing into the capacitor due to the continuous application of an AC voltage or pulse voltage.  
 When a DC rated voltage product is used in an AC voltage circuit or a pulse voltage circuit, the AC current or pulse current will flow into the capacitor; therefore check the self-heating condition.  
 Please confirm the surface temperature of the capacitor so that the temperature remains within the upper limits of the operating temperature, including the rise in temperature due to self-heating. When the capacitor is used with a high-frequency voltage or pulse voltage, heat may be generated by dielectric loss.  
 <Applicable to Rated Voltage of less than 100VDC>
  - 1-1. The load should be contained to the level such that when measuring at atmospheric temperature of 25°C, the product's self-heating remains below 20°C and the surface temperature of the capacitor in the actual circuit remains within the maximum operating temperature.

[Example of Temperature Rise (Heat Generation) in Chip Monolithic Ceramic Capacitors in Contrast to Ripple Current]

Sample: R (R1) characteristics 10μF,  
 Rated voltage: DC10V

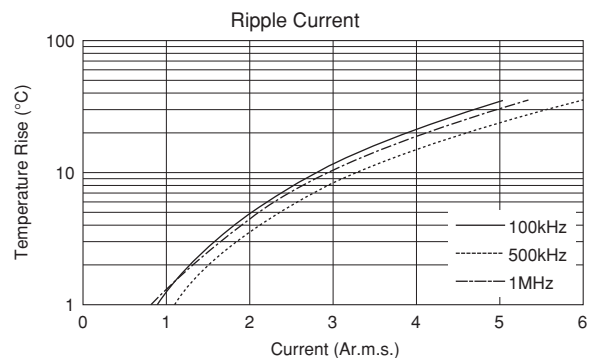

## ⚠Caution

↳ Continued from the preceding page.

<Applicable to Temperature Characteristics X7R (R7), X7T (D7) beyond Rated Voltage of 200VDC>

1-2. The load should be contained so that the self-heating of the capacitor body remains below 20°C, when measuring at an ambient temperature of 25°C. In addition, use a K thermocouple of  $\phi 0.1\text{mm}$  with less heat capacity when measuring, and measure in a condition where there is no effect from the radiant heat of other components or air flow caused by convection. Excessive generation of heat may cause deterioration of the characteristics and reliability of the capacitor. (Absolutely do not perform measurements while the cooling fan is operating, as an accurate measurement may not be performed.)

<Applicable to Temperature Characteristics U2J (7U), C0G (5C) beyond Rated Voltage of 200VDC>

1-3. Since the self-heating is low in the low loss series, the allowable power becomes extremely high compared to the common X7R (R7) characteristics. However, when a load with self-heating of 20°C is applied at the rated voltage, the allowable power may be exceeded. When the capacitor is used in a high-frequency voltage circuit of 1kHz or more, the frequency of the applied voltage should be less than 500kHz sine wave (less than 100kHz for a product with rated voltage of DC3.15kV), to limit the voltage load so that the load remains within the derating shown in the following figure. In the case of non-sine wave, high-frequency components exceeding the fundamental frequency may be included. In such a case, please contact Murata. The excessive generation of heat may cause deterioration of the characteristics and reliability of the capacitor. (Absolutely do not perform measurements while the cooling fan is operating, as an accurate measurement may not be performed.)

The temperature of the surface of capacitor: 125°C or less (including self-heating)

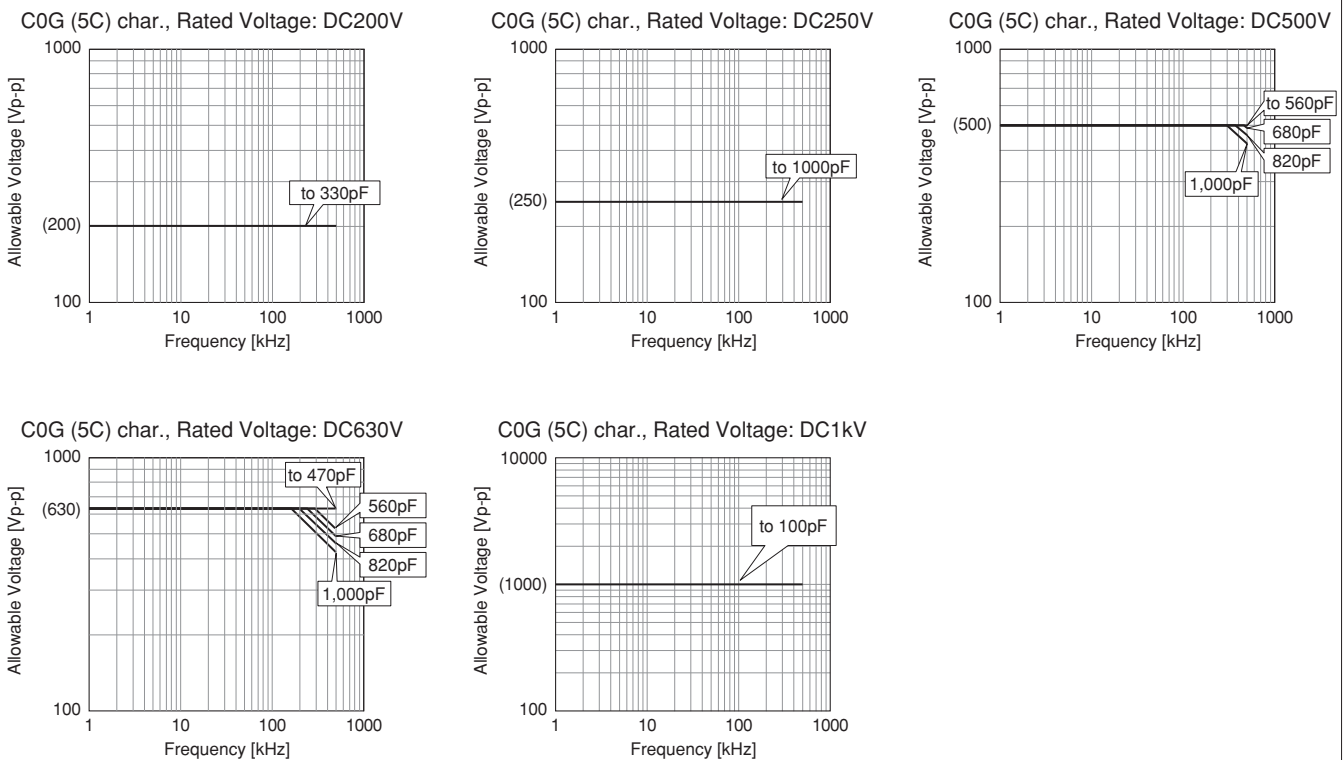

The sine-wave frequency VS allowable voltage

Continued on the following page. ↗

↳ Continued from the preceding page.

The temperature of the surface of capacitor: 125°C or less (including self-heating)

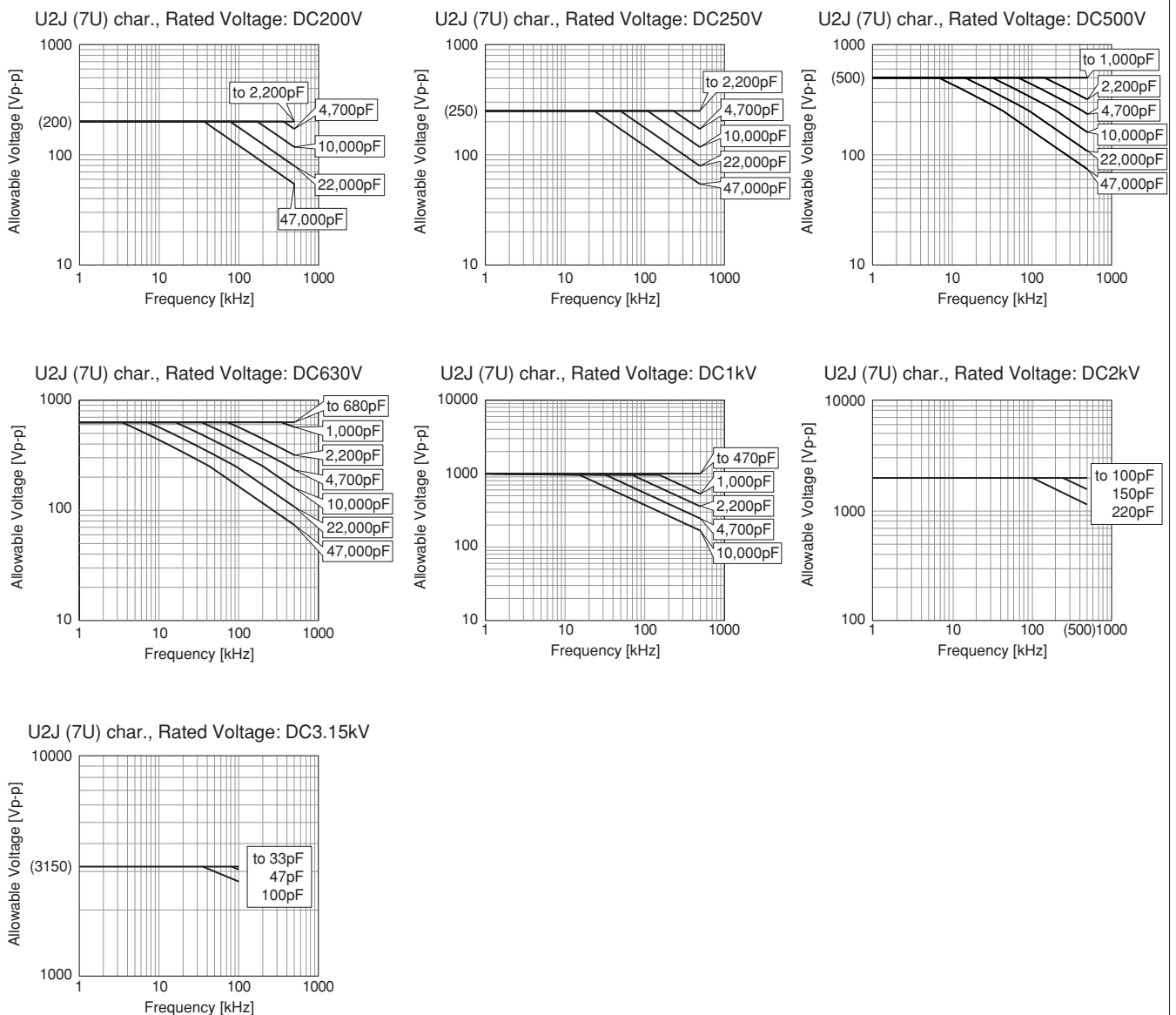

The sine-wave frequency VS allowable voltage

<Design Tool>

• Simsurfing

Simsurfing is a web application to display the characteristics charts and download the characteristics data of our products. The frequency characteristics, temperature characteristics, bias characteristics etc. can be checked.

(Address: <http://www.murata.com/simsurfing/>)

• Medium Voltage Ceramic Capacitor Selection Tool

The selection tool "Murata Medium Voltage Capacitors Selection Tool by Voltage Form" is installed in the above SimSurfing, where the usability of the preferred medium voltage ceramic capacitors can be determined according to the application including automobiles.

By using this tool, the preferred products\* can be checked by specifications, such as the power, voltage, and fundamental frequency of the voltage waveform to be input into the capacitor.

\*Supported Series

Temperature characteristics U2J (7U), C0G (5C) of GRM/DC200V or more

GRM Series  
 GJM Series  
 GMA Series  
 GMD Series  
 GQM Series  
 GRJ Series  
 GR3 Series  
 KRM Series  
 KR3 Series  
 LLA Series  
 LLL Series  
 LLM Series  
 LLR Series  
 ⚠Caution

## ⚠Caution

↳ Continued from the preceding page.

### 5. DC Voltage and AC Voltage Characteristics

1. The capacitance value of a high dielectric constant type capacitor changes depending on the DC voltage applied. Please consider the DC voltage characteristics when a capacitor is selected for use in a DC circuit.

1-1. The capacitance of ceramic capacitors may change sharply depending on the applied voltage (see figure).

Please confirm the following in order to secure the capacitance.

- (1) Determine whether the capacitance change caused by the applied voltage is within the allowed range.
- (2) In the DC voltage characteristics, the rate of capacitance change becomes larger as voltage increases, even if the applied voltage is below the rated voltage. When a high dielectric constant type capacitor is used in a circuit that requires a tight (narrow) capacitance tolerance (e.g., a time constant circuit), please carefully consider the voltage characteristics, and confirm the various characteristics in actual operating conditions in an actual system.

2. The capacitance values of high dielectric constant type capacitors changes depending on the AC voltage applied. Please consider the AC voltage characteristics when selecting a capacitor to be used in an AC circuit.

[DC Voltage Characteristics]

Sample: X7R (R7) Characteristics 0.1μF, Rated Voltage 50VDC

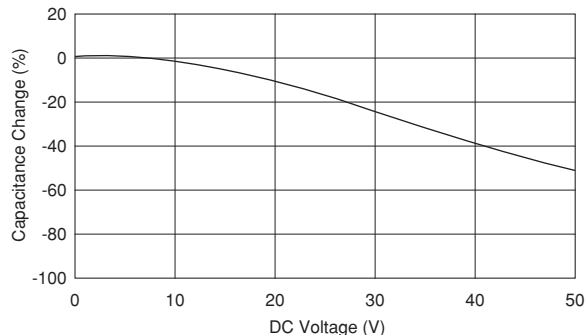

[AC Voltage Characteristics]

Sample: X7R (R7) Characteristics 10μF, Rated Voltage 6.3VDC

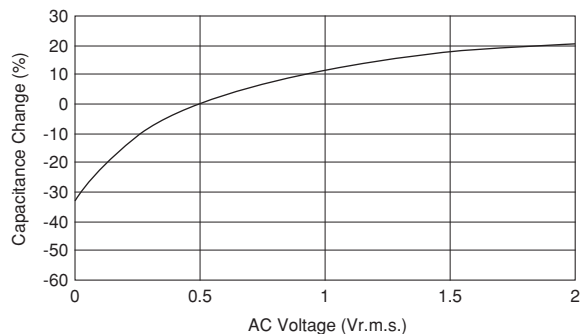

### 6. Capacitance Aging

1. The high dielectric constant type capacitors have the characteristic in which the capacitance value decreases with the passage of time.

When you use high dielectric constant type capacitors in a circuit that needs a tight (narrow) capacitance tolerance (e.g., a time-constant circuit), please carefully consider the characteristics of these capacitors, such as their aging, voltage, and temperature characteristics. In addition, check capacitors using your actual appliances at the intended environment and operating conditions.

[Example of Change Over Time (Aging Characteristics)]

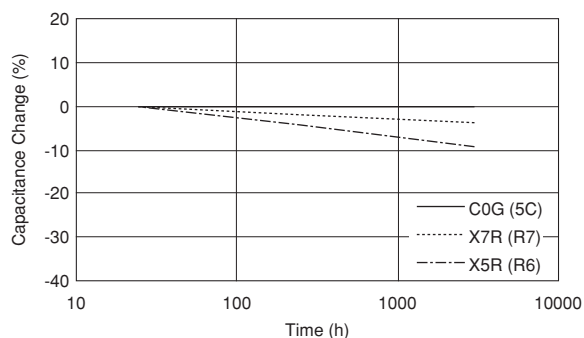

Continued on the following page. ↗

☐ Continued from the preceding page.

**7. Vibration and Shock**

1. Please confirm the kind of vibration and/or shock, its condition, and any generation of resonance.  
Please mount the capacitor so as not to generate resonance, and do not allow any impact on the terminals.
2. Mechanical shock due to being dropped may cause damage or a crack in the dielectric material of the capacitor.  
Do not use a dropped capacitor because the quality and reliability may be deteriorated.
3. When printed circuit boards are piled up or handled, the corner of another printed circuit board should not be allowed to hit the capacitor, in order to avoid a crack or other damage to the capacitor.

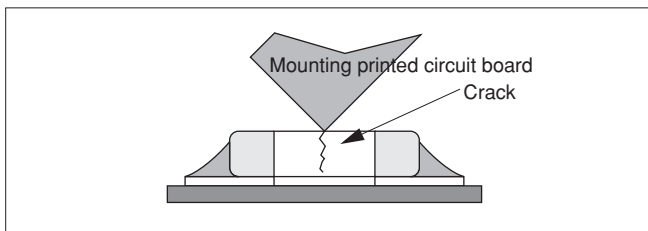
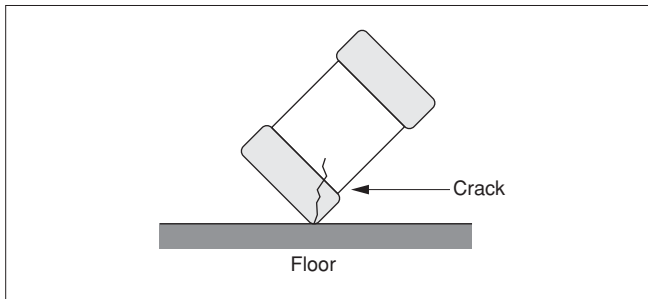

**■ Soldering and Mounting**

**1. Mounting Position**

1. Confirm the best mounting position and direction that minimizes the stress imposed on the capacitor during flexing or bending the printed circuit board.
  - 1-1. Choose a mounting position that minimizes the stress imposed on the chip during flexing or bending of the board.

**[Component Direction]**

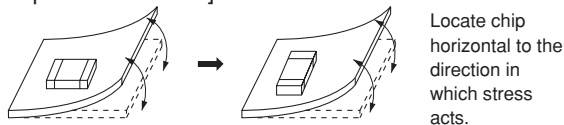

**[Chip Mounting Close to Board Separation Point]**

It is effective to implement the following measures, to reduce stress in separating the board.  
 It is best to implement all of the following three measures; however, implement as many measures as possible to reduce stress.

| Contents of Measures   | Stress Level |
|--|--------------|
| (1) Turn the mounting direction of the component parallel to the board separation surface. | A > D        |
| (2) Add slits in the board separation part.  | A > B        |
| (3) Keep the mounting position of the component away from the board separation surface.    | A > C        |

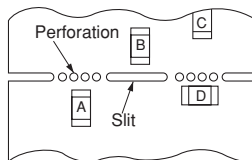

**[Mounting Capacitors Near Screw Holes]**

When a capacitor is mounted near a screw hole, it may be affected by the board deflection that occurs during the tightening of the screw. Mount the capacitor in a position as far away from the screw holes as possible.

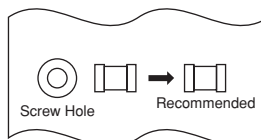

Continued on the following page. ↗

GRM Series  
 GJM Series  
 GMA Series  
 GMD Series  
 GQM Series  
 GRJ Series  
 GR3 Series  
 KRM Series  
 KR3 Series  
 LLA Series  
 LLL Series  
 LLM Series  
 LLR Series  
 ⚠Caution

## ⚠Caution

☐ Continued from the preceding page.

### 2. Information before Mounting

1. Do not re-use capacitors that were removed from the equipment.
2. Confirm capacitance characteristics under actual applied voltage.
3. Confirm the mechanical stress under actual process and equipment use.
4. Confirm the rated capacitance, rated voltage and other electrical characteristics before assembly.
5. Prior to use, confirm the solderability of capacitors that were in long-term storage.
6. Prior to measuring capacitance, carry out a heat treatment for capacitors that were in long-term storage.
7. The use of Sn-Zn based solder will deteriorate the reliability of the MLCC.

Please contact our sales representative or product engineers on the use of Sn-Zn based solder in advance.

8. We have also produced a DVD which shows a summary of our opinions, regarding the precautions for mounting. Please contact our sales representative to request the DVD.

### 3. Maintenance of the Mounting (pick and place) Machine

1. Make sure that the following excessive forces are not applied to the capacitors.

1-1. In mounting the capacitors on the printed circuit board, any bending force against them shall be kept to a minimum to prevent them from any bending damage or cracking. Please take into account the following precautions and recommendations for use in your process.

- (1) Adjust the lowest position of the pickup nozzle so as not to bend the printed circuit board.
- (2) Adjust the nozzle pressure within a static load of 1N to 3N during mounting.

2. Dirt particles and dust accumulated between the suction nozzle and the cylinder inner wall prevent the nozzle from moving smoothly. This imposes greater force upon the chip during mounting, causing cracked chips. Also, the locating claw, when worn out, imposes uneven forces on the chip when positioning, causing cracked chips. The suction nozzle and the locating claw must be maintained, checked, and replaced periodically.

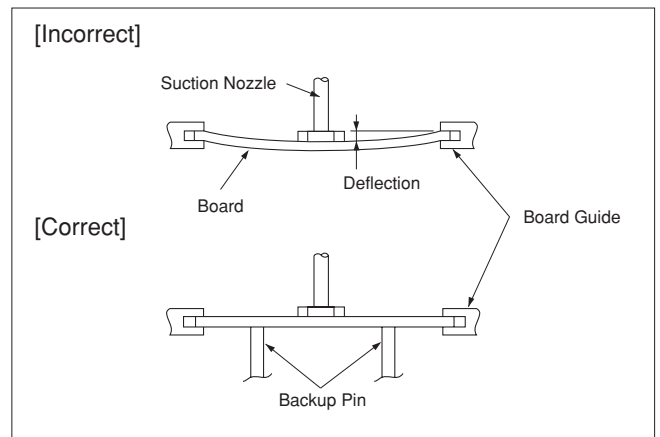

Continued on the following page. ☐

☐ Continued from the preceding page.

### 4-1. Reflow Soldering

- When sudden heat is applied to the components, the mechanical strength of the components will decrease because a sudden temperature change causes deformation inside the components. In order to prevent mechanical damage to the components, preheating is required for both the components and the PCB. Preheating conditions are shown in table 1. It is required to keep the temperature differential between the solder and the components surface ( $\Delta T$ ) as small as possible.
- Solderability of tin plating termination chips might be deteriorated when a low temperature soldering profile where the peak solder temperature is below the melting point of tin is used. Please confirm the solderability of tin plated termination chips before use.
- When components are immersed in solvent after mounting, be sure to maintain the temperature difference ( $\Delta T$ ) between the component and the solvent within the range shown in table 1.

Table 1

| Part Number  | Temperature Differential          |
|--|-----------------------------------|
| GJM/GQM/GR3/GRJ/GRM/KRM/LLL/LLR Series 02/03/15/18/21/31 sizes<br>LLL Series 1U size             | $\Delta T \leq 190^\circ\text{C}$ |
| GR3/GRJ/GRM/KR3/KRM Series 32/43/55 sizes<br>LLA/LLM Series 18/21/31 sizes<br>GQM Series 22 size | $\Delta T \leq 130^\circ\text{C}$ |

#### Recommended Conditions

|                  | Pb-Sn Solder |                                     | Lead Free Solder      |
|------------------|--------------|-------------------------------------|-----------------------|
|                  | Reflow       | Vapor Reflow                        |                       |
| Peak Temperature | 230 to 250°C | 230 to 240°C                        | 240 to 260°C          |
| Atmosphere       | Air          | Saturated vapor of inactive solvent | Air or N <sub>2</sub> |

Pb-Sn Solder: Sn-37Pb

Lead Free Solder: Sn-3.0Ag-0.5Cu

#### 4. Optimum Solder Amount for Reflow Soldering

- Overly thick application of solder paste results in a excessive solder fillet height. This makes the chip more susceptible to mechanical and thermal stress on the board and may cause the chips to crack.
- Too little solder paste results in a lack of adhesive strength on the outer electrode, which may result in chips breaking loose from the PCB.
- Make sure the solder has been applied smoothly to the end surface to a height of 0.2mm\* min.

#### Inverting the PCB

Make sure not to impose any abnormal mechanical shocks to the PCB.

#### [Standard Conditions for Reflow Soldering]

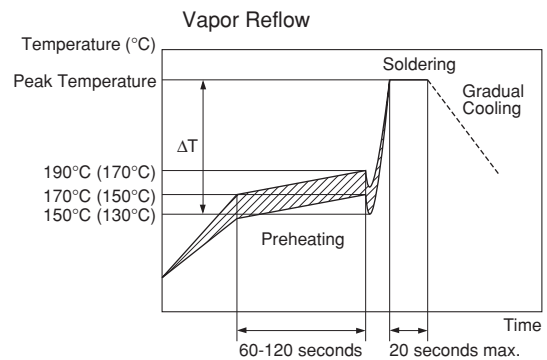
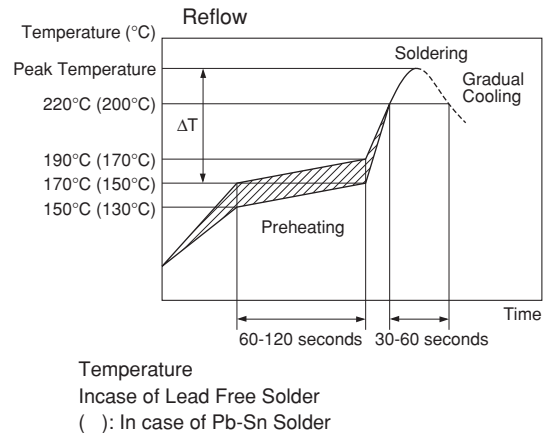

#### [Allowable Reflow Soldering Temperature and Time]

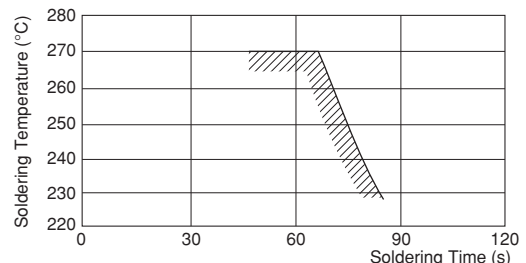

In the case of repeated soldering, the accumulated soldering time must be within the range shown above.

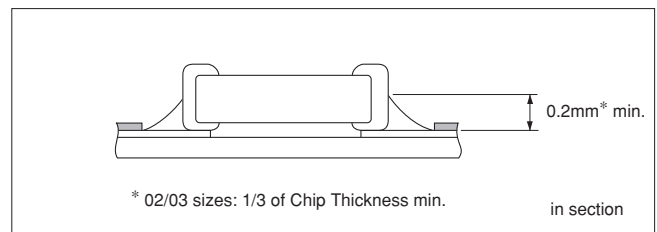

GRM Series  
 GJM Series  
 GMA Series  
 GMD Series  
 GQM Series  
 GRJ Series  
 GR3 Series  
 KRM Series  
 KR3 Series  
 LLA Series  
 LLL Series  
 LLM Series  
 LLR Series  
 ⚠Caution

## ⚠Caution

☐ Continued from the preceding page.

### 4-2. Flow Soldering

1. Do not apply flow soldering to chips not listed in table 2.

Table 2

| Part Number   | Temperature Differential            |
|---|-------------------------------------|
| <b>GR3/GRM Series 18/21/31 sizes</b><br><b>GQM Series 18/21 sizes</b><br><b>LLL Series 21/31 sizes</b><br><b>GRJ Series Rated Voltage 250VDC or more 18/21/31 sizes</b> | $\Delta T \leq 150^{\circ}\text{C}$ |

- When sudden heat is applied to the components, the mechanical strength of the components will decrease because a sudden temperature change causes deformation inside the components. In order to prevent mechanical damage to the components, preheating is required for both of the components and the PCB. Preheating conditions are shown in table 2. It is required to keep the temperature differential between the solder and the components surface ( $\Delta T$ ) as low as possible.
- Excessively long soldering time or high soldering temperature can result in leaching of the outer electrodes, causing poor adhesion or a reduction in capacitance value due to loss of contact between the electrodes and end termination.
- When components are immersed in solvent after mounting, be sure to maintain the temperature differential ( $\Delta T$ ) between the component and solvent within the range shown in the table 2.

#### Recommended Conditions

|                             | Pb-Sn Solder | Lead Free Solder |
|-----------------------------|--------------|------------------|
| Preheating Peak Temperature | 90 to 110°C  | 100 to 120°C     |
| Soldering Peak Temperature  | 240 to 250°C | 250 to 260°C     |
| Atmosphere                  | Air          | Air              |

Pb-Sn Solder: Sn-37Pb  
 Lead Free Solder: Sn-3.0Ag-0.5Cu

#### 5. Optimum Solder Amount for Flow Soldering

- The top of the solder fillet should be lower than the thickness of the components. If the solder amount is excessive, the risk of cracking is higher during board bending or any other stressful condition.

#### [Standard Conditions for Flow Soldering]

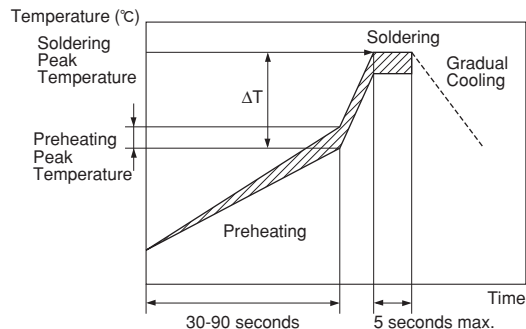

#### [Allowable Flow Soldering Temperature and Time]

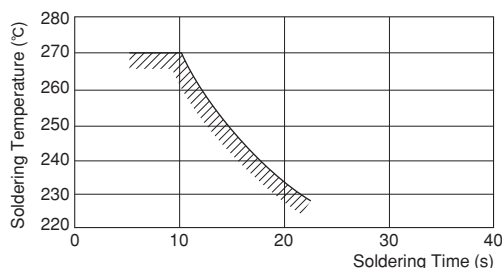

In the case of repeated soldering, the accumulated soldering time must be within the range shown above.

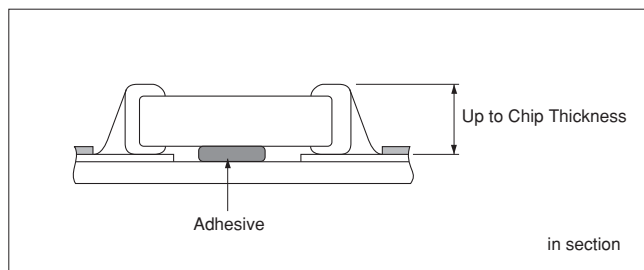

Continued on the following page. ☐



☐ Continued from the preceding page.

### 4-3. Correction of Soldered Portion

When sudden heat is applied to the capacitor, distortion caused by the large temperature difference occurs internally, and can be the cause of cracks. Capacitors also tend to be affected by mechanical and thermal stress depending on the board preheating temperature or the soldering fillet shape, and can be the cause of cracks. Please refer to "1. PCB Design" or "3. Optimum solder amount" for the solder amount and the fillet shapes.

#### 1. Correction with a Soldering Iron

- 1-1. In order to reduce damage to the capacitor, be sure to preheat the capacitor and the mounting board. Preheat to the temperature range shown in Table 3. A hot plate, hot air type preheater, etc. can be used for preheating.
- 1-2. After soldering, do not allow the component/PCB to cool down rapidly.
- 1-3. Perform the corrections with a soldering iron as quickly as possible. If the soldering iron is applied too long, there is a possibility of causing solder leaching on the terminal electrodes, which will cause deterioration of the adhesive strength and other problems.

#### 2. Correction with Spot Heater

Compared to local heating with a soldering iron, hot air heating by a spot heater heats the overall component and board, therefore, it tends to lessen the thermal shock. In the case of a high density mounted board, a spot heater can also prevent concerns of the soldering iron making direct contact with the component.

- 2-1. If the distance from the hot air outlet of the spot heater to the component is too close, cracks may occur due to thermal shock. To prevent this problem, follow the conditions shown in Table 4.

- 2-2. In order to create an appropriate solder fillet shape, it is recommended that hot air be applied at the angle shown in Figure 1.

#### 3. Optimum solder amount when re-working with a soldering iron

- 3-1. In the case of sizes smaller than 0603, (GJM/GQM/GR3/GRJ/GRM Series, 03/15/18 sizes), the top of the solder fillet should be lower than  $\frac{2}{3}$  of the thickness of the component or 0.5mm, whichever is smaller. In the case of 0805 and larger sizes, (GJM/GQM/GR3/GRJ/GRM Series, 21/22/31/32/43/55 sizes), the top of the solder fillet should be lower than  $\frac{2}{3}$  of the thickness of the component. If the solder amount is excessive, the risk of cracking is higher during board bending or under any other stressful condition.

Table 3

| Part Number   | Temperature of Soldering Iron Tip | Preheating Temperature | Temperature Differential ( $\Delta T$ ) | Atmosphere |
|---|-----------------------------------|------------------------|---|------------|
| GJM/GQM/GR3/GRJ/GRM Series<br>03/15/18/21/31 sizes        | 350°C max.                        | 150°C min.             | $\Delta T \leq 190^\circ\text{C}$       | Air        |
| GRJ/GRM Series<br>32/43/55 sizes<br>GQM Series<br>22 size | 280°C max.                        | 150°C min.             | $\Delta T \leq 130^\circ\text{C}$       | Air        |

\*Applicable for both Pb-Sn and Lead Free Solder.  
 Pb-Sn Solder: Sn-37Pb  
 Lead Free Solder: Sn-3.0Ag-0.5Cu

Table 4

|                                   |   |
|-----------------------------------|---|
| Distance                          | 5mm or more   |
| Hot Air Application Angle         | 45° *Figure 1   |
| Hot Air Temperature Nozzle Outlet | 400°C max.  |
| Application Time                  | Less than 10 seconds<br>(1206 (3216 in mm) size or smaller) |
|                                   | Less than 30 seconds<br>(1210 (3225 in mm) size or larger)  |

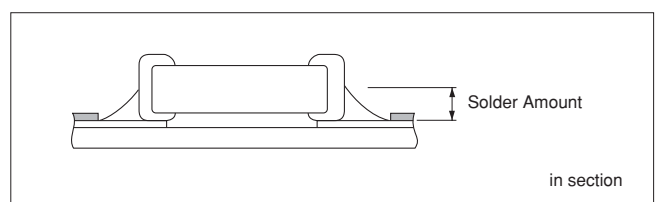
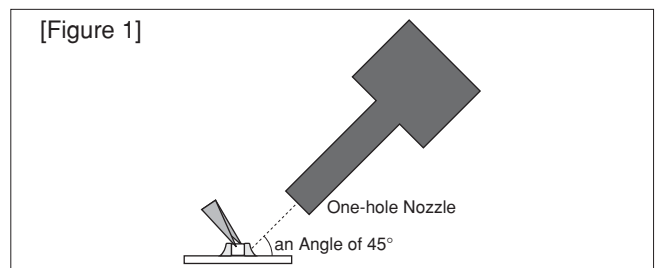

GRM Series  
 GJM Series  
 GMA Series  
 GMD Series  
 GQM Series  
 GRJ Series  
 GR3 Series  
 KRM Series  
 KR3 Series  
 LLA Series  
 LLL Series  
 LLM Series  
 LLR Series  
 ⚠Caution

## ⚠Caution

☐ Continued from the preceding page.

- 3-2. A soldering iron with a tip of  $\phi 3\text{mm}$  or smaller should be used. It is also necessary to keep the soldering iron from touching the components during the re-work.
- 3-3. Solder wire with  $\phi 0.5\text{mm}$  or smaller is required for soldering.

<Applicable to KR3/KRM Series>

4. For the shape of the soldering iron tip, refer to the figure on the right.

Regarding the type of solder, use a wire diameter of  $\phi 0.5\text{mm}$  or less (rosin core wire solder).

### 4-1. How to Apply the Soldering Iron

Apply the tip of the soldering iron against the lower end of the metal terminal.

- 1) In order to prevent cracking caused by sudden heating of the ceramic device, do not touch the ceramic base directly.
- 2) In order to prevent deviations and dislocating of the chip, do not touch the junction of the chip and the metal terminal, and the metal portion on the outside directly.

### 4-2. Appropriate Amount of Solder

The amount of solder for corrections by soldering iron, should be lower than the height of the lower side of the chip.

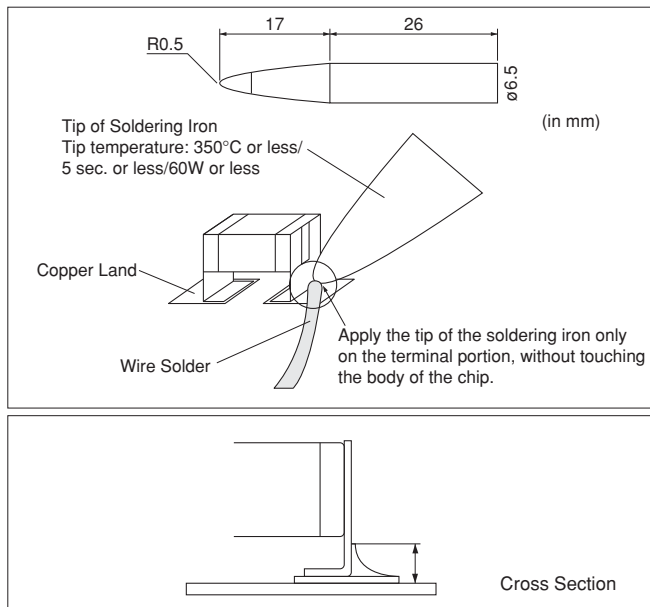

## 5. Washing

Excessive ultrasonic oscillation during cleaning can cause the PCBs to resonate, resulting in cracked chips or broken solder joints. Take note not to vibrate PCBs.

## 6. Electrical Test on Printed Circuit Board

1. Confirm position of the backup pin or specific jig, when inspecting the electrical performance of a capacitor after mounting on the printed circuit board.

1-1. Avoid bending the printed circuit board by the pressure of a test-probe, etc.

The thrusting force of the test probe can flex the PCB, resulting in cracked chips or open solder joints.

Provide backup pins on the back side of the PCB to prevent warping or flexing. Install backup pins as close to the test-probe as possible.

1-2. Avoid vibration of the board by shock when a test-probe contacts a printed circuit board.

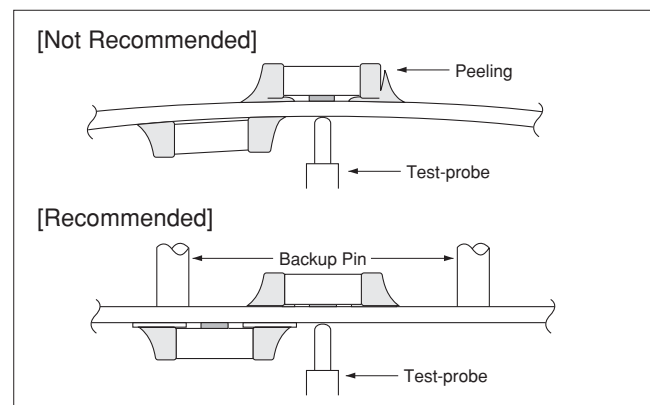

## 7. Printed Circuit Board Cropping

1. After mounting a capacitor on a printed circuit board, do not apply any stress to the capacitor that causes bending or twisting the board.

1-1. In cropping the board, the stress as shown at right may cause the capacitor to crack.

Cracked capacitors may cause deterioration of the insulation resistance, and result in a short.

Avoid this type of stress to a capacitor.

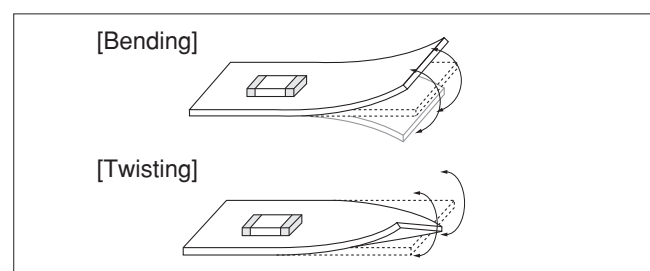

Continued on the following page. ↗

☐ Continued from the preceding page.

2. Check the cropping method for the printed circuit board in advance.

2-1. Printed circuit board cropping shall be carried out by using a jig or an apparatus (Disk separator, router type separator, etc.) to prevent the mechanical stress that can occur to the board.

| Board Separation Method  | Hand Separation<br>Nipper Separation   | (1) Board Separation Jig  | Board Separation Apparatus   |                           |
|--------------------------|--|---|--|---------------------------|
|                          |  |   | (2) Disk Separator   | (3) Router Type Separator |
| Level of stress on board | High   | Medium  | Medium   | Low                       |
| Recommended              | ×  | △*  | △*   | ○                         |
| Notes                    | Hand and nipper separation apply a high level of stress. Use another method. | <ul style="list-style-type: none"> <li>Board handling</li> <li>Board bending direction</li> <li>Layout of capacitors</li> </ul> | <ul style="list-style-type: none"> <li>Board handling</li> <li>Layout of slits</li> <li>Design of V groove</li> <li>Arrangement of blades</li> <li>Controlling blade life</li> </ul> | Board handling            |

\* When a board separation jig or disk separator is used, if the following precautions are not observed, a large board deflection stress will occur and the capacitors may crack. Use router type separator if at all possible.

(1) Example of a suitable jig

[In the case of Single-side Mounting]

An outline of the board separation jig is shown as follows. Recommended example: Stress on the component mounting position can be minimized by holding the portion close to the jig, and bend in the direction towards the side where the capacitors are mounted. Not recommended example: The risk of cracks occurring in the capacitors increases due to large stress being applied to the component mounting position, if the portion away from the jig is held and bent in the direction opposite the side where the capacitors are mounted.

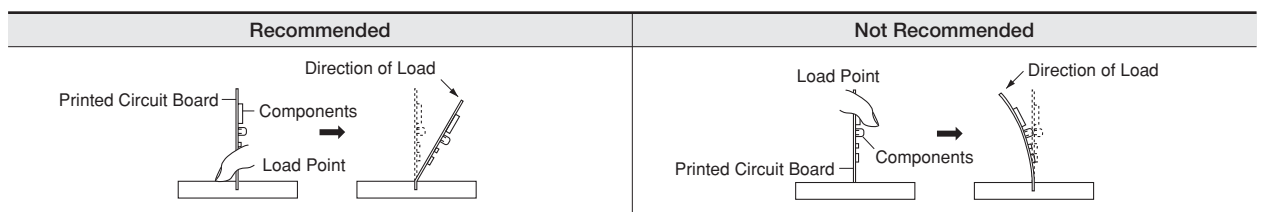
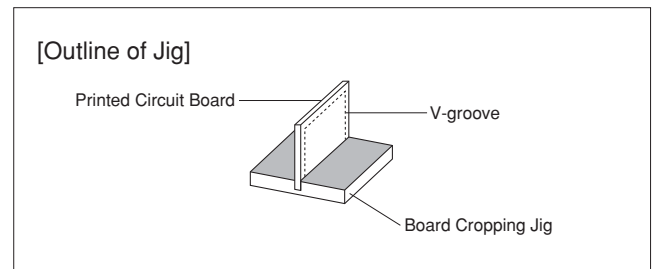

[In the case of Double-sided Mounting]

Since components are mounted on both sides of the board, the risk of cracks occurring can not be avoided with the above method.

Therefore, implement the following measures to prevent stress from being applied to the components. (Measures)

- (1) Consider introducing a router type separator.  
If it is difficult to introduce a router type separator, implement the following measures. (Refer to item 1. Mounting Position)
- (2) Mount the components parallel to the board separation surface.
- (3) When mounting components near the board separation point, add slits in the separation position near the component.
- (4) Keep the mounting position of the components away from the board separation point.

GRM Series  
GJM Series  
GMA Series  
GMD Series  
GQM Series  
GRJ Series  
GR3 Series  
KRM Series  
KR3 Series  
LLA Series  
LLL Series  
LLM Series  
LLR Series  
⚠Caution

GRM Series  
 GJM Series  
 GMA Series  
 GMD Series  
 GQM Series  
 GRJ Series  
 GR3 Series  
 KRM Series  
 KR3 Series  
 LLA Series  
 LLL Series  
 LLM Series  
 LLR Series  
 ⚠Caution

**⚠Caution**

Continued from the preceding page.

(2) Example of a Disk Separator

An outline of a disk separator is shown as follows. As shown in the Principle of Operation, the top blade and bottom blade are aligned with the V-grooves on the printed circuit board to separate the board.

In the following case, board deflection stress will be applied and cause cracks in the capacitors.

- (1) When the adjustment of the top and bottom blades are misaligned, such as deviating in the top-bottom, left-right or front-rear directions
- (2) The angle of the V groove is too low, depth of the V groove is too shallow, or the V groove is misaligned top-bottom

IF V groove is too deep, it is possible to brake when you handle and carry it. Carefully design depth of the V groove with consideration about strength of material of the printed circuit board.

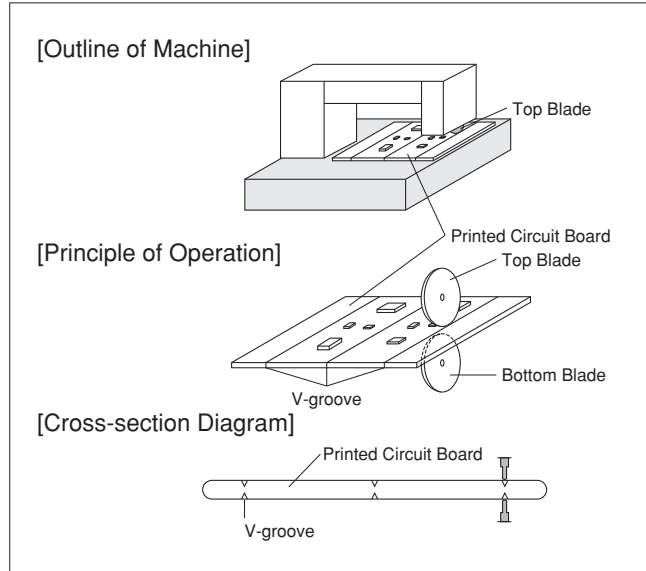

| Recommended                          | Not Recommended                      |                                      |                                      |
|--------------------------------------|--------------------------------------|--------------------------------------|--------------------------------------|
|                                      | Top-bottom Misalignment              | Left-right Misalignment              | Front-rear Misalignment              |
| <p>Top Blade</p> <p>Bottom Blade</p> | <p>Top Blade</p> <p>Bottom Blade</p> | <p>Top Blade</p> <p>Bottom Blade</p> | <p>Top Blade</p> <p>Bottom Blade</p> |

| Example of Recommended V-groove Design | Not Recommended         |           |                   |                |
|--|-------------------------|-----------|-------------------|----------------|
|  | Left-right Misalignment | Low-Angle | Depth too Shallow | Depth too Deep |
|  |                         |           |                   |                |

(3) Example of Router Type Separator

The router type separator performs cutting by a router rotating at a high speed. Since the board does not bend in the cutting process, stress on the board can be suppressed during board separation.

When attaching or removing boards to/from the router type separator, carefully handle the boards to prevent bending.

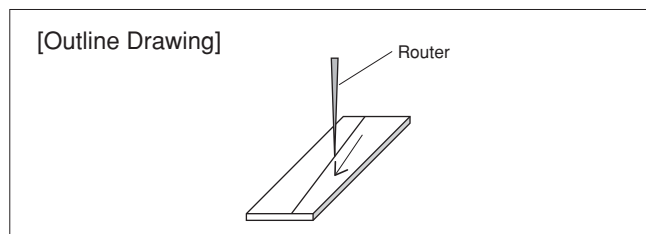

Continued on the following page. ↗

☐ Continued from the preceding page.

## 8. Assembly

### 1. Handling

If a board mounted with capacitors is held with one hand, the board may bend. Firmly hold the edges of the board with both hands when handling.

If a board mounted with capacitors is dropped, cracks may occur in the capacitors.

Do not use dropped boards, as there is a possibility that the quality of the capacitors may be impaired.

### 2. Attachment of Other Components

#### 2-1. Mounting of Other Components

Pay attention to the following items, when mounting other components on the back side of the board after capacitors have been mounted on the opposite side. When the bottom dead point of the suction nozzle is set too low, board deflection stress may be applied to the capacitors on the back side (bottom side), and cracks may occur in the capacitors.

- After the board is straightened, set the bottom dead point of the nozzle on the upper surface of the board.
- Periodically check and adjust the bottom dead point.

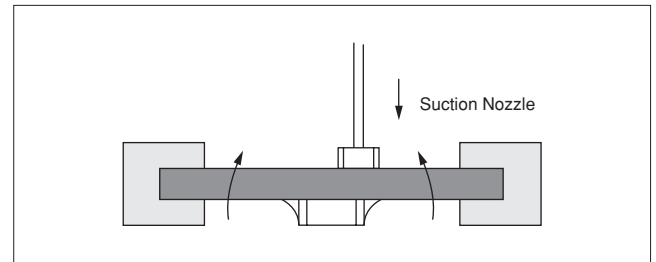

#### 2-2. Inserting Components with Leads into Boards

When inserting components (transformers, IC, etc.) into boards, bending the board may cause cracks in the capacitors or cracks in the solder.

Pay attention to the following.

- Increase the size of the holes to insert the leads, to reduce the stress on the board during insertion.
- Fix the board with backup pins or a dedicated jig before insertion.
- Support below the board so that the board does not bend. When using multiple backup pins on the board, periodically confirm that there is no difference in the height of each backup pin.

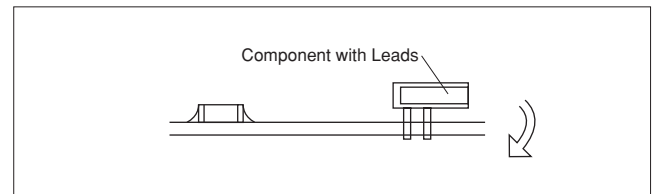

#### 2-3. Attaching/Removing Sockets

When the board itself is a connector, the board may bend when a socket is attached or removed. Plan the work so that the board does not bend when a socket is attached or removed.

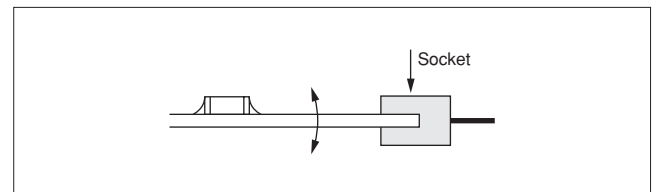

#### 2-4. Tightening Screws

The board may be bent, when tightening screws, etc. during the attachment of the board to a shield or chassis.

Pay attention to the following items before performing the work.

- Plan the work to prevent the board from bending.
- Use a torque screwdriver, to prevent over-tightening of the screws.
- The board may bend after mounting by reflow soldering, etc. Please note, as stress may be applied to the chips by forcibly flattening the board when tightening the screws.

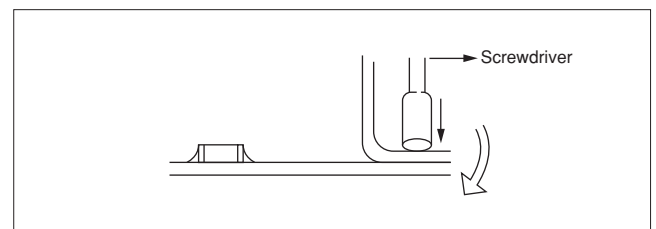

Continued on the following page. ☐

## ⚠Caution

☐ Continued from the preceding page.

<Applicable to GMA or GMD Series>

### 9. Die Bonding/Wire Bonding

#### 1. Die Bonding of Capacitors

1-1. Use the following materials for the Brazing alloys:

Au-Sn (80/20) 300 to 320 °C in N<sub>2</sub> atmosphere

1-2. Mounting

- (1) Control the temperature of the substrate so it matches the temperature of the brazing alloy.
- (2) Place the brazing alloy on the substrate and place the capacitor on the alloy. Hold the capacitor and gently apply the load. Be sure to complete the operation within 1 minute.

#### 2. Wire Bonding

2-1. Wire

Gold wire: 25 micro m (0.001 inch) diameter

2-2. Bonding

- (1) Thermo compression, ultrasonic ball bonding.
- (2) Required stage temperature: 150 to 200 °C
- (3) Required wedge or capillary weight: 0.2N to 0.5N
- (4) Bond the capacitor and base substrate or other devices with gold wire.

### ■ Other

#### 1. Under Operation of Equipment

- 1-1. Do not touch a capacitor directly with bare hands during operation in order to avoid the danger of an electric shock.
- 1-2. Do not allow the terminals of a capacitor to come in contact with any conductive objects (short-circuit). Do not expose a capacitor to a conductive liquid, including any acid or alkali solutions.
- 1-3. Confirm the environment in which the equipment will operate is under the specified conditions. Do not use the equipment under the following environments.
  - (1) Being splattered with water or oil.
  - (2) Being exposed to direct sunlight.
  - (3) Being exposed to ozone, ultraviolet rays, or radiation.
  - (4) Being exposed to toxic gas (e.g., hydrogen sulfide, sulfur dioxide, chlorine, ammonia gas, etc.)
  - (5) Any vibrations or mechanical shocks exceeding the specified limits.
  - (6) Moisture condensing environments.
- 1-4. Use damp proof countermeasures if using under any conditions that can cause condensation.

#### 2. Other

2-1. In an Emergency

- (1) If the equipment should generate smoke, fire, or smell, immediately turn off or unplug the equipment. If the equipment is not turned off or unplugged, the hazards may be worsened by supplying continuous power.
- (2) In this type of situation, do not allow face and hands to come in contact with the capacitor or burns may be caused by the capacitor's high temperature.

2-2. Disposal of Waste

When capacitors are disposed of, they must be burned or buried by an industrial waste vendor with the appropriate licenses.

2-3. Circuit Design

(1) Addition of Fail Safe Function

Capacitors that are cracked by dropping or bending of the board may cause deterioration of the insulation resistance, and result in a short. If the circuit being used may cause an electrical shock, smoke or fire when a capacitor is shorted, be sure to install fail-safe functions, such as a fuse, to prevent secondary accidents.

- (2) Capacitors used to prevent electromagnetic interference in the primary AC side circuit, or as a connection/insulation, must be a safety standard certified product, or satisfy the contents stipulated in the Electrical Appliance and Material Safety Law. Install a fuse for each line in case of a short.
- (3) The GJM, GMA, GMD, GQM, GR3, GRJ, GRM, KR3, KRM, LLA, LLL, LLM and LLR series are not safety standard certified products.

2-4. Remarks

Failure to follow the cautions may result, worst case, in a short circuit and smoking when the product is used.

The above notices are for standard applications and conditions. Contact us when the products are used in special mounting conditions.

Select optimum conditions for operation as they determine the reliability of the product after assembly. The data herein are given in typical values, not guaranteed ratings.

■ Rating

1. Operating Temperature

1. The operating temperature limit depends on the capacitor.

1-1. Do not apply temperatures exceeding the upper operating temperature.

It is necessary to select a capacitor with a suitable rated temperature that will cover the operating temperature range.

It is also necessary to consider the temperature distribution in equipment and the seasonal temperature variable factor.

1-2. Consider the self-heating factor of the capacitor.

The surface temperature of the capacitor shall be the upper operating temperature or less when including the self-heating factors.

2. Atmosphere Surroundings (gaseous and liquid)

1. Restriction on the operating environment of capacitors.

1-1. Capacitors, when used in the above, unsuitable,

operating environments may deteriorate due to the corrosion of the terminations and the penetration of moisture into the capacitor.

1-2. The same phenomenon as the above may occur when the electrodes or terminals of the capacitor are subject to moisture condensation.

1-3. The deterioration of characteristics and insulation resistance due to the oxidization or corrosion of terminal electrodes may result in breakdown when the capacitor is exposed to corrosive or volatile gases or solvents for long periods of time.

3. Piezo-electric Phenomenon

1. When using high dielectric constant type capacitors in AC or pulse circuits, the capacitor itself vibrates at specific frequencies and noise may be generated. Moreover, when the mechanical vibration or shock is added to the capacitor, noise may occur.

■ Soldering and Mounting

1. PCB Design

1. Notice for Pattern Forms

1-1. Unlike leaded components, chip components are susceptible to flexing stresses since they are mounted directly on the substrate.

They are also more sensitive to mechanical and thermal stresses than leaded components.

Excess solder fillet height can multiply these stresses and cause chip cracking. When designing substrates, take land patterns and dimensions into consideration to eliminate the possibility of excess solder fillet height.

1-2. There is a possibility of chip cracking caused by PCB expansion/contraction with heat, because stress on a chip is different depending on PCB material and structure. When the thermal expansion coefficient greatly differs between the board used for mounting and the chip, it will cause cracking of the chip due to the thermal expansion and contraction. When capacitors are mounted on a fluorine resin printed circuit board or on a single-layered glass epoxy board, it may also cause cracking of the chip for the same reason.

Pattern Forms

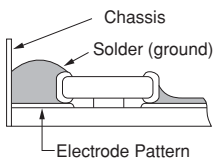
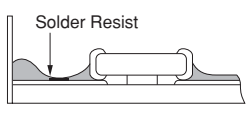
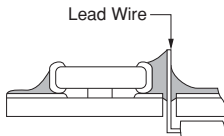
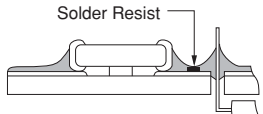
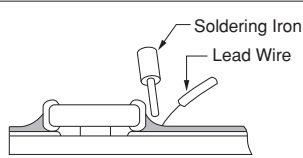
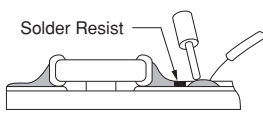
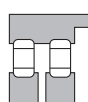
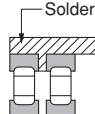
|   | Prohibited  | Correct   |
|---|---|---|
| Placing Close to Chassis                          |  |  |
| Placing of Chip Components and Leaded Components  |  |  |
| Placing of Leaded Components after Chip Component |  |  |
| Lateral Mounting                                  |  |  |

Continued on the following page. ↗

## Notice

☐ Continued from the preceding page.

### 2. Land Dimensions

2-1. Chip capacitors can be cracked due to the stress of PCB bending, etc. if the land area is larger than needed and has an excess amount of solder. Please refer to the land dimensions in table 1 for flow soldering, table 2 for reflow soldering, table 3 for reflow soldering for LLA Series, table 4 for reflow soldering for LLM Series. Please confirm the suitable land dimension by evaluating of the actual SET / PCB.

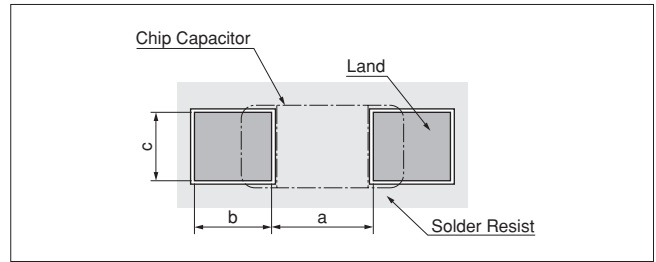

**Table 1 Flow Soldering Method**

| Part Number                           | Dimensions | Chip (L×W) | a          | b          | c          |
|---------------------------------------|------------|------------|------------|------------|------------|
| <b>GQM/GR3/GRJ/GRM</b> Series 18 size |            | 1.6×0.8    | 0.6 to 1.0 | 0.8 to 0.9 | 0.6 to 0.8 |
| <b>GQM/GR3/GRJ/GRM</b> Series 21 size |            | 2.0×1.25   | 1.0 to 1.2 | 0.9 to 1.0 | 0.8 to 1.1 |
| <b>GR3/GRJ/GRM</b> Series 31 size     |            | 3.2×1.6    | 2.2 to 2.6 | 1.0 to 1.1 | 1.0 to 1.4 |
| <b>LLL</b> Series 21 size             |            | 1.25×2.0   | 0.4 to 0.7 | 0.5 to 0.7 | 1.4 to 1.8 |
| <b>LLL</b> Series 31 size             |            | 1.6×3.2    | 0.6 to 1.0 | 0.8 to 0.9 | 2.6 to 2.8 |

Flow soldering can only be used for products with a chip size from 1.6x0.8mm to 3.2x1.6mm.

(in mm)

**Table 2 Reflow Soldering Method**

| Part Number                           | Dimensions | Chip (L×W)              | a            | b            | c           |
|---------------------------------------|------------|-------------------------|--------------|--------------|-------------|
| <b>GJM/GRM</b> Series 02 size         |            | 0.4×0.2                 | 0.16 to 0.2  | 0.12 to 0.18 | 0.2 to 0.23 |
| <b>GJM/GRM</b> Series 03 size         |            | 0.6×0.3                 | 0.2 to 0.3   | 0.2 to 0.35  | 0.2 to 0.4  |
| <b>GJM/GRM</b> Series 15 size         |            | 1.0×0.5 (within ±0.10)  | 0.3 to 0.5   | 0.35 to 0.45 | 0.4 to 0.6  |
|                                       |            | 1.0×0.5 (±0.15/±0.20)   | 0.4 to 0.6   | 0.4 to 0.5   | 0.5 to 0.7  |
| <b>GQM/GR3/GRJ/GRM</b> Series 18 size |            | 1.6×0.8 (within ±0.10)  | 0.6 to 0.8   | 0.6 to 0.7   | 0.6 to 0.8  |
|                                       |            | 1.6×0.8 (±0.15/±0.20)   | 0.7 to 0.9   | 0.7 to 0.8   | 0.8 to 1.0  |
| <b>GQM</b> Series 21 size             |            | 2.0×1.25                | 1.0 to 1.2   | 0.6 to 0.7   | 0.8 to 1.1  |
|                                       |            | 2.0×1.25 (within ±0.10) | 1.2          | 0.6          | 1.25        |
| <b>GR3/GRJ/GRM</b> Series 21 size     |            | 2.0×1.25 (±0.15)        | 1.2          | 0.6 to 0.8   | 1.2 to 1.4  |
|                                       |            | 2.0×1.25 (±0.20)        | 1.0 to 1.4   | 0.6 to 0.8   | 1.2 to 1.4  |
|                                       |            | 3.2×1.6 (within ±0.20)  | 1.8 to 2.0   | 0.9 to 1.2   | 1.5 to 1.7  |
| <b>GR3/GRJ/GRM</b> Series 31 size     |            | 3.2×1.6 (±0.30)         | 1.9 to 2.1   | 1.0 to 1.3   | 1.7 to 1.9  |
|                                       |            | 3.2×2.5                 | 2.0 to 2.4   | 1.0 to 1.2   | 1.8 to 2.3  |
| <b>GR3/GRJ/GRM</b> Series 43 size     |            | 4.5×3.2                 | 3.0 to 3.5   | 1.2 to 1.4   | 2.3 to 3.0  |
| <b>GR3/GRJ/GRM</b> Series 55 size     |            | 5.7×5.0                 | 4.0 to 4.6   | 1.4 to 1.6   | 3.5 to 4.8  |
| <b>LLL</b> Series 15 size             |            | 0.5×1.0                 | 0.15 to 0.2  | 0.2 to 0.25  | 0.7 to 1.0  |
| <b>LLL</b> Series 1U size             |            | 0.6×1.0                 | 0.20 to 0.25 | 0.25 to 0.35 | 0.7 to 1.0  |
| <b>LLL/LLR</b> Series 18 size         |            | 0.8×1.6                 | 0.2 to 0.3   | 0.3 to 0.4   | 1.4 to 1.6  |
| <b>LLL</b> Series 21 size             |            | 1.25×2.0                | 0.4 to 0.5   | 0.4 to 0.5   | 1.4 to 1.8  |
| <b>LLL</b> Series 31 size             |            | 1.6×3.2                 | 0.6 to 0.8   | 0.6 to 0.7   | 2.6 to 2.8  |
| <b>GQM</b> Series 22 size             |            | 2.8×2.8                 | 2.2 to 2.5   | 0.8 to 1.0   | 1.9 to 2.3  |

(in mm)

<Applicable to Part Number KR3/KRM>

| Part Number                   | Dimensions | Chip (L×W) | a          | b          | c          |
|-------------------------------|------------|------------|------------|------------|------------|
| <b>KRM</b> Series 21 size     |            | 2.0×1.25   | 1.0 to 1.2 | 0.6 to 0.7 | 0.8 to 1.1 |
| <b>KRM</b> Series 31 size     |            | 3.2×1.6    | 2.2 to 2.4 | 0.8 to 0.9 | 1.0 to 1.4 |
| <b>KR3/KRM</b> Series 55 size |            | 5.7×5.0    | 2.6        | 2.7        | 5.6        |

(in mm)

Continued on the following page. ☐



Continued from the preceding page.

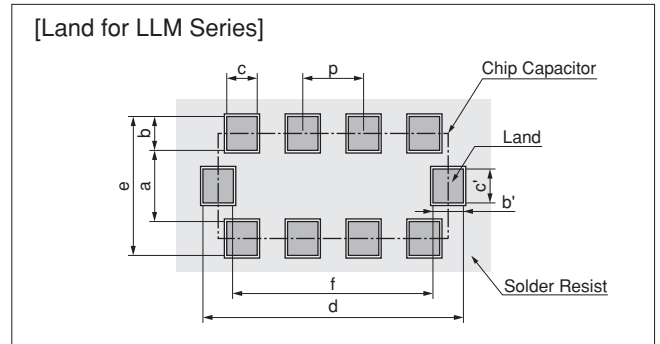
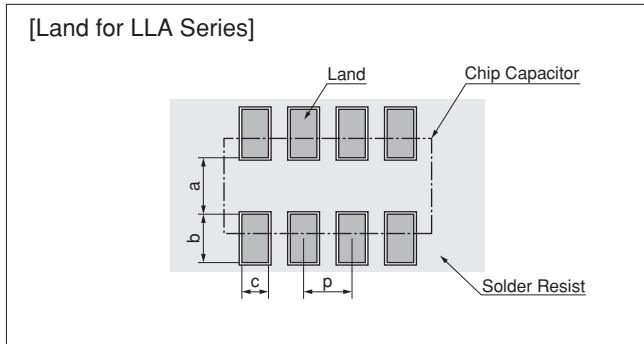

Table 3 LLA Series Reflow Soldering Method

| Part Number        | Dimensions | Chip (L×W) | a          | b            | c            | p   |
|--------------------|------------|------------|------------|--------------|--------------|-----|
| LLA Series 18 size |            | 1.6×0.8    | 0.3 to 0.4 | 0.25 to 0.35 | 0.15 to 0.25 | 0.4 |
| LLA Series 21 size |            | 2.0×1.25   | 0.5 to 0.7 | 0.35 to 0.6  | 0.2 to 0.3   | 0.5 |
| LLA Series 31 size |            | 3.2×1.6    | 0.7 to 0.9 | 0.4 to 0.7   | 0.3 to 0.4   | 0.8 |

(in mm)

Table 4 LLM Series Reflow Soldering Method

| Part Number        | Dimensions | Chip (L×W) | a          | b, b'        | c, c' | d          | e          | f          | p   |
|--------------------|------------|------------|------------|--------------|-------|------------|------------|------------|-----|
| LLM Series 21 size |            | 2.0×1.25   | 0.6 to 0.8 | (0.3 to 0.5) | 0.3   | 2.0 to 2.6 | 1.3 to 1.8 | 1.4 to 1.6 | 0.5 |
| LLM Series 31 size |            | 3.2×1.6    | 1.0        | (0.3 to 0.5) | 0.4   | 3.2 to 3.6 | 1.6 to 2.0 | 2.6        | 0.8 |

$b=(c-e)/2, b'=(d-f)/2$

(in mm)

<Applicable to beyond Rated Voltage of 250VDC>

2-2. Dimensions of Slit (Example)

Preparing the slit helps flux cleaning and resin coating on the back of the capacitor.

However, the length of the slit design should be as short as possible to prevent mechanical damage in the capacitor.

A longer slit design might receive more severe mechanical stress from the PCB.

Recommended slit design is shown in the Table.

| L×W      | d          | e          |
|----------|------------|------------|
| 1.6×0.8  | —          | —          |
| 2.0×1.25 | —          | —          |
| 3.2×1.6  | 1.0 to 2.0 | 3.2 to 3.7 |
| 3.2×2.5  | 1.0 to 2.0 | 4.1 to 4.6 |
| 4.5×2.0  | 1.0 to 2.8 | 3.6 to 4.1 |
| 4.5×3.2  | 1.0 to 2.8 | 4.8 to 5.3 |
| 5.7×2.8  | 1.0 to 4.0 | 4.4 to 4.9 |
| 5.7×5.0  | 1.0 to 4.0 | 6.6 to 7.1 |

(in mm)

Continued on the following page. ↗

GRM Series  
 GJM Series  
 GMA Series  
 GMD Series  
 GQM Series  
 GRJ Series  
 GR3 Series  
 KRM Series  
 KR3 Series  
 LLA Series  
 LLL Series  
 LLM Series  
 LLR Series  
 Notice

# Notice

☐ Continued from the preceding page.

## 3. Board Design

When designing the board, keep in mind that the amount of strain which occurs will increase depending on the size and material of the board.

[Relationship with amount of strain to the board thickness, length, width, etc.]

$$\epsilon = \frac{3PL}{2Ewh^2}$$

Relationship between load and strain

- ε: Strain on center of board (μst)
- L: Distance between supporting points (mm)
- w: Board width (mm)
- h: Board thickness (mm)
- E: Elastic modulus of board (N/m<sup>2</sup>=Pa)
- Y: Deflection (mm)
- P: Load (N)

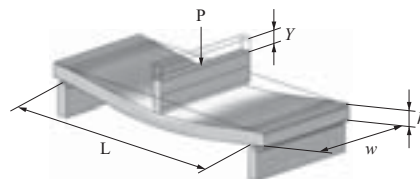

- When the load is constant, the following relationship can be established.
- As the distance between the supporting points (L) increases, the amount of strain also increases.  
→Reduce the distance between the supporting points.
  - As the elastic modulus (E) decreases, the amount of strain increases.  
→Increase the elastic modulus.
  - As the board width (w) decreases, the amount of strain increases.  
→Increase the width of the board.
  - As the board thickness (h) decreases, the amount of strain increases.  
→Increase the thickness of the board.
- Since the board thickness is squared, the effect on the amount of strain becomes even greater.

## 2. Adhesive Application

1. Thin or insufficient adhesive can cause the chips to loosen or become disconnected during flow soldering. The amount of adhesive must be more than dimension c, shown in the drawing at right, to obtain the correct bonding strength.

The chip's electrode thickness and land thickness must also be taken into consideration.

2. Low viscosity adhesive can cause chips to slip after mounting. The adhesive must have a viscosity of 5000Pa · s (500ps) min. (at 25°C).

## 3. Adhesive Coverage

| Size (L×W) (in mm) | Adhesive Coverage* |
|--------------------|--------------------|
| 1.6×0.8            | 0.05mg min.        |
| 2.0×1.25           | 0.1mg min.         |
| 3.2×1.6            | 0.15mg min.        |

\*Nominal Value

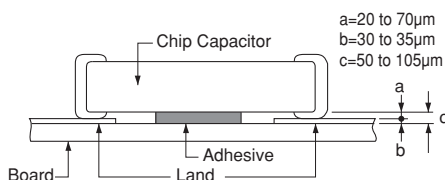

## 3. Adhesive Curing

1. Insufficient curing of the adhesive can cause chips to disconnect during flow soldering and causes deterioration in the insulation resistance between the outer electrodes due to moisture absorption.

Control curing temperature and time in order to prevent insufficient hardening.

Continued on the following page. ↗

☐ Continued from the preceding page.

#### 4. Flux for Reflow and Flow Soldering

1. An excessive amount of flux generates a large quantity of flux gas, which can cause a deterioration of solder ability, so apply flux thinly and evenly throughout. (A foaming system is generally used for flow soldering.)
2. Flux containing too high a percentage of halide may cause corrosion of the outer electrodes unless there is sufficient cleaning. Use flux with a halide content of 0.1% max.

3. Do not use strong acidic flux.
4. Do not use water-soluble flux.\*  
 (\*Water-soluble flux can be defined as non-rosin type flux including wash-type flux and non-wash-type flux.)

#### 5. Flow Soldering

- Set temperature and time to ensure that leaching of the outer electrode does not exceed 25% of the chip end area as a single chip (full length of the edge A-B-C-D shown at right) and 25% of the length A-B shown as mounted on substrate.

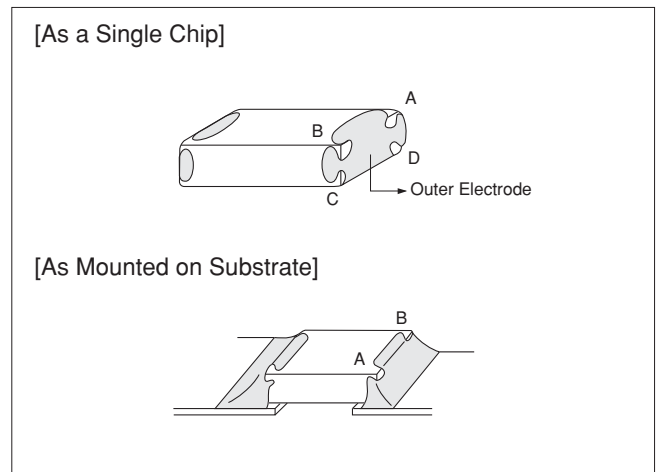

#### 6. Washing

1. Please evaluate the capacitor using actual cleaning equipment and conditions to confirm the quality, and select the solvent for cleaning.
2. Unsuitable cleaning solvent may leave residual flux or other foreign substances, causing deterioration of electrical characteristics and the reliability of the capacitors.

3. Select the proper cleaning conditions.  
 3-1. Improper cleaning conditions (excessive or insufficient) may result in deterioration of the performance of the capacitors.

#### 7. Coating

1. A crack may be caused in the capacitor due to the stress of the thermal contraction of the resin during curing process.  
 The stress is affected by the amount of resin and curing contraction.  
 Select a resin with low curing contraction.  
 The difference in the thermal expansion coefficient between a coating resin or a molding resin and the capacitor may cause the destruction and deterioration of the capacitor such as a crack or peeling, and lead to the deterioration of insulation resistance or dielectric breakdown.  
 Select a resin for which the thermal expansion coefficient is as close to that of the capacitor as possible.  
 A silicone resin can be used as an under-coating to buffer against the stress.

2. Select a resin that is less hygroscopic.  
 Using hygroscopic resins under high humidity conditions may cause the deterioration of the insulation resistance of a capacitor.  
 An epoxy resin can be used as a less hygroscopic resin.

Continued on the following page. ↗

## Notice

☐ Continued from the preceding page.

### ■ Other

#### 1. Transportation

1. The performance of a capacitor may be affected by the conditions during transportation.

1-1. The capacitors shall be protected against excessive temperature, humidity, and mechanical force during transportation.

(1) Climatic condition

- low air temperature: -40°C
- change of temperature air/air: -25°C/+25°C
- low air pressure: 30 kPa
- change of air pressure: 6 kPa/min.

(2) Mechanical condition

Transportation shall be done in such a way that the boxes are not deformed and forces are not directly passed on to the inner packaging.

1-2. Do not apply excessive vibration, shock, or pressure to the capacitor.

(1) When excessive mechanical shock or pressure is applied to a capacitor, chipping or cracking may occur in the ceramic body of the capacitor.

(2) When the sharp edge of an air driver, a soldering iron, tweezers, a chassis, etc. impacts strongly on the surface of the capacitor, the capacitor may crack and short-circuit.

1-3. Do not use a capacitor to which excessive shock was applied by dropping, etc.

A capacitor dropped accidentally during processing may be damaged.

#### 2. Characteristics Evaluation in the Actual System

1. Evaluate the capacitor in the actual system, to confirm that there is no problem with the performance and specification values in a finished product before using.

2. Since a voltage dependency and temperature dependency exists in the capacitance of high dielectric type ceramic capacitors, the capacitance may change depending on the operating conditions in the actual system. Therefore, be sure to evaluate the various characteristics, such as the leakage current and noise absorptivity, which will affect the capacitance value of the capacitor.

3. In addition, voltages exceeding the predetermined surge may be applied to the capacitor by the inductance in the actual system. Evaluate the surge resistance in the actual system as required.

GRM Series

GJM Series

GMA Series

GMD Series

GQM Series

GRJ Series

GR3 Series

KRM Series

KR3 Series

LLA Series

LLL Series

LLM Series

LLR Series

Notice

## Qualified Standards

The products listed here have been produced by ISO 9001 certified factory.

| Plant                                    |
|--|
| Fukui Murata Mfg. Co., Ltd.              |
| Izumo Murata Mfg. Co., Ltd.              |
| Okayama Murata Mfg. Co., Ltd.            |
| Murata Electronics Singapore (Pte.) Ltd. |
| Beijing Murata Electronics Co., Ltd.     |
| Wuxi Murata Electronics Co., Ltd.        |



# Design assistant tool: SimSurfing SimSurfing

## MLCC is now available !

Design assistant tool "SimSurfing" has been updated and you can now find and view any kind of characteristics of MLCCs.

### Available function for MLCCs:

- ① Products search
- ② View frequency characteristics (S parameters, Z, R, X, Q, DF, L, C)  
 DC bias can be applied to available part number.
- ③ DC voltage bias characteristics (absolute capacitance/change rate)
- ④ Temperature characteristics (absolute capacitance/change rate)
- ⑤ AC voltage bias characteristics (absolute capacitance/change rate)
- ⑥ Download SPICE netlist/S parameter

**Enhanced SimSurfing**  
 If you register members only engineers portal site "my Murata", you can use the Enhanced SimSurfing.  
 Member Registration  
<https://my.murata.com/>

### 1 Select the Products

- (1) By part number
- (2) By specification

### 2 View characteristics

By clicking buttons in this area with part number selected, you can view any electrical characteristics chart.

### 3 Data download

You can download SPICE netlist and S parameter files (S2P)



Added the capacitor finder tool for middle and high voltage capacitor which are capable for specified voltage waveform.

These images are captured at August/2014. Be sure that this software will be updated frequently.

<http://ds.murata.com/software/simsurfing/en-us/mlcc/>

# Capacitor Website Introduction



Search for Capacitors

Global

Murata capacitors can be searched.

1 Search by part number

2 Search by specifications

3 Search by features

4 Search in the lineups

5 Cross reference

## 1 Search by part number <http://psearch.murata.com/capacitor/partnumber/>



The applicable capacitors can be searched by alphanumeric characters. Although the alternative symbol "#" is used for the package specification code, you can also enter the full package specification code to search the part number including the package specification code.

## 2 Search by specifications <http://psearch.murata.com/capacitor/spec/>

Capacitors can be searched by various specifications, such as the capacitance, rated voltage, and temperature characteristics.

### Basic specifications

Applicable products can be searched by any value and specified range. To support the entry, the minimum and maximum values of the product applicable to the conditions selected in the other items will be displayed.

### Add detailed specifications

Setting the conditions particular to the SMD, mold and lead, enables you to search the product with a more detailed specification.

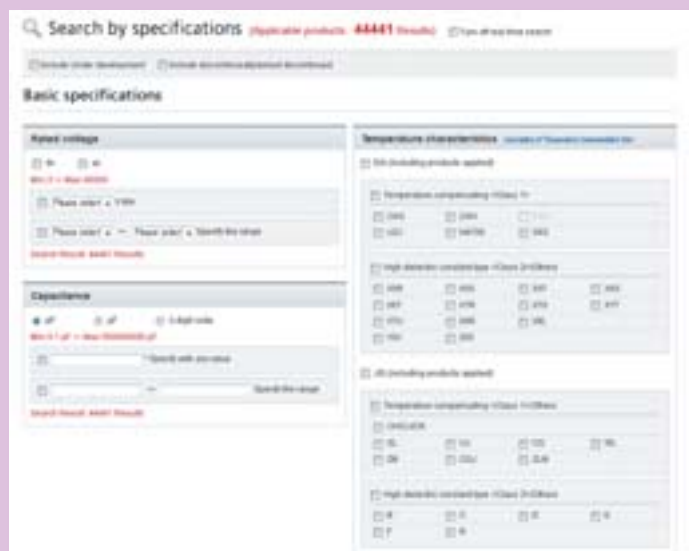

## 3 Search by features <http://psearch.murata.com/capacitor/feature/>

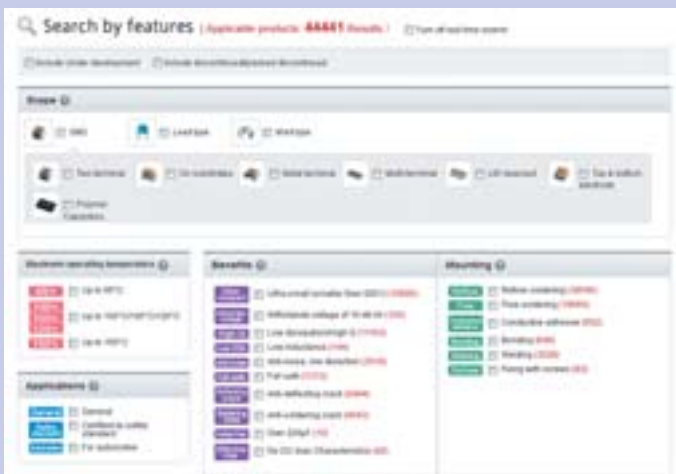

The applicable capacitors can be searched by the Shape, Maximum operating temperature, Applications, Benefits, and Mounting.

Select the conditions of the following items to search for a product.

- "Shape"
- "Maximum operating temperature"
- "Applications"
- "Benefits"
- "Mounting"



#### 4 Search in the lineups <http://psearch.murata.com/capacitor/lineup/>

Capacitors applicable to the conditions can be searched from the lineup of each series.

The features and applications of the series can also be checked in the Series page.

Capacitance chart in Series page

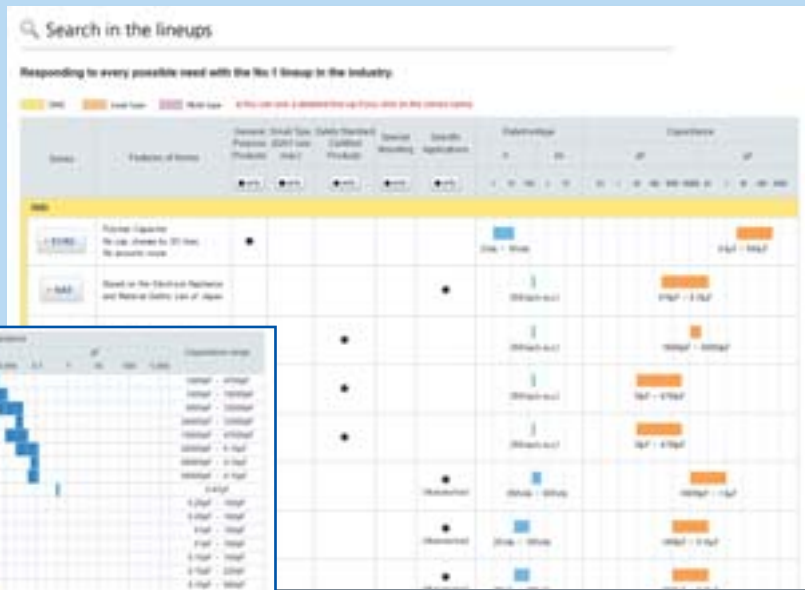

#### 5 Cross reference <http://cross-reference.murata.com/capacitor/crossreference/index.cfm>

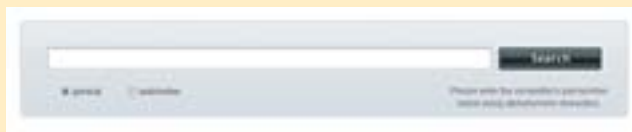

The Murata part number applicable to the assumed specification can be searched by the competitor's part number of the chip monolithic ceramic capacitors.

#### [Search result]

**Applicable products 29752 results**

The number of cases applicable to the current search conditions is always displayed in real time.

Click each search condition button to display the menu. The search results will change in real time with the selected conditions.

Clicking the "Current search conditions" opens a menu, and the current narrowed down conditions can be checked.

The results can be sorted by clicking the ▲ button of the search results items.

Clicking the product name opens the details page, and more detailed information can be acquired.

A simple specification sheet can be downloaded without opening the details page.

The icons clearly indicate the status and the features of the product.

# Global Locations

For details please visit [www.murata.com](http://www.murata.com)



## ⚠ Note

### 1 Export Control

#### For customers outside Japan:

No Murata products should be used or sold, through any channels, for use in the design, development, production, utilization, maintenance or operation of, or otherwise contribution to (1) any weapons (Weapons of Mass Destruction [nuclear, chemical or biological weapons or missiles] or conventional weapons) or (2) goods or systems specially designed or intended for military end-use or utilization by military end-users.

#### For customers in Japan:

For products which are controlled items subject to the "Foreign Exchange and Foreign Trade Law" of Japan, the export license specified by the law is required for export.

2 Please contact our sales representatives or product engineers before using the products in this catalog for the applications listed below, which require especially high reliability for the prevention of defects which might directly damage a third party's life, body or property, or when one of our products is intended for use in applications other than those specified in this catalog.

- ① Aircraft equipment
- ② Aerospace equipment
- ③ Undersea equipment
- ④ Power plant equipment
- ⑤ Medical equipment
- ⑥ Transportation equipment (vehicles, trains, ships, etc.)
- ⑦ Traffic signal equipment
- ⑧ Disaster prevention / crime prevention equipment
- ⑨ Data-processing equipment
- ⑩ Application of similar complexity and/or reliability requirements to the applications listed above

3 Product specifications in this catalog are as of August 2014. They are subject to change or our products in it may be discontinued without advance notice. Please check with our sales representatives or product engineers before ordering. If there are any questions, please contact our sales representatives or product engineers.

4 Please read rating and ⚠CAUTION (for storage, operating, rating, soldering, mounting and handling) in this catalog to prevent smoking and/or burning, etc.

5 This catalog has only typical specifications. Therefore, please approve our product specifications or transact the approval sheet for product specifications before ordering.

6 Please note that unless otherwise specified, we shall assume no responsibility whatsoever for any conflict or dispute that may occur in connection with the effect of our and/or a third party's intellectual property rights and other related rights in consideration of your use of our products and/or information described or contained in our catalogs. In this connection, no representation shall be made to the effect that any third parties are authorized to use the rights mentioned above under licenses without our consent.

7 No ozone depleting substances (ODS) under the Montreal Protocol are used in our manufacturing process.

Murata Manufacturing Co., Ltd.

[www.murata.com](http://www.murata.com)

**muRata**  
INNOVATOR IN ELECTRONICS

## X-ON Electronics

Largest Supplier of Electrical and Electronic Components

*Click to view similar products for [Multilayer Ceramic Capacitors MLCC - SMD/SMT](#) category:*

*Click to view products by [Murata](#) manufacturer:*

Other Similar products are found below :

[M39014/01-1467](#) [M39014/02-1218V](#) [M39014/02-1225V](#) [M39014/02-1262V](#) [M39014/02-1301](#) [M39014/22-0631](#) [1210J5000102JCT](#)  
[1210J2K00102KXT](#) [1210J5000103KXT](#) [1210J5000223KXT](#) [D55342E07B379BR-TR](#) [D55342E07B523DR-T/R](#) [1812J1K00103KXT](#)  
[1812J1K00473KXT](#) [1812J2K00680JCT](#) [1812J4K00102MXT](#) [1812J5000102JCT](#) [1812J5000103JCT](#) [1812J5000682JCT](#) [NIN-FB391JTRF](#)  
[NIN-FC2R7JTRF](#) [NPIS27H102MTRF](#) [C1206C101J1GAC](#) [C1608C0G1E472JT000N](#) [C2012C0G2A472J](#) [2220J2K00101JCT](#)  
[KHC201E225M76N0T00](#) [LRC-LRF1206LF-01R025FTR1K](#) [1812J1K00222JCT](#) [1812J2K00102KXT](#) [1812J2K00222KXT](#)  
[1812J2K00472KXT](#) [2-1622820-7-CUT-TAPE](#) [2220J3K00102KXT](#) [2225J2500824KXT](#) [CCR07CG103KM](#) [CGA2B2C0G1H010C](#)  
[CGA2B2C0G1H040C](#) [CGA2B2C0G1H050C](#) [CGA2B2C0G1H060D](#) [CGA2B2C0G1H070D](#) [CGA2B2C0G1H151J](#) [CGA2B2C0G1H1R5C](#)  
[CGA2B2C0G1H2R2C](#) [CGA2B2C0G1H3R3C](#) [CGA2B2C0G1H680J](#) [CGA2B2C0G1H6R8D](#) [CGA2B2X8R1H221K](#) [CGA2B2X8R1H472K](#)  
[CGA3E1X7R1C474K](#)