

# Chip Multilayer Ceramic Capacitors for General

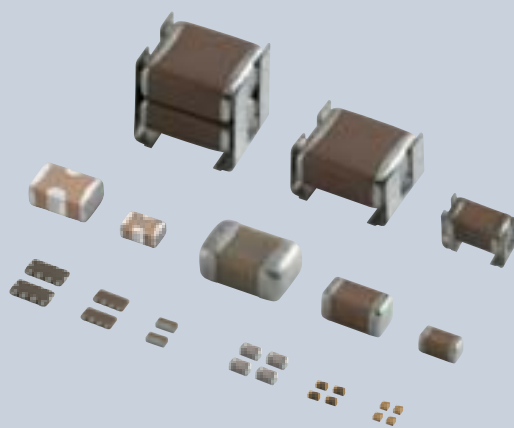

2018

# Explanation of Symbols in This Catalog



Links are provided to the latest information from the PDF version of the catalog, which is available on the web.

|                            |   |
|----------------------------|---|
| <b>General</b>             | For applications that do not require the particular reliability such as the general equipment   |
| <b>Info-tainment</b>       | Infotainment for Automotive<br>The product for entertainment equipment like car navigations, car audios, and body control equipment like wipers, power windows.   |
| <b>Powertrain</b>          | Powertrain/Safety for Automotive<br>Product used for applications (running, turning, stopping and safety devices) which particularly concern human life, such as in devices for automobiles.  |
| <b>Medical Device</b>      | Medical-grade products for Implanted Medical Devices<br>These products are intended for use in implanted medical devices such as cardiac pacemakers, cochlear implants, insulin pumps and gastric electrostimulators.<br>They are suitable for use in non-critical circuits. *1<br>*1 Non-critical circuits<br>This term refers to circuits in implanted medical devices that are not directly linked to life support, i.e. circuits that will not directly endanger the life of the patient should the functionality of the device be reduced or halted by failure of the circuit. |
| <b>AEC-Q200</b>            | AEC-Q200 compliant product  |
| <b>Safety standard</b>     | Safety Standard Certified Product<br>Products that acquired safety standard certification IEC60384-14 and products based on the Electrical Appliance and Material Safety Law of Japan.  |
| <b>Japanese Safety Law</b> | Based on the Electrical Appliance and Material Safety Law of Japan<br>Products that are based on the electrical appliance and material safety law of Japan.   |
| <b>High Q</b>              | Low dissipation for high frequency<br>By devising ceramic materials and electrode materials, low dissipation is achieved in frequency bands of VHF, UHF and microwave or beyond.  |
| <b>Low ESL</b>             | Low inductance<br>This capacitor is designed so that the parasitic inductance component (ESL) that the capacitor has on the high frequency side becomes lower.  |
| <b>Fail safe</b>           | Fail safe product<br>This capacitor is designed to prevent failures as much as possible by short mode.  |
| <b>Deflecting crack</b>    | Product resistant to deflection cracking<br>This capacitor is designed to prevent failures as much as possible by short mode caused by cracking when there is board deflection.   |
| <b>Soldering crack</b>     | Product with solder cracking suppression<br>"This capacitor is configured with metal terminals and leads connected to the chip. The metal terminals and leads relieve the stress from expansion and contraction of the solder, to suppress solder cracking."  |
| <b>Anti-noise</b>          | Product suitable for acoustic noise reduction and low distortion<br>This product suppresses acoustic noise, which occurs when a ceramic capacitor is used, by devising the materials and configuration.   |
| <b>Effective Cap</b>       | No DC bias characteristics<br>Polymer capacitor is no capacitance change with DC bias due to aluminum oxidized film for dielectric.   |
| <b>EMI FIL®</b>            | Low-inductance product suitable for noise suppression.<br>This product has extremely low ESL and is suitable for suppression of noise, including high frequencies.<br>This product can also be used as a low-ESL, high-performance bypass capacitor.  |
| <b>Bonding</b>             | Product for bonding<br>Since gold is used for the external electrodes, the capacitor can be mounted by die bonding/wire bonding.  |

**Derating 1**  
 This product is suitable when a voltage continuously applied to a capacitor in an operating circuit, is used below (derated) the rated voltage of the capacitor. This model guarantees the test conditions in the endurance test, at a rated voltage x 100% at the maximum operating temperature. A reliability assurance level equivalent to a common product can be secured, by using this product within the voltage and temperature derated conditions recommended in the figure below.

Recommended Conditions of the Derating Operating Voltage and Temperature

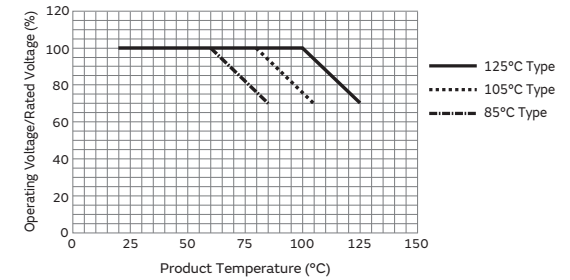

**D1**  
 Derating 1

**Derating 2**  
 When the product temperature exceeds 105°C, please use this product within the voltage and temperature derated conditions in the figure below.

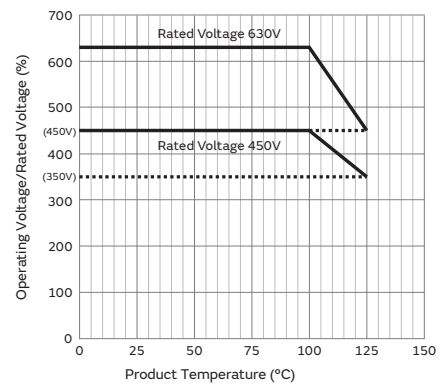

**D2**  
 Derating 2

**Derating 3**  
 Please apply the derating curve according to the operating temperature.  
 Please refer to detailed specifications sheet for details.

**D3**  
 Derating 3

**Derating 4**  
 When the product temperature exceeds 125°C, please use this product within the voltage and temperature derated conditions in the figure below.

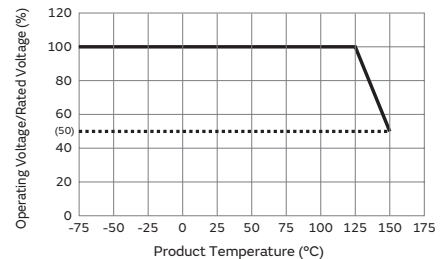

**D4**  
 Derating 4

**Derating 5**  
 Please apply the rated voltage derating over 150 °C.  
 Please refer to detailed specifications sheet for details.

**D5**  
 Derating 5

# Selection Guide for Capacitors

| For general                |     |   |      |
|----------------------------|-----|---|------|
| General SMD                |     |   |      |
| Solder mounting            |     |   |      |
| Chip type                  |     |   |      |
|                            | GRM |   | p40  |
|                            | GRM | For LCD backlight inverter circuit only   | WEB  |
|                            | GR3 | Anti-noise<br>High effective capacitance & high ripple current                            | p109 |
|                            | GRJ | Deflecting crack<br>Soft termination  | p120 |
|                            | GXM | Water Repellent   | WEB  |
|                            | GR4 | For information devices only  | p125 |
|                            | GR7 | For camera flash circuit only   | p130 |
|                            | GJM | High Q  | p135 |
|                            | GQM | High Q  | p164 |
|                            | GA2 | Japanese Safety Law<br>Based on the Electrical Appliance and Material Safety Law of Japan | p184 |
|                            | GA3 | Safety standard   | p189 |
|                            | LLL | Low ESL<br>LW reversed  | p219 |
|                            | LLA | Low ESL<br>8 terminals  | p222 |
|                            | LLM | Low ESL<br>10 terminals   | p228 |
|                            | LLR | Low ESL<br>LW reversed controlled ESR   | p232 |
|                            | NFM | Low ESL<br>3 terminals  | p236 |
|                            | GJ4 | Anti-noise<br>Low distortion  | WEB  |
|                            | GJ8 | Anti-noise<br>Low acoustic noise  | WEB  |
| On interposer board        |     |   |      |
|                            | ZRA | Anti-noise  | WEB  |
|                            | ZRB | Anti-noise  | WEB  |
| Metal terminal type        |     |   |      |
|                            | KRM | Anti-noise<br>Deflecting crack<br>Soldering crack   | p239 |
|                            | KR3 | Anti-noise<br>Deflecting crack<br>Soldering crack   | p243 |
| Resin molding SMD type     |     |   |      |
|                            | DK1 | Safety standard   | WEB  |
| Wire bonding mounting      |     |   |      |
| Chip type                  |     |   |      |
|                            | GMA | Microchip   | p249 |
|                            | GMD |   | p256 |
| Lead type                  |     |   |      |
| Solder mounting            |     |   |      |
|                            | RDE | Anti-noise<br>Deflecting crack<br>Soldering crack   | WEB  |
|                            | DEH | High temperature low loss   | WEB  |
|                            | DEA | High temperature Class 1  | WEB  |
|                            | DEB | Class 2   | WEB  |
|                            | DEC |   | WEB  |
|                            | DEF | For LCD backlight inverter circuit only   | WEB  |
|                            | DHR | Ultra-high voltage<br>Deflecting crack<br>Soldering crack                                 | WEB  |
|                            | DEJ | Japanese Safety Law<br>Based on the Electrical Appliance and Material Safety Law of Japan | WEB  |
|                            | DE1 | Safety standard<br>X1/Y1 Class certified product  | WEB  |
|                            | DE2 | Safety standard<br>X1/Y2 Class certified product  | WEB  |
| Screw termination mounting |     |   |      |
|                            | DHS | Ultra-high voltage  | WEB  |
|                            | DHK | Ultra-high voltage<br>High voltage AC rated   | WEB  |

| Infotainment for automotive |     |
|-----------------------------|-----|
| SMD                         |     |
| Solder mounting             |     |
| Chip type                   |     |
|                             | GRT |
| WEB                         |     |

| Powertrain/Safety for automotive    |     |  |     |
|-------------------------------------|-----|--|-----|
| SMD                                 |     |  |     |
| Solder mounting                     |     |  |     |
| Chip type                           |     |  |     |
|                                     | GCM |  | WEB |
|                                     | GC3 | Anti-noise<br>High effective capacitance & high ripple current   | WEB |
|                                     | GCJ | Fail safe<br>Deflecting crack<br>Soft termination  | WEB |
|                                     | GGM | Water Repellent  | WEB |
|                                     | GCQ | High Q   | WEB |
|                                     | GCD | Fail safe<br>Deflecting crack<br>MLSC design   | WEB |
|                                     | GCE | Fail safe<br>Deflecting crack<br>Soft termination MLSC design  | WEB |
|                                     | GGD | Fail safe<br>Deflecting crack<br>Water Repellent<br>MLSC design  | WEB |
|                                     | NFM | Low ESL<br>3 terminals   | WEB |
| Metal terminal type                 |     |  |     |
|                                     | KCM | Anti-noise<br>Deflecting crack<br>Soldering crack  | WEB |
|                                     | KC3 | Anti-noise<br>Deflecting crack<br>Soldering crack<br>High effective capacitance & high ripple current  | WEB |
|                                     | KCA | Safety standard<br>Anti-noise<br>Deflecting crack<br>Soldering crack                                   | WEB |
| Limited to Conductive Glue Mounting |     |  |     |
| Chip type                           |     |  |     |
|                                     | GCB | Deflecting crack<br>Soldering crack<br>Ni plating + Pd plating termination<br>conductive glue mounting | WEB |
|                                     | GCG | Deflecting crack<br>Soldering crack<br>AgPd termination conductive glue<br>mounting                    | WEB |
| Lead type                           |     |  |     |
| Solder mounting                     |     |  |     |
|                                     | RCE | Anti-noise<br>Deflecting crack<br>Soldering crack  | WEB |
|                                     | RHE | Anti-noise<br>Deflecting crack<br>Soldering crack<br>150°C operation leaded                            | WEB |
|                                     | RHS | Anti-noise<br>Deflecting crack<br>Soldering crack<br>200°C operation leaded                            | WEB |
|                                     | DE6 | Safety standard  | WEB |

| Medical-grade products for implanted medical devices |     |  |     |
|--|-----|--|-----|
| SMD  |     |  |     |
| Solder mounting                                      |     |  |     |
| Chip type  |     |  |     |
|  | GCH |  | WEB |

● Part Numbering

Chip Multilayer Ceramic Capacitors for General



(Part Number)

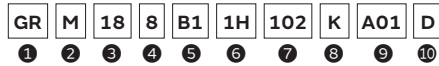

① Product ID ② Series

| Product ID | Code | Series   |
|------------|------|--|
| GA         | 2    | Based on the Electrical Appliance and Material Safety Law of Japan Chip Multilayer Ceramic Capacitors for General Purpose        |
|            | 3    | Safety Standard Certified Chip Multilayer Ceramic Capacitors for General Purpose   |
| GJ         | M    | High Q Chip Multilayer Ceramic Capacitors for General Purpose  |
| GM         | A    | Wire Bonding Mount Multilayer Microchip Capacitors for General Purpose   |
|            | D    | Wire Bonding/AuSn Soldering Mount Chip Multilayer Ceramic Capacitors for General Purpose   |
| GQ         | M    | High Q and High Power Chip Multilayer Ceramic Capacitors for General Purpose   |
| GR         | 3    | High Effective Capacitance & High Ripple Current Chip Multilayer Ceramic Capacitors for General Purpose                          |
|            | 4    | Chip Multilayer Ceramic Capacitors for Camera Flash Circuit only   |
|            | 7    | Chip Multilayer Ceramic Capacitors for Ethernet LAN and Primary-secondary Coupling of DC-DC Converters                           |
|            | J    | Soft Termination Chip Multilayer Ceramic Capacitors for General Purpose  |
| KR         | M    | Chip Multilayer Ceramic Capacitors for General Purpose   |
|            | 3    | High Effective Capacitance & High Allowable Ripple Current Metal Terminal Type Multilayer Ceramic Capacitors for General Purpose |
| LL         | M    | Metal Terminal Type Multilayer Ceramic Capacitors for General Purpose  |
|            | A    | 8 Terminals Low ESL Chip Multilayer Ceramic Capacitors for General Purpose   |
|            | L    | LW Reversed Low ESL Chip Multilayer Ceramic Capacitors for General Purpose   |
|            | M    | 10 Terminals Low ESL Chip Multilayer Ceramic Capacitors for General Purpose  |
|            | R    | LW Reversed Controlled ESR Low ESL Chip Multilayer Ceramic Capacitors for General Purpose  |

③ Chip Dimensions (LxW)

| Code | Dimensions (LxW) | EIA    |
|------|------------------|--------|
| 02   | 0.4x0.2mm        | 01005  |
| 0D   | 0.38x0.38mm      | 015015 |
| 03   | 0.6x0.3mm        | 0201   |
| 05   | 0.5x0.5mm        | 0202   |
| 08   | 0.8x0.8mm        | 0303   |
| 1U   | 0.6x1.0mm        | 02404  |
| 15   | 1.0x0.5mm        | 0402   |
| 18   | 1.6x0.8mm        | 0603   |
| 21   | 2.0x1.25mm       | 0805   |
| 22   | 2.8x2.8mm        | 1111   |
| 31   | 3.2x1.6mm        | 1206   |
| 32   | 3.2x2.5mm        | 1210   |
| 42   | 4.5x2.0mm        | 1808   |
| 43   | 4.5x3.2mm        | 1812   |
| 52   | 5.7x2.8mm        | 2211   |
| 55   | 5.7x5.0mm        | 2220   |

Continued on the following page. ↗

(Part Number)

|    |   |    |   |    |    |     |   |     |    |
|----|---|----|---|----|----|-----|---|-----|----|
| GR | M | 18 | 8 | B1 | 1H | 102 | K | A01 | D  |
| 1  | 2 | 3  | 4 | 5  | 6  | 7   | 8 | 9   | 10 |

Continued from the preceding page. ↘

④ Height Dimension (T) (Except KR□)

| Code | Dimension (T)                    |
|------|----------------------------------|
| 2    | 0.2mm                            |
| 3    | 0.3mm                            |
| 4    | 0.4mm                            |
| 5    | 0.5mm                            |
| 6    | 0.6mm                            |
| 7    | 0.7mm                            |
| 8    | 0.8mm                            |
| 9    | 0.85mm                           |
| A    | 1.0mm                            |
| B    | 1.25mm                           |
| C    | 1.6mm                            |
| D    | 2.0mm                            |
| E    | 2.5mm                            |
| M    | 1.15mm                           |
| Q    | 1.5mm                            |
| X    | Depends on individual standards. |

④ Height Dimension (T) (KR□ Only)

| Code | Dimension (T) |
|------|---------------|
| E    | 1.8mm         |
| F    | 1.9mm         |
| K    | 2.7mm         |
| L    | 2.8mm         |
| Q    | 3.7mm         |
| T    | 4.8mm         |
| W    | 6.4mm         |

⑤ Temperature Characteristics

| Temperature Characteristic Codes |                 |                       | Temperature Characteristics |   |                     |              | Operating Temperature Range | Capacitance Change Each Temperature (%) |      |       |      |       |  |
|----------------------------------|-----------------|-----------------------|-----------------------------|---|---------------------|--------------|-----------------------------|---|------|-------|------|-------|--|
| Code                             | Public STD Code | Reference Temperature | Temperature Range           | Capacitance Change or Temperature Coefficient | -55°C               |              |                             | *6                                      |      | -10°C |      |       |  |
|                                  |                 |                       |                             |   | Max.                | Min.         |                             | Max.                                    | Min. | Max.  | Min. |       |  |
| 1X                               | SL              | JIS                   | 20°C                        | 20 to 85°C                                    | +350 to -1000ppm/°C | -55 to 125°C | -                           | -                                       | -    | -     | -    | -     |  |
| 2C                               | CH              | JIS                   | 20°C                        | 20 to 125°C                                   | 0±60ppm/°C          | -55 to 125°C | 0.82                        | -0.45                                   | 0.49 | -0.27 | 0.33 | -0.18 |  |
| 3C                               | CJ              | JIS                   | 20°C                        | 20 to 125°C                                   | 0±120ppm/°C         | -55 to 125°C | 1.37                        | -0.9                                    | 0.82 | -0.54 | 0.55 | -0.36 |  |
| 3U                               | UJ              | JIS                   | 20°C                        | 20 to 85°C                                    | -750±120ppm/°C      | -25 to 85°C  | -                           | -                                       | 4.94 | 2.84  | 3.29 | 1.89  |  |
| 4C                               | CK              | JIS                   | 20°C                        | 20 to 125°C                                   | 0±250ppm/°C         | -55 to 125°C | 2.56                        | -1.88                                   | 1.54 | -1.13 | 1.02 | -0.75 |  |
| 5C                               | COG             | EIA                   | 25°C                        | 25 to 125°C                                   | 0±30ppm/°C          | -55 to 125°C | 0.58                        | -0.24                                   | 0.4  | -0.17 | 0.25 | -0.11 |  |
| 5G                               | X8G             | *2                    | 25°C                        | 25 to 150°C                                   | 0±30ppm/°C          | -55 to 150°C | 0.58                        | -0.24                                   | 0.4  | -0.17 | 0.25 | -0.11 |  |
| 7U                               | U2J             | EIA                   | 25°C                        | 25 to 125°C *3                                | -750±120ppm/°C      | -55 to 125°C | 8.78                        | 5.04                                    | 6.04 | 3.47  | 3.84 | 2.21  |  |
| B1                               | B *1            | JIS                   | 20°C                        | -25 to 85°C                                   | ±10%                | -25 to 85°C  | -                           | -                                       | -    | -     | -    | -     |  |
| B3                               | B               | JIS                   | 20°C                        | -25 to 85°C                                   | ±10%                | -25 to 85°C  | -                           | -                                       | -    | -     | -    | -     |  |
| C7                               | X7S             | EIA                   | 25°C                        | -55 to 125°C                                  | ±22%                | -55 to 125°C | -                           | -                                       | -    | -     | -    | -     |  |
| C8                               | X6S             | EIA                   | 25°C                        | -55 to 105°C                                  | ±22%                | -55 to 105°C | -                           | -                                       | -    | -     | -    | -     |  |
| D7                               | X7T             | EIA                   | 25°C                        | -55 to 125°C                                  | +22%, -33%          | -55 to 125°C | -                           | -                                       | -    | -     | -    | -     |  |
| D8                               | X6T             | EIA                   | 25°C                        | -55 to 105°C                                  | +22%, -33%          | -55 to 105°C | -                           | -                                       | -    | -     | -    | -     |  |
| E7                               | X7U             | EIA                   | 25°C                        | -55 to 125°C                                  | +22%, -56%          | -55 to 125°C | -                           | -                                       | -    | -     | -    | -     |  |
| R1                               | R *1            | JIS                   | 20°C                        | -55 to 125°C                                  | ±15%                | -55 to 125°C | -                           | -                                       | -    | -     | -    | -     |  |
| R6                               | X5R             | EIA                   | 25°C                        | -55 to 85°C                                   | ±15%                | -55 to 85°C  | -                           | -                                       | -    | -     | -    | -     |  |
| R7                               | X7R             | EIA                   | 25°C                        | -55 to 125°C                                  | ±15%                | -55 to 125°C | -                           | -                                       | -    | -     | -    | -     |  |
| W0                               | X7T             | EIA                   | 25°C                        | -55 to 125°C                                  | ±10% *4             | -55 to 125°C | -                           | -                                       | -    | -     | -    | -     |  |
|                                  |                 |                       |                             |   | +22%, -33% *5       |              | -                           | -                                       | -    | -     | -    | -     |  |

\*1 Capacitance change is specified with 50% rated voltage applied.  
 \*2 Murata Temperature Characteristic Code.  
 \*3 Rated Voltage 100Vdc max: 25 to 85°C  
 \*4 Apply DC350V bias.  
 \*5 No DC bias.  
 \*6 -25°C (Reference Temperature 20°C) / -30°C (Reference Temperature 25°C)

Continued on the following page. ↗

(Part Number)

|    |   |    |   |    |    |     |   |     |    |
|----|---|----|---|----|----|-----|---|-----|----|
| GR | M | 18 | 8 | B1 | 1H | 102 | K | A01 | D  |
| 1  | 2 | 3  | 4 | 5  | 6  | 7   | 8 | 9   | 10 |

Continued from the preceding page. ↘

⑥ Rated Voltage

| Code | Rated Voltage   |
|------|---|
| OE   | DC2.5V  |
| OG   | DC4V  |
| OJ   | DC6.3V  |
| 1A   | DC10V   |
| 1C   | DC16V   |
| 1E   | DC25V   |
| 1H   | DC50V   |
| 1J   | DC63V   |
| 1K   | DC80V   |
| 2A   | DC100V  |
| 2D   | DC200V  |
| 2E   | DC250V  |
| 2W   | DC450V  |
| 2H   | DC500V  |
| 2J   | DC630V  |
| 3A   | DC1kV   |
| 3D   | DC2kV   |
| 3F   | DC3.15kV  |
| BB   | DC350V  |
| E2   | AC250V  |
| GB   | X2; AC250V (Safety Standard Certified Type GB)        |
| GD   | Y3; AC250V (Safety Standard Certified Type GD)        |
| GF   | Y2, X1/Y2; AC250V (Safety Standard Certified Type GF) |
| YA   | DC35V   |

⑦ Capacitance

Expressed by three-digit alphanumerics. The unit is picofarad (pF). The first and second figures are significant digits, and the third figure expresses the number of zeros which follow the two numbers. If there is a decimal point, it is expressed by the capital letter "R." In this case, all figures are significant digits. If any alphabet, other than "R", is included, this indicates the specific part number is a non-standard part.

Ex.)

| Code | Capacitance |
|------|-------------|
| R50  | 0.50pF      |
| 1R0  | 1.0pF       |
| 100  | 10pF        |
| 103  | 10000pF     |

⑧ Capacitance Tolerance

| Code | Capacitance Tolerance                            |
|------|--|
| B    | ±0.1pF   |
| C    | ±0.25pF  |
| D    | ±0.5pF (Less than 10pF)<br>±0.5% (10pF and over) |
| F    | ±1%  |
| G    | ±2%  |
| J    | ±5%  |
| K    | ±10%   |
| M    | ±20%   |
| W    | ±0.05pF  |

⑨ Individual Specification Code (Except LLR)

Expressed by three figures.

⑨ ESR (LLR Only)

| Code | ESR    |
|------|--------|
| E01  | 100mΩ  |
| E03  | 220mΩ  |
| E05  | 470mΩ  |
| E07  | 1000mΩ |

⑩ Packaging

| Code  | Packaging              |
|-------|------------------------|
| L     | ø180mm Embossed Taping |
| D/E/W | ø180mm Paper Taping    |
| K     | ø330mm Embossed Taping |
| J/F   | ø330mm Paper Taping    |
| T     | Bulk Tray              |

Please contact us if you find any part number not provided in this table.

Chip Multilayer Ceramic Capacitors for General Purpose

**GRM Series**



This is Murata primary products renowned for both small size and large capacitance value with latest advanced technology.

Features

① Achieves large-capacity and small size in a multilayer structure.

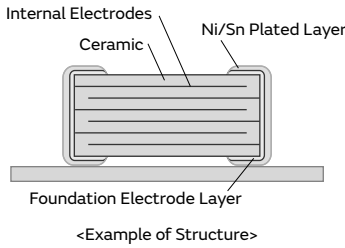

**"Thin Layer Technology" for thinner layers**

**"Fine Particle Technology" for finer particles**

**"High Precision Lamination Technology" for more accuracy**

② Sn plating is applied to the external electrodes; excellent solderability.

③ High reliability with no polarity.

|  | Ceramic Capacitors | Tantalum Capacitor | Aluminum Electrolytic Capacitor | Conductive Polymer Capacitor |
|--|--------------------|--------------------|---------------------------------|------------------------------|
| Price  | ○                  | ○                  | ◎                               | ○                            |
| Comparison between Impedance Frequency Characteristics | ◎                  | △                  | △                               | ○                            |
| Capacitance temperature characteristics                | ○                  | ◎                  | ○                               | ○                            |
| DC breakdown voltage                                   | ◎                  | △                  | △                               | △                            |
| Polarity   | No                 | Yes                | Yes                             | Yes                          |
| Pulse response   | ◎                  | △                  | △                               | ○                            |
| Allowable ripple current                               | ◎                  | △                  | △                               | △                            |
| Reliability  | ◎                  | ○                  | ○                               | ○                            |
| DC bias characteristics                                | △                  | ◎                  | ◎                               | ◎                            |

◎: Particularly excellent ○: Excellent △: Inferior

Specifications

|                   |  |
|-------------------|--|
| Size (mm)         | 0.25×0.125mm to 5.7×5.0mm  |
| Rated Voltage     | 2.5Vdc to 3150Vdc  |
| Capacitance       | 0.10pF to 330µF  |
| Main Applications | 1. Rated voltage 100V Max.<br>High Dielectric Constant Type . . . For decoupling and smoothing circuits<br>Temperature Compensating Type . . . For tuning circuits, oscillating circuits, and high frequency filter circuits<br><br>2. Rated voltage 200V min.<br>High Dielectric Constant Type . . . For clamp snubber circuits and smoothing circuits<br>Temperature Compensating Type . . . Power supply damper snubber |

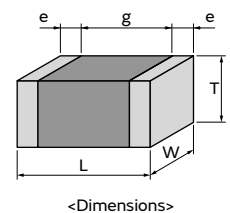

This catalog contains only a portion of the product lineup.  
 Please refer to the capacitor search tool on the Murata Web site for details.

GRM  
 GR3  
 GRJ  
 GR4  
 GR7  
 GJM  
 GQM  
 GA2  
 GA3 GB  
 GA3 GD  
 GA3 GF  
 LLL  
 LLA  
 LLM  
 LLR  
 NFM  
 KRM  
 KR3  
 GMA  
 GMD  
 △Caution /Notice

# GRM Series Temperature Compensating Type Part Number List

## 0.4×0.2mm

| T max.  | Rated Voltage      | TC Code            | Cap.   | Tol.    | Part Number        |
|---------|--------------------|--------------------|--------|---------|--------------------|
| 0.22mm  | 50Vdc              | COG                | 0.20pF | ±0.05pF | GRM0225C1HR20WA03# |
|         |                    |                    |        | ±0.1pF  | GRM0225C1HR20BA03# |
|         |                    |                    | 0.30pF | ±0.05pF | GRM0225C1HR30WA03# |
|         |                    |                    |        | ±0.1pF  | GRM0225C1HR30BA03# |
|         |                    |                    | 0.40pF | ±0.05pF | GRM0225C1HR40WA03# |
|         |                    |                    |        | ±0.1pF  | GRM0225C1HR40BA03# |
|         |                    |                    | 0.50pF | ±0.05pF | GRM0225C1HR50WA03# |
|         |                    |                    |        | ±0.1pF  | GRM0225C1HR50BA03# |
|         |                    |                    | 0.60pF | ±0.05pF | GRM0225C1HR60WA03# |
|         |                    |                    |        | ±0.1pF  | GRM0225C1HR60BA03# |
|         |                    |                    | 0.70pF | ±0.05pF | GRM0225C1HR70WA03# |
|         |                    |                    |        | ±0.1pF  | GRM0225C1HR70BA03# |
|         |                    |                    | 0.80pF | ±0.05pF | GRM0225C1HR80WA03# |
|         |                    |                    |        | ±0.1pF  | GRM0225C1HR80BA03# |
|         |                    |                    | 0.90pF | ±0.05pF | GRM0225C1HR90WA03# |
|         |                    |                    |        | ±0.1pF  | GRM0225C1HR90BA03# |
|         |                    |                    | 1.0pF  | ±0.05pF | GRM0225C1H1R0WA03# |
|         |                    |                    |        | ±0.1pF  | GRM0225C1H1R0BA03# |
|         |                    |                    |        | ±0.25pF | GRM0225C1H1R0CA03# |
|         |                    |                    | 1.1pF  | ±0.05pF | GRM0225C1H1R1WA03# |
|         |                    |                    |        | ±0.1pF  | GRM0225C1H1R1BA03# |
|         |                    |                    |        | ±0.25pF | GRM0225C1H1R1CA03# |
|         |                    |                    | 1.2pF  | ±0.05pF | GRM0225C1H1R2WA03# |
|         |                    |                    |        | ±0.1pF  | GRM0225C1H1R2BA03# |
|         |                    |                    |        | ±0.25pF | GRM0225C1H1R2CA03# |
|         |                    |                    | 1.3pF  | ±0.05pF | GRM0225C1H1R3WA03# |
|         |                    |                    |        | ±0.1pF  | GRM0225C1H1R3BA03# |
|         |                    |                    |        | ±0.25pF | GRM0225C1H1R3CA03# |
|         |                    |                    | 1.4pF  | ±0.05pF | GRM0225C1H1R4WA03# |
|         |                    |                    |        | ±0.1pF  | GRM0225C1H1R4BA03# |
|         |                    |                    |        | ±0.25pF | GRM0225C1H1R4CA03# |
|         |                    |                    | 1.5pF  | ±0.05pF | GRM0225C1H1R5WA03# |
|         |                    |                    |        | ±0.1pF  | GRM0225C1H1R5BA03# |
|         |                    |                    |        | ±0.25pF | GRM0225C1H1R5CA03# |
|         |                    |                    | 1.6pF  | ±0.05pF | GRM0225C1H1R6WA03# |
|         |                    |                    |        | ±0.1pF  | GRM0225C1H1R6BA03# |
|         |                    |                    |        | ±0.25pF | GRM0225C1H1R6CA03# |
|         |                    |                    | 1.7pF  | ±0.05pF | GRM0225C1H1R7WA03# |
|         |                    |                    |        | ±0.1pF  | GRM0225C1H1R7BA03# |
|         |                    |                    |        | ±0.25pF | GRM0225C1H1R7CA03# |
|         |                    |                    | 1.8pF  | ±0.05pF | GRM0225C1H1R8WA03# |
|         |                    |                    |        | ±0.1pF  | GRM0225C1H1R8BA03# |
|         |                    |                    |        | ±0.25pF | GRM0225C1H1R8CA03# |
|         |                    |                    | 1.9pF  | ±0.05pF | GRM0225C1H1R9WA03# |
|         |                    |                    |        | ±0.1pF  | GRM0225C1H1R9BA03# |
|         |                    |                    |        | ±0.25pF | GRM0225C1H1R9CA03# |
|         |                    |                    | 2.0pF  | ±0.05pF | GRM0225C1H2R0WA03# |
|         |                    |                    |        | ±0.1pF  | GRM0225C1H2R0BA03# |
| ±0.25pF | GRM0225C1H2R0CA03# |                    |        |         |                    |
| 2.1pF   | ±0.05pF            | GRM0225C1H2R1WA03# |        |         |                    |
|         | ±0.1pF             | GRM0225C1H2R1BA03# |        |         |                    |
|         | ±0.25pF            | GRM0225C1H2R1CA03# |        |         |                    |

| T max. | Rated Voltage | TC Code            | Cap.  | Tol.    | Part Number        |
|--------|---------------|--------------------|-------|---------|--------------------|
| 0.22mm | 50Vdc         | COG                | 2.2pF | ±0.05pF | GRM0225C1H2R2WA03# |
|        |               |                    |       | ±0.1pF  | GRM0225C1H2R2BA03# |
|        |               |                    |       | ±0.25pF | GRM0225C1H2R2CA03# |
|        |               |                    | 2.3pF | ±0.05pF | GRM0225C1H2R3WA03# |
|        |               |                    |       | ±0.1pF  | GRM0225C1H2R3BA03# |
|        |               |                    |       | ±0.25pF | GRM0225C1H2R3CA03# |
|        |               |                    | 2.4pF | ±0.05pF | GRM0225C1H2R4WA03# |
|        |               |                    |       | ±0.1pF  | GRM0225C1H2R4BA03# |
|        |               |                    |       | ±0.25pF | GRM0225C1H2R4CA03# |
|        |               |                    | 2.5pF | ±0.05pF | GRM0225C1H2R5WA03# |
|        |               |                    |       | ±0.1pF  | GRM0225C1H2R5BA03# |
|        |               |                    |       | ±0.25pF | GRM0225C1H2R5CA03# |
|        |               |                    | 2.6pF | ±0.05pF | GRM0225C1H2R6WA03# |
|        |               |                    |       | ±0.1pF  | GRM0225C1H2R6BA03# |
|        |               |                    |       | ±0.25pF | GRM0225C1H2R6CA03# |
|        |               |                    | 2.7pF | ±0.05pF | GRM0225C1H2R7WA03# |
|        |               |                    |       | ±0.1pF  | GRM0225C1H2R7BA03# |
|        |               |                    |       | ±0.25pF | GRM0225C1H2R7CA03# |
|        |               |                    | 2.8pF | ±0.05pF | GRM0225C1H2R8WA03# |
|        |               |                    |       | ±0.1pF  | GRM0225C1H2R8BA03# |
|        |               |                    |       | ±0.25pF | GRM0225C1H2R8CA03# |
|        |               |                    | 2.9pF | ±0.05pF | GRM0225C1H2R9WA03# |
|        |               |                    |       | ±0.1pF  | GRM0225C1H2R9BA03# |
|        |               |                    |       | ±0.25pF | GRM0225C1H2R9CA03# |
|        |               |                    | 3.0pF | ±0.05pF | GRM0225C1H3R0WA03# |
|        |               |                    |       | ±0.1pF  | GRM0225C1H3R0BA03# |
|        |               |                    |       | ±0.25pF | GRM0225C1H3R0CA03# |
|        |               |                    | 3.1pF | ±0.05pF | GRM0225C1H3R1WA03# |
|        |               |                    |       | ±0.1pF  | GRM0225C1H3R1BA03# |
|        |               |                    |       | ±0.25pF | GRM0225C1H3R1CA03# |
|        |               |                    | 3.2pF | ±0.05pF | GRM0225C1H3R2WA03# |
|        |               |                    |       | ±0.1pF  | GRM0225C1H3R2BA03# |
|        |               |                    |       | ±0.25pF | GRM0225C1H3R2CA03# |
|        |               |                    | 3.3pF | ±0.05pF | GRM0225C1H3R3WA03# |
|        |               |                    |       | ±0.1pF  | GRM0225C1H3R3BA03# |
|        |               |                    |       | ±0.25pF | GRM0225C1H3R3CA03# |
|        |               |                    | 3.4pF | ±0.05pF | GRM0225C1H3R4WA03# |
|        |               |                    |       | ±0.1pF  | GRM0225C1H3R4BA03# |
|        |               |                    |       | ±0.25pF | GRM0225C1H3R4CA03# |
|        |               |                    | 3.5pF | ±0.05pF | GRM0225C1H3R5WA03# |
|        |               |                    |       | ±0.1pF  | GRM0225C1H3R5BA03# |
|        |               |                    |       | ±0.25pF | GRM0225C1H3R5CA03# |
|        |               |                    | 3.6pF | ±0.05pF | GRM0225C1H3R6WA03# |
|        |               |                    |       | ±0.1pF  | GRM0225C1H3R6BA03# |
|        |               |                    |       | ±0.25pF | GRM0225C1H3R6CA03# |
|        |               |                    | 3.7pF | ±0.05pF | GRM0225C1H3R7WA03# |
|        |               |                    |       | ±0.1pF  | GRM0225C1H3R7BA03# |
|        |               |                    |       | ±0.25pF | GRM0225C1H3R7CA03# |
| 3.8pF  | ±0.05pF       | GRM0225C1H3R8WA03# |       |         |                    |
|        | ±0.1pF        | GRM0225C1H3R8BA03# |       |         |                    |
|        | ±0.25pF       | GRM0225C1H3R8CA03# |       |         |                    |
| 3.9pF  | ±0.05pF       | GRM0225C1H3R9WA03# |       |         |                    |
|        | ±0.1pF        | GRM0225C1H3R9BA03# |       |         |                    |
|        | ±0.25pF       | GRM0225C1H3R9CA03# |       |         |                    |

- GRM
- GR3
- GRJ
- GR4
- GR7
- GJM
- GQM
- GA2
- GA3 GB
- GA3 GD
- GA3 GF
- LLL
- LLA
- LLM
- LLR
- NFM
- KRM
- KR3
- GMA
- GMD
- ⚠Caution /Notice

Part number # indicates the package specification code.



# GRM Series Temperature Compensating Type Part Number List

(→ 0.4×0.2mm)

| T max. | Rated Voltage | TC Code | Cap.  | Tol.    | Part Number        |
|--------|---------------|---------|-------|---------|--------------------|
| 0.22mm | 50Vdc         | COG     | 4.0pF | ±0.05pF | GRM0225C1H4R0WA03# |
|        |               |         |       | ±0.1pF  | GRM0225C1H4R0BA03# |
|        |               |         |       | ±0.25pF | GRM0225C1H4R0CA03# |
|        |               |         | 4.1pF | ±0.05pF | GRM0225C1H4R1WA03# |
|        |               |         |       | ±0.1pF  | GRM0225C1H4R1BA03# |
|        |               |         |       | ±0.25pF | GRM0225C1H4R1CA03# |
|        |               |         | 4.2pF | ±0.05pF | GRM0225C1H4R2WA03# |
|        |               |         |       | ±0.1pF  | GRM0225C1H4R2BA03# |
|        |               |         |       | ±0.25pF | GRM0225C1H4R2CA03# |
|        |               |         | 4.3pF | ±0.05pF | GRM0225C1H4R3WA03# |
|        |               |         |       | ±0.1pF  | GRM0225C1H4R3BA03# |
|        |               |         |       | ±0.25pF | GRM0225C1H4R3CA03# |
|        |               |         | 4.4pF | ±0.05pF | GRM0225C1H4R4WA03# |
|        |               |         |       | ±0.1pF  | GRM0225C1H4R4BA03# |
|        |               |         |       | ±0.25pF | GRM0225C1H4R4CA03# |
|        |               |         | 4.5pF | ±0.05pF | GRM0225C1H4R5WA03# |
|        |               |         |       | ±0.1pF  | GRM0225C1H4R5BA03# |
|        |               |         |       | ±0.25pF | GRM0225C1H4R5CA03# |
|        |               |         | 4.6pF | ±0.05pF | GRM0225C1H4R6WA03# |
|        |               |         |       | ±0.1pF  | GRM0225C1H4R6BA03# |
|        |               |         |       | ±0.25pF | GRM0225C1H4R6CA03# |
|        |               |         | 4.7pF | ±0.05pF | GRM0225C1H4R7WA03# |
|        |               |         |       | ±0.1pF  | GRM0225C1H4R7BA03# |
|        |               |         |       | ±0.25pF | GRM0225C1H4R7CA03# |
|        |               |         | 4.8pF | ±0.05pF | GRM0225C1H4R8WA03# |
|        |               |         |       | ±0.1pF  | GRM0225C1H4R8BA03# |
|        |               |         |       | ±0.25pF | GRM0225C1H4R8CA03# |
|        |               |         | 4.9pF | ±0.05pF | GRM0225C1H4R9WA03# |
|        |               |         |       | ±0.1pF  | GRM0225C1H4R9BA03# |
|        |               |         |       | ±0.25pF | GRM0225C1H4R9CA03# |
|        |               |         | 5.0pF | ±0.05pF | GRM0225C1H5R0WA03# |
|        |               |         |       | ±0.1pF  | GRM0225C1H5R0BA03# |
|        |               |         |       | ±0.25pF | GRM0225C1H5R0CA03# |
|        |               |         | 5.1pF | ±0.05pF | GRM0225C1H5R1WA03# |
|        |               |         |       | ±0.1pF  | GRM0225C1H5R1BA03# |
|        |               |         |       | ±0.25pF | GRM0225C1H5R1CA03# |
|        |               |         |       | ±0.5pF  | GRM0225C1H5R1DA03# |
|        |               |         | 5.2pF | ±0.05pF | GRM0225C1H5R2WA03# |
|        |               |         |       | ±0.1pF  | GRM0225C1H5R2BA03# |
|        |               |         |       | ±0.25pF | GRM0225C1H5R2CA03# |
|        |               |         |       | ±0.5pF  | GRM0225C1H5R2DA03# |
|        |               |         | 5.3pF | ±0.05pF | GRM0225C1H5R3WA03# |
|        |               |         |       | ±0.1pF  | GRM0225C1H5R3BA03# |
|        |               |         |       | ±0.25pF | GRM0225C1H5R3CA03# |
|        |               |         |       | ±0.5pF  | GRM0225C1H5R3DA03# |
|        |               |         | 5.4pF | ±0.05pF | GRM0225C1H5R4WA03# |
|        |               |         |       | ±0.1pF  | GRM0225C1H5R4BA03# |
|        |               |         |       | ±0.25pF | GRM0225C1H5R4CA03# |
|        |               |         |       | ±0.5pF  | GRM0225C1H5R4DA03# |
|        |               |         | 5.5pF | ±0.05pF | GRM0225C1H5R5WA03# |
|        |               |         |       | ±0.1pF  | GRM0225C1H5R5BA03# |
|        |               |         |       | ±0.25pF | GRM0225C1H5R5CA03# |
|        |               |         |       | ±0.5pF  | GRM0225C1H5R5DA03# |
|        |               |         | 5.6pF | ±0.05pF | GRM0225C1H5R6WA03# |

| T max. | Rated Voltage | TC Code | Cap.  | Tol.    | Part Number        |
|--------|---------------|---------|-------|---------|--------------------|
| 0.22mm | 50Vdc         | COG     | 5.6pF | ±0.1pF  | GRM0225C1H5R6BA03# |
|        |               |         |       | ±0.25pF | GRM0225C1H5R6CA03# |
|        |               |         |       | ±0.5pF  | GRM0225C1H5R6DA03# |
|        |               |         | 5.7pF | ±0.05pF | GRM0225C1H5R7WA03# |
|        |               |         |       | ±0.1pF  | GRM0225C1H5R7BA03# |
|        |               |         |       | ±0.25pF | GRM0225C1H5R7CA03# |
|        |               |         | 5.8pF | ±0.05pF | GRM0225C1H5R8WA03# |
|        |               |         |       | ±0.1pF  | GRM0225C1H5R8BA03# |
|        |               |         |       | ±0.25pF | GRM0225C1H5R8CA03# |
|        |               |         | 5.9pF | ±0.05pF | GRM0225C1H5R9WA03# |
|        |               |         |       | ±0.1pF  | GRM0225C1H5R9BA03# |
|        |               |         |       | ±0.25pF | GRM0225C1H5R9CA03# |
|        |               |         | 6.0pF | ±0.05pF | GRM0225C1H6R0WA03# |
|        |               |         |       | ±0.1pF  | GRM0225C1H6R0BA03# |
|        |               |         |       | ±0.25pF | GRM0225C1H6R0CA03# |
|        |               |         | 6.1pF | ±0.05pF | GRM0225C1H6R1WA03# |
|        |               |         |       | ±0.1pF  | GRM0225C1H6R1BA03# |
|        |               |         |       | ±0.25pF | GRM0225C1H6R1CA03# |
|        |               |         | 6.2pF | ±0.05pF | GRM0225C1H6R2WA03# |
|        |               |         |       | ±0.1pF  | GRM0225C1H6R2BA03# |
|        |               |         |       | ±0.25pF | GRM0225C1H6R2CA03# |
|        |               |         | 6.3pF | ±0.05pF | GRM0225C1H6R3WA03# |
|        |               |         |       | ±0.1pF  | GRM0225C1H6R3BA03# |
|        |               |         |       | ±0.25pF | GRM0225C1H6R3CA03# |
|        |               |         | 6.4pF | ±0.05pF | GRM0225C1H6R4WA03# |
|        |               |         |       | ±0.1pF  | GRM0225C1H6R4BA03# |
|        |               |         |       | ±0.25pF | GRM0225C1H6R4CA03# |
|        |               |         | 6.5pF | ±0.05pF | GRM0225C1H6R5WA03# |
|        |               |         |       | ±0.1pF  | GRM0225C1H6R5BA03# |
|        |               |         |       | ±0.25pF | GRM0225C1H6R5CA03# |
|        |               |         | 6.6pF | ±0.05pF | GRM0225C1H6R6WA03# |
|        |               |         |       | ±0.1pF  | GRM0225C1H6R6BA03# |
|        |               |         |       | ±0.25pF | GRM0225C1H6R6CA03# |
|        |               |         | 6.7pF | ±0.05pF | GRM0225C1H6R7WA03# |
|        |               |         |       | ±0.1pF  | GRM0225C1H6R7BA03# |
|        |               |         |       | ±0.25pF | GRM0225C1H6R7CA03# |
|        |               |         | 6.8pF | ±0.05pF | GRM0225C1H6R8WA03# |
|        |               |         |       | ±0.1pF  | GRM0225C1H6R8BA03# |
|        |               |         |       | ±0.25pF | GRM0225C1H6R8CA03# |
|        |               |         | 6.9pF | ±0.05pF | GRM0225C1H6R9WA03# |
|        |               |         |       | ±0.1pF  | GRM0225C1H6R9BA03# |
|        |               |         |       | ±0.25pF | GRM0225C1H6R9CA03# |

Part number # indicates the package specification code.

- GRM
- GR3
- GRJ
- GR4
- GR7
- GJM
- GQM
- GA2
- GA3 GB
- GA3 GD
- GA3 GF
- LLL
- LLA
- LLM
- LLR
- NFM
- KRM
- KR3
- GMA
- GMD
- ⚠Caution /Notice

# GRM Series Temperature Compensating Type Part Number List

(→ 0.4×0.2mm)

| T max. | Rated Voltage | TC Code | Cap.    | Tol.               | Part Number        | T max. | Rated Voltage | TC Code | Cap.               | Tol.    | Part Number        |                    |
|--------|---------------|---------|---------|--------------------|--------------------|--------|---------------|---------|--------------------|---------|--------------------|--------------------|
| 0.22mm | 50Vdc         | COG     | 6.9pF   | ±0.5pF             | GRM0225C1H6R9DA03# | 0.22mm | 50Vdc         | COG     | 8.3pF              | ±0.1pF  | GRM0225C1H8R3BA03# |                    |
|        |               |         |         | ±0.05pF            | GRM0225C1H7R0WA03# |        |               |         |                    | ±0.25pF | GRM0225C1H8R3CA03# |                    |
|        |               |         |         | ±0.1pF             | GRM0225C1H7R0BA03# |        |               |         |                    | ±0.5pF  | GRM0225C1H8R3DA03# |                    |
|        |               |         | 7.0pF   | ±0.25pF            | GRM0225C1H7R0CA03# |        |               |         | 8.4pF              | ±0.05pF | GRM0225C1H8R4WA03# |                    |
|        |               |         |         | ±0.5pF             | GRM0225C1H7R0DA03# |        |               |         |                    | ±0.1pF  | GRM0225C1H8R4BA03# |                    |
|        |               |         |         | ±0.05pF            | GRM0225C1H7R1WA03# |        |               |         |                    | ±0.25pF | GRM0225C1H8R4CA03# |                    |
|        |               |         |         | ±0.1pF             | GRM0225C1H7R1BA03# |        |               |         |                    | ±0.5pF  | GRM0225C1H8R4DA03# |                    |
|        |               |         | 7.1pF   | ±0.25pF            | GRM0225C1H7R1CA03# |        |               |         | 8.5pF              | ±0.05pF | GRM0225C1H8R5WA03# |                    |
|        |               |         |         | ±0.5pF             | GRM0225C1H7R1DA03# |        |               |         |                    | ±0.1pF  | GRM0225C1H8R5BA03# |                    |
|        |               |         |         | ±0.05pF            | GRM0225C1H7R2WA03# |        |               |         |                    | ±0.25pF | GRM0225C1H8R5CA03# |                    |
|        |               |         | 7.2pF   | ±0.1pF             | GRM0225C1H7R2BA03# |        |               |         | 8.6pF              | ±0.5pF  | GRM0225C1H8R5DA03# |                    |
|        |               |         |         | ±0.25pF            | GRM0225C1H7R2CA03# |        |               |         |                    | ±0.05pF | GRM0225C1H8R6WA03# |                    |
|        |               |         |         | ±0.5pF             | GRM0225C1H7R2DA03# |        |               |         |                    | ±0.1pF  | GRM0225C1H8R6BA03# |                    |
|        |               |         | 7.3pF   | ±0.05pF            | GRM0225C1H7R3WA03# |        |               |         | 8.7pF              | ±0.25pF | GRM0225C1H8R6CA03# |                    |
|        |               |         |         | ±0.1pF             | GRM0225C1H7R3BA03# |        |               |         |                    | ±0.5pF  | GRM0225C1H8R6DA03# |                    |
|        |               |         |         | ±0.25pF            | GRM0225C1H7R3CA03# |        |               |         |                    | 8.8pF   | ±0.05pF            | GRM0225C1H8R7WA03# |
|        |               |         |         | ±0.5pF             | GRM0225C1H7R3DA03# |        |               |         |                    |         | ±0.1pF             | GRM0225C1H8R7BA03# |
|        |               |         | ±0.05pF | GRM0225C1H7R4WA03# | ±0.25pF            |        |               |         | GRM0225C1H8R7CA03# |         |                    |                    |
|        |               |         | ±0.1pF  | GRM0225C1H7R4BA03# | ±0.5pF             |        |               |         | GRM0225C1H8R7DA03# |         |                    |                    |
|        |               |         | 7.4pF   | ±0.25pF            | GRM0225C1H7R4CA03# |        |               |         | 8.9pF              | ±0.05pF | GRM0225C1H8R8WA03# |                    |
|        |               |         |         | ±0.5pF             | GRM0225C1H7R4DA03# |        |               |         |                    | ±0.1pF  | GRM0225C1H8R8BA03# |                    |
|        |               |         |         | ±0.05pF            | GRM0225C1H7R5WA03# |        |               |         |                    | ±0.25pF | GRM0225C1H8R8CA03# |                    |
|        |               |         | 7.5pF   | ±0.1pF             | GRM0225C1H7R5BA03# |        |               |         | 9.0pF              | ±0.5pF  | GRM0225C1H8R8DA03# |                    |
|        |               |         |         | ±0.25pF            | GRM0225C1H7R5CA03# |        |               |         |                    | 9.1pF   | ±0.05pF            | GRM0225C1H8R9WA03# |
|        |               |         |         | ±0.5pF             | GRM0225C1H7R5DA03# |        |               |         |                    |         | ±0.1pF             | GRM0225C1H8R9BA03# |
|        |               |         | ±0.05pF | GRM0225C1H7R6WA03# | ±0.25pF            |        |               |         | GRM0225C1H8R9CA03# |         |                    |                    |
|        |               |         | 7.6pF   | ±0.1pF             | GRM0225C1H7R6BA03# |        |               |         | 9.2pF              | ±0.5pF  | GRM0225C1H8R9DA03# |                    |
|        |               |         |         | ±0.25pF            | GRM0225C1H7R6CA03# |        |               |         |                    | 9.3pF   | ±0.05pF            | GRM0225C1H9R0WA03# |
|        |               |         |         | ±0.5pF             | GRM0225C1H7R6DA03# |        |               |         |                    |         | ±0.1pF             | GRM0225C1H9R0BA03# |
|        |               |         | 7.7pF   | ±0.25pF            | GRM0225C1H7R7CA03# |        |               |         | 9.4pF              |         | ±0.25pF            | GRM0225C1H9R0CA03# |
|        |               |         |         | ±0.5pF             | GRM0225C1H7R7DA03# |        |               |         |                    | ±0.5pF  | GRM0225C1H9R0DA03# |                    |
|        |               |         |         | ±0.05pF            | GRM0225C1H7R8WA03# |        |               |         |                    | 9.5pF   | ±0.05pF            | GRM0225C1H9R1WA03# |
|        |               |         |         | ±0.1pF             | GRM0225C1H7R8BA03# |        |               |         |                    |         | ±0.1pF             | GRM0225C1H9R1BA03# |
|        |               |         | ±0.25pF | GRM0225C1H7R8CA03# | ±0.25pF            |        |               |         | GRM0225C1H9R1CA03# |         |                    |                    |
|        |               |         | ±0.5pF  | GRM0225C1H7R8DA03# | ±0.5pF             |        |               |         | GRM0225C1H9R1DA03# |         |                    |                    |
|        |               |         | 7.8pF   | ±0.05pF            | GRM0225C1H7R9WA03# |        |               |         | 9.6pF              | ±0.05pF | GRM0225C1H9R2WA03# |                    |
|        |               |         |         | ±0.1pF             | GRM0225C1H7R9BA03# |        |               |         |                    | ±0.1pF  | GRM0225C1H9R2BA03# |                    |
|        |               |         |         | ±0.25pF            | GRM0225C1H7R9CA03# |        |               |         |                    | ±0.25pF | GRM0225C1H9R2CA03# |                    |
|        |               |         | 7.9pF   | ±0.5pF             | GRM0225C1H7R9DA03# |        |               |         | 9.3pF              | ±0.5pF  | GRM0225C1H9R2DA03# |                    |
|        |               |         |         | ±0.05pF            | GRM0225C1H8R0WA03# |        |               |         |                    | 9.4pF   | ±0.05pF            | GRM0225C1H9R3WA03# |
|        |               |         |         | ±0.1pF             | GRM0225C1H8R0BA03# |        |               |         |                    |         | ±0.1pF             | GRM0225C1H9R3BA03# |
|        |               |         | ±0.25pF | GRM0225C1H8R0CA03# | ±0.25pF            |        |               |         | GRM0225C1H9R3CA03# |         |                    |                    |
|        |               |         | 8.0pF   | ±0.5pF             | GRM0225C1H8R0DA03# |        |               |         | 9.5pF              | ±0.5pF  | GRM0225C1H9R3DA03# |                    |
|        |               |         |         | ±0.05pF            | GRM0225C1H8R1WA03# |        |               |         |                    | 9.6pF   | ±0.05pF            | GRM0225C1H9R4WA03# |
|        |               |         |         | ±0.1pF             | GRM0225C1H8R1BA03# |        |               |         |                    |         | ±0.1pF             | GRM0225C1H9R4BA03# |
|        |               |         | ±0.25pF | GRM0225C1H8R1CA03# | ±0.25pF            |        |               |         | GRM0225C1H9R4CA03# |         |                    |                    |
|        |               |         | 8.1pF   | ±0.5pF             | GRM0225C1H8R1DA03# |        |               |         | 9.7pF              | ±0.5pF  | GRM0225C1H9R4DA03# |                    |
|        |               |         |         | ±0.05pF            | GRM0225C1H8R2WA03# |        |               |         |                    | 9.8pF   | ±0.05pF            | GRM0225C1H9R5WA03# |
|        |               |         |         | ±0.1pF             | GRM0225C1H8R2BA03# |        |               |         |                    |         | ±0.1pF             | GRM0225C1H9R5BA03# |
|        |               |         | ±0.25pF | GRM0225C1H8R2CA03# | ±0.25pF            |        |               |         | GRM0225C1H9R5CA03# |         |                    |                    |
|        |               |         | 8.2pF   | ±0.5pF             | GRM0225C1H8R2DA03# |        |               |         | 9.9pF              | ±0.5pF  | GRM0225C1H9R5DA03# |                    |
|        |               |         |         | ±0.05pF            | GRM0225C1H8R3WA03# |        |               |         |                    | 10.0pF  | ±0.05pF            | GRM0225C1H9R6WA03# |
|        |               |         |         | ±0.1pF             | GRM0225C1H8R3BA03# |        |               |         |                    |         | ±0.1pF             | GRM0225C1H9R6BA03# |
|        |               |         | ±0.25pF | GRM0225C1H8R3CA03# | ±0.25pF            |        |               |         | GRM0225C1H9R6CA03# |         |                    |                    |

- GRM
- GR3
- GRJ
- GR4
- GR7
- GJM
- GQM
- GA2
- GA3 GB
- GA3 GD
- GA3 GF
- LLL
- LLA
- LLM
- LLR
- NFM
- KRM
- KR3
- GMA
- GMD
- ⚠Caution /Notice

Part number # indicates the package specification code.

# GRM Series Temperature Compensating Type Part Number List

(→ 0.4×0.2mm)

| T max. | Rated Voltage | TC Code            | Cap.   | Tol.    | Part Number        | T max.             | Rated Voltage | TC Code | Cap.               | Tol.               | Part Number        |
|--------|---------------|--------------------|--------|---------|--------------------|--------------------|---------------|---------|--------------------|--------------------|--------------------|
| 0.22mm | 50Vdc         | COG                | 9.6pF  | ±0.5pF  | GRM0225C1H9R6DA03# | 0.22mm             | 50Vdc         | CK      | 0.50pF             | ±0.05pF            | GRM0224C1HR50WA03# |
|        |               |                    |        | ±0.05pF | GRM0225C1H9R7WA03# |                    |               |         |                    | ±0.1pF             | GRM0224C1HR50BA03# |
|        |               |                    |        | ±0.1pF  | GRM0225C1H9R7BA03# |                    |               |         |                    | ±0.05pF            | GRM0224C1HR51WA03# |
|        |               |                    |        | ±0.25pF | GRM0225C1H9R7CA03# |                    |               |         |                    | ±0.05pF            | GRM0224C1HR60WA03# |
|        |               |                    |        | ±0.5pF  | GRM0225C1H9R7DA03# |                    |               |         |                    | ±0.1pF             | GRM0224C1HR60BA03# |
|        |               |                    | 9.8pF  | ±0.05pF | GRM0225C1H9R8WA03# | ±0.05pF            |               |         | GRM0224C1HR70WA03# |                    |                    |
|        |               |                    |        | ±0.1pF  | GRM0225C1H9R8BA03# | ±0.1pF             |               |         | GRM0224C1HR70BA03# |                    |                    |
|        |               |                    |        | ±0.25pF | GRM0225C1H9R8CA03# | ±0.05pF            |               |         | GRM0224C1HR80WA03# |                    |                    |
|        |               |                    |        | ±0.5pF  | GRM0225C1H9R8DA03# | ±0.1pF             |               |         | GRM0224C1HR80BA03# |                    |                    |
|        |               |                    | 9.9pF  | ±0.05pF | GRM0225C1H9R9WA03# | ±0.05pF            |               |         | GRM0224C1HR90WA03# |                    |                    |
|        |               |                    |        | ±0.1pF  | GRM0225C1H9R9BA03# | ±0.1pF             |               |         | GRM0224C1HR90BA03# |                    |                    |
|        |               |                    |        | ±0.25pF | GRM0225C1H9R9CA03# | ±0.05pF            |               |         | GRM0224C1H1R0WA03# |                    |                    |
|        |               |                    |        | ±0.5pF  | GRM0225C1H9R9DA03# | ±0.1pF             |               |         | GRM0224C1H1R0BA03# |                    |                    |
|        |               |                    | 10pF   | ±2%     | GRM0225C1H100GA03# | ±0.25pF            |               |         | GRM0224C1H1R0CA03# |                    |                    |
|        |               |                    |        | ±5%     | GRM0225C1H100JA03# | 1.1pF              |               |         | ±0.05pF            | GRM0224C1H1R1WA03# |                    |
|        |               |                    | 11pF   | ±2%     | GRM0225C1H110GA03# |                    |               |         | ±0.1pF             | GRM0224C1H1R1BA03# |                    |
|        |               |                    |        | ±5%     | GRM0225C1H110JA03# | ±0.25pF            |               |         | GRM0224C1H1R1CA03# |                    |                    |
|        |               |                    | 12pF   | ±2%     | GRM0225C1H120GA03# | 1.2pF              |               |         | ±0.05pF            | GRM0224C1H1R2WA03# |                    |
|        |               |                    |        | ±5%     | GRM0225C1H120JA03# |                    |               |         | ±0.1pF             | GRM0224C1H1R2BA03# |                    |
|        |               |                    | 13pF   | ±2%     | GRM0225C1H130GA03# | ±0.25pF            |               |         | GRM0224C1H1R2CA03# |                    |                    |
|        |               |                    |        | ±5%     | GRM0225C1H130JA03# | 1.3pF              |               |         | ±0.05pF            | GRM0224C1H1R3WA03# |                    |
|        |               |                    | 15pF   | ±2%     | GRM0225C1H150GA03# |                    |               |         | ±0.1pF             | GRM0224C1H1R3BA03# |                    |
|        |               |                    |        | ±5%     | GRM0225C1H150JA03# |                    |               |         | ±0.25pF            | GRM0224C1H1R3CA03# |                    |
|        |               |                    | 16pF   | ±2%     | GRM0225C1H160GA03# | 1.4pF              |               |         | ±0.05pF            | GRM0224C1H1R4WA03# |                    |
|        |               |                    |        | ±5%     | GRM0225C1H160JA03# |                    |               |         | ±0.1pF             | GRM0224C1H1R4BA03# |                    |
|        |               |                    | 17pF   | ±5%     | GRM0225C1H170JA02# |                    |               |         | ±0.25pF            | GRM0224C1H1R4CA03# |                    |
|        |               |                    |        | 18pF    | ±5%                | GRM0225C1H180JA02# |               |         | 1.5pF              | ±0.05pF            | GRM0224C1H1R5WA03# |
|        |               |                    | 19pF   |         | ±5%                | GRM0225C1H190JA02# |               |         |                    | ±0.1pF             | GRM0224C1H1R5BA03# |
|        |               |                    |        | 20pF    | ±5%                | GRM0225C1H200JA02# |               |         |                    | ±0.25pF            | GRM0224C1H1R5CA03# |
|        |               |                    | 21pF   |         | ±5%                | GRM0225C1H210JA02# |               |         | 1.6pF              | ±0.05pF            | GRM0224C1H1R6WA03# |
|        |               |                    |        | 22pF    | ±5%                | GRM0225C1H220JA02# |               |         |                    | ±0.1pF             | GRM0224C1H1R6BA03# |
|        |               |                    | 23pF   |         | ±5%                | GRM0225C1H230JA02# |               |         |                    | ±0.25pF            | GRM0224C1H1R6CA03# |
|        |               |                    |        | 24pF    | ±5%                | GRM0225C1H240JA02# |               |         | 1.7pF              | ±0.05pF            | GRM0224C1H1R7WA03# |
|        |               |                    | 27pF   |         | ±5%                | GRM0225C1H270JA02# |               |         |                    | ±0.1pF             | GRM0224C1H1R7BA03# |
|        |               |                    |        | 30pF    | ±5%                | GRM0225C1H300JA02# |               |         |                    | ±0.25pF            | GRM0224C1H1R7CA03# |
|        |               |                    | 33pF   |         | ±5%                | GRM0225C1H330JA02# |               |         | 1.8pF              | ±0.05pF            | GRM0224C1H1R8WA03# |
|        |               |                    |        | 36pF    | ±5%                | GRM0225C1H360JA02# |               |         |                    | ±0.1pF             | GRM0224C1H1R8BA03# |
|        |               |                    | 39pF   |         | ±5%                | GRM0225C1H390JA02# |               |         |                    | ±0.25pF            | GRM0224C1H1R8CA03# |
|        |               |                    |        | 43pF    | ±5%                | GRM0225C1H430JA02# |               |         | 1.9pF              | ±0.05pF            | GRM0224C1H1R9WA03# |
|        |               |                    | 47pF   |         | ±5%                | GRM0225C1H470JA02# |               |         |                    | ±0.1pF             | GRM0224C1H1R9BA03# |
|        |               |                    |        | 51pF    | ±5%                | GRM0225C1H510JA02# |               |         |                    | ±0.25pF            | GRM0224C1H1R9CA03# |
|        |               |                    | 56pF   |         | ±5%                | GRM0225C1H560JA02# |               |         | 2.0pF              | ±0.05pF            | GRM0224C1H2R0WA03# |
|        |               |                    |        | 62pF    | ±5%                | GRM0225C1H620JA02# |               |         |                    | ±0.1pF             | GRM0224C1H2R0BA03# |
|        |               |                    | 68pF   |         | ±5%                | GRM0225C1H680JA02# |               |         |                    | ±0.25pF            | GRM0224C1H2R0CA03# |
|        |               |                    |        | 75pF    | ±5%                | GRM0225C1H750JA02# |               |         | CJ                 | 2.1pF              | ±0.05pF            |
|        |               |                    | 82pF   |         | ±5%                | GRM0225C1H820JA02# |               |         |                    |                    | ±0.1pF             |
|        |               |                    |        | 91pF    | ±5%                | GRM0225C1H910JA02# |               |         |                    |                    | ±0.25pF            |
|        |               |                    | 100pF  |         | ±5%                | GRM0225C1H101JA02# |               |         | 2.2pF              | ±0.05pF            | GRM0223C1H2R2WA03# |
|        |               |                    |        | 0.20pF  | ±0.05pF            | GRM0224C1HR20WA03# |               |         |                    | ±0.1pF             | GRM0223C1H2R2BA03# |
|        |               |                    | ±0.1pF |         | GRM0224C1HR20BA03# | ±0.25pF            |               |         |                    | GRM0223C1H2R2CA03# |                    |
| 0.30pF | ±0.05pF       | GRM0224C1HR30WA03# | 2.3pF  | ±0.05pF | GRM0223C1H2R3WA03# |                    |               |         |                    |                    |                    |
|        | ±0.1pF        | GRM0224C1HR30BA03# |        | ±0.1pF  | GRM0223C1H2R3BA03# |                    |               |         |                    |                    |                    |
| 0.40pF | ±0.05pF       | GRM0224C1HR40WA03# |        | ±0.25pF | GRM0223C1H2R3CA03# |                    |               |         |                    |                    |                    |
|        | ±0.1pF        | GRM0224C1HR40BA03# | 2.4pF  | ±0.05pF | GRM0223C1H2R4WA03# |                    |               |         |                    |                    |                    |

Part number # indicates the package specification code.

# GRM Series Temperature Compensating Type Part Number List

(→ 0.4×0.2mm)

| T max.  | Rated Voltage      | TC Code | Cap.    | Tol.               | Part Number        | T max.             | Rated Voltage      | TC Code | Cap.  | Tol.               | Part Number        |
|---------|--------------------|---------|---------|--------------------|--------------------|--------------------|--------------------|---------|-------|--------------------|--------------------|
| 0.22mm  | 50Vdc              | CJ      | 2.4pF   | ±0.1pF             | GRM0223C1H2R4BA03# | 0.22mm             | 50Vdc              | CH      | 4.2pF | ±0.1pF             | GRM0222C1H4R2BA03# |
|         |                    |         |         | ±0.25pF            | GRM0223C1H2R4CA03# |                    |                    |         |       | ±0.25pF            | GRM0222C1H4R2CA03# |
|         |                    |         | 2.5pF   | ±0.05pF            | GRM0223C1H2R5WA03# |                    |                    |         | 4.3pF | ±0.05pF            | GRM0222C1H4R3WA03# |
|         |                    |         |         | ±0.1pF             | GRM0223C1H2R5BA03# |                    |                    |         |       | ±0.1pF             | GRM0222C1H4R3BA03# |
|         |                    |         |         | ±0.25pF            | GRM0223C1H2R5CA03# |                    |                    |         |       | ±0.25pF            | GRM0222C1H4R3CA03# |
|         |                    |         | 2.6pF   | ±0.05pF            | GRM0223C1H2R6WA03# |                    |                    |         | 4.4pF | ±0.05pF            | GRM0222C1H4R4WA03# |
|         |                    |         |         | ±0.1pF             | GRM0223C1H2R6BA03# |                    |                    |         |       | ±0.1pF             | GRM0222C1H4R4BA03# |
|         |                    |         |         | ±0.25pF            | GRM0223C1H2R6CA03# |                    |                    |         |       | ±0.25pF            | GRM0222C1H4R4CA03# |
|         |                    |         | 2.7pF   | ±0.05pF            | GRM0223C1H2R7WA03# |                    |                    |         | 4.5pF | ±0.05pF            | GRM0222C1H4R5WA03# |
|         |                    |         |         | ±0.1pF             | GRM0223C1H2R7BA03# |                    |                    |         |       | ±0.1pF             | GRM0222C1H4R5BA03# |
|         |                    |         |         | ±0.25pF            | GRM0223C1H2R7CA03# |                    |                    |         |       | ±0.25pF            | GRM0222C1H4R5CA03# |
|         |                    |         | 2.8pF   | ±0.05pF            | GRM0223C1H2R8WA03# |                    |                    |         | 4.6pF | ±0.05pF            | GRM0222C1H4R6WA03# |
|         |                    |         |         | ±0.1pF             | GRM0223C1H2R8BA03# |                    |                    |         |       | ±0.1pF             | GRM0222C1H4R6BA03# |
|         |                    |         |         | ±0.25pF            | GRM0223C1H2R8CA03# |                    |                    |         |       | ±0.25pF            | GRM0222C1H4R6CA03# |
|         |                    |         | 2.9pF   | ±0.05pF            | GRM0223C1H2R9WA03# |                    |                    |         | 4.7pF | ±0.05pF            | GRM0222C1H4R7WA03# |
|         |                    |         |         | ±0.1pF             | GRM0223C1H2R9BA03# |                    |                    |         |       | ±0.1pF             | GRM0222C1H4R7BA03# |
|         |                    |         |         | ±0.25pF            | GRM0223C1H2R9CA03# |                    |                    |         |       | ±0.25pF            | GRM0222C1H4R7CA03# |
|         |                    |         | 3.0pF   | ±0.05pF            | GRM0223C1H3R0WA03# |                    |                    |         | 4.8pF | ±0.05pF            | GRM0222C1H4R8WA03# |
|         |                    |         |         | ±0.1pF             | GRM0223C1H3R0BA03# |                    |                    |         |       | ±0.1pF             | GRM0222C1H4R8BA03# |
|         |                    |         |         | ±0.25pF            | GRM0223C1H3R0CA03# |                    |                    |         |       | ±0.25pF            | GRM0222C1H4R8CA03# |
|         |                    |         | 3.1pF   | ±0.05pF            | GRM0223C1H3R1WA03# |                    |                    |         | 4.9pF | ±0.05pF            | GRM0222C1H4R9WA03# |
|         |                    |         |         | ±0.1pF             | GRM0223C1H3R1BA03# |                    |                    |         |       | ±0.1pF             | GRM0222C1H4R9BA03# |
|         |                    |         |         | ±0.25pF            | GRM0223C1H3R1CA03# |                    |                    |         |       | ±0.25pF            | GRM0222C1H4R9CA03# |
|         |                    |         | 3.2pF   | ±0.05pF            | GRM0223C1H3R2WA03# |                    |                    |         | 5.0pF | ±0.05pF            | GRM0222C1H5R0WA03# |
|         |                    | ±0.1pF  |         | GRM0223C1H3R2BA03# | ±0.1pF             | GRM0222C1H5R0BA03# |                    |         |       |                    |                    |
|         |                    | ±0.25pF |         | GRM0223C1H3R2CA03# | ±0.25pF            | GRM0222C1H5R0CA03# |                    |         |       |                    |                    |
|         |                    | 3.3pF   | ±0.05pF | GRM0223C1H3R3WA03# | 5.1pF              | ±0.05pF            | GRM0222C1H5R1WA03# |         |       |                    |                    |
|         |                    |         | ±0.1pF  | GRM0223C1H3R3BA03# |                    | ±0.1pF             | GRM0222C1H5R1BA03# |         |       |                    |                    |
|         |                    |         | ±0.25pF | GRM0223C1H3R3CA03# |                    | ±0.25pF            | GRM0222C1H5R1CA03# |         |       |                    |                    |
|         |                    | 3.4pF   | ±0.05pF | GRM0223C1H3R4WA03# | 5.2pF              | ±0.05pF            | GRM0222C1H5R2WA03# |         |       |                    |                    |
|         |                    |         | ±0.1pF  | GRM0223C1H3R4BA03# |                    | ±0.1pF             | GRM0222C1H5R2BA03# |         |       |                    |                    |
|         |                    |         | ±0.25pF | GRM0223C1H3R4CA03# |                    | ±0.25pF            | GRM0222C1H5R2CA03# |         |       |                    |                    |
|         |                    | 3.5pF   | ±0.05pF | GRM0223C1H3R5WA03# | 5.3pF              | ±0.05pF            | GRM0222C1H5R3WA03# |         |       |                    |                    |
|         |                    |         | ±0.1pF  | GRM0223C1H3R5BA03# |                    | ±0.1pF             | GRM0222C1H5R3BA03# |         |       |                    |                    |
|         |                    |         | ±0.25pF | GRM0223C1H3R5CA03# |                    | ±0.25pF            | GRM0222C1H5R3CA03# |         |       |                    |                    |
|         |                    | 3.6pF   | ±0.05pF | GRM0223C1H3R6WA03# | 5.4pF              | ±0.05pF            | GRM0222C1H5R4WA03# |         |       |                    |                    |
|         |                    |         | ±0.1pF  | GRM0223C1H3R6BA03# |                    | ±0.1pF             | GRM0222C1H5R4BA03# |         |       |                    |                    |
|         |                    |         | ±0.25pF | GRM0223C1H3R6CA03# |                    | ±0.25pF            | GRM0222C1H5R4CA03# |         |       |                    |                    |
|         |                    | 3.7pF   | ±0.05pF | GRM0223C1H3R7WA03# | 5.5pF              | ±0.05pF            | GRM0222C1H5R5WA03# |         |       |                    |                    |
|         |                    |         | ±0.1pF  | GRM0223C1H3R7BA03# |                    | ±0.1pF             | GRM0222C1H5R5BA03# |         |       |                    |                    |
|         |                    |         | ±0.25pF | GRM0223C1H3R7CA03# |                    | ±0.25pF            | GRM0222C1H5R5CA03# |         |       |                    |                    |
|         |                    | 3.8pF   | ±0.05pF | GRM0223C1H3R8WA03# | 5.6pF              | ±0.05pF            | GRM0222C1H5R6WA03# |         |       |                    |                    |
|         |                    |         | ±0.1pF  | GRM0223C1H3R8BA03# |                    | ±0.1pF             | GRM0222C1H5R6BA03# |         |       |                    |                    |
|         |                    |         | ±0.25pF | GRM0223C1H3R8CA03# |                    | ±0.25pF            | GRM0222C1H5R6CA03# |         |       |                    |                    |
|         |                    | 3.9pF   | ±0.05pF | GRM0223C1H3R9WA03# | 5.7pF              | ±0.05pF            | GRM0222C1H5R7WA03# |         |       |                    |                    |
|         |                    |         | ±0.1pF  | GRM0223C1H3R9BA03# |                    | ±0.1pF             | GRM0222C1H5R7BA03# |         |       |                    |                    |
|         |                    |         | ±0.25pF | GRM0223C1H3R9CA03# |                    | ±0.25pF            | GRM0222C1H5R7CA03# |         |       |                    |                    |
|         |                    | CH      | 50Vdc   | 4.0pF              | ±0.05pF            | GRM0222C1H4R0WA03# | 0.22mm             | 50Vdc   | CH    | 4.2pF              | ±0.05pF            |
| ±0.1pF  | GRM0222C1H4R0BA03# |         |         |                    | ±0.1pF             | GRM0222C1H5R7BA03# |                    |         |       |                    |                    |
| ±0.25pF | GRM0222C1H4R0CA03# |         |         |                    | ±0.25pF            | GRM0222C1H5R7CA03# |                    |         |       |                    |                    |
| 4.1pF   | ±0.05pF            |         |         | GRM0222C1H4R1WA03# | 5.7pF              | ±0.05pF            |                    |         |       | GRM0222C1H5R7WA03# |                    |
|         | ±0.1pF             |         |         | GRM0222C1H4R1BA03# |                    | ±0.1pF             |                    |         |       | GRM0222C1H5R7BA03# |                    |
|         | ±0.25pF            |         |         | GRM0222C1H4R1CA03# |                    | ±0.25pF            |                    |         |       | GRM0222C1H5R7CA03# |                    |
| 4.2pF   | ±0.05pF            |         |         | GRM0222C1H4R2WA03# | 5.7pF              | ±0.05pF            |                    |         |       | GRM0222C1H5R7DA03# |                    |
|         | ±0.1pF             |         |         | GRM0222C1H4R2BA03# |                    | ±0.1pF             |                    |         |       | GRM0222C1H5R7BA03# |                    |
|         | ±0.25pF            |         |         | GRM0222C1H4R2CA03# |                    | ±0.25pF            |                    |         |       | GRM0222C1H5R7CA03# |                    |

- GRM
- GR3
- GRJ
- GR4
- GR7
- GJM
- GQM
- GA2
- GA3 GB
- GA3 GD
- GA3 GF
- LLL
- LLA
- LLM
- LLR
- NFM
- KRM
- KR3
- GMA
- GMD
- ⚠Caution /Notice

Part number # indicates the package specification code.

# GRM Series Temperature Compensating Type Part Number List

(→ 0.4×0.2mm)

| T max. | Rated Voltage | TC Code | Cap.  | Tol.    | Part Number        |
|--------|---------------|---------|-------|---------|--------------------|
| 0.22mm | 50Vdc         | CH      | 5.8pF | ±0.05pF | GRM0222C1H5R8WA03# |
|        |               |         |       | ±0.1pF  | GRM0222C1H5R8BA03# |
|        |               |         |       | ±0.25pF | GRM0222C1H5R8CA03# |
|        |               |         |       | ±0.5pF  | GRM0222C1H5R8DA03# |
|        |               |         | 5.9pF | ±0.05pF | GRM0222C1H5R9WA03# |
|        |               |         |       | ±0.1pF  | GRM0222C1H5R9BA03# |
|        |               |         |       | ±0.25pF | GRM0222C1H5R9CA03# |
|        |               |         |       | ±0.5pF  | GRM0222C1H5R9DA03# |
|        |               |         | 6.0pF | ±0.05pF | GRM0222C1H6R0WA03# |
|        |               |         |       | ±0.1pF  | GRM0222C1H6R0BA03# |
|        |               |         |       | ±0.25pF | GRM0222C1H6R0CA03# |
|        |               |         |       | ±0.5pF  | GRM0222C1H6R0DA03# |
|        |               |         | 6.1pF | ±0.05pF | GRM0222C1H6R1WA03# |
|        |               |         |       | ±0.1pF  | GRM0222C1H6R1BA03# |
|        |               |         |       | ±0.25pF | GRM0222C1H6R1CA03# |
|        |               |         |       | ±0.5pF  | GRM0222C1H6R1DA03# |
|        |               |         | 6.2pF | ±0.05pF | GRM0222C1H6R2WA03# |
|        |               |         |       | ±0.1pF  | GRM0222C1H6R2BA03# |
|        |               |         |       | ±0.25pF | GRM0222C1H6R2CA03# |
|        |               |         |       | ±0.5pF  | GRM0222C1H6R2DA03# |
|        |               |         | 6.3pF | ±0.05pF | GRM0222C1H6R3WA03# |
|        |               |         |       | ±0.1pF  | GRM0222C1H6R3BA03# |
|        |               |         |       | ±0.25pF | GRM0222C1H6R3CA03# |
|        |               |         |       | ±0.5pF  | GRM0222C1H6R3DA03# |
|        |               |         | 6.4pF | ±0.05pF | GRM0222C1H6R4WA03# |
|        |               |         |       | ±0.1pF  | GRM0222C1H6R4BA03# |
|        |               |         |       | ±0.25pF | GRM0222C1H6R4CA03# |
|        |               |         |       | ±0.5pF  | GRM0222C1H6R4DA03# |
|        |               |         | 6.5pF | ±0.05pF | GRM0222C1H6R5WA03# |
|        |               |         |       | ±0.1pF  | GRM0222C1H6R5BA03# |
|        |               |         |       | ±0.25pF | GRM0222C1H6R5CA03# |
|        |               |         |       | ±0.5pF  | GRM0222C1H6R5DA03# |
|        |               |         | 6.6pF | ±0.05pF | GRM0222C1H6R6WA03# |
|        |               |         |       | ±0.1pF  | GRM0222C1H6R6BA03# |
|        |               |         |       | ±0.25pF | GRM0222C1H6R6CA03# |
|        |               |         |       | ±0.5pF  | GRM0222C1H6R6DA03# |
|        |               |         | 6.7pF | ±0.05pF | GRM0222C1H6R7WA03# |
|        |               |         |       | ±0.1pF  | GRM0222C1H6R7BA03# |
|        |               |         |       | ±0.25pF | GRM0222C1H6R7CA03# |
|        |               |         |       | ±0.5pF  | GRM0222C1H6R7DA03# |
|        |               |         | 6.8pF | ±0.05pF | GRM0222C1H6R8WA03# |
|        |               |         |       | ±0.1pF  | GRM0222C1H6R8BA03# |
|        |               |         |       | ±0.25pF | GRM0222C1H6R8CA03# |
|        |               |         |       | ±0.5pF  | GRM0222C1H6R8DA03# |
|        |               |         | 6.9pF | ±0.05pF | GRM0222C1H6R9WA03# |
|        |               |         |       | ±0.1pF  | GRM0222C1H6R9BA03# |
|        |               |         |       | ±0.25pF | GRM0222C1H6R9CA03# |
|        |               |         |       | ±0.5pF  | GRM0222C1H6R9DA03# |
|        |               |         | 7.0pF | ±0.05pF | GRM0222C1H7R0WA03# |
|        |               |         |       | ±0.1pF  | GRM0222C1H7R0BA03# |
|        |               |         |       | ±0.25pF | GRM0222C1H7R0CA03# |
|        |               |         |       | ±0.5pF  | GRM0222C1H7R0DA03# |
|        |               |         | 7.1pF | ±0.05pF | GRM0222C1H7R1WA03# |
|        |               |         |       | ±0.1pF  | GRM0222C1H7R1BA03# |

| T max. | Rated Voltage | TC Code | Cap.  | Tol.    | Part Number        |
|--------|---------------|---------|-------|---------|--------------------|
| 0.22mm | 50Vdc         | CH      | 7.1pF | ±0.25pF | GRM0222C1H7R1CA03# |
|        |               |         |       | ±0.5pF  | GRM0222C1H7R1DA03# |
|        |               |         | 7.2pF | ±0.05pF | GRM0222C1H7R2WA03# |
|        |               |         |       | ±0.1pF  | GRM0222C1H7R2BA03# |
|        |               |         |       | ±0.25pF | GRM0222C1H7R2CA03# |
|        |               |         |       | ±0.5pF  | GRM0222C1H7R2DA03# |
|        |               |         | 7.3pF | ±0.05pF | GRM0222C1H7R3WA03# |
|        |               |         |       | ±0.1pF  | GRM0222C1H7R3BA03# |
|        |               |         |       | ±0.25pF | GRM0222C1H7R3CA03# |
|        |               |         |       | ±0.5pF  | GRM0222C1H7R3DA03# |
|        |               |         | 7.4pF | ±0.05pF | GRM0222C1H7R4WA03# |
|        |               |         |       | ±0.1pF  | GRM0222C1H7R4BA03# |
|        |               |         |       | ±0.25pF | GRM0222C1H7R4CA03# |
|        |               |         |       | ±0.5pF  | GRM0222C1H7R4DA03# |
|        |               |         | 7.5pF | ±0.05pF | GRM0222C1H7R5WA03# |
|        |               |         |       | ±0.1pF  | GRM0222C1H7R5BA03# |
|        |               |         |       | ±0.25pF | GRM0222C1H7R5CA03# |
|        |               |         |       | ±0.5pF  | GRM0222C1H7R5DA03# |
|        |               |         | 7.6pF | ±0.05pF | GRM0222C1H7R6WA03# |
|        |               |         |       | ±0.1pF  | GRM0222C1H7R6BA03# |
|        |               |         |       | ±0.25pF | GRM0222C1H7R6CA03# |
|        |               |         |       | ±0.5pF  | GRM0222C1H7R6DA03# |
|        |               |         | 7.7pF | ±0.05pF | GRM0222C1H7R7WA03# |
|        |               |         |       | ±0.1pF  | GRM0222C1H7R7BA03# |
|        |               |         |       | ±0.25pF | GRM0222C1H7R7CA03# |
|        |               |         |       | ±0.5pF  | GRM0222C1H7R7DA03# |
|        |               |         | 7.8pF | ±0.05pF | GRM0222C1H7R8WA03# |
|        |               |         |       | ±0.1pF  | GRM0222C1H7R8BA03# |
|        |               |         |       | ±0.25pF | GRM0222C1H7R8CA03# |
|        |               |         |       | ±0.5pF  | GRM0222C1H7R8DA03# |
|        |               |         | 7.9pF | ±0.05pF | GRM0222C1H7R9WA03# |
|        |               |         |       | ±0.1pF  | GRM0222C1H7R9BA03# |
|        |               |         |       | ±0.25pF | GRM0222C1H7R9CA03# |
|        |               |         |       | ±0.5pF  | GRM0222C1H7R9DA03# |
|        |               |         | 8.0pF | ±0.05pF | GRM0222C1H8R0WA03# |
|        |               |         |       | ±0.1pF  | GRM0222C1H8R0BA03# |
|        |               |         |       | ±0.25pF | GRM0222C1H8R0CA03# |
|        |               |         |       | ±0.5pF  | GRM0222C1H8R0DA03# |
|        |               |         | 8.1pF | ±0.05pF | GRM0222C1H8R1WA03# |
|        |               |         |       | ±0.1pF  | GRM0222C1H8R1BA03# |
|        |               |         |       | ±0.25pF | GRM0222C1H8R1CA03# |
|        |               |         |       | ±0.5pF  | GRM0222C1H8R1DA03# |
|        |               |         | 8.2pF | ±0.05pF | GRM0222C1H8R2WA03# |
|        |               |         |       | ±0.1pF  | GRM0222C1H8R2BA03# |
|        |               |         |       | ±0.25pF | GRM0222C1H8R2CA03# |
|        |               |         |       | ±0.5pF  | GRM0222C1H8R2DA03# |
|        |               |         | 8.3pF | ±0.05pF | GRM0222C1H8R3WA03# |
|        |               |         |       | ±0.1pF  | GRM0222C1H8R3BA03# |
|        |               |         |       | ±0.25pF | GRM0222C1H8R3CA03# |
|        |               |         |       | ±0.5pF  | GRM0222C1H8R3DA03# |
|        |               |         | 8.4pF | ±0.05pF | GRM0222C1H8R4WA03# |
|        |               |         |       | ±0.1pF  | GRM0222C1H8R4BA03# |
|        |               |         |       | ±0.25pF | GRM0222C1H8R4CA03# |
|        |               |         |       | ±0.5pF  | GRM0222C1H8R4DA03# |

Part number # indicates the package specification code.

GRM  
 GR3  
 GRJ  
 GR4  
 GR7  
 GJM  
 GQM  
 GA2  
 GA3 GB  
 GA3 GD  
 GA3 GF  
 LLL  
 LLA  
 LLM  
 LLR  
 NFM  
 KRM  
 KR3  
 GMA  
 GMD  
 ⚠Caution /Notice

# GRM Series Temperature Compensating Type Part Number List

(→ 0.4×0.2mm)

| T max. | Rated Voltage | TC Code            | Cap.  | Tol.    | Part Number        | T max.             | Rated Voltage      | TC Code | Cap.    | Tol.    | Part Number        |                    |                    |
|--------|---------------|--------------------|-------|---------|--------------------|--------------------|--------------------|---------|---------|---------|--------------------|--------------------|--------------------|
| 0.22mm | 50Vdc         | CH                 | 8.5pF | ±0.05pF | GRM0222C1H8R5WA03# | 0.22mm             | 50Vdc              | CH      | 9.8pF   | ±0.25pF | GRM0222C1H9R8CA03# |                    |                    |
|        |               |                    |       | ±0.1pF  | GRM0222C1H8R5BA03# |                    |                    |         |         | ±0.5pF  | GRM0222C1H9R8DA03# |                    |                    |
|        |               |                    |       | ±0.25pF | GRM0222C1H8R5CA03# |                    |                    |         |         | 9.9pF   | ±0.05pF            | GRM0222C1H9R9WA03# |                    |
|        |               |                    |       | ±0.5pF  | GRM0222C1H8R5DA03# |                    |                    |         |         |         | ±0.1pF             | GRM0222C1H9R9BA03# |                    |
|        |               |                    | 8.6pF | ±0.05pF | GRM0222C1H8R6WA03# |                    |                    |         | ±0.25pF |         | GRM0222C1H9R9CA03# |                    |                    |
|        |               |                    |       | ±0.1pF  | GRM0222C1H8R6BA03# |                    |                    |         | ±0.5pF  |         | GRM0222C1H9R9DA03# |                    |                    |
|        |               |                    |       | ±0.25pF | GRM0222C1H8R6CA03# |                    |                    |         | 10pF    | ±2%     | GRM0222C1H100GA03# |                    |                    |
|        |               |                    |       | ±0.5pF  | GRM0222C1H8R6DA03# |                    |                    |         |         | ±5%     | GRM0222C1H100JA03# |                    |                    |
|        |               |                    | 8.7pF | ±0.05pF | GRM0222C1H8R7WA03# |                    |                    |         | 11pF    | ±2%     | GRM0222C1H110GA03# |                    |                    |
|        |               |                    |       | ±0.1pF  | GRM0222C1H8R7BA03# |                    |                    |         |         | ±5%     | GRM0222C1H110JA03# |                    |                    |
|        |               |                    |       | ±0.25pF | GRM0222C1H8R7CA03# |                    |                    |         | 12pF    | ±2%     | GRM0222C1H120GA03# |                    |                    |
|        |               |                    |       | ±0.5pF  | GRM0222C1H8R7DA03# |                    |                    |         |         | ±5%     | GRM0222C1H120JA03# |                    |                    |
|        |               |                    | 8.8pF | ±0.05pF | GRM0222C1H8R8WA03# |                    |                    |         | 13pF    | ±2%     | GRM0222C1H130GA03# |                    |                    |
|        |               |                    |       | ±0.1pF  | GRM0222C1H8R8BA03# |                    |                    |         |         | ±5%     | GRM0222C1H130JA03# |                    |                    |
|        |               |                    |       | ±0.25pF | GRM0222C1H8R8CA03# |                    |                    |         | 15pF    | ±2%     | GRM0222C1H150GA03# |                    |                    |
|        |               |                    |       | ±0.5pF  | GRM0222C1H8R8DA03# |                    |                    |         |         | ±5%     | GRM0222C1H150JA03# |                    |                    |
|        |               |                    | 8.9pF | ±0.05pF | GRM0222C1H8R9WA03# |                    |                    |         | 16pF    | ±2%     | GRM0222C1H160GA03# |                    |                    |
|        |               |                    |       | ±0.1pF  | GRM0222C1H8R9BA03# |                    |                    |         |         | ±5%     | GRM0222C1H160JA03# |                    |                    |
|        |               |                    |       | ±0.25pF | GRM0222C1H8R9CA03# |                    |                    |         | 17pF    | ±5%     | GRM0222C1H170JA02# |                    |                    |
|        |               |                    |       | ±0.5pF  | GRM0222C1H8R9DA03# |                    |                    |         |         | 18pF    | ±5%                | GRM0222C1H180JA02# |                    |
|        |               |                    | 9.0pF | ±0.05pF | GRM0222C1H9R0WA03# |                    |                    |         | 19pF    |         | ±5%                | GRM0222C1H190JA02# |                    |
|        |               |                    |       | ±0.1pF  | GRM0222C1H9R0BA03# |                    |                    |         |         | 20pF    | ±5%                | GRM0222C1H200JA02# |                    |
|        |               |                    |       | ±0.25pF | GRM0222C1H9R0CA03# |                    |                    |         | 21pF    |         | ±5%                | GRM0222C1H210JA02# |                    |
|        |               |                    |       | ±0.5pF  | GRM0222C1H9R0DA03# |                    |                    |         |         | 22pF    | ±5%                | GRM0222C1H220JA02# |                    |
|        |               |                    | 9.1pF | ±0.05pF | GRM0222C1H9R1WA03# |                    |                    |         | 23pF    |         | ±5%                | GRM0222C1H230JA02# |                    |
|        |               |                    |       | ±0.1pF  | GRM0222C1H9R1BA03# |                    |                    |         |         | 24pF    | ±5%                | GRM0222C1H240JA02# |                    |
|        |               |                    |       | ±0.25pF | GRM0222C1H9R1CA03# |                    |                    |         | 27pF    |         | ±5%                | GRM0222C1H270JA02# |                    |
|        |               |                    |       | ±0.5pF  | GRM0222C1H9R1DA03# |                    |                    |         |         | 30pF    | ±5%                | GRM0222C1H300JA02# |                    |
|        |               |                    | 9.2pF | ±0.05pF | GRM0222C1H9R2WA03# |                    |                    |         | 33pF    |         | ±5%                | GRM0222C1H330JA02# |                    |
|        |               |                    |       | ±0.1pF  | GRM0222C1H9R2BA03# |                    |                    |         |         | 36pF    | ±5%                | GRM0222C1H360JA02# |                    |
|        |               |                    |       | ±0.25pF | GRM0222C1H9R2CA03# |                    |                    |         | 39pF    |         | ±5%                | GRM0222C1H390JA02# |                    |
|        |               |                    |       | ±0.5pF  | GRM0222C1H9R2DA03# |                    |                    |         |         | 43pF    | ±5%                | GRM0222C1H430JA02# |                    |
|        |               |                    | 9.3pF | ±0.05pF | GRM0222C1H9R3WA03# |                    |                    |         | 47pF    |         | ±5%                | GRM0222C1H470JA02# |                    |
|        |               |                    |       | ±0.1pF  | GRM0222C1H9R3BA03# |                    |                    |         |         | 51pF    | ±5%                | GRM0222C1H510JA02# |                    |
|        |               |                    |       | ±0.25pF | GRM0222C1H9R3CA03# |                    |                    |         | 56pF    |         | ±5%                | GRM0222C1H560JA02# |                    |
|        |               |                    |       | ±0.5pF  | GRM0222C1H9R3DA03# |                    |                    |         |         | 62pF    | ±5%                | GRM0222C1H620JA02# |                    |
|        |               |                    | 9.4pF | ±0.05pF | GRM0222C1H9R4WA03# |                    |                    |         | 68pF    |         | ±5%                | GRM0222C1H680JA02# |                    |
|        |               |                    |       | ±0.1pF  | GRM0222C1H9R4BA03# |                    |                    |         |         | 75pF    | ±5%                | GRM0222C1H750JA02# |                    |
|        |               |                    |       | ±0.25pF | GRM0222C1H9R4CA03# |                    |                    |         | 82pF    |         | ±5%                | GRM0222C1H820JA02# |                    |
|        |               |                    |       | ±0.5pF  | GRM0222C1H9R4DA03# |                    |                    |         |         | 91pF    | ±5%                | GRM0222C1H910JA02# |                    |
|        |               |                    | 9.5pF | ±0.05pF | GRM0222C1H9R5WA03# |                    |                    |         | 100pF   |         | ±5%                | GRM0222C1H101JA02# |                    |
|        |               |                    |       | ±0.1pF  | GRM0222C1H9R5BA03# |                    |                    |         |         | 25Vdc   | COG                | 120pF              | ±5%                |
|        |               |                    |       | ±0.25pF | GRM0222C1H9R5CA03# |                    |                    |         | 150pF   |         |                    | ±5%                | GRM0225C1E151JA02# |
|        |               |                    |       | ±0.5pF  | GRM0222C1H9R5DA03# |                    |                    |         | 180pF   |         |                    | ±5%                | GRM0225C1E181JA02# |
|        |               |                    | 9.6pF | ±0.05pF | GRM0222C1H9R6WA03# |                    |                    |         | 220pF   |         |                    | ±5%                | GRM0225C1E221JA02# |
|        |               |                    |       | ±0.1pF  | GRM0222C1H9R6BA03# |                    |                    |         | CH      | 120pF   | ±5%                | GRM0222C1E121JA02# |                    |
|        |               |                    |       | ±0.25pF | GRM0222C1H9R6CA03# |                    |                    |         |         | 150pF   | ±5%                | GRM0222C1E151JA02# |                    |
|        |               |                    |       | ±0.5pF  | GRM0222C1H9R6DA03# |                    |                    |         |         | 180pF   | ±5%                | GRM0222C1E181JA02# |                    |
| 9.7pF  | ±0.05pF       | GRM0222C1H9R7WA03# | 220pF | ±5%     | GRM0222C1E221JA02# |                    |                    |         |         |         |                    |                    |                    |
|        | ±0.1pF        | GRM0222C1H9R7BA03# | 16Vdc | COG     | 120pF              | ±5%                | GRM0225C1C121JA02# |         |         |         |                    |                    |                    |
|        | ±0.25pF       | GRM0222C1H9R7CA03# |       |         | 150pF              | ±5%                | GRM0225C1C151JA02# |         |         |         |                    |                    |                    |
|        | ±0.5pF        | GRM0222C1H9R7DA03# |       |         | 180pF              | ±5%                | GRM0225C1C181JA02# |         |         |         |                    |                    |                    |
| 9.8pF  | ±0.05pF       | GRM0222C1H9R8WA03# |       |         | 220pF              | ±5%                | GRM0225C1C221JA02# |         |         |         |                    |                    |                    |
|        | ±0.1pF        | GRM0222C1H9R8BA03# | CH    | 120pF   | ±5%                | GRM0222C1C121JA02# |                    |         |         |         |                    |                    |                    |

GRM  
 GR3  
 GRJ  
 GR4  
 GR7  
 GJM  
 GQM  
 GA2  
 GA3 GB  
 GA3 GD  
 GA3 GF  
 LLL  
 LLA  
 LLM  
 LLR  
 NFM  
 KRM  
 KR3  
 GMA  
 GMD  
 ⚠Caution /Notice

Part number # indicates the package specification code.

# GRM Series Temperature Compensating Type Part Number List

(→ 0.4×0.2mm)

| T max. | Rated Voltage | TC Code | Cap.  | Tol. | Part Number        |
|--------|---------------|---------|-------|------|--------------------|
| 0.22mm | 16Vdc         | CH      | 150pF | ±5%  | GRM0222C1C151JA02# |
|        |               |         | 180pF | ±5%  | GRM0222C1C181JA02# |
|        |               |         | 220pF | ±5%  | GRM0222C1C221JA02# |

| T max.  | Rated Voltage      | TC Code            | Cap.  | Tol.    | Part Number        |
|---------|--------------------|--------------------|-------|---------|--------------------|
| 0.33mm  | 100Vdc             | COG                | 1.9pF | ±0.25pF | GRM0335C2A1R9CA01# |
|         |                    |                    | 2.0pF | ±0.05pF | GRM0335C2A2R0WA01# |
|         |                    |                    |       | ±0.1pF  | GRM0335C2A2R0BA01# |
|         |                    |                    |       | ±0.25pF | GRM0335C2A2R0CA01# |
|         |                    |                    | 2.1pF | ±0.05pF | GRM0335C2A2R1WA01# |
|         |                    |                    |       | ±0.1pF  | GRM0335C2A2R1BA01# |
|         |                    |                    |       | ±0.25pF | GRM0335C2A2R1CA01# |
|         |                    |                    | 2.2pF | ±0.05pF | GRM0335C2A2R2WA01# |
|         |                    |                    |       | ±0.1pF  | GRM0335C2A2R2BA01# |
|         |                    |                    |       | ±0.25pF | GRM0335C2A2R2CA01# |
|         |                    |                    | 2.3pF | ±0.05pF | GRM0335C2A2R3WA01# |
|         |                    |                    |       | ±0.1pF  | GRM0335C2A2R3BA01# |
|         |                    |                    |       | ±0.25pF | GRM0335C2A2R3CA01# |
|         |                    |                    | 2.4pF | ±0.05pF | GRM0335C2A2R4WA01# |
|         |                    |                    |       | ±0.1pF  | GRM0335C2A2R4BA01# |
|         |                    |                    |       | ±0.25pF | GRM0335C2A2R4CA01# |
|         |                    |                    | 2.5pF | ±0.05pF | GRM0335C2A2R5WA01# |
|         |                    |                    |       | ±0.1pF  | GRM0335C2A2R5BA01# |
|         |                    |                    |       | ±0.25pF | GRM0335C2A2R5CA01# |
|         |                    |                    | 2.6pF | ±0.05pF | GRM0335C2A2R6WA01# |
|         |                    |                    |       | ±0.1pF  | GRM0335C2A2R6BA01# |
|         |                    |                    |       | ±0.25pF | GRM0335C2A2R6CA01# |
|         |                    |                    | 2.7pF | ±0.05pF | GRM0335C2A2R7WA01# |
|         |                    |                    |       | ±0.1pF  | GRM0335C2A2R7BA01# |
|         |                    |                    |       | ±0.25pF | GRM0335C2A2R7CA01# |
|         |                    |                    | 2.8pF | ±0.05pF | GRM0335C2A2R8WA01# |
|         |                    |                    |       | ±0.1pF  | GRM0335C2A2R8BA01# |
|         |                    |                    |       | ±0.25pF | GRM0335C2A2R8CA01# |
|         |                    |                    | 2.9pF | ±0.05pF | GRM0335C2A2R9WA01# |
|         |                    |                    |       | ±0.1pF  | GRM0335C2A2R9BA01# |
|         |                    |                    |       | ±0.25pF | GRM0335C2A2R9CA01# |
|         |                    |                    | 3.0pF | ±0.05pF | GRM0335C2A3R0WA01# |
|         |                    |                    |       | ±0.1pF  | GRM0335C2A3R0BA01# |
|         |                    |                    |       | ±0.25pF | GRM0335C2A3R0CA01# |
|         |                    |                    | 3.1pF | ±0.05pF | GRM0335C2A3R1WA01# |
|         |                    |                    |       | ±0.1pF  | GRM0335C2A3R1BA01# |
| ±0.25pF | GRM0335C2A3R1CA01# |                    |       |         |                    |
| 3.2pF   | ±0.05pF            | GRM0335C2A3R2WA01# |       |         |                    |
|         | ±0.1pF             | GRM0335C2A3R2BA01# |       |         |                    |
|         | ±0.25pF            | GRM0335C2A3R2CA01# |       |         |                    |
| 3.3pF   | ±0.05pF            | GRM0335C2A3R3WA01# |       |         |                    |
|         | ±0.1pF             | GRM0335C2A3R3BA01# |       |         |                    |
|         | ±0.25pF            | GRM0335C2A3R3CA01# |       |         |                    |
| 3.4pF   | ±0.05pF            | GRM0335C2A3R4WA01# |       |         |                    |
|         | ±0.1pF             | GRM0335C2A3R4BA01# |       |         |                    |
|         | ±0.25pF            | GRM0335C2A3R4CA01# |       |         |                    |
| 3.5pF   | ±0.05pF            | GRM0335C2A3R5WA01# |       |         |                    |
|         | ±0.1pF             | GRM0335C2A3R5BA01# |       |         |                    |
|         | ±0.25pF            | GRM0335C2A3R5CA01# |       |         |                    |
| 3.6pF   | ±0.05pF            | GRM0335C2A3R6WA01# |       |         |                    |
|         | ±0.1pF             | GRM0335C2A3R6BA01# |       |         |                    |
|         | ±0.25pF            | GRM0335C2A3R6CA01# |       |         |                    |
| 3.7pF   | ±0.05pF            | GRM0335C2A3R7WA01# |       |         |                    |
|         | ±0.1pF             | GRM0335C2A3R7BA01# |       |         |                    |

0.6×0.3mm

| T max.  | Rated Voltage      | TC Code            | Cap.   | Tol.    | Part Number        |
|---------|--------------------|--------------------|--------|---------|--------------------|
| 0.33mm  | 100Vdc             | COG                | 0.10pF | ±0.05pF | GRM0335C2AR10WA01# |
|         |                    |                    | 0.20pF | ±0.05pF | GRM0335C2AR20WA01# |
|         |                    |                    |        | ±0.1pF  | GRM0335C2AR20BA01# |
|         |                    |                    | 0.30pF | ±0.05pF | GRM0335C2AR30WA01# |
|         |                    |                    |        | ±0.1pF  | GRM0335C2AR30BA01# |
|         |                    |                    | 0.40pF | ±0.05pF | GRM0335C2AR40WA01# |
|         |                    |                    |        | ±0.1pF  | GRM0335C2AR40BA01# |
|         |                    |                    | 0.50pF | ±0.05pF | GRM0335C2AR50WA01# |
|         |                    |                    |        | ±0.1pF  | GRM0335C2AR50BA01# |
|         |                    |                    | 0.60pF | ±0.05pF | GRM0335C2AR60WA01# |
|         |                    |                    |        | ±0.1pF  | GRM0335C2AR60BA01# |
|         |                    |                    | 0.70pF | ±0.05pF | GRM0335C2AR70WA01# |
|         |                    |                    |        | ±0.1pF  | GRM0335C2AR70BA01# |
|         |                    |                    | 0.80pF | ±0.05pF | GRM0335C2AR80WA01# |
|         |                    |                    |        | ±0.1pF  | GRM0335C2AR80BA01# |
|         |                    |                    | 0.90pF | ±0.05pF | GRM0335C2AR90WA01# |
|         |                    |                    |        | ±0.1pF  | GRM0335C2AR90BA01# |
|         |                    |                    | 1.0pF  | ±0.05pF | GRM0335C2A1R0WA01# |
|         |                    |                    |        | ±0.1pF  | GRM0335C2A1R0BA01# |
|         |                    |                    |        | ±0.25pF | GRM0335C2A1R0CA01# |
|         |                    |                    | 1.1pF  | ±0.05pF | GRM0335C2A1R1WA01# |
|         |                    |                    |        | ±0.1pF  | GRM0335C2A1R1BA01# |
|         |                    |                    |        | ±0.25pF | GRM0335C2A1R1CA01# |
|         |                    |                    | 1.2pF  | ±0.05pF | GRM0335C2A1R2WA01# |
|         |                    |                    |        | ±0.1pF  | GRM0335C2A1R2BA01# |
|         |                    |                    |        | ±0.25pF | GRM0335C2A1R2CA01# |
|         |                    |                    | 1.3pF  | ±0.05pF | GRM0335C2A1R3WA01# |
|         |                    |                    |        | ±0.1pF  | GRM0335C2A1R3BA01# |
|         |                    |                    |        | ±0.25pF | GRM0335C2A1R3CA01# |
|         |                    |                    | 1.4pF  | ±0.05pF | GRM0335C2A1R4WA01# |
|         |                    |                    |        | ±0.1pF  | GRM0335C2A1R4BA01# |
|         |                    |                    |        | ±0.25pF | GRM0335C2A1R4CA01# |
|         |                    |                    | 1.5pF  | ±0.05pF | GRM0335C2A1R5WA01# |
|         |                    |                    |        | ±0.1pF  | GRM0335C2A1R5BA01# |
|         |                    |                    |        | ±0.25pF | GRM0335C2A1R5CA01# |
|         |                    |                    | 1.6pF  | ±0.05pF | GRM0335C2A1R6WA01# |
|         |                    |                    |        | ±0.1pF  | GRM0335C2A1R6BA01# |
|         |                    |                    |        | ±0.25pF | GRM0335C2A1R6CA01# |
|         |                    |                    | 1.7pF  | ±0.05pF | GRM0335C2A1R7WA01# |
|         |                    |                    |        | ±0.1pF  | GRM0335C2A1R7BA01# |
|         |                    |                    |        | ±0.25pF | GRM0335C2A1R7CA01# |
|         |                    |                    | 1.8pF  | ±0.05pF | GRM0335C2A1R8WA01# |
| ±0.1pF  | GRM0335C2A1R8BA01# |                    |        |         |                    |
| ±0.25pF | GRM0335C2A1R8CA01# |                    |        |         |                    |
| 1.9pF   | ±0.05pF            | GRM0335C2A1R9WA01# |        |         |                    |
|         | ±0.1pF             | GRM0335C2A1R9BA01# |        |         |                    |

Part number # indicates the package specification code.

GRM  
 GR3  
 GRJ  
 GR4  
 GR7  
 GJM  
 GQM  
 GA2  
 GA3 GB  
 GA3 GD  
 GA3 GF  
 LLL  
 LLA  
 LLM  
 LLR  
 NFM  
 KRM  
 KR3  
 GMA  
 GMD  
 ⚠Caution /Notice

# GRM Series Temperature Compensating Type Part Number List

(→ 0.6×0.3mm)

| T max. | Rated Voltage | TC Code | Cap.    | Tol.               | Part Number        | T max. | Rated Voltage | TC Code | Cap.               | Tol.               | Part Number        |                    |                    |
|--------|---------------|---------|---------|--------------------|--------------------|--------|---------------|---------|--------------------|--------------------|--------------------|--------------------|--------------------|
| 0.33mm | 100Vdc        | COG     | 3.7pF   | ±0.25pF            | GRM0335C2A3R7CA01# | 0.33mm | 100Vdc        | COG     | 5.4pF              | ±0.25pF            | GRM0335C2A5R4CA01# |                    |                    |
|        |               |         |         | ±0.05pF            | GRM0335C2A3R8WA01# |        |               |         |                    | ±0.5pF             | GRM0335C2A5R4DA01# |                    |                    |
|        |               |         | ±0.1pF  | GRM0335C2A3R8BA01# | 5.5pF              |        |               |         | ±0.05pF            | GRM0335C2A5R5WA01# |                    |                    |                    |
|        |               |         |         | ±0.25pF            |                    |        |               |         | GRM0335C2A3R8CA01# | ±0.1pF             | GRM0335C2A5R5BA01# |                    |                    |
|        |               |         |         | ±0.05pF            |                    |        |               |         | GRM0335C2A3R9WA01# | ±0.25pF            | GRM0335C2A5R5CA01# |                    |                    |
|        |               |         | ±0.1pF  |                    | GRM0335C2A3R9BA01# |        |               |         | ±0.5pF             | GRM0335C2A5R5DA01# |                    |                    |                    |
|        |               |         | ±0.25pF | GRM0335C2A3R9CA01# | 5.6pF              |        |               |         |                    | ±0.05pF            | GRM0335C2A5R6WA01# |                    |                    |
|        |               |         | ±0.05pF | GRM0335C2A4R0WA01# |                    |        |               |         | ±0.1pF             | GRM0335C2A5R6BA01# |                    |                    |                    |
|        |               |         |         | ±0.1pF             |                    |        |               |         | GRM0335C2A4R0BA01# | ±0.25pF            | GRM0335C2A5R6CA01# |                    |                    |
|        |               |         |         | ±0.25pF            | GRM0335C2A4R0CA01# |        |               |         | ±0.5pF             | GRM0335C2A5R6DA01# |                    |                    |                    |
|        |               |         | 4.1pF   | ±0.05pF            | GRM0335C2A4R1WA01# |        |               |         | 5.7pF              | ±0.05pF            | GRM0335C2A5R7WA01# |                    |                    |
|        |               |         |         | ±0.1pF             | GRM0335C2A4R1BA01# |        |               |         |                    | ±0.1pF             | GRM0335C2A5R7BA01# |                    |                    |
|        |               |         |         | ±0.25pF            | GRM0335C2A4R1CA01# |        |               |         |                    | ±0.25pF            | GRM0335C2A5R7CA01# |                    |                    |
|        |               |         | 4.2pF   | ±0.05pF            | GRM0335C2A4R2WA01# |        |               |         | ±0.5pF             | GRM0335C2A5R7DA01# | 5.8pF              | ±0.05pF            | GRM0335C2A5R8WA01# |
|        |               |         |         | ±0.1pF             | GRM0335C2A4R2BA01# |        |               |         |                    | ±0.1pF             |                    | GRM0335C2A5R8BA01# |                    |
|        |               |         |         | ±0.25pF            | GRM0335C2A4R2CA01# |        |               |         |                    | ±0.25pF            |                    | GRM0335C2A5R8CA01# |                    |
|        |               |         | 4.3pF   | ±0.05pF            | GRM0335C2A4R3WA01# |        |               |         | ±0.5pF             | GRM0335C2A5R8DA01# | ±0.05pF            | GRM0335C2A5R9WA01# |                    |
|        |               |         |         | ±0.1pF             | GRM0335C2A4R3BA01# |        |               |         | 5.9pF              | ±0.1pF             |                    | GRM0335C2A5R9BA01# |                    |
|        |               |         |         | ±0.25pF            | GRM0335C2A4R3CA01# |        |               |         |                    | ±0.25pF            |                    | GRM0335C2A5R9CA01# |                    |
|        |               |         | 4.4pF   | ±0.05pF            | GRM0335C2A4R4WA01# |        |               |         |                    | ±0.5pF             | GRM0335C2A5R9DA01# | 6.0pF              | ±0.05pF            |
|        |               |         |         | ±0.1pF             | GRM0335C2A4R4BA01# |        |               |         | ±0.1pF             | GRM0335C2A6R0BA01# | ±0.1pF             |                    | GRM0335C2A6R0BA01# |
|        |               |         |         | ±0.25pF            | GRM0335C2A4R4CA01# |        |               |         | ±0.25pF            | GRM0335C2A6R0CA01# | ±0.25pF            |                    | GRM0335C2A6R0CA01# |
|        |               |         | 4.5pF   | ±0.05pF            | GRM0335C2A4R5WA01# |        |               |         | 6.1pF              | ±0.5pF             | GRM0335C2A6R0DA01# | ±0.05pF            | GRM0335C2A6R1WA01# |
|        |               |         |         | ±0.1pF             | GRM0335C2A4R5BA01# |        |               |         |                    | ±0.1pF             | GRM0335C2A6R1BA01# | ±0.1pF             | GRM0335C2A6R1BA01# |
|        |               |         |         | ±0.25pF            | GRM0335C2A4R5CA01# |        |               |         |                    | ±0.25pF            | GRM0335C2A6R1CA01# | ±0.25pF            | GRM0335C2A6R1CA01# |
|        |               |         | 4.6pF   | ±0.05pF            | GRM0335C2A4R6WA01# |        |               |         | 6.2pF              | ±0.5pF             | GRM0335C2A6R1DA01# | ±0.05pF            | GRM0335C2A6R2WA01# |
|        |               |         |         | ±0.1pF             | GRM0335C2A4R6BA01# |        |               |         |                    | ±0.1pF             | GRM0335C2A6R2BA01# | ±0.1pF             | GRM0335C2A6R2BA01# |
|        |               |         |         | ±0.25pF            | GRM0335C2A4R6CA01# |        |               |         |                    | ±0.25pF            | GRM0335C2A6R2CA01# | ±0.25pF            | GRM0335C2A6R2CA01# |
|        |               |         | 4.7pF   | ±0.05pF            | GRM0335C2A4R7WA01# |        |               |         | 6.3pF              | ±0.5pF             | GRM0335C2A6R2DA01# | ±0.05pF            | GRM0335C2A6R3WA01# |
|        |               |         |         | ±0.1pF             | GRM0335C2A4R7BA01# |        |               |         |                    | ±0.1pF             | GRM0335C2A6R3BA01# | ±0.1pF             | GRM0335C2A6R3BA01# |
|        |               |         |         | ±0.25pF            | GRM0335C2A4R7CA01# |        |               |         |                    | ±0.25pF            | GRM0335C2A6R3CA01# | ±0.25pF            | GRM0335C2A6R3CA01# |
|        |               |         | 4.8pF   | ±0.05pF            | GRM0335C2A4R8WA01# |        |               |         | 6.4pF              | ±0.5pF             | GRM0335C2A6R3DA01# | ±0.05pF            | GRM0335C2A6R4WA01# |
|        |               |         |         | ±0.1pF             | GRM0335C2A4R8BA01# |        |               |         |                    | ±0.1pF             | GRM0335C2A6R4BA01# | ±0.1pF             | GRM0335C2A6R4BA01# |
|        |               |         |         | ±0.25pF            | GRM0335C2A4R8CA01# |        |               |         |                    | ±0.25pF            | GRM0335C2A6R4CA01# | ±0.25pF            | GRM0335C2A6R4CA01# |
|        |               |         | 4.9pF   | ±0.05pF            | GRM0335C2A4R9WA01# |        |               |         | 6.5pF              | ±0.5pF             | GRM0335C2A6R4DA01# | ±0.05pF            | GRM0335C2A6R5WA01# |
|        |               |         |         | ±0.1pF             | GRM0335C2A4R9BA01# |        |               |         |                    | ±0.1pF             | GRM0335C2A6R5BA01# | ±0.1pF             | GRM0335C2A6R5BA01# |
|        |               |         |         | ±0.25pF            | GRM0335C2A4R9CA01# |        |               |         |                    | ±0.25pF            | GRM0335C2A6R5CA01# | ±0.25pF            | GRM0335C2A6R5CA01# |
|        |               |         | 5.0pF   | ±0.05pF            | GRM0335C2A5R0WA01# |        |               |         | 6.6pF              | ±0.5pF             | GRM0335C2A6R5DA01# | ±0.05pF            | GRM0335C2A6R6WA01# |
|        |               |         |         | ±0.1pF             | GRM0335C2A5R0BA01# |        |               |         |                    | ±0.1pF             | GRM0335C2A6R6BA01# | ±0.1pF             | GRM0335C2A6R6BA01# |
|        |               |         |         | ±0.25pF            | GRM0335C2A5R0CA01# |        |               |         |                    | ±0.25pF            | GRM0335C2A6R6CA01# | ±0.25pF            | GRM0335C2A6R6CA01# |
|        |               |         | 5.1pF   | ±0.05pF            | GRM0335C2A5R1WA01# |        |               |         | 6.7pF              | ±0.5pF             | GRM0335C2A6R6DA01# | ±0.05pF            | GRM0335C2A6R7WA01# |
|        |               |         |         | ±0.1pF             | GRM0335C2A5R1BA01# |        |               |         |                    | ±0.1pF             | GRM0335C2A6R7BA01# | ±0.1pF             | GRM0335C2A6R7BA01# |
|        |               |         |         | ±0.25pF            | GRM0335C2A5R1CA01# |        |               |         |                    | ±0.25pF            | GRM0335C2A6R7CA01# | ±0.25pF            | GRM0335C2A6R7CA01# |
|        |               |         |         | ±0.5pF             | GRM0335C2A5R1DA01# |        |               |         |                    | ±0.5pF             | GRM0335C2A6R7DA01# | ±0.5pF             | GRM0335C2A6R7DA01# |
|        |               |         | 5.2pF   | ±0.05pF            | GRM0335C2A5R2WA01# |        |               |         | 6.8pF              | ±0.5pF             | GRM0335C2A6R8DA01# | ±0.05pF            | GRM0335C2A6R8WA01# |
|        |               |         |         | ±0.1pF             | GRM0335C2A5R2BA01# |        |               |         |                    | ±0.1pF             | GRM0335C2A6R8BA01# | ±0.1pF             | GRM0335C2A6R8BA01# |
|        |               |         |         | ±0.25pF            | GRM0335C2A5R2CA01# |        |               |         |                    | ±0.25pF            | GRM0335C2A6R8CA01# | ±0.25pF            | GRM0335C2A6R8CA01# |
|        |               |         |         | ±0.5pF             | GRM0335C2A5R2DA01# |        |               |         |                    | ±0.5pF             | GRM0335C2A6R8DA01# | ±0.5pF             | GRM0335C2A6R8DA01# |
|        |               |         | 5.3pF   | ±0.05pF            | GRM0335C2A5R3WA01# |        |               |         | 6.9pF              | ±0.5pF             | GRM0335C2A6R9DA01# | ±0.05pF            | GRM0335C2A6R9WA01# |
|        |               |         |         | ±0.1pF             | GRM0335C2A5R3BA01# |        |               |         |                    | ±0.1pF             | GRM0335C2A6R9BA01# | ±0.1pF             | GRM0335C2A6R9BA01# |
|        |               |         |         | ±0.25pF            | GRM0335C2A5R3CA01# |        |               |         |                    | ±0.25pF            | GRM0335C2A6R9CA01# | ±0.25pF            | GRM0335C2A6R9CA01# |
|        |               |         |         | ±0.5pF             | GRM0335C2A5R3DA01# |        |               |         |                    | ±0.5pF             | GRM0335C2A6R9DA01# | ±0.5pF             | GRM0335C2A6R9DA01# |
|        |               |         | 5.4pF   | ±0.05pF            | GRM0335C2A5R4WA01# |        |               |         | 7.0pF              | ±0.5pF             | GRM0335C2A6R0DA01# | ±0.05pF            | GRM0335C2A6R0WA01# |
|        |               |         |         | ±0.1pF             | GRM0335C2A5R4BA01# |        |               |         |                    | ±0.1pF             | GRM0335C2A6R0BA01# | ±0.1pF             | GRM0335C2A6R0BA01# |

- GRM
- GR3
- GRJ
- GR4
- GR7
- GJM
- GQM
- GA2
- GA3 GB
- GA3 GD
- GA3 GF
- LLL
- LLA
- LLM
- LLR
- NFM
- KRM
- KR3
- GMA
- GMD
- ⚠Caution /Notice

Part number # indicates the package specification code.



# GRM Series Temperature Compensating Type Part Number List

(→ 0.6×0.3mm)

| T max. | Rated Voltage | TC Code | Cap.  | Tol.    | Part Number        |
|--------|---------------|---------|-------|---------|--------------------|
| 0.33mm | 100Vdc        | COG     | 6.8pF | ±0.05pF | GRM0335C2A6R8WA01# |
|        |               |         |       | ±0.1pF  | GRM0335C2A6R8BA01# |
|        |               |         |       | ±0.25pF | GRM0335C2A6R8CA01# |
|        |               |         |       | ±0.5pF  | GRM0335C2A6R8DA01# |
|        |               |         | 6.9pF | ±0.05pF | GRM0335C2A6R9WA01# |
|        |               |         |       | ±0.1pF  | GRM0335C2A6R9BA01# |
|        |               |         |       | ±0.25pF | GRM0335C2A6R9CA01# |
|        |               |         |       | ±0.5pF  | GRM0335C2A6R9DA01# |
|        |               |         | 7.0pF | ±0.05pF | GRM0335C2A7R0WA01# |
|        |               |         |       | ±0.1pF  | GRM0335C2A7R0BA01# |
|        |               |         |       | ±0.25pF | GRM0335C2A7R0CA01# |
|        |               |         |       | ±0.5pF  | GRM0335C2A7R0DA01# |
|        |               |         | 7.1pF | ±0.05pF | GRM0335C2A7R1WA01# |
|        |               |         |       | ±0.1pF  | GRM0335C2A7R1BA01# |
|        |               |         |       | ±0.25pF | GRM0335C2A7R1CA01# |
|        |               |         |       | ±0.5pF  | GRM0335C2A7R1DA01# |
|        |               |         | 7.2pF | ±0.05pF | GRM0335C2A7R2WA01# |
|        |               |         |       | ±0.1pF  | GRM0335C2A7R2BA01# |
|        |               |         |       | ±0.25pF | GRM0335C2A7R2CA01# |
|        |               |         |       | ±0.5pF  | GRM0335C2A7R2DA01# |
|        |               |         | 7.3pF | ±0.05pF | GRM0335C2A7R3WA01# |
|        |               |         |       | ±0.1pF  | GRM0335C2A7R3BA01# |
|        |               |         |       | ±0.25pF | GRM0335C2A7R3CA01# |
|        |               |         |       | ±0.5pF  | GRM0335C2A7R3DA01# |
|        |               |         | 7.4pF | ±0.05pF | GRM0335C2A7R4WA01# |
|        |               |         |       | ±0.1pF  | GRM0335C2A7R4BA01# |
|        |               |         |       | ±0.25pF | GRM0335C2A7R4CA01# |
|        |               |         |       | ±0.5pF  | GRM0335C2A7R4DA01# |
|        |               |         | 7.5pF | ±0.05pF | GRM0335C2A7R5WA01# |
|        |               |         |       | ±0.1pF  | GRM0335C2A7R5BA01# |
|        |               |         |       | ±0.25pF | GRM0335C2A7R5CA01# |
|        |               |         |       | ±0.5pF  | GRM0335C2A7R5DA01# |
|        |               |         | 7.6pF | ±0.05pF | GRM0335C2A7R6WA01# |
|        |               |         |       | ±0.1pF  | GRM0335C2A7R6BA01# |
|        |               |         |       | ±0.25pF | GRM0335C2A7R6CA01# |
|        |               |         |       | ±0.5pF  | GRM0335C2A7R6DA01# |
|        |               |         | 7.7pF | ±0.05pF | GRM0335C2A7R7WA01# |
|        |               |         |       | ±0.1pF  | GRM0335C2A7R7BA01# |
|        |               |         |       | ±0.25pF | GRM0335C2A7R7CA01# |
|        |               |         |       | ±0.5pF  | GRM0335C2A7R7DA01# |
|        |               |         | 7.8pF | ±0.05pF | GRM0335C2A7R8WA01# |
|        |               |         |       | ±0.1pF  | GRM0335C2A7R8BA01# |
|        |               |         |       | ±0.25pF | GRM0335C2A7R8CA01# |
|        |               |         |       | ±0.5pF  | GRM0335C2A7R8DA01# |
|        |               |         | 7.9pF | ±0.05pF | GRM0335C2A7R9WA01# |
|        |               |         |       | ±0.1pF  | GRM0335C2A7R9BA01# |
|        |               |         |       | ±0.25pF | GRM0335C2A7R9CA01# |
|        |               |         |       | ±0.5pF  | GRM0335C2A7R9DA01# |
|        |               |         | 8.0pF | ±0.05pF | GRM0335C2A8R0WA01# |
|        |               |         |       | ±0.1pF  | GRM0335C2A8R0BA01# |
|        |               |         |       | ±0.25pF | GRM0335C2A8R0CA01# |
|        |               |         |       | ±0.5pF  | GRM0335C2A8R0DA01# |
|        |               |         | 8.1pF | ±0.05pF | GRM0335C2A8R1WA01# |
|        |               |         |       | ±0.1pF  | GRM0335C2A8R1BA01# |

| T max. | Rated Voltage | TC Code | Cap.  | Tol.    | Part Number        |
|--------|---------------|---------|-------|---------|--------------------|
| 0.33mm | 100Vdc        | COG     | 8.1pF | ±0.25pF | GRM0335C2A8R1CA01# |
|        |               |         |       | ±0.5pF  | GRM0335C2A8R1DA01# |
|        |               |         | 8.2pF | ±0.05pF | GRM0335C2A8R2WA01# |
|        |               |         |       | ±0.1pF  | GRM0335C2A8R2BA01# |
|        |               |         |       | ±0.25pF | GRM0335C2A8R2CA01# |
|        |               |         |       | ±0.5pF  | GRM0335C2A8R2DA01# |
|        |               |         | 8.3pF | ±0.05pF | GRM0335C2A8R3WA01# |
|        |               |         |       | ±0.1pF  | GRM0335C2A8R3BA01# |
|        |               |         |       | ±0.25pF | GRM0335C2A8R3CA01# |
|        |               |         |       | ±0.5pF  | GRM0335C2A8R3DA01# |
|        |               |         | 8.4pF | ±0.05pF | GRM0335C2A8R4WA01# |
|        |               |         |       | ±0.1pF  | GRM0335C2A8R4BA01# |
|        |               |         |       | ±0.25pF | GRM0335C2A8R4CA01# |
|        |               |         |       | ±0.5pF  | GRM0335C2A8R4DA01# |
|        |               |         | 8.5pF | ±0.05pF | GRM0335C2A8R5WA01# |
|        |               |         |       | ±0.1pF  | GRM0335C2A8R5BA01# |
|        |               |         |       | ±0.25pF | GRM0335C2A8R5CA01# |
|        |               |         |       | ±0.5pF  | GRM0335C2A8R5DA01# |
|        |               |         | 8.6pF | ±0.05pF | GRM0335C2A8R6WA01# |
|        |               |         |       | ±0.1pF  | GRM0335C2A8R6BA01# |
|        |               |         |       | ±0.25pF | GRM0335C2A8R6CA01# |
|        |               |         |       | ±0.5pF  | GRM0335C2A8R6DA01# |
|        |               |         | 8.7pF | ±0.05pF | GRM0335C2A8R7WA01# |
|        |               |         |       | ±0.1pF  | GRM0335C2A8R7BA01# |
|        |               |         |       | ±0.25pF | GRM0335C2A8R7CA01# |
|        |               |         |       | ±0.5pF  | GRM0335C2A8R7DA01# |
|        |               |         | 8.8pF | ±0.05pF | GRM0335C2A8R8WA01# |
|        |               |         |       | ±0.1pF  | GRM0335C2A8R8BA01# |
|        |               |         |       | ±0.25pF | GRM0335C2A8R8CA01# |
|        |               |         |       | ±0.5pF  | GRM0335C2A8R8DA01# |
|        |               |         | 8.9pF | ±0.05pF | GRM0335C2A8R9WA01# |
|        |               |         |       | ±0.1pF  | GRM0335C2A8R9BA01# |
|        |               |         |       | ±0.25pF | GRM0335C2A8R9CA01# |
|        |               |         |       | ±0.5pF  | GRM0335C2A8R9DA01# |
|        |               |         | 9.0pF | ±0.05pF | GRM0335C2A9R0WA01# |
|        |               |         |       | ±0.1pF  | GRM0335C2A9R0BA01# |
|        |               |         |       | ±0.25pF | GRM0335C2A9R0CA01# |
|        |               |         |       | ±0.5pF  | GRM0335C2A9R0DA01# |
|        |               |         | 9.1pF | ±0.05pF | GRM0335C2A9R1WA01# |
|        |               |         |       | ±0.1pF  | GRM0335C2A9R1BA01# |
|        |               |         |       | ±0.25pF | GRM0335C2A9R1CA01# |
|        |               |         |       | ±0.5pF  | GRM0335C2A9R1DA01# |
|        |               |         | 9.2pF | ±0.05pF | GRM0335C2A9R2WA01# |
|        |               |         |       | ±0.1pF  | GRM0335C2A9R2BA01# |
|        |               |         |       | ±0.25pF | GRM0335C2A9R2CA01# |
|        |               |         |       | ±0.5pF  | GRM0335C2A9R2DA01# |
|        |               |         | 9.3pF | ±0.05pF | GRM0335C2A9R3WA01# |
|        |               |         |       | ±0.1pF  | GRM0335C2A9R3BA01# |
|        |               |         |       | ±0.25pF | GRM0335C2A9R3CA01# |
|        |               |         |       | ±0.5pF  | GRM0335C2A9R3DA01# |
|        |               |         | 9.4pF | ±0.05pF | GRM0335C2A9R4WA01# |
|        |               |         |       | ±0.1pF  | GRM0335C2A9R4BA01# |
|        |               |         |       | ±0.25pF | GRM0335C2A9R4CA01# |
|        |               |         |       | ±0.5pF  | GRM0335C2A9R4DA01# |

Part number # indicates the package specification code.

- GRM
- GR3
- GRJ
- GR4
- GR7
- GJM
- GQM
- GA2
- GA3 GB
- GA3 GD
- GA3 GF
- LLL
- LLA
- LLM
- LLR
- NFM
- KRM
- KR3
- GMA
- GMD
- ⚠Caution /Notice

# GRM Series Temperature Compensating Type Part Number List

(→ 0.6×0.3mm)

| T max. | Rated Voltage | TC Code | Cap.  | Tol.    | Part Number        | T max. | Rated Voltage | TC Code | Cap.    | Tol.               | Part Number        |                    |                    |
|--------|---------------|---------|-------|---------|--------------------|--------|---------------|---------|---------|--------------------|--------------------|--------------------|--------------------|
| 0.33mm | 100Vdc        | COG     | 9.5pF | ±0.05pF | GRM0335C2A9R5WA01# | 0.33mm | 100Vdc        | COG     | 68pF    | ±2%                | GRM0335C2A680GA01# |                    |                    |
|        |               |         |       | ±0.1pF  | GRM0335C2A9R5BA01# |        |               |         |         | ±5%                | GRM0335C2A680JA01# |                    |                    |
|        |               |         |       | ±0.25pF | GRM0335C2A9R5CA01# |        |               |         |         | 75pF               | ±2%                | GRM0335C2A750GA01# |                    |
|        |               |         |       | ±0.5pF  | GRM0335C2A9R5DA01# |        |               |         |         |                    | ±5%                | GRM0335C2A750JA01# |                    |
|        |               |         | 9.6pF | ±0.05pF | GRM0335C2A9R6WA01# |        |               |         | 82pF    | ±2%                | GRM0335C2A820GA01# |                    |                    |
|        |               |         |       | ±0.1pF  | GRM0335C2A9R6BA01# |        |               |         |         | ±5%                | GRM0335C2A820JA01# |                    |                    |
|        |               |         |       | ±0.25pF | GRM0335C2A9R6CA01# |        |               |         |         | 91pF               | ±2%                | GRM0335C2A910GA01# |                    |
|        |               |         |       | ±0.5pF  | GRM0335C2A9R6DA01# |        |               |         |         |                    | ±5%                | GRM0335C2A910JA01# |                    |
|        |               |         | 9.7pF | ±0.05pF | GRM0335C2A9R7WA01# |        |               |         | 100pF   | ±2%                | GRM0335C2A101GA01# |                    |                    |
|        |               |         |       | ±0.1pF  | GRM0335C2A9R7BA01# |        |               |         |         | ±5%                | GRM0335C2A101JA01# |                    |                    |
|        |               |         |       | ±0.25pF | GRM0335C2A9R7CA01# |        |               |         |         |                    | CK                 | 0.10pF             | ±0.05pF            |
|        |               |         |       | ±0.5pF  | GRM0335C2A9R7DA01# |        |               |         |         | 0.20pF             |                    | ±0.05pF            | GRM0334C2AR20WA01# |
|        |               |         | 9.8pF | ±0.05pF | GRM0335C2A9R8WA01# |        |               |         | ±0.1pF  | GRM0334C2AR20BA01# | 0.30pF             | ±0.05pF            | GRM0334C2AR30WA01# |
|        |               |         |       | ±0.1pF  | GRM0335C2A9R8BA01# |        |               |         |         | ±0.1pF             |                    | GRM0334C2AR30BA01# |                    |
|        |               |         |       | ±0.25pF | GRM0335C2A9R8CA01# |        |               |         |         | 0.40pF             |                    | ±0.05pF            | GRM0334C2AR40WA01# |
|        |               |         |       | ±0.5pF  | GRM0335C2A9R8DA01# |        |               |         |         |                    |                    | ±0.1pF             | GRM0334C2AR40BA01# |
|        |               |         | 9.9pF | ±0.05pF | GRM0335C2A9R9WA01# |        |               |         | ±0.05pF | GRM0334C2AR50WA01# | 0.50pF             | ±0.05pF            | GRM0334C2AR50WA01# |
|        |               |         |       | ±0.1pF  | GRM0335C2A9R9BA01# |        |               |         |         | ±0.1pF             |                    | GRM0334C2AR50BA01# |                    |
|        |               |         |       | ±0.25pF | GRM0335C2A9R9CA01# |        |               |         |         | ±0.05pF            |                    | GRM0334C2AR60WA01# |                    |
|        |               |         |       | ±0.5pF  | GRM0335C2A9R9DA01# |        |               |         |         |                    |                    | ±0.1pF             | GRM0334C2AR60BA01# |
|        |               |         | 10pF  | ±2%     | GRM0335C2A100GA01# |        |               |         | ±0.1pF  | GRM0334C2AR70WA01# | 0.60pF             | ±0.05pF            | GRM0334C2AR70WA01# |
|        |               |         |       | ±5%     | GRM0335C2A100JA01# |        |               |         |         | ±0.1pF             |                    | GRM0334C2AR70BA01# |                    |
|        |               |         | 12pF  | ±2%     | GRM0335C2A120GA01# |        |               |         | ±0.05pF | GRM0334C2AR80WA01# | 0.70pF             | ±0.05pF            | GRM0334C2AR80WA01# |
|        |               |         |       | ±5%     | GRM0335C2A120JA01# |        |               |         |         | ±0.1pF             |                    | GRM0334C2AR80BA01# |                    |
|        |               |         | 15pF  | ±2%     | GRM0335C2A150GA01# |        |               |         | ±0.05pF | GRM0334C2AR90WA01# | 0.80pF             | ±0.05pF            | GRM0334C2AR90WA01# |
|        |               |         |       | ±5%     | GRM0335C2A150JA01# |        |               |         |         | ±0.1pF             |                    | GRM0334C2AR90BA01# |                    |
|        |               |         | 18pF  | ±2%     | GRM0335C2A180GA01# |        |               |         | ±0.05pF | GRM0334C2A1R0WA01# | 1.0pF              | ±0.05pF            | GRM0334C2A1R0WA01# |
|        |               |         |       | ±5%     | GRM0335C2A180JA01# |        |               |         |         | ±0.1pF             |                    | GRM0334C2A1R0BA01# |                    |
|        |               |         | 20pF  | ±2%     | GRM0335C2A200GA01# |        |               |         | ±0.1pF  | GRM0334C2A1R1WA01# | 1.1pF              | ±0.05pF            | GRM0334C2A1R1WA01# |
|        |               |         |       | ±5%     | GRM0335C2A200JA01# |        |               |         |         | ±0.1pF             |                    | GRM0334C2A1R1BA01# |                    |
|        |               |         | 22pF  | ±2%     | GRM0335C2A220GA01# |        |               |         | ±0.1pF  | GRM0334C2A1R1CA01# | 1.2pF              | ±0.05pF            | GRM0334C2A1R2WA01# |
|        |               |         |       | ±5%     | GRM0335C2A220JA01# |        |               |         |         | ±0.25pF            |                    | GRM0334C2A1R2BA01# |                    |
|        |               |         | 24pF  | ±2%     | GRM0335C2A240GA01# |        |               |         | ±0.1pF  | GRM0334C2A1R2CA01# | 1.3pF              | ±0.05pF            | GRM0334C2A1R3WA01# |
|        |               |         |       | ±5%     | GRM0335C2A240JA01# |        |               |         |         | ±0.1pF             |                    | GRM0334C2A1R3BA01# |                    |
|        |               |         | 27pF  | ±2%     | GRM0335C2A270GA01# |        |               |         | ±0.25pF | GRM0334C2A1R3CA01# | 1.4pF              | ±0.05pF            | GRM0334C2A1R4WA01# |
|        |               |         |       | ±5%     | GRM0335C2A270JA01# |        |               |         |         | ±0.25pF            |                    | GRM0334C2A1R4BA01# |                    |
|        |               |         | 30pF  | ±2%     | GRM0335C2A300GA01# |        |               |         | ±0.05pF | GRM0334C2A1R4CA01# | 1.5pF              | ±0.05pF            | GRM0334C2A1R5WA01# |
|        |               |         |       | ±5%     | GRM0335C2A300JA01# |        |               |         |         | ±0.1pF             |                    | GRM0334C2A1R5BA01# |                    |
|        |               |         | 33pF  | ±2%     | GRM0335C2A330GA01# |        |               |         | ±0.1pF  | GRM0334C2A1R5CA01# | 1.6pF              | ±0.05pF            | GRM0334C2A1R6WA01# |
|        |               |         |       | ±5%     | GRM0335C2A330JA01# |        |               |         |         | ±0.1pF             |                    | GRM0334C2A1R6BA01# |                    |
|        |               |         | 36pF  | ±2%     | GRM0335C2A360GA01# |        |               |         | ±0.25pF | GRM0334C2A1R6CA01# | 1.7pF              | ±0.05pF            | GRM0334C2A1R7WA01# |
|        |               |         |       | ±5%     | GRM0335C2A360JA01# |        |               |         |         | ±0.25pF            |                    | GRM0334C2A1R7BA01# |                    |
|        |               |         | 39pF  | ±2%     | GRM0335C2A390GA01# |        |               |         | ±0.05pF | GRM0334C2A1R7CA01# | 1.8pF              | ±0.05pF            | GRM0334C2A1R8WA01# |
|        |               |         |       | ±5%     | GRM0335C2A390JA01# |        |               |         |         | ±0.1pF             |                    | GRM0334C2A1R8BA01# |                    |
|        |               |         | 43pF  | ±2%     | GRM0335C2A430GA01# |        |               |         | ±0.1pF  | GRM0334C2A1R8CA01# | ±0.05pF            | ±0.05pF            | GRM0334C2A1R8WA01# |
|        |               |         |       | ±5%     | GRM0335C2A430JA01# |        |               |         |         | ±0.25pF            |                    | GRM0334C2A1R8BA01# |                    |
|        |               |         | 47pF  | ±2%     | GRM0335C2A470GA01# |        |               |         | ±0.25pF | GRM0334C2A1R8CA01# | ±0.1pF             | ±0.1pF             | GRM0334C2A1R8WA01# |
|        |               |         |       | ±5%     | GRM0335C2A470JA01# |        |               |         |         | ±0.25pF            |                    | GRM0334C2A1R8BA01# |                    |
|        |               |         | 51pF  | ±2%     | GRM0335C2A510GA01# |        |               |         | ±0.25pF | GRM0334C2A1R8CA01# | ±0.25pF            | ±0.25pF            | GRM0334C2A1R8WA01# |
|        |               |         |       | ±5%     | GRM0335C2A510JA01# |        |               |         |         | ±0.25pF            |                    | GRM0334C2A1R8BA01# |                    |
|        |               |         | 56pF  | ±2%     | GRM0335C2A560GA01# |        |               |         | ±0.25pF | GRM0334C2A1R8CA01# | ±0.25pF            | ±0.25pF            | GRM0334C2A1R8WA01# |
|        |               |         |       | ±5%     | GRM0335C2A560JA01# |        |               |         |         | ±0.25pF            |                    | GRM0334C2A1R8BA01# |                    |
|        |               |         | 62pF  | ±2%     | GRM0335C2A620GA01# |        |               |         | ±0.25pF | GRM0334C2A1R8CA01# | ±0.25pF            | ±0.25pF            | GRM0334C2A1R8WA01# |
|        |               |         |       | ±5%     | GRM0335C2A620JA01# |        |               |         |         | ±0.25pF            |                    | GRM0334C2A1R8BA01# |                    |

- GRM
- GR3
- GRJ
- GR4
- GR7
- GJM
- GQM
- GA2
- GA3 GB
- GA3 GD
- GA3 GF
- LLL
- LLA
- LLM
- LLR
- NFM
- KRM
- KR3
- GMA
- GMD
- ⚠Caution /Notice

Part number # indicates the package specification code.

# GRM Series Temperature Compensating Type Part Number List

(→ 0.6×0.3mm)

| T max. | Rated Voltage | TC Code | Cap.    | Tol.               | Part Number        | T max.  | Rated Voltage      | TC Code            | Cap.               | Tol.    | Part Number        |                    |                    |                    |
|--------|---------------|---------|---------|--------------------|--------------------|---------|--------------------|--------------------|--------------------|---------|--------------------|--------------------|--------------------|--------------------|
| 0.33mm | 100Vdc        | CK      | 1.9pF   | ±0.05pF            | GRM0334C2A1R9WA01# | 0.33mm  | 100Vdc             | CJ                 | 3.7pF              | ±0.05pF | GRM0333C2A3R7WA01# |                    |                    |                    |
|        |               |         |         | ±0.1pF             | GRM0334C2A1R9BA01# |         |                    |                    |                    | ±0.05pF | GRM0333C2A3R7BA01# |                    |                    |                    |
|        |               |         |         | ±0.25pF            | GRM0334C2A1R9CA01# |         |                    |                    |                    | ±0.1pF  | GRM0333C2A3R7CA01# |                    |                    |                    |
|        |               |         | 2.0pF   | ±0.05pF            | GRM0334C2A2R0WA01# |         |                    |                    |                    | 3.8pF   | ±0.05pF            | GRM0333C2A3R8WA01# |                    |                    |
|        |               |         |         | ±0.1pF             | GRM0334C2A2R0BA01# |         |                    |                    |                    |         | ±0.1pF             | GRM0333C2A3R8BA01# |                    |                    |
|        |               |         |         | ±0.25pF            | GRM0334C2A2R0CA01# |         |                    |                    |                    |         | ±0.25pF            | GRM0333C2A3R8CA01# |                    |                    |
|        |               |         | 2.1pF   | ±0.05pF            | GRM0333C2A2R1WA01# |         |                    |                    |                    |         | 3.9pF              | ±0.05pF            | GRM0333C2A3R9WA01# |                    |
|        |               |         |         | ±0.1pF             | GRM0333C2A2R1BA01# |         |                    |                    |                    |         |                    | ±0.1pF             | GRM0333C2A3R9BA01# |                    |
|        |               |         |         | ±0.25pF            | GRM0333C2A2R1CA01# |         |                    |                    |                    |         |                    | ±0.25pF            | GRM0333C2A3R9CA01# |                    |
|        |               |         | 2.2pF   | ±0.05pF            | GRM0333C2A2R2WA01# |         |                    |                    | 4.0pF              |         |                    | ±0.05pF            | GRM0332C2A4R0WA01# |                    |
|        |               |         |         | ±0.1pF             | GRM0333C2A2R2BA01# |         |                    |                    |                    |         |                    | ±0.1pF             | GRM0332C2A4R0BA01# |                    |
|        |               |         |         | ±0.25pF            | GRM0333C2A2R2CA01# |         |                    |                    |                    |         |                    | ±0.25pF            | GRM0332C2A4R0CA01# |                    |
|        |               |         | 2.3pF   | ±0.05pF            | GRM0333C2A2R3WA01# |         |                    |                    |                    | 4.1pF   |                    | ±0.05pF            | GRM0332C2A4R1WA01# |                    |
|        |               |         |         | ±0.1pF             | GRM0333C2A2R3BA01# |         |                    |                    |                    |         |                    | ±0.1pF             | GRM0332C2A4R1BA01# |                    |
|        |               |         |         | ±0.25pF            | GRM0333C2A2R3CA01# |         |                    |                    |                    |         |                    | ±0.25pF            | GRM0332C2A4R1CA01# |                    |
|        |               |         | 2.4pF   | ±0.05pF            | GRM0333C2A2R4WA01# |         |                    |                    |                    |         | 4.2pF              | ±0.05pF            | GRM0332C2A4R2WA01# |                    |
|        |               |         |         | ±0.1pF             | GRM0333C2A2R4BA01# |         |                    |                    |                    |         |                    | ±0.1pF             | GRM0332C2A4R2BA01# |                    |
|        |               |         |         | ±0.25pF            | GRM0333C2A2R4CA01# |         |                    |                    |                    |         |                    | ±0.25pF            | GRM0332C2A4R2CA01# |                    |
|        |               |         | 2.5pF   | ±0.05pF            | GRM0333C2A2R5WA01# |         |                    |                    | 4.3pF              |         |                    | ±0.05pF            | GRM0332C2A4R3WA01# |                    |
|        |               |         |         | ±0.1pF             | GRM0333C2A2R5BA01# |         |                    |                    |                    |         |                    | ±0.1pF             | GRM0332C2A4R3BA01# |                    |
|        |               |         |         | ±0.25pF            | GRM0333C2A2R5CA01# |         |                    |                    |                    |         |                    | ±0.25pF            | GRM0332C2A4R3CA01# |                    |
|        |               |         | 2.6pF   | ±0.05pF            | GRM0333C2A2R6WA01# |         |                    |                    |                    | 4.4pF   |                    | ±0.05pF            | GRM0332C2A4R4WA01# |                    |
|        |               |         |         | ±0.1pF             | GRM0333C2A2R6BA01# |         |                    |                    |                    |         |                    | ±0.1pF             | GRM0332C2A4R4BA01# |                    |
|        |               |         |         | ±0.25pF            | GRM0333C2A2R6CA01# |         |                    |                    |                    |         |                    | ±0.25pF            | GRM0332C2A4R4CA01# |                    |
|        |               |         | 2.7pF   | ±0.05pF            | GRM0333C2A2R7WA01# |         |                    |                    |                    |         | 4.5pF              | ±0.05pF            | GRM0332C2A4R5WA01# |                    |
|        |               |         |         | ±0.1pF             | GRM0333C2A2R7BA01# |         |                    |                    |                    |         |                    | ±0.1pF             | GRM0332C2A4R5BA01# |                    |
|        |               |         |         | ±0.25pF            | GRM0333C2A2R7CA01# |         |                    |                    |                    |         |                    | ±0.25pF            | GRM0332C2A4R5CA01# |                    |
|        |               |         | 2.8pF   | ±0.05pF            | GRM0333C2A2R8WA01# |         |                    |                    | 4.6pF              |         |                    | ±0.05pF            | GRM0332C2A4R6WA01# |                    |
|        |               |         |         | ±0.1pF             | GRM0333C2A2R8BA01# |         |                    |                    |                    |         |                    | ±0.1pF             | GRM0332C2A4R6BA01# |                    |
|        |               |         |         | ±0.25pF            | GRM0333C2A2R8CA01# |         |                    |                    |                    |         |                    | ±0.25pF            | GRM0332C2A4R6CA01# |                    |
|        |               |         | 2.9pF   | ±0.05pF            | GRM0333C2A2R9WA01# |         |                    |                    |                    | 4.7pF   |                    | ±0.05pF            | GRM0332C2A4R7WA01# |                    |
|        |               |         |         | ±0.1pF             | GRM0333C2A2R9BA01# |         |                    |                    |                    |         |                    | ±0.1pF             | GRM0332C2A4R7BA01# |                    |
|        |               |         |         | ±0.25pF            | GRM0333C2A2R9CA01# |         |                    |                    |                    |         |                    | ±0.25pF            | GRM0332C2A4R7CA01# |                    |
|        |               |         | 3.0pF   | ±0.05pF            | GRM0333C2A3R0WA01# |         |                    |                    |                    |         | 4.8pF              | ±0.05pF            | GRM0332C2A4R8WA01# |                    |
|        |               |         |         | ±0.1pF             | GRM0333C2A3R0BA01# |         |                    |                    |                    |         |                    | ±0.1pF             | GRM0332C2A4R8BA01# |                    |
|        |               |         |         | ±0.25pF            | GRM0333C2A3R0CA01# |         |                    |                    |                    |         |                    | ±0.25pF            | GRM0332C2A4R8CA01# |                    |
|        |               | 3.1pF   | ±0.05pF | GRM0333C2A3R1WA01# | 4.9pF              | ±0.05pF | GRM0332C2A4R9WA01# |                    |                    |         |                    |                    |                    |                    |
|        |               |         | ±0.1pF  | GRM0333C2A3R1BA01# |                    | ±0.1pF  | GRM0332C2A4R9BA01# |                    |                    |         |                    |                    |                    |                    |
|        |               |         | ±0.25pF | GRM0333C2A3R1CA01# |                    | ±0.25pF | GRM0332C2A4R9CA01# |                    |                    |         |                    |                    |                    |                    |
|        |               | 3.2pF   | ±0.05pF | GRM0333C2A3R2WA01# |                    | 5.0pF   | ±0.05pF            | GRM0332C2A5R0WA01# |                    |         |                    |                    |                    |                    |
|        |               |         | ±0.1pF  | GRM0333C2A3R2BA01# |                    |         | ±0.1pF             | GRM0332C2A5R0BA01# |                    |         |                    |                    |                    |                    |
|        |               |         | ±0.25pF | GRM0333C2A3R2CA01# |                    |         | ±0.25pF            | GRM0332C2A5R0CA01# |                    |         |                    |                    |                    |                    |
|        |               | 3.3pF   | ±0.05pF | GRM0333C2A3R3WA01# |                    |         | 5.1pF              | ±0.05pF            | GRM0332C2A5R1WA01# |         |                    |                    |                    |                    |
|        |               |         | ±0.1pF  | GRM0333C2A3R3BA01# |                    |         |                    | ±0.1pF             | GRM0332C2A5R1BA01# |         |                    |                    |                    |                    |
|        |               |         | ±0.25pF | GRM0333C2A3R3CA01# |                    |         |                    | ±0.25pF            | GRM0332C2A5R1CA01# |         |                    |                    |                    |                    |
|        |               | 3.4pF   | ±0.05pF | GRM0333C2A3R4WA01# | 5.2pF              |         |                    | ±0.05pF            | GRM0332C2A5R2WA01# |         |                    |                    |                    |                    |
|        |               |         | ±0.1pF  | GRM0333C2A3R4BA01# |                    |         |                    | ±0.1pF             | GRM0332C2A5R2BA01# |         |                    |                    |                    |                    |
|        |               |         | ±0.25pF | GRM0333C2A3R4CA01# |                    |         |                    | ±0.25pF            | GRM0332C2A5R2CA01# |         |                    |                    |                    |                    |
|        |               | 3.5pF   | ±0.05pF | GRM0333C2A3R5WA01# |                    | 5.3pF   |                    | ±0.05pF            | GRM0332C2A5R3WA01# |         |                    |                    |                    |                    |
|        |               |         | ±0.1pF  | GRM0333C2A3R5BA01# |                    |         |                    | ±0.1pF             | GRM0332C2A5R3BA01# |         |                    |                    |                    |                    |
|        |               |         | ±0.25pF | GRM0333C2A3R5CA01# |                    |         |                    | ±0.25pF            | GRM0332C2A5R3CA01# |         |                    |                    |                    |                    |
|        |               | 3.6pF   | ±0.05pF | GRM0333C2A3R6WA01# |                    |         | 5.3pF              | ±0.05pF            | GRM0332C2A5R3WA01# |         |                    |                    |                    |                    |
|        |               |         | ±0.1pF  | GRM0333C2A3R6BA01# |                    |         |                    | ±0.1pF             | GRM0332C2A5R3BA01# |         |                    |                    |                    |                    |
|        |               |         | ±0.25pF | GRM0333C2A3R6CA01# |                    |         |                    | ±0.25pF            | GRM0332C2A5R3CA01# |         |                    |                    |                    |                    |
|        |               |         |         |                    |                    |         |                    |                    |                    |         |                    |                    | ±0.5pF             | GRM0332C2A5R3DA01# |

Part number # indicates the package specification code.



# GRM Series Temperature Compensating Type Part Number List

(→ 0.6×0.3mm)

| T max. | Rated Voltage | TC Code | Cap.  | Tol.    | Part Number        |
|--------|---------------|---------|-------|---------|--------------------|
| 0.33mm | 100Vdc        | CH      | 5.4pF | ±0.05pF | GRM0332C2A5R4WA01# |
|        |               |         |       | ±0.1pF  | GRM0332C2A5R4BA01# |
|        |               |         |       | ±0.25pF | GRM0332C2A5R4CA01# |
|        |               |         |       | ±0.5pF  | GRM0332C2A5R4DA01# |
|        |               |         | 5.5pF | ±0.05pF | GRM0332C2A5R5WA01# |
|        |               |         |       | ±0.1pF  | GRM0332C2A5R5BA01# |
|        |               |         |       | ±0.25pF | GRM0332C2A5R5CA01# |
|        |               |         |       | ±0.5pF  | GRM0332C2A5R5DA01# |
|        |               |         | 5.6pF | ±0.05pF | GRM0332C2A5R6WA01# |
|        |               |         |       | ±0.1pF  | GRM0332C2A5R6BA01# |
|        |               |         |       | ±0.25pF | GRM0332C2A5R6CA01# |
|        |               |         |       | ±0.5pF  | GRM0332C2A5R6DA01# |
|        |               |         | 5.7pF | ±0.05pF | GRM0332C2A5R7WA01# |
|        |               |         |       | ±0.1pF  | GRM0332C2A5R7BA01# |
|        |               |         |       | ±0.25pF | GRM0332C2A5R7CA01# |
|        |               |         |       | ±0.5pF  | GRM0332C2A5R7DA01# |
|        |               |         | 5.8pF | ±0.05pF | GRM0332C2A5R8WA01# |
|        |               |         |       | ±0.1pF  | GRM0332C2A5R8BA01# |
|        |               |         |       | ±0.25pF | GRM0332C2A5R8CA01# |
|        |               |         |       | ±0.5pF  | GRM0332C2A5R8DA01# |
|        |               |         | 5.9pF | ±0.05pF | GRM0332C2A5R9WA01# |
|        |               |         |       | ±0.1pF  | GRM0332C2A5R9BA01# |
|        |               |         |       | ±0.25pF | GRM0332C2A5R9CA01# |
|        |               |         |       | ±0.5pF  | GRM0332C2A5R9DA01# |
|        |               |         | 6.0pF | ±0.05pF | GRM0332C2A6R0WA01# |
|        |               |         |       | ±0.1pF  | GRM0332C2A6R0BA01# |
|        |               |         |       | ±0.25pF | GRM0332C2A6R0CA01# |
|        |               |         |       | ±0.5pF  | GRM0332C2A6R0DA01# |
|        |               |         | 6.1pF | ±0.05pF | GRM0332C2A6R1WA01# |
|        |               |         |       | ±0.1pF  | GRM0332C2A6R1BA01# |
|        |               |         |       | ±0.25pF | GRM0332C2A6R1CA01# |
|        |               |         |       | ±0.5pF  | GRM0332C2A6R1DA01# |
|        |               |         | 6.2pF | ±0.05pF | GRM0332C2A6R2WA01# |
|        |               |         |       | ±0.1pF  | GRM0332C2A6R2BA01# |
|        |               |         |       | ±0.25pF | GRM0332C2A6R2CA01# |
|        |               |         |       | ±0.5pF  | GRM0332C2A6R2DA01# |
|        |               |         | 6.3pF | ±0.05pF | GRM0332C2A6R3WA01# |
|        |               |         |       | ±0.1pF  | GRM0332C2A6R3BA01# |
|        |               |         |       | ±0.25pF | GRM0332C2A6R3CA01# |
|        |               |         |       | ±0.5pF  | GRM0332C2A6R3DA01# |
|        |               |         | 6.4pF | ±0.05pF | GRM0332C2A6R4WA01# |
|        |               |         |       | ±0.1pF  | GRM0332C2A6R4BA01# |
|        |               |         |       | ±0.25pF | GRM0332C2A6R4CA01# |
|        |               |         |       | ±0.5pF  | GRM0332C2A6R4DA01# |
|        |               |         | 6.5pF | ±0.05pF | GRM0332C2A6R5WA01# |
|        |               |         |       | ±0.1pF  | GRM0332C2A6R5BA01# |
|        |               |         |       | ±0.25pF | GRM0332C2A6R5CA01# |
|        |               |         |       | ±0.5pF  | GRM0332C2A6R5DA01# |
|        |               |         | 6.6pF | ±0.05pF | GRM0332C2A6R6WA01# |
|        |               |         |       | ±0.1pF  | GRM0332C2A6R6BA01# |
|        |               |         |       | ±0.25pF | GRM0332C2A6R6CA01# |
|        |               |         |       | ±0.5pF  | GRM0332C2A6R6DA01# |
|        |               |         | 6.7pF | ±0.05pF | GRM0332C2A6R7WA01# |
|        |               |         |       | ±0.1pF  | GRM0332C2A6R7BA01# |

| T max. | Rated Voltage | TC Code | Cap.  | Tol.    | Part Number        |
|--------|---------------|---------|-------|---------|--------------------|
| 0.33mm | 100Vdc        | CH      | 6.7pF | ±0.25pF | GRM0332C2A6R7CA01# |
|        |               |         |       | ±0.5pF  | GRM0332C2A6R7DA01# |
|        |               |         | 6.8pF | ±0.05pF | GRM0332C2A6R8WA01# |
|        |               |         |       | ±0.1pF  | GRM0332C2A6R8BA01# |
|        |               |         |       | ±0.25pF | GRM0332C2A6R8CA01# |
|        |               |         | 6.9pF | ±0.05pF | GRM0332C2A6R9WA01# |
|        |               |         |       | ±0.1pF  | GRM0332C2A6R9BA01# |
|        |               |         |       | ±0.25pF | GRM0332C2A6R9CA01# |
|        |               |         | 7.0pF | ±0.05pF | GRM0332C2A7R0WA01# |
|        |               |         |       | ±0.1pF  | GRM0332C2A7R0BA01# |
|        |               |         |       | ±0.25pF | GRM0332C2A7R0CA01# |
|        |               |         | 7.1pF | ±0.05pF | GRM0332C2A7R1WA01# |
|        |               |         |       | ±0.1pF  | GRM0332C2A7R1BA01# |
|        |               |         |       | ±0.25pF | GRM0332C2A7R1CA01# |
|        |               |         | 7.2pF | ±0.05pF | GRM0332C2A7R2WA01# |
|        |               |         |       | ±0.1pF  | GRM0332C2A7R2BA01# |
|        |               |         |       | ±0.25pF | GRM0332C2A7R2CA01# |
|        |               |         | 7.3pF | ±0.05pF | GRM0332C2A7R3WA01# |
|        |               |         |       | ±0.1pF  | GRM0332C2A7R3BA01# |
|        |               |         |       | ±0.25pF | GRM0332C2A7R3CA01# |
|        |               |         | 7.4pF | ±0.05pF | GRM0332C2A7R4WA01# |
|        |               |         |       | ±0.1pF  | GRM0332C2A7R4BA01# |
|        |               |         |       | ±0.25pF | GRM0332C2A7R4CA01# |
|        |               |         | 7.5pF | ±0.05pF | GRM0332C2A7R5WA01# |
|        |               |         |       | ±0.1pF  | GRM0332C2A7R5BA01# |
|        |               |         |       | ±0.25pF | GRM0332C2A7R5CA01# |
|        |               |         | 7.6pF | ±0.05pF | GRM0332C2A7R6WA01# |
|        |               |         |       | ±0.1pF  | GRM0332C2A7R6BA01# |
|        |               |         |       | ±0.25pF | GRM0332C2A7R6CA01# |
|        |               |         | 7.7pF | ±0.05pF | GRM0332C2A7R7WA01# |
|        |               |         |       | ±0.1pF  | GRM0332C2A7R7BA01# |
|        |               |         |       | ±0.25pF | GRM0332C2A7R7CA01# |
|        |               |         | 7.8pF | ±0.05pF | GRM0332C2A7R8WA01# |
|        |               |         |       | ±0.1pF  | GRM0332C2A7R8BA01# |
|        |               |         |       | ±0.25pF | GRM0332C2A7R8CA01# |
|        |               |         | 7.9pF | ±0.05pF | GRM0332C2A7R9WA01# |
|        |               |         |       | ±0.1pF  | GRM0332C2A7R9BA01# |
|        |               |         |       | ±0.25pF | GRM0332C2A7R9CA01# |
|        |               |         | 8.0pF | ±0.05pF | GRM0332C2A8R0WA01# |
|        |               |         |       | ±0.1pF  | GRM0332C2A8R0BA01# |
|        |               |         |       | ±0.25pF | GRM0332C2A8R0CA01# |

- GRM
- GR3
- GRJ
- GR4
- GR7
- GJM
- GQM
- GA2
- GA3 GB
- GA3 GD
- GA3 GF
- LLL
- LLA
- LLM
- LLR
- NFM
- KRM
- KR3
- GMA
- GMD
- ⚠Caution /Notice

Part number # indicates the package specification code.

# GRM Series Temperature Compensating Type Part Number List

(→ 0.6×0.3mm)

| T max. | Rated Voltage | TC Code | Cap.  | Tol.    | Part Number        |
|--------|---------------|---------|-------|---------|--------------------|
| 0.33mm | 100Vdc        | CH      | 8.1pF | ±0.05pF | GRM0332C2A8R1WA01# |
|        |               |         |       | ±0.1pF  | GRM0332C2A8R1BA01# |
|        |               |         |       | ±0.25pF | GRM0332C2A8R1CA01# |
|        |               |         |       | ±0.5pF  | GRM0332C2A8R1DA01# |
|        |               |         | 8.2pF | ±0.05pF | GRM0332C2A8R2WA01# |
|        |               |         |       | ±0.1pF  | GRM0332C2A8R2BA01# |
|        |               |         |       | ±0.25pF | GRM0332C2A8R2CA01# |
|        |               |         |       | ±0.5pF  | GRM0332C2A8R2DA01# |
|        |               |         | 8.3pF | ±0.05pF | GRM0332C2A8R3WA01# |
|        |               |         |       | ±0.1pF  | GRM0332C2A8R3BA01# |
|        |               |         |       | ±0.25pF | GRM0332C2A8R3CA01# |
|        |               |         |       | ±0.5pF  | GRM0332C2A8R3DA01# |
|        |               |         | 8.4pF | ±0.05pF | GRM0332C2A8R4WA01# |
|        |               |         |       | ±0.1pF  | GRM0332C2A8R4BA01# |
|        |               |         |       | ±0.25pF | GRM0332C2A8R4CA01# |
|        |               |         |       | ±0.5pF  | GRM0332C2A8R4DA01# |
|        |               |         | 8.5pF | ±0.05pF | GRM0332C2A8R5WA01# |
|        |               |         |       | ±0.1pF  | GRM0332C2A8R5BA01# |
|        |               |         |       | ±0.25pF | GRM0332C2A8R5CA01# |
|        |               |         |       | ±0.5pF  | GRM0332C2A8R5DA01# |
|        |               |         | 8.6pF | ±0.05pF | GRM0332C2A8R6WA01# |
|        |               |         |       | ±0.1pF  | GRM0332C2A8R6BA01# |
|        |               |         |       | ±0.25pF | GRM0332C2A8R6CA01# |
|        |               |         |       | ±0.5pF  | GRM0332C2A8R6DA01# |
|        |               |         | 8.7pF | ±0.05pF | GRM0332C2A8R7WA01# |
|        |               |         |       | ±0.1pF  | GRM0332C2A8R7BA01# |
|        |               |         |       | ±0.25pF | GRM0332C2A8R7CA01# |
|        |               |         |       | ±0.5pF  | GRM0332C2A8R7DA01# |
|        |               |         | 8.8pF | ±0.05pF | GRM0332C2A8R8WA01# |
|        |               |         |       | ±0.1pF  | GRM0332C2A8R8BA01# |
|        |               |         |       | ±0.25pF | GRM0332C2A8R8CA01# |
|        |               |         |       | ±0.5pF  | GRM0332C2A8R8DA01# |
|        |               |         | 8.9pF | ±0.05pF | GRM0332C2A8R9WA01# |
|        |               |         |       | ±0.1pF  | GRM0332C2A8R9BA01# |
|        |               |         |       | ±0.25pF | GRM0332C2A8R9CA01# |
|        |               |         |       | ±0.5pF  | GRM0332C2A8R9DA01# |
|        |               |         | 9.0pF | ±0.05pF | GRM0332C2A9R0WA01# |
|        |               |         |       | ±0.1pF  | GRM0332C2A9R0BA01# |
|        |               |         |       | ±0.25pF | GRM0332C2A9R0CA01# |
|        |               |         |       | ±0.5pF  | GRM0332C2A9R0DA01# |
|        |               |         | 9.1pF | ±0.05pF | GRM0332C2A9R1WA01# |
|        |               |         |       | ±0.1pF  | GRM0332C2A9R1BA01# |
|        |               |         |       | ±0.25pF | GRM0332C2A9R1CA01# |
|        |               |         |       | ±0.5pF  | GRM0332C2A9R1DA01# |
|        |               |         | 9.2pF | ±0.05pF | GRM0332C2A9R2WA01# |
|        |               |         |       | ±0.1pF  | GRM0332C2A9R2BA01# |
|        |               |         |       | ±0.25pF | GRM0332C2A9R2CA01# |
|        |               |         |       | ±0.5pF  | GRM0332C2A9R2DA01# |
|        |               |         | 9.3pF | ±0.05pF | GRM0332C2A9R3WA01# |
|        |               |         |       | ±0.1pF  | GRM0332C2A9R3BA01# |
|        |               |         |       | ±0.25pF | GRM0332C2A9R3CA01# |
|        |               |         |       | ±0.5pF  | GRM0332C2A9R3DA01# |
|        |               |         | 9.4pF | ±0.05pF | GRM0332C2A9R4WA01# |
|        |               |         |       | ±0.1pF  | GRM0332C2A9R4BA01# |

| T max. | Rated Voltage | TC Code | Cap.  | Tol.    | Part Number        |
|--------|---------------|---------|-------|---------|--------------------|
| 0.33mm | 100Vdc        | CH      | 9.4pF | ±0.25pF | GRM0332C2A9R4CA01# |
|        |               |         |       | ±0.5pF  | GRM0332C2A9R4DA01# |
|        |               |         | 9.5pF | ±0.05pF | GRM0332C2A9R5WA01# |
|        |               |         |       | ±0.1pF  | GRM0332C2A9R5BA01# |
|        |               |         |       | ±0.25pF | GRM0332C2A9R5CA01# |
|        |               |         | 9.6pF | ±0.05pF | GRM0332C2A9R6WA01# |
|        |               |         |       | ±0.1pF  | GRM0332C2A9R6BA01# |
|        |               |         |       | ±0.25pF | GRM0332C2A9R6CA01# |
|        |               |         | 9.7pF | ±0.05pF | GRM0332C2A9R7WA01# |
|        |               |         |       | ±0.1pF  | GRM0332C2A9R7BA01# |
|        |               |         |       | ±0.25pF | GRM0332C2A9R7CA01# |
|        |               |         | 9.8pF | ±0.05pF | GRM0332C2A9R8WA01# |
|        |               |         |       | ±0.1pF  | GRM0332C2A9R8BA01# |
|        |               |         |       | ±0.25pF | GRM0332C2A9R8CA01# |
|        |               |         | 9.9pF | ±0.05pF | GRM0332C2A9R9WA01# |
|        |               |         |       | ±0.1pF  | GRM0332C2A9R9BA01# |
|        |               |         |       | ±0.25pF | GRM0332C2A9R9CA01# |
|        |               |         | 10pF  | ±2%     | GRM0332C2A100GA01# |
|        |               |         |       | ±5%     | GRM0332C2A100JA01# |
|        |               |         | 12pF  | ±2%     | GRM0332C2A120GA01# |
|        |               |         |       | ±5%     | GRM0332C2A120JA01# |
|        |               |         | 15pF  | ±2%     | GRM0332C2A150GA01# |
|        |               |         |       | ±5%     | GRM0332C2A150JA01# |
|        |               |         | 18pF  | ±2%     | GRM0332C2A180GA01# |
|        |               |         |       | ±5%     | GRM0332C2A180JA01# |
|        |               |         | 20pF  | ±2%     | GRM0332C2A200GA01# |
|        |               |         |       | ±5%     | GRM0332C2A200JA01# |
|        |               |         | 22pF  | ±2%     | GRM0332C2A220GA01# |
|        |               |         |       | ±5%     | GRM0332C2A220JA01# |
|        |               |         | 24pF  | ±2%     | GRM0332C2A240GA01# |
|        |               |         |       | ±5%     | GRM0332C2A240JA01# |
|        |               |         | 27pF  | ±2%     | GRM0332C2A270GA01# |
|        |               |         |       | ±5%     | GRM0332C2A270JA01# |
|        |               |         | 30pF  | ±2%     | GRM0332C2A300GA01# |
|        |               |         |       | ±5%     | GRM0332C2A300JA01# |
|        |               |         | 33pF  | ±2%     | GRM0332C2A330GA01# |
|        |               |         |       | ±5%     | GRM0332C2A330JA01# |
|        |               |         | 36pF  | ±2%     | GRM0332C2A360GA01# |
|        |               |         |       | ±5%     | GRM0332C2A360JA01# |
|        |               |         | 39pF  | ±2%     | GRM0332C2A390GA01# |
|        |               |         |       | ±5%     | GRM0332C2A390JA01# |
|        |               |         | 43pF  | ±2%     | GRM0332C2A430GA01# |
|        |               |         |       | ±5%     | GRM0332C2A430JA01# |
|        |               |         | 47pF  | ±2%     | GRM0332C2A470GA01# |
|        |               |         |       | ±5%     | GRM0332C2A470JA01# |
|        |               |         | 51pF  | ±2%     | GRM0332C2A510GA01# |
|        |               |         |       | ±5%     | GRM0332C2A510JA01# |
|        |               |         | 56pF  | ±2%     | GRM0332C2A560GA01# |
|        |               |         |       | ±5%     | GRM0332C2A560JA01# |

Part number # indicates the package specification code.



# GRM Series Temperature Compensating Type Part Number List

(→ 0.6×0.3mm)

| T max. | Rated Voltage | TC Code            | Cap.    | Tol.               | Part Number        | T max.  | Rated Voltage      | TC Code            | Cap.  | Tol.    | Part Number        |
|--------|---------------|--------------------|---------|--------------------|--------------------|---------|--------------------|--------------------|-------|---------|--------------------|
| 0.33mm | 100Vdc        | CH                 | 62pF    | ±2%                | GRM0332C2A620GA01# | 0.33mm  | 50Vdc              | COG                | 1.8pF | ±0.1pF  | GRM0335C1H1R8BA01# |
|        |               |                    |         | ±5%                | GRM0332C2A620JA01# |         |                    |                    |       | ±0.25pF | GRM0335C1H1R8CA01# |
|        |               |                    | 68pF    | ±2%                | GRM0332C2A680GA01# |         |                    |                    | 1.9pF | ±0.05pF | GRM0335C1H1R9WA01# |
|        |               |                    |         | ±5%                | GRM0332C2A680JA01# |         |                    |                    |       | ±0.1pF  | GRM0335C1H1R9BA01# |
|        |               |                    | 75pF    | ±2%                | GRM0332C2A750GA01# |         |                    |                    | 2.0pF | ±0.25pF | GRM0335C1H1R9CA01# |
|        |               |                    |         | ±5%                | GRM0332C2A750JA01# |         |                    |                    |       | ±0.05pF | GRM0335C1H2R0WA01# |
|        |               |                    | 82pF    | ±2%                | GRM0332C2A820GA01# |         |                    |                    | 2.1pF | ±0.1pF  | GRM0335C1H2R0BA01# |
|        |               |                    |         | ±5%                | GRM0332C2A820JA01# |         |                    |                    |       | ±0.25pF | GRM0335C1H2R0CA01# |
|        |               |                    | 91pF    | ±2%                | GRM0332C2A910GA01# |         |                    |                    | 2.1pF | ±0.05pF | GRM0335C1H2R1WA01# |
|        |               |                    |         | ±5%                | GRM0332C2A910JA01# |         |                    |                    |       | ±0.1pF  | GRM0335C1H2R1BA01# |
|        |               |                    | 100pF   | ±2%                | GRM0332C2A101GA01# |         |                    |                    | 2.1pF | ±0.25pF | GRM0335C1H2R1CA01# |
|        |               |                    |         | ±5%                | GRM0332C2A101JA01# |         |                    |                    |       | ±0.05pF | GRM0335C1H2R2WA01# |
|        | 50Vdc         | COG                | 0.10pF  | ±0.05pF            | GRM0335C1HR10WA01# |         |                    |                    | 2.2pF | ±0.1pF  | GRM0335C1H2R2BA01# |
|        |               |                    |         | ±0.1pF             | GRM0335C1HR10BA01# |         |                    |                    |       | ±0.25pF | GRM0335C1H2R2CA01# |
|        |               |                    | 0.20pF  | ±0.05pF            | GRM0335C1HR20WA01# |         |                    |                    | 2.3pF | ±0.05pF | GRM0335C1H2R3WA01# |
|        |               |                    |         | ±0.1pF             | GRM0335C1HR20BA01# |         |                    |                    |       | ±0.1pF  | GRM0335C1H2R3BA01# |
|        |               |                    | 0.30pF  | ±0.05pF            | GRM0335C1HR30WA01# |         |                    |                    | 2.3pF | ±0.25pF | GRM0335C1H2R3CA01# |
|        |               |                    |         | ±0.1pF             | GRM0335C1HR30BA01# |         |                    |                    |       | ±0.05pF | GRM0335C1H2R4WA01# |
|        |               |                    | 0.40pF  | ±0.05pF            | GRM0335C1HR40WA01# |         |                    |                    | 2.4pF | ±0.1pF  | GRM0335C1H2R4BA01# |
|        |               |                    |         | ±0.1pF             | GRM0335C1HR40BA01# |         |                    |                    |       | ±0.25pF | GRM0335C1H2R4CA01# |
|        |               |                    | 0.50pF  | ±0.05pF            | GRM0335C1HR50WA01# |         |                    |                    | 2.4pF | ±0.1pF  | GRM0335C1H2R4BA01# |
|        |               |                    |         | ±0.1pF             | GRM0335C1HR50BA01# |         |                    |                    |       | ±0.25pF | GRM0335C1H2R4CA01# |
|        |               |                    | 0.60pF  | ±0.05pF            | GRM0335C1HR60WA01# |         |                    |                    | 2.5pF | ±0.05pF | GRM0335C1H2R5WA01# |
|        |               |                    |         | ±0.1pF             | GRM0335C1HR60BA01# |         |                    |                    |       | ±0.1pF  | GRM0335C1H2R5BA01# |
| 0.70pF |               |                    | ±0.05pF | GRM0335C1HR70WA01# | 2.5pF              | ±0.25pF | GRM0335C1H2R5CA01# |                    |       |         |                    |
|        |               |                    | ±0.1pF  | GRM0335C1HR70BA01# |                    | ±0.05pF | GRM0335C1H2R6WA01# |                    |       |         |                    |
| 0.80pF |               |                    | ±0.05pF | GRM0335C1HR80WA01# | 2.6pF              | ±0.1pF  | GRM0335C1H2R6BA01# |                    |       |         |                    |
|        |               |                    | ±0.1pF  | GRM0335C1HR80BA01# |                    | ±0.25pF | GRM0335C1H2R6CA01# |                    |       |         |                    |
| 0.90pF |               |                    | ±0.05pF | GRM0335C1HR90WA01# | 2.6pF              | ±0.1pF  | GRM0335C1H2R6BA01# |                    |       |         |                    |
|        |               |                    | ±0.1pF  | GRM0335C1HR90BA01# |                    | ±0.25pF | GRM0335C1H2R7WA01# |                    |       |         |                    |
| 1.0pF  |               |                    | ±0.05pF | GRM0335C1H1R0WA01# | 2.7pF              | ±0.05pF | GRM0335C1H2R7WA01# |                    |       |         |                    |
|        |               |                    | ±0.1pF  | GRM0335C1H1R0BA01# |                    | ±0.1pF  | GRM0335C1H2R7BA01# |                    |       |         |                    |
|        |               |                    | ±0.25pF | GRM0335C1H1R0CA01# |                    | ±0.25pF | GRM0335C1H2R7CA01# |                    |       |         |                    |
| 1.1pF  |               |                    | ±0.05pF | GRM0335C1H1R1WA01# | 2.8pF              | ±0.05pF | GRM0335C1H2R8WA01# |                    |       |         |                    |
|        |               |                    | ±0.1pF  | GRM0335C1H1R1BA01# |                    | ±0.1pF  | GRM0335C1H2R8BA01# |                    |       |         |                    |
|        |               |                    | ±0.25pF | GRM0335C1H1R1CA01# |                    | ±0.25pF | GRM0335C1H2R8CA01# |                    |       |         |                    |
| 1.2pF  | ±0.05pF       | GRM0335C1H1R2WA01# | 2.8pF   | ±0.1pF             | GRM0335C1H2R8BA01# |         |                    |                    |       |         |                    |
|        | ±0.1pF        | GRM0335C1H1R2BA01# |         | ±0.25pF            | GRM0335C1H2R9WA01# |         |                    |                    |       |         |                    |
|        | ±0.25pF       | GRM0335C1H1R2CA01# |         | ±0.1pF             | GRM0335C1H2R9BA01# |         |                    |                    |       |         |                    |
| 1.3pF  | ±0.05pF       | GRM0335C1H1R3WA01# | 2.9pF   | ±0.25pF            | GRM0335C1H2R9CA01# |         |                    |                    |       |         |                    |
|        | ±0.1pF        | GRM0335C1H1R3BA01# |         | ±0.05pF            | GRM0335C1H3R0WA01# |         |                    |                    |       |         |                    |
|        | ±0.25pF       | GRM0335C1H1R3CA01# |         | ±0.1pF             | GRM0335C1H3R0BA01# |         |                    |                    |       |         |                    |
| 1.4pF  | ±0.05pF       | GRM0335C1H1R4WA01# | 3.0pF   | ±0.25pF            | GRM0335C1H3R0CA01# |         |                    |                    |       |         |                    |
|        | ±0.1pF        | GRM0335C1H1R4BA01# |         | ±0.05pF            | GRM0335C1H3R1WA01# |         |                    |                    |       |         |                    |
|        | ±0.25pF       | GRM0335C1H1R4CA01# |         | ±0.1pF             | GRM0335C1H3R1BA01# |         |                    |                    |       |         |                    |
| 1.5pF  | ±0.05pF       | GRM0335C1H1R5WA01# | 3.1pF   | ±0.25pF            | GRM0335C1H3R1CA01# |         |                    |                    |       |         |                    |
|        | ±0.1pF        | GRM0335C1H1R5BA01# |         | ±0.05pF            | GRM0335C1H3R2WA01# |         |                    |                    |       |         |                    |
|        | ±0.25pF       | GRM0335C1H1R5CA01# |         | ±0.1pF             | GRM0335C1H3R2BA01# |         |                    |                    |       |         |                    |
| 1.6pF  | ±0.05pF       | GRM0335C1H1R6WA01# | 3.2pF   | ±0.25pF            | GRM0335C1H3R2CA01# |         |                    |                    |       |         |                    |
|        | ±0.1pF        | GRM0335C1H1R6BA01# |         | ±0.05pF            | GRM0335C1H3R3WA01# |         |                    |                    |       |         |                    |
|        | ±0.25pF       | GRM0335C1H1R6CA01# |         | ±0.1pF             | GRM0335C1H3R3BA01# |         |                    |                    |       |         |                    |
| 1.7pF  | ±0.05pF       | GRM0335C1H1R7WA01# | 3.3pF   | ±0.25pF            | GRM0335C1H3R3CA01# |         |                    |                    |       |         |                    |
|        | ±0.1pF        | GRM0335C1H1R7BA01# |         | ±0.05pF            | GRM0335C1H3R4WA01# |         |                    |                    |       |         |                    |
|        | ±0.25pF       | GRM0335C1H1R7CA01# |         | ±0.1pF             | GRM0335C1H3R4BA01# |         |                    |                    |       |         |                    |
| 1.8pF  | ±0.05pF       | GRM0335C1H1R8WA01# | 3.4pF   | ±0.25pF            | GRM0335C1H3R4CA01# |         |                    |                    |       |         |                    |
|        | ±0.1pF        | GRM0335C1H1R8BA01# |         | ±0.05pF            | GRM0335C1H3R5WA01# |         |                    |                    |       |         |                    |
|        | ±0.25pF       | GRM0335C1H1R8CA01# |         | ±0.1pF             | GRM0335C1H3R5BA01# |         |                    |                    |       |         |                    |
|        |               |                    |         |                    |                    | ±0.25pF | GRM0335C1H3R5CA01# |                    |       |         |                    |
|        |               |                    |         |                    |                    | 3.6pF   | ±0.05pF            | GRM0335C1H3R6WA01# |       |         |                    |

- GRM
- GR3
- GRJ
- GR4
- GR7
- GJM
- GQM
- GA2
- GA3 GB
- GA3 GD
- GA3 GF
- LLL
- LLA
- LLM
- LLR
- NFM
- KRM
- KR3
- GMA
- GMD
- ⚠Caution /Notice

Part number # indicates the package specification code.

# GRM Series Temperature Compensating Type Part Number List

(→ 0.6×0.3mm)

| T max. | Rated Voltage | TC Code | Cap.  | Tol.    | Part Number        |
|--------|---------------|---------|-------|---------|--------------------|
| 0.33mm | 50Vdc         | COG     | 3.6pF | ±0.1pF  | GRM0335C1H3R6BA01# |
|        |               |         |       | ±0.25pF | GRM0335C1H3R6CA01# |
|        |               |         | 3.7pF | ±0.05pF | GRM0335C1H3R7WA01# |
|        |               |         |       | ±0.1pF  | GRM0335C1H3R7BA01# |
|        |               |         |       | ±0.25pF | GRM0335C1H3R7CA01# |
|        |               |         | 3.8pF | ±0.05pF | GRM0335C1H3R8WA01# |
|        |               |         |       | ±0.1pF  | GRM0335C1H3R8BA01# |
|        |               |         |       | ±0.25pF | GRM0335C1H3R8CA01# |
|        |               |         | 3.9pF | ±0.05pF | GRM0335C1H3R9WA01# |
|        |               |         |       | ±0.1pF  | GRM0335C1H3R9BA01# |
|        |               |         |       | ±0.25pF | GRM0335C1H3R9CA01# |
|        |               |         | 4.0pF | ±0.05pF | GRM0335C1H4R0WA01# |
|        |               |         |       | ±0.1pF  | GRM0335C1H4R0BA01# |
|        |               |         |       | ±0.25pF | GRM0335C1H4R0CA01# |
|        |               |         | 4.1pF | ±0.05pF | GRM0335C1H4R1WA01# |
|        |               |         |       | ±0.1pF  | GRM0335C1H4R1BA01# |
|        |               |         |       | ±0.25pF | GRM0335C1H4R1CA01# |
|        |               |         | 4.2pF | ±0.05pF | GRM0335C1H4R2WA01# |
|        |               |         |       | ±0.1pF  | GRM0335C1H4R2BA01# |
|        |               |         |       | ±0.25pF | GRM0335C1H4R2CA01# |
|        |               |         | 4.3pF | ±0.05pF | GRM0335C1H4R3WA01# |
|        |               |         |       | ±0.1pF  | GRM0335C1H4R3BA01# |
|        |               |         |       | ±0.25pF | GRM0335C1H4R3CA01# |
|        |               |         | 4.4pF | ±0.05pF | GRM0335C1H4R4WA01# |
|        |               |         |       | ±0.1pF  | GRM0335C1H4R4BA01# |
|        |               |         |       | ±0.25pF | GRM0335C1H4R4CA01# |
|        |               |         | 4.5pF | ±0.05pF | GRM0335C1H4R5WA01# |
|        |               |         |       | ±0.1pF  | GRM0335C1H4R5BA01# |
|        |               |         |       | ±0.25pF | GRM0335C1H4R5CA01# |
|        |               |         | 4.6pF | ±0.05pF | GRM0335C1H4R6WA01# |
|        |               |         |       | ±0.1pF  | GRM0335C1H4R6BA01# |
|        |               |         |       | ±0.25pF | GRM0335C1H4R6CA01# |
|        |               |         | 4.7pF | ±0.05pF | GRM0335C1H4R7WA01# |
|        |               |         |       | ±0.1pF  | GRM0335C1H4R7BA01# |
|        |               |         |       | ±0.25pF | GRM0335C1H4R7CA01# |
|        |               |         | 4.8pF | ±0.05pF | GRM0335C1H4R8WA01# |
|        |               |         |       | ±0.1pF  | GRM0335C1H4R8BA01# |
|        |               |         |       | ±0.25pF | GRM0335C1H4R8CA01# |
|        |               |         | 4.9pF | ±0.05pF | GRM0335C1H4R9WA01# |
|        |               |         |       | ±0.1pF  | GRM0335C1H4R9BA01# |
|        |               |         |       | ±0.25pF | GRM0335C1H4R9CA01# |
|        |               |         | 5.0pF | ±0.05pF | GRM0335C1H5R0WA01# |
|        |               |         |       | ±0.1pF  | GRM0335C1H5R0BA01# |
|        |               |         |       | ±0.25pF | GRM0335C1H5R0CA01# |
|        |               |         | 5.1pF | ±0.05pF | GRM0335C1H5R1WA01# |
|        |               |         |       | ±0.1pF  | GRM0335C1H5R1BA01# |
|        |               |         |       | ±0.25pF | GRM0335C1H5R1CA01# |
|        |               |         |       | ±0.5pF  | GRM0335C1H5R1DA01# |
|        |               |         | 5.2pF | ±0.05pF | GRM0335C1H5R2WA01# |
|        |               |         |       | ±0.1pF  | GRM0335C1H5R2BA01# |
|        |               |         |       | ±0.25pF | GRM0335C1H5R2CA01# |
|        |               |         |       | ±0.5pF  | GRM0335C1H5R2DA01# |
|        |               |         | 5.3pF | ±0.05pF | GRM0335C1H5R3WA01# |
|        |               |         |       | ±0.1pF  | GRM0335C1H5R3BA01# |

| T max. | Rated Voltage | TC Code | Cap.  | Tol.    | Part Number        |
|--------|---------------|---------|-------|---------|--------------------|
| 0.33mm | 50Vdc         | COG     | 5.3pF | ±0.25pF | GRM0335C1H5R3CA01# |
|        |               |         |       | ±0.5pF  | GRM0335C1H5R3DA01# |
|        |               |         | 5.4pF | ±0.05pF | GRM0335C1H5R4WA01# |
|        |               |         |       | ±0.1pF  | GRM0335C1H5R4BA01# |
|        |               |         |       | ±0.25pF | GRM0335C1H5R4CA01# |
|        |               |         |       | ±0.5pF  | GRM0335C1H5R4DA01# |
|        |               |         | 5.5pF | ±0.05pF | GRM0335C1H5R5WA01# |
|        |               |         |       | ±0.1pF  | GRM0335C1H5R5BA01# |
|        |               |         |       | ±0.25pF | GRM0335C1H5R5CA01# |
|        |               |         |       | ±0.5pF  | GRM0335C1H5R5DA01# |
|        |               |         | 5.6pF | ±0.05pF | GRM0335C1H5R6WA01# |
|        |               |         |       | ±0.1pF  | GRM0335C1H5R6BA01# |
|        |               |         |       | ±0.25pF | GRM0335C1H5R6CA01# |
|        |               |         |       | ±0.5pF  | GRM0335C1H5R6DA01# |
|        |               |         | 5.7pF | ±0.05pF | GRM0335C1H5R7WA01# |
|        |               |         |       | ±0.1pF  | GRM0335C1H5R7BA01# |
|        |               |         |       | ±0.25pF | GRM0335C1H5R7CA01# |
|        |               |         |       | ±0.5pF  | GRM0335C1H5R7DA01# |
|        |               |         | 5.8pF | ±0.05pF | GRM0335C1H5R8WA01# |
|        |               |         |       | ±0.1pF  | GRM0335C1H5R8BA01# |
|        |               |         |       | ±0.25pF | GRM0335C1H5R8CA01# |
|        |               |         |       | ±0.5pF  | GRM0335C1H5R8DA01# |
|        |               |         | 5.9pF | ±0.05pF | GRM0335C1H5R9WA01# |
|        |               |         |       | ±0.1pF  | GRM0335C1H5R9BA01# |
|        |               |         |       | ±0.25pF | GRM0335C1H5R9CA01# |
|        |               |         |       | ±0.5pF  | GRM0335C1H5R9DA01# |
|        |               |         | 6.0pF | ±0.05pF | GRM0335C1H6R0WA01# |
|        |               |         |       | ±0.1pF  | GRM0335C1H6R0BA01# |
|        |               |         |       | ±0.25pF | GRM0335C1H6R0CA01# |
|        |               |         |       | ±0.5pF  | GRM0335C1H6R0DA01# |
|        |               |         | 6.1pF | ±0.05pF | GRM0335C1H6R1WA01# |
|        |               |         |       | ±0.1pF  | GRM0335C1H6R1BA01# |
|        |               |         |       | ±0.25pF | GRM0335C1H6R1CA01# |
|        |               |         |       | ±0.5pF  | GRM0335C1H6R1DA01# |
|        |               |         | 6.2pF | ±0.05pF | GRM0335C1H6R2WA01# |
|        |               |         |       | ±0.1pF  | GRM0335C1H6R2BA01# |
|        |               |         |       | ±0.25pF | GRM0335C1H6R2CA01# |
|        |               |         |       | ±0.5pF  | GRM0335C1H6R2DA01# |
|        |               |         | 6.3pF | ±0.05pF | GRM0335C1H6R3WA01# |
|        |               |         |       | ±0.1pF  | GRM0335C1H6R3BA01# |
|        |               |         |       | ±0.25pF | GRM0335C1H6R3CA01# |
|        |               |         |       | ±0.5pF  | GRM0335C1H6R3DA01# |
|        |               |         | 6.4pF | ±0.05pF | GRM0335C1H6R4WA01# |
|        |               |         |       | ±0.1pF  | GRM0335C1H6R4BA01# |
|        |               |         |       | ±0.25pF | GRM0335C1H6R4CA01# |
|        |               |         | 6.5pF | ±0.05pF | GRM0335C1H6R5WA01# |
|        |               |         |       | ±0.1pF  | GRM0335C1H6R5BA01# |
|        |               |         |       | ±0.25pF | GRM0335C1H6R5CA01# |
|        |               |         |       | ±0.5pF  | GRM0335C1H6R5DA01# |
|        |               |         | 6.6pF | ±0.05pF | GRM0335C1H6R6WA01# |
|        |               |         |       | ±0.1pF  | GRM0335C1H6R6BA01# |
|        |               |         |       | ±0.25pF | GRM0335C1H6R6CA01# |
|        |               |         |       | ±0.5pF  | GRM0335C1H6R6DA01# |

Part number # indicates the package specification code.

GRM  
 GR3  
 GRJ  
 GR4  
 GR7  
 GJM  
 GQM  
 GA2  
 GA3 GB  
 GA3 GD  
 GA3 GF  
 LLL  
 LLA  
 LLM  
 LLR  
 NFM  
 KRM  
 KR3  
 GMA  
 GMD  
 ⚠Caution /Notice

# GRM Series Temperature Compensating Type Part Number List

(→ 0.6×0.3mm)

| T max. | Rated Voltage | TC Code | Cap.  | Tol.    | Part Number        | T max.  | Rated Voltage | TC Code | Cap.               | Tol.               | Part Number        |                    |
|--------|---------------|---------|-------|---------|--------------------|---------|---------------|---------|--------------------|--------------------|--------------------|--------------------|
| 0.33mm | 50Vdc         | COG     | 6.7pF | ±0.05pF | GRM0335C1H6R7WA01# | 0.33mm  | 50Vdc         | COG     | 8.0pF              | ±0.25pF            | GRM0335C1H8ROCA01# |                    |
|        |               |         |       | ±0.1pF  | GRM0335C1H6R7BA01# |         |               |         |                    | ±0.5pF             | GRM0335C1H8RODA01# |                    |
|        |               |         |       | ±0.25pF | GRM0335C1H6R7CA01# |         |               |         |                    | 8.1pF              | ±0.05pF            | GRM0335C1H8R1WA01# |
|        |               |         |       | ±0.5pF  | GRM0335C1H6R7DA01# |         |               |         |                    |                    | ±0.1pF             | GRM0335C1H8R1BA01# |
|        |               |         | 6.8pF | ±0.05pF | GRM0335C1H6R8WA01# | ±0.25pF |               |         | GRM0335C1H8R1CA01# |                    |                    |                    |
|        |               |         |       | ±0.1pF  | GRM0335C1H6R8BA01# | ±0.5pF  |               |         | GRM0335C1H8R1DA01# |                    |                    |                    |
|        |               |         |       | ±0.25pF | GRM0335C1H6R8CA01# | 8.2pF   |               |         | ±0.05pF            | GRM0335C1H8R2WA01# |                    |                    |
|        |               |         |       | ±0.5pF  | GRM0335C1H6R8DA01# |         |               |         | ±0.1pF             | GRM0335C1H8R2BA01# |                    |                    |
|        |               |         | 6.9pF | ±0.05pF | GRM0335C1H6R9WA01# |         |               |         | ±0.25pF            | GRM0335C1H8R2CA01# |                    |                    |
|        |               |         |       | ±0.1pF  | GRM0335C1H6R9BA01# |         |               |         | ±0.5pF             | GRM0335C1H8R2DA01# |                    |                    |
|        |               |         |       | ±0.25pF | GRM0335C1H6R9CA01# | 8.3pF   |               |         | ±0.05pF            | GRM0335C1H8R3WA01# |                    |                    |
|        |               |         |       | ±0.5pF  | GRM0335C1H6R9DA01# |         |               |         | ±0.1pF             | GRM0335C1H8R3BA01# |                    |                    |
|        |               |         | 7.0pF | ±0.05pF | GRM0335C1H7R0WA01# |         |               |         | ±0.25pF            | GRM0335C1H8R3CA01# |                    |                    |
|        |               |         |       | ±0.1pF  | GRM0335C1H7R0BA01# |         |               |         | ±0.5pF             | GRM0335C1H8R3DA01# |                    |                    |
|        |               |         |       | ±0.25pF | GRM0335C1H7R0CA01# | 8.4pF   |               |         | ±0.05pF            | GRM0335C1H8R4WA01# |                    |                    |
|        |               |         |       | ±0.5pF  | GRM0335C1H7R0DA01# |         |               |         | ±0.1pF             | GRM0335C1H8R4BA01# |                    |                    |
|        |               |         | 7.1pF | ±0.05pF | GRM0335C1H7R1WA01# |         |               |         | ±0.25pF            | GRM0335C1H8R4CA01# |                    |                    |
|        |               |         |       | ±0.1pF  | GRM0335C1H7R1BA01# |         |               |         | ±0.5pF             | GRM0335C1H8R4DA01# |                    |                    |
|        |               |         |       | ±0.25pF | GRM0335C1H7R1CA01# | 8.5pF   |               |         | ±0.05pF            | GRM0335C1H8R5WA01# |                    |                    |
|        |               |         |       | ±0.5pF  | GRM0335C1H7R1DA01# |         |               |         | ±0.1pF             | GRM0335C1H8R5BA01# |                    |                    |
|        |               |         | 7.2pF | ±0.05pF | GRM0335C1H7R2WA01# |         |               |         | ±0.25pF            | GRM0335C1H8R5CA01# |                    |                    |
|        |               |         |       | ±0.1pF  | GRM0335C1H7R2BA01# |         |               |         | ±0.5pF             | GRM0335C1H8R5DA01# |                    |                    |
|        |               |         |       | ±0.25pF | GRM0335C1H7R2CA01# | 8.6pF   |               |         | ±0.05pF            | GRM0335C1H8R6WA01# |                    |                    |
|        |               |         |       | ±0.5pF  | GRM0335C1H7R2DA01# |         |               |         | ±0.1pF             | GRM0335C1H8R6BA01# |                    |                    |
|        |               |         | 7.3pF | ±0.05pF | GRM0335C1H7R3WA01# |         |               |         | ±0.25pF            | GRM0335C1H8R6CA01# |                    |                    |
|        |               |         |       | ±0.1pF  | GRM0335C1H7R3BA01# |         |               |         | ±0.5pF             | GRM0335C1H8R6DA01# |                    |                    |
|        |               |         |       | ±0.25pF | GRM0335C1H7R3CA01# | 8.7pF   |               |         | ±0.05pF            | GRM0335C1H8R7WA01# |                    |                    |
|        |               |         |       | ±0.5pF  | GRM0335C1H7R3DA01# |         |               |         | ±0.1pF             | GRM0335C1H8R7BA01# |                    |                    |
|        |               |         | 7.4pF | ±0.05pF | GRM0335C1H7R4WA01# |         |               |         | ±0.25pF            | GRM0335C1H8R7CA01# |                    |                    |
|        |               |         |       | ±0.1pF  | GRM0335C1H7R4BA01# |         |               |         | ±0.5pF             | GRM0335C1H8R7DA01# |                    |                    |
|        |               |         |       | ±0.25pF | GRM0335C1H7R4CA01# | 8.8pF   |               |         | ±0.05pF            | GRM0335C1H8R8WA01# |                    |                    |
|        |               |         |       | ±0.5pF  | GRM0335C1H7R4DA01# |         |               |         | ±0.1pF             | GRM0335C1H8R8BA01# |                    |                    |
|        |               |         | 7.5pF | ±0.05pF | GRM0335C1H7R5WA01# |         |               |         | ±0.25pF            | GRM0335C1H8R8CA01# |                    |                    |
|        |               |         |       | ±0.1pF  | GRM0335C1H7R5BA01# |         |               |         | ±0.5pF             | GRM0335C1H8R8DA01# |                    |                    |
|        |               |         |       | ±0.25pF | GRM0335C1H7R5CA01# | 8.9pF   |               |         | ±0.05pF            | GRM0335C1H8R9WA01# |                    |                    |
|        |               |         |       | ±0.5pF  | GRM0335C1H7R5DA01# |         |               |         | ±0.1pF             | GRM0335C1H8R9BA01# |                    |                    |
|        |               |         | 7.6pF | ±0.05pF | GRM0335C1H7R6WA01# |         |               |         | ±0.25pF            | GRM0335C1H8R9CA01# |                    |                    |
|        |               |         |       | ±0.1pF  | GRM0335C1H7R6BA01# |         |               |         | ±0.5pF             | GRM0335C1H8R9DA01# |                    |                    |
|        |               |         |       | ±0.25pF | GRM0335C1H7R6CA01# | 9.0pF   |               |         | ±0.05pF            | GRM0335C1H9R0WA01# |                    |                    |
|        |               |         |       | ±0.5pF  | GRM0335C1H7R6DA01# |         |               |         | ±0.1pF             | GRM0335C1H9R0BA01# |                    |                    |
|        |               |         | 7.7pF | ±0.05pF | GRM0335C1H7R7WA01# |         |               |         | ±0.25pF            | GRM0335C1H9R0CA01# |                    |                    |
|        |               |         |       | ±0.1pF  | GRM0335C1H7R7BA01# |         |               |         | ±0.5pF             | GRM0335C1H9R0DA01# |                    |                    |
|        |               |         |       | ±0.25pF | GRM0335C1H7R7CA01# | 9.1pF   |               |         | ±0.05pF            | GRM0335C1H9R1WA01# |                    |                    |
|        |               |         |       | ±0.5pF  | GRM0335C1H7R7DA01# |         |               |         | ±0.1pF             | GRM0335C1H9R1BA01# |                    |                    |
|        |               |         | 7.8pF | ±0.05pF | GRM0335C1H7R8WA01# |         |               |         | ±0.25pF            | GRM0335C1H9R1CA01# |                    |                    |
|        |               |         |       | ±0.1pF  | GRM0335C1H7R8BA01# |         |               |         | ±0.5pF             | GRM0335C1H9R1DA01# |                    |                    |
|        |               |         |       | ±0.25pF | GRM0335C1H7R8CA01# | 9.2pF   |               |         | ±0.05pF            | GRM0335C1H9R2WA01# |                    |                    |
|        |               |         |       | ±0.5pF  | GRM0335C1H7R8DA01# |         |               |         | ±0.1pF             | GRM0335C1H9R2BA01# |                    |                    |
|        |               |         | 7.9pF | ±0.05pF | GRM0335C1H7R9WA01# |         |               |         | ±0.25pF            | GRM0335C1H9R2CA01# |                    |                    |
|        |               |         |       | ±0.1pF  | GRM0335C1H7R9BA01# |         |               |         | ±0.5pF             | GRM0335C1H9R2DA01# |                    |                    |
|        |               |         |       | ±0.25pF | GRM0335C1H7R9CA01# | 9.3pF   |               |         | ±0.05pF            | GRM0335C1H9R3WA01# |                    |                    |
|        |               |         |       | ±0.5pF  | GRM0335C1H7R9DA01# |         |               |         | ±0.1pF             | GRM0335C1H9R3BA01# |                    |                    |
|        |               |         | 8.0pF | ±0.05pF | GRM0335C1H8R0WA01# |         |               |         | ±0.25pF            | GRM0335C1H9R3CA01# |                    |                    |
|        |               |         |       | ±0.1pF  | GRM0335C1H8R0BA01# |         |               |         | ±0.5pF             | GRM0335C1H9R3DA01# |                    |                    |

- GRM
- GR3
- GRJ
- GR4
- GR7
- GJM
- GQM
- GA2
- GA3 GB
- GA3 GD
- GA3 GF
- LLL
- LLA
- LLM
- LLR
- NFM
- KRM
- KR3
- GMA
- GMD
- ⚠Caution /Notice

Part number # indicates the package specification code.



# GRM Series Temperature Compensating Type Part Number List

(→ 0.6×0.3mm)

| T max. | Rated Voltage | TC Code | Cap.  | Tol.    | Part Number        | T max. | Rated Voltage | TC Code | Cap.  | Tol.    | Part Number        |                    |
|--------|---------------|---------|-------|---------|--------------------|--------|---------------|---------|-------|---------|--------------------|--------------------|
| 0.33mm | 50Vdc         | COG     | 9.4pF | ±0.05pF | GRM0335C1H9R4WA01# | 0.33mm | 50Vdc         | COG     | 180pF | ±2%     | GRM0335C1H181GA01# |                    |
|        |               |         |       | ±0.1pF  | GRM0335C1H9R4BA01# |        |               |         |       | ±5%     | GRM0335C1H181JA01# |                    |
|        |               |         |       | ±0.25pF | GRM0335C1H9R4CA01# |        |               |         |       | 220pF   | ±2%                | GRM0335C1H221GA01# |
|        |               |         |       | ±0.5pF  | GRM0335C1H9R4DA01# |        |               |         |       |         | ±5%                | GRM0335C1H221JA01# |
|        |               |         | 9.5pF | ±0.05pF | GRM0335C1H9R5WA01# |        |               |         | CK    | 0.10pF  | ±0.05pF            | GRM0334C1HR10WA01# |
|        |               |         |       | ±0.1pF  | GRM0335C1H9R5BA01# |        |               |         |       |         | 0.20pF             | ±0.05pF            |
|        |               |         |       | ±0.25pF | GRM0335C1H9R5CA01# |        |               |         |       | ±0.1pF  |                    | GRM0334C1HR20BA01# |
|        |               |         |       | ±0.5pF  | GRM0335C1H9R5DA01# |        |               |         |       | 0.30pF  | ±0.05pF            | GRM0334C1HR30WA01# |
|        |               |         | 9.6pF | ±0.05pF | GRM0335C1H9R6WA01# |        |               |         |       |         | ±0.1pF             | GRM0334C1HR30BA01# |
|        |               |         |       | ±0.1pF  | GRM0335C1H9R6BA01# |        |               |         |       | 0.40pF  | ±0.05pF            | GRM0334C1HR40WA01# |
|        |               |         |       | ±0.25pF | GRM0335C1H9R6CA01# |        |               |         |       |         | ±0.1pF             | GRM0334C1HR40BA01# |
|        |               |         |       | ±0.5pF  | GRM0335C1H9R6DA01# |        |               |         |       | 0.50pF  | ±0.05pF            | GRM0334C1HR50WA01# |
|        |               |         | 9.7pF | ±0.05pF | GRM0335C1H9R7WA01# |        |               |         |       |         | ±0.1pF             | GRM0334C1HR50BA01# |
|        |               |         |       | ±0.1pF  | GRM0335C1H9R7BA01# |        |               |         |       | 0.60pF  | ±0.05pF            | GRM0334C1HR60WA01# |
|        |               |         |       | ±0.25pF | GRM0335C1H9R7CA01# |        |               |         |       |         | ±0.1pF             | GRM0334C1HR60BA01# |
|        |               |         |       | ±0.5pF  | GRM0335C1H9R7DA01# |        |               |         |       | 0.70pF  | ±0.05pF            | GRM0334C1HR70WA01# |
|        |               |         | 9.8pF | ±0.05pF | GRM0335C1H9R8WA01# |        |               |         |       |         | ±0.1pF             | GRM0334C1HR70BA01# |
|        |               |         |       | ±0.1pF  | GRM0335C1H9R8BA01# |        |               |         |       | 0.80pF  | ±0.05pF            | GRM0334C1HR80WA01# |
|        |               |         |       | ±0.25pF | GRM0335C1H9R8CA01# |        |               |         |       |         | ±0.1pF             | GRM0334C1HR80BA01# |
|        |               |         |       | ±0.5pF  | GRM0335C1H9R8DA01# |        |               |         |       | 0.90pF  | ±0.05pF            | GRM0334C1HR90WA01# |
|        |               |         | 9.9pF | ±0.05pF | GRM0335C1H9R9WA01# |        |               |         |       |         | ±0.1pF             | GRM0334C1HR90BA01# |
|        |               |         |       | ±0.1pF  | GRM0335C1H9R9BA01# |        |               |         |       | 1.0pF   | ±0.05pF            | GRM0334C1H1R0WA01# |
|        |               |         |       | ±0.25pF | GRM0335C1H9R9CA01# |        |               |         |       |         | ±0.1pF             | GRM0334C1H1R0BA01# |
|        |               |         |       | ±0.5pF  | GRM0335C1H9R9DA01# |        |               |         |       | ±0.25pF | GRM0334C1H1R0CA01# |                    |
|        |               |         | 10pF  | ±2%     | GRM0335C1H100GA01# |        |               |         |       | 1.1pF   | ±0.05pF            | GRM0334C1H1R1WA01# |
|        |               |         |       | ±5%     | GRM0335C1H100JA01# |        |               |         |       |         | ±0.1pF             | GRM0334C1H1R1BA01# |
|        |               |         | 12pF  | ±2%     | GRM0335C1H120GA01# |        |               |         |       | ±0.25pF | GRM0334C1H1R1CA01# |                    |
|        |               |         |       | ±5%     | GRM0335C1H120JA01# |        |               |         |       | 1.2pF   | ±0.05pF            | GRM0334C1H1R2WA01# |
|        |               |         | 15pF  | ±2%     | GRM0335C1H150GA01# |        |               |         |       |         | ±0.1pF             | GRM0334C1H1R2BA01# |
|        |               |         |       | ±5%     | GRM0335C1H150JA01# |        |               |         |       | ±0.25pF | GRM0334C1H1R2CA01# |                    |
|        |               |         | 18pF  | ±2%     | GRM0335C1H180GA01# |        |               |         |       | 1.3pF   | ±0.05pF            | GRM0334C1H1R3WA01# |
|        |               |         |       | ±5%     | GRM0335C1H180JA01# |        |               |         |       |         | ±0.1pF             | GRM0334C1H1R3BA01# |
|        |               |         | 22pF  | ±2%     | GRM0335C1H220GA01# |        |               |         |       | ±0.25pF | GRM0334C1H1R3CA01# |                    |
|        |               |         |       | ±5%     | GRM0335C1H220JA01# |        |               |         |       | 1.4pF   | ±0.05pF            | GRM0334C1H1R4WA01# |
|        |               |         | 27pF  | ±2%     | GRM0335C1H270GA01# |        |               |         |       |         | ±0.1pF             | GRM0334C1H1R4BA01# |
|        |               |         |       | ±5%     | GRM0335C1H270JA01# |        |               |         |       | ±0.25pF | GRM0334C1H1R4CA01# |                    |
|        |               |         | 33pF  | ±2%     | GRM0335C1H330GA01# |        |               |         |       | 1.5pF   | ±0.05pF            | GRM0334C1H1R5WA01# |
|        |               |         |       | ±5%     | GRM0335C1H330JA01# |        |               |         |       |         | ±0.1pF             | GRM0334C1H1R5BA01# |
|        |               |         | 39pF  | ±2%     | GRM0335C1H390GA01# |        |               |         |       | ±0.25pF | GRM0334C1H1R5CA01# |                    |
|        |               |         |       | ±5%     | GRM0335C1H390JA01# |        |               |         |       | 1.6pF   | ±0.05pF            | GRM0334C1H1R6WA01# |
|        |               |         | 47pF  | ±2%     | GRM0335C1H470GA01# |        |               |         |       |         | ±0.1pF             | GRM0334C1H1R6BA01# |
|        |               |         |       | ±5%     | GRM0335C1H470JA01# |        |               |         |       | ±0.25pF | GRM0334C1H1R6CA01# |                    |
|        |               |         | 56pF  | ±2%     | GRM0335C1H560GA01# |        |               |         |       | 1.7pF   | ±0.05pF            | GRM0334C1H1R7WA01# |
|        |               |         |       | ±5%     | GRM0335C1H560JA01# |        |               |         |       |         | ±0.1pF             | GRM0334C1H1R7BA01# |
|        |               |         | 68pF  | ±2%     | GRM0335C1H680GA01# |        |               |         |       | ±0.25pF | GRM0334C1H1R7CA01# |                    |
|        |               |         |       | ±5%     | GRM0335C1H680JA01# |        |               |         |       | 1.8pF   | ±0.05pF            | GRM0334C1H1R8WA01# |
|        |               |         | 82pF  | ±2%     | GRM0335C1H820GA01# |        |               |         |       |         | ±0.1pF             | GRM0334C1H1R8BA01# |
|        |               |         |       | ±5%     | GRM0335C1H820JA01# |        |               |         |       | ±0.25pF | GRM0334C1H1R8CA01# |                    |
|        |               |         | 100pF | ±2%     | GRM0335C1H101GA01# |        |               |         |       | 1.9pF   | ±0.05pF            | GRM0334C1H1R9WA01# |
|        |               |         |       | ±5%     | GRM0335C1H101JA01# |        |               |         |       |         | ±0.1pF             | GRM0334C1H1R9BA01# |
|        |               |         | 120pF | ±2%     | GRM0335C1H121GA01# |        |               |         |       | ±0.25pF | GRM0334C1H1R9CA01# |                    |
|        |               |         |       | ±5%     | GRM0335C1H121JA01# |        |               |         |       | 2.0pF   | ±0.05pF            | GRM0334C1H2R0WA01# |
|        |               |         | 150pF | ±2%     | GRM0335C1H151GA01# |        |               |         |       |         | ±0.1pF             | GRM0334C1H2R0BA01# |
|        |               |         |       | ±5%     | GRM0335C1H151JA01# |        |               |         |       | ±0.25pF | GRM0334C1H2R0CA01# |                    |

Part number # indicates the package specification code.



# GRM Series Temperature Compensating Type Part Number List

(→ 0.6×0.3mm)

| T max. | Rated Voltage | TC Code | Cap.  | Tol.    | Part Number        | T max. | Rated Voltage | TC Code | Cap.  | Tol.    | Part Number        |                    |
|--------|---------------|---------|-------|---------|--------------------|--------|---------------|---------|-------|---------|--------------------|--------------------|
| 0.33mm | 50Vdc         | CJ      | 2.1pF | ±0.05pF | GRM0333C1H2R1WA01# | 0.33mm | 50Vdc         | CJ      | 3.9pF | ±0.05pF | GRM0333C1H3R9WA01# |                    |
|        |               |         |       | ±0.1pF  | GRM0333C1H2R1BA01# |        |               |         |       | ±0.1pF  | GRM0333C1H3R9BA01# |                    |
|        |               |         |       | ±0.25pF | GRM0333C1H2R1CA01# |        |               |         |       | ±0.25pF | GRM0333C1H3R9CA01# |                    |
|        |               |         | 2.2pF | ±0.05pF | GRM0333C1H2R2WA01# |        |               |         | CH    | 4.0pF   | ±0.05pF            | GRM0332C1H4R0WA01# |
|        |               |         |       | ±0.1pF  | GRM0333C1H2R2BA01# |        |               |         |       |         | ±0.1pF             | GRM0332C1H4R0BA01# |
|        |               |         |       | ±0.25pF | GRM0333C1H2R2CA01# |        |               |         |       |         | ±0.25pF            | GRM0332C1H4R0CA01# |
|        |               |         | 2.3pF | ±0.05pF | GRM0333C1H2R3WA01# |        |               |         |       | 4.1pF   | ±0.05pF            | GRM0332C1H4R1WA01# |
|        |               |         |       | ±0.1pF  | GRM0333C1H2R3BA01# |        |               |         |       |         | ±0.1pF             | GRM0332C1H4R1BA01# |
|        |               |         |       | ±0.25pF | GRM0333C1H2R3CA01# |        |               |         |       |         | ±0.25pF            | GRM0332C1H4R1CA01# |
|        |               |         | 2.4pF | ±0.05pF | GRM0333C1H2R4WA01# |        |               |         |       | 4.2pF   | ±0.05pF            | GRM0332C1H4R2WA01# |
|        |               |         |       | ±0.1pF  | GRM0333C1H2R4BA01# |        |               |         |       |         | ±0.1pF             | GRM0332C1H4R2BA01# |
|        |               |         |       | ±0.25pF | GRM0333C1H2R4CA01# |        |               |         |       |         | ±0.25pF            | GRM0332C1H4R2CA01# |
|        |               |         | 2.5pF | ±0.05pF | GRM0333C1H2R5WA01# |        |               |         |       | 4.3pF   | ±0.05pF            | GRM0332C1H4R3WA01# |
|        |               |         |       | ±0.1pF  | GRM0333C1H2R5BA01# |        |               |         |       |         | ±0.1pF             | GRM0332C1H4R3BA01# |
|        |               |         |       | ±0.25pF | GRM0333C1H2R5CA01# |        |               |         |       |         | ±0.25pF            | GRM0332C1H4R3CA01# |
|        |               |         | 2.6pF | ±0.05pF | GRM0333C1H2R6WA01# |        |               |         |       | 4.4pF   | ±0.05pF            | GRM0332C1H4R4WA01# |
|        |               |         |       | ±0.1pF  | GRM0333C1H2R6BA01# |        |               |         |       |         | ±0.1pF             | GRM0332C1H4R4BA01# |
|        |               |         |       | ±0.25pF | GRM0333C1H2R6CA01# |        |               |         |       |         | ±0.25pF            | GRM0332C1H4R4CA01# |
|        |               |         | 2.7pF | ±0.05pF | GRM0333C1H2R7WA01# |        |               |         |       | 4.5pF   | ±0.05pF            | GRM0332C1H4R5WA01# |
|        |               |         |       | ±0.1pF  | GRM0333C1H2R7BA01# |        |               |         |       |         | ±0.1pF             | GRM0332C1H4R5BA01# |
|        |               |         |       | ±0.25pF | GRM0333C1H2R7CA01# |        |               |         |       |         | ±0.25pF            | GRM0332C1H4R5CA01# |
|        |               |         | 2.8pF | ±0.05pF | GRM0333C1H2R8WA01# |        |               |         |       | 4.6pF   | ±0.05pF            | GRM0332C1H4R6WA01# |
|        |               |         |       | ±0.1pF  | GRM0333C1H2R8BA01# |        |               |         |       |         | ±0.1pF             | GRM0332C1H4R6BA01# |
|        |               |         |       | ±0.25pF | GRM0333C1H2R8CA01# |        |               |         |       |         | ±0.25pF            | GRM0332C1H4R6CA01# |
|        |               |         | 2.9pF | ±0.05pF | GRM0333C1H2R9WA01# |        |               |         |       | 4.7pF   | ±0.05pF            | GRM0332C1H4R7WA01# |
|        |               |         |       | ±0.1pF  | GRM0333C1H2R9BA01# |        |               |         |       |         | ±0.1pF             | GRM0332C1H4R7BA01# |
|        |               |         |       | ±0.25pF | GRM0333C1H2R9CA01# |        |               |         |       |         | ±0.25pF            | GRM0332C1H4R7CA01# |
|        |               |         | 3.0pF | ±0.05pF | GRM0333C1H3R0WA01# |        |               |         |       | 4.8pF   | ±0.05pF            | GRM0332C1H4R8WA01# |
|        |               |         |       | ±0.1pF  | GRM0333C1H3R0BA01# |        |               |         |       |         | ±0.1pF             | GRM0332C1H4R8BA01# |
|        |               |         |       | ±0.25pF | GRM0333C1H3R0CA01# |        |               |         |       |         | ±0.25pF            | GRM0332C1H4R8CA01# |
|        |               |         | 3.1pF | ±0.05pF | GRM0333C1H3R1WA01# |        |               |         |       | 4.9pF   | ±0.05pF            | GRM0332C1H4R9WA01# |
|        |               |         |       | ±0.1pF  | GRM0333C1H3R1BA01# |        |               |         |       |         | ±0.1pF             | GRM0332C1H4R9BA01# |
|        |               |         |       | ±0.25pF | GRM0333C1H3R1CA01# |        |               |         |       |         | ±0.25pF            | GRM0332C1H4R9CA01# |
|        |               |         | 3.2pF | ±0.05pF | GRM0333C1H3R2WA01# |        |               |         |       | 5.0pF   | ±0.05pF            | GRM0332C1H5R0WA01# |
|        |               |         |       | ±0.1pF  | GRM0333C1H3R2BA01# |        |               |         |       |         | ±0.1pF             | GRM0332C1H5R0BA01# |
|        |               |         |       | ±0.25pF | GRM0333C1H3R2CA01# |        |               |         |       |         | ±0.25pF            | GRM0332C1H5R0CA01# |
|        |               |         | 3.3pF | ±0.05pF | GRM0333C1H3R3WA01# |        |               |         |       | 5.1pF   | ±0.05pF            | GRM0332C1H5R1WA01# |
|        |               |         |       | ±0.1pF  | GRM0333C1H3R3BA01# |        |               |         |       |         | ±0.1pF             | GRM0332C1H5R1BA01# |
|        |               |         |       | ±0.25pF | GRM0333C1H3R3CA01# |        |               |         |       |         | ±0.25pF            | GRM0332C1H5R1CA01# |
|        |               |         | 3.4pF | ±0.05pF | GRM0333C1H3R4WA01# |        |               |         |       | 5.2pF   | ±0.05pF            | GRM0332C1H5R2WA01# |
|        |               |         |       | ±0.1pF  | GRM0333C1H3R4BA01# |        |               |         |       |         | ±0.1pF             | GRM0332C1H5R2BA01# |
|        |               |         |       | ±0.25pF | GRM0333C1H3R4CA01# |        |               |         |       |         | ±0.25pF            | GRM0332C1H5R2CA01# |
|        |               |         | 3.5pF | ±0.05pF | GRM0333C1H3R5WA01# |        |               |         |       | 5.3pF   | ±0.05pF            | GRM0332C1H5R3WA01# |
|        |               |         |       | ±0.1pF  | GRM0333C1H3R5BA01# |        |               |         |       |         | ±0.1pF             | GRM0332C1H5R3BA01# |
|        |               |         |       | ±0.25pF | GRM0333C1H3R5CA01# |        |               |         |       |         | ±0.25pF            | GRM0332C1H5R3CA01# |
|        |               |         | 3.6pF | ±0.05pF | GRM0333C1H3R6WA01# |        |               |         |       | 5.4pF   | ±0.05pF            | GRM0332C1H5R4WA01# |
|        |               |         |       | ±0.1pF  | GRM0333C1H3R6BA01# |        |               |         |       |         | ±0.1pF             | GRM0332C1H5R4BA01# |
|        |               |         |       | ±0.25pF | GRM0333C1H3R6CA01# |        |               |         |       |         | ±0.25pF            | GRM0332C1H5R4CA01# |
|        |               |         | 3.7pF | ±0.05pF | GRM0333C1H3R7WA01# |        |               |         |       | 5.5pF   | ±0.05pF            | GRM0332C1H5R5WA01# |
|        |               |         |       | ±0.1pF  | GRM0333C1H3R7BA01# |        |               |         |       |         | ±0.1pF             | GRM0332C1H5R5BA01# |
|        |               |         |       | ±0.25pF | GRM0333C1H3R7CA01# |        |               |         |       |         | ±0.25pF            | GRM0332C1H5R5CA01# |
|        |               |         | 3.8pF | ±0.05pF | GRM0333C1H3R8WA01# |        |               |         |       |         | ±0.05pF            | GRM0332C1H5R5WA01# |
|        |               |         |       | ±0.1pF  | GRM0333C1H3R8BA01# |        |               |         |       |         | ±0.1pF             | GRM0332C1H5R5BA01# |
|        |               |         |       | ±0.25pF | GRM0333C1H3R8CA01# |        |               |         |       |         | ±0.25pF            | GRM0332C1H5R5CA01# |

Part number # indicates the package specification code.

GRM  
 GR3  
 GRJ  
 GR4  
 GR7  
 GJM  
 GQM  
 GA2  
 GA3 GB  
 GA3 GD  
 GA3 GF  
 LLL  
 LLA  
 LLM  
 LLR  
 NFM  
 KRM  
 KR3  
 GMA  
 GMD  
 ⚠Caution /Notice

# GRM Series Temperature Compensating Type Part Number List

(→ 0.6×0.3mm)

| T max. | Rated Voltage | TC Code | Cap.   | Tol.               | Part Number        | T max. | Rated Voltage | TC Code | Cap.    | Tol.               | Part Number        |
|--------|---------------|---------|--------|--------------------|--------------------|--------|---------------|---------|---------|--------------------|--------------------|
| 0.33mm | 50Vdc         | CH      | 5.5pF  | ±0.25pF            | GRM0332C1H5R5CA01# | 0.33mm | 50Vdc         | CH      | 6.9pF   | ±0.05pF            | GRM0332C1H6R9WA01# |
|        |               |         |        | ±0.5pF             | GRM0332C1H5R5DA01# |        |               |         |         | ±0.1pF             | GRM0332C1H6R9BA01# |
|        |               |         | 5.6pF  | ±0.05pF            | GRM0332C1H5R6WA01# |        |               |         | ±0.25pF | GRM0332C1H6R9CA01# |                    |
|        |               |         |        | ±0.1pF             | GRM0332C1H5R6BA01# |        |               |         | ±0.5pF  | GRM0332C1H6R9DA01# |                    |
|        |               |         |        | ±0.25pF            | GRM0332C1H5R6CA01# |        |               |         | 7.0pF   | ±0.05pF            | GRM0332C1H7R0WA01# |
|        |               |         |        | ±0.5pF             | GRM0332C1H5R6DA01# |        |               |         |         | ±0.1pF             | GRM0332C1H7R0BA01# |
|        |               |         | 5.7pF  | ±0.05pF            | GRM0332C1H5R7WA01# |        |               |         |         | ±0.25pF            | GRM0332C1H7R0CA01# |
|        |               |         |        | ±0.1pF             | GRM0332C1H5R7BA01# |        |               |         | ±0.5pF  | GRM0332C1H7R0DA01# |                    |
|        |               |         |        | ±0.25pF            | GRM0332C1H5R7CA01# |        |               |         | 7.1pF   | ±0.05pF            | GRM0332C1H7R1WA01# |
|        |               |         | ±0.5pF | GRM0332C1H5R7DA01# | ±0.1pF             |        |               |         |         | GRM0332C1H7R1BA01# |                    |
|        |               |         | 5.8pF  | ±0.05pF            | GRM0332C1H5R8WA01# |        |               |         |         | ±0.25pF            | GRM0332C1H7R1CA01# |
|        |               |         |        | ±0.1pF             | GRM0332C1H5R8BA01# |        |               |         | ±0.5pF  | GRM0332C1H7R1DA01# |                    |
|        |               |         |        | ±0.25pF            | GRM0332C1H5R8CA01# |        |               |         | 7.2pF   | ±0.05pF            | GRM0332C1H7R2WA01# |
|        |               |         |        | ±0.5pF             | GRM0332C1H5R8DA01# |        |               |         |         | ±0.1pF             | GRM0332C1H7R2BA01# |
|        |               |         | 5.9pF  | ±0.05pF            | GRM0332C1H5R9WA01# |        |               |         |         | ±0.25pF            | GRM0332C1H7R2CA01# |
|        |               |         |        | ±0.1pF             | GRM0332C1H5R9BA01# |        |               |         | ±0.5pF  | GRM0332C1H7R2DA01# |                    |
|        |               |         |        | ±0.25pF            | GRM0332C1H5R9CA01# |        |               |         | 7.3pF   | ±0.05pF            | GRM0332C1H7R3WA01# |
|        |               |         |        | ±0.5pF             | GRM0332C1H5R9DA01# |        |               |         |         | ±0.1pF             | GRM0332C1H7R3BA01# |
|        |               |         | 6.0pF  | ±0.05pF            | GRM0332C1H6R0WA01# |        |               |         |         | ±0.25pF            | GRM0332C1H7R3CA01# |
|        |               |         |        | ±0.1pF             | GRM0332C1H6R0BA01# |        |               |         | ±0.5pF  | GRM0332C1H7R3DA01# |                    |
|        |               |         |        | ±0.25pF            | GRM0332C1H6R0CA01# |        |               |         | 7.4pF   | ±0.05pF            | GRM0332C1H7R4WA01# |
|        |               |         |        | ±0.5pF             | GRM0332C1H6R0DA01# |        |               |         |         | ±0.1pF             | GRM0332C1H7R4BA01# |
|        |               |         | 6.1pF  | ±0.05pF            | GRM0332C1H6R1WA01# |        |               |         |         | ±0.25pF            | GRM0332C1H7R4CA01# |
|        |               |         |        | ±0.1pF             | GRM0332C1H6R1BA01# |        |               |         | ±0.5pF  | GRM0332C1H7R4DA01# |                    |
|        |               |         |        | ±0.25pF            | GRM0332C1H6R1CA01# |        |               |         | 7.5pF   | ±0.05pF            | GRM0332C1H7R5WA01# |
|        |               |         |        | ±0.5pF             | GRM0332C1H6R1DA01# |        |               |         |         | ±0.1pF             | GRM0332C1H7R5BA01# |
|        |               |         | 6.2pF  | ±0.05pF            | GRM0332C1H6R2WA01# |        |               |         |         | ±0.25pF            | GRM0332C1H7R5CA01# |
|        |               |         |        | ±0.1pF             | GRM0332C1H6R2BA01# |        |               |         | ±0.5pF  | GRM0332C1H7R5DA01# |                    |
|        |               |         |        | ±0.25pF            | GRM0332C1H6R2CA01# |        |               |         | 7.6pF   | ±0.05pF            | GRM0332C1H7R6WA01# |
|        |               |         |        | ±0.5pF             | GRM0332C1H6R2DA01# |        |               |         |         | ±0.1pF             | GRM0332C1H7R6BA01# |
|        |               |         | 6.3pF  | ±0.05pF            | GRM0332C1H6R3WA01# |        |               |         |         | ±0.25pF            | GRM0332C1H7R6CA01# |
|        |               |         |        | ±0.1pF             | GRM0332C1H6R3BA01# |        |               |         | ±0.5pF  | GRM0332C1H7R6DA01# |                    |
|        |               |         |        | ±0.25pF            | GRM0332C1H6R3CA01# |        |               |         | 7.7pF   | ±0.05pF            | GRM0332C1H7R7WA01# |
|        |               |         |        | ±0.5pF             | GRM0332C1H6R3DA01# |        |               |         |         | ±0.1pF             | GRM0332C1H7R7BA01# |
|        |               |         | 6.4pF  | ±0.05pF            | GRM0332C1H6R4WA01# |        |               |         |         | ±0.25pF            | GRM0332C1H7R7CA01# |
|        |               |         |        | ±0.1pF             | GRM0332C1H6R4BA01# |        |               |         | ±0.5pF  | GRM0332C1H7R7DA01# |                    |
|        |               |         |        | ±0.25pF            | GRM0332C1H6R4CA01# |        |               |         | 7.8pF   | ±0.05pF            | GRM0332C1H7R8WA01# |
|        |               |         |        | ±0.5pF             | GRM0332C1H6R4DA01# |        |               |         |         | ±0.1pF             | GRM0332C1H7R8BA01# |
|        |               |         | 6.5pF  | ±0.05pF            | GRM0332C1H6R5WA01# |        |               |         |         | ±0.25pF            | GRM0332C1H7R8CA01# |
|        |               |         |        | ±0.1pF             | GRM0332C1H6R5BA01# |        |               |         | ±0.5pF  | GRM0332C1H7R8DA01# |                    |
|        |               |         |        | ±0.25pF            | GRM0332C1H6R5CA01# |        |               |         | 7.9pF   | ±0.05pF            | GRM0332C1H7R9WA01# |
|        |               |         |        | ±0.5pF             | GRM0332C1H6R5DA01# |        |               |         |         | ±0.1pF             | GRM0332C1H7R9BA01# |
|        |               |         | 6.6pF  | ±0.05pF            | GRM0332C1H6R6WA01# |        |               |         |         | ±0.25pF            | GRM0332C1H7R9CA01# |
|        |               |         |        | ±0.1pF             | GRM0332C1H6R6BA01# |        |               |         | ±0.5pF  | GRM0332C1H7R9DA01# |                    |
|        |               |         |        | ±0.25pF            | GRM0332C1H6R6CA01# |        |               |         | 8.0pF   | ±0.05pF            | GRM0332C1H8R0WA01# |
|        |               |         |        | ±0.5pF             | GRM0332C1H6R6DA01# |        |               |         |         | ±0.1pF             | GRM0332C1H8R0BA01# |
|        |               |         | 6.7pF  | ±0.05pF            | GRM0332C1H6R7WA01# |        |               |         |         | ±0.25pF            | GRM0332C1H8R0CA01# |
|        |               |         |        | ±0.1pF             | GRM0332C1H6R7BA01# |        |               |         | ±0.5pF  | GRM0332C1H8R0DA01# |                    |
|        |               |         |        | ±0.25pF            | GRM0332C1H6R7CA01# |        |               |         | 8.1pF   | ±0.05pF            | GRM0332C1H8R1WA01# |
|        |               |         |        | ±0.5pF             | GRM0332C1H6R7DA01# |        |               |         |         | ±0.1pF             | GRM0332C1H8R1BA01# |
|        |               |         | 6.8pF  | ±0.05pF            | GRM0332C1H6R8WA01# |        |               |         |         | ±0.25pF            | GRM0332C1H8R1CA01# |
|        |               |         |        | ±0.1pF             | GRM0332C1H6R8BA01# |        |               |         | ±0.5pF  | GRM0332C1H8R1DA01# |                    |
|        |               |         |        | ±0.25pF            | GRM0332C1H6R8CA01# |        |               |         | 8.2pF   | ±0.05pF            | GRM0332C1H8R2WA01# |
|        |               |         |        | ±0.5pF             | GRM0332C1H6R8DA01# |        |               |         |         | ±0.1pF             | GRM0332C1H8R2BA01# |

Part number # indicates the package specification code.



# GRM Series Temperature Compensating Type Part Number List

(→ 0.6×0.3mm)

| T max. | Rated Voltage | TC Code | Cap.   | Tol.               | Part Number        | T max. | Rated Voltage | TC Code | Cap.    | Tol.               | Part Number        |       |     |  |       |     |                    |                    |
|--------|---------------|---------|--------|--------------------|--------------------|--------|---------------|---------|---------|--------------------|--------------------|-------|-----|--|-------|-----|--------------------|--------------------|
| 0.33mm | 50Vdc         | CH      | 8.2pF  | ±0.25pF            | GRM0332C1H8R2CA01# | 0.33mm | 50Vdc         | CH      | 9.6pF   | ±0.05pF            | GRM0332C1H9R6WA01# |       |     |  |       |     |                    |                    |
|        |               |         |        | ±0.5pF             | GRM0332C1H8R2DA01# |        |               |         |         | ±0.1pF             | GRM0332C1H9R6BA01# |       |     |  |       |     |                    |                    |
|        |               |         | 8.3pF  | ±0.05pF            | GRM0332C1H8R3WA01# |        |               |         | ±0.25pF | GRM0332C1H9R6CA01# |                    |       |     |  |       |     |                    |                    |
|        |               |         |        | ±0.1pF             | GRM0332C1H8R3BA01# |        |               |         | ±0.5pF  | GRM0332C1H9R6DA01# |                    |       |     |  |       |     |                    |                    |
|        |               |         |        | ±0.25pF            | GRM0332C1H8R3CA01# |        |               |         | 9.7pF   | ±0.05pF            | GRM0332C1H9R7WA01# |       |     |  |       |     |                    |                    |
|        |               |         |        | ±0.5pF             | GRM0332C1H8R3DA01# |        |               |         |         | ±0.1pF             | GRM0332C1H9R7BA01# |       |     |  |       |     |                    |                    |
|        |               |         | 8.4pF  | ±0.05pF            | GRM0332C1H8R4WA01# |        |               |         |         | ±0.25pF            | GRM0332C1H9R7CA01# |       |     |  |       |     |                    |                    |
|        |               |         |        | ±0.1pF             | GRM0332C1H8R4BA01# |        |               |         | ±0.5pF  | GRM0332C1H9R7DA01# |                    |       |     |  |       |     |                    |                    |
|        |               |         |        | ±0.25pF            | GRM0332C1H8R4CA01# |        |               |         | 9.8pF   | ±0.05pF            | GRM0332C1H9R8WA01# |       |     |  |       |     |                    |                    |
|        |               |         | ±0.5pF | GRM0332C1H8R4DA01# | ±0.1pF             |        |               |         |         | GRM0332C1H9R8BA01# |                    |       |     |  |       |     |                    |                    |
|        |               |         | 8.5pF  | ±0.05pF            | GRM0332C1H8R5WA01# |        |               |         |         | ±0.25pF            | GRM0332C1H9R8CA01# |       |     |  |       |     |                    |                    |
|        |               |         |        | ±0.1pF             | GRM0332C1H8R5BA01# |        |               |         | ±0.5pF  | GRM0332C1H9R8DA01# |                    |       |     |  |       |     |                    |                    |
|        |               |         |        | ±0.25pF            | GRM0332C1H8R5CA01# |        |               |         | 9.9pF   | ±0.05pF            | GRM0332C1H9R9WA01# |       |     |  |       |     |                    |                    |
|        |               |         | ±0.5pF | GRM0332C1H8R5DA01# | ±0.1pF             |        |               |         |         | GRM0332C1H9R9BA01# |                    |       |     |  |       |     |                    |                    |
|        |               |         | 8.6pF  | ±0.05pF            | GRM0332C1H8R6WA01# |        |               |         |         | ±0.25pF            | GRM0332C1H9R9CA01# |       |     |  |       |     |                    |                    |
|        |               |         |        | ±0.1pF             | GRM0332C1H8R6BA01# |        |               |         | ±0.5pF  | GRM0332C1H9R9DA01# |                    |       |     |  |       |     |                    |                    |
|        |               |         |        | ±0.25pF            | GRM0332C1H8R6CA01# |        |               |         | 10pF    | ±2%                | GRM0332C1H100GA01# |       |     |  |       |     |                    |                    |
|        |               |         |        | ±0.5pF             | GRM0332C1H8R6DA01# |        |               |         |         | ±5%                | GRM0332C1H100JA01# |       |     |  |       |     |                    |                    |
|        |               |         | 8.7pF  | ±0.05pF            | GRM0332C1H8R7WA01# |        |               |         | 12pF    | ±2%                | GRM0332C1H120GA01# |       |     |  |       |     |                    |                    |
|        |               |         |        | ±0.1pF             | GRM0332C1H8R7BA01# |        |               |         |         | ±5%                | GRM0332C1H120JA01# |       |     |  |       |     |                    |                    |
|        |               |         |        | ±0.25pF            | GRM0332C1H8R7CA01# |        |               |         | 15pF    | ±2%                | GRM0332C1H150GA01# |       |     |  |       |     |                    |                    |
|        |               |         |        | ±0.5pF             | GRM0332C1H8R7DA01# |        |               |         |         | ±5%                | GRM0332C1H150JA01# |       |     |  |       |     |                    |                    |
|        |               |         | 8.8pF  | ±0.05pF            | GRM0332C1H8R8WA01# |        |               |         | 18pF    | ±2%                | GRM0332C1H180GA01# |       |     |  |       |     |                    |                    |
|        |               |         |        | ±0.1pF             | GRM0332C1H8R8BA01# |        |               |         |         | ±5%                | GRM0332C1H180JA01# |       |     |  |       |     |                    |                    |
|        |               |         |        | ±0.25pF            | GRM0332C1H8R8CA01# |        |               |         | 22pF    | ±2%                | GRM0332C1H220GA01# |       |     |  |       |     |                    |                    |
|        |               |         |        | ±0.5pF             | GRM0332C1H8R8DA01# |        |               |         |         | ±5%                | GRM0332C1H220JA01# |       |     |  |       |     |                    |                    |
|        |               |         | 8.9pF  | ±0.05pF            | GRM0332C1H8R9WA01# |        |               |         | 27pF    | ±2%                | GRM0332C1H270GA01# |       |     |  |       |     |                    |                    |
|        |               |         |        | ±0.1pF             | GRM0332C1H8R9BA01# |        |               |         |         | ±5%                | GRM0332C1H270JA01# |       |     |  |       |     |                    |                    |
|        |               |         |        | ±0.25pF            | GRM0332C1H8R9CA01# |        |               |         | 33pF    | ±2%                | GRM0332C1H330GA01# |       |     |  |       |     |                    |                    |
|        |               |         |        | ±0.5pF             | GRM0332C1H8R9DA01# |        |               |         |         | ±5%                | GRM0332C1H330JA01# |       |     |  |       |     |                    |                    |
|        |               |         | 9.0pF  | ±0.05pF            | GRM0332C1H9R0WA01# |        |               |         | 39pF    | ±2%                | GRM0332C1H390GA01# |       |     |  |       |     |                    |                    |
|        |               |         |        | ±0.1pF             | GRM0332C1H9R0BA01# |        |               |         |         | ±5%                | GRM0332C1H390JA01# |       |     |  |       |     |                    |                    |
|        |               |         |        | ±0.25pF            | GRM0332C1H9R0CA01# |        |               |         | 47pF    | ±2%                | GRM0332C1H470GA01# |       |     |  |       |     |                    |                    |
|        |               |         |        | ±0.5pF             | GRM0332C1H9R0DA01# |        |               |         |         | ±5%                | GRM0332C1H470JA01# |       |     |  |       |     |                    |                    |
|        |               |         | 9.1pF  | ±0.05pF            | GRM0332C1H9R1WA01# |        |               |         | 56pF    | ±2%                | GRM0332C1H560GA01# |       |     |  |       |     |                    |                    |
|        |               |         |        | ±0.1pF             | GRM0332C1H9R1BA01# |        |               |         |         | ±5%                | GRM0332C1H560JA01# |       |     |  |       |     |                    |                    |
|        |               |         |        | ±0.25pF            | GRM0332C1H9R1CA01# |        |               |         | 68pF    | ±2%                | GRM0332C1H680GA01# |       |     |  |       |     |                    |                    |
|        |               |         |        | ±0.5pF             | GRM0332C1H9R1DA01# |        |               |         |         | ±5%                | GRM0332C1H680JA01# |       |     |  |       |     |                    |                    |
|        |               |         | 9.2pF  | ±0.05pF            | GRM0332C1H9R2WA01# |        |               |         | 82pF    | ±2%                | GRM0332C1H820GA01# |       |     |  |       |     |                    |                    |
|        |               |         |        | ±0.1pF             | GRM0332C1H9R2BA01# |        |               |         |         | ±5%                | GRM0332C1H820JA01# |       |     |  |       |     |                    |                    |
|        |               |         |        | ±0.25pF            | GRM0332C1H9R2CA01# |        |               |         | 100pF   | ±2%                | GRM0332C1H101GA01# |       |     |  |       |     |                    |                    |
|        |               |         |        | ±0.5pF             | GRM0332C1H9R2DA01# |        |               |         |         | ±5%                | GRM0332C1H101JA01# |       |     |  |       |     |                    |                    |
|        |               |         | 9.3pF  | ±0.05pF            | GRM0332C1H9R3WA01# |        |               |         | 120pF   | ±2%                | GRM0332C1H121GA01# |       |     |  |       |     |                    |                    |
|        |               |         |        | ±0.1pF             | GRM0332C1H9R3BA01# |        |               |         |         | ±5%                | GRM0332C1H121JA01# |       |     |  |       |     |                    |                    |
|        |               |         |        | ±0.25pF            | GRM0332C1H9R3CA01# |        |               |         | 150pF   | ±2%                | GRM0332C1H151GA01# |       |     |  |       |     |                    |                    |
|        |               |         |        | ±0.5pF             | GRM0332C1H9R3DA01# |        |               |         |         | ±5%                | GRM0332C1H151JA01# |       |     |  |       |     |                    |                    |
|        |               |         | 9.4pF  | ±0.05pF            | GRM0332C1H9R4WA01# |        |               |         | 180pF   | ±2%                | GRM0332C1H181GA01# |       |     |  |       |     |                    |                    |
|        |               |         |        | ±0.1pF             | GRM0332C1H9R4BA01# |        |               |         |         | ±5%                | GRM0332C1H181JA01# |       |     |  |       |     |                    |                    |
|        |               |         |        | ±0.25pF            | GRM0332C1H9R4CA01# |        |               |         | 220pF   | ±2%                | GRM0332C1H221GA01# |       |     |  |       |     |                    |                    |
|        |               |         |        | ±0.5pF             | GRM0332C1H9R4DA01# |        |               |         |         | ±5%                | GRM0332C1H221JA01# |       |     |  |       |     |                    |                    |
|        |               |         | 9.5pF  | ±0.05pF            | GRM0332C1H9R5WA01# |        |               |         | 270pF   | ±2%                | GRM0335C1E271GA01# |       |     |  |       |     |                    |                    |
|        |               |         |        | ±0.1pF             | GRM0332C1H9R5BA01# |        |               |         |         |                    | GRM0335C1E271JA01# |       |     |  |       |     |                    |                    |
|        |               |         |        | ±0.25pF            | GRM0332C1H9R5CA01# |        |               |         |         |                    | GRM0335C1E331GA01# |       |     |  |       |     |                    |                    |
|        |               |         |        | ±0.5pF             | GRM0332C1H9R5DA01# |        |               |         |         |                    | GRM0335C1E331JA01# |       |     |  |       |     |                    |                    |
|        |               |         |        |                    |                    |        |               |         |         |                    |                    | 25Vdc | COG |  | 330pF | ±2% | GRM0335C1E331GA01# |                    |
|        |               |         |        |                    |                    |        |               |         |         |                    |                    |       |     |  |       |     | ±5%                | GRM0335C1E271JA01# |
|        |               |         |        |                    |                    |        |               |         |         |                    |                    |       |     |  |       |     | ±2%                | GRM0335C1E331GA01# |
|        |               |         |        |                    |                    |        |               |         |         |                    |                    |       |     |  |       |     | ±5%                | GRM0335C1E331JA01# |

GRM  
 GR3  
 GRJ  
 GR4  
 GR7  
 GJM  
 GQM  
 GA2  
 GA3 GB  
 GA3 GD  
 GA3 GF  
 LLL  
 LLA  
 LLM  
 LLR  
 NFM  
 KRM  
 KR3  
 GMA  
 GMD  
 ⚠Caution /Notice

Part number # indicates the package specification code.

# GRM Series Temperature Compensating Type Part Number List

(→ 0.6×0.3mm)

| T max. | Rated Voltage | TC Code | Cap.   | Tol.  | Part Number        |                    |
|--------|---------------|---------|--------|-------|--------------------|--------------------|
| 0.33mm | 25Vdc         | COG     | 390pF  | ±2%   | GRM0335C1E391GA01# |                    |
|        |               |         |        | ±5%   | GRM0335C1E391JA01# |                    |
|        |               |         | 470pF  | ±2%   | GRM0335C1E471GA01# |                    |
|        |               |         |        | ±5%   | GRM0335C1E471JA01# |                    |
|        |               |         | 560pF  | ±2%   | GRM0335C1E561GA01# |                    |
|        |               |         |        | ±5%   | GRM0335C1E561JA01# |                    |
|        |               |         | 680pF  | ±2%   | GRM0335C1E681GA01# |                    |
|        |               |         |        | ±5%   | GRM0335C1E681JA01# |                    |
|        |               |         | 820pF  | ±2%   | GRM0335C1E821GA01# |                    |
|        |               |         |        | ±5%   | GRM0335C1E821JA01# |                    |
|        |               |         | 910pF  | ±2%   | GRM0335C1E911GA01# |                    |
|        |               |         |        | ±5%   | GRM0335C1E911JA01# |                    |
|        |               |         | 1000pF | ±2%   | GRM0335C1E102GA01# |                    |
|        |               |         |        | ±5%   | GRM0335C1E102JA01# |                    |
|        |               |         | CH     | 270pF | ±2%                | GRM0332C1E271GA01# |
|        |               |         |        |       | ±5%                | GRM0332C1E271JA01# |
|        |               |         |        | 330pF | ±2%                | GRM0332C1E331GA01# |
|        |               |         |        |       | ±5%                | GRM0332C1E331JA01# |
|        |               |         |        | 390pF | ±2%                | GRM0332C1E391GA01# |
|        |               |         |        |       | ±5%                | GRM0332C1E391JA01# |
|        |               |         |        | 470pF | ±2%                | GRM0332C1E471GA01# |
|        |               | ±5%     |        |       | GRM0332C1E471JA01# |                    |
|        |               | 560pF   |        | ±2%   | GRM0332C1E561GA01# |                    |
|        |               |         |        | ±5%   | GRM0332C1E561JA01# |                    |
|        |               | 680pF   |        | ±2%   | GRM0332C1E681GA01# |                    |
|        |               |         |        | ±5%   | GRM0332C1E681JA01# |                    |
|        |               | 820pF   |        | ±2%   | GRM0332C1E821GA01# |                    |
|        |               |         |        | ±5%   | GRM0332C1E821JA01# |                    |
|        |               | 1000pF  |        | ±2%   | GRM0332C1E102GA01# |                    |
|        |               |         |        | ±5%   | GRM0332C1E102JA01# |                    |

| T max. | Rated Voltage | TC Code | Cap.  | Tol.    | Part Number        |
|--------|---------------|---------|-------|---------|--------------------|
| 0.55mm | 100Vdc        | COG     | 1.0pF | ±0.25pF | GRM1555C2A1ROCA01# |
|        |               |         |       | ±0.05pF | GRM1555C2A1R1WA01# |
|        |               |         |       |         | ±0.1pF             |
|        |               |         | 1.1pF | ±0.25pF | GRM1555C2A1R1CA01# |
|        |               |         |       | ±0.05pF | GRM1555C2A1R2WA01# |
|        |               |         |       |         | ±0.1pF             |
|        |               |         | 1.2pF | ±0.25pF | GRM1555C2A1R2CA01# |
|        |               |         |       | ±0.05pF | GRM1555C2A1R3WA01# |
|        |               |         |       |         | ±0.1pF             |
|        |               |         | 1.3pF | ±0.25pF | GRM1555C2A1R3CA01# |
|        |               |         |       | ±0.05pF | GRM1555C2A1R4WA01# |
|        |               |         |       |         | ±0.1pF             |
|        |               |         | 1.4pF | ±0.25pF | GRM1555C2A1R4CA01# |
|        |               |         |       | ±0.05pF | GRM1555C2A1R5WA01# |
|        |               |         |       |         | ±0.1pF             |
|        |               |         | 1.5pF | ±0.25pF | GRM1555C2A1R5CA01# |
|        |               |         |       | ±0.05pF | GRM1555C2A1R6WA01# |
|        |               |         |       |         | ±0.1pF             |
|        |               |         | 1.6pF | ±0.25pF | GRM1555C2A1R6CA01# |
|        |               |         |       | ±0.05pF | GRM1555C2A1R7WA01# |
|        |               |         |       |         | ±0.1pF             |
|        |               |         | 1.7pF | ±0.25pF | GRM1555C2A1R7CA01# |
|        |               |         |       | ±0.05pF | GRM1555C2A1R8WA01# |
|        |               |         |       |         | ±0.1pF             |
|        |               |         | 1.8pF | ±0.25pF | GRM1555C2A1R8CA01# |
|        |               |         |       | ±0.05pF | GRM1555C2A1R9WA01# |
|        |               |         |       |         | ±0.1pF             |
|        |               |         | 1.9pF | ±0.25pF | GRM1555C2A1R9CA01# |
|        |               |         |       | ±0.05pF | GRM1555C2A2R0WA01# |
|        |               |         |       |         | ±0.1pF             |
|        |               |         | 2.0pF | ±0.25pF | GRM1555C2A2R0CA01# |
|        |               |         |       | ±0.05pF | GRM1555C2A2R1WA01# |
|        |               |         |       |         | ±0.1pF             |
|        |               |         | 2.1pF | ±0.25pF | GRM1555C2A2R1CA01# |
|        |               |         |       | ±0.05pF | GRM1555C2A2R2WA01# |
|        |               |         |       |         | ±0.1pF             |
|        |               |         | 2.2pF | ±0.25pF | GRM1555C2A2R2CA01# |
|        |               |         |       | ±0.05pF | GRM1555C2A2R3WA01# |
|        |               |         |       |         | ±0.1pF             |
|        |               |         | 2.3pF | ±0.25pF | GRM1555C2A2R3CA01# |
|        |               |         |       | ±0.05pF | GRM1555C2A2R4WA01# |
|        |               |         |       |         | ±0.1pF             |
|        |               |         | 2.4pF | ±0.25pF | GRM1555C2A2R4CA01# |
|        |               |         |       | ±0.05pF | GRM1555C2A2R5WA01# |
|        |               |         |       |         | ±0.1pF             |
|        |               |         | 2.5pF | ±0.25pF | GRM1555C2A2R5CA01# |
|        |               |         |       | ±0.05pF | GRM1555C2A2R6WA01# |
|        |               |         |       |         | ±0.1pF             |
|        |               |         | 2.6pF | ±0.25pF | GRM1555C2A2R6CA01# |
|        |               |         |       | ±0.05pF | GRM1555C2A2R7WA01# |
|        |               |         |       |         | ±0.1pF             |
|        |               |         | 2.7pF | ±0.25pF | GRM1555C2A2R7CA01# |
|        |               |         |       | ±0.05pF | GRM1555C2A2R8WA01# |
|        |               |         |       |         | ±0.1pF             |

1.0×0.5mm

| T max. | Rated Voltage | TC Code | Cap.   | Tol.    | Part Number        |
|--------|---------------|---------|--------|---------|--------------------|
| 0.55mm | 100Vdc        | COG     | 0.10pF | ±0.05pF | GRM1555C2AR10WA01# |
|        |               |         |        | ±0.05pF | GRM1555C2AR20WA01# |
|        |               |         | 0.20pF | ±0.1pF  | GRM1555C2AR20BA01# |
|        |               |         |        | ±0.05pF | GRM1555C2AR30WA01# |
|        |               |         | 0.30pF | ±0.1pF  | GRM1555C2AR30BA01# |
|        |               |         |        | ±0.05pF | GRM1555C2AR40WA01# |
|        |               |         | 0.40pF | ±0.1pF  | GRM1555C2AR40BA01# |
|        |               |         |        | ±0.05pF | GRM1555C2AR50WA01# |
|        |               |         | 0.50pF | ±0.1pF  | GRM1555C2AR50BA01# |
|        |               |         |        | ±0.05pF | GRM1555C2AR60WA01# |
|        |               |         | 0.60pF | ±0.1pF  | GRM1555C2AR60BA01# |
|        |               |         |        | ±0.05pF | GRM1555C2AR70WA01# |
|        |               |         | 0.70pF | ±0.1pF  | GRM1555C2AR70BA01# |
|        |               |         |        | ±0.05pF | GRM1555C2AR80WA01# |
|        |               |         | 0.80pF | ±0.1pF  | GRM1555C2AR80BA01# |
|        |               |         |        | ±0.05pF | GRM1555C2AR90WA01# |
|        |               |         | 0.90pF | ±0.1pF  | GRM1555C2AR90BA01# |
|        |               |         |        | ±0.05pF | GRM1555C2A1R0WA01# |
|        |               |         | 1.0pF  | ±0.1pF  | GRM1555C2A1R0BA01# |

Part number # indicates the package specification code.

GRM  
 GR3  
 GRJ  
 GR4  
 GR7  
 GJM  
 GQM  
 GA2  
 GA3 GB  
 GA3 GD  
 GA3 GF  
 LLL  
 LLA  
 LLM  
 LLR  
 NFM  
 KRM  
 KR3  
 GMA  
 GMD  
 ⚠Caution /Notice

# GRM Series Temperature Compensating Type Part Number List

(→ 1.0×0.5mm)

| T max. | Rated Voltage | TC Code | Cap.    | Tol.    | Part Number        |
|--------|---------------|---------|---------|---------|--------------------|
| 0.55mm | 100Vdc        | COG     | 2.8pF   | ±0.25pF | GRM1555C2A2R8CA01# |
|        |               |         |         | ±0.05pF | GRM1555C2A2R9WA01# |
|        |               |         | 2.9pF   | ±0.1pF  | GRM1555C2A2R9BA01# |
|        |               |         |         | ±0.25pF | GRM1555C2A2R9CA01# |
|        |               |         |         | 3.0pF   | ±0.05pF            |
|        |               |         | ±0.1pF  |         | GRM1555C2A3R0BA01# |
|        |               |         | ±0.25pF |         | GRM1555C2A3R0CA01# |
|        |               |         | 3.1pF   | ±0.05pF | GRM1555C2A3R1WA01# |
|        |               |         |         | ±0.1pF  | GRM1555C2A3R1BA01# |
|        |               |         |         | ±0.25pF | GRM1555C2A3R1CA01# |
|        |               |         | 3.2pF   | ±0.05pF | GRM1555C2A3R2WA01# |
|        |               |         |         | ±0.1pF  | GRM1555C2A3R2BA01# |
|        |               |         |         | ±0.25pF | GRM1555C2A3R2CA01# |
|        |               |         | 3.3pF   | ±0.05pF | GRM1555C2A3R3WA01# |
|        |               |         |         | ±0.1pF  | GRM1555C2A3R3BA01# |
|        |               |         |         | ±0.25pF | GRM1555C2A3R3CA01# |
|        |               |         | 3.4pF   | ±0.05pF | GRM1555C2A3R4WA01# |
|        |               |         |         | ±0.1pF  | GRM1555C2A3R4BA01# |
|        |               |         |         | ±0.25pF | GRM1555C2A3R4CA01# |
|        |               |         | 3.5pF   | ±0.05pF | GRM1555C2A3R5WA01# |
|        |               |         |         | ±0.1pF  | GRM1555C2A3R5BA01# |
|        |               |         |         | ±0.25pF | GRM1555C2A3R5CA01# |
|        |               |         | 3.6pF   | ±0.05pF | GRM1555C2A3R6WA01# |
|        |               |         |         | ±0.1pF  | GRM1555C2A3R6BA01# |
|        |               |         |         | ±0.25pF | GRM1555C2A3R6CA01# |
|        |               |         | 3.7pF   | ±0.05pF | GRM1555C2A3R7WA01# |
|        |               |         |         | ±0.1pF  | GRM1555C2A3R7BA01# |
|        |               |         |         | ±0.25pF | GRM1555C2A3R7CA01# |
|        |               |         | 3.8pF   | ±0.05pF | GRM1555C2A3R8WA01# |
|        |               |         |         | ±0.1pF  | GRM1555C2A3R8BA01# |
|        |               |         |         | ±0.25pF | GRM1555C2A3R8CA01# |
|        |               |         | 3.9pF   | ±0.05pF | GRM1555C2A3R9WA01# |
|        |               |         |         | ±0.1pF  | GRM1555C2A3R9BA01# |
|        |               |         |         | ±0.25pF | GRM1555C2A3R9CA01# |
|        |               |         | 4.0pF   | ±0.05pF | GRM1555C2A4R0WA01# |
|        |               |         |         | ±0.1pF  | GRM1555C2A4R0BA01# |
|        |               |         |         | ±0.25pF | GRM1555C2A4R0CA01# |
|        |               |         | 4.1pF   | ±0.05pF | GRM1555C2A4R1WA01# |
|        |               |         |         | ±0.1pF  | GRM1555C2A4R1BA01# |
|        |               |         |         | ±0.25pF | GRM1555C2A4R1CA01# |
|        |               |         | 4.2pF   | ±0.05pF | GRM1555C2A4R2WA01# |
|        |               |         |         | ±0.1pF  | GRM1555C2A4R2BA01# |
|        |               |         |         | ±0.25pF | GRM1555C2A4R2CA01# |
|        |               |         | 4.3pF   | ±0.05pF | GRM1555C2A4R3WA01# |
|        |               |         |         | ±0.1pF  | GRM1555C2A4R3BA01# |
|        |               |         |         | ±0.25pF | GRM1555C2A4R3CA01# |
|        |               |         | 4.4pF   | ±0.05pF | GRM1555C2A4R4WA01# |
|        |               |         |         | ±0.1pF  | GRM1555C2A4R4BA01# |
|        |               |         |         | ±0.25pF | GRM1555C2A4R4CA01# |
|        |               |         | 4.5pF   | ±0.05pF | GRM1555C2A4R5WA01# |
|        |               |         |         | ±0.1pF  | GRM1555C2A4R5BA01# |
|        |               |         |         | ±0.25pF | GRM1555C2A4R5CA01# |
|        |               |         | 4.6pF   | ±0.05pF | GRM1555C2A4R6WA01# |
|        |               |         |         | ±0.1pF  | GRM1555C2A4R6BA01# |

| T max. | Rated Voltage | TC Code | Cap.    | Tol.    | Part Number        |
|--------|---------------|---------|---------|---------|--------------------|
| 0.55mm | 100Vdc        | COG     | 4.6pF   | ±0.25pF | GRM1555C2A4R6CA01# |
|        |               |         |         | ±0.05pF | GRM1555C2A4R7WA01# |
|        |               |         | 4.7pF   | ±0.1pF  | GRM1555C2A4R7BA01# |
|        |               |         |         | ±0.25pF | GRM1555C2A4R7CA01# |
|        |               |         |         | 4.8pF   | ±0.05pF            |
|        |               |         | ±0.1pF  |         | GRM1555C2A4R8BA01# |
|        |               |         | ±0.25pF |         | GRM1555C2A4R8CA01# |
|        |               |         | 4.9pF   | ±0.05pF | GRM1555C2A4R9WA01# |
|        |               |         |         | ±0.1pF  | GRM1555C2A4R9BA01# |
|        |               |         |         | ±0.25pF | GRM1555C2A4R9CA01# |
|        |               |         | 5.0pF   | ±0.05pF | GRM1555C2A5R0WA01# |
|        |               |         |         | ±0.1pF  | GRM1555C2A5R0BA01# |
|        |               |         |         | ±0.25pF | GRM1555C2A5R0CA01# |
|        |               |         | 5.1pF   | ±0.05pF | GRM1555C2A5R1WA01# |
|        |               |         |         | ±0.1pF  | GRM1555C2A5R1BA01# |
|        |               |         |         | ±0.25pF | GRM1555C2A5R1CA01# |
|        |               |         |         | ±0.5pF  | GRM1555C2A5R1DA01# |
|        |               |         |         | 5.2pF   | ±0.05pF            |
|        |               |         | ±0.1pF  |         | GRM1555C2A5R2BA01# |
|        |               |         | ±0.25pF |         | GRM1555C2A5R2CA01# |
|        |               |         | 5.3pF   | ±0.05pF | GRM1555C2A5R3WA01# |
|        |               |         |         | ±0.1pF  | GRM1555C2A5R3BA01# |
|        |               |         |         | ±0.25pF | GRM1555C2A5R3CA01# |
|        |               |         | 5.4pF   | ±0.05pF | GRM1555C2A5R4WA01# |
|        |               |         |         | ±0.1pF  | GRM1555C2A5R4BA01# |
|        |               |         |         | ±0.25pF | GRM1555C2A5R4CA01# |
|        |               |         | 5.5pF   | ±0.05pF | GRM1555C2A5R5WA01# |
|        |               |         |         | ±0.1pF  | GRM1555C2A5R5BA01# |
|        |               |         |         | ±0.25pF | GRM1555C2A5R5CA01# |
|        |               |         | 5.6pF   | ±0.05pF | GRM1555C2A5R6WA01# |
|        |               |         |         | ±0.1pF  | GRM1555C2A5R6BA01# |
|        |               |         |         | ±0.25pF | GRM1555C2A5R6CA01# |
|        |               |         | 5.7pF   | ±0.05pF | GRM1555C2A5R7WA01# |
|        |               |         |         | ±0.1pF  | GRM1555C2A5R7BA01# |
|        |               |         |         | ±0.25pF | GRM1555C2A5R7CA01# |
|        |               |         | 5.8pF   | ±0.05pF | GRM1555C2A5R8WA01# |
|        |               |         |         | ±0.1pF  | GRM1555C2A5R8BA01# |
|        |               |         |         | ±0.25pF | GRM1555C2A5R8CA01# |
|        |               |         | 5.9pF   | ±0.05pF | GRM1555C2A5R9WA01# |
|        |               |         |         | ±0.1pF  | GRM1555C2A5R9BA01# |
|        |               |         |         | ±0.25pF | GRM1555C2A5R9CA01# |
|        |               |         | 6.0pF   | ±0.05pF | GRM1555C2A6R0WA01# |
|        |               |         |         | ±0.1pF  | GRM1555C2A6R0BA01# |
|        |               |         |         | ±0.25pF | GRM1555C2A6R0CA01# |
|        |               |         | 6.1pF   | ±0.05pF | GRM1555C2A6R1WA01# |

- GRM
- GR3
- GRJ
- GR4
- GR7
- GJM
- GQM
- GA2
- GA3 GB
- GA3 GD
- GA3 GF
- LLL
- LLA
- LLM
- LLR
- NFM
- KRM
- KR3
- GMA
- GMD
- ⚠Caution /Notice

Part number # indicates the package specification code.

# GRM Series Temperature Compensating Type Part Number List

(→ 1.0×0.5mm)

| T max. | Rated Voltage | TC Code | Cap.  | Tol.    | Part Number        |
|--------|---------------|---------|-------|---------|--------------------|
| 0.55mm | 100Vdc        | COG     | 6.1pF | ±0.1pF  | GRM1555C2A6R1BA01# |
|        |               |         |       | ±0.25pF | GRM1555C2A6R1CA01# |
|        |               |         |       | ±0.5pF  | GRM1555C2A6R1DA01# |
|        |               |         | 6.2pF | ±0.05pF | GRM1555C2A6R2WA01# |
|        |               |         |       | ±0.1pF  | GRM1555C2A6R2BA01# |
|        |               |         |       | ±0.25pF | GRM1555C2A6R2CA01# |
|        |               |         | 6.3pF | ±0.05pF | GRM1555C2A6R3WA01# |
|        |               |         |       | ±0.1pF  | GRM1555C2A6R3BA01# |
|        |               |         |       | ±0.25pF | GRM1555C2A6R3CA01# |
|        |               |         | 6.4pF | ±0.05pF | GRM1555C2A6R4WA01# |
|        |               |         |       | ±0.1pF  | GRM1555C2A6R4BA01# |
|        |               |         |       | ±0.25pF | GRM1555C2A6R4CA01# |
|        |               |         | 6.5pF | ±0.05pF | GRM1555C2A6R5WA01# |
|        |               |         |       | ±0.1pF  | GRM1555C2A6R5BA01# |
|        |               |         |       | ±0.25pF | GRM1555C2A6R5CA01# |
|        |               |         | 6.6pF | ±0.05pF | GRM1555C2A6R6WA01# |
|        |               |         |       | ±0.1pF  | GRM1555C2A6R6BA01# |
|        |               |         |       | ±0.25pF | GRM1555C2A6R6CA01# |
|        |               |         | 6.7pF | ±0.05pF | GRM1555C2A6R7WA01# |
|        |               |         |       | ±0.1pF  | GRM1555C2A6R7BA01# |
|        |               |         |       | ±0.25pF | GRM1555C2A6R7CA01# |
|        |               |         | 6.8pF | ±0.05pF | GRM1555C2A6R8WA01# |
|        |               |         |       | ±0.1pF  | GRM1555C2A6R8BA01# |
|        |               |         |       | ±0.25pF | GRM1555C2A6R8CA01# |
|        |               |         | 6.9pF | ±0.05pF | GRM1555C2A6R9WA01# |
|        |               |         |       | ±0.1pF  | GRM1555C2A6R9BA01# |
|        |               |         |       | ±0.25pF | GRM1555C2A6R9CA01# |
|        |               |         | 7.0pF | ±0.05pF | GRM1555C2A7R0WA01# |
|        |               |         |       | ±0.1pF  | GRM1555C2A7R0BA01# |
|        |               |         |       | ±0.25pF | GRM1555C2A7R0CA01# |
|        |               |         | 7.1pF | ±0.05pF | GRM1555C2A7R1WA01# |
|        |               |         |       | ±0.1pF  | GRM1555C2A7R1BA01# |
|        |               |         |       | ±0.25pF | GRM1555C2A7R1CA01# |
|        |               |         | 7.2pF | ±0.05pF | GRM1555C2A7R2WA01# |
|        |               |         |       | ±0.1pF  | GRM1555C2A7R2BA01# |
|        |               |         |       | ±0.25pF | GRM1555C2A7R2CA01# |
|        |               |         | 7.3pF | ±0.05pF | GRM1555C2A7R3WA01# |
|        |               |         |       | ±0.1pF  | GRM1555C2A7R3BA01# |
|        |               |         |       | ±0.25pF | GRM1555C2A7R3CA01# |
|        |               |         | 7.4pF | ±0.05pF | GRM1555C2A7R4WA01# |
|        |               |         |       | ±0.1pF  | GRM1555C2A7R4BA01# |
|        |               |         |       | ±0.25pF | GRM1555C2A7R4CA01# |

| T max. | Rated Voltage | TC Code | Cap.  | Tol.    | Part Number        |
|--------|---------------|---------|-------|---------|--------------------|
| 0.55mm | 100Vdc        | COG     | 7.4pF | ±0.5pF  | GRM1555C2A7R4DA01# |
|        |               |         |       | ±0.05pF | GRM1555C2A7R5WA01# |
|        |               |         |       | ±0.1pF  | GRM1555C2A7R5BA01# |
|        |               |         | 7.5pF | ±0.25pF | GRM1555C2A7R5CA01# |
|        |               |         |       | ±0.5pF  | GRM1555C2A7R5DA01# |
|        |               |         |       | ±0.05pF | GRM1555C2A7R6WA01# |
|        |               |         | 7.6pF | ±0.1pF  | GRM1555C2A7R6BA01# |
|        |               |         |       | ±0.25pF | GRM1555C2A7R6CA01# |
|        |               |         |       | ±0.5pF  | GRM1555C2A7R6DA01# |
|        |               |         | 7.7pF | ±0.05pF | GRM1555C2A7R7WA01# |
|        |               |         |       | ±0.1pF  | GRM1555C2A7R7BA01# |
|        |               |         |       | ±0.25pF | GRM1555C2A7R7CA01# |
|        |               |         | 7.8pF | ±0.05pF | GRM1555C2A7R8WA01# |
|        |               |         |       | ±0.1pF  | GRM1555C2A7R8BA01# |
|        |               |         |       | ±0.25pF | GRM1555C2A7R8CA01# |
|        |               |         | 7.9pF | ±0.05pF | GRM1555C2A7R9WA01# |
|        |               |         |       | ±0.1pF  | GRM1555C2A7R9BA01# |
|        |               |         |       | ±0.25pF | GRM1555C2A7R9CA01# |
|        |               |         | 8.0pF | ±0.05pF | GRM1555C2A8R0WA01# |
|        |               |         |       | ±0.1pF  | GRM1555C2A8R0BA01# |
|        |               |         |       | ±0.25pF | GRM1555C2A8R0CA01# |
|        |               |         | 8.1pF | ±0.05pF | GRM1555C2A8R1WA01# |
|        |               |         |       | ±0.1pF  | GRM1555C2A8R1BA01# |
|        |               |         |       | ±0.25pF | GRM1555C2A8R1CA01# |
|        |               |         | 8.2pF | ±0.05pF | GRM1555C2A8R2WA01# |
|        |               |         |       | ±0.1pF  | GRM1555C2A8R2BA01# |
|        |               |         |       | ±0.25pF | GRM1555C2A8R2CA01# |
|        |               |         | 8.3pF | ±0.05pF | GRM1555C2A8R3WA01# |
|        |               |         |       | ±0.1pF  | GRM1555C2A8R3BA01# |
|        |               |         |       | ±0.25pF | GRM1555C2A8R3CA01# |
|        |               |         | 8.4pF | ±0.05pF | GRM1555C2A8R4WA01# |
|        |               |         |       | ±0.1pF  | GRM1555C2A8R4BA01# |
|        |               |         |       | ±0.25pF | GRM1555C2A8R4CA01# |
|        |               |         | 8.5pF | ±0.05pF | GRM1555C2A8R5WA01# |
|        |               |         |       | ±0.1pF  | GRM1555C2A8R5BA01# |
|        |               |         |       | ±0.25pF | GRM1555C2A8R5CA01# |
|        |               |         | 8.6pF | ±0.05pF | GRM1555C2A8R6WA01# |
|        |               |         |       | ±0.1pF  | GRM1555C2A8R6BA01# |
|        |               |         |       | ±0.25pF | GRM1555C2A8R6CA01# |
|        |               |         | 8.7pF | ±0.05pF | GRM1555C2A8R7WA01# |
|        |               |         |       | ±0.1pF  | GRM1555C2A8R7BA01# |
|        |               |         |       | ±0.25pF | GRM1555C2A8R7CA01# |
|        |               |         | 8.8pF | ±0.05pF | GRM1555C2A8R8WA01# |
|        |               |         |       | ±0.1pF  | GRM1555C2A8R8BA01# |
|        |               |         |       | ±0.25pF | GRM1555C2A8R8CA01# |

Part number # indicates the package specification code.



# GRM Series Temperature Compensating Type Part Number List

(→ 1.0×0.5mm)

| T max. | Rated Voltage | TC Code | Cap.   | Tol.               | Part Number        | T max. | Rated Voltage | TC Code | Cap.  | Tol.               | Part Number        |                    |                    |
|--------|---------------|---------|--------|--------------------|--------------------|--------|---------------|---------|-------|--------------------|--------------------|--------------------|--------------------|
| 0.55mm | 100Vdc        | COG     | 8.8pF  | ±0.1pF             | GRM1555C2A8R8BA01# | 0.55mm | 100Vdc        | COG     | 18pF  | ±5%                | GRM1555C2A180JA01# |                    |                    |
|        |               |         |        | ±0.25pF            | GRM1555C2A8R8CA01# |        |               |         |       | 22pF               | ±2%                | GRM1555C2A220GA01# |                    |
|        |               |         |        | ±0.5pF             | GRM1555C2A8R8DA01# |        |               |         |       |                    | ±5%                | GRM1555C2A220JA01# |                    |
|        |               |         | 8.9pF  | ±0.05pF            | GRM1555C2A8R9WA01# |        |               |         | 27pF  | ±2%                | GRM1555C2A270GA01# |                    |                    |
|        |               |         |        | ±0.1pF             | GRM1555C2A8R9BA01# |        |               |         |       | ±5%                | GRM1555C2A270JA01# |                    |                    |
|        |               |         |        | ±0.25pF            | GRM1555C2A8R9CA01# |        |               |         | 33pF  | ±2%                | GRM1555C2A330GA01# |                    |                    |
|        |               |         | ±0.5pF | GRM1555C2A8R9DA01# | ±5%                |        |               |         |       | GRM1555C2A330JA01# |                    |                    |                    |
|        |               |         | 9.0pF  | ±0.05pF            | GRM1555C2A9R0WA01# |        |               |         | 39pF  | ±2%                | GRM1555C2A390GA01# |                    |                    |
|        |               |         |        | ±0.1pF             | GRM1555C2A9R0BA01# |        |               |         |       | ±5%                | GRM1555C2A390JA01# |                    |                    |
|        |               |         |        | ±0.25pF            | GRM1555C2A9R0CA01# |        |               |         | 47pF  | ±2%                | GRM1555C2A470GA01# |                    |                    |
|        |               |         |        | ±0.5pF             | GRM1555C2A9R0DA01# |        |               |         |       | ±5%                | GRM1555C2A470JA01# |                    |                    |
|        |               |         | 9.1pF  | ±0.05pF            | GRM1555C2A9R1WA01# |        |               |         | 56pF  | ±2%                | GRM1555C2A560GA01# |                    |                    |
|        |               |         |        | ±0.1pF             | GRM1555C2A9R1BA01# |        |               |         |       | ±5%                | GRM1555C2A560JA01# |                    |                    |
|        |               |         |        | ±0.25pF            | GRM1555C2A9R1CA01# |        |               |         | 68pF  | ±2%                | GRM1555C2A680GA01# |                    |                    |
|        |               |         |        | ±0.5pF             | GRM1555C2A9R1DA01# |        |               |         |       | ±5%                | GRM1555C2A680JA01# |                    |                    |
|        |               |         | 9.2pF  | ±0.05pF            | GRM1555C2A9R2WA01# |        |               |         | 82pF  | ±2%                | GRM1555C2A820GA01# |                    |                    |
|        |               |         |        | ±0.1pF             | GRM1555C2A9R2BA01# |        |               |         |       | ±5%                | GRM1555C2A820JA01# |                    |                    |
|        |               |         |        | ±0.25pF            | GRM1555C2A9R2CA01# |        |               |         | 100pF | ±2%                | GRM1555C2A101GA01# |                    |                    |
|        |               |         |        | ±0.5pF             | GRM1555C2A9R2DA01# |        |               |         |       | ±5%                | GRM1555C2A101JA01# |                    |                    |
|        |               |         | 9.3pF  | ±0.05pF            | GRM1555C2A9R3WA01# |        |               |         | CK    | ±0.05pF            | GRM1554C2AR10WA01# |                    |                    |
|        |               |         |        | ±0.1pF             | GRM1555C2A9R3BA01# |        |               |         |       | ±0.05pF            | GRM1554C2AR20WA01# |                    |                    |
|        |               |         |        | ±0.25pF            | GRM1555C2A9R3CA01# |        |               |         |       | ±0.1pF             | GRM1554C2AR20BA01# |                    |                    |
|        |               |         |        | ±0.5pF             | GRM1555C2A9R3DA01# |        |               |         |       | 0.30pF             | ±0.05pF            | GRM1554C2AR30WA01# |                    |
|        |               |         | 9.4pF  | ±0.05pF            | GRM1555C2A9R4WA01# |        |               |         |       |                    | ±0.1pF             | GRM1554C2AR30BA01# |                    |
|        |               |         |        | ±0.1pF             | GRM1555C2A9R4BA01# |        |               |         |       | 0.40pF             | ±0.05pF            | GRM1554C2AR40WA01# |                    |
|        |               |         |        | ±0.25pF            | GRM1555C2A9R4CA01# |        |               |         |       |                    | ±0.1pF             | GRM1554C2AR40BA01# |                    |
|        |               |         | ±0.5pF | GRM1555C2A9R4DA01# | 0.50pF             |        |               |         |       | ±0.05pF            | GRM1554C2AR50WA01# |                    |                    |
|        |               |         | 9.5pF  | ±0.05pF            |                    |        |               |         |       | GRM1555C2A9R5WA01# | ±0.1pF             | GRM1554C2AR50BA01# |                    |
|        |               |         |        | ±0.1pF             | GRM1555C2A9R5BA01# |        |               |         |       | 0.60pF             | ±0.05pF            | GRM1554C2AR60WA01# |                    |
|        |               |         |        | ±0.25pF            | GRM1555C2A9R5CA01# |        |               |         |       |                    | ±0.1pF             | GRM1554C2AR60BA01# |                    |
|        |               |         | ±0.5pF | GRM1555C2A9R5DA01# | 0.70pF             |        |               |         |       | ±0.05pF            | GRM1554C2AR70WA01# |                    |                    |
|        |               |         | 9.6pF  | ±0.05pF            |                    |        |               |         |       | GRM1555C2A9R6WA01# | ±0.1pF             | GRM1554C2AR70BA01# |                    |
|        |               |         |        | ±0.1pF             | GRM1555C2A9R6BA01# |        |               |         |       | 0.80pF             | ±0.05pF            | GRM1554C2AR80WA01# |                    |
|        |               |         |        | ±0.25pF            | GRM1555C2A9R6CA01# |        |               |         |       |                    | ±0.1pF             | GRM1554C2AR80BA01# |                    |
|        |               |         | ±0.5pF | GRM1555C2A9R6DA01# | 0.90pF             |        |               |         |       | ±0.05pF            | GRM1554C2AR90WA01# |                    |                    |
|        |               |         | 9.7pF  | ±0.05pF            |                    |        |               |         |       | GRM1555C2A9R7WA01# | ±0.1pF             | GRM1554C2AR90BA01# |                    |
|        |               |         |        | ±0.1pF             | GRM1555C2A9R7BA01# |        |               |         |       | 1.0pF              | ±0.05pF            | GRM1554C2A1R0WA01# |                    |
|        |               |         |        | ±0.25pF            | GRM1555C2A9R7CA01# |        |               |         |       |                    | ±0.1pF             | GRM1554C2A1R0BA01# |                    |
|        |               |         | ±0.5pF | GRM1555C2A9R7DA01# | ±0.25pF            |        |               |         |       | GRM1554C2A1ROCA01# | 1.1pF              | ±0.05pF            | GRM1554C2A1R1WA01# |
|        |               |         | 9.8pF  | ±0.05pF            | GRM1555C2A9R8WA01# |        |               |         |       | ±0.1pF             |                    | GRM1554C2A1R1BA01# |                    |
|        |               |         |        | ±0.1pF             | GRM1555C2A9R8BA01# |        |               |         |       | ±0.25pF            |                    | GRM1554C2A1R1CA01# |                    |
|        |               |         |        | ±0.25pF            | GRM1555C2A9R8CA01# |        |               |         |       | 1.2pF              | ±0.05pF            | GRM1554C2A1R2WA01# |                    |
|        |               |         | ±0.5pF | GRM1555C2A9R8DA01# | ±0.1pF             |        |               |         |       |                    | GRM1554C2A1R2BA01# |                    |                    |
|        |               |         | 9.9pF  | ±0.05pF            | GRM1555C2A9R9WA01# |        |               |         |       | ±0.25pF            | GRM1554C2A1R2CA01# |                    |                    |
|        |               |         |        | ±0.1pF             | GRM1555C2A9R9BA01# |        |               |         |       | 1.3pF              | ±0.05pF            | GRM1554C2A1R3WA01# |                    |
|        |               |         |        | ±0.25pF            | GRM1555C2A9R9CA01# |        |               |         |       |                    | ±0.1pF             | GRM1554C2A1R3BA01# |                    |
|        |               |         | ±0.5pF | GRM1555C2A9R9DA01# | 1.4pF              |        |               |         |       | ±0.25pF            | GRM1554C2A1R3CA01# |                    |                    |
|        |               |         | 10pF   | ±2%                |                    |        |               |         |       | GRM1555C2A100GA01# | ±0.05pF            | GRM1554C2A1R4WA01# |                    |
|        |               |         |        | ±5%                | GRM1555C2A100JA01# |        |               |         |       | ±0.1pF             | GRM1554C2A1R4BA01# |                    |                    |
|        |               |         | 12pF   | ±2%                | GRM1555C2A120GA01# |        |               |         |       | ±0.25pF            | GRM1554C2A1R4CA01# |                    |                    |
|        |               |         |        | ±5%                | GRM1555C2A120JA01# |        |               |         |       | 1.5pF              | ±0.05pF            | GRM1554C2A1R5WA01# |                    |
|        |               |         | 15pF   | ±2%                | GRM1555C2A150GA01# |        |               |         |       |                    | ±0.1pF             | GRM1554C2A1R5BA01# |                    |
|        |               |         |        | ±5%                | GRM1555C2A150JA01# |        |               |         |       | ±0.25pF            | GRM1554C2A1R5CA01# |                    |                    |
|        |               |         | 18pF   | ±2%                | GRM1555C2A180GA01# |        |               |         |       |                    |                    |                    |                    |

- GRM
- GR3
- GRJ
- GR4
- GR7
- GJM
- GQM
- GA2
- GA3 GB
- GA3 GD
- GA3 GF
- LLL
- LLA
- LLM
- LLR
- NFM
- KRM
- KR3
- GMA
- GMD
- ⚠Caution /Notice

Part number # indicates the package specification code.



# GRM Series Temperature Compensating Type Part Number List

(→ 1.0×0.5mm)

| T max. | Rated Voltage | TC Code | Cap.    | Tol.               | Part Number        | T max. | Rated Voltage | TC Code            | Cap.               | Tol.    | Part Number        |         |                    |
|--------|---------------|---------|---------|--------------------|--------------------|--------|---------------|--------------------|--------------------|---------|--------------------|---------|--------------------|
| 0.55mm | 100Vdc        | CK      | 1.6pF   | ±0.05pF            | GRM1554C2A1R6WA01# | 0.55mm | 100Vdc        | CJ                 | 3.4pF              | ±0.05pF | GRM1553C2A3R4WA01# |         |                    |
|        |               |         |         | ±0.1pF             | GRM1554C2A1R6BA01# |        |               |                    |                    | ±0.1pF  | GRM1553C2A3R4BA01# |         |                    |
|        |               |         |         | ±0.25pF            | GRM1554C2A1R6CA01# |        |               |                    |                    | ±0.25pF | GRM1553C2A3R4CA01# |         |                    |
|        |               |         | 1.7pF   | ±0.05pF            | GRM1554C2A1R7WA01# |        |               |                    | 3.5pF              | ±0.05pF | GRM1553C2A3R5WA01# |         |                    |
|        |               |         |         | ±0.1pF             | GRM1554C2A1R7BA01# |        |               |                    |                    | ±0.1pF  | GRM1553C2A3R5BA01# |         |                    |
|        |               |         |         | ±0.25pF            | GRM1554C2A1R7CA01# |        |               |                    |                    | ±0.25pF | GRM1553C2A3R5CA01# |         |                    |
|        |               |         | 1.8pF   | ±0.05pF            | GRM1554C2A1R8WA01# |        |               |                    | 3.6pF              | ±0.05pF | GRM1553C2A3R6WA01# |         |                    |
|        |               |         |         | ±0.1pF             | GRM1554C2A1R8BA01# |        |               |                    |                    | ±0.1pF  | GRM1553C2A3R6BA01# |         |                    |
|        |               |         |         | ±0.25pF            | GRM1554C2A1R8CA01# |        |               |                    |                    | ±0.25pF | GRM1553C2A3R6CA01# |         |                    |
|        |               |         | 1.9pF   | ±0.05pF            | GRM1554C2A1R9WA01# |        |               |                    | 3.7pF              | ±0.05pF | GRM1553C2A3R7WA01# |         |                    |
|        |               |         |         | ±0.1pF             | GRM1554C2A1R9BA01# |        |               |                    |                    | ±0.1pF  | GRM1553C2A3R7BA01# |         |                    |
|        |               |         |         | ±0.25pF            | GRM1554C2A1R9CA01# |        |               |                    |                    | ±0.25pF | GRM1553C2A3R7CA01# |         |                    |
|        |               |         | 2.0pF   | ±0.05pF            | GRM1554C2A2R0WA01# |        |               |                    | 3.8pF              | ±0.05pF | GRM1553C2A3R8WA01# |         |                    |
|        |               |         |         | ±0.1pF             | GRM1554C2A2R0BA01# |        |               |                    |                    | ±0.1pF  | GRM1553C2A3R8BA01# |         |                    |
|        |               |         |         | ±0.25pF            | GRM1554C2A2R0CA01# |        |               |                    |                    | ±0.25pF | GRM1553C2A3R8CA01# |         |                    |
|        |               |         | CJ      | 2.1pF              | ±0.05pF            |        |               |                    | GRM1553C2A2R1WA01# | CH      | 4.0pF              | ±0.05pF | GRM1552C2A4R0WA01# |
|        |               |         |         |                    | ±0.1pF             |        |               |                    | GRM1553C2A2R1BA01# |         |                    | ±0.1pF  | GRM1552C2A4R0BA01# |
|        |               |         |         |                    | ±0.25pF            |        |               |                    | GRM1553C2A2R1CA01# |         |                    | ±0.25pF | GRM1552C2A4R0CA01# |
|        |               |         |         | 2.2pF              | ±0.05pF            |        |               |                    | GRM1553C2A2R2WA01# |         | 4.1pF              | ±0.05pF | GRM1552C2A4R1WA01# |
|        |               |         |         |                    | ±0.1pF             |        |               |                    | GRM1553C2A2R2BA01# |         |                    | ±0.1pF  | GRM1552C2A4R1BA01# |
|        |               |         |         |                    | ±0.25pF            |        |               |                    | GRM1553C2A2R2CA01# |         |                    | ±0.25pF | GRM1552C2A4R1CA01# |
|        |               |         |         | 2.3pF              | ±0.05pF            |        |               |                    | GRM1553C2A2R3WA01# |         | 4.2pF              | ±0.05pF | GRM1552C2A4R2WA01# |
|        |               |         |         |                    | ±0.1pF             |        |               |                    | GRM1553C2A2R3BA01# |         |                    | ±0.1pF  | GRM1552C2A4R2BA01# |
|        |               |         |         |                    | ±0.25pF            |        |               |                    | GRM1553C2A2R3CA01# |         |                    | ±0.25pF | GRM1552C2A4R2CA01# |
|        |               |         |         | 2.4pF              | ±0.05pF            |        |               |                    | GRM1553C2A2R4WA01# |         | 4.3pF              | ±0.05pF | GRM1552C2A4R3WA01# |
|        |               |         |         |                    | ±0.1pF             |        |               |                    | GRM1553C2A2R4BA01# |         |                    | ±0.1pF  | GRM1552C2A4R3BA01# |
|        |               |         |         |                    | ±0.25pF            |        |               |                    | GRM1553C2A2R4CA01# |         |                    | ±0.25pF | GRM1552C2A4R3CA01# |
|        |               |         |         | 2.5pF              | ±0.05pF            |        |               |                    | GRM1553C2A2R5WA01# |         | 4.4pF              | ±0.05pF | GRM1552C2A4R4WA01# |
|        |               |         |         |                    | ±0.1pF             |        |               |                    | GRM1553C2A2R5BA01# |         |                    | ±0.1pF  | GRM1552C2A4R4BA01# |
|        |               |         |         |                    | ±0.25pF            |        |               |                    | GRM1553C2A2R5CA01# |         |                    | ±0.25pF | GRM1552C2A4R4CA01# |
|        |               |         |         | 2.6pF              | ±0.05pF            |        |               |                    | GRM1553C2A2R6WA01# |         | 4.5pF              | ±0.05pF | GRM1552C2A4R5WA01# |
|        |               |         |         |                    | ±0.1pF             |        |               |                    | GRM1553C2A2R6BA01# |         |                    | ±0.1pF  | GRM1552C2A4R5BA01# |
|        |               |         |         |                    | ±0.25pF            |        |               |                    | GRM1553C2A2R6CA01# |         |                    | ±0.25pF | GRM1552C2A4R5CA01# |
|        |               |         |         | 2.7pF              | ±0.05pF            |        |               |                    | GRM1553C2A2R7WA01# |         | 4.6pF              | ±0.05pF | GRM1552C2A4R6WA01# |
|        |               |         |         |                    | ±0.1pF             |        |               |                    | GRM1553C2A2R7BA01# |         |                    | ±0.1pF  | GRM1552C2A4R6BA01# |
|        |               |         |         |                    | ±0.25pF            |        |               |                    | GRM1553C2A2R7CA01# |         |                    | ±0.25pF | GRM1552C2A4R6CA01# |
|        |               | 2.8pF   |         | ±0.05pF            | GRM1553C2A2R8WA01# | 4.7pF  | ±0.05pF       | GRM1552C2A4R7WA01# |                    |         |                    |         |                    |
|        |               |         |         | ±0.1pF             | GRM1553C2A2R8BA01# |        | ±0.1pF        | GRM1552C2A4R7BA01# |                    |         |                    |         |                    |
|        |               |         |         | ±0.25pF            | GRM1553C2A2R8CA01# |        | ±0.25pF       | GRM1552C2A4R7CA01# |                    |         |                    |         |                    |
|        |               | 2.9pF   |         | ±0.05pF            | GRM1553C2A2R9WA01# | 4.8pF  | ±0.05pF       | GRM1552C2A4R8WA01# |                    |         |                    |         |                    |
|        |               |         |         | ±0.1pF             | GRM1553C2A2R9BA01# |        | ±0.1pF        | GRM1552C2A4R8BA01# |                    |         |                    |         |                    |
|        |               |         |         | ±0.25pF            | GRM1553C2A2R9CA01# |        | ±0.25pF       | GRM1552C2A4R8CA01# |                    |         |                    |         |                    |
|        |               | 3.0pF   |         | ±0.05pF            | GRM1553C2A3R0WA01# | 5.0pF  | ±0.05pF       | GRM1552C2A5R0WA01# |                    |         |                    |         |                    |
|        |               |         |         | ±0.1pF             | GRM1553C2A3R0BA01# |        | ±0.1pF        | GRM1552C2A5R0BA01# |                    |         |                    |         |                    |
|        |               |         |         | ±0.25pF            | GRM1553C2A3R0CA01# |        | ±0.25pF       | GRM1552C2A5R0CA01# |                    |         |                    |         |                    |
|        |               | 3.1pF   |         | ±0.05pF            | GRM1553C2A3R1WA01# |        | 5.1pF         | ±0.05pF            | GRM1552C2A5R1WA01# |         |                    |         |                    |
|        |               |         |         | ±0.1pF             | GRM1553C2A3R1BA01# |        |               | ±0.1pF             | GRM1552C2A5R1BA01# |         |                    |         |                    |
|        |               |         |         | ±0.25pF            | GRM1553C2A3R1CA01# |        |               | ±0.25pF            | GRM1552C2A5R1CA01# |         |                    |         |                    |
|        |               | 3.2pF   |         | ±0.05pF            | GRM1553C2A3R2WA01# |        |               |                    |                    |         |                    |         |                    |
|        |               |         |         | ±0.1pF             | GRM1553C2A3R2BA01# |        |               |                    |                    |         |                    |         |                    |
|        |               |         |         | ±0.25pF            | GRM1553C2A3R2CA01# |        |               |                    |                    |         |                    |         |                    |
|        |               | 3.3pF   | ±0.05pF | GRM1553C2A3R3WA01# |                    |        |               |                    |                    |         |                    |         |                    |
|        |               |         | ±0.1pF  | GRM1553C2A3R3BA01# |                    |        |               |                    |                    |         |                    |         |                    |
|        |               |         | ±0.25pF | GRM1553C2A3R3CA01# |                    |        |               |                    |                    |         |                    |         |                    |

Part number # indicates the package specification code.



# GRM Series Temperature Compensating Type Part Number List

(→ 1.0×0.5mm)

| T max. | Rated Voltage | TC Code | Cap.  | Tol.    | Part Number        | T max. | Rated Voltage | TC Code | Cap.  | Tol.    | Part Number        |
|--------|---------------|---------|-------|---------|--------------------|--------|---------------|---------|-------|---------|--------------------|
| 0.55mm | 100Vdc        | CH      | 5.1pF | ±0.5pF  | GRM1552C2A5R1DA01# | 0.55mm | 100Vdc        | CH      | 6.5pF | ±0.1pF  | GRM1552C2A6R5BA01# |
|        |               |         |       | ±0.05pF | GRM1552C2A5R2WA01# |        |               |         |       | ±0.25pF | GRM1552C2A6R5CA01# |
|        |               |         |       | ±0.1pF  | GRM1552C2A5R2BA01# |        |               |         |       | ±0.5pF  | GRM1552C2A6R5DA01# |
|        |               |         | 5.2pF | ±0.25pF | GRM1552C2A5R2CA01# |        |               |         | 6.6pF | ±0.05pF | GRM1552C2A6R6WA01# |
|        |               |         |       | ±0.5pF  | GRM1552C2A5R2DA01# |        |               |         |       | ±0.1pF  | GRM1552C2A6R6BA01# |
|        |               |         |       | ±0.05pF | GRM1552C2A5R3WA01# |        |               |         |       | ±0.25pF | GRM1552C2A6R6CA01# |
|        |               |         |       | ±0.1pF  | GRM1552C2A5R3BA01# |        |               |         |       | ±0.5pF  | GRM1552C2A6R6DA01# |
|        |               |         | 5.3pF | ±0.25pF | GRM1552C2A5R3CA01# |        |               |         | 6.7pF | ±0.05pF | GRM1552C2A6R7WA01# |
|        |               |         |       | ±0.5pF  | GRM1552C2A5R3DA01# |        |               |         |       | ±0.1pF  | GRM1552C2A6R7BA01# |
|        |               |         |       | ±0.05pF | GRM1552C2A5R4WA01# |        |               |         |       | ±0.25pF | GRM1552C2A6R7CA01# |
|        |               |         |       | ±0.1pF  | GRM1552C2A5R4BA01# |        |               |         |       | ±0.5pF  | GRM1552C2A6R7DA01# |
|        |               |         | 5.4pF | ±0.25pF | GRM1552C2A5R4CA01# |        |               |         | 6.8pF | ±0.05pF | GRM1552C2A6R8WA01# |
|        |               |         |       | ±0.5pF  | GRM1552C2A5R4DA01# |        |               |         |       | ±0.1pF  | GRM1552C2A6R8BA01# |
|        |               |         |       | ±0.05pF | GRM1552C2A5R5WA01# |        |               |         |       | ±0.25pF | GRM1552C2A6R8CA01# |
|        |               |         |       | ±0.1pF  | GRM1552C2A5R5BA01# |        |               |         |       | ±0.5pF  | GRM1552C2A6R8DA01# |
|        |               |         | 5.5pF | ±0.25pF | GRM1552C2A5R5CA01# |        |               |         | 6.9pF | ±0.05pF | GRM1552C2A6R9WA01# |
|        |               |         |       | ±0.5pF  | GRM1552C2A5R5DA01# |        |               |         |       | ±0.1pF  | GRM1552C2A6R9BA01# |
|        |               |         |       | ±0.05pF | GRM1552C2A5R6WA01# |        |               |         |       | ±0.25pF | GRM1552C2A6R9CA01# |
|        |               |         |       | ±0.1pF  | GRM1552C2A5R6BA01# |        |               |         |       | ±0.5pF  | GRM1552C2A6R9DA01# |
|        |               |         | 5.6pF | ±0.25pF | GRM1552C2A5R6CA01# |        |               |         | 7.0pF | ±0.05pF | GRM1552C2A7R0WA01# |
|        |               |         |       | ±0.5pF  | GRM1552C2A5R6DA01# |        |               |         |       | ±0.1pF  | GRM1552C2A7R0BA01# |
|        |               |         |       | ±0.05pF | GRM1552C2A5R7WA01# |        |               |         |       | ±0.25pF | GRM1552C2A7R0CA01# |
|        |               |         |       | ±0.1pF  | GRM1552C2A5R7BA01# |        |               |         |       | ±0.5pF  | GRM1552C2A7R0DA01# |
|        |               |         | 5.7pF | ±0.25pF | GRM1552C2A5R7CA01# |        |               |         | 7.1pF | ±0.05pF | GRM1552C2A7R1WA01# |
|        |               |         |       | ±0.5pF  | GRM1552C2A5R7DA01# |        |               |         |       | ±0.1pF  | GRM1552C2A7R1BA01# |
|        |               |         |       | ±0.05pF | GRM1552C2A5R8WA01# |        |               |         |       | ±0.25pF | GRM1552C2A7R1CA01# |
|        |               |         |       | ±0.1pF  | GRM1552C2A5R8BA01# |        |               |         |       | ±0.5pF  | GRM1552C2A7R1DA01# |
|        |               |         | 5.8pF | ±0.25pF | GRM1552C2A5R8CA01# |        |               |         | 7.2pF | ±0.05pF | GRM1552C2A7R2WA01# |
|        |               |         |       | ±0.5pF  | GRM1552C2A5R8DA01# |        |               |         |       | ±0.1pF  | GRM1552C2A7R2BA01# |
|        |               |         |       | ±0.05pF | GRM1552C2A5R9WA01# |        |               |         |       | ±0.25pF | GRM1552C2A7R2CA01# |
|        |               |         |       | ±0.1pF  | GRM1552C2A5R9BA01# |        |               |         |       | ±0.5pF  | GRM1552C2A7R2DA01# |
|        |               |         | 5.9pF | ±0.25pF | GRM1552C2A5R9CA01# |        |               |         | 7.3pF | ±0.05pF | GRM1552C2A7R3WA01# |
|        |               |         |       | ±0.5pF  | GRM1552C2A5R9DA01# |        |               |         |       | ±0.1pF  | GRM1552C2A7R3BA01# |
|        |               |         |       | ±0.05pF | GRM1552C2A6R0WA01# |        |               |         |       | ±0.25pF | GRM1552C2A7R3CA01# |
|        |               |         |       | ±0.1pF  | GRM1552C2A6R0BA01# |        |               |         |       | ±0.5pF  | GRM1552C2A7R3DA01# |
|        |               |         | 6.0pF | ±0.25pF | GRM1552C2A6R0CA01# |        |               |         | 7.4pF | ±0.05pF | GRM1552C2A7R4WA01# |
|        |               |         |       | ±0.5pF  | GRM1552C2A6R0DA01# |        |               |         |       | ±0.1pF  | GRM1552C2A7R4BA01# |
|        |               |         |       | ±0.05pF | GRM1552C2A6R1WA01# |        |               |         |       | ±0.25pF | GRM1552C2A7R4CA01# |
|        |               |         |       | ±0.1pF  | GRM1552C2A6R1BA01# |        |               |         |       | ±0.5pF  | GRM1552C2A7R4DA01# |
|        |               |         | 6.1pF | ±0.25pF | GRM1552C2A6R1CA01# |        |               |         | 7.5pF | ±0.05pF | GRM1552C2A7R5WA01# |
|        |               |         |       | ±0.5pF  | GRM1552C2A6R1DA01# |        |               |         |       | ±0.1pF  | GRM1552C2A7R5BA01# |
|        |               |         |       | ±0.05pF | GRM1552C2A6R2WA01# |        |               |         |       | ±0.25pF | GRM1552C2A7R5CA01# |
|        |               |         |       | ±0.1pF  | GRM1552C2A6R2BA01# |        |               |         |       | ±0.5pF  | GRM1552C2A7R5DA01# |
|        |               |         | 6.2pF | ±0.25pF | GRM1552C2A6R2CA01# |        |               |         | 7.6pF | ±0.05pF | GRM1552C2A7R6WA01# |
|        |               |         |       | ±0.5pF  | GRM1552C2A6R2DA01# |        |               |         |       | ±0.1pF  | GRM1552C2A7R6BA01# |
|        |               |         |       | ±0.05pF | GRM1552C2A6R3WA01# |        |               |         |       | ±0.25pF | GRM1552C2A7R6CA01# |
|        |               |         |       | ±0.1pF  | GRM1552C2A6R3BA01# |        |               |         |       | ±0.5pF  | GRM1552C2A7R6DA01# |
|        |               |         | 6.3pF | ±0.25pF | GRM1552C2A6R3CA01# |        |               |         | 7.7pF | ±0.05pF | GRM1552C2A7R7WA01# |
|        |               |         |       | ±0.5pF  | GRM1552C2A6R3DA01# |        |               |         |       | ±0.1pF  | GRM1552C2A7R7BA01# |
|        |               |         |       | ±0.05pF | GRM1552C2A6R4WA01# |        |               |         |       | ±0.25pF | GRM1552C2A7R7CA01# |
|        |               |         |       | ±0.1pF  | GRM1552C2A6R4BA01# |        |               |         |       | ±0.5pF  | GRM1552C2A7R7DA01# |
|        |               |         | 6.4pF | ±0.25pF | GRM1552C2A6R4CA01# |        |               |         | 7.8pF | ±0.05pF | GRM1552C2A7R8WA01# |
|        |               |         |       | ±0.5pF  | GRM1552C2A6R4DA01# |        |               |         |       | ±0.1pF  | GRM1552C2A7R8BA01# |
|        |               |         |       | ±0.05pF | GRM1552C2A6R5WA01# |        |               |         |       | ±0.25pF | GRM1552C2A7R8CA01# |
|        |               |         |       | ±0.1pF  | GRM1552C2A6R5BA01# |        |               |         |       |         |                    |

GRM  
 GR3  
 GRJ  
 GR4  
 GR7  
 GJM  
 GQM  
 GA2  
 GA3 GB  
 GA3 GD  
 GA3 GF  
 LLL  
 LLA  
 LLM  
 LLR  
 NFM  
 KRM  
 KR3  
 GMA  
 GMD  
 ⚠Caution /Notice

Part number # indicates the package specification code.

# GRM Series Temperature Compensating Type Part Number List

(→ 1.0×0.5mm)

| T max. | Rated Voltage | TC Code | Cap.    | Tol.               | Part Number        | T max. | Rated Voltage | TC Code | Cap.   | Tol.               | Part Number        |
|--------|---------------|---------|---------|--------------------|--------------------|--------|---------------|---------|--------|--------------------|--------------------|
| 0.55mm | 100Vdc        | CH      | 7.8pF   | ±0.5pF             | GRM1552C2A7R8DA01# | 0.55mm | 100Vdc        | CH      | 9.2pF  | ±0.1pF             | GRM1552C2A9R2BA01# |
|        |               |         |         | ±0.05pF            | GRM1552C2A7R9WA01# |        |               |         |        | ±0.25pF            | GRM1552C2A9R2CA01# |
|        |               |         | 7.9pF   | ±0.1pF             | GRM1552C2A7R9BA01# |        |               |         | ±0.5pF | GRM1552C2A9R2DA01# |                    |
|        |               |         |         | ±0.25pF            | GRM1552C2A7R9CA01# |        |               |         | 9.3pF  | ±0.05pF            | GRM1552C2A9R3WA01# |
|        |               |         |         | ±0.5pF             | GRM1552C2A7R9DA01# |        |               |         |        | ±0.1pF             | GRM1552C2A9R3BA01# |
|        |               |         |         | 8.0pF              | ±0.05pF            |        |               |         |        | GRM1552C2A8R0WA01# | ±0.25pF            |
|        |               |         | ±0.1pF  |                    | GRM1552C2A8R0BA01# |        |               |         | ±0.5pF | GRM1552C2A9R3DA01# |                    |
|        |               |         | ±0.25pF |                    | GRM1552C2A8R0CA01# |        |               |         | 9.4pF  | ±0.05pF            | GRM1552C2A9R4WA01# |
|        |               |         | ±0.5pF  | GRM1552C2A8R0DA01# | ±0.1pF             |        |               |         |        | GRM1552C2A9R4BA01# |                    |
|        |               |         | 8.1pF   | ±0.05pF            | GRM1552C2A8R1WA01# |        |               |         |        | ±0.25pF            | GRM1552C2A9R4CA01# |
|        |               |         |         | ±0.1pF             | GRM1552C2A8R1BA01# |        |               |         | ±0.5pF | GRM1552C2A9R4DA01# |                    |
|        |               |         |         | ±0.25pF            | GRM1552C2A8R1CA01# |        |               |         | 9.5pF  | ±0.05pF            | GRM1552C2A9R5WA01# |
|        |               |         | ±0.5pF  | GRM1552C2A8R1DA01# | ±0.1pF             |        |               |         |        | GRM1552C2A9R5BA01# |                    |
|        |               |         | 8.2pF   | ±0.05pF            | GRM1552C2A8R2WA01# |        |               |         |        | ±0.25pF            | GRM1552C2A9R5CA01# |
|        |               |         |         | ±0.1pF             | GRM1552C2A8R2BA01# |        |               |         | ±0.5pF | GRM1552C2A9R5DA01# |                    |
|        |               |         |         | ±0.25pF            | GRM1552C2A8R2CA01# |        |               |         | 9.6pF  | ±0.05pF            | GRM1552C2A9R6WA01# |
|        |               |         |         | ±0.5pF             | GRM1552C2A8R2DA01# |        |               |         |        | ±0.1pF             | GRM1552C2A9R6BA01# |
|        |               |         | 8.3pF   | ±0.05pF            | GRM1552C2A8R3WA01# |        |               |         |        | ±0.25pF            | GRM1552C2A9R6CA01# |
|        |               |         |         | ±0.1pF             | GRM1552C2A8R3BA01# |        |               |         | ±0.5pF | GRM1552C2A9R6DA01# |                    |
|        |               |         |         | ±0.25pF            | GRM1552C2A8R3CA01# |        |               |         | 9.7pF  | ±0.05pF            | GRM1552C2A9R7WA01# |
|        |               |         | ±0.5pF  | GRM1552C2A8R3DA01# | ±0.1pF             |        |               |         |        | GRM1552C2A9R7BA01# |                    |
|        |               |         | 8.4pF   | ±0.05pF            | GRM1552C2A8R4WA01# |        |               |         |        | ±0.25pF            | GRM1552C2A9R7CA01# |
|        |               |         |         | ±0.1pF             | GRM1552C2A8R4BA01# |        |               |         | ±0.5pF | GRM1552C2A9R7DA01# |                    |
|        |               |         |         | ±0.25pF            | GRM1552C2A8R4CA01# |        |               |         | 9.8pF  | ±0.05pF            | GRM1552C2A9R8WA01# |
|        |               |         |         | ±0.5pF             | GRM1552C2A8R4DA01# |        |               |         |        | ±0.1pF             | GRM1552C2A9R8BA01# |
|        |               |         | 8.5pF   | ±0.05pF            | GRM1552C2A8R5WA01# |        |               |         |        | ±0.25pF            | GRM1552C2A9R8CA01# |
|        |               |         |         | ±0.1pF             | GRM1552C2A8R5BA01# |        |               |         | ±0.5pF | GRM1552C2A9R8DA01# |                    |
|        |               |         |         | ±0.25pF            | GRM1552C2A8R5CA01# |        |               |         | 9.9pF  | ±0.05pF            | GRM1552C2A9R9WA01# |
|        |               |         | ±0.5pF  | GRM1552C2A8R5DA01# | ±0.1pF             |        |               |         |        | GRM1552C2A9R9BA01# |                    |
|        |               |         | 8.6pF   | ±0.05pF            | GRM1552C2A8R6WA01# |        |               |         |        | ±0.25pF            | GRM1552C2A9R9CA01# |
|        |               |         |         | ±0.1pF             | GRM1552C2A8R6BA01# |        |               |         | ±0.5pF | GRM1552C2A9R9DA01# |                    |
|        |               |         |         | ±0.25pF            | GRM1552C2A8R6CA01# |        |               |         | 10pF   | ±2%                | GRM1552C2A100GA01# |
|        |               |         |         | ±0.5pF             | GRM1552C2A8R6DA01# |        |               |         |        | ±5%                | GRM1552C2A100JA01# |
|        |               |         | 8.7pF   | ±0.05pF            | GRM1552C2A8R7WA01# |        |               |         | 12pF   | ±2%                | GRM1552C2A120GA01# |
|        |               |         |         | ±0.1pF             | GRM1552C2A8R7BA01# |        |               |         |        | ±5%                | GRM1552C2A120JA01# |
|        |               |         |         | ±0.25pF            | GRM1552C2A8R7CA01# |        |               |         | 15pF   | ±2%                | GRM1552C2A150GA01# |
|        |               |         |         | ±0.5pF             | GRM1552C2A8R7DA01# |        |               |         |        | ±5%                | GRM1552C2A150JA01# |
|        |               |         | 8.8pF   | ±0.05pF            | GRM1552C2A8R8WA01# |        |               |         | 18pF   | ±2%                | GRM1552C2A180GA01# |
|        |               |         |         | ±0.1pF             | GRM1552C2A8R8BA01# |        |               |         |        | ±5%                | GRM1552C2A180JA01# |
|        |               |         |         | ±0.25pF            | GRM1552C2A8R8CA01# |        |               |         | 22pF   | ±2%                | GRM1552C2A220GA01# |
|        |               |         |         | ±0.5pF             | GRM1552C2A8R8DA01# |        |               |         |        | ±5%                | GRM1552C2A220JA01# |
|        |               |         | 8.9pF   | ±0.05pF            | GRM1552C2A8R9WA01# |        |               |         | 27pF   | ±2%                | GRM1552C2A270GA01# |
|        |               |         |         | ±0.1pF             | GRM1552C2A8R9BA01# |        |               |         |        | ±5%                | GRM1552C2A270JA01# |
|        |               |         |         | ±0.25pF            | GRM1552C2A8R9CA01# |        |               |         | 33pF   | ±2%                | GRM1552C2A330GA01# |
|        |               |         |         | ±0.5pF             | GRM1552C2A8R9DA01# |        |               |         |        | ±5%                | GRM1552C2A330JA01# |
|        |               |         | 9.0pF   | ±0.05pF            | GRM1552C2A9R0WA01# |        |               |         | 39pF   | ±2%                | GRM1552C2A390GA01# |
|        |               |         |         | ±0.1pF             | GRM1552C2A9R0BA01# |        |               |         |        | ±5%                | GRM1552C2A390JA01# |
|        |               |         |         | ±0.25pF            | GRM1552C2A9R0CA01# |        |               |         | 47pF   | ±2%                | GRM1552C2A470GA01# |
|        |               |         |         | ±0.5pF             | GRM1552C2A9R0DA01# |        |               |         |        | ±5%                | GRM1552C2A470JA01# |
|        |               |         | 9.1pF   | ±0.05pF            | GRM1552C2A9R1WA01# |        |               |         | 56pF   | ±2%                | GRM1552C2A560GA01# |
|        |               |         |         | ±0.1pF             | GRM1552C2A9R1BA01# |        |               |         |        | ±5%                | GRM1552C2A560JA01# |
|        |               |         |         | ±0.25pF            | GRM1552C2A9R1CA01# |        |               |         | 68pF   | ±2%                | GRM1552C2A680GA01# |
|        |               |         |         | ±0.5pF             | GRM1552C2A9R1DA01# |        |               |         |        | ±5%                | GRM1552C2A680JA01# |
|        |               |         | 9.2pF   | ±0.05pF            | GRM1552C2A9R2WA01# |        |               |         | 82pF   | ±2%                | GRM1552C2A820GA01# |

Part number # indicates the package specification code.



# GRM Series Temperature Compensating Type Part Number List

(→ 1.0×0.5mm)

| T max. | Rated Voltage | TC Code            | Cap.    | Tol.               | Part Number        | T max.             | Rated Voltage      | TC Code | Cap.    | Tol.               | Part Number        |
|--------|---------------|--------------------|---------|--------------------|--------------------|--------------------|--------------------|---------|---------|--------------------|--------------------|
| 0.55mm | 100Vdc        | CH                 | 82pF    | ±5%                | GRM1552C2A820JA01# | 0.55mm             | 50Vdc              | COG     | 2.1pF   | ±0.1pF             | GRM1555C1H2R1BA01# |
|        |               |                    | 100pF   | ±2%                | GRM1552C2A101GA01# |                    |                    |         | ±0.25pF | GRM1555C1H2R1CA01# |                    |
|        |               |                    |         | ±5%                | GRM1552C2A101JA01# |                    |                    |         | 2.2pF   | ±0.05pF            | GRM1555C1H2R2WA01# |
|        | 50Vdc         | COG                | 0.10pF  | ±0.05pF            | GRM1555C1HR10WA01# |                    |                    |         | ±0.1pF  | GRM1555C1H2R2BA01# |                    |
| 0.20pF |               |                    | ±0.05pF | GRM1555C1HR20WA01# | ±0.25pF            | GRM1555C1H2R2CA01# |                    |         |         |                    |                    |
|        |               |                    | ±0.1pF  | GRM1555C1HR20BA01# | 2.3pF              | ±0.05pF            | GRM1555C1H2R3WA01# |         |         |                    |                    |
| 0.30pF |               |                    | ±0.05pF | GRM1555C1HR30WA01# | ±0.1pF             | GRM1555C1H2R3BA01# |                    |         |         |                    |                    |
|        |               |                    | ±0.1pF  | GRM1555C1HR30BA01# | ±0.25pF            | GRM1555C1H2R3CA01# |                    |         |         |                    |                    |
| 0.40pF |               |                    | ±0.05pF | GRM1555C1HR40WA01# | 2.4pF              | ±0.05pF            | GRM1555C1H2R4WA01# |         |         |                    |                    |
|        |               |                    | ±0.1pF  | GRM1555C1HR40BA01# | ±0.1pF             | GRM1555C1H2R4BA01# |                    |         |         |                    |                    |
| 0.50pF |               |                    | ±0.05pF | GRM1555C1HR50WA01# | ±0.25pF            | GRM1555C1H2R4CA01# |                    |         |         |                    |                    |
|        |               |                    | ±0.1pF  | GRM1555C1HR50BA01# | 2.5pF              | ±0.05pF            | GRM1555C1H2R5WA01# |         |         |                    |                    |
| 0.60pF |               |                    | ±0.05pF | GRM1555C1HR60WA01# | ±0.1pF             | GRM1555C1H2R5BA01# |                    |         |         |                    |                    |
|        |               |                    | ±0.1pF  | GRM1555C1HR60BA01# | ±0.25pF            | GRM1555C1H2R5CA01# |                    |         |         |                    |                    |
| 0.70pF |               |                    | ±0.05pF | GRM1555C1HR70WA01# | 2.6pF              | ±0.05pF            | GRM1555C1H2R6WA01# |         |         |                    |                    |
|        |               |                    | ±0.1pF  | GRM1555C1HR70BA01# | ±0.1pF             | GRM1555C1H2R6BA01# |                    |         |         |                    |                    |
| 0.80pF |               |                    | ±0.05pF | GRM1555C1HR80WA01# | ±0.25pF            | GRM1555C1H2R6CA01# |                    |         |         |                    |                    |
|        |               |                    | ±0.1pF  | GRM1555C1HR80BA01# | 2.7pF              | ±0.05pF            | GRM1555C1H2R7WA01# |         |         |                    |                    |
| 0.90pF |               |                    | ±0.05pF | GRM1555C1HR90WA01# | ±0.1pF             | GRM1555C1H2R7BA01# |                    |         |         |                    |                    |
|        |               |                    | ±0.1pF  | GRM1555C1HR90BA01# | ±0.25pF            | GRM1555C1H2R7CA01# |                    |         |         |                    |                    |
| 1.0pF  |               |                    | ±0.05pF | GRM1555C1H1R0WA01# | 2.8pF              | ±0.05pF            | GRM1555C1H2R8WA01# |         |         |                    |                    |
|        |               |                    | ±0.1pF  | GRM1555C1H1R0BA01# | ±0.1pF             | GRM1555C1H2R8BA01# |                    |         |         |                    |                    |
|        |               |                    | ±0.25pF | GRM1555C1H1R0CA01# | ±0.25pF            | GRM1555C1H2R8CA01# |                    |         |         |                    |                    |
| 1.1pF  |               |                    | ±0.05pF | GRM1555C1H1R1WA01# | 2.9pF              | ±0.05pF            | GRM1555C1H2R9WA01# |         |         |                    |                    |
|        |               |                    | ±0.1pF  | GRM1555C1H1R1BA01# | ±0.1pF             | GRM1555C1H2R9BA01# |                    |         |         |                    |                    |
|        |               |                    | ±0.25pF | GRM1555C1H1R1CA01# | ±0.25pF            | GRM1555C1H2R9CA01# |                    |         |         |                    |                    |
| 1.2pF  |               |                    | ±0.05pF | GRM1555C1H1R2WA01# | 3.0pF              | ±0.05pF            | GRM1555C1H3R0WA01# |         |         |                    |                    |
|        |               |                    | ±0.1pF  | GRM1555C1H1R2BA01# | ±0.1pF             | GRM1555C1H3R0BA01# |                    |         |         |                    |                    |
|        |               |                    | ±0.25pF | GRM1555C1H1R2CA01# | ±0.25pF            | GRM1555C1H3R0CA01# |                    |         |         |                    |                    |
| 1.3pF  |               |                    | ±0.05pF | GRM1555C1H1R3WA01# | 3.1pF              | ±0.05pF            | GRM1555C1H3R1WA01# |         |         |                    |                    |
|        |               |                    | ±0.1pF  | GRM1555C1H1R3BA01# | ±0.1pF             | GRM1555C1H3R1BA01# |                    |         |         |                    |                    |
|        |               |                    | ±0.25pF | GRM1555C1H1R3CA01# | ±0.25pF            | GRM1555C1H3R1CA01# |                    |         |         |                    |                    |
| 1.4pF  |               |                    | ±0.05pF | GRM1555C1H1R4WA01# | 3.2pF              | ±0.05pF            | GRM1555C1H3R2WA01# |         |         |                    |                    |
|        |               |                    | ±0.1pF  | GRM1555C1H1R4BA01# | ±0.1pF             | GRM1555C1H3R2BA01# |                    |         |         |                    |                    |
|        |               |                    | ±0.25pF | GRM1555C1H1R4CA01# | ±0.25pF            | GRM1555C1H3R2CA01# |                    |         |         |                    |                    |
| 1.5pF  |               |                    | ±0.05pF | GRM1555C1H1R5WA01# | 3.3pF              | ±0.05pF            | GRM1555C1H3R3WA01# |         |         |                    |                    |
|        |               |                    | ±0.1pF  | GRM1555C1H1R5BA01# | ±0.1pF             | GRM1555C1H3R3BA01# |                    |         |         |                    |                    |
|        |               |                    | ±0.25pF | GRM1555C1H1R5CA01# | ±0.25pF            | GRM1555C1H3R3CA01# |                    |         |         |                    |                    |
| 1.6pF  |               |                    | ±0.05pF | GRM1555C1H1R6WA01# | 3.4pF              | ±0.05pF            | GRM1555C1H3R4WA01# |         |         |                    |                    |
|        |               |                    | ±0.1pF  | GRM1555C1H1R6BA01# | ±0.1pF             | GRM1555C1H3R4BA01# |                    |         |         |                    |                    |
|        |               |                    | ±0.25pF | GRM1555C1H1R6CA01# | ±0.25pF            | GRM1555C1H3R4CA01# |                    |         |         |                    |                    |
| 1.7pF  |               |                    | ±0.05pF | GRM1555C1H1R7WA01# | 3.5pF              | ±0.05pF            | GRM1555C1H3R5WA01# |         |         |                    |                    |
|        |               |                    | ±0.1pF  | GRM1555C1H1R7BA01# | ±0.1pF             | GRM1555C1H3R5BA01# |                    |         |         |                    |                    |
|        |               |                    | ±0.25pF | GRM1555C1H1R7CA01# | ±0.25pF            | GRM1555C1H3R5CA01# |                    |         |         |                    |                    |
| 1.8pF  |               |                    | ±0.05pF | GRM1555C1H1R8WA01# | 3.6pF              | ±0.05pF            | GRM1555C1H3R6WA01# |         |         |                    |                    |
|        | ±0.1pF        | GRM1555C1H1R8BA01# | ±0.1pF  | GRM1555C1H3R6BA01# |                    |                    |                    |         |         |                    |                    |
|        | ±0.25pF       | GRM1555C1H1R8CA01# | ±0.25pF | GRM1555C1H3R6CA01# |                    |                    |                    |         |         |                    |                    |
| 1.9pF  | ±0.05pF       | GRM1555C1H1R9WA01# | 3.7pF   | ±0.05pF            | GRM1555C1H3R7WA01# |                    |                    |         |         |                    |                    |
|        | ±0.1pF        | GRM1555C1H1R9BA01# | ±0.1pF  | GRM1555C1H3R7BA01# |                    |                    |                    |         |         |                    |                    |
|        | ±0.25pF       | GRM1555C1H1R9CA01# | ±0.25pF | GRM1555C1H3R7CA01# |                    |                    |                    |         |         |                    |                    |
| 2.0pF  | ±0.05pF       | GRM1555C1H2R0WA01# | 3.8pF   | ±0.05pF            | GRM1555C1H3R8WA01# |                    |                    |         |         |                    |                    |
|        | ±0.1pF        | GRM1555C1H2R0BA01# | ±0.1pF  | GRM1555C1H3R8BA01# |                    |                    |                    |         |         |                    |                    |
|        | ±0.25pF       | GRM1555C1H2R0CA01# | ±0.25pF | GRM1555C1H3R8CA01# |                    |                    |                    |         |         |                    |                    |
| 2.1pF  | ±0.05pF       | GRM1555C1H2R1WA01# | 3.9pF   | ±0.05pF            | GRM1555C1H3R9WA01# |                    |                    |         |         |                    |                    |

- GRM
- GR3
- GRJ
- GR4
- GR7
- GJM
- GQM
- GA2
- GA3 GB
- GA3 GD
- GA3 GF
- LLL
- LLA
- LLM
- LLR
- NFM
- KRM
- KR3
- GMA
- GMD
- ⚠Caution /Notice

Part number # indicates the package specification code.

# GRM Series Temperature Compensating Type Part Number List

(→ 1.0×0.5mm)

| T max. | Rated Voltage | TC Code | Cap.    | Tol.               | Part Number        | T max. | Rated Voltage | TC Code | Cap.               | Tol.               | Part Number        |                    |
|--------|---------------|---------|---------|--------------------|--------------------|--------|---------------|---------|--------------------|--------------------|--------------------|--------------------|
| 0.55mm | 50Vdc         | COG     | 3.9pF   | ±0.1pF             | GRM1555C1H3R9BA01# | 0.55mm | 50Vdc         | COG     | 5.5pF              | ±0.5pF             | GRM1555C1H5R5DA01# |                    |
|        |               |         |         | ±0.25pF            | GRM1555C1H3R9CA01# |        |               |         |                    | 5.6pF              | ±0.05pF            | GRM1555C1H5R6WA01# |
|        |               |         |         | 4.0pF              | ±0.05pF            |        |               |         |                    |                    | GRM1555C1H4R0WA01# | ±0.1pF             |
|        |               |         | ±0.1pF  |                    | GRM1555C1H4R0BA01# |        |               |         | ±0.25pF            |                    | GRM1555C1H5R6CA01# |                    |
|        |               |         | ±0.25pF | GRM1555C1H4R0CA01# | 5.7pF              |        |               |         | ±0.5pF             | GRM1555C1H5R6DA01# |                    |                    |
|        |               |         | 4.1pF   | ±0.05pF            |                    |        |               |         | GRM1555C1H4R1WA01# | ±0.05pF            | GRM1555C1H5R7WA01# |                    |
|        |               |         |         | ±0.1pF             |                    |        |               |         | GRM1555C1H4R1BA01# | ±0.1pF             | GRM1555C1H5R7BA01# |                    |
|        |               |         |         | ±0.25pF            | GRM1555C1H4R1CA01# |        |               |         | ±0.25pF            | GRM1555C1H5R7CA01# |                    |                    |
|        |               |         | 4.2pF   | ±0.05pF            | GRM1555C1H4R2WA01# |        |               |         | ±0.5pF             | GRM1555C1H5R7DA01# |                    |                    |
|        |               |         |         | ±0.1pF             | GRM1555C1H4R2BA01# |        |               |         | 5.8pF              | ±0.05pF            | GRM1555C1H5R8WA01# |                    |
|        |               |         |         | ±0.25pF            | GRM1555C1H4R2CA01# |        |               |         |                    | ±0.1pF             | GRM1555C1H5R8BA01# |                    |
|        |               |         | 4.3pF   | ±0.05pF            | GRM1555C1H4R3WA01# |        |               |         |                    | ±0.25pF            | GRM1555C1H5R8CA01# |                    |
|        |               |         |         | ±0.1pF             | GRM1555C1H4R3BA01# |        |               |         | ±0.5pF             | GRM1555C1H5R8DA01# |                    |                    |
|        |               |         |         | ±0.25pF            | GRM1555C1H4R3CA01# |        |               |         | 5.9pF              | ±0.05pF            | GRM1555C1H5R9WA01# |                    |
|        |               |         | 4.4pF   | ±0.05pF            | GRM1555C1H4R4WA01# |        |               |         |                    | ±0.1pF             | GRM1555C1H5R9BA01# |                    |
|        |               |         |         | ±0.1pF             | GRM1555C1H4R4BA01# |        |               |         |                    | ±0.25pF            | GRM1555C1H5R9CA01# |                    |
|        |               |         |         | ±0.25pF            | GRM1555C1H4R4CA01# |        |               |         | ±0.5pF             | GRM1555C1H5R9DA01# |                    |                    |
|        |               |         | 4.5pF   | ±0.05pF            | GRM1555C1H4R5WA01# |        |               |         | 6.0pF              | ±0.05pF            | GRM1555C1H6R0WA01# |                    |
|        |               |         |         | ±0.1pF             | GRM1555C1H4R5BA01# |        |               |         |                    | ±0.1pF             | GRM1555C1H6R0BA01# |                    |
|        |               |         |         | ±0.25pF            | GRM1555C1H4R5CA01# |        |               |         |                    | ±0.25pF            | GRM1555C1H6R0CA01# |                    |
|        |               |         | 4.6pF   | ±0.05pF            | GRM1555C1H4R6WA01# |        |               |         | ±0.5pF             | GRM1555C1H6R0DA01# |                    |                    |
|        |               |         |         | ±0.1pF             | GRM1555C1H4R6BA01# |        |               |         | 6.1pF              | ±0.05pF            | GRM1555C1H6R1WA01# |                    |
|        |               |         |         | ±0.25pF            | GRM1555C1H4R6CA01# |        |               |         |                    | ±0.1pF             | GRM1555C1H6R1BA01# |                    |
|        |               |         | 4.7pF   | ±0.05pF            | GRM1555C1H4R7WA01# |        |               |         |                    | ±0.25pF            | GRM1555C1H6R1CA01# |                    |
|        |               |         |         | ±0.1pF             | GRM1555C1H4R7BA01# |        |               |         | ±0.5pF             | GRM1555C1H6R1DA01# |                    |                    |
|        |               |         |         | ±0.25pF            | GRM1555C1H4R7CA01# |        |               |         | 6.2pF              | ±0.05pF            | GRM1555C1H6R2WA01# |                    |
|        |               |         | 4.8pF   | ±0.05pF            | GRM1555C1H4R8WA01# |        |               |         |                    | ±0.1pF             | GRM1555C1H6R2BA01# |                    |
|        |               |         |         | ±0.1pF             | GRM1555C1H4R8BA01# |        |               |         |                    | ±0.25pF            | GRM1555C1H6R2CA01# |                    |
|        |               |         |         | ±0.25pF            | GRM1555C1H4R8CA01# |        |               |         | ±0.5pF             | GRM1555C1H6R2DA01# |                    |                    |
|        |               |         | 4.9pF   | ±0.05pF            | GRM1555C1H4R9WA01# |        |               |         | 6.3pF              | ±0.05pF            | GRM1555C1H6R3WA01# |                    |
|        |               |         |         | ±0.1pF             | GRM1555C1H4R9BA01# |        |               |         |                    | ±0.1pF             | GRM1555C1H6R3BA01# |                    |
|        |               |         |         | ±0.25pF            | GRM1555C1H4R9CA01# |        |               |         |                    | ±0.25pF            | GRM1555C1H6R3CA01# |                    |
|        |               |         | 5.0pF   | ±0.05pF            | GRM1555C1H5R0WA01# |        |               |         | ±0.5pF             | GRM1555C1H6R3DA01# |                    |                    |
|        |               |         |         | ±0.1pF             | GRM1555C1H5R0BA01# |        |               |         | 6.4pF              | ±0.05pF            | GRM1555C1H6R4WA01# |                    |
|        |               |         |         | ±0.25pF            | GRM1555C1H5R0CA01# |        |               |         |                    | ±0.1pF             | GRM1555C1H6R4BA01# |                    |
|        |               |         | 5.1pF   | ±0.05pF            | GRM1555C1H5R1WA01# |        |               |         |                    | ±0.25pF            | GRM1555C1H6R4CA01# |                    |
|        |               |         |         | ±0.1pF             | GRM1555C1H5R1BA01# |        |               |         | ±0.5pF             | GRM1555C1H6R4DA01# |                    |                    |
|        |               |         |         | ±0.25pF            | GRM1555C1H5R1CA01# |        |               |         | 6.5pF              | ±0.05pF            | GRM1555C1H6R5WA01# |                    |
|        |               |         | ±0.5pF  | GRM1555C1H5R1DA01# | ±0.1pF             |        |               |         |                    | GRM1555C1H6R5BA01# |                    |                    |
|        |               |         | 5.2pF   | ±0.05pF            | GRM1555C1H5R2WA01# |        |               |         |                    | ±0.25pF            | GRM1555C1H6R5CA01# |                    |
|        |               |         |         | ±0.1pF             | GRM1555C1H5R2BA01# |        |               |         | ±0.5pF             | GRM1555C1H6R5DA01# |                    |                    |
|        |               |         |         | ±0.25pF            | GRM1555C1H5R2CA01# |        |               |         | 6.6pF              | ±0.05pF            | GRM1555C1H6R6WA01# |                    |
|        |               |         | ±0.5pF  | GRM1555C1H5R2DA01# | ±0.1pF             |        |               |         |                    | GRM1555C1H6R6BA01# |                    |                    |
|        |               |         | 5.3pF   | ±0.05pF            | GRM1555C1H5R3WA01# |        |               |         |                    | ±0.25pF            | GRM1555C1H6R6CA01# |                    |
|        |               |         |         | ±0.1pF             | GRM1555C1H5R3BA01# |        |               |         | ±0.5pF             | GRM1555C1H6R6DA01# |                    |                    |
|        |               |         |         | ±0.25pF            | GRM1555C1H5R3CA01# |        |               |         | 6.7pF              | ±0.05pF            | GRM1555C1H6R7WA01# |                    |
|        |               |         | ±0.5pF  | GRM1555C1H5R3DA01# | ±0.1pF             |        |               |         |                    | GRM1555C1H6R7BA01# |                    |                    |
|        |               |         | 5.4pF   | ±0.05pF            | GRM1555C1H5R4WA01# |        |               |         |                    | ±0.25pF            | GRM1555C1H6R7CA01# |                    |
|        |               |         |         | ±0.1pF             | GRM1555C1H5R4BA01# |        |               |         | ±0.5pF             | GRM1555C1H6R7DA01# |                    |                    |
|        |               |         |         | ±0.25pF            | GRM1555C1H5R4CA01# |        |               |         | 6.8pF              | ±0.05pF            | GRM1555C1H6R8WA01# |                    |
|        |               |         | ±0.5pF  | GRM1555C1H5R4DA01# | ±0.1pF             |        |               |         |                    | GRM1555C1H6R8BA01# |                    |                    |
|        |               |         | 5.5pF   | ±0.05pF            | GRM1555C1H5R5WA01# |        |               |         |                    | ±0.25pF            | GRM1555C1H6R8CA01# |                    |
|        |               |         |         | ±0.1pF             | GRM1555C1H5R5BA01# |        |               |         | ±0.5pF             | GRM1555C1H6R8DA01# |                    |                    |
|        |               |         |         | ±0.25pF            | GRM1555C1H5R5CA01# |        |               |         | 6.9pF              | ±0.05pF            | GRM1555C1H6R9WA01# |                    |

Part number # indicates the package specification code.



# GRM Series Temperature Compensating Type Part Number List

(→ 1.0×0.5mm)

| T max. | Rated Voltage | TC Code | Cap.   | Tol.               | Part Number        | T max. | Rated Voltage | TC Code | Cap.    | Tol.               | Part Number        |                    |
|--------|---------------|---------|--------|--------------------|--------------------|--------|---------------|---------|---------|--------------------|--------------------|--------------------|
| 0.55mm | 50Vdc         | COG     | 6.9pF  | ±0.1pF             | GRM1555C1H6R9BA01# | 0.55mm | 50Vdc         | COG     | 8.2pF   | ±0.5pF             | GRM1555C1H8R2DA01# |                    |
|        |               |         |        | ±0.25pF            | GRM1555C1H6R9CA01# |        |               |         |         | 8.3pF              | ±0.05pF            | GRM1555C1H8R3WA01# |
|        |               |         |        | ±0.5pF             | GRM1555C1H6R9DA01# |        |               |         |         |                    | ±0.1pF             | GRM1555C1H8R3BA01# |
|        |               |         | 7.0pF  | ±0.05pF            | GRM1555C1H7ROWA01# |        |               |         | ±0.25pF |                    | GRM1555C1H8R3CA01# |                    |
|        |               |         |        | ±0.1pF             | GRM1555C1H7ROBA01# |        |               |         | ±0.5pF  | GRM1555C1H8R3DA01# |                    |                    |
|        |               |         |        | ±0.25pF            | GRM1555C1H7ROCA01# |        |               |         | 8.4pF   | ±0.05pF            | GRM1555C1H8R4WA01# |                    |
|        |               |         | ±0.5pF | GRM1555C1H7RODA01# | ±0.1pF             |        |               |         |         | GRM1555C1H8R4BA01# |                    |                    |
|        |               |         | 7.1pF  | ±0.05pF            | GRM1555C1H7R1WA01# |        |               |         |         | ±0.25pF            | GRM1555C1H8R4CA01# |                    |
|        |               |         |        | ±0.1pF             | GRM1555C1H7R1BA01# |        |               |         | ±0.5pF  | GRM1555C1H8R4DA01# |                    |                    |
|        |               |         |        | ±0.25pF            | GRM1555C1H7R1CA01# |        |               |         | 8.5pF   | ±0.05pF            | GRM1555C1H8R5WA01# |                    |
|        |               |         | ±0.5pF | GRM1555C1H7R1DA01# | ±0.1pF             |        |               |         |         | GRM1555C1H8R5BA01# |                    |                    |
|        |               |         | 7.2pF  | ±0.05pF            | GRM1555C1H7R2WA01# |        |               |         |         | ±0.25pF            | GRM1555C1H8R5CA01# |                    |
|        |               |         |        | ±0.1pF             | GRM1555C1H7R2BA01# |        |               |         | ±0.5pF  | GRM1555C1H8R5DA01# |                    |                    |
|        |               |         |        | ±0.25pF            | GRM1555C1H7R2CA01# |        |               |         | 8.6pF   | ±0.05pF            | GRM1555C1H8R6WA01# |                    |
|        |               |         | ±0.5pF | GRM1555C1H7R2DA01# | ±0.1pF             |        |               |         |         | GRM1555C1H8R6BA01# |                    |                    |
|        |               |         | 7.3pF  | ±0.05pF            | GRM1555C1H7R3WA01# |        |               |         |         | ±0.25pF            | GRM1555C1H8R6CA01# |                    |
|        |               |         |        | ±0.1pF             | GRM1555C1H7R3BA01# |        |               |         | ±0.5pF  | GRM1555C1H8R6DA01# |                    |                    |
|        |               |         |        | ±0.25pF            | GRM1555C1H7R3CA01# |        |               |         | 8.7pF   | ±0.05pF            | GRM1555C1H8R7WA01# |                    |
|        |               |         | ±0.5pF | GRM1555C1H7R3DA01# | ±0.1pF             |        |               |         |         | GRM1555C1H8R7BA01# |                    |                    |
|        |               |         | 7.4pF  | ±0.05pF            | GRM1555C1H7R4WA01# |        |               |         |         | ±0.25pF            | GRM1555C1H8R7CA01# |                    |
|        |               |         |        | ±0.1pF             | GRM1555C1H7R4BA01# |        |               |         | ±0.5pF  | GRM1555C1H8R7DA01# |                    |                    |
|        |               |         |        | ±0.25pF            | GRM1555C1H7R4CA01# |        |               |         | 8.8pF   | ±0.05pF            | GRM1555C1H8R8WA01# |                    |
|        |               |         | ±0.5pF | GRM1555C1H7R4DA01# | ±0.1pF             |        |               |         |         | GRM1555C1H8R8BA01# |                    |                    |
|        |               |         | 7.5pF  | ±0.05pF            | GRM1555C1H7R5WA01# |        |               |         |         | ±0.25pF            | GRM1555C1H8R8CA01# |                    |
|        |               |         |        | ±0.1pF             | GRM1555C1H7R5BA01# |        |               |         | ±0.5pF  | GRM1555C1H8R8DA01# |                    |                    |
|        |               |         |        | ±0.25pF            | GRM1555C1H7R5CA01# |        |               |         | 8.9pF   | ±0.05pF            | GRM1555C1H8R9WA01# |                    |
|        |               |         | ±0.5pF | GRM1555C1H7R5DA01# | ±0.1pF             |        |               |         |         | GRM1555C1H8R9BA01# |                    |                    |
|        |               |         | 7.6pF  | ±0.05pF            | GRM1555C1H7R6WA01# |        |               |         |         | ±0.25pF            | GRM1555C1H8R9CA01# |                    |
|        |               |         |        | ±0.1pF             | GRM1555C1H7R6BA01# |        |               |         | ±0.5pF  | GRM1555C1H8R9DA01# |                    |                    |
|        |               |         |        | ±0.25pF            | GRM1555C1H7R6CA01# |        |               |         | 9.0pF   | ±0.05pF            | GRM1555C1H9R0WA01# |                    |
|        |               |         | ±0.5pF | GRM1555C1H7R6DA01# | ±0.1pF             |        |               |         |         | GRM1555C1H9R0BA01# |                    |                    |
|        |               |         | 7.7pF  | ±0.05pF            | GRM1555C1H7R7WA01# |        |               |         |         | ±0.25pF            | GRM1555C1H9R0CA01# |                    |
|        |               |         |        | ±0.1pF             | GRM1555C1H7R7BA01# |        |               |         | ±0.5pF  | GRM1555C1H9R0DA01# |                    |                    |
|        |               |         |        | ±0.25pF            | GRM1555C1H7R7CA01# |        |               |         | 9.1pF   | ±0.05pF            | GRM1555C1H9R1WA01# |                    |
|        |               |         | ±0.5pF | GRM1555C1H7R7DA01# | ±0.1pF             |        |               |         |         | GRM1555C1H9R1BA01# |                    |                    |
|        |               |         | 7.8pF  | ±0.05pF            | GRM1555C1H7R8WA01# |        |               |         |         | ±0.25pF            | GRM1555C1H9R1CA01# |                    |
|        |               |         |        | ±0.1pF             | GRM1555C1H7R8BA01# |        |               |         | ±0.5pF  | GRM1555C1H9R1DA01# |                    |                    |
|        |               |         |        | ±0.25pF            | GRM1555C1H7R8CA01# |        |               |         | 9.2pF   | ±0.05pF            | GRM1555C1H9R2WA01# |                    |
|        |               |         | ±0.5pF | GRM1555C1H7R8DA01# | ±0.1pF             |        |               |         |         | GRM1555C1H9R2BA01# |                    |                    |
|        |               |         | 7.9pF  | ±0.05pF            | GRM1555C1H7R9WA01# |        |               |         |         | ±0.25pF            | GRM1555C1H9R2CA01# |                    |
|        |               |         |        | ±0.1pF             | GRM1555C1H7R9BA01# |        |               |         | ±0.5pF  | GRM1555C1H9R2DA01# |                    |                    |
|        |               |         |        | ±0.25pF            | GRM1555C1H7R9CA01# |        |               |         | 9.3pF   | ±0.05pF            | GRM1555C1H9R3WA01# |                    |
|        |               |         | ±0.5pF | GRM1555C1H7R9DA01# | ±0.1pF             |        |               |         |         | GRM1555C1H9R3BA01# |                    |                    |
|        |               |         | 8.0pF  | ±0.05pF            | GRM1555C1H8R0WA01# |        |               |         |         | ±0.25pF            | GRM1555C1H9R3CA01# |                    |
|        |               |         |        | ±0.1pF             | GRM1555C1H8R0BA01# |        |               |         | ±0.5pF  | GRM1555C1H9R3DA01# |                    |                    |
|        |               |         |        | ±0.25pF            | GRM1555C1H8R0CA01# |        |               |         | 9.4pF   | ±0.05pF            | GRM1555C1H9R4WA01# |                    |
|        |               |         | ±0.5pF | GRM1555C1H8R0DA01# | ±0.1pF             |        |               |         |         | GRM1555C1H9R4BA01# |                    |                    |
|        |               |         | 8.1pF  | ±0.05pF            | GRM1555C1H8R1WA01# |        |               |         |         | ±0.25pF            | GRM1555C1H9R4CA01# |                    |
|        |               |         |        | ±0.1pF             | GRM1555C1H8R1BA01# |        |               |         | ±0.5pF  | GRM1555C1H9R4DA01# |                    |                    |
|        |               |         |        | ±0.25pF            | GRM1555C1H8R1CA01# |        |               |         | 9.5pF   | ±0.05pF            | GRM1555C1H9R5WA01# |                    |
|        |               |         | ±0.5pF | GRM1555C1H8R1DA01# | ±0.1pF             |        |               |         |         | GRM1555C1H9R5BA01# |                    |                    |
|        |               |         | 8.2pF  | ±0.05pF            | GRM1555C1H8R2WA01# |        |               |         |         | ±0.25pF            | GRM1555C1H9R5CA01# |                    |
|        |               |         |        | ±0.1pF             | GRM1555C1H8R2BA01# |        |               |         | ±0.5pF  | GRM1555C1H9R5DA01# |                    |                    |
|        |               |         |        | ±0.25pF            | GRM1555C1H8R2CA01# |        |               |         | 9.6pF   | ±0.05pF            | GRM1555C1H9R6WA01# |                    |

GRM  
 GR3  
 GRJ  
 GR4  
 GR7  
 GJM  
 GQM  
 GA2  
 GA3 GB  
 GA3 GD  
 GA3 GF  
 LLL  
 LLA  
 LLM  
 LLR  
 NFM  
 KRM  
 KR3  
 GMA  
 GMD  
 ⚠Caution /Notice

Part number # indicates the package specification code.

## GRM Series Temperature Compensating Type Part Number List

(→ 1.0×0.5mm)

| T max. | Rated Voltage      | TC Code            | Cap.   | Tol.               | Part Number        | T max. | Rated Voltage | TC Code | Cap.               | Tol.   | Part Number        |                    |
|--------|--------------------|--------------------|--------|--------------------|--------------------|--------|---------------|---------|--------------------|--------|--------------------|--------------------|
| 0.55mm | 50Vdc              | COG                | 9.6pF  | ±0.1pF             | GRM1555C1H9R6BA01# | 0.55mm | 50Vdc         | COG     | 390pF              | ±5%    | GRM1555C1H391JA01# |                    |
|        |                    |                    |        | ±0.25pF            | GRM1555C1H9R6CA01# |        |               |         |                    | 470pF  | ±2%                | GRM1555C1H471GA01# |
|        |                    |                    |        | ±0.5pF             | GRM1555C1H9R6DA01# |        |               |         |                    |        | ±5%                | GRM1555C1H471JA01# |
|        |                    |                    | 9.7pF  | ±0.05pF            | GRM1555C1H9R7WA01# |        |               |         | 560pF              |        | ±2%                | GRM1555C1H561GA01# |
|        |                    |                    |        | ±0.1pF             | GRM1555C1H9R7BA01# |        |               |         |                    | ±5%    | GRM1555C1H561JA01# |                    |
|        |                    |                    |        | ±0.25pF            | GRM1555C1H9R7CA01# |        |               |         |                    | 680pF  | ±2%                | GRM1555C1H681GA01# |
|        |                    |                    | ±0.5pF | GRM1555C1H9R7DA01# | ±5%                |        |               |         | GRM1555C1H681JA01# |        |                    |                    |
|        |                    |                    | 9.8pF  | ±0.05pF            | GRM1555C1H9R8WA01# |        |               |         | 820pF              |        | ±2%                | GRM1555C1H821GA01# |
|        |                    |                    |        | ±0.1pF             | GRM1555C1H9R8BA01# |        |               |         |                    | ±5%    | GRM1555C1H821JA01# |                    |
|        |                    |                    |        | ±0.25pF            | GRM1555C1H9R8CA01# |        |               |         |                    | 1000pF | ±2%                | GRM1555C1H102GA01# |
|        |                    |                    |        | ±0.5pF             | GRM1555C1H9R8DA01# |        |               |         |                    |        | ±5%                | GRM1555C1H102JA01# |
|        |                    |                    | 9.9pF  | ±0.05pF            | GRM1555C1H9R9WA01# |        |               |         | CK                 | 0.10pF | ±0.05pF            | GRM1554C1HR10WA01# |
|        |                    |                    |        | ±0.1pF             | GRM1555C1H9R9BA01# |        |               |         |                    | 0.20pF | ±0.05pF            | GRM1554C1HR20WA01# |
|        |                    |                    |        | ±0.25pF            | GRM1555C1H9R9CA01# |        |               |         |                    | ±0.1pF | GRM1554C1HR20BA01# |                    |
|        |                    |                    |        | ±0.5pF             | GRM1555C1H9R9DA01# |        |               |         |                    | 0.30pF | ±0.05pF            | GRM1554C1HR30WA01# |
|        |                    |                    | 10pF   | ±2%                | GRM1555C1H100GA01# |        |               |         |                    |        | ±0.1pF             | GRM1554C1HR30BA01# |
|        |                    |                    |        | ±5%                | GRM1555C1H100JA01# |        |               |         |                    | 0.40pF | ±0.05pF            | GRM1554C1HR40WA01# |
|        |                    |                    | 12pF   | ±2%                | GRM1555C1H120GA01# |        |               |         |                    |        | ±0.1pF             | GRM1554C1HR40BA01# |
|        |                    |                    |        | ±5%                | GRM1555C1H120JA01# |        |               |         |                    | 0.50pF | ±0.05pF            | GRM1554C1HR50WA01# |
|        |                    |                    | 15pF   | ±2%                | GRM1555C1H150GA01# |        |               |         |                    |        | ±0.1pF             | GRM1554C1HR50BA01# |
|        |                    |                    |        | ±5%                | GRM1555C1H150JA01# |        |               |         |                    | 0.60pF | ±0.05pF            | GRM1554C1HR60WA01# |
|        |                    |                    | 18pF   | ±2%                | GRM1555C1H180GA01# |        |               |         |                    |        | ±0.1pF             | GRM1554C1HR60BA01# |
|        |                    |                    |        | ±5%                | GRM1555C1H180JA01# |        |               |         |                    | 0.70pF | ±0.05pF            | GRM1554C1HR70WA01# |
|        |                    |                    | 22pF   | ±2%                | GRM1555C1H220GA01# |        |               |         |                    |        | ±0.1pF             | GRM1554C1HR70BA01# |
|        |                    |                    |        | ±5%                | GRM1555C1H220JA01# |        |               |         |                    | 0.80pF | ±0.05pF            | GRM1554C1HR80WA01# |
|        |                    |                    | 27pF   | ±2%                | GRM1555C1H270GA01# |        |               |         |                    |        | ±0.1pF             | GRM1554C1HR80BA01# |
|        |                    |                    |        | ±5%                | GRM1555C1H270JA01# |        |               |         |                    | 0.90pF | ±0.05pF            | GRM1554C1HR90WA01# |
|        |                    |                    | 33pF   | ±2%                | GRM1555C1H330GA01# |        |               |         |                    |        | ±0.1pF             | GRM1554C1HR90BA01# |
|        |                    |                    |        | ±5%                | GRM1555C1H330JA01# |        |               |         |                    | 1.0pF  | ±0.05pF            | GRM1554C1H1R0WA01# |
|        |                    |                    | 39pF   | ±2%                | GRM1555C1H390GA01# |        |               |         |                    |        | ±0.1pF             | GRM1554C1H1R0BA01# |
|        |                    |                    |        | ±5%                | GRM1555C1H390JA01# |        |               |         |                    |        | ±0.25pF            | GRM1554C1H1R0CA01# |
|        |                    |                    | 47pF   | ±2%                | GRM1555C1H470GA01# |        |               |         |                    | 1.1pF  | ±0.05pF            | GRM1554C1H1R1WA01# |
|        |                    |                    |        | ±5%                | GRM1555C1H470JA01# |        |               |         |                    |        | ±0.1pF             | GRM1554C1H1R1BA01# |
|        |                    |                    |        | 56pF               | ±2%                |        |               |         |                    |        | GRM1555C1H560GA01# | ±0.25pF            |
|        |                    |                    | ±5%    |                    | GRM1555C1H560JA01# |        |               |         |                    | 1.2pF  | ±0.05pF            | GRM1554C1H1R2WA01# |
|        |                    |                    | 68pF   | ±2%                | GRM1555C1H680GA01# |        |               |         |                    |        | ±0.1pF             | GRM1554C1H1R2BA01# |
|        |                    |                    |        | ±5%                | GRM1555C1H680JA01# |        |               |         |                    |        | ±0.25pF            | GRM1554C1H1R2CA01# |
|        |                    |                    | 82pF   | ±2%                | GRM1555C1H820GA01# |        |               |         |                    | 1.3pF  | ±0.05pF            | GRM1554C1H1R3WA01# |
|        |                    |                    |        | ±5%                | GRM1555C1H820JA01# |        |               |         |                    |        | ±0.1pF             | GRM1554C1H1R3BA01# |
|        |                    |                    | 100pF  | ±2%                | GRM1555C1H101GA01# |        |               |         |                    |        | ±0.25pF            | GRM1554C1H1R3CA01# |
|        |                    |                    |        | ±5%                | GRM1555C1H101JA01# |        |               |         |                    | 1.4pF  | ±0.05pF            | GRM1554C1H1R4WA01# |
|        |                    |                    | 120pF  | ±2%                | GRM1555C1H121GA01# |        |               |         |                    |        | ±0.1pF             | GRM1554C1H1R4BA01# |
| ±5%    | GRM1555C1H121JA01# | ±0.25pF            |        | GRM1554C1H1R4CA01# |                    |        |               |         |                    |        |                    |                    |
| 150pF  | ±2%                | GRM1555C1H151GA01# | 1.5pF  | ±0.05pF            | GRM1554C1H1R5WA01# |        |               |         |                    |        |                    |                    |
|        | ±5%                | GRM1555C1H151JA01# |        | ±0.1pF             | GRM1554C1H1R5BA01# |        |               |         |                    |        |                    |                    |
| 180pF  | ±2%                | GRM1555C1H181GA01# |        | ±0.25pF            | GRM1554C1H1R5CA01# |        |               |         |                    |        |                    |                    |
|        | ±5%                | GRM1555C1H181JA01# | 1.6pF  | ±0.05pF            | GRM1554C1H1R6WA01# |        |               |         |                    |        |                    |                    |
| 220pF  | ±2%                | GRM1555C1H221GA01# |        | ±0.1pF             | GRM1554C1H1R6BA01# |        |               |         |                    |        |                    |                    |
|        | ±5%                | GRM1555C1H221JA01# |        | ±0.25pF            | GRM1554C1H1R6CA01# |        |               |         |                    |        |                    |                    |
| 270pF  | ±2%                | GRM1555C1H271GA01# | 1.7pF  | ±0.05pF            | GRM1554C1H1R7WA01# |        |               |         |                    |        |                    |                    |
|        | ±5%                | GRM1555C1H271JA01# |        | ±0.1pF             | GRM1554C1H1R7BA01# |        |               |         |                    |        |                    |                    |
| 330pF  | ±2%                | GRM1555C1H331GA01# |        | ±0.25pF            | GRM1554C1H1R7CA01# |        |               |         |                    |        |                    |                    |
|        | ±5%                | GRM1555C1H331JA01# | 1.8pF  | ±0.05pF            | GRM1554C1H1R8WA01# |        |               |         |                    |        |                    |                    |
| 390pF  | ±2%                | GRM1555C1H391GA01# |        | ±0.1pF             | GRM1554C1H1R8BA01# |        |               |         |                    |        |                    |                    |

Part number # indicates the package specification code.



# GRM Series Temperature Compensating Type Part Number List

(→ 1.0×0.5mm)

| T max. | Rated Voltage | TC Code | Cap.    | Tol.               | Part Number        | T max.             | Rated Voltage      | TC Code | Cap.               | Tol.    | Part Number        |
|--------|---------------|---------|---------|--------------------|--------------------|--------------------|--------------------|---------|--------------------|---------|--------------------|
| 0.55mm | 50Vdc         | CK      | 1.8pF   | ±0.25pF            | GRM1554C1H1R8CA01# | 0.55mm             | 50Vdc              | CJ      | 3.6pF              | ±0.25pF | GRM1553C1H3R6CA01# |
|        |               |         |         | ±0.05pF            | GRM1554C1H1R9WA01# |                    |                    |         |                    | ±0.05pF | GRM1553C1H3R7WA01# |
|        |               |         |         | ±0.1pF             | GRM1554C1H1R9BA01# |                    |                    |         |                    | ±0.1pF  | GRM1553C1H3R7BA01# |
|        |               |         | ±0.25pF | GRM1554C1H1R9CA01# | ±0.25pF            |                    |                    |         | GRM1553C1H3R7CA01# |         |                    |
|        |               |         | 2.0pF   | ±0.05pF            | GRM1554C1H2R0WA01# |                    |                    |         | 3.8pF              | ±0.05pF | GRM1553C1H3R8WA01# |
|        |               |         |         | ±0.1pF             | GRM1554C1H2R0BA01# |                    |                    |         |                    | ±0.1pF  | GRM1553C1H3R8BA01# |
|        |               |         |         | ±0.25pF            | GRM1554C1H2R0CA01# |                    |                    |         |                    | ±0.25pF | GRM1553C1H3R8CA01# |
|        |               |         | 2.1pF   | ±0.05pF            | GRM1553C1H2R1WA01# |                    |                    |         | 3.9pF              | ±0.05pF | GRM1553C1H3R9WA01# |
|        |               |         |         | ±0.1pF             | GRM1553C1H2R1BA01# |                    |                    |         |                    | ±0.1pF  | GRM1553C1H3R9BA01# |
|        |               |         |         | ±0.25pF            | GRM1553C1H2R1CA01# |                    |                    |         |                    | ±0.25pF | GRM1553C1H3R9CA01# |
|        |               |         | 2.2pF   | ±0.05pF            | GRM1553C1H2R2WA01# |                    |                    |         | 4.0pF              | ±0.05pF | GRM1552C1H4R0WA01# |
|        |               |         |         | ±0.1pF             | GRM1553C1H2R2BA01# |                    |                    |         |                    | ±0.1pF  | GRM1552C1H4R0BA01# |
|        |               |         |         | ±0.25pF            | GRM1553C1H2R2CA01# |                    |                    |         |                    | ±0.25pF | GRM1552C1H4R0CA01# |
|        |               |         | 2.3pF   | ±0.05pF            | GRM1553C1H2R3WA01# |                    |                    |         | 4.1pF              | ±0.05pF | GRM1552C1H4R1WA01# |
|        |               |         |         | ±0.1pF             | GRM1553C1H2R3BA01# |                    |                    |         |                    | ±0.1pF  | GRM1552C1H4R1BA01# |
|        |               |         |         | ±0.25pF            | GRM1553C1H2R3CA01# |                    |                    |         |                    | ±0.25pF | GRM1552C1H4R1CA01# |
|        |               |         | 2.4pF   | ±0.05pF            | GRM1553C1H2R4WA01# |                    |                    |         | 4.2pF              | ±0.05pF | GRM1552C1H4R2WA01# |
|        |               |         |         | ±0.1pF             | GRM1553C1H2R4BA01# |                    |                    |         |                    | ±0.1pF  | GRM1552C1H4R2BA01# |
|        |               |         |         | ±0.25pF            | GRM1553C1H2R4CA01# |                    |                    |         |                    | ±0.25pF | GRM1552C1H4R2CA01# |
|        |               |         | 2.5pF   | ±0.05pF            | GRM1553C1H2R5WA01# |                    |                    |         | 4.3pF              | ±0.05pF | GRM1552C1H4R3WA01# |
|        |               |         |         | ±0.1pF             | GRM1553C1H2R5BA01# |                    |                    |         |                    | ±0.1pF  | GRM1552C1H4R3BA01# |
|        |               |         |         | ±0.25pF            | GRM1553C1H2R5CA01# |                    |                    |         |                    | ±0.25pF | GRM1552C1H4R3CA01# |
|        |               |         | 2.6pF   | ±0.05pF            | GRM1553C1H2R6WA01# |                    |                    |         | 4.4pF              | ±0.05pF | GRM1552C1H4R4WA01# |
|        |               |         |         | ±0.1pF             | GRM1553C1H2R6BA01# |                    |                    |         |                    | ±0.1pF  | GRM1552C1H4R4BA01# |
|        |               |         |         | ±0.25pF            | GRM1553C1H2R6CA01# |                    |                    |         |                    | ±0.25pF | GRM1552C1H4R4CA01# |
|        |               |         | 2.7pF   | ±0.05pF            | GRM1553C1H2R7WA01# |                    |                    |         | 4.5pF              | ±0.05pF | GRM1552C1H4R5WA01# |
|        |               |         |         | ±0.1pF             | GRM1553C1H2R7BA01# |                    |                    |         |                    | ±0.1pF  | GRM1552C1H4R5BA01# |
|        |               |         |         | ±0.25pF            | GRM1553C1H2R7CA01# |                    |                    |         |                    | ±0.25pF | GRM1552C1H4R5CA01# |
|        |               |         | 2.8pF   | ±0.05pF            | GRM1553C1H2R8WA01# |                    |                    |         | 4.6pF              | ±0.05pF | GRM1552C1H4R6WA01# |
|        |               |         |         | ±0.1pF             | GRM1553C1H2R8BA01# |                    |                    |         |                    | ±0.1pF  | GRM1552C1H4R6BA01# |
|        |               | ±0.25pF |         | GRM1553C1H2R8CA01# | ±0.25pF            | GRM1552C1H4R6CA01# |                    |         |                    |         |                    |
|        |               | 2.9pF   | ±0.05pF | GRM1553C1H2R9WA01# | 4.7pF              | ±0.05pF            | GRM1552C1H4R7WA01# |         |                    |         |                    |
|        |               |         | ±0.1pF  | GRM1553C1H2R9BA01# |                    | ±0.1pF             | GRM1552C1H4R7BA01# |         |                    |         |                    |
|        |               |         | ±0.25pF | GRM1553C1H2R9CA01# |                    | ±0.25pF            | GRM1552C1H4R7CA01# |         |                    |         |                    |
|        |               | 3.0pF   | ±0.05pF | GRM1553C1H3R0WA01# | 4.8pF              | ±0.05pF            | GRM1552C1H4R8WA01# |         |                    |         |                    |
|        |               |         | ±0.1pF  | GRM1553C1H3R0BA01# |                    | ±0.1pF             | GRM1552C1H4R8BA01# |         |                    |         |                    |
|        |               |         | ±0.25pF | GRM1553C1H3R0CA01# |                    | ±0.25pF            | GRM1552C1H4R8CA01# |         |                    |         |                    |
|        |               | 3.1pF   | ±0.05pF | GRM1553C1H3R1WA01# | 4.9pF              | ±0.05pF            | GRM1552C1H4R9WA01# |         |                    |         |                    |
|        |               |         | ±0.1pF  | GRM1553C1H3R1BA01# |                    | ±0.1pF             | GRM1552C1H4R9BA01# |         |                    |         |                    |
|        |               |         | ±0.25pF | GRM1553C1H3R1CA01# |                    | ±0.25pF            | GRM1552C1H4R9CA01# |         |                    |         |                    |
|        |               | 3.2pF   | ±0.05pF | GRM1553C1H3R2WA01# | 5.0pF              | ±0.05pF            | GRM1552C1H5R0WA01# |         |                    |         |                    |
|        |               |         | ±0.1pF  | GRM1553C1H3R2BA01# |                    | ±0.1pF             | GRM1552C1H5R0BA01# |         |                    |         |                    |
|        |               |         | ±0.25pF | GRM1553C1H3R2CA01# |                    | ±0.25pF            | GRM1552C1H5R0CA01# |         |                    |         |                    |
|        |               | 3.3pF   | ±0.05pF | GRM1553C1H3R3WA01# | 5.1pF              | ±0.05pF            | GRM1552C1H5R1WA01# |         |                    |         |                    |
|        |               |         | ±0.1pF  | GRM1553C1H3R3BA01# |                    | ±0.1pF             | GRM1552C1H5R1BA01# |         |                    |         |                    |
|        |               |         | ±0.25pF | GRM1553C1H3R3CA01# |                    | ±0.25pF            | GRM1552C1H5R1CA01# |         |                    |         |                    |
|        |               | 3.4pF   | ±0.05pF | GRM1553C1H3R4WA01# | 5.2pF              | ±0.05pF            | GRM1552C1H5R2WA01# |         |                    |         |                    |
|        |               |         | ±0.1pF  | GRM1553C1H3R4BA01# |                    | ±0.1pF             | GRM1552C1H5R2BA01# |         |                    |         |                    |
|        |               |         | ±0.25pF | GRM1553C1H3R4CA01# |                    | ±0.25pF            | GRM1552C1H5R2CA01# |         |                    |         |                    |
|        |               | 3.5pF   | ±0.05pF | GRM1553C1H3R5WA01# | 5.3pF              | ±0.05pF            | GRM1552C1H5R3WA01# |         |                    |         |                    |
|        |               |         | ±0.1pF  | GRM1553C1H3R5BA01# |                    | ±0.1pF             | GRM1552C1H5R3BA01# |         |                    |         |                    |
|        |               |         | ±0.25pF | GRM1553C1H3R5CA01# |                    | ±0.25pF            | GRM1552C1H5R3CA01# |         |                    |         |                    |
|        |               | 3.6pF   | ±0.05pF | GRM1553C1H3R6WA01# | 5.3pF              | ±0.05pF            | GRM1552C1H5R3WA01# |         |                    |         |                    |
|        |               |         | ±0.1pF  | GRM1553C1H3R6BA01# |                    | ±0.1pF             | GRM1552C1H5R3BA01# |         |                    |         |                    |

- GRM
- GR3
- GRJ
- GR4
- GR7
- GJM
- GJM
- GQM
- GA2
- GA3 GB
- GA3 GD
- GA3 GF
- LLL
- LLA
- LLM
- LLR
- NFM
- KRM
- KR3
- GMA
- GMD
- ⚠Caution /Notice

Part number # indicates the package specification code.



# GRM Series Temperature Compensating Type Part Number List

(→ 1.0×0.5mm)

| T max. | Rated Voltage | TC Code | Cap.    | Tol.    | Part Number        |
|--------|---------------|---------|---------|---------|--------------------|
| 0.55mm | 50Vdc         | CH      | 5.3pF   | ±0.5pF  | GRM1552C1H5R3DA01# |
|        |               |         |         | ±0.05pF | GRM1552C1H5R4WA01# |
|        |               |         |         |         | ±0.1pF             |
|        |               |         | ±0.25pF |         | GRM1552C1H5R4CA01# |
|        |               |         | 5.4pF   | ±0.5pF  | GRM1552C1H5R4DA01# |
|        |               |         |         | ±0.05pF | GRM1552C1H5R5WA01# |
|        |               |         |         | ±0.1pF  | GRM1552C1H5R5BA01# |
|        |               |         | 5.5pF   | ±0.25pF | GRM1552C1H5R5CA01# |
|        |               |         |         | ±0.5pF  | GRM1552C1H5R5DA01# |
|        |               |         |         | ±0.05pF | GRM1552C1H5R6WA01# |
|        |               |         | 5.6pF   | ±0.1pF  | GRM1552C1H5R6BA01# |
|        |               |         |         | ±0.25pF | GRM1552C1H5R6CA01# |
|        |               |         |         | ±0.5pF  | GRM1552C1H5R6DA01# |
|        |               |         | 5.7pF   | ±0.05pF | GRM1552C1H5R7WA01# |
|        |               |         |         | ±0.1pF  | GRM1552C1H5R7BA01# |
|        |               |         |         | ±0.25pF | GRM1552C1H5R7CA01# |
|        |               |         | 5.8pF   | ±0.5pF  | GRM1552C1H5R7DA01# |
|        |               |         |         | ±0.05pF | GRM1552C1H5R8WA01# |
|        |               |         |         | ±0.1pF  | GRM1552C1H5R8BA01# |
|        |               |         | 5.9pF   | ±0.25pF | GRM1552C1H5R8CA01# |
|        |               |         |         | ±0.5pF  | GRM1552C1H5R8DA01# |
|        |               |         |         | ±0.05pF | GRM1552C1H5R9WA01# |
|        |               |         | 6.0pF   | ±0.1pF  | GRM1552C1H5R9BA01# |
|        |               |         |         | ±0.25pF | GRM1552C1H5R9CA01# |
|        |               |         |         | ±0.5pF  | GRM1552C1H5R9DA01# |
|        |               |         | 6.1pF   | ±0.05pF | GRM1552C1H6R0WA01# |
|        |               |         |         | ±0.1pF  | GRM1552C1H6R0BA01# |
|        |               |         |         | ±0.25pF | GRM1552C1H6R0CA01# |
|        |               |         | 6.2pF   | ±0.5pF  | GRM1552C1H6R0DA01# |
|        |               |         |         | ±0.05pF | GRM1552C1H6R1WA01# |
|        |               |         |         | ±0.1pF  | GRM1552C1H6R1BA01# |
|        |               |         | 6.3pF   | ±0.25pF | GRM1552C1H6R1CA01# |
|        |               |         |         | ±0.5pF  | GRM1552C1H6R1DA01# |
|        |               |         |         | ±0.05pF | GRM1552C1H6R2WA01# |
|        |               |         | 6.4pF   | ±0.1pF  | GRM1552C1H6R2BA01# |
|        |               |         |         | ±0.25pF | GRM1552C1H6R2CA01# |
|        |               |         |         | ±0.5pF  | GRM1552C1H6R2DA01# |
|        |               |         | 6.5pF   | ±0.05pF | GRM1552C1H6R3WA01# |
|        |               |         |         | ±0.1pF  | GRM1552C1H6R3BA01# |
|        |               |         |         | ±0.25pF | GRM1552C1H6R3CA01# |
|        |               |         | 6.6pF   | ±0.5pF  | GRM1552C1H6R3DA01# |
|        |               |         |         | ±0.05pF | GRM1552C1H6R4WA01# |
|        |               |         |         | ±0.1pF  | GRM1552C1H6R4BA01# |
|        |               |         | 6.7pF   | ±0.25pF | GRM1552C1H6R4CA01# |
|        |               |         |         | ±0.5pF  | GRM1552C1H6R4DA01# |
|        |               |         |         | ±0.05pF | GRM1552C1H6R5WA01# |
|        |               |         | 6.8pF   | ±0.1pF  | GRM1552C1H6R5BA01# |
|        |               |         |         | ±0.25pF | GRM1552C1H6R5CA01# |
|        |               |         |         | ±0.5pF  | GRM1552C1H6R5DA01# |
|        |               |         | 6.9pF   | ±0.05pF | GRM1552C1H6R6WA01# |
|        |               |         |         | ±0.1pF  | GRM1552C1H6R6BA01# |
|        |               |         |         | ±0.25pF | GRM1552C1H6R6CA01# |
|        |               |         | 7.0pF   | ±0.5pF  | GRM1552C1H6R6DA01# |
|        |               |         |         | ±0.05pF | GRM1552C1H6R7WA01# |
|        |               |         |         | ±0.1pF  | GRM1552C1H6R7BA01# |
|        |               |         | 7.1pF   | ±0.25pF | GRM1552C1H6R7CA01# |
|        |               |         |         | ±0.5pF  | GRM1552C1H6R7DA01# |
|        |               |         |         | ±0.05pF | GRM1552C1H6R8WA01# |
|        |               |         | 7.2pF   | ±0.1pF  | GRM1552C1H6R8BA01# |
|        |               |         |         | ±0.25pF | GRM1552C1H6R8CA01# |
|        |               |         |         | ±0.5pF  | GRM1552C1H6R8DA01# |
|        |               |         | 7.3pF   | ±0.05pF | GRM1552C1H6R9WA01# |
|        |               |         |         | ±0.1pF  | GRM1552C1H6R9BA01# |
|        |               |         |         | ±0.25pF | GRM1552C1H6R9CA01# |
|        |               |         | 7.4pF   | ±0.5pF  | GRM1552C1H6R9DA01# |
|        |               |         |         | ±0.05pF | GRM1552C1H7R0WA01# |
|        |               |         |         | ±0.1pF  | GRM1552C1H7R0BA01# |
|        |               |         | 7.5pF   | ±0.25pF | GRM1552C1H7R0CA01# |
|        |               |         |         | ±0.5pF  | GRM1552C1H7R0DA01# |
|        |               |         |         | ±0.05pF | GRM1552C1H7R1WA01# |
|        |               |         | 7.6pF   | ±0.1pF  | GRM1552C1H7R1BA01# |
|        |               |         |         | ±0.25pF | GRM1552C1H7R1CA01# |
|        |               |         |         | ±0.5pF  | GRM1552C1H7R1DA01# |
|        |               |         | 7.7pF   | ±0.05pF | GRM1552C1H7R2WA01# |
|        |               |         |         | ±0.1pF  | GRM1552C1H7R2BA01# |
|        |               |         |         | ±0.25pF | GRM1552C1H7R2CA01# |
|        |               |         | 7.8pF   | ±0.5pF  | GRM1552C1H7R2DA01# |
|        |               |         |         | ±0.05pF | GRM1552C1H7R3WA01# |
|        |               |         |         | ±0.1pF  | GRM1552C1H7R3BA01# |
|        |               |         | 7.9pF   | ±0.25pF | GRM1552C1H7R3CA01# |
|        |               |         |         | ±0.5pF  | GRM1552C1H7R3DA01# |
|        |               |         |         | ±0.05pF | GRM1552C1H7R4WA01# |
|        |               |         | 8.0pF   | ±0.1pF  | GRM1552C1H7R4BA01# |
|        |               |         |         | ±0.25pF | GRM1552C1H7R4CA01# |
|        |               |         |         | ±0.5pF  | GRM1552C1H7R4DA01# |

| T max. | Rated Voltage | TC Code | Cap.  | Tol.    | Part Number        |
|--------|---------------|---------|-------|---------|--------------------|
| 0.55mm | 50Vdc         | CH      | 6.7pF | ±0.1pF  | GRM1552C1H6R7BA01# |
|        |               |         |       | ±0.25pF | GRM1552C1H6R7CA01# |
|        |               |         |       | ±0.5pF  | GRM1552C1H6R7DA01# |
|        |               |         | 6.8pF | ±0.05pF | GRM1552C1H6R8WA01# |
|        |               |         |       | ±0.1pF  | GRM1552C1H6R8BA01# |
|        |               |         |       | ±0.25pF | GRM1552C1H6R8CA01# |
|        |               |         | 6.9pF | ±0.5pF  | GRM1552C1H6R8DA01# |
|        |               |         |       | ±0.05pF | GRM1552C1H6R9WA01# |
|        |               |         |       | ±0.1pF  | GRM1552C1H6R9BA01# |
|        |               |         | 7.0pF | ±0.25pF | GRM1552C1H6R9CA01# |
|        |               |         |       | ±0.5pF  | GRM1552C1H6R9DA01# |
|        |               |         |       | ±0.05pF | GRM1552C1H7R0WA01# |
|        |               |         | 7.1pF | ±0.1pF  | GRM1552C1H7R0BA01# |
|        |               |         |       | ±0.25pF | GRM1552C1H7R0CA01# |
|        |               |         |       | ±0.5pF  | GRM1552C1H7R0DA01# |
|        |               |         | 7.2pF | ±0.05pF | GRM1552C1H7R1WA01# |
|        |               |         |       | ±0.1pF  | GRM1552C1H7R1BA01# |
|        |               |         |       | ±0.25pF | GRM1552C1H7R1CA01# |
|        |               |         | 7.3pF | ±0.5pF  | GRM1552C1H7R1DA01# |
|        |               |         |       | ±0.05pF | GRM1552C1H7R2WA01# |
|        |               |         |       | ±0.1pF  | GRM1552C1H7R2BA01# |
|        |               |         | 7.4pF | ±0.25pF | GRM1552C1H7R2CA01# |
|        |               |         |       | ±0.5pF  | GRM1552C1H7R2DA01# |
|        |               |         |       | ±0.05pF | GRM1552C1H7R3WA01# |
|        |               |         | 7.5pF | ±0.1pF  | GRM1552C1H7R3BA01# |
|        |               |         |       | ±0.25pF | GRM1552C1H7R3CA01# |
|        |               |         |       | ±0.5pF  | GRM1552C1H7R3DA01# |
|        |               |         | 7.6pF | ±0.05pF | GRM1552C1H7R4WA01# |
|        |               |         |       | ±0.1pF  | GRM1552C1H7R4BA01# |
|        |               |         |       | ±0.25pF | GRM1552C1H7R4CA01# |
|        |               |         | 7.7pF | ±0.5pF  | GRM1552C1H7R4DA01# |
|        |               |         |       | ±0.05pF | GRM1552C1H7R5WA01# |
|        |               |         |       | ±0.1pF  | GRM1552C1H7R5BA01# |
|        |               |         | 7.8pF | ±0.25pF | GRM1552C1H7R5CA01# |
|        |               |         |       | ±0.5pF  | GRM1552C1H7R5DA01# |
|        |               |         |       | ±0.05pF | GRM1552C1H7R6WA01# |
|        |               |         | 7.9pF | ±0.1pF  | GRM1552C1H7R6BA01# |
|        |               |         |       | ±0.25pF | GRM1552C1H7R6CA01# |
|        |               |         |       | ±0.5pF  | GRM1552C1H7R6DA01# |
|        |               |         | 8.0pF | ±0.05pF | GRM1552C1H7R7WA01# |
|        |               |         |       | ±0.1pF  | GRM1552C1H7R7BA01# |
|        |               |         |       | ±0.25pF | GRM1552C1H7R7CA01# |
|        |               |         | 8.0pF | ±0.5pF  | GRM1552C1H7R7DA01# |
|        |               |         |       | ±0.05pF | GRM1552C1H7R8WA01# |
|        |               |         |       | ±0.1pF  | GRM1552C1H7R8BA01# |
|        |               |         | 8.0pF | ±0.25pF | GRM1552C1H7R8CA01# |
|        |               |         |       | ±0.5pF  | GRM1552C1H7R8DA01# |
|        |               |         |       | ±0.05pF | GRM1552C1H7R9WA01# |
|        |               |         | 8.0pF | ±0.1pF  | GRM1552C1H7R9BA01# |
|        |               |         |       | ±0.25pF | GRM1552C1H7R9CA01# |
|        |               |         |       | ±0.5pF  | GRM1552C1H7R9DA01# |
|        |               |         | 8.0pF | ±0.05pF | GRM1552C1H8R0WA01# |
|        |               |         |       | ±0.1pF  | GRM1552C1H8R0BA01# |
|        |               |         |       | ±0.25pF | GRM1552C1H8R0CA01# |

Part number # indicates the package specification code.

# GRM Series Temperature Compensating Type Part Number List

(→ 1.0×0.5mm)

| T max. | Rated Voltage | TC Code | Cap.  | Tol.    | Part Number        | T max. | Rated Voltage | TC Code | Cap.    | Tol.               | Part Number        |
|--------|---------------|---------|-------|---------|--------------------|--------|---------------|---------|---------|--------------------|--------------------|
| 0.55mm | 50Vdc         | CH      | 8.0pF | ±0.5pF  | GRM1552C1H8R0DA01# | 0.55mm | 50Vdc         | CH      | 9.4pF   | ±0.1pF             | GRM1552C1H9R4BA01# |
|        |               |         |       | ±0.05pF | GRM1552C1H8R1WA01# |        |               |         |         | ±0.25pF            | GRM1552C1H9R4CA01# |
|        |               |         |       | ±0.1pF  | GRM1552C1H8R1BA01# |        |               |         |         | ±0.5pF             | GRM1552C1H9R4DA01# |
|        |               |         | 8.1pF | ±0.25pF | GRM1552C1H8R1CA01# | 9.5pF  |               |         | ±0.05pF | GRM1552C1H9R5WA01# |                    |
|        |               |         |       | ±0.5pF  | GRM1552C1H8R1DA01# |        |               |         | ±0.1pF  | GRM1552C1H9R5BA01# |                    |
|        |               |         |       | ±0.05pF | GRM1552C1H8R2WA01# |        |               |         | ±0.25pF | GRM1552C1H9R5CA01# |                    |
|        |               |         |       | ±0.1pF  | GRM1552C1H8R2BA01# |        |               |         | ±0.5pF  | GRM1552C1H9R5DA01# |                    |
|        |               |         | 8.2pF | ±0.25pF | GRM1552C1H8R2CA01# | 9.6pF  |               |         | ±0.05pF | GRM1552C1H9R6WA01# |                    |
|        |               |         |       | ±0.5pF  | GRM1552C1H8R2DA01# |        |               |         | ±0.1pF  | GRM1552C1H9R6BA01# |                    |
|        |               |         |       | ±0.05pF | GRM1552C1H8R3WA01# |        |               |         | ±0.25pF | GRM1552C1H9R6CA01# |                    |
|        |               |         |       | ±0.1pF  | GRM1552C1H8R3BA01# |        |               |         | ±0.5pF  | GRM1552C1H9R6DA01# |                    |
|        |               |         | 8.3pF | ±0.25pF | GRM1552C1H8R3CA01# | 9.7pF  |               |         | ±0.05pF | GRM1552C1H9R7WA01# |                    |
|        |               |         |       | ±0.5pF  | GRM1552C1H8R3DA01# |        |               |         | ±0.1pF  | GRM1552C1H9R7BA01# |                    |
|        |               |         |       | ±0.05pF | GRM1552C1H8R4WA01# |        |               |         | ±0.25pF | GRM1552C1H9R7CA01# |                    |
|        |               |         |       | ±0.1pF  | GRM1552C1H8R4BA01# |        |               |         | ±0.5pF  | GRM1552C1H9R7DA01# |                    |
|        |               |         | 8.4pF | ±0.25pF | GRM1552C1H8R4CA01# | 9.8pF  |               |         | ±0.05pF | GRM1552C1H9R8WA01# |                    |
|        |               |         |       | ±0.5pF  | GRM1552C1H8R4DA01# |        |               |         | ±0.1pF  | GRM1552C1H9R8BA01# |                    |
|        |               |         |       | ±0.05pF | GRM1552C1H8R5WA01# |        |               |         | ±0.25pF | GRM1552C1H9R8CA01# |                    |
|        |               |         |       | ±0.1pF  | GRM1552C1H8R5BA01# |        |               |         | ±0.5pF  | GRM1552C1H9R8DA01# |                    |
|        |               |         | 8.5pF | ±0.25pF | GRM1552C1H8R5CA01# | 9.9pF  |               |         | ±0.05pF | GRM1552C1H9R9WA01# |                    |
|        |               |         |       | ±0.5pF  | GRM1552C1H8R5DA01# |        |               |         | ±0.1pF  | GRM1552C1H9R9BA01# |                    |
|        |               |         |       | ±0.05pF | GRM1552C1H8R6WA01# |        |               |         | ±0.25pF | GRM1552C1H9R9CA01# |                    |
|        |               |         |       | ±0.1pF  | GRM1552C1H8R6BA01# |        |               |         | ±0.5pF  | GRM1552C1H9R9DA01# |                    |
|        |               |         | 8.6pF | ±0.25pF | GRM1552C1H8R6CA01# | 10pF   |               |         | ±2%     | GRM1552C1H100GA01# |                    |
|        |               |         |       | ±0.5pF  | GRM1552C1H8R6DA01# |        |               |         | ±5%     | GRM1552C1H100JA01# |                    |
|        |               |         |       | ±0.05pF | GRM1552C1H8R7WA01# |        |               |         | 12pF    | ±2%                | GRM1552C1H120GA01# |
|        |               |         |       | ±0.1pF  | GRM1552C1H8R7BA01# |        |               |         |         | ±5%                | GRM1552C1H120JA01# |
|        |               |         | 8.7pF | ±0.25pF | GRM1552C1H8R7CA01# | 15pF   |               |         | ±2%     | GRM1552C1H150GA01# |                    |
|        |               |         |       | ±0.5pF  | GRM1552C1H8R7DA01# |        |               |         | ±5%     | GRM1552C1H150JA01# |                    |
|        |               |         |       | ±0.05pF | GRM1552C1H8R8WA01# | 18pF   |               |         | ±2%     | GRM1552C1H180GA01# |                    |
|        |               |         |       | ±0.1pF  | GRM1552C1H8R8BA01# |        |               |         | ±5%     | GRM1552C1H180JA01# |                    |
|        |               |         | 8.8pF | ±0.25pF | GRM1552C1H8R8CA01# | 22pF   |               |         | ±2%     | GRM1552C1H220GA01# |                    |
|        |               |         |       | ±0.5pF  | GRM1552C1H8R8DA01# |        |               |         | ±5%     | GRM1552C1H220JA01# |                    |
|        |               |         |       | ±0.05pF | GRM1552C1H8R9WA01# | 27pF   |               |         | ±2%     | GRM1552C1H270GA01# |                    |
|        |               |         |       | ±0.1pF  | GRM1552C1H8R9BA01# |        |               |         | ±5%     | GRM1552C1H270JA01# |                    |
|        |               |         | 8.9pF | ±0.25pF | GRM1552C1H8R9CA01# | 33pF   |               |         | ±2%     | GRM1552C1H330GA01# |                    |
|        |               |         |       | ±0.5pF  | GRM1552C1H8R9DA01# |        |               |         | ±5%     | GRM1552C1H330JA01# |                    |
|        |               |         |       | ±0.05pF | GRM1552C1H9R0WA01# | 39pF   |               |         | ±2%     | GRM1552C1H390GA01# |                    |
|        |               |         |       | ±0.1pF  | GRM1552C1H9R0BA01# |        |               |         | ±5%     | GRM1552C1H390JA01# |                    |
|        |               |         | 9.0pF | ±0.25pF | GRM1552C1H9R0CA01# | 47pF   |               |         | ±2%     | GRM1552C1H470GA01# |                    |
|        |               |         |       | ±0.5pF  | GRM1552C1H9R0DA01# |        |               |         | ±5%     | GRM1552C1H470JA01# |                    |
|        |               |         |       | ±0.05pF | GRM1552C1H9R1WA01# | 56pF   |               |         | ±2%     | GRM1552C1H560GA01# |                    |
|        |               |         |       | ±0.1pF  | GRM1552C1H9R1BA01# |        |               |         | ±5%     | GRM1552C1H560JA01# |                    |
|        |               |         | 9.1pF | ±0.25pF | GRM1552C1H9R1CA01# | 68pF   |               |         | ±2%     | GRM1552C1H680GA01# |                    |
|        |               |         |       | ±0.5pF  | GRM1552C1H9R1DA01# |        |               |         | ±5%     | GRM1552C1H680JA01# |                    |
|        |               |         |       | ±0.05pF | GRM1552C1H9R2WA01# | 82pF   |               |         | ±2%     | GRM1552C1H820GA01# |                    |
|        |               |         |       | ±0.1pF  | GRM1552C1H9R2BA01# |        |               |         | ±5%     | GRM1552C1H820JA01# |                    |
|        |               |         | 9.2pF | ±0.25pF | GRM1552C1H9R2CA01# | 100pF  |               |         | ±2%     | GRM1552C1H101GA01# |                    |
|        |               |         |       | ±0.5pF  | GRM1552C1H9R2DA01# |        |               |         | ±5%     | GRM1552C1H101JA01# |                    |
|        |               |         |       | ±0.05pF | GRM1552C1H9R3WA01# | 120pF  |               |         | ±2%     | GRM1552C1H121GA01# |                    |
|        |               |         |       | ±0.1pF  | GRM1552C1H9R3BA01# |        |               |         | ±5%     | GRM1552C1H121JA01# |                    |
|        |               |         | 9.3pF | ±0.25pF | GRM1552C1H9R3CA01# | 150pF  |               |         | ±2%     | GRM1552C1H151GA01# |                    |
|        |               |         |       | ±0.5pF  | GRM1552C1H9R3DA01# |        |               |         | ±5%     | GRM1552C1H151JA01# |                    |
|        |               |         |       | ±0.05pF | GRM1552C1H9R4WA01# | 180pF  |               |         | ±2%     | GRM1552C1H181GA01# |                    |
|        |               |         |       | ±0.1pF  | GRM1552C1H9R4BA01# |        |               |         | ±5%     | GRM1552C1H181JA01# |                    |

GRM  
 GR3  
 GRJ  
 GR4  
 GR7  
 GJM  
 GQM  
 GA2  
 GA3 GB  
 GA3 GD  
 GA3 GF  
 LLL  
 LLA  
 LLM  
 LLR  
 NFM  
 KRM  
 KR3  
 GMA  
 GMD  
 ⚠Caution /Notice

Part number # indicates the package specification code.

# GRM Series Temperature Compensating Type Part Number List

(→ 1.0×0.5mm)

| T max. | Rated Voltage | TC Code            | Cap.               | Tol.               | Part Number        |                    |
|--------|---------------|--------------------|--------------------|--------------------|--------------------|--------------------|
| 0.55mm | 50Vdc         | CH                 | 180pF              | ±5%                | GRM1552C1H181JA01# |                    |
|        |               |                    |                    | ±2%                | GRM1552C1H221GA01# |                    |
|        |               |                    | 220pF              | ±5%                | GRM1552C1H221JA01# |                    |
|        |               |                    |                    | ±2%                | GRM1552C1H271GA01# |                    |
|        |               |                    | 270pF              | ±5%                | GRM1552C1H271JA01# |                    |
|        |               |                    |                    | ±2%                | GRM1552C1H331GA01# |                    |
|        |               |                    | 330pF              | ±5%                | GRM1552C1H331JA01# |                    |
|        |               |                    |                    | ±2%                | GRM1552C1H391GA01# |                    |
|        |               |                    | 390pF              | ±5%                | GRM1552C1H391JA01# |                    |
|        |               |                    |                    | ±2%                | GRM1552C1H471GA01# |                    |
|        |               |                    | 470pF              | ±5%                | GRM1552C1H471JA01# |                    |
|        |               |                    |                    | ±2%                | GRM1552C1H561GA01# |                    |
|        |               |                    | 560pF              | ±5%                | GRM1552C1H561JA01# |                    |
|        |               |                    |                    | ±2%                | GRM1552C1H681GA01# |                    |
|        |               |                    | 680pF              | ±5%                | GRM1552C1H681JA01# |                    |
|        |               |                    |                    | ±2%                | GRM1552C1H821GA01# |                    |
|        |               |                    | 820pF              | ±5%                | GRM1552C1H821JA01# |                    |
|        |               |                    |                    | ±2%                | GRM1552C1H102GA01# |                    |
|        |               |                    | 1000pF             | ±5%                | GRM1552C1H102JA01# |                    |
|        |               |                    |                    | 10Vdc              | SL                 | 1200pF             |
|        | ±5%           | GRM1551X1A152JA01# |                    |                    |                    |                    |
|        | 1800pF        | ±5%                | GRM1551X1A182JA01# |                    |                    |                    |
|        |               | ±5%                | GRM1551X1A222JA01# |                    |                    |                    |
|        | 2700pF        | ±5%                | GRM1551X1A272JA01# |                    |                    |                    |
|        |               | ±5%                | GRM1551X1A332JA01# |                    |                    |                    |
|        | 3900pF        | ±5%                | GRM1551X1A392JA01# |                    |                    |                    |
|        |               | ±5%                | GRM1551X1A472JA01# |                    |                    |                    |
|        | U2J           | 1200pF             | ±5%                |                    |                    | GRM1557U1A122JA01# |
|        |               |                    | ±5%                |                    |                    | GRM1557U1A152JA01# |
|        |               | 1800pF             | ±5%                |                    | GRM1557U1A182JA01# |                    |
|        |               |                    | ±5%                |                    | GRM1557U1A222JA01# |                    |
|        |               | 2700pF             | ±5%                |                    | GRM1557U1A272JA01# |                    |
|        |               |                    | ±5%                |                    | GRM1557U1A332JA01# |                    |
|        |               | 3900pF             | ±5%                |                    | GRM1557U1A392JA01# |                    |
|        |               |                    | ±5%                |                    | GRM1557U1A472JA01# |                    |
|        |               | UJ                 | 1200pF             |                    | ±5%                | GRM1553U1A122JA01# |
|        |               |                    |                    |                    | ±5%                | GRM1553U1A152JA01# |
|        | 1800pF        |                    | ±5%                |                    | GRM1553U1A182JA01# |                    |
|        |               |                    | ±5%                |                    | GRM1553U1A222JA01# |                    |
|        | 2700pF        |                    | ±5%                | GRM1553U1A272JA01# |                    |                    |
| ±5%    |               |                    | GRM1553U1A332JA01# |                    |                    |                    |
| 3900pF | ±5%           |                    | GRM1553U1A392JA01# |                    |                    |                    |
|        | ±5%           |                    | GRM1553U1A472JA01# |                    |                    |                    |

| T max. | Rated Voltage | TC Code            | Cap.               | Tol.               | Part Number        |                    |
|--------|---------------|--------------------|--------------------|--------------------|--------------------|--------------------|
| 0.5mm  | 50Vdc         | U2J                | 2700pF             | ±5%                | GRM1857U1H272JA44# |                    |
|        |               |                    |                    | ±5%                | GRM1857U1H332JA44# |                    |
|        |               |                    | 3300pF             | ±5%                | GRM1857U1H392JA44# |                    |
|        |               |                    |                    | ±5%                | GRM1857U1H472JA44# |                    |
|        |               |                    | 4700pF             | ±5%                | GRM1853U1H222JA44# |                    |
|        |               |                    |                    | ±5%                | GRM1853U1H272JA44# |                    |
|        |               |                    | 2200pF             | ±5%                | GRM1853U1H332JA44# |                    |
|        |               |                    |                    | ±5%                | GRM1853U1H392JA44# |                    |
|        |               |                    | 3900pF             | ±5%                | GRM1853U1H472JA44# |                    |
|        |               |                    |                    | 10Vdc              | SL                 | 5600pF             |
|        |               | ±5%                | GRM1851X1A682JA44# |                    |                    |                    |
|        |               | 8200pF             | ±5%                |                    |                    | GRM1851X1A822JA44# |
|        |               |                    | ±5%                |                    |                    | GRM1851X1A103JA44# |
|        |               | U2J                | 5600pF             |                    | ±5%                | GRM1857U1A562JA44# |
|        |               |                    |                    |                    | ±5%                | GRM1857U1A682JA44# |
|        |               |                    | 8200pF             |                    | ±5%                | GRM1857U1A822JA44# |
|        |               |                    |                    |                    | ±5%                | GRM1857U1A103JA44# |
|        |               |                    | 5600pF             |                    | ±5%                | GRM1853U1A562JA44# |
|        |               |                    |                    |                    | ±5%                | GRM1853U1A682JA44# |
|        |               | 8200pF             | ±5%                | GRM1853U1A822JA44# |                    |                    |
|        | ±5%           |                    | GRM1853U1A103JA44# |                    |                    |                    |
|        | 100Vdc        | COG                | 0.50pF             | ±0.05pF            | GRM1885C2AR50WA01# |                    |
|        |               |                    |                    | ±0.1pF             | GRM1885C2AR50BA01# |                    |
|        |               |                    | 0.60pF             | ±0.05pF            | GRM1885C2AR60WA01# |                    |
|        |               |                    |                    | ±0.1pF             | GRM1885C2AR60BA01# |                    |
|        |               |                    | 0.70pF             | ±0.05pF            | GRM1885C2AR70WA01# |                    |
|        |               |                    |                    | ±0.1pF             | GRM1885C2AR70BA01# |                    |
|        |               |                    | 0.80pF             | ±0.05pF            | GRM1885C2AR80WA01# |                    |
|        |               |                    |                    | ±0.1pF             | GRM1885C2AR80BA01# |                    |
|        |               |                    | 0.90pF             | ±0.05pF            | GRM1885C2AR90WA01# |                    |
|        |               |                    |                    | ±0.1pF             | GRM1885C2AR90BA01# |                    |
|        |               |                    | 1.0pF              | ±0.05pF            | GRM1885C2A1R0WA01# |                    |
|        |               |                    |                    | ±0.1pF             | GRM1885C2A1R0BA01# |                    |
|        |               |                    |                    | ±0.25pF            | GRM1885C2A1R0CA01# |                    |
|        |               |                    |                    | ±0.05pF            | GRM1885C2A1R1WA01# |                    |
|        |               |                    | 1.1pF              | ±0.1pF             | GRM1885C2A1R1BA01# |                    |
|        |               |                    |                    | ±0.25pF            | GRM1885C2A1R1CA01# |                    |
|        |               |                    | 1.2pF              | ±0.05pF            | GRM1885C2A1R2WA01# |                    |
|        |               |                    |                    | ±0.1pF             | GRM1885C2A1R2BA01# |                    |
|        |               |                    |                    | ±0.25pF            | GRM1885C2A1R2CA01# |                    |
| 1.3pF  |               |                    | ±0.05pF            | GRM1885C2A1R3WA01# |                    |                    |
|        | ±0.1pF        | GRM1885C2A1R3BA01# |                    |                    |                    |                    |
|        | ±0.25pF       | GRM1885C2A1R3CA01# |                    |                    |                    |                    |
| 1.4pF  | ±0.05pF       | GRM1885C2A1R4WA01# |                    |                    |                    |                    |
|        | ±0.1pF        | GRM1885C2A1R4BA01# |                    |                    |                    |                    |
|        | ±0.25pF       | GRM1885C2A1R4CA01# |                    |                    |                    |                    |
| 1.5pF  | ±0.05pF       | GRM1885C2A1R5WA01# |                    |                    |                    |                    |
|        | ±0.1pF        | GRM1885C2A1R5BA01# |                    |                    |                    |                    |
|        | ±0.25pF       | GRM1885C2A1R5CA01# |                    |                    |                    |                    |
| 1.6pF  | ±0.05pF       | GRM1885C2A1R6WA01# |                    |                    |                    |                    |
|        | ±0.1pF        | GRM1885C2A1R6BA01# |                    |                    |                    |                    |
|        | ±0.25pF       | GRM1885C2A1R6CA01# |                    |                    |                    |                    |
| 1.7pF  | ±0.05pF       | GRM1885C2A1R7WA01# |                    |                    |                    |                    |
|        | ±0.1pF        | GRM1885C2A1R7BA01# |                    |                    |                    |                    |

1.6×0.8mm

| T max. | Rated Voltage | TC Code | Cap.   | Tol.   | Part Number        |
|--------|---------------|---------|--------|--------|--------------------|
| 0.5mm  | 50Vdc         | SL      | 2200pF | ±5%    | GRM1851X1H222JA44# |
|        |               |         |        | ±5%    | GRM1851X1H272JA44# |
|        |               |         | 3300pF | ±5%    | GRM1851X1H332JA44# |
|        |               |         |        | ±5%    | GRM1851X1H392JA44# |
|        |               |         | 4700pF | ±5%    | GRM1851X1H472JA44# |
|        |               | U2J     |        | 2200pF | ±5%                |

Part number # indicates the package specification code.

# GRM Series Temperature Compensating Type Part Number List

(→ 1.6×0.8mm)

| T max. | Rated Voltage | TC Code | Cap.    | Tol.    | Part Number        | T max. | Rated Voltage | TC Code | Cap.    | Tol.               | Part Number        |         |                    |
|--------|---------------|---------|---------|---------|--------------------|--------|---------------|---------|---------|--------------------|--------------------|---------|--------------------|
| 0.9mm  | 100Vdc        | COG     | 1.7pF   | ±0.25pF | GRM1885C2A1R7CA01# | 0.9mm  | 100Vdc        | COG     | 3.5pF   | ±0.25pF            | GRM1885C2A3R5CA01# |         |                    |
|        |               |         |         | 1.8pF   | ±0.05pF            |        |               |         |         | GRM1885C2A1R8WA01# | 3.6pF              | ±0.05pF | GRM1885C2A3R6WA01# |
|        |               |         |         |         | ±0.1pF             |        |               |         |         | GRM1885C2A1R8BA01# |                    | ±0.1pF  | GRM1885C2A3R6BA01# |
|        |               |         | ±0.25pF |         | GRM1885C2A1R8CA01# |        |               |         | ±0.25pF | GRM1885C2A3R6CA01# |                    |         |                    |
|        |               |         | 1.9pF   | ±0.05pF | GRM1885C2A1R9WA01# |        |               |         | 3.7pF   | ±0.05pF            | GRM1885C2A3R7WA01# |         |                    |
|        |               |         |         | ±0.1pF  | GRM1885C2A1R9BA01# |        |               |         |         | ±0.1pF             | GRM1885C2A3R7BA01# |         |                    |
|        |               |         |         | ±0.25pF | GRM1885C2A1R9CA01# |        |               |         |         | ±0.25pF            | GRM1885C2A3R7CA01# |         |                    |
|        |               |         | 2.0pF   | ±0.05pF | GRM1885C2A2R0WA01# |        |               |         | 3.8pF   | ±0.05pF            | GRM1885C2A3R8WA01# |         |                    |
|        |               |         |         | ±0.1pF  | GRM1885C2A2R0BA01# |        |               |         |         | ±0.1pF             | GRM1885C2A3R8BA01# |         |                    |
|        |               |         |         | ±0.25pF | GRM1885C2A2R0CA01# |        |               |         |         | ±0.25pF            | GRM1885C2A3R8CA01# |         |                    |
|        |               |         | 2.1pF   | ±0.05pF | GRM1885C2A2R1WA01# |        |               |         | 3.9pF   | ±0.05pF            | GRM1885C2A3R9WA01# |         |                    |
|        |               |         |         | ±0.1pF  | GRM1885C2A2R1BA01# |        |               |         |         | ±0.1pF             | GRM1885C2A3R9BA01# |         |                    |
|        |               |         |         | ±0.25pF | GRM1885C2A2R1CA01# |        |               |         |         | ±0.25pF            | GRM1885C2A3R9CA01# |         |                    |
|        |               |         | 2.2pF   | ±0.05pF | GRM1885C2A2R2WA01# |        |               |         | 4.0pF   | ±0.05pF            | GRM1885C2A4R0WA01# |         |                    |
|        |               |         |         | ±0.1pF  | GRM1885C2A2R2BA01# |        |               |         |         | ±0.1pF             | GRM1885C2A4R0BA01# |         |                    |
|        |               |         |         | ±0.25pF | GRM1885C2A2R2CA01# |        |               |         |         | ±0.25pF            | GRM1885C2A4R0CA01# |         |                    |
|        |               |         | 2.3pF   | ±0.05pF | GRM1885C2A2R3WA01# |        |               |         | 4.1pF   | ±0.05pF            | GRM1885C2A4R1WA01# |         |                    |
|        |               |         |         | ±0.1pF  | GRM1885C2A2R3BA01# |        |               |         |         | ±0.1pF             | GRM1885C2A4R1BA01# |         |                    |
|        |               |         |         | ±0.25pF | GRM1885C2A2R3CA01# |        |               |         |         | ±0.25pF            | GRM1885C2A4R1CA01# |         |                    |
|        |               |         | 2.4pF   | ±0.05pF | GRM1885C2A2R4WA01# |        |               |         | 4.2pF   | ±0.05pF            | GRM1885C2A4R2WA01# |         |                    |
|        |               |         |         | ±0.1pF  | GRM1885C2A2R4BA01# |        |               |         |         | ±0.1pF             | GRM1885C2A4R2BA01# |         |                    |
|        |               |         |         | ±0.25pF | GRM1885C2A2R4CA01# |        |               |         |         | ±0.25pF            | GRM1885C2A4R2CA01# |         |                    |
|        |               |         | 2.5pF   | ±0.05pF | GRM1885C2A2R5WA01# |        |               |         | 4.3pF   | ±0.05pF            | GRM1885C2A4R3WA01# |         |                    |
|        |               |         |         | ±0.1pF  | GRM1885C2A2R5BA01# |        |               |         |         | ±0.1pF             | GRM1885C2A4R3BA01# |         |                    |
|        |               |         |         | ±0.25pF | GRM1885C2A2R5CA01# |        |               |         |         | ±0.25pF            | GRM1885C2A4R3CA01# |         |                    |
|        |               |         | 2.6pF   | ±0.05pF | GRM1885C2A2R6WA01# |        |               |         | 4.4pF   | ±0.05pF            | GRM1885C2A4R4WA01# |         |                    |
|        |               |         |         | ±0.1pF  | GRM1885C2A2R6BA01# |        |               |         |         | ±0.1pF             | GRM1885C2A4R4BA01# |         |                    |
|        |               |         |         | ±0.25pF | GRM1885C2A2R6CA01# |        |               |         |         | ±0.25pF            | GRM1885C2A4R4CA01# |         |                    |
|        |               |         | 2.7pF   | ±0.05pF | GRM1885C2A2R7WA01# |        |               |         | 4.5pF   | ±0.05pF            | GRM1885C2A4R5WA01# |         |                    |
|        |               |         |         | ±0.1pF  | GRM1885C2A2R7BA01# |        |               |         |         | ±0.1pF             | GRM1885C2A4R5BA01# |         |                    |
|        |               |         |         | ±0.25pF | GRM1885C2A2R7CA01# |        |               |         |         | ±0.25pF            | GRM1885C2A4R5CA01# |         |                    |
|        |               |         | 2.8pF   | ±0.05pF | GRM1885C2A2R8WA01# |        |               |         | 4.6pF   | ±0.05pF            | GRM1885C2A4R6WA01# |         |                    |
|        |               |         |         | ±0.1pF  | GRM1885C2A2R8BA01# |        |               |         |         | ±0.1pF             | GRM1885C2A4R6BA01# |         |                    |
|        |               |         |         | ±0.25pF | GRM1885C2A2R8CA01# |        |               |         |         | ±0.25pF            | GRM1885C2A4R6CA01# |         |                    |
|        |               |         | 2.9pF   | ±0.05pF | GRM1885C2A2R9WA01# |        |               |         | 4.7pF   | ±0.05pF            | GRM1885C2A4R7WA01# |         |                    |
|        |               |         |         | ±0.1pF  | GRM1885C2A2R9BA01# |        |               |         |         | ±0.1pF             | GRM1885C2A4R7BA01# |         |                    |
|        |               |         |         | ±0.25pF | GRM1885C2A2R9CA01# |        |               |         |         | ±0.25pF            | GRM1885C2A4R7CA01# |         |                    |
|        |               |         | 3.0pF   | ±0.05pF | GRM1885C2A3R0WA01# |        |               |         | 4.8pF   | ±0.05pF            | GRM1885C2A4R8WA01# |         |                    |
|        |               |         |         | ±0.1pF  | GRM1885C2A3R0BA01# |        |               |         |         | ±0.1pF             | GRM1885C2A4R8BA01# |         |                    |
|        |               |         |         | ±0.25pF | GRM1885C2A3R0CA01# |        |               |         |         | ±0.25pF            | GRM1885C2A4R8CA01# |         |                    |
|        |               |         | 3.1pF   | ±0.05pF | GRM1885C2A3R1WA01# |        |               |         | 4.9pF   | ±0.05pF            | GRM1885C2A4R9WA01# |         |                    |
|        |               |         |         | ±0.1pF  | GRM1885C2A3R1BA01# |        |               |         |         | ±0.1pF             | GRM1885C2A4R9BA01# |         |                    |
|        |               |         |         | ±0.25pF | GRM1885C2A3R1CA01# |        |               |         |         | ±0.25pF            | GRM1885C2A4R9CA01# |         |                    |
|        |               |         | 3.2pF   | ±0.05pF | GRM1885C2A3R2WA01# |        |               |         | 5.0pF   | ±0.05pF            | GRM1885C2A5R0WA01# |         |                    |
|        |               |         |         | ±0.1pF  | GRM1885C2A3R2BA01# |        |               |         |         | ±0.1pF             | GRM1885C2A5R0BA01# |         |                    |
|        |               |         |         | ±0.25pF | GRM1885C2A3R2CA01# |        |               |         |         | ±0.25pF            | GRM1885C2A5R0CA01# |         |                    |
|        |               |         | 3.3pF   | ±0.05pF | GRM1885C2A3R3WA01# |        |               |         | 5.1pF   | ±0.05pF            | GRM1885C2A5R1WA01# |         |                    |
|        |               |         |         | ±0.1pF  | GRM1885C2A3R3BA01# |        |               |         |         | ±0.1pF             | GRM1885C2A5R1BA01# |         |                    |
|        |               |         |         | ±0.25pF | GRM1885C2A3R3CA01# |        |               |         |         | ±0.25pF            | GRM1885C2A5R1CA01# |         |                    |
|        |               |         | 3.4pF   | ±0.05pF | GRM1885C2A3R4WA01# |        |               |         | 5.2pF   | ±0.05pF            | GRM1885C2A5R2WA01# |         |                    |
|        |               |         |         | ±0.1pF  | GRM1885C2A3R4BA01# |        |               |         |         | ±0.1pF             | GRM1885C2A5R2BA01# |         |                    |
|        |               |         |         | ±0.25pF | GRM1885C2A3R4CA01# |        |               |         |         | ±0.25pF            | GRM1885C2A5R2CA01# |         |                    |
|        |               |         | 3.5pF   | ±0.05pF | GRM1885C2A3R5WA01# |        |               |         | 5.2pF   | ±0.05pF            | GRM1885C2A5R2WA01# |         |                    |
|        |               |         |         | ±0.1pF  | GRM1885C2A3R5BA01# |        |               |         |         | ±0.1pF             | GRM1885C2A5R2BA01# |         |                    |
|        |               |         |         |         |                    |        |               |         | ±0.5pF  |                    | GRM1885C2A5R2DA01# |         |                    |

GRM  
 GR3  
 GRJ  
 GR4  
 GR7  
 GJM  
 GQM  
 GA2  
 GA3 GB  
 GA3 GD  
 GA3 GF  
 LLL  
 LLA  
 LLM  
 LLR  
 NFM  
 KRM  
 KR3  
 GMA  
 GMD  
 ⚠Caution /Notice

Part number # indicates the package specification code.

# GRM Series Temperature Compensating Type Part Number List

(→ 1.6×0.8mm)

| T max. | Rated Voltage | TC Code            | Cap.    | Tol.               | Part Number        | T max. | Rated Voltage | TC Code | Cap.    | Tol.    | Part Number        |                    |
|--------|---------------|--------------------|---------|--------------------|--------------------|--------|---------------|---------|---------|---------|--------------------|--------------------|
| 0.9mm  | 100Vdc        | COG                | 5.3pF   | ±0.05pF            | GRM1885C2A5R3WA01# | 0.9mm  | 100Vdc        | COG     | 6.6pF   | ±0.25pF | GRM1885C2A6R6CA01# |                    |
|        |               |                    |         | ±0.1pF             | GRM1885C2A5R3BA01# |        |               |         |         | ±0.5pF  | GRM1885C2A6R6DA01# |                    |
|        |               |                    |         | ±0.25pF            | GRM1885C2A5R3CA01# |        |               |         |         | 6.7pF   | ±0.05pF            | GRM1885C2A6R7WA01# |
|        |               |                    |         | ±0.5pF             | GRM1885C2A5R3DA01# |        |               |         |         |         | ±0.1pF             | GRM1885C2A6R7BA01# |
|        |               |                    | 5.4pF   | ±0.05pF            | GRM1885C2A5R4WA01# |        |               |         | ±0.25pF |         | GRM1885C2A6R7CA01# |                    |
|        |               |                    |         | ±0.1pF             | GRM1885C2A5R4BA01# |        |               |         | ±0.5pF  |         | GRM1885C2A6R7DA01# |                    |
|        |               |                    |         | ±0.25pF            | GRM1885C2A5R4CA01# |        |               |         | 6.8pF   | ±0.05pF | GRM1885C2A6R8WA01# |                    |
|        |               |                    |         | ±0.5pF             | GRM1885C2A5R4DA01# |        |               |         |         | ±0.1pF  | GRM1885C2A6R8BA01# |                    |
|        |               |                    | 5.5pF   | ±0.05pF            | GRM1885C2A5R5WA01# |        |               |         |         | ±0.25pF | GRM1885C2A6R8CA01# |                    |
|        |               |                    |         | ±0.1pF             | GRM1885C2A5R5BA01# |        |               |         |         | ±0.5pF  | GRM1885C2A6R8DA01# |                    |
|        |               |                    |         | ±0.25pF            | GRM1885C2A5R5CA01# |        |               |         | 6.9pF   | ±0.05pF | GRM1885C2A6R9WA01# |                    |
|        |               |                    |         | ±0.5pF             | GRM1885C2A5R5DA01# |        |               |         |         | ±0.1pF  | GRM1885C2A6R9BA01# |                    |
|        |               |                    | 5.6pF   | ±0.05pF            | GRM1885C2A5R6WA01# |        |               |         |         | ±0.25pF | GRM1885C2A6R9CA01# |                    |
|        |               |                    |         | ±0.1pF             | GRM1885C2A5R6BA01# |        |               |         |         | ±0.5pF  | GRM1885C2A6R9DA01# |                    |
|        |               |                    |         | ±0.25pF            | GRM1885C2A5R6CA01# |        |               |         | 7.0pF   | ±0.05pF | GRM1885C2A7R0WA01# |                    |
|        |               |                    |         | ±0.5pF             | GRM1885C2A5R6DA01# |        |               |         |         | ±0.1pF  | GRM1885C2A7R0BA01# |                    |
|        |               |                    | 5.7pF   | ±0.05pF            | GRM1885C2A5R7WA01# |        |               |         |         | ±0.25pF | GRM1885C2A7R0CA01# |                    |
|        |               |                    |         | ±0.1pF             | GRM1885C2A5R7BA01# |        |               |         |         | ±0.5pF  | GRM1885C2A7R0DA01# |                    |
|        |               |                    |         | ±0.25pF            | GRM1885C2A5R7CA01# |        |               |         | 7.1pF   | ±0.05pF | GRM1885C2A7R1WA01# |                    |
|        |               |                    |         | ±0.5pF             | GRM1885C2A5R7DA01# |        |               |         |         | ±0.1pF  | GRM1885C2A7R1BA01# |                    |
|        |               |                    | 5.8pF   | ±0.05pF            | GRM1885C2A5R8WA01# |        |               |         |         | ±0.25pF | GRM1885C2A7R1CA01# |                    |
|        |               |                    |         | ±0.1pF             | GRM1885C2A5R8BA01# |        |               |         |         | ±0.5pF  | GRM1885C2A7R1DA01# |                    |
|        |               |                    |         | ±0.25pF            | GRM1885C2A5R8CA01# |        |               |         | 7.2pF   | ±0.05pF | GRM1885C2A7R2WA01# |                    |
|        |               |                    |         | ±0.5pF             | GRM1885C2A5R8DA01# |        |               |         |         | ±0.1pF  | GRM1885C2A7R2BA01# |                    |
|        |               |                    | 5.9pF   | ±0.05pF            | GRM1885C2A5R9WA01# |        |               |         |         | ±0.25pF | GRM1885C2A7R2CA01# |                    |
|        |               |                    |         | ±0.1pF             | GRM1885C2A5R9BA01# |        |               |         |         | ±0.5pF  | GRM1885C2A7R2DA01# |                    |
|        |               |                    |         | ±0.25pF            | GRM1885C2A5R9CA01# |        |               |         | 7.3pF   | ±0.05pF | GRM1885C2A7R3WA01# |                    |
|        |               |                    |         | ±0.5pF             | GRM1885C2A5R9DA01# |        |               |         |         | ±0.1pF  | GRM1885C2A7R3BA01# |                    |
|        |               |                    | 6.0pF   | ±0.05pF            | GRM1885C2A6R0WA01# |        |               |         |         | ±0.25pF | GRM1885C2A7R3CA01# |                    |
|        |               |                    |         | ±0.1pF             | GRM1885C2A6R0BA01# |        |               |         |         | ±0.5pF  | GRM1885C2A7R3DA01# |                    |
|        |               |                    |         | ±0.25pF            | GRM1885C2A6R0CA01# |        |               |         | 7.4pF   | ±0.05pF | GRM1885C2A7R4WA01# |                    |
|        |               |                    |         | ±0.5pF             | GRM1885C2A6R0DA01# |        |               |         |         | ±0.1pF  | GRM1885C2A7R4BA01# |                    |
|        |               |                    | 6.1pF   | ±0.05pF            | GRM1885C2A6R1WA01# |        |               |         |         | ±0.25pF | GRM1885C2A7R4CA01# |                    |
|        |               |                    |         | ±0.1pF             | GRM1885C2A6R1BA01# |        |               |         |         | ±0.5pF  | GRM1885C2A7R4DA01# |                    |
|        |               |                    |         | ±0.25pF            | GRM1885C2A6R1CA01# |        |               |         | 7.5pF   | ±0.05pF | GRM1885C2A7R5WA01# |                    |
|        |               |                    |         | ±0.5pF             | GRM1885C2A6R1DA01# |        |               |         |         | ±0.1pF  | GRM1885C2A7R5BA01# |                    |
|        |               |                    | 6.2pF   | ±0.05pF            | GRM1885C2A6R2WA01# |        |               |         |         | ±0.25pF | GRM1885C2A7R5CA01# |                    |
|        |               |                    |         | ±0.1pF             | GRM1885C2A6R2BA01# |        |               |         |         | ±0.5pF  | GRM1885C2A7R5DA01# |                    |
|        |               |                    |         | ±0.25pF            | GRM1885C2A6R2CA01# |        |               |         | 7.6pF   | ±0.05pF | GRM1885C2A7R6WA01# |                    |
|        |               |                    |         | ±0.5pF             | GRM1885C2A6R2DA01# |        |               |         |         | ±0.1pF  | GRM1885C2A7R6BA01# |                    |
|        |               |                    | 6.3pF   | ±0.05pF            | GRM1885C2A6R3WA01# |        |               |         |         | ±0.25pF | GRM1885C2A7R6CA01# |                    |
|        |               |                    |         | ±0.1pF             | GRM1885C2A6R3BA01# |        |               |         |         | ±0.5pF  | GRM1885C2A7R6DA01# |                    |
|        |               |                    |         | ±0.25pF            | GRM1885C2A6R3CA01# |        |               |         | 7.7pF   | ±0.05pF | GRM1885C2A7R7WA01# |                    |
|        |               |                    |         | ±0.5pF             | GRM1885C2A6R3DA01# |        |               |         |         | ±0.1pF  | GRM1885C2A7R7BA01# |                    |
|        |               |                    | 6.4pF   | ±0.05pF            | GRM1885C2A6R4WA01# |        |               |         |         | ±0.25pF | GRM1885C2A7R7CA01# |                    |
|        |               |                    |         | ±0.1pF             | GRM1885C2A6R4BA01# |        |               |         |         | ±0.5pF  | GRM1885C2A7R7DA01# |                    |
|        |               |                    |         | ±0.25pF            | GRM1885C2A6R4CA01# |        |               |         | 7.8pF   | ±0.05pF | GRM1885C2A7R8WA01# |                    |
|        |               |                    |         | ±0.5pF             | GRM1885C2A6R4DA01# |        |               |         |         | ±0.1pF  | GRM1885C2A7R8BA01# |                    |
| 6.5pF  | ±0.05pF       | GRM1885C2A6R5WA01# | ±0.25pF | GRM1885C2A7R8CA01# |                    |        |               |         |         |         |                    |                    |
|        | ±0.1pF        | GRM1885C2A6R5BA01# | ±0.5pF  | GRM1885C2A7R8DA01# |                    |        |               |         |         |         |                    |                    |
|        | ±0.25pF       | GRM1885C2A6R5CA01# | 7.9pF   | ±0.05pF            | GRM1885C2A7R9WA01# |        |               |         |         |         |                    |                    |
|        | ±0.5pF        | GRM1885C2A6R5DA01# |         | ±0.1pF             | GRM1885C2A7R9BA01# |        |               |         |         |         |                    |                    |
| 6.6pF  | ±0.05pF       | GRM1885C2A6R6WA01# |         | ±0.25pF            | GRM1885C2A7R9CA01# |        |               |         |         |         |                    |                    |
|        | ±0.1pF        | GRM1885C2A6R6BA01# |         | ±0.5pF             | GRM1885C2A7R9DA01# |        |               |         |         |         |                    |                    |

Part number # indicates the package specification code.



# GRM Series Temperature Compensating Type Part Number List

(→ 1.6×0.8mm)

| T max. | Rated Voltage | TC Code | Cap.  | Tol.    | Part Number        | T max. | Rated Voltage | TC Code | Cap.    | Tol.    | Part Number        |                    |
|--------|---------------|---------|-------|---------|--------------------|--------|---------------|---------|---------|---------|--------------------|--------------------|
| 0.9mm  | 100Vdc        | COG     | 8.0pF | ±0.05pF | GRM1885C2A8R0WA01# | 0.9mm  | 100Vdc        | COG     | 9.3pF   | ±0.25pF | GRM1885C2A9R3CA01# |                    |
|        |               |         |       | ±0.1pF  | GRM1885C2A8R0BA01# |        |               |         |         | ±0.5pF  | GRM1885C2A9R3DA01# |                    |
|        |               |         |       | ±0.25pF | GRM1885C2A8R0CA01# |        |               |         |         | 9.4pF   | ±0.05pF            | GRM1885C2A9R4WA01# |
|        |               |         |       | ±0.5pF  | GRM1885C2A8R0DA01# |        |               |         |         |         | ±0.1pF             | GRM1885C2A9R4BA01# |
|        |               |         | 8.1pF | ±0.05pF | GRM1885C2A8R1WA01# |        |               |         | ±0.25pF |         | GRM1885C2A9R4CA01# |                    |
|        |               |         |       | ±0.1pF  | GRM1885C2A8R1BA01# |        |               |         | ±0.5pF  |         | GRM1885C2A9R4DA01# |                    |
|        |               |         |       | ±0.25pF | GRM1885C2A8R1CA01# |        |               |         | 9.5pF   | ±0.05pF | GRM1885C2A9R5WA01# |                    |
|        |               |         |       | ±0.5pF  | GRM1885C2A8R1DA01# |        |               |         |         | ±0.1pF  | GRM1885C2A9R5BA01# |                    |
|        |               |         | 8.2pF | ±0.05pF | GRM1885C2A8R2WA01# |        |               |         |         | ±0.25pF | GRM1885C2A9R5CA01# |                    |
|        |               |         |       | ±0.1pF  | GRM1885C2A8R2BA01# |        |               |         |         | ±0.5pF  | GRM1885C2A9R5DA01# |                    |
|        |               |         |       | ±0.25pF | GRM1885C2A8R2CA01# |        |               |         | 9.6pF   | ±0.05pF | GRM1885C2A9R6WA01# |                    |
|        |               |         |       | ±0.5pF  | GRM1885C2A8R2DA01# |        |               |         |         | ±0.1pF  | GRM1885C2A9R6BA01# |                    |
|        |               |         | 8.3pF | ±0.05pF | GRM1885C2A8R3WA01# |        |               |         |         | ±0.25pF | GRM1885C2A9R6CA01# |                    |
|        |               |         |       | ±0.1pF  | GRM1885C2A8R3BA01# |        |               |         |         | ±0.5pF  | GRM1885C2A9R6DA01# |                    |
|        |               |         |       | ±0.25pF | GRM1885C2A8R3CA01# |        |               |         | 9.7pF   | ±0.05pF | GRM1885C2A9R7WA01# |                    |
|        |               |         |       | ±0.5pF  | GRM1885C2A8R3DA01# |        |               |         |         | ±0.1pF  | GRM1885C2A9R7BA01# |                    |
|        |               |         | 8.4pF | ±0.05pF | GRM1885C2A8R4WA01# |        |               |         |         | ±0.25pF | GRM1885C2A9R7CA01# |                    |
|        |               |         |       | ±0.1pF  | GRM1885C2A8R4BA01# |        |               |         |         | ±0.5pF  | GRM1885C2A9R7DA01# |                    |
|        |               |         |       | ±0.25pF | GRM1885C2A8R4CA01# |        |               |         | 9.8pF   | ±0.05pF | GRM1885C2A9R8WA01# |                    |
|        |               |         |       | ±0.5pF  | GRM1885C2A8R4DA01# |        |               |         |         | ±0.1pF  | GRM1885C2A9R8BA01# |                    |
|        |               |         | 8.5pF | ±0.05pF | GRM1885C2A8R5WA01# |        |               |         |         | ±0.25pF | GRM1885C2A9R8CA01# |                    |
|        |               |         |       | ±0.1pF  | GRM1885C2A8R5BA01# |        |               |         |         | ±0.5pF  | GRM1885C2A9R8DA01# |                    |
|        |               |         |       | ±0.25pF | GRM1885C2A8R5CA01# |        |               |         | 9.9pF   | ±0.05pF | GRM1885C2A9R9WA01# |                    |
|        |               |         |       | ±0.5pF  | GRM1885C2A8R5DA01# |        |               |         |         | ±0.1pF  | GRM1885C2A9R9BA01# |                    |
|        |               |         | 8.6pF | ±0.05pF | GRM1885C2A8R6WA01# |        |               |         |         | ±0.25pF | GRM1885C2A9R9CA01# |                    |
|        |               |         |       | ±0.1pF  | GRM1885C2A8R6BA01# |        |               |         |         | ±0.5pF  | GRM1885C2A9R9DA01# |                    |
|        |               |         |       | ±0.25pF | GRM1885C2A8R6CA01# |        |               |         | 10pF    | ±5%     | GRM1885C2A100JA01# |                    |
|        |               |         |       | ±0.5pF  | GRM1885C2A8R6DA01# |        |               |         | 12pF    | ±5%     | GRM1885C2A120JA01# |                    |
|        |               |         | 8.7pF | ±0.05pF | GRM1885C2A8R7WA01# |        |               |         | 15pF    | ±5%     | GRM1885C2A150JA01# |                    |
|        |               |         |       | ±0.1pF  | GRM1885C2A8R7BA01# |        |               |         | 18pF    | ±5%     | GRM1885C2A180JA01# |                    |
|        |               |         |       | ±0.25pF | GRM1885C2A8R7CA01# |        |               |         | 22pF    | ±5%     | GRM1885C2A220JA01# |                    |
|        |               |         |       | ±0.5pF  | GRM1885C2A8R7DA01# |        |               |         | 27pF    | ±5%     | GRM1885C2A270JA01# |                    |
|        |               |         | 8.8pF | ±0.05pF | GRM1885C2A8R8WA01# |        |               |         | 33pF    | ±5%     | GRM1885C2A330JA01# |                    |
|        |               |         |       | ±0.1pF  | GRM1885C2A8R8BA01# |        |               |         | 39pF    | ±5%     | GRM1885C2A390JA01# |                    |
|        |               |         |       | ±0.25pF | GRM1885C2A8R8CA01# |        |               |         | 47pF    | ±5%     | GRM1885C2A470JA01# |                    |
|        |               |         |       | ±0.5pF  | GRM1885C2A8R8DA01# |        |               |         | 56pF    | ±5%     | GRM1885C2A560JA01# |                    |
|        |               |         | 8.9pF | ±0.05pF | GRM1885C2A8R9WA01# |        |               |         | 68pF    | ±5%     | GRM1885C2A680JA01# |                    |
|        |               |         |       | ±0.1pF  | GRM1885C2A8R9BA01# |        |               |         | 82pF    | ±5%     | GRM1885C2A820JA01# |                    |
|        |               |         |       | ±0.25pF | GRM1885C2A8R9CA01# |        |               |         | 100pF   | ±5%     | GRM1885C2A101JA01# |                    |
|        |               |         |       | ±0.5pF  | GRM1885C2A8R9DA01# |        |               |         | 120pF   | ±5%     | GRM1885C2A121JA01# |                    |
|        |               |         | 9.0pF | ±0.05pF | GRM1885C2A9R0WA01# |        |               |         | 150pF   | ±5%     | GRM1885C2A151JA01# |                    |
|        |               |         |       | ±0.1pF  | GRM1885C2A9R0BA01# |        |               |         | 180pF   | ±5%     | GRM1885C2A181JA01# |                    |
|        |               |         |       | ±0.25pF | GRM1885C2A9R0CA01# |        |               |         | 220pF   | ±5%     | GRM1885C2A221JA01# |                    |
|        |               |         |       | ±0.5pF  | GRM1885C2A9R0DA01# |        |               |         | 270pF   | ±5%     | GRM1885C2A271JA01# |                    |
|        |               |         | 9.1pF | ±0.05pF | GRM1885C2A9R1WA01# |        |               |         | 330pF   | ±5%     | GRM1885C2A331JA01# |                    |
|        |               |         |       | ±0.1pF  | GRM1885C2A9R1BA01# |        |               |         | 390pF   | ±5%     | GRM1885C2A391JA01# |                    |
|        |               |         |       | ±0.25pF | GRM1885C2A9R1CA01# |        |               |         | 470pF   | ±5%     | GRM1885C2A471JA01# |                    |
|        |               |         |       | ±0.5pF  | GRM1885C2A9R1DA01# |        |               |         | 560pF   | ±5%     | GRM1885C2A561JA01# |                    |
|        |               |         | 9.2pF | ±0.05pF | GRM1885C2A9R2WA01# |        |               |         | 680pF   | ±5%     | GRM1885C2A681JA01# |                    |
|        |               |         |       | ±0.1pF  | GRM1885C2A9R2BA01# |        |               |         | 820pF   | ±5%     | GRM1885C2A821JA01# |                    |
|        |               |         |       | ±0.25pF | GRM1885C2A9R2CA01# |        |               |         | 1000pF  | ±5%     | GRM1885C2A102JA01# |                    |
|        |               |         |       | ±0.5pF  | GRM1885C2A9R2DA01# |        |               |         | 1200pF  | ±5%     | GRM1885C2A122JA01# |                    |
|        |               |         | 9.3pF | ±0.05pF | GRM1885C2A9R3WA01# |        |               |         | 1500pF  | ±5%     | GRM1885C2A152JA01# |                    |
|        |               |         |       | ±0.1pF  | GRM1885C2A9R3BA01# |        |               |         | CK      | 0.50pF  | ±0.05pF            | GRM1884C2AR50WA01# |

Part number # indicates the package specification code.

⚠Caution / Notice

GRM  
 GR3  
 GRJ  
 GR4  
 GR7  
 GJM  
 GQM  
 GA2  
 GA3 GB  
 GA3 GD  
 GA3 GF  
 LLL  
 LLA  
 LLM  
 LLR  
 NFM  
 KRM  
 KR3  
 GMA  
 GMD

# GRM Series Temperature Compensating Type Part Number List

(→ 1.6×0.8mm)

| T max. | Rated Voltage | TC Code            | Cap.    | Tol.               | Part Number        | T max.  | Rated Voltage | TC Code            | Cap.               | Tol.    | Part Number        |
|--------|---------------|--------------------|---------|--------------------|--------------------|---------|---------------|--------------------|--------------------|---------|--------------------|
| 0.9mm  | 100Vdc        | CK                 | 0.50pF  | ±0.1pF             | GRM1884C2AR50BA01# | 0.9mm   | 100Vdc        | CJ                 | 2.5pF              | ±0.05pF | GRM1883C2A2R5WA01# |
|        |               |                    |         | ±0.05pF            | GRM1884C2AR60WA01# |         |               |                    |                    | ±0.1pF  | GRM1883C2A2R5BA01# |
|        |               |                    | ±0.1pF  | GRM1884C2AR60BA01# | ±0.25pF            |         |               |                    | GRM1883C2A2R5CA01# |         |                    |
|        |               |                    | 0.70pF  | ±0.05pF            | GRM1884C2AR70WA01# |         |               |                    | 2.6pF              | ±0.05pF | GRM1883C2A2R6WA01# |
|        |               |                    |         | ±0.1pF             | GRM1884C2AR70BA01# |         |               |                    |                    | ±0.1pF  | GRM1883C2A2R6BA01# |
|        |               |                    | 0.80pF  | ±0.05pF            | GRM1884C2AR80WA01# |         |               |                    | 2.7pF              | ±0.25pF | GRM1883C2A2R6CA01# |
|        |               |                    |         | ±0.1pF             | GRM1884C2AR80BA01# |         |               |                    |                    | ±0.05pF | GRM1883C2A2R7WA01# |
|        |               |                    | 0.90pF  | ±0.05pF            | GRM1884C2AR90WA01# |         |               |                    | 2.8pF              | ±0.1pF  | GRM1883C2A2R7BA01# |
|        |               |                    |         | ±0.1pF             | GRM1884C2AR90BA01# |         |               |                    |                    | ±0.25pF | GRM1883C2A2R7CA01# |
|        |               |                    | 1.0pF   | ±0.05pF            | GRM1884C2A1R0WA01# |         |               |                    | 2.9pF              | ±0.05pF | GRM1883C2A2R8WA01# |
|        |               |                    |         | ±0.1pF             | GRM1884C2A1R0BA01# |         |               |                    |                    | ±0.1pF  | GRM1883C2A2R8BA01# |
|        |               |                    |         | ±0.25pF            | GRM1884C2A1R0CA01# |         |               |                    |                    | ±0.25pF | GRM1883C2A2R8CA01# |
|        |               |                    | 1.1pF   | ±0.05pF            | GRM1884C2A1R1WA01# |         |               |                    | 3.0pF              | ±0.05pF | GRM1883C2A2R9WA01# |
|        |               |                    |         | ±0.1pF             | GRM1884C2A1R1BA01# |         |               |                    |                    | ±0.1pF  | GRM1883C2A2R9BA01# |
|        |               |                    |         | ±0.25pF            | GRM1884C2A1R1CA01# |         |               |                    |                    | ±0.25pF | GRM1883C2A2R9CA01# |
|        |               |                    | 1.2pF   | ±0.05pF            | GRM1884C2A1R2WA01# |         |               |                    | 3.1pF              | ±0.05pF | GRM1883C2A3R0WA01# |
|        |               |                    |         | ±0.1pF             | GRM1884C2A1R2BA01# |         |               |                    |                    | ±0.1pF  | GRM1883C2A3R0BA01# |
|        |               |                    |         | ±0.25pF            | GRM1884C2A1R2CA01# |         |               |                    |                    | ±0.25pF | GRM1883C2A3R0CA01# |
|        |               |                    | 1.3pF   | ±0.05pF            | GRM1884C2A1R3WA01# |         |               |                    | 3.2pF              | ±0.05pF | GRM1883C2A3R1WA01# |
|        |               |                    |         | ±0.1pF             | GRM1884C2A1R3BA01# |         |               |                    |                    | ±0.1pF  | GRM1883C2A3R1BA01# |
|        |               |                    |         | ±0.25pF            | GRM1884C2A1R3CA01# |         |               |                    |                    | ±0.25pF | GRM1883C2A3R1CA01# |
|        |               |                    | 1.4pF   | ±0.05pF            | GRM1884C2A1R4WA01# |         |               |                    | 3.3pF              | ±0.05pF | GRM1883C2A3R2WA01# |
|        |               |                    |         | ±0.1pF             | GRM1884C2A1R4BA01# |         |               |                    |                    | ±0.1pF  | GRM1883C2A3R2BA01# |
|        |               |                    |         | ±0.25pF            | GRM1884C2A1R4CA01# |         |               |                    |                    | ±0.25pF | GRM1883C2A3R2CA01# |
|        |               | 1.5pF              | ±0.05pF | GRM1884C2A1R5WA01# | 3.4pF              | ±0.05pF |               | GRM1883C2A3R3WA01# |                    |         |                    |
|        |               |                    | ±0.1pF  | GRM1884C2A1R5BA01# |                    | ±0.1pF  |               | GRM1883C2A3R3BA01# |                    |         |                    |
|        |               |                    | ±0.25pF | GRM1884C2A1R5CA01# |                    | ±0.25pF |               | GRM1883C2A3R3CA01# |                    |         |                    |
|        |               | 1.6pF              | ±0.05pF | GRM1884C2A1R6WA01# | 3.5pF              | ±0.05pF |               | GRM1883C2A3R4WA01# |                    |         |                    |
|        |               |                    | ±0.1pF  | GRM1884C2A1R6BA01# |                    | ±0.1pF  |               | GRM1883C2A3R4BA01# |                    |         |                    |
|        |               |                    | ±0.25pF | GRM1884C2A1R6CA01# |                    | ±0.25pF |               | GRM1883C2A3R4CA01# |                    |         |                    |
|        |               | 1.7pF              | ±0.05pF | GRM1884C2A1R7WA01# | 3.6pF              | ±0.05pF |               | GRM1883C2A3R5WA01# |                    |         |                    |
|        |               |                    | ±0.1pF  | GRM1884C2A1R7BA01# |                    | ±0.1pF  |               | GRM1883C2A3R5BA01# |                    |         |                    |
|        |               |                    | ±0.25pF | GRM1884C2A1R7CA01# |                    | ±0.25pF |               | GRM1883C2A3R5CA01# |                    |         |                    |
|        |               | 1.8pF              | ±0.05pF | GRM1884C2A1R8WA01# | 3.7pF              | ±0.05pF |               | GRM1883C2A3R6WA01# |                    |         |                    |
|        |               |                    | ±0.1pF  | GRM1884C2A1R8BA01# |                    | ±0.1pF  |               | GRM1883C2A3R6BA01# |                    |         |                    |
|        |               |                    | ±0.25pF | GRM1884C2A1R8CA01# |                    | ±0.25pF |               | GRM1883C2A3R6CA01# |                    |         |                    |
|        |               | 1.9pF              | ±0.05pF | GRM1884C2A1R9WA01# | 3.8pF              | ±0.05pF |               | GRM1883C2A3R7WA01# |                    |         |                    |
|        |               |                    | ±0.1pF  | GRM1884C2A1R9BA01# |                    | ±0.1pF  |               | GRM1883C2A3R7BA01# |                    |         |                    |
|        |               |                    | ±0.25pF | GRM1884C2A1R9CA01# |                    | ±0.25pF |               | GRM1883C2A3R7CA01# |                    |         |                    |
|        |               | 2.0pF              | ±0.05pF | GRM1884C2A2R0WA01# | 3.9pF              | ±0.05pF |               | GRM1883C2A3R8WA01# |                    |         |                    |
|        |               |                    | ±0.1pF  | GRM1884C2A2R0BA01# |                    | ±0.1pF  |               | GRM1883C2A3R8BA01# |                    |         |                    |
|        |               |                    | ±0.25pF | GRM1884C2A2R0CA01# |                    | ±0.25pF |               | GRM1883C2A3R8CA01# |                    |         |                    |
|        |               | 2.1pF              | ±0.05pF | GRM1883C2A2R1WA01# | 4.0pF              | ±0.05pF |               | GRM1882C2A4R0WA01# |                    |         |                    |
|        |               |                    | ±0.1pF  | GRM1883C2A2R1BA01# |                    | ±0.1pF  |               | GRM1882C2A4R0BA01# |                    |         |                    |
|        |               |                    | ±0.25pF | GRM1883C2A2R1CA01# |                    | ±0.25pF |               | GRM1882C2A4R0CA01# |                    |         |                    |
|        |               | 2.2pF              | ±0.05pF | GRM1883C2A2R2WA01# | 4.1pF              | ±0.05pF |               | GRM1882C2A4R1WA01# |                    |         |                    |
|        |               |                    | ±0.1pF  | GRM1883C2A2R2BA01# |                    | ±0.1pF  |               | GRM1882C2A4R1BA01# |                    |         |                    |
|        |               |                    | ±0.25pF | GRM1883C2A2R2CA01# |                    | ±0.25pF |               | GRM1882C2A4R1CA01# |                    |         |                    |
| 2.3pF  | ±0.05pF       | GRM1883C2A2R3WA01# | 4.2pF   | ±0.05pF            | GRM1882C2A4R2WA01# |         |               |                    |                    |         |                    |
|        | ±0.1pF        | GRM1883C2A2R3BA01# |         | ±0.1pF             | GRM1882C2A4R2BA01# |         |               |                    |                    |         |                    |
|        | ±0.25pF       | GRM1883C2A2R3CA01# |         | ±0.25pF            | GRM1882C2A4R2CA01# |         |               |                    |                    |         |                    |
| 2.4pF  | ±0.05pF       | GRM1883C2A2R4WA01# |         |                    |                    |         |               |                    |                    |         |                    |
|        | ±0.1pF        | GRM1883C2A2R4BA01# |         |                    |                    |         |               |                    |                    |         |                    |
|        | ±0.25pF       | GRM1883C2A2R4CA01# |         |                    |                    |         |               |                    |                    |         |                    |

Part number # indicates the package specification code.



# GRM Series Temperature Compensating Type Part Number List

(→ 1.6×0.8mm)

| T max. | Rated Voltage | TC Code | Cap.  | Tol.    | Part Number        | T max. | Rated Voltage | TC Code | Cap.    | Tol.               | Part Number        |                    |                    |
|--------|---------------|---------|-------|---------|--------------------|--------|---------------|---------|---------|--------------------|--------------------|--------------------|--------------------|
| 0.9mm  | 100Vdc        | CH      | 4.3pF | ±0.05pF | GRM1882C2A4R3WA01# | 0.9mm  | 100Vdc        | CH      | 5.8pF   | ±0.25pF            | GRM1882C2A5R8CA01# |                    |                    |
|        |               |         |       | ±0.1pF  | GRM1882C2A4R3BA01# |        |               |         |         | ±0.5pF             | GRM1882C2A5R8DA01# |                    |                    |
|        |               |         |       | ±0.25pF | GRM1882C2A4R3CA01# |        |               |         |         | 5.9pF              | ±0.05pF            | GRM1882C2A5R9WA01# |                    |
|        |               |         | 4.4pF | ±0.05pF | GRM1882C2A4R4WA01# |        |               |         | ±0.1pF  |                    | GRM1882C2A5R9BA01# |                    |                    |
|        |               |         |       | ±0.1pF  | GRM1882C2A4R4BA01# |        |               |         | ±0.25pF |                    | GRM1882C2A5R9CA01# |                    |                    |
|        |               |         |       | ±0.25pF | GRM1882C2A4R4CA01# |        |               |         | 6.0pF   | ±0.05pF            | GRM1882C2A6R0WA01# |                    |                    |
|        |               |         | 4.5pF | ±0.05pF | GRM1882C2A4R5WA01# |        |               |         |         | ±0.1pF             | GRM1882C2A6R0BA01# |                    |                    |
|        |               |         |       | ±0.1pF  | GRM1882C2A4R5BA01# |        |               |         |         | ±0.25pF            | GRM1882C2A6R0CA01# |                    |                    |
|        |               |         |       | ±0.25pF | GRM1882C2A4R5CA01# |        |               |         | 6.1pF   | ±0.05pF            | GRM1882C2A6R1WA01# |                    |                    |
|        |               |         | 4.6pF | ±0.05pF | GRM1882C2A4R6WA01# |        |               |         |         | ±0.1pF             | GRM1882C2A6R1BA01# |                    |                    |
|        |               |         |       | ±0.1pF  | GRM1882C2A4R6BA01# |        |               |         |         | ±0.25pF            | GRM1882C2A6R1CA01# |                    |                    |
|        |               |         |       | ±0.25pF | GRM1882C2A4R6CA01# |        |               |         | 6.2pF   | ±0.05pF            | GRM1882C2A6R2WA01# |                    |                    |
|        |               |         | 4.7pF | ±0.05pF | GRM1882C2A4R7WA01# |        |               |         |         | ±0.1pF             | GRM1882C2A6R2BA01# |                    |                    |
|        |               |         |       | ±0.1pF  | GRM1882C2A4R7BA01# |        |               |         |         | ±0.25pF            | GRM1882C2A6R2CA01# |                    |                    |
|        |               |         |       | ±0.25pF | GRM1882C2A4R7CA01# |        |               |         | ±0.5pF  | GRM1882C2A6R2DA01# |                    |                    |                    |
|        |               |         | 4.8pF | ±0.05pF | GRM1882C2A4R8WA01# |        |               |         | 6.3pF   | ±0.05pF            | GRM1882C2A6R3WA01# |                    |                    |
|        |               |         |       | ±0.1pF  | GRM1882C2A4R8BA01# |        |               |         |         | ±0.1pF             | GRM1882C2A6R3BA01# |                    |                    |
|        |               |         |       | ±0.25pF | GRM1882C2A4R8CA01# |        |               |         |         | ±0.25pF            | GRM1882C2A6R3CA01# |                    |                    |
|        |               |         | 4.9pF | ±0.05pF | GRM1882C2A4R9WA01# |        |               |         | ±0.5pF  | GRM1882C2A6R3DA01# | 6.4pF              | ±0.05pF            | GRM1882C2A6R4WA01# |
|        |               |         |       | ±0.1pF  | GRM1882C2A4R9BA01# |        |               |         | ±0.1pF  | GRM1882C2A6R4BA01# |                    | ±0.25pF            | GRM1882C2A6R4CA01# |
|        |               |         |       | ±0.25pF | GRM1882C2A4R9CA01# |        |               |         | ±0.5pF  | GRM1882C2A6R4DA01# |                    |                    |                    |
|        |               |         | 5.0pF | ±0.05pF | GRM1882C2A5R0WA01# |        |               |         | 6.5pF   | ±0.05pF            | GRM1882C2A6R5WA01# |                    |                    |
|        |               |         |       | ±0.1pF  | GRM1882C2A5R0BA01# |        |               |         |         | ±0.1pF             | GRM1882C2A6R5BA01# |                    |                    |
|        |               |         |       | ±0.25pF | GRM1882C2A5R0CA01# |        |               |         |         | ±0.25pF            | GRM1882C2A6R5CA01# |                    |                    |
|        |               |         | 5.1pF | ±0.05pF | GRM1882C2A5R1WA01# |        |               |         | 6.6pF   | ±0.05pF            | GRM1882C2A6R6WA01# |                    |                    |
|        |               |         |       | ±0.1pF  | GRM1882C2A5R1BA01# |        |               |         |         | ±0.1pF             | GRM1882C2A6R6BA01# |                    |                    |
|        |               |         |       | ±0.25pF | GRM1882C2A5R1CA01# |        |               |         |         | ±0.25pF            | GRM1882C2A6R6CA01# |                    |                    |
|        |               |         |       | ±0.5pF  | GRM1882C2A5R1DA01# |        |               |         |         | ±0.5pF             | GRM1882C2A6R6DA01# |                    |                    |
|        |               |         | 5.2pF | ±0.05pF | GRM1882C2A5R2WA01# |        |               |         | 6.7pF   | ±0.05pF            | GRM1882C2A6R7WA01# |                    |                    |
|        |               |         |       | ±0.1pF  | GRM1882C2A5R2BA01# |        |               |         |         | ±0.1pF             | GRM1882C2A6R7BA01# |                    |                    |
|        |               |         |       | ±0.25pF | GRM1882C2A5R2CA01# |        |               |         |         | ±0.25pF            | GRM1882C2A6R7CA01# |                    |                    |
|        |               |         |       | ±0.5pF  | GRM1882C2A5R2DA01# |        |               |         |         | ±0.5pF             | GRM1882C2A6R7DA01# |                    |                    |
|        |               |         | 5.3pF | ±0.05pF | GRM1882C2A5R3WA01# |        |               |         | 6.8pF   | ±0.05pF            | GRM1882C2A6R8WA01# |                    |                    |
|        |               |         |       | ±0.1pF  | GRM1882C2A5R3BA01# |        |               |         |         | ±0.1pF             | GRM1882C2A6R8BA01# |                    |                    |
|        |               |         |       | ±0.25pF | GRM1882C2A5R3CA01# |        |               |         |         | ±0.25pF            | GRM1882C2A6R8CA01# |                    |                    |
|        |               |         |       | ±0.5pF  | GRM1882C2A5R3DA01# |        |               |         |         | ±0.5pF             | GRM1882C2A6R8DA01# |                    |                    |
|        |               |         | 5.4pF | ±0.05pF | GRM1882C2A5R4WA01# |        |               |         | 6.9pF   | ±0.05pF            | GRM1882C2A6R9WA01# |                    |                    |
|        |               |         |       | ±0.1pF  | GRM1882C2A5R4BA01# |        |               |         |         | ±0.1pF             | GRM1882C2A6R9BA01# |                    |                    |
|        |               |         |       | ±0.25pF | GRM1882C2A5R4CA01# |        |               |         |         | ±0.25pF            | GRM1882C2A6R9CA01# |                    |                    |
|        |               |         |       | ±0.5pF  | GRM1882C2A5R4DA01# |        |               |         |         | ±0.5pF             | GRM1882C2A6R9DA01# |                    |                    |
|        |               |         | 5.5pF | ±0.05pF | GRM1882C2A5R5WA01# |        |               |         | 7.0pF   | ±0.05pF            | GRM1882C2A7R0WA01# |                    |                    |
|        |               |         |       | ±0.1pF  | GRM1882C2A5R5BA01# |        |               |         |         | ±0.1pF             | GRM1882C2A7R0BA01# |                    |                    |
|        |               |         |       | ±0.25pF | GRM1882C2A5R5CA01# |        |               |         |         | ±0.25pF            | GRM1882C2A7R0CA01# |                    |                    |
|        |               |         |       | ±0.5pF  | GRM1882C2A5R5DA01# |        |               |         |         | ±0.5pF             | GRM1882C2A7R0DA01# |                    |                    |
|        |               |         | 5.6pF | ±0.05pF | GRM1882C2A5R6WA01# |        |               |         | 7.1pF   | ±0.05pF            | GRM1882C2A7R1WA01# |                    |                    |
|        |               |         |       | ±0.1pF  | GRM1882C2A5R6BA01# |        |               |         |         | ±0.1pF             | GRM1882C2A7R1BA01# |                    |                    |
|        |               |         |       | ±0.25pF | GRM1882C2A5R6CA01# |        |               |         |         | ±0.25pF            | GRM1882C2A7R1CA01# |                    |                    |
|        |               |         |       | ±0.5pF  | GRM1882C2A5R6DA01# |        |               |         |         | ±0.5pF             | GRM1882C2A7R1DA01# |                    |                    |
|        |               |         | 5.7pF | ±0.05pF | GRM1882C2A5R7WA01# |        |               |         |         |                    |                    |                    |                    |
|        |               |         |       | ±0.1pF  | GRM1882C2A5R7BA01# |        |               |         |         |                    |                    |                    |                    |
|        |               |         |       | ±0.25pF | GRM1882C2A5R7CA01# |        |               |         |         |                    |                    |                    |                    |
|        |               |         |       | ±0.5pF  | GRM1882C2A5R7DA01# |        |               |         |         |                    |                    |                    |                    |
|        |               |         | 5.8pF | ±0.05pF | GRM1882C2A5R8WA01# |        |               |         |         |                    |                    |                    |                    |
|        |               |         |       | ±0.1pF  | GRM1882C2A5R8BA01# |        |               |         |         |                    |                    |                    |                    |

- GRM
- GR3
- GRJ
- GR4
- GR7
- GJM
- GQM
- GA2
- GA3 GB
- GA3 GD
- GA3 GF
- LLL
- LLA
- LLM
- LLR
- NFM
- KRM
- KR3
- GMA
- GMD
- ⚠Caution /Notice

Part number # indicates the package specification code.



# GRM Series Temperature Compensating Type Part Number List

(→ 1.6×0.8mm)

| T max. | Rated Voltage | TC Code | Cap.   | Tol.               | Part Number        | T max. | Rated Voltage | TC Code | Cap.    | Tol.               | Part Number        |                    |
|--------|---------------|---------|--------|--------------------|--------------------|--------|---------------|---------|---------|--------------------|--------------------|--------------------|
| 0.9mm  | 100Vdc        | CH      | 7.2pF  | ±0.05pF            | GRM1882C2A7R2WA01# | 0.9mm  | 100Vdc        | CH      | 8.5pF   | ±0.25pF            | GRM1882C2A8R5CA01# |                    |
|        |               |         |        | ±0.1pF             | GRM1882C2A7R2BA01# |        |               |         |         | ±0.5pF             | GRM1882C2A8R5DA01# |                    |
|        |               |         |        | ±0.25pF            | GRM1882C2A7R2CA01# |        |               |         |         | 8.6pF              | ±0.05pF            | GRM1882C2A8R6WA01# |
|        |               |         |        | ±0.5pF             | GRM1882C2A7R2DA01# |        |               |         |         |                    | ±0.1pF             | GRM1882C2A8R6BA01# |
|        |               |         | 7.3pF  | ±0.05pF            | GRM1882C2A7R3WA01# |        |               |         | ±0.25pF | GRM1882C2A8R6CA01# |                    |                    |
|        |               |         |        | ±0.1pF             | GRM1882C2A7R3BA01# |        |               |         | ±0.5pF  | GRM1882C2A8R6DA01# |                    |                    |
|        |               |         |        | ±0.25pF            | GRM1882C2A7R3CA01# |        |               |         | 8.7pF   | ±0.05pF            | GRM1882C2A8R7WA01# |                    |
|        |               |         | ±0.5pF | GRM1882C2A7R3DA01# | ±0.1pF             |        |               |         |         | GRM1882C2A8R7BA01# |                    |                    |
|        |               |         | 7.4pF  | ±0.05pF            | GRM1882C2A7R4WA01# |        |               |         |         | ±0.25pF            | GRM1882C2A8R7CA01# |                    |
|        |               |         |        | ±0.1pF             | GRM1882C2A7R4BA01# |        |               |         | ±0.5pF  | GRM1882C2A8R7DA01# |                    |                    |
|        |               |         |        | ±0.25pF            | GRM1882C2A7R4CA01# |        |               |         | 8.8pF   | ±0.05pF            | GRM1882C2A8R8WA01# |                    |
|        |               |         |        | ±0.5pF             | GRM1882C2A7R4DA01# |        |               |         |         | ±0.1pF             | GRM1882C2A8R8BA01# |                    |
|        |               |         | 7.5pF  | ±0.05pF            | GRM1882C2A7R5WA01# |        |               |         |         | ±0.25pF            | GRM1882C2A8R8CA01# |                    |
|        |               |         |        | ±0.1pF             | GRM1882C2A7R5BA01# |        |               |         |         | ±0.5pF             | GRM1882C2A8R8DA01# |                    |
|        |               |         |        | ±0.25pF            | GRM1882C2A7R5CA01# |        |               |         | 8.9pF   | ±0.05pF            | GRM1882C2A8R9WA01# |                    |
|        |               |         |        | ±0.5pF             | GRM1882C2A7R5DA01# |        |               |         |         | ±0.1pF             | GRM1882C2A8R9BA01# |                    |
|        |               |         | 7.6pF  | ±0.05pF            | GRM1882C2A7R6WA01# |        |               |         |         | ±0.25pF            | GRM1882C2A8R9CA01# |                    |
|        |               |         |        | ±0.1pF             | GRM1882C2A7R6BA01# |        |               |         |         | ±0.5pF             | GRM1882C2A8R9DA01# |                    |
|        |               |         |        | ±0.25pF            | GRM1882C2A7R6CA01# |        |               |         | 9.0pF   | ±0.05pF            | GRM1882C2A9R0WA01# |                    |
|        |               |         |        | ±0.5pF             | GRM1882C2A7R6DA01# |        |               |         |         | ±0.1pF             | GRM1882C2A9R0BA01# |                    |
|        |               |         | 7.7pF  | ±0.05pF            | GRM1882C2A7R7WA01# |        |               |         |         | ±0.25pF            | GRM1882C2A9R0CA01# |                    |
|        |               |         |        | ±0.1pF             | GRM1882C2A7R7BA01# |        |               |         |         | ±0.5pF             | GRM1882C2A9R0DA01# |                    |
|        |               |         |        | ±0.25pF            | GRM1882C2A7R7CA01# |        |               |         | 9.1pF   | ±0.05pF            | GRM1882C2A9R1WA01# |                    |
|        |               |         |        | ±0.5pF             | GRM1882C2A7R7DA01# |        |               |         |         | ±0.1pF             | GRM1882C2A9R1BA01# |                    |
|        |               |         | 7.8pF  | ±0.05pF            | GRM1882C2A7R8WA01# |        |               |         |         | ±0.25pF            | GRM1882C2A9R1CA01# |                    |
|        |               |         |        | ±0.1pF             | GRM1882C2A7R8BA01# |        |               |         |         | ±0.5pF             | GRM1882C2A9R1DA01# |                    |
|        |               |         |        | ±0.25pF            | GRM1882C2A7R8CA01# |        |               |         | 9.2pF   | ±0.05pF            | GRM1882C2A9R2WA01# |                    |
|        |               |         |        | ±0.5pF             | GRM1882C2A7R8DA01# |        |               |         |         | ±0.1pF             | GRM1882C2A9R2BA01# |                    |
|        |               |         | 7.9pF  | ±0.05pF            | GRM1882C2A7R9WA01# |        |               |         |         | ±0.25pF            | GRM1882C2A9R2CA01# |                    |
|        |               |         |        | ±0.1pF             | GRM1882C2A7R9BA01# |        |               |         |         | ±0.5pF             | GRM1882C2A9R2DA01# |                    |
|        |               |         |        | ±0.25pF            | GRM1882C2A7R9CA01# |        |               |         | 9.3pF   | ±0.05pF            | GRM1882C2A9R3WA01# |                    |
|        |               |         |        | ±0.5pF             | GRM1882C2A7R9DA01# |        |               |         |         | ±0.1pF             | GRM1882C2A9R3BA01# |                    |
|        |               |         | 8.0pF  | ±0.05pF            | GRM1882C2A8R0WA01# |        |               |         |         | ±0.25pF            | GRM1882C2A9R3CA01# |                    |
|        |               |         |        | ±0.1pF             | GRM1882C2A8R0BA01# |        |               |         |         | ±0.5pF             | GRM1882C2A9R3DA01# |                    |
|        |               |         |        | ±0.25pF            | GRM1882C2A8R0CA01# |        |               |         | 9.4pF   | ±0.05pF            | GRM1882C2A9R4WA01# |                    |
|        |               |         |        | ±0.5pF             | GRM1882C2A8R0DA01# |        |               |         |         | ±0.1pF             | GRM1882C2A9R4BA01# |                    |
|        |               |         | 8.1pF  | ±0.05pF            | GRM1882C2A8R1WA01# |        |               |         |         | ±0.25pF            | GRM1882C2A9R4CA01# |                    |
|        |               |         |        | ±0.1pF             | GRM1882C2A8R1BA01# |        |               |         |         | ±0.5pF             | GRM1882C2A9R4DA01# |                    |
|        |               |         |        | ±0.25pF            | GRM1882C2A8R1CA01# |        |               |         | 9.5pF   | ±0.05pF            | GRM1882C2A9R5WA01# |                    |
|        |               |         |        | ±0.5pF             | GRM1882C2A8R1DA01# |        |               |         |         | ±0.1pF             | GRM1882C2A9R5BA01# |                    |
|        |               |         | 8.2pF  | ±0.05pF            | GRM1882C2A8R2WA01# |        |               |         |         | ±0.25pF            | GRM1882C2A9R5CA01# |                    |
|        |               |         |        | ±0.1pF             | GRM1882C2A8R2BA01# |        |               |         |         | ±0.5pF             | GRM1882C2A9R5DA01# |                    |
|        |               |         |        | ±0.25pF            | GRM1882C2A8R2CA01# |        |               |         | 9.6pF   | ±0.05pF            | GRM1882C2A9R6WA01# |                    |
|        |               |         |        | ±0.5pF             | GRM1882C2A8R2DA01# |        |               |         |         | ±0.1pF             | GRM1882C2A9R6BA01# |                    |
|        |               |         | 8.3pF  | ±0.05pF            | GRM1882C2A8R3WA01# |        |               |         |         | ±0.25pF            | GRM1882C2A9R6CA01# |                    |
|        |               |         |        | ±0.1pF             | GRM1882C2A8R3BA01# |        |               |         |         | ±0.5pF             | GRM1882C2A9R6DA01# |                    |
|        |               |         |        | ±0.25pF            | GRM1882C2A8R3CA01# |        |               |         | 9.7pF   | ±0.05pF            | GRM1882C2A9R7WA01# |                    |
|        |               |         |        | ±0.5pF             | GRM1882C2A8R3DA01# |        |               |         |         | ±0.1pF             | GRM1882C2A9R7BA01# |                    |
|        |               |         | 8.4pF  | ±0.05pF            | GRM1882C2A8R4WA01# |        |               |         |         | ±0.25pF            | GRM1882C2A9R7CA01# |                    |
|        |               |         |        | ±0.1pF             | GRM1882C2A8R4BA01# |        |               |         |         | ±0.5pF             | GRM1882C2A9R7DA01# |                    |
|        |               |         |        | ±0.25pF            | GRM1882C2A8R4CA01# |        |               |         | 9.8pF   | ±0.05pF            | GRM1882C2A9R8WA01# |                    |
|        |               |         |        | ±0.5pF             | GRM1882C2A8R4DA01# |        |               |         |         | ±0.1pF             | GRM1882C2A9R8BA01# |                    |
|        |               |         | 8.5pF  | ±0.05pF            | GRM1882C2A8R5WA01# |        |               |         |         | ±0.25pF            | GRM1882C2A9R8CA01# |                    |
|        |               |         |        | ±0.1pF             | GRM1882C2A8R5BA01# |        |               |         |         | ±0.5pF             | GRM1882C2A9R8DA01# |                    |

Part number # indicates the package specification code.



# GRM Series Temperature Compensating Type Part Number List

(→ 1.6×0.8mm)

| T max.  | Rated Voltage      | TC Code            | Cap.   | Tol.    | Part Number        | T max.             | Rated Voltage      | TC Code | Cap.    | Tol.               | Part Number        |                    |
|---------|--------------------|--------------------|--------|---------|--------------------|--------------------|--------------------|---------|---------|--------------------|--------------------|--------------------|
| 0.9mm   | 100Vdc             | CH                 | 9.9pF  | ±0.05pF | GRM1882C2A9R9WA01# | 0.9mm              | 50Vdc              | COG     | 1.4pF   | ±0.1pF             | GRM1885C1H1R4BA01# |                    |
|         |                    |                    |        | ±0.1pF  | GRM1882C2A9R9BA01# |                    |                    |         |         | ±0.25pF            | GRM1885C1H1R4CA01# |                    |
|         |                    |                    |        | ±0.25pF | GRM1882C2A9R9CA01# |                    |                    |         |         | 1.5pF              | ±0.05pF            | GRM1885C1H1R5WA01# |
|         |                    |                    |        | ±0.5pF  | GRM1882C2A9R9DA01# |                    |                    |         |         |                    | ±0.1pF             | GRM1885C1H1R5BA01# |
|         |                    |                    | 10pF   | ±5%     | GRM1882C2A100JA01# |                    |                    |         | 1.6pF   | ±0.25pF            | GRM1885C1H1R5CA01# |                    |
|         |                    |                    | 12pF   | ±5%     | GRM1882C2A120JA01# |                    |                    |         |         | ±0.05pF            | GRM1885C1H1R6WA01# |                    |
|         |                    |                    | 15pF   | ±5%     | GRM1882C2A150JA01# |                    |                    |         | ±0.1pF  | GRM1885C1H1R6BA01# |                    |                    |
|         |                    |                    | 18pF   | ±5%     | GRM1882C2A180JA01# |                    |                    |         | ±0.25pF | GRM1885C1H1R6CA01# |                    |                    |
|         |                    |                    | 22pF   | ±5%     | GRM1882C2A220JA01# |                    |                    |         | 1.7pF   | ±0.05pF            | GRM1885C1H1R7WA01# |                    |
|         |                    |                    | 27pF   | ±5%     | GRM1882C2A270JA01# |                    |                    |         |         | ±0.1pF             | GRM1885C1H1R7BA01# |                    |
|         |                    |                    | 33pF   | ±5%     | GRM1882C2A330JA01# |                    |                    |         | ±0.25pF | GRM1885C1H1R7CA01# |                    |                    |
|         |                    |                    | 39pF   | ±5%     | GRM1882C2A390JA01# |                    |                    |         | 1.8pF   | ±0.05pF            | GRM1885C1H1R8WA01# |                    |
|         |                    |                    | 47pF   | ±5%     | GRM1882C2A470JA01# |                    |                    |         |         | ±0.1pF             | GRM1885C1H1R8BA01# |                    |
|         |                    |                    | 56pF   | ±5%     | GRM1882C2A560JA01# |                    |                    |         | ±0.25pF | GRM1885C1H1R8CA01# |                    |                    |
|         |                    |                    | 68pF   | ±5%     | GRM1882C2A680JA01# |                    |                    |         | 1.9pF   | ±0.05pF            | GRM1885C1H1R9WA01# |                    |
|         |                    |                    | 82pF   | ±5%     | GRM1882C2A820JA01# |                    |                    |         |         | ±0.1pF             | GRM1885C1H1R9BA01# |                    |
|         |                    |                    | 100pF  | ±5%     | GRM1882C2A101JA01# |                    |                    |         | ±0.25pF | GRM1885C1H1R9CA01# |                    |                    |
|         |                    |                    | 120pF  | ±5%     | GRM1882C2A121JA01# |                    |                    |         | 2.0pF   | ±0.05pF            | GRM1885C1H2R0WA01# |                    |
|         |                    |                    | 150pF  | ±5%     | GRM1882C2A151JA01# |                    |                    |         |         | ±0.1pF             | GRM1885C1H2R0BA01# |                    |
|         |                    |                    | 180pF  | ±5%     | GRM1882C2A181JA01# |                    |                    |         | ±0.25pF | GRM1885C1H2R0CA01# |                    |                    |
|         |                    |                    | 220pF  | ±5%     | GRM1882C2A221JA01# |                    |                    |         | 2.1pF   | ±0.05pF            | GRM1885C1H2R1WA01# |                    |
|         |                    |                    | 270pF  | ±5%     | GRM1882C2A271JA01# |                    |                    |         |         | ±0.1pF             | GRM1885C1H2R1BA01# |                    |
|         |                    |                    | 330pF  | ±5%     | GRM1882C2A331JA01# |                    |                    |         | ±0.25pF | GRM1885C1H2R1CA01# |                    |                    |
|         |                    |                    | 390pF  | ±5%     | GRM1882C2A391JA01# |                    |                    |         | 2.2pF   | ±0.05pF            | GRM1885C1H2R2WA01# |                    |
|         |                    |                    | 470pF  | ±5%     | GRM1882C2A471JA01# |                    |                    |         |         | ±0.1pF             | GRM1885C1H2R2BA01# |                    |
|         |                    |                    | 560pF  | ±5%     | GRM1882C2A561JA01# |                    |                    |         | ±0.25pF | GRM1885C1H2R2CA01# |                    |                    |
|         |                    |                    | 680pF  | ±5%     | GRM1882C2A681JA01# |                    |                    |         | 2.3pF   | ±0.05pF            | GRM1885C1H2R3WA01# |                    |
|         |                    |                    | 820pF  | ±5%     | GRM1882C2A821JA01# |                    |                    |         |         | ±0.1pF             | GRM1885C1H2R3BA01# |                    |
|         |                    |                    | 1000pF | ±5%     | GRM1882C2A102JA01# |                    |                    |         | ±0.25pF | GRM1885C1H2R3CA01# |                    |                    |
|         |                    |                    | 1200pF | ±5%     | GRM1882C2A122JA01# |                    |                    |         | 2.4pF   | ±0.05pF            | GRM1885C1H2R4WA01# |                    |
|         |                    |                    | 1500pF | ±5%     | GRM1882C2A152JA01# |                    |                    |         |         | ±0.1pF             | GRM1885C1H2R4BA01# |                    |
|         |                    |                    | 50Vdc  | COG     | 0.50pF             |                    |                    |         | ±0.05pF | GRM1885C1HR50WA01# | ±0.25pF            | GRM1885C1H2R4CA01# |
|         |                    |                    |        |         |                    |                    |                    |         | ±0.1pF  | GRM1885C1HR50BA01# | 2.5pF              | ±0.05pF            |
|         |                    |                    |        |         | 0.60pF             |                    |                    |         | ±0.05pF | GRM1885C1HR60WA01# |                    | ±0.1pF             |
| ±0.1pF  | GRM1885C1HR60BA01# | ±0.25pF            |        |         | GRM1885C1H2R5CA01# |                    |                    |         |         |                    |                    |                    |
| 0.70pF  | ±0.05pF            | GRM1885C1HR70WA01# |        |         | 2.6pF              | ±0.05pF            | GRM1885C1H2R6WA01# |         |         |                    |                    |                    |
| ±0.1pF  | GRM1885C1HR70BA01# | ±0.1pF             |        |         |                    | GRM1885C1H2R6BA01# |                    |         |         |                    |                    |                    |
| 0.80pF  | ±0.05pF            | GRM1885C1HR80WA01# |        |         | ±0.25pF            | GRM1885C1H2R6CA01# |                    |         |         |                    |                    |                    |
| ±0.1pF  | GRM1885C1HR80BA01# | 2.7pF              |        |         | ±0.05pF            | GRM1885C1H2R7WA01# |                    |         |         |                    |                    |                    |
| 0.90pF  | ±0.05pF            |                    |        |         | GRM1885C1HR90WA01# | ±0.1pF             | GRM1885C1H2R7BA01# |         |         |                    |                    |                    |
| ±0.1pF  | GRM1885C1HR90BA01# | ±0.25pF            |        |         | GRM1885C1H2R7CA01# |                    |                    |         |         |                    |                    |                    |
| 1.0pF   | ±0.05pF            | GRM1885C1H1R0WA01# |        |         | 2.8pF              | ±0.05pF            | GRM1885C1H2R8WA01# |         |         |                    |                    |                    |
| ±0.1pF  | GRM1885C1H1R0BA01# | ±0.1pF             |        |         |                    | GRM1885C1H2R8BA01# |                    |         |         |                    |                    |                    |
| ±0.25pF | GRM1885C1H1R0CA01# | ±0.25pF            |        |         | GRM1885C1H2R8CA01# |                    |                    |         |         |                    |                    |                    |
| 1.1pF   | ±0.05pF            | GRM1885C1H1R1WA01# |        |         | 2.9pF              | ±0.05pF            | GRM1885C1H2R9WA01# |         |         |                    |                    |                    |
| ±0.1pF  | GRM1885C1H1R1BA01# | ±0.1pF             |        |         |                    | GRM1885C1H2R9BA01# |                    |         |         |                    |                    |                    |
| ±0.25pF | GRM1885C1H1R1CA01# | ±0.25pF            |        |         | GRM1885C1H2R9CA01# |                    |                    |         |         |                    |                    |                    |
| 1.2pF   | ±0.05pF            | GRM1885C1H1R2WA01# |        |         | 3.0pF              | ±0.05pF            | GRM1885C1H3R0WA01# |         |         |                    |                    |                    |
| ±0.1pF  | GRM1885C1H1R2BA01# | ±0.1pF             |        |         |                    | GRM1885C1H3R0BA01# |                    |         |         |                    |                    |                    |
| ±0.25pF | GRM1885C1H1R2CA01# | ±0.25pF            |        |         | GRM1885C1H3R0CA01# |                    |                    |         |         |                    |                    |                    |
| 1.3pF   | ±0.05pF            | GRM1885C1H1R3WA01# |        |         | 3.1pF              | ±0.05pF            | GRM1885C1H3R1WA01# |         |         |                    |                    |                    |
| ±0.1pF  | GRM1885C1H1R3BA01# | ±0.1pF             |        |         |                    | GRM1885C1H3R1BA01# |                    |         |         |                    |                    |                    |
| ±0.25pF | GRM1885C1H1R3CA01# | ±0.25pF            |        |         | GRM1885C1H3R1CA01# |                    |                    |         |         |                    |                    |                    |
| 1.4pF   | ±0.05pF            | GRM1885C1H1R4WA01# |        |         | 3.2pF              | ±0.05pF            | GRM1885C1H3R2WA01# |         |         |                    |                    |                    |

GRM  
 GR3  
 GRJ  
 GR4  
 GR7  
 GJM  
 GQM  
 GA2  
 GA3 GB  
 GA3 GD  
 GA3 GF  
 LLL  
 LLA  
 LLM  
 LLR  
 NFM  
 KRM  
 KR3  
 GMA  
 GMD  
 ⚠Caution /Notice

Part number # indicates the package specification code.

## GRM Series Temperature Compensating Type Part Number List

(→ 1.6×0.8mm)

| T max. | Rated Voltage | TC Code            | Cap.  | Tol.    | Part Number        | T max. | Rated Voltage | TC Code | Cap.    | Tol.               | Part Number        |
|--------|---------------|--------------------|-------|---------|--------------------|--------|---------------|---------|---------|--------------------|--------------------|
| 0.9mm  | 50Vdc         | COG                | 3.2pF | ±0.1pF  | GRM1885C1H3R2BA01# | 0.9mm  | 50Vdc         | COG     | 5.0pF   | ±0.1pF             | GRM1885C1H5R0BA01# |
|        |               |                    |       | ±0.25pF | GRM1885C1H3R2CA01# |        |               |         |         | ±0.25pF            | GRM1885C1H5R0CA01# |
|        |               |                    | 3.3pF | ±0.05pF | GRM1885C1H3R3WA01# | 5.1pF  |               |         | ±0.05pF | GRM1885C1H5R1WA01# |                    |
|        |               |                    |       | ±0.1pF  | GRM1885C1H3R3BA01# |        |               |         | ±0.1pF  | GRM1885C1H5R1BA01# |                    |
|        |               |                    |       | ±0.25pF | GRM1885C1H3R3CA01# |        |               |         | ±0.25pF | GRM1885C1H5R1CA01# |                    |
|        |               |                    | 3.4pF | ±0.05pF | GRM1885C1H3R4WA01# | 5.2pF  |               |         | ±0.05pF | GRM1885C1H5R2WA01# |                    |
|        |               |                    |       | ±0.1pF  | GRM1885C1H3R4BA01# |        |               |         | ±0.1pF  | GRM1885C1H5R2BA01# |                    |
|        |               |                    |       | ±0.25pF | GRM1885C1H3R4CA01# |        |               |         | ±0.25pF | GRM1885C1H5R2CA01# |                    |
|        |               |                    | 3.5pF | ±0.05pF | GRM1885C1H3R5WA01# | 5.3pF  |               |         | ±0.05pF | GRM1885C1H5R3WA01# |                    |
|        |               |                    |       | ±0.1pF  | GRM1885C1H3R5BA01# |        |               |         | ±0.1pF  | GRM1885C1H5R3BA01# |                    |
|        |               |                    |       | ±0.25pF | GRM1885C1H3R5CA01# |        |               |         | ±0.25pF | GRM1885C1H5R3CA01# |                    |
|        |               |                    | 3.6pF | ±0.05pF | GRM1885C1H3R6WA01# | 5.4pF  |               |         | ±0.05pF | GRM1885C1H5R4WA01# |                    |
|        |               |                    |       | ±0.1pF  | GRM1885C1H3R6BA01# |        |               |         | ±0.1pF  | GRM1885C1H5R4BA01# |                    |
|        |               |                    |       | ±0.25pF | GRM1885C1H3R6CA01# |        |               |         | ±0.25pF | GRM1885C1H5R4CA01# |                    |
|        |               |                    | 3.7pF | ±0.05pF | GRM1885C1H3R7WA01# | 5.5pF  |               |         | ±0.05pF | GRM1885C1H5R5WA01# |                    |
|        |               |                    |       | ±0.1pF  | GRM1885C1H3R7BA01# |        |               |         | ±0.1pF  | GRM1885C1H5R5BA01# |                    |
|        |               |                    |       | ±0.25pF | GRM1885C1H3R7CA01# |        |               |         | ±0.25pF | GRM1885C1H5R5CA01# |                    |
|        |               |                    | 3.8pF | ±0.05pF | GRM1885C1H3R8WA01# | 5.6pF  |               |         | ±0.05pF | GRM1885C1H5R6WA01# |                    |
|        |               |                    |       | ±0.1pF  | GRM1885C1H3R8BA01# |        |               |         | ±0.1pF  | GRM1885C1H5R6BA01# |                    |
|        |               |                    |       | ±0.25pF | GRM1885C1H3R8CA01# |        |               |         | ±0.25pF | GRM1885C1H5R6CA01# |                    |
|        |               |                    | 3.9pF | ±0.05pF | GRM1885C1H3R9WA01# | 5.7pF  |               |         | ±0.05pF | GRM1885C1H5R7WA01# |                    |
|        |               |                    |       | ±0.1pF  | GRM1885C1H3R9BA01# |        |               |         | ±0.1pF  | GRM1885C1H5R7BA01# |                    |
|        |               |                    |       | ±0.25pF | GRM1885C1H3R9CA01# |        |               |         | ±0.25pF | GRM1885C1H5R7CA01# |                    |
|        |               |                    | 4.0pF | ±0.05pF | GRM1885C1H4R0WA01# | 5.8pF  |               |         | ±0.05pF | GRM1885C1H5R8WA01# |                    |
|        |               |                    |       | ±0.1pF  | GRM1885C1H4R0BA01# |        |               |         | ±0.1pF  | GRM1885C1H5R8BA01# |                    |
|        |               |                    |       | ±0.25pF | GRM1885C1H4R0CA01# |        |               |         | ±0.25pF | GRM1885C1H5R8CA01# |                    |
|        |               |                    | 4.1pF | ±0.05pF | GRM1885C1H4R1WA01# | 5.9pF  |               |         | ±0.05pF | GRM1885C1H5R9WA01# |                    |
|        |               |                    |       | ±0.1pF  | GRM1885C1H4R1BA01# |        |               |         | ±0.1pF  | GRM1885C1H5R9BA01# |                    |
|        |               |                    |       | ±0.25pF | GRM1885C1H4R1CA01# |        |               |         | ±0.25pF | GRM1885C1H5R9CA01# |                    |
|        |               |                    | 4.2pF | ±0.05pF | GRM1885C1H4R2WA01# | 6.0pF  |               |         | ±0.05pF | GRM1885C1H6R0WA01# |                    |
|        |               |                    |       | ±0.1pF  | GRM1885C1H4R2BA01# |        |               |         | ±0.1pF  | GRM1885C1H6R0BA01# |                    |
|        |               |                    |       | ±0.25pF | GRM1885C1H4R2CA01# |        |               |         | ±0.25pF | GRM1885C1H6R0CA01# |                    |
|        |               |                    | 4.3pF | ±0.05pF | GRM1885C1H4R3WA01# | 6.1pF  |               |         | ±0.05pF | GRM1885C1H6R1WA01# |                    |
|        |               |                    |       | ±0.1pF  | GRM1885C1H4R3BA01# |        |               |         | ±0.1pF  | GRM1885C1H6R1BA01# |                    |
|        |               |                    |       | ±0.25pF | GRM1885C1H4R3CA01# |        |               |         | ±0.25pF | GRM1885C1H6R1CA01# |                    |
|        |               |                    | 4.4pF | ±0.05pF | GRM1885C1H4R4WA01# | 6.2pF  |               |         | ±0.05pF | GRM1885C1H6R2WA01# |                    |
|        |               |                    |       | ±0.1pF  | GRM1885C1H4R4BA01# |        |               |         | ±0.1pF  | GRM1885C1H6R2BA01# |                    |
|        |               |                    |       | ±0.25pF | GRM1885C1H4R4CA01# |        |               |         | ±0.25pF | GRM1885C1H6R2CA01# |                    |
|        |               |                    | 4.5pF | ±0.05pF | GRM1885C1H4R5WA01# | 6.3pF  |               |         | ±0.05pF | GRM1885C1H6R3WA01# |                    |
|        |               |                    |       | ±0.1pF  | GRM1885C1H4R5BA01# |        |               |         | ±0.1pF  | GRM1885C1H6R3BA01# |                    |
|        |               |                    |       | ±0.25pF | GRM1885C1H4R5CA01# |        |               |         | ±0.25pF | GRM1885C1H6R3CA01# |                    |
|        |               |                    | 4.6pF | ±0.05pF | GRM1885C1H4R6WA01# | 5.0pF  |               |         | ±0.05pF | GRM1885C1H5R0WA01# |                    |
|        |               |                    |       | ±0.1pF  | GRM1885C1H4R6BA01# |        |               |         | ±0.1pF  | GRM1885C1H5R0BA01# |                    |
|        |               |                    |       | ±0.25pF | GRM1885C1H4R6CA01# |        |               |         | ±0.25pF | GRM1885C1H5R0CA01# |                    |
|        |               |                    | 4.7pF | ±0.05pF | GRM1885C1H4R7WA01# |        |               |         |         |                    |                    |
|        |               |                    |       | ±0.1pF  | GRM1885C1H4R7BA01# |        |               |         |         |                    |                    |
|        |               |                    |       | ±0.25pF | GRM1885C1H4R7CA01# |        |               |         |         |                    |                    |
|        |               |                    | 4.8pF | ±0.05pF | GRM1885C1H4R8WA01# |        |               |         |         |                    |                    |
|        |               |                    |       | ±0.1pF  | GRM1885C1H4R8BA01# |        |               |         |         |                    |                    |
|        |               |                    |       | ±0.25pF | GRM1885C1H4R8CA01# |        |               |         |         |                    |                    |
| 4.9pF  | ±0.05pF       | GRM1885C1H4R9WA01# |       |         |                    |        |               |         |         |                    |                    |
|        | ±0.1pF        | GRM1885C1H4R9BA01# |       |         |                    |        |               |         |         |                    |                    |
|        | ±0.25pF       | GRM1885C1H4R9CA01# |       |         |                    |        |               |         |         |                    |                    |

Part number # indicates the package specification code.

# GRM Series Temperature Compensating Type Part Number List

(→ 1.6×0.8mm)

| T max. | Rated Voltage | TC Code | Cap.  | Tol.    | Part Number        | T max. | Rated Voltage | TC Code | Cap.    | Tol.               | Part Number        |                    |
|--------|---------------|---------|-------|---------|--------------------|--------|---------------|---------|---------|--------------------|--------------------|--------------------|
| 0.9mm  | 50Vdc         | COG     | 6.4pF | ±0.05pF | GRM1885C1H6R4WA01# | 0.9mm  | 50Vdc         | COG     | 7.7pF   | ±0.25pF            | GRM1885C1H7R7CA01# |                    |
|        |               |         |       | ±0.1pF  | GRM1885C1H6R4BA01# |        |               |         |         | ±0.5pF             | GRM1885C1H7R7DA01# |                    |
|        |               |         |       | ±0.25pF | GRM1885C1H6R4CA01# |        |               |         |         | 7.8pF              | ±0.05pF            | GRM1885C1H7R8WA01# |
|        |               |         |       | ±0.5pF  | GRM1885C1H6R4DA01# |        |               |         |         |                    | ±0.1pF             | GRM1885C1H7R8BA01# |
|        |               |         | 6.5pF | ±0.05pF | GRM1885C1H6R5WA01# |        |               |         | ±0.25pF | GRM1885C1H7R8CA01# |                    |                    |
|        |               |         |       | ±0.1pF  | GRM1885C1H6R5BA01# |        |               |         | ±0.5pF  | GRM1885C1H7R8DA01# |                    |                    |
|        |               |         |       | ±0.25pF | GRM1885C1H6R5CA01# |        |               |         | 7.9pF   | ±0.05pF            | GRM1885C1H7R9WA01# |                    |
|        |               |         |       | ±0.5pF  | GRM1885C1H6R5DA01# |        |               |         |         | ±0.1pF             | GRM1885C1H7R9BA01# |                    |
|        |               |         | 6.6pF | ±0.05pF | GRM1885C1H6R6WA01# |        |               |         | ±0.25pF | GRM1885C1H7R9CA01# |                    |                    |
|        |               |         |       | ±0.1pF  | GRM1885C1H6R6BA01# |        |               |         | ±0.5pF  | GRM1885C1H7R9DA01# |                    |                    |
|        |               |         |       | ±0.25pF | GRM1885C1H6R6CA01# |        |               |         | 8.0pF   | ±0.05pF            | GRM1885C1H8R0WA01# |                    |
|        |               |         |       | ±0.5pF  | GRM1885C1H6R6DA01# |        |               |         |         | ±0.1pF             | GRM1885C1H8R0BA01# |                    |
|        |               |         | 6.7pF | ±0.05pF | GRM1885C1H6R7WA01# |        |               |         | ±0.25pF | GRM1885C1H8R0CA01# |                    |                    |
|        |               |         |       | ±0.1pF  | GRM1885C1H6R7BA01# |        |               |         | ±0.5pF  | GRM1885C1H8R0DA01# |                    |                    |
|        |               |         |       | ±0.25pF | GRM1885C1H6R7CA01# |        |               |         | 8.1pF   | ±0.05pF            | GRM1885C1H8R1WA01# |                    |
|        |               |         |       | ±0.5pF  | GRM1885C1H6R7DA01# |        |               |         |         | ±0.1pF             | GRM1885C1H8R1BA01# |                    |
|        |               |         | 6.8pF | ±0.05pF | GRM1885C1H6R8WA01# |        |               |         | ±0.25pF | GRM1885C1H8R1CA01# |                    |                    |
|        |               |         |       | ±0.1pF  | GRM1885C1H6R8BA01# |        |               |         | ±0.5pF  | GRM1885C1H8R1DA01# |                    |                    |
|        |               |         |       | ±0.25pF | GRM1885C1H6R8CA01# |        |               |         | 8.2pF   | ±0.05pF            | GRM1885C1H8R2WA01# |                    |
|        |               |         |       | ±0.5pF  | GRM1885C1H6R8DA01# |        |               |         |         | ±0.1pF             | GRM1885C1H8R2BA01# |                    |
|        |               |         | 6.9pF | ±0.05pF | GRM1885C1H6R9WA01# |        |               |         | ±0.25pF | GRM1885C1H8R2CA01# |                    |                    |
|        |               |         |       | ±0.1pF  | GRM1885C1H6R9BA01# |        |               |         | ±0.5pF  | GRM1885C1H8R2DA01# |                    |                    |
|        |               |         |       | ±0.25pF | GRM1885C1H6R9CA01# |        |               |         | 8.3pF   | ±0.05pF            | GRM1885C1H8R3WA01# |                    |
|        |               |         |       | ±0.5pF  | GRM1885C1H6R9DA01# |        |               |         |         | ±0.1pF             | GRM1885C1H8R3BA01# |                    |
|        |               |         | 7.0pF | ±0.05pF | GRM1885C1H7R0WA01# |        |               |         | ±0.25pF | GRM1885C1H8R3CA01# |                    |                    |
|        |               |         |       | ±0.1pF  | GRM1885C1H7R0BA01# |        |               |         | ±0.5pF  | GRM1885C1H8R3DA01# |                    |                    |
|        |               |         |       | ±0.25pF | GRM1885C1H7R0CA01# |        |               |         | 8.4pF   | ±0.05pF            | GRM1885C1H8R4WA01# |                    |
|        |               |         |       | ±0.5pF  | GRM1885C1H7R0DA01# |        |               |         |         | ±0.1pF             | GRM1885C1H8R4BA01# |                    |
|        |               |         | 7.1pF | ±0.05pF | GRM1885C1H7R1WA01# |        |               |         | ±0.25pF | GRM1885C1H8R4CA01# |                    |                    |
|        |               |         |       | ±0.1pF  | GRM1885C1H7R1BA01# |        |               |         | ±0.5pF  | GRM1885C1H8R4DA01# |                    |                    |
|        |               |         |       | ±0.25pF | GRM1885C1H7R1CA01# |        |               |         | 8.5pF   | ±0.05pF            | GRM1885C1H8R5WA01# |                    |
|        |               |         |       | ±0.5pF  | GRM1885C1H7R1DA01# |        |               |         |         | ±0.1pF             | GRM1885C1H8R5BA01# |                    |
|        |               |         | 7.2pF | ±0.05pF | GRM1885C1H7R2WA01# |        |               |         | ±0.25pF | GRM1885C1H8R5CA01# |                    |                    |
|        |               |         |       | ±0.1pF  | GRM1885C1H7R2BA01# |        |               |         | ±0.5pF  | GRM1885C1H8R5DA01# |                    |                    |
|        |               |         |       | ±0.25pF | GRM1885C1H7R2CA01# |        |               |         | 8.6pF   | ±0.05pF            | GRM1885C1H8R6WA01# |                    |
|        |               |         |       | ±0.5pF  | GRM1885C1H7R2DA01# |        |               |         |         | ±0.1pF             | GRM1885C1H8R6BA01# |                    |
|        |               |         | 7.3pF | ±0.05pF | GRM1885C1H7R3WA01# |        |               |         | ±0.25pF | GRM1885C1H8R6CA01# |                    |                    |
|        |               |         |       | ±0.1pF  | GRM1885C1H7R3BA01# |        |               |         | ±0.5pF  | GRM1885C1H8R6DA01# |                    |                    |
|        |               |         |       | ±0.25pF | GRM1885C1H7R3CA01# |        |               |         | 8.7pF   | ±0.05pF            | GRM1885C1H8R7WA01# |                    |
|        |               |         |       | ±0.5pF  | GRM1885C1H7R3DA01# |        |               |         |         | ±0.1pF             | GRM1885C1H8R7BA01# |                    |
|        |               |         | 7.4pF | ±0.05pF | GRM1885C1H7R4WA01# |        |               |         | ±0.25pF | GRM1885C1H8R7CA01# |                    |                    |
|        |               |         |       | ±0.1pF  | GRM1885C1H7R4BA01# |        |               |         | ±0.5pF  | GRM1885C1H8R7DA01# |                    |                    |
|        |               |         |       | ±0.25pF | GRM1885C1H7R4CA01# |        |               |         | 8.8pF   | ±0.05pF            | GRM1885C1H8R8WA01# |                    |
|        |               |         |       | ±0.5pF  | GRM1885C1H7R4DA01# |        |               |         |         | ±0.1pF             | GRM1885C1H8R8BA01# |                    |
|        |               |         | 7.5pF | ±0.05pF | GRM1885C1H7R5WA01# |        |               |         | ±0.25pF | GRM1885C1H8R8CA01# |                    |                    |
|        |               |         |       | ±0.1pF  | GRM1885C1H7R5BA01# |        |               |         | ±0.5pF  | GRM1885C1H8R8DA01# |                    |                    |
|        |               |         |       | ±0.25pF | GRM1885C1H7R5CA01# |        |               |         | 8.9pF   | ±0.05pF            | GRM1885C1H8R9WA01# |                    |
|        |               |         |       | ±0.5pF  | GRM1885C1H7R5DA01# |        |               |         |         | ±0.1pF             | GRM1885C1H8R9BA01# |                    |
|        |               |         | 7.6pF | ±0.05pF | GRM1885C1H7R6WA01# |        |               |         | ±0.25pF | GRM1885C1H8R9CA01# |                    |                    |
|        |               |         |       | ±0.1pF  | GRM1885C1H7R6BA01# |        |               |         | ±0.5pF  | GRM1885C1H8R9DA01# |                    |                    |
|        |               |         |       | ±0.25pF | GRM1885C1H7R6CA01# |        |               |         | 9.0pF   | ±0.05pF            | GRM1885C1H9R0WA01# |                    |
|        |               |         |       | ±0.5pF  | GRM1885C1H7R6DA01# |        |               |         |         | ±0.1pF             | GRM1885C1H9R0BA01# |                    |
|        |               |         | 7.7pF | ±0.05pF | GRM1885C1H7R7WA01# |        |               |         | ±0.25pF | GRM1885C1H9R0CA01# |                    |                    |
|        |               |         |       | ±0.1pF  | GRM1885C1H7R7BA01# |        |               |         | ±0.5pF  | GRM1885C1H9R0DA01# |                    |                    |

- GRM
- GR3
- GRJ
- GR4
- GR7
- GJM
- GQM
- GA2
- GA3 GB
- GA3 GD
- GA3 GF
- LLL
- LLA
- LLM
- LLR
- NFM
- KRM
- KR3
- GMA
- GMD
- ⚠Caution /Notice

Part number # indicates the package specification code.

# GRM Series Temperature Compensating Type Part Number List

(→ 1.6×0.8mm)

| T max. | Rated Voltage | TC Code            | Cap.  | Tol.    | Part Number        | T max. | Rated Voltage | TC Code | Cap.    | Tol.               | Part Number        |                    |
|--------|---------------|--------------------|-------|---------|--------------------|--------|---------------|---------|---------|--------------------|--------------------|--------------------|
| 0.9mm  | 50Vdc         | COG                | 9.1pF | ±0.05pF | GRM1885C1H9R1WA01# | 0.9mm  | 50Vdc         | COG     | 330pF   | ±5%                | GRM1885C1H331JA01# |                    |
|        |               |                    |       | ±0.1pF  | GRM1885C1H9R1BA01# |        |               |         |         | 390pF              | ±5%                | GRM1885C1H391JA01# |
|        |               |                    |       | ±0.25pF | GRM1885C1H9R1CA01# |        |               |         |         | 470pF              | ±5%                | GRM1885C1H471JA01# |
|        |               |                    |       | ±0.5pF  | GRM1885C1H9R1DA01# |        |               |         |         | 560pF              | ±5%                | GRM1885C1H561JA01# |
|        |               |                    | 9.2pF | ±0.05pF | GRM1885C1H9R2WA01# |        |               |         | 680pF   | ±5%                | GRM1885C1H681JA01# |                    |
|        |               |                    |       | ±0.1pF  | GRM1885C1H9R2BA01# |        |               |         | 820pF   | ±5%                | GRM1885C1H821JA01# |                    |
|        |               |                    |       | ±0.25pF | GRM1885C1H9R2CA01# |        |               |         | 1000pF  | ±5%                | GRM1885C1H102JA01# |                    |
|        |               |                    |       | ±0.5pF  | GRM1885C1H9R2DA01# |        |               |         | 1200pF  | ±5%                | GRM1885C1H122JA01# |                    |
|        |               |                    | 9.3pF | ±0.05pF | GRM1885C1H9R3WA01# |        |               |         | 1500pF  | ±5%                | GRM1885C1H152JA01# |                    |
|        |               |                    |       | ±0.1pF  | GRM1885C1H9R3BA01# |        |               |         | 1800pF  | ±5%                | GRM1885C1H182JA01# |                    |
|        |               |                    |       | ±0.25pF | GRM1885C1H9R3CA01# |        |               |         | 2200pF  | ±5%                | GRM1885C1H222JA01# |                    |
|        |               |                    |       | ±0.5pF  | GRM1885C1H9R3DA01# |        |               |         | 2700pF  | ±5%                | GRM1885C1H272JA01# |                    |
|        |               |                    | 9.4pF | ±0.05pF | GRM1885C1H9R4WA01# |        |               |         | 3300pF  | ±5%                | GRM1885C1H332JA01# |                    |
|        |               |                    |       | ±0.1pF  | GRM1885C1H9R4BA01# |        |               |         | 3900pF  | ±5%                | GRM1885C1H392JA01# |                    |
|        |               |                    |       | ±0.25pF | GRM1885C1H9R4CA01# |        |               |         | 4700pF  | ±5%                | GRM1885C1H472JA01# |                    |
|        |               |                    |       | ±0.5pF  | GRM1885C1H9R4DA01# |        |               |         | 5600pF  | ±5%                | GRM1885C1H562JA01# |                    |
|        |               |                    | 9.5pF | ±0.05pF | GRM1885C1H9R5WA01# |        |               |         | 6800pF  | ±5%                | GRM1885C1H682JA01# |                    |
|        |               |                    |       | ±0.1pF  | GRM1885C1H9R5BA01# |        |               |         | 8200pF  | ±5%                | GRM1885C1H822JA01# |                    |
|        |               |                    |       | ±0.25pF | GRM1885C1H9R5CA01# |        |               |         | 10000pF | ±5%                | GRM1885C1H103JA01# |                    |
|        |               |                    |       | ±0.5pF  | GRM1885C1H9R5DA01# |        |               |         | CK      | 0.50pF             | ±0.05pF            | GRM1884C1HR50WA01# |
|        |               |                    | 9.6pF | ±0.05pF | GRM1885C1H9R6WA01# |        |               |         |         | ±0.1pF             | GRM1884C1HR50BA01# |                    |
|        |               |                    |       | ±0.1pF  | GRM1885C1H9R6BA01# |        |               |         |         | 0.60pF             | ±0.05pF            | GRM1884C1HR60WA01# |
|        |               |                    |       | ±0.25pF | GRM1885C1H9R6CA01# |        |               |         |         | ±0.1pF             | GRM1884C1HR60BA01# |                    |
|        |               |                    |       | ±0.5pF  | GRM1885C1H9R6DA01# |        |               |         | 0.70pF  | ±0.05pF            | GRM1884C1HR70WA01# |                    |
|        |               |                    | 9.7pF | ±0.05pF | GRM1885C1H9R7WA01# |        |               |         | ±0.1pF  | GRM1884C1HR70BA01# |                    |                    |
|        |               |                    |       | ±0.1pF  | GRM1885C1H9R7BA01# |        |               |         | 0.80pF  | ±0.05pF            | GRM1884C1HR80WA01# |                    |
|        |               |                    |       | ±0.25pF | GRM1885C1H9R7CA01# |        |               |         | ±0.1pF  | GRM1884C1HR80BA01# |                    |                    |
|        |               |                    |       | ±0.5pF  | GRM1885C1H9R7DA01# |        |               |         | 0.90pF  | ±0.05pF            | GRM1884C1HR90WA01# |                    |
|        |               |                    | 9.8pF | ±0.05pF | GRM1885C1H9R8WA01# |        |               |         | ±0.1pF  | GRM1884C1HR90BA01# |                    |                    |
|        |               |                    |       | ±0.1pF  | GRM1885C1H9R8BA01# |        |               |         | 1.0pF   | ±0.05pF            | GRM1884C1H1R0WA01# |                    |
|        |               |                    |       | ±0.25pF | GRM1885C1H9R8CA01# |        |               |         | ±0.1pF  | GRM1884C1H1R0BA01# |                    |                    |
|        |               |                    |       | ±0.5pF  | GRM1885C1H9R8DA01# |        |               |         | ±0.25pF | GRM1884C1H1R0CA01# |                    |                    |
|        |               |                    | 9.9pF | ±0.05pF | GRM1885C1H9R9WA01# |        |               |         | 1.1pF   | ±0.05pF            | GRM1884C1H1R1WA01# |                    |
|        |               |                    |       | ±0.1pF  | GRM1885C1H9R9BA01# |        |               |         | ±0.1pF  | GRM1884C1H1R1BA01# |                    |                    |
|        |               |                    |       | ±0.25pF | GRM1885C1H9R9CA01# |        |               |         | ±0.25pF | GRM1884C1H1R1CA01# |                    |                    |
|        |               |                    |       | ±0.5pF  | GRM1885C1H9R9DA01# |        |               |         | 1.2pF   | ±0.05pF            | GRM1884C1H1R2WA01# |                    |
|        |               |                    | 10pF  | ±5%     | GRM1885C1H100JA01# |        |               |         | ±0.1pF  | GRM1884C1H1R2BA01# |                    |                    |
|        |               |                    | 12pF  | ±5%     | GRM1885C1H120JA01# |        |               |         | ±0.25pF | GRM1884C1H1R2CA01# |                    |                    |
|        |               |                    | 15pF  | ±5%     | GRM1885C1H150JA01# |        |               |         | 1.3pF   | ±0.05pF            | GRM1884C1H1R3WA01# |                    |
|        |               |                    | 18pF  | ±5%     | GRM1885C1H180JA01# |        |               |         |         | ±0.1pF             | GRM1884C1H1R3BA01# |                    |
|        |               |                    | 22pF  | ±5%     | GRM1885C1H220JA01# |        |               |         |         | ±0.25pF            | GRM1884C1H1R3CA01# |                    |
|        |               |                    | 27pF  | ±5%     | GRM1885C1H270JA01# |        |               |         | 1.4pF   | ±0.05pF            | GRM1884C1H1R4WA01# |                    |
|        |               |                    | 33pF  | ±5%     | GRM1885C1H330JA01# |        |               |         |         | ±0.1pF             | GRM1884C1H1R4BA01# |                    |
|        |               |                    | 39pF  | ±5%     | GRM1885C1H390JA01# |        |               |         |         | ±0.25pF            | GRM1884C1H1R4CA01# |                    |
|        |               |                    | 47pF  | ±5%     | GRM1885C1H470JA01# |        |               |         | 1.5pF   | ±0.05pF            | GRM1884C1H1R5WA01# |                    |
|        |               |                    | 56pF  | ±5%     | GRM1885C1H560JA01# |        |               |         |         | ±0.1pF             | GRM1884C1H1R5BA01# |                    |
|        |               |                    | 68pF  | ±5%     | GRM1885C1H680JA01# |        |               |         |         | ±0.25pF            | GRM1884C1H1R5CA01# |                    |
|        |               |                    | 82pF  | ±5%     | GRM1885C1H820JA01# |        |               |         | 1.6pF   | ±0.05pF            | GRM1884C1H1R6WA01# |                    |
|        |               |                    | 100pF | ±5%     | GRM1885C1H101JA01# |        |               |         |         | ±0.1pF             | GRM1884C1H1R6BA01# |                    |
|        |               |                    | 120pF | ±5%     | GRM1885C1H121JA01# |        |               |         |         | ±0.25pF            | GRM1884C1H1R6CA01# |                    |
| 150pF  | ±5%           | GRM1885C1H151JA01# | 1.7pF | ±0.05pF | GRM1884C1H1R7WA01# |        |               |         |         |                    |                    |                    |
| 180pF  | ±5%           | GRM1885C1H181JA01# |       | ±0.1pF  | GRM1884C1H1R7BA01# |        |               |         |         |                    |                    |                    |
| 220pF  | ±5%           | GRM1885C1H221JA01# |       | ±0.25pF | GRM1884C1H1R7CA01# |        |               |         |         |                    |                    |                    |
| 270pF  | ±5%           | GRM1885C1H271JA01# | 1.8pF | ±0.05pF | GRM1884C1H1R8WA01# |        |               |         |         |                    |                    |                    |

Part number # indicates the package specification code.



# GRM Series Temperature Compensating Type Part Number List

(→ 1.6×0.8mm)

| T max.  | Rated Voltage | TC Code | Cap.    | Tol.               | Part Number        | T max.             | Rated Voltage      | TC Code | Cap.               | Tol.    | Part Number        |
|---------|---------------|---------|---------|--------------------|--------------------|--------------------|--------------------|---------|--------------------|---------|--------------------|
| 0.9mm   | 50Vdc         | CK      | 1.8pF   | ±0.1pF             | GRM1884C1H1R8BA01# | 0.9mm              | 50Vdc              | CJ      | 3.6pF              | ±0.1pF  | GRM1883C1H3R6BA01# |
|         |               |         |         | ±0.25pF            | GRM1884C1H1R8CA01# |                    |                    |         |                    | ±0.25pF | GRM1883C1H3R6CA01# |
|         |               |         |         | ±0.05pF            | GRM1884C1H1R9WA01# |                    |                    |         |                    | ±0.05pF | GRM1883C1H3R7WA01# |
|         |               |         | 1.9pF   | ±0.1pF             | GRM1884C1H1R9BA01# |                    |                    |         | 3.7pF              | ±0.1pF  | GRM1883C1H3R7BA01# |
|         |               |         |         | ±0.25pF            | GRM1884C1H1R9CA01# |                    |                    |         |                    | ±0.25pF | GRM1883C1H3R7CA01# |
|         |               |         |         | ±0.05pF            | GRM1884C1H2R0WA01# |                    |                    |         |                    | ±0.05pF | GRM1883C1H3R8WA01# |
|         |               |         | 2.0pF   | ±0.1pF             | GRM1884C1H2R0BA01# |                    |                    |         | 3.8pF              | ±0.1pF  | GRM1883C1H3R8BA01# |
|         |               |         |         | ±0.25pF            | GRM1884C1H2R0CA01# |                    |                    |         |                    | ±0.25pF | GRM1883C1H3R8CA01# |
|         |               |         |         | ±0.05pF            | GRM1883C1H2R1WA01# |                    |                    |         |                    | ±0.05pF | GRM1883C1H3R9WA01# |
|         |               |         | 2.1pF   | ±0.1pF             | GRM1883C1H2R1BA01# |                    |                    |         | 3.9pF              | ±0.1pF  | GRM1883C1H3R9BA01# |
|         |               |         |         | ±0.25pF            | GRM1883C1H2R1CA01# |                    |                    |         |                    | ±0.25pF | GRM1883C1H3R9CA01# |
|         |               |         |         | ±0.05pF            | GRM1883C1H2R2WA01# |                    |                    |         |                    | CH      | 4.0pF              |
|         |               |         | ±0.1pF  | GRM1883C1H2R2BA01# | ±0.1pF             |                    |                    |         | GRM1882C1H4R0BA01# |         |                    |
|         |               |         | ±0.25pF | GRM1883C1H2R2CA01# | ±0.25pF            |                    |                    |         | GRM1882C1H4R0CA01# |         |                    |
|         |               |         | 2.2pF   | ±0.05pF            | GRM1883C1H2R3WA01# |                    |                    |         | 4.1pF              | ±0.05pF | GRM1882C1H4R1WA01# |
|         |               |         |         | ±0.1pF             | GRM1883C1H2R3BA01# |                    |                    |         |                    | ±0.1pF  | GRM1882C1H4R1BA01# |
|         |               |         |         | ±0.25pF            | GRM1883C1H2R3CA01# |                    |                    |         |                    | ±0.25pF | GRM1882C1H4R1CA01# |
|         |               |         | 2.3pF   | ±0.05pF            | GRM1883C1H2R4WA01# |                    |                    |         | 4.2pF              | ±0.05pF | GRM1882C1H4R2WA01# |
|         |               | ±0.1pF  |         | GRM1883C1H2R4BA01# | ±0.1pF             | GRM1882C1H4R2BA01# |                    |         |                    |         |                    |
|         |               | ±0.25pF |         | GRM1883C1H2R4CA01# | ±0.25pF            | GRM1882C1H4R2CA01# |                    |         |                    |         |                    |
|         |               | 2.4pF   | ±0.05pF | GRM1883C1H2R5WA01# | 4.3pF              | ±0.05pF            | GRM1882C1H4R3WA01# |         |                    |         |                    |
|         |               |         | ±0.1pF  | GRM1883C1H2R5BA01# |                    | ±0.1pF             | GRM1882C1H4R3BA01# |         |                    |         |                    |
|         |               |         | ±0.25pF | GRM1883C1H2R5CA01# |                    | ±0.25pF            | GRM1882C1H4R3CA01# |         |                    |         |                    |
|         |               | 2.5pF   | ±0.05pF | GRM1883C1H2R6WA01# | 4.4pF              | ±0.05pF            | GRM1882C1H4R4WA01# |         |                    |         |                    |
|         |               |         | ±0.1pF  | GRM1883C1H2R6BA01# |                    | ±0.1pF             | GRM1882C1H4R4BA01# |         |                    |         |                    |
|         |               |         | ±0.25pF | GRM1883C1H2R6CA01# |                    | ±0.25pF            | GRM1882C1H4R4CA01# |         |                    |         |                    |
|         |               | 2.6pF   | ±0.05pF | GRM1883C1H2R7WA01# | 4.5pF              | ±0.05pF            | GRM1882C1H4R5WA01# |         |                    |         |                    |
|         |               |         | ±0.1pF  | GRM1883C1H2R7BA01# |                    | ±0.1pF             | GRM1882C1H4R5BA01# |         |                    |         |                    |
|         |               |         | ±0.25pF | GRM1883C1H2R7CA01# |                    | ±0.25pF            | GRM1882C1H4R5CA01# |         |                    |         |                    |
|         |               | 2.7pF   | ±0.05pF | GRM1883C1H2R8WA01# | 4.6pF              | ±0.05pF            | GRM1882C1H4R6WA01# |         |                    |         |                    |
|         |               |         | ±0.1pF  | GRM1883C1H2R8BA01# |                    | ±0.1pF             | GRM1882C1H4R6BA01# |         |                    |         |                    |
|         |               |         | ±0.25pF | GRM1883C1H2R8CA01# |                    | ±0.25pF            | GRM1882C1H4R6CA01# |         |                    |         |                    |
|         |               | 2.8pF   | ±0.05pF | GRM1883C1H2R9WA01# | 4.7pF              | ±0.05pF            | GRM1882C1H4R7WA01# |         |                    |         |                    |
|         |               |         | ±0.1pF  | GRM1883C1H2R9BA01# |                    | ±0.1pF             | GRM1882C1H4R7BA01# |         |                    |         |                    |
|         |               |         | ±0.25pF | GRM1883C1H2R9CA01# |                    | ±0.25pF            | GRM1882C1H4R7CA01# |         |                    |         |                    |
|         |               | 2.9pF   | ±0.05pF | GRM1883C1H3R0WA01# | 4.8pF              | ±0.05pF            | GRM1882C1H4R8WA01# |         |                    |         |                    |
|         |               |         | ±0.1pF  | GRM1883C1H3R0BA01# |                    | ±0.1pF             | GRM1882C1H4R8BA01# |         |                    |         |                    |
|         |               |         | ±0.25pF | GRM1883C1H3R0CA01# |                    | ±0.25pF            | GRM1882C1H4R8CA01# |         |                    |         |                    |
|         |               | 3.0pF   | ±0.05pF | GRM1883C1H3R1WA01# | 4.9pF              | ±0.05pF            | GRM1882C1H4R9WA01# |         |                    |         |                    |
|         |               |         | ±0.1pF  | GRM1883C1H3R1BA01# |                    | ±0.1pF             | GRM1882C1H4R9BA01# |         |                    |         |                    |
|         |               |         | ±0.25pF | GRM1883C1H3R1CA01# |                    | ±0.25pF            | GRM1882C1H4R9CA01# |         |                    |         |                    |
|         |               | 3.1pF   | ±0.05pF | GRM1883C1H3R2WA01# | 5.0pF              | ±0.05pF            | GRM1882C1H5R0WA01# |         |                    |         |                    |
|         |               |         | ±0.1pF  | GRM1883C1H3R2BA01# |                    | ±0.1pF             | GRM1882C1H5R0BA01# |         |                    |         |                    |
|         |               |         | ±0.25pF | GRM1883C1H3R2CA01# |                    | ±0.25pF            | GRM1882C1H5R0CA01# |         |                    |         |                    |
|         |               | 3.2pF   | ±0.05pF | GRM1883C1H3R3WA01# | 5.1pF              | ±0.05pF            | GRM1882C1H5R1WA01# |         |                    |         |                    |
|         |               |         | ±0.1pF  | GRM1883C1H3R3BA01# |                    | ±0.1pF             | GRM1882C1H5R1BA01# |         |                    |         |                    |
|         |               |         | ±0.25pF | GRM1883C1H3R3CA01# |                    | ±0.25pF            | GRM1882C1H5R1CA01# |         |                    |         |                    |
|         |               | 3.3pF   | ±0.05pF | GRM1883C1H3R4WA01# | 5.2pF              | ±0.05pF            | GRM1882C1H5R2WA01# |         |                    |         |                    |
|         |               |         | ±0.1pF  | GRM1883C1H3R4BA01# |                    | ±0.1pF             | GRM1882C1H5R2BA01# |         |                    |         |                    |
|         |               |         | ±0.25pF | GRM1883C1H3R4CA01# |                    | ±0.25pF            | GRM1882C1H5R2CA01# |         |                    |         |                    |
|         |               | 3.4pF   | ±0.05pF | GRM1883C1H3R5WA01# | 5.3pF              | ±0.05pF            | GRM1882C1H5R3WA01# |         |                    |         |                    |
|         |               |         | ±0.1pF  | GRM1883C1H3R5BA01# |                    | ±0.1pF             | GRM1882C1H5R3BA01# |         |                    |         |                    |
|         |               |         | ±0.25pF | GRM1883C1H3R5CA01# |                    | ±0.25pF            | GRM1882C1H5R3CA01# |         |                    |         |                    |
|         |               | 3.5pF   | ±0.05pF | GRM1883C1H3R6WA01# |                    |                    |                    |         |                    |         |                    |
| ±0.1pF  |               |         |         |                    |                    |                    |                    |         |                    |         |                    |
| ±0.25pF |               |         |         |                    |                    |                    |                    |         |                    |         |                    |

GRM  
 GR3  
 GRJ  
 GR4  
 GR7  
 GJM  
 GQM  
 GA2  
 GA3 GB  
 GA3 GD  
 GA3 GF  
 LLL  
 LLA  
 LLM  
 LLR  
 NFM  
 KRM  
 KR3  
 GMA  
 GMD  
 ⚠Caution / Notice

Part number # indicates the package specification code.

# GRM Series Temperature Compensating Type Part Number List

(→ 1.6×0.8mm)

| T max. | Rated Voltage | TC Code | Cap.   | Tol.               | Part Number        | T max.  | Rated Voltage | TC Code | Cap.               | Tol.               | Part Number        |
|--------|---------------|---------|--------|--------------------|--------------------|---------|---------------|---------|--------------------|--------------------|--------------------|
| 0.9mm  | 50Vdc         | CH      | 5.3pF  | ±0.25pF            | GRM1882C1H5R3CA01# | 0.9mm   | 50Vdc         | CH      | 6.7pF              | ±0.05pF            | GRM1882C1H6R7WA01# |
|        |               |         |        | ±0.5pF             | GRM1882C1H5R3DA01# |         |               |         |                    | ±0.1pF             | GRM1882C1H6R7BA01# |
|        |               |         | 5.4pF  | ±0.05pF            | GRM1882C1H5R4WA01# | ±0.25pF |               |         | GRM1882C1H6R7CA01# |                    |                    |
|        |               |         |        | ±0.1pF             | GRM1882C1H5R4BA01# | ±0.5pF  |               |         | GRM1882C1H6R7DA01# |                    |                    |
|        |               |         |        | ±0.25pF            | GRM1882C1H5R4CA01# | 6.8pF   |               |         | ±0.05pF            | GRM1882C1H6R8WA01# |                    |
|        |               |         |        | ±0.5pF             | GRM1882C1H5R4DA01# |         |               |         | ±0.1pF             | GRM1882C1H6R8BA01# |                    |
|        |               |         | 5.5pF  | ±0.05pF            | GRM1882C1H5R5WA01# |         |               |         | ±0.25pF            | GRM1882C1H6R8CA01# |                    |
|        |               |         |        | ±0.1pF             | GRM1882C1H5R5BA01# | ±0.5pF  |               |         | GRM1882C1H6R8DA01# |                    |                    |
|        |               |         |        | ±0.25pF            | GRM1882C1H5R5CA01# | 6.9pF   |               |         | ±0.05pF            | GRM1882C1H6R9WA01# |                    |
|        |               |         | ±0.5pF | GRM1882C1H5R5DA01# | ±0.1pF             |         |               |         | GRM1882C1H6R9BA01# |                    |                    |
|        |               |         | 5.6pF  | ±0.05pF            | GRM1882C1H5R6WA01# |         |               |         | ±0.25pF            | GRM1882C1H6R9CA01# |                    |
|        |               |         |        | ±0.1pF             | GRM1882C1H5R6BA01# | ±0.5pF  |               |         | GRM1882C1H6R9DA01# |                    |                    |
|        |               |         |        | ±0.25pF            | GRM1882C1H5R6CA01# | 7.0pF   |               |         | ±0.05pF            | GRM1882C1H7R0WA01# |                    |
|        |               |         |        | ±0.5pF             | GRM1882C1H5R6DA01# |         |               |         | ±0.1pF             | GRM1882C1H7R0BA01# |                    |
|        |               |         | 5.7pF  | ±0.05pF            | GRM1882C1H5R7WA01# |         |               |         | ±0.25pF            | GRM1882C1H7R0CA01# |                    |
|        |               |         |        | ±0.1pF             | GRM1882C1H5R7BA01# | ±0.5pF  |               |         | GRM1882C1H7R0DA01# |                    |                    |
|        |               |         |        | ±0.25pF            | GRM1882C1H5R7CA01# | 7.1pF   |               |         | ±0.05pF            | GRM1882C1H7R1WA01# |                    |
|        |               |         |        | ±0.5pF             | GRM1882C1H5R7DA01# |         |               |         | ±0.1pF             | GRM1882C1H7R1BA01# |                    |
|        |               |         | 5.8pF  | ±0.05pF            | GRM1882C1H5R8WA01# |         |               |         | ±0.25pF            | GRM1882C1H7R1CA01# |                    |
|        |               |         |        | ±0.1pF             | GRM1882C1H5R8BA01# | ±0.5pF  |               |         | GRM1882C1H7R1DA01# |                    |                    |
|        |               |         |        | ±0.25pF            | GRM1882C1H5R8CA01# | 7.2pF   |               |         | ±0.05pF            | GRM1882C1H7R2WA01# |                    |
|        |               |         |        | ±0.5pF             | GRM1882C1H5R8DA01# |         |               |         | ±0.1pF             | GRM1882C1H7R2BA01# |                    |
|        |               |         | 5.9pF  | ±0.05pF            | GRM1882C1H5R9WA01# |         |               |         | ±0.25pF            | GRM1882C1H7R2CA01# |                    |
|        |               |         |        | ±0.1pF             | GRM1882C1H5R9BA01# | ±0.5pF  |               |         | GRM1882C1H7R2DA01# |                    |                    |
|        |               |         |        | ±0.25pF            | GRM1882C1H5R9CA01# | 7.3pF   |               |         | ±0.05pF            | GRM1882C1H7R3WA01# |                    |
|        |               |         |        | ±0.5pF             | GRM1882C1H5R9DA01# |         |               |         | ±0.1pF             | GRM1882C1H7R3BA01# |                    |
|        |               |         | 6.0pF  | ±0.05pF            | GRM1882C1H6R0WA01# |         |               |         | ±0.25pF            | GRM1882C1H7R3CA01# |                    |
|        |               |         |        | ±0.1pF             | GRM1882C1H6R0BA01# | ±0.5pF  |               |         | GRM1882C1H7R3DA01# |                    |                    |
|        |               |         |        | ±0.25pF            | GRM1882C1H6R0CA01# | 7.4pF   |               |         | ±0.05pF            | GRM1882C1H7R4WA01# |                    |
|        |               |         |        | ±0.5pF             | GRM1882C1H6R0DA01# |         |               |         | ±0.1pF             | GRM1882C1H7R4BA01# |                    |
|        |               |         | 6.1pF  | ±0.05pF            | GRM1882C1H6R1WA01# |         |               |         | ±0.25pF            | GRM1882C1H7R4CA01# |                    |
|        |               |         |        | ±0.1pF             | GRM1882C1H6R1BA01# | ±0.5pF  |               |         | GRM1882C1H7R4DA01# |                    |                    |
|        |               |         |        | ±0.25pF            | GRM1882C1H6R1CA01# | 7.5pF   |               |         | ±0.05pF            | GRM1882C1H7R5WA01# |                    |
|        |               |         |        | ±0.5pF             | GRM1882C1H6R1DA01# |         |               |         | ±0.1pF             | GRM1882C1H7R5BA01# |                    |
|        |               |         | 6.2pF  | ±0.05pF            | GRM1882C1H6R2WA01# |         |               |         | ±0.25pF            | GRM1882C1H7R5CA01# |                    |
|        |               |         |        | ±0.1pF             | GRM1882C1H6R2BA01# | ±0.5pF  |               |         | GRM1882C1H7R5DA01# |                    |                    |
|        |               |         |        | ±0.25pF            | GRM1882C1H6R2CA01# | 7.6pF   |               |         | ±0.05pF            | GRM1882C1H7R6WA01# |                    |
|        |               |         |        | ±0.5pF             | GRM1882C1H6R2DA01# |         |               |         | ±0.1pF             | GRM1882C1H7R6BA01# |                    |
|        |               |         | 6.3pF  | ±0.05pF            | GRM1882C1H6R3WA01# |         |               |         | ±0.25pF            | GRM1882C1H7R6CA01# |                    |
|        |               |         |        | ±0.1pF             | GRM1882C1H6R3BA01# | ±0.5pF  |               |         | GRM1882C1H7R6DA01# |                    |                    |
|        |               |         |        | ±0.25pF            | GRM1882C1H6R3CA01# | 7.7pF   |               |         | ±0.05pF            | GRM1882C1H7R7WA01# |                    |
|        |               |         |        | ±0.5pF             | GRM1882C1H6R3DA01# |         |               |         | ±0.1pF             | GRM1882C1H7R7BA01# |                    |
|        |               |         | 6.4pF  | ±0.05pF            | GRM1882C1H6R4WA01# |         |               |         | ±0.25pF            | GRM1882C1H7R7CA01# |                    |
|        |               |         |        | ±0.1pF             | GRM1882C1H6R4BA01# | ±0.5pF  |               |         | GRM1882C1H7R7DA01# |                    |                    |
|        |               |         |        | ±0.25pF            | GRM1882C1H6R4CA01# | 7.8pF   |               |         | ±0.05pF            | GRM1882C1H7R8WA01# |                    |
|        |               |         |        | ±0.5pF             | GRM1882C1H6R4DA01# |         |               |         | ±0.1pF             | GRM1882C1H7R8BA01# |                    |
|        |               |         | 6.5pF  | ±0.05pF            | GRM1882C1H6R5WA01# |         |               |         | ±0.25pF            | GRM1882C1H7R8CA01# |                    |
|        |               |         |        | ±0.1pF             | GRM1882C1H6R5BA01# | ±0.5pF  |               |         | GRM1882C1H7R8DA01# |                    |                    |
|        |               |         |        | ±0.25pF            | GRM1882C1H6R5CA01# | 7.9pF   |               |         | ±0.05pF            | GRM1882C1H7R9WA01# |                    |
|        |               |         |        | ±0.5pF             | GRM1882C1H6R5DA01# |         |               |         | ±0.1pF             | GRM1882C1H7R9BA01# |                    |
|        |               |         | 6.6pF  | ±0.05pF            | GRM1882C1H6R6WA01# |         |               |         | ±0.25pF            | GRM1882C1H7R9CA01# |                    |
|        |               |         |        | ±0.1pF             | GRM1882C1H6R6BA01# | ±0.5pF  |               |         | GRM1882C1H7R9DA01# |                    |                    |
|        |               |         |        | ±0.25pF            | GRM1882C1H6R6CA01# | 8.0pF   |               |         | ±0.05pF            | GRM1882C1H8R0WA01# |                    |
|        |               |         |        | ±0.5pF             | GRM1882C1H6R6DA01# |         |               |         | ±0.1pF             | GRM1882C1H8R0BA01# |                    |

Part number # indicates the package specification code.



# GRM Series Temperature Compensating Type Part Number List

(→ 1.6×0.8mm)

| T max. | Rated Voltage | TC Code | Cap.   | Tol.               | Part Number        | T max.  | Rated Voltage | TC Code | Cap.               | Tol.               | Part Number        |
|--------|---------------|---------|--------|--------------------|--------------------|---------|---------------|---------|--------------------|--------------------|--------------------|
| 0.9mm  | 50Vdc         | CH      | 8.0pF  | ±0.25pF            | GRM1882C1H8R0CA01# | 0.9mm   | 50Vdc         | CH      | 9.4pF              | ±0.05pF            | GRM1882C1H9R4WA01# |
|        |               |         |        | ±0.5pF             | GRM1882C1H8R0DA01# |         |               |         |                    | ±0.1pF             | GRM1882C1H9R4BA01# |
|        |               |         | 8.1pF  | ±0.05pF            | GRM1882C1H8R1WA01# | ±0.25pF |               |         | GRM1882C1H9R4CA01# |                    |                    |
|        |               |         |        | ±0.1pF             | GRM1882C1H8R1BA01# | ±0.5pF  |               |         | GRM1882C1H9R4DA01# |                    |                    |
|        |               |         |        | ±0.25pF            | GRM1882C1H8R1CA01# | 9.5pF   |               |         | ±0.05pF            | GRM1882C1H9R5WA01# |                    |
|        |               |         |        | ±0.5pF             | GRM1882C1H8R1DA01# |         |               |         | ±0.1pF             | GRM1882C1H9R5BA01# |                    |
|        |               |         | 8.2pF  | ±0.05pF            | GRM1882C1H8R2WA01# |         |               |         | ±0.25pF            | GRM1882C1H9R5CA01# |                    |
|        |               |         |        | ±0.1pF             | GRM1882C1H8R2BA01# | ±0.5pF  |               |         | GRM1882C1H9R5DA01# |                    |                    |
|        |               |         |        | ±0.25pF            | GRM1882C1H8R2CA01# | 9.6pF   |               |         | ±0.05pF            | GRM1882C1H9R6WA01# |                    |
|        |               |         | ±0.5pF | GRM1882C1H8R2DA01# | ±0.1pF             |         |               |         | GRM1882C1H9R6BA01# |                    |                    |
|        |               |         | 8.3pF  | ±0.05pF            | GRM1882C1H8R3WA01# |         |               |         | ±0.25pF            | GRM1882C1H9R6CA01# |                    |
|        |               |         |        | ±0.1pF             | GRM1882C1H8R3BA01# | ±0.5pF  |               |         | GRM1882C1H9R6DA01# |                    |                    |
|        |               |         |        | ±0.25pF            | GRM1882C1H8R3CA01# | 9.7pF   |               |         | ±0.05pF            | GRM1882C1H9R7WA01# |                    |
|        |               |         | ±0.5pF | GRM1882C1H8R3DA01# | ±0.1pF             |         |               |         | GRM1882C1H9R7BA01# |                    |                    |
|        |               |         | 8.4pF  | ±0.05pF            | GRM1882C1H8R4WA01# |         |               |         | ±0.25pF            | GRM1882C1H9R7CA01# |                    |
|        |               |         |        | ±0.1pF             | GRM1882C1H8R4BA01# | ±0.5pF  |               |         | GRM1882C1H9R7DA01# |                    |                    |
|        |               |         |        | ±0.25pF            | GRM1882C1H8R4CA01# | 9.8pF   |               |         | ±0.05pF            | GRM1882C1H9R8WA01# |                    |
|        |               |         |        | ±0.5pF             | GRM1882C1H8R4DA01# |         |               |         | ±0.1pF             | GRM1882C1H9R8BA01# |                    |
|        |               |         | 8.5pF  | ±0.05pF            | GRM1882C1H8R5WA01# |         |               |         | ±0.25pF            | GRM1882C1H9R8CA01# |                    |
|        |               |         |        | ±0.1pF             | GRM1882C1H8R5BA01# | ±0.5pF  |               |         | GRM1882C1H9R8DA01# |                    |                    |
|        |               |         |        | ±0.25pF            | GRM1882C1H8R5CA01# | 9.9pF   |               |         | ±0.05pF            | GRM1882C1H9R9WA01# |                    |
|        |               |         | ±0.5pF | GRM1882C1H8R5DA01# | ±0.1pF             |         |               |         | GRM1882C1H9R9BA01# |                    |                    |
|        |               |         | 8.6pF  | ±0.05pF            | GRM1882C1H8R6WA01# |         |               |         | ±0.25pF            | GRM1882C1H9R9CA01# |                    |
|        |               |         |        | ±0.1pF             | GRM1882C1H8R6BA01# | ±0.5pF  |               |         | GRM1882C1H9R9DA01# |                    |                    |
|        |               |         |        | ±0.25pF            | GRM1882C1H8R6CA01# | 10pF    |               |         | ±5%                | GRM1882C1H100JA01# |                    |
|        |               |         |        | ±0.5pF             | GRM1882C1H8R6DA01# |         |               |         | 12pF               | ±5%                | GRM1882C1H120JA01# |
|        |               |         | 8.7pF  | ±0.05pF            | GRM1882C1H8R7WA01# | 15pF    |               |         |                    | ±5%                | GRM1882C1H150JA01# |
|        |               |         |        | ±0.1pF             | GRM1882C1H8R7BA01# |         |               |         | 18pF               | ±5%                | GRM1882C1H180JA01# |
|        |               |         |        | ±0.25pF            | GRM1882C1H8R7CA01# | 22pF    |               |         |                    | ±5%                | GRM1882C1H220JA01# |
|        |               |         |        | ±0.5pF             | GRM1882C1H8R7DA01# |         |               |         | 27pF               | ±5%                | GRM1882C1H270JA01# |
|        |               |         | 8.8pF  | ±0.05pF            | GRM1882C1H8R8WA01# | 33pF    |               |         |                    | ±5%                | GRM1882C1H330JA01# |
|        |               |         |        | ±0.1pF             | GRM1882C1H8R8BA01# |         |               |         | 39pF               | ±5%                | GRM1882C1H390JA01# |
|        |               |         |        | ±0.25pF            | GRM1882C1H8R8CA01# | 47pF    |               |         |                    | ±5%                | GRM1882C1H470JA01# |
|        |               |         |        | ±0.5pF             | GRM1882C1H8R8DA01# |         |               |         | 56pF               | ±5%                | GRM1882C1H560JA01# |
|        |               |         | 8.9pF  | ±0.05pF            | GRM1882C1H8R9WA01# | 68pF    |               |         |                    | ±5%                | GRM1882C1H680JA01# |
|        |               |         |        | ±0.1pF             | GRM1882C1H8R9BA01# |         |               |         | 82pF               | ±5%                | GRM1882C1H820JA01# |
|        |               |         |        | ±0.25pF            | GRM1882C1H8R9CA01# | 100pF   |               |         |                    | ±5%                | GRM1882C1H101JA01# |
|        |               |         |        | ±0.5pF             | GRM1882C1H8R9DA01# |         |               |         | 120pF              | ±5%                | GRM1882C1H121JA01# |
|        |               |         | 9.0pF  | ±0.05pF            | GRM1882C1H9R0WA01# | 150pF   |               |         |                    | ±5%                | GRM1882C1H151JA01# |
|        |               |         |        | ±0.1pF             | GRM1882C1H9R0BA01# |         |               |         | 180pF              | ±5%                | GRM1882C1H181JA01# |
|        |               |         |        | ±0.25pF            | GRM1882C1H9R0CA01# | 220pF   |               |         |                    | ±5%                | GRM1882C1H221JA01# |
|        |               |         |        | ±0.5pF             | GRM1882C1H9R0DA01# |         |               |         | 270pF              | ±5%                | GRM1882C1H271JA01# |
|        |               |         | 9.1pF  | ±0.05pF            | GRM1882C1H9R1WA01# | 330pF   |               |         |                    | ±5%                | GRM1882C1H331JA01# |
|        |               |         |        | ±0.1pF             | GRM1882C1H9R1BA01# |         |               |         | 390pF              | ±5%                | GRM1882C1H391JA01# |
|        |               |         |        | ±0.25pF            | GRM1882C1H9R1CA01# | 470pF   |               |         |                    | ±5%                | GRM1882C1H471JA01# |
|        |               |         |        | ±0.5pF             | GRM1882C1H9R1DA01# |         |               |         | 560pF              | ±5%                | GRM1882C1H561JA01# |
|        |               |         | 9.2pF  | ±0.05pF            | GRM1882C1H9R2WA01# | 680pF   |               |         |                    | ±5%                | GRM1882C1H681JA01# |
|        |               |         |        | ±0.1pF             | GRM1882C1H9R2BA01# |         |               |         | 820pF              | ±5%                | GRM1882C1H821JA01# |
|        |               |         |        | ±0.25pF            | GRM1882C1H9R2CA01# | 1000pF  |               |         |                    | ±5%                | GRM1882C1H102JA01# |
|        |               |         |        | ±0.5pF             | GRM1882C1H9R2DA01# |         |               |         | 1200pF             | ±5%                | GRM1882C1H122JA01# |
|        |               |         | 9.3pF  | ±0.05pF            | GRM1882C1H9R3WA01# | 1500pF  |               |         |                    | ±5%                | GRM1882C1H152JA01# |
|        |               |         |        | ±0.1pF             | GRM1882C1H9R3BA01# |         |               |         | 1800pF             | ±5%                | GRM1882C1H182JA01# |
|        |               |         |        | ±0.25pF            | GRM1882C1H9R3CA01# | 2200pF  |               |         |                    | ±5%                | GRM1882C1H222JA01# |
|        |               |         |        | ±0.5pF             | GRM1882C1H9R3DA01# |         |               |         | 2700pF             | ±5%                | GRM1882C1H272JA01# |

GRM  
 GR3  
 GRJ  
 GR4  
 GR7  
 GJM  
 GQM  
 GA2  
 GA3 GB  
 GA3 GD  
 GA3 GF  
 LLL  
 LLA  
 LLM  
 LLR  
 NFM  
 KRM  
 KR3  
 GMA  
 GMD  
 ⚠Caution /Notice

Part number # indicates the package specification code.



# GRM Series Temperature Compensating Type Part Number List

(→ 1.6×0.8mm)

| T max.  | Rated Voltage | TC Code            | Cap.               | Tol.               | Part Number        |         |         |                    |                    |
|---------|---------------|--------------------|--------------------|--------------------|--------------------|---------|---------|--------------------|--------------------|
| 0.9mm   | 50Vdc         | CH                 | 3300pF             | ±5%                | GRM1882C1H332JA01# |         |         |                    |                    |
|         |               |                    | 3900pF             | ±5%                | GRM1882C1H392JA01# |         |         |                    |                    |
|         |               |                    | 4700pF             | ±5%                | GRM1882C1H472JA01# |         |         |                    |                    |
|         |               |                    | 5600pF             | ±5%                | GRM1882C1H562JA01# |         |         |                    |                    |
|         |               |                    | 6800pF             | ±5%                | GRM1882C1H682JA01# |         |         |                    |                    |
|         |               |                    | 8200pF             | ±5%                | GRM1882C1H822JA01# |         |         |                    |                    |
|         |               |                    | 10000pF            | ±5%                | GRM1882C1H103JA01# |         |         |                    |                    |
| 0.9mm   | 50Vdc         | SL                 | 1200pF             | ±5%                | GRM1881X1H122JA01# |         |         |                    |                    |
|         |               |                    | 1500pF             | ±5%                | GRM1881X1H152JA01# |         |         |                    |                    |
|         |               |                    | 1800pF             | ±5%                | GRM1881X1H182JA01# |         |         |                    |                    |
|         |               |                    | 2200pF             | ±5%                | GRM1881X1H222JA01# |         |         |                    |                    |
|         |               |                    | 2700pF             | ±5%                | GRM1881X1H272JA01# |         |         |                    |                    |
|         |               |                    | 3300pF             | ±5%                | GRM1881X1H332JA01# |         |         |                    |                    |
|         |               |                    | 3900pF             | ±5%                | GRM1881X1H392JA01# |         |         |                    |                    |
|         |               |                    | 4700pF             | ±5%                | GRM1881X1H472JA01# |         |         |                    |                    |
|         |               |                    | 5600pF             | ±5%                | GRM1881X1H562JA01# |         |         |                    |                    |
|         |               |                    | 6800pF             | ±5%                | GRM1881X1H682JA01# |         |         |                    |                    |
|         |               |                    | 8200pF             | ±5%                | GRM1881X1H822JA01# |         |         |                    |                    |
|         |               | 10000pF            | ±5%                | GRM1881X1H103JA01# |                    |         |         |                    |                    |
|         |               | U2J                | 1200pF             | ±5%                | GRM1887U1H122JA01# |         |         |                    |                    |
|         |               |                    | 1500pF             | ±5%                | GRM1887U1H152JA01# |         |         |                    |                    |
|         |               |                    | 1800pF             | ±5%                | GRM1887U1H182JA01# |         |         |                    |                    |
|         |               |                    | 2200pF             | ±5%                | GRM1887U1H222JA01# |         |         |                    |                    |
|         |               |                    | 2700pF             | ±5%                | GRM1887U1H272JA01# |         |         |                    |                    |
|         |               |                    | 3300pF             | ±5%                | GRM1887U1H332JA01# |         |         |                    |                    |
|         |               |                    | 3900pF             | ±5%                | GRM1887U1H392JA01# |         |         |                    |                    |
|         |               |                    | 4700pF             | ±5%                | GRM1887U1H472JA01# |         |         |                    |                    |
|         |               |                    | 5600pF             | ±5%                | GRM1887U1H562JA01# |         |         |                    |                    |
| 6800pF  | ±5%           |                    | GRM1887U1H682JA01# |                    |                    |         |         |                    |                    |
| 8200pF  | ±5%           | GRM1887U1H822JA01# |                    |                    |                    |         |         |                    |                    |
| 10000pF | ±5%           | GRM1887U1H103JA01# |                    |                    |                    |         |         |                    |                    |
| UJ      | 50Vdc         | UJ                 | 1000pF             | ±5%                | GRM1883U1H102JA01# |         |         |                    |                    |
|         |               |                    | 1200pF             | ±5%                | GRM1883U1H122JA01# |         |         |                    |                    |
|         |               |                    | 1500pF             | ±5%                | GRM1883U1H152JA01# |         |         |                    |                    |
|         |               |                    | 1800pF             | ±5%                | GRM1883U1H182JA01# |         |         |                    |                    |
|         |               |                    | 2200pF             | ±5%                | GRM1883U1H222JA01# |         |         |                    |                    |
|         |               |                    | 2700pF             | ±5%                | GRM1883U1H272JA01# |         |         |                    |                    |
|         |               |                    | 3300pF             | ±5%                | GRM1883U1H332JA01# |         |         |                    |                    |
|         |               |                    | 3900pF             | ±5%                | GRM1883U1H392JA01# |         |         |                    |                    |
|         |               |                    | 4700pF             | ±5%                | GRM1883U1H472JA01# |         |         |                    |                    |
|         |               |                    | 5600pF             | ±5%                | GRM1883U1H562JA01# |         |         |                    |                    |
|         |               |                    | 6800pF             | ±5%                | GRM1883U1H682JA01# |         |         |                    |                    |
|         |               |                    | 8200pF             | ±5%                | GRM1883U1H822JA01# |         |         |                    |                    |
|         |               |                    | 10000pF            | ±5%                | GRM1883U1H103JA01# |         |         |                    |                    |
|         |               |                    | SL                 | 10Vdc              | SL                 | 12000pF | ±5%     | GRM1881X1A123JA01# |                    |
|         |               |                    |                    |                    |                    | 15000pF | ±5%     | GRM1881X1A153JA01# |                    |
|         |               |                    |                    |                    |                    | 18000pF | ±5%     | GRM1881X1A183JA01# |                    |
|         |               |                    |                    |                    |                    | 22000pF | ±5%     | GRM1881X1A223JA01# |                    |
|         |               |                    |                    |                    |                    | U2J     | 12000pF | ±5%                | GRM1887U1A123JA01# |
|         |               |                    |                    |                    |                    |         | 15000pF | ±5%                | GRM1887U1A153JA01# |
| 18000pF | ±5%           | GRM1887U1A183JA01# |                    |                    |                    |         |         |                    |                    |
| 22000pF | ±5%           | GRM1887U1A223JA01# |                    |                    |                    |         |         |                    |                    |
| UJ      | 12000pF       | ±5%                | GRM1883U1A123JA01# |                    |                    |         |         |                    |                    |
|         | 15000pF       | ±5%                | GRM1883U1A153JA01# |                    |                    |         |         |                    |                    |

| T max. | Rated Voltage | TC Code | Cap.    | Tol. | Part Number        |
|--------|---------------|---------|---------|------|--------------------|
| 0.9mm  | 10Vdc         | UJ      | 18000pF | ±5%  | GRM1883U1A183JA01# |
|        |               |         | 22000pF | ±5%  | GRM1883U1A223JA01# |

2.0×1.25mm

| T max. | Rated Voltage | TC Code | Cap.   | Tol.  | Part Number        |                    |                    |
|--------|---------------|---------|--------|-------|--------------------|--------------------|--------------------|
| 0.7mm  | 100Vdc        | COG     | 100pF  | ±5%   | GRM2165C2A101JA01# |                    |                    |
|        |               |         | 120pF  | ±5%   | GRM2165C2A121JA01# |                    |                    |
|        |               |         | 150pF  | ±5%   | GRM2165C2A151JA01# |                    |                    |
|        |               |         | 180pF  | ±5%   | GRM2165C2A181JA01# |                    |                    |
|        |               |         | 220pF  | ±5%   | GRM2165C2A221JA01# |                    |                    |
|        |               |         | 270pF  | ±5%   | GRM2165C2A271JA01# |                    |                    |
|        |               |         | 330pF  | ±5%   | GRM2165C2A331JA01# |                    |                    |
|        |               |         | 390pF  | ±5%   | GRM2165C2A391JA01# |                    |                    |
|        |               |         | 470pF  | ±5%   | GRM2165C2A471JA01# |                    |                    |
|        |               |         | 560pF  | ±5%   | GRM2165C2A561JA01# |                    |                    |
|        |               |         | 680pF  | ±5%   | GRM2165C2A681JA01# |                    |                    |
|        |               |         | 820pF  | ±5%   | GRM2165C2A821JA01# |                    |                    |
|        |               |         | 1000pF | ±5%   | GRM2165C2A102JA01# |                    |                    |
|        |               |         | 1200pF | ±5%   | GRM2165C2A122JA01# |                    |                    |
|        |               |         | 1500pF | ±5%   | GRM2165C2A152JA01# |                    |                    |
|        |               |         | 1800pF | ±5%   | GRM2165C2A182JA01# |                    |                    |
|        |               |         | 2200pF | ±5%   | GRM2165C2A222JA01# |                    |                    |
|        |               |         | 2700pF | ±5%   | GRM2165C2A272JA01# |                    |                    |
|        |               |         | 3300pF | ±5%   | GRM2165C2A332JA01# |                    |                    |
|        |               |         | CH     | 100pF | ±5%                | GRM2162C2A101JA01# |                    |
|        |               |         |        | 120pF | ±5%                | GRM2162C2A121JA01# |                    |
|        |               | 150pF   |        | ±5%   | GRM2162C2A151JA01# |                    |                    |
|        |               | 180pF   |        | ±5%   | GRM2162C2A181JA01# |                    |                    |
|        |               | 220pF   |        | ±5%   | GRM2162C2A221JA01# |                    |                    |
|        |               | 270pF   |        | ±5%   | GRM2162C2A271JA01# |                    |                    |
|        |               | 330pF   |        | ±5%   | GRM2162C2A331JA01# |                    |                    |
|        |               | 390pF   |        | ±5%   | GRM2162C2A391JA01# |                    |                    |
|        |               | 470pF   |        | ±5%   | GRM2162C2A471JA01# |                    |                    |
|        |               | 560pF   |        | ±5%   | GRM2162C2A561JA01# |                    |                    |
|        |               | 680pF   |        | ±5%   | GRM2162C2A681JA01# |                    |                    |
|        |               | 820pF   |        | ±5%   | GRM2162C2A821JA01# |                    |                    |
|        |               | COG     | 50Vdc  | COG   | 1200pF             | ±5%                | GRM2165C1H122JA01# |
|        |               |         |        |       | 1500pF             | ±5%                | GRM2165C1H152JA01# |
| 1800pF | ±5%           |         |        |       | GRM2165C1H182JA01# |                    |                    |
| 2200pF | ±5%           |         |        |       | GRM2165C1H222JA01# |                    |                    |
| 2700pF | ±5%           |         |        |       | GRM2165C1H272JA01# |                    |                    |
| 3300pF | ±5%           |         |        |       | GRM2165C1H332JA01# |                    |                    |
| 3900pF | ±5%           |         |        |       | GRM2165C1H392JA01# |                    |                    |
| 4700pF | ±5%           |         |        |       | GRM2165C1H472JA01# |                    |                    |
| CH     | 1200pF        |         |        |       | ±5%                | GRM2162C1H122JA01# |                    |

Part number # indicates the package specification code.



# GRM Series Temperature Compensating Type Part Number List

(→ 2.0×1.25mm)

| T max.  | Rated Voltage | TC Code | Cap.    | Tol.    | Part Number        | T max.             | Rated Voltage      | TC Code            | Cap.               | Tol.               | Part Number        |                    |                    |
|---------|---------------|---------|---------|---------|--------------------|--------------------|--------------------|--------------------|--------------------|--------------------|--------------------|--------------------|--------------------|
| 0.7mm   | 50Vdc         | CH      | 1500pF  | ±5%     | GRM2162C1H152JA01# | 1.0mm              | 630Vdc             | COG                | 220pF              | ±5%                | GRM21A5C2J221JWA1# |                    |                    |
|         |               |         | 1800pF  | ±5%     | GRM2162C1H182JA01# |                    |                    |                    | 270pF              | ±5%                | GRM21A5C2J271JWA1# |                    |                    |
|         |               |         | 2200pF  | ±5%     | GRM2162C1H222JA01# |                    |                    |                    | 330pF              | ±5%                | GRM21A5C2J331JWA1# |                    |                    |
|         |               |         | 2700pF  | ±5%     | GRM2162C1H272JA01# |                    |                    |                    | 390pF              | ±5%                | GRM21A5C2J391JWA1# |                    |                    |
|         |               |         | 3300pF  | ±5%     | GRM2162C1H332JA01# |                    |                    |                    | 470pF              | ±5%                | GRM21A5C2J471JWA1# |                    |                    |
|         |               |         | 3900pF  | ±5%     | GRM2162C1H392JA01# |                    |                    |                    | 560pF              | ±5%                | GRM21A5C2J561JWA1# |                    |                    |
|         |               |         | 4700pF  | ±5%     | GRM2162C1H472JA01# |                    |                    |                    | 250Vdc             | COG                | 10pF               | ±5%                | GRM21A5C2E100JW01# |
|         |               |         | SL      | 12000pF | ±5%                |                    |                    |                    |                    |                    | GRM2161X1H123JA01# | 12pF               | ±5%                |
|         |               | 15000pF |         | ±5%     | GRM2161X1H153JA01# |                    |                    | 15pF               |                    |                    | ±5%                | GRM21A5C2E150JW01# |                    |
|         |               | 18000pF |         | ±5%     | GRM2161X1H183JA01# |                    |                    | 18pF               |                    |                    | ±5%                | GRM21A5C2E180JW01# |                    |
|         |               | U2J     | 12000pF | ±5%     | GRM2167U1H123JA01# |                    |                    | 22pF               |                    |                    | ±5%                | GRM21A5C2E220JW01# |                    |
|         |               |         | 15000pF | ±5%     | GRM2167U1H153JA01# |                    |                    | 27pF               |                    |                    | ±5%                | GRM21A5C2E270JW01# |                    |
|         |               |         | 18000pF | ±5%     | GRM2167U1H183JA01# |                    |                    | 33pF               |                    |                    | ±5%                | GRM21A5C2E330JW01# |                    |
|         |               | UJ      | 10000pF | ±5%     | GRM2163U1H103JA01# |                    |                    | 39pF               |                    |                    | ±5%                | GRM21A5C2E390JW01# |                    |
|         |               |         | 12000pF | ±5%     | GRM2163U1H123JA01# |                    |                    | 47pF               |                    |                    | ±5%                | GRM21A5C2E470JW01# |                    |
|         |               |         | 15000pF | ±5%     | GRM2163U1H153JA01# |                    |                    | 56pF               |                    |                    | ±5%                | GRM21A5C2E560JW01# |                    |
|         |               |         | 18000pF | ±5%     | GRM2163U1H183JA01# |                    |                    | 68pF               | ±5%                | GRM21A5C2E680JW01# |                    |                    |                    |
|         |               | 0.95mm  | 50Vdc   | COG     | 5600pF             |                    |                    | ±5%                | GRM2195C1H562JA01# | 82pF               | ±5%                | GRM21A5C2E820JW01# |                    |
|         |               |         |         |         | 6800pF             |                    |                    | ±5%                | GRM2195C1H682JA01# | 100pF              | ±5%                | GRM21A5C2E101JW01# |                    |
|         |               |         |         |         | 8200pF             |                    |                    | ±5%                | GRM2195C1H822JA01# | 120pF              | ±5%                | GRM21A5C2E121JW01# |                    |
|         |               |         |         |         | 10000pF            |                    |                    | ±5%                | GRM2195C1H103JA01# | 150pF              | ±5%                | GRM21A5C2E151JW01# |                    |
| 12000pF | ±5%           |         |         |         | GRM2195C1H123JA01# | 180pF              | ±5%                | GRM21A5C2E181JW01# |                    |                    |                    |                    |                    |
| 15000pF | ±5%           |         |         |         | GRM2195C1H153JA01# | 220pF              | ±5%                | GRM21A5C2E221JW01# |                    |                    |                    |                    |                    |
| CH      | 5600pF        |         |         | ±5%     | GRM2192C1H562JA01# | 270pF              | ±5%                | GRM21A5C2E271JW01# |                    |                    |                    |                    |                    |
|         | 6800pF        |         |         | ±5%     | GRM2192C1H682JA01# | 330pF              | ±5%                | GRM21A5C2E331JW01# |                    |                    |                    |                    |                    |
|         | 8200pF        |         |         | ±5%     | GRM2192C1H822JA01# | 390pF              | ±5%                | GRM21A5C2E391JWA1# |                    |                    |                    |                    |                    |
|         | 10000pF       |         |         | ±5%     | GRM2192C1H103JA01# | 470pF              | ±5%                | GRM21A5C2E471JWA1# |                    |                    |                    |                    |                    |
|         | 12000pF       |         |         | ±5%     | GRM2192C1H123JA01# | 560pF              | ±5%                | GRM21A5C2E561JWA1# |                    |                    |                    |                    |                    |
|         | 15000pF       |         |         | ±5%     | GRM2192C1H153JA01# | 680pF              | ±5%                | GRM21A5C2E681JWA1# |                    |                    |                    |                    |                    |
| SL      | 22000pF       |         |         | ±5%     | GRM2191X1H223JA01# | 820pF              | ±5%                | GRM21A5C2E821JWA1# |                    |                    |                    |                    |                    |
|         | 27000pF       |         |         | ±5%     | GRM2191X1H273JA01# | 1000pF             | ±5%                | GRM21A5C2E102JWA1# |                    |                    |                    |                    |                    |
| U2J     | 22000pF       |         |         | ±5%     | GRM2197U1H223JA01# | 1200pF             | ±5%                | GRM21A5C2E122JWA1# |                    |                    |                    |                    |                    |
|         | 27000pF       |         |         | ±5%     | GRM2197U1H273JA01# | 1500pF             | ±5%                | GRM21A5C2E152JWA1# |                    |                    |                    |                    |                    |
| UJ      | 22000pF       |         |         | ±5%     | GRM2193U1H223JA01# | 1800pF             | ±5%                | GRM21A5C2E182JWA1# |                    |                    |                    |                    |                    |
|         | 27000pF       |         |         | ±5%     | GRM2193U1H273JA01# | 2200pF             | ±5%                | GRM21A5C2E222JWA1# |                    |                    |                    |                    |                    |
| 10Vdc   | SL            |         |         | 56000pF | ±5%                | GRM2191X1A563JA01# | 2700pF             | ±5%                | GRM21A5C2E272JWA1# |                    |                    |                    |                    |
|         |               |         |         | U2J     | 56000pF            | ±5%                | GRM2197U1A563JA01# | U2J                | 100pF              | ±5%                | GRM21A7U2E101JW31# |                    |                    |
|         |               |         |         | UJ      | 56000pF            | ±5%                | GRM2193U1A563JA01# |                    | 120pF              | ±5%                | GRM21A7U2E121JW31# |                    |                    |
| 1.0mm   | 630Vdc        | COG     | 10pF    | ±5%     | GRM21A5C2J100JWA1# | 150pF              | ±5%                |                    | GRM21A7U2E151JW31# |                    |                    |                    |                    |
|         |               |         | 12pF    | ±5%     | GRM21A5C2J120JWA1# | 180pF              | ±5%                |                    | GRM21A7U2E181JW31# |                    |                    |                    |                    |
|         |               |         | 15pF    | ±5%     | GRM21A5C2J150JWA1# | 220pF              | ±5%                |                    | GRM21A7U2E221JW31# |                    |                    |                    |                    |
|         |               |         | 18pF    | ±5%     | GRM21A5C2J180JWA1# | 270pF              | ±5%                |                    | GRM21A7U2E271JW31# |                    |                    |                    |                    |
|         |               |         | 22pF    | ±5%     | GRM21A5C2J220JWA1# | 330pF              | ±5%                |                    | GRM21A7U2E331JW31# |                    |                    |                    |                    |
|         |               |         | 27pF    | ±5%     | GRM21A5C2J270JWA1# | 390pF              | ±5%                |                    | GRM21A7U2E391JW31# |                    |                    |                    |                    |
|         |               |         | 33pF    | ±5%     | GRM21A5C2J330JWA1# | 470pF              | ±5%                |                    | GRM21A7U2E471JW31# |                    |                    |                    |                    |
|         |               |         | 39pF    | ±5%     | GRM21A5C2J390JWA1# | 560pF              | ±5%                |                    | GRM21A7U2E561JW31# |                    |                    |                    |                    |
|         |               |         | 47pF    | ±5%     | GRM21A5C2J470JWA1# | 680pF              | ±5%                | GRM21A7U2E681JW31# |                    |                    |                    |                    |                    |
|         |               |         | 56pF    | ±5%     | GRM21A5C2J560JWA1# | 820pF              | ±5%                | GRM21A7U2E821JW31# |                    |                    |                    |                    |                    |
|         |               |         | 68pF    | ±5%     | GRM21A5C2J680JWA1# | 1000pF             | ±5%                | GRM21A7U2E102JW31# |                    |                    |                    |                    |                    |
|         |               |         | 82pF    | ±5%     | GRM21A5C2J820JWA1# | 1200pF             | ±5%                | GRM21A7U2E122JW31# |                    |                    |                    |                    |                    |
|         |               |         | 100pF   | ±5%     | GRM21A5C2J101JWA1# | 1500pF             | ±5%                | GRM21A7U2E152JW31# |                    |                    |                    |                    |                    |
|         |               |         | 120pF   | ±5%     | GRM21A5C2J121JWA1# | 1800pF             | ±5%                | GRM21A7U2E182JW31# |                    |                    |                    |                    |                    |
|         |               |         | 150pF   | ±5%     | GRM21A5C2J151JWA1# | 2200pF             | ±5%                | GRM21A7U2E222JW31# |                    |                    |                    |                    |                    |
|         |               |         | 180pF   | ±5%     | GRM21A5C2J181JWA1# | 200Vdc             | COG                | 10pF               | ±5%                | GRM21A5C2D100JW01# |                    |                    |                    |

Part number # indicates the package specification code.

⚠Caution / Notice

GRM  
 GR3  
 GRJ  
 GR4  
 GR7  
 GJM  
 GQM  
 GA2  
 GA3 GB  
 GA3 GD  
 GA3 GF  
 LLL  
 LLA  
 LLM  
 LLR  
 NFM  
 KRM  
 KR3  
 GMA  
 GMD

# GRM Series Temperature Compensating Type Part Number List

(→ 2.0×1.25mm)

| T max.  | Rated Voltage | TC Code | Cap.    | Tol.    | Part Number        |                    |                    |                    |
|---------|---------------|---------|---------|---------|--------------------|--------------------|--------------------|--------------------|
| 1.0mm   | 200Vdc        | COG     | 12pF    | ±5%     | GRM21A5C2D120JW01# |                    |                    |                    |
|         |               |         | 15pF    | ±5%     | GRM21A5C2D150JW01# |                    |                    |                    |
|         |               |         | 18pF    | ±5%     | GRM21A5C2D180JW01# |                    |                    |                    |
|         |               |         |         |         |                    | 22pF               | ±5%                | GRM21A5C2D220JW01# |
|         |               |         |         |         |                    | 27pF               | ±5%                | GRM21A5C2D270JW01# |
|         |               |         |         |         |                    | 33pF               | ±5%                | GRM21A5C2D330JW01# |
|         |               |         |         |         |                    | 39pF               | ±5%                | GRM21A5C2D390JW01# |
|         |               |         |         |         |                    | 47pF               | ±5%                | GRM21A5C2D470JW01# |
|         |               |         |         |         |                    | 56pF               | ±5%                | GRM21A5C2D560JW01# |
|         |               |         |         |         |                    | 68pF               | ±5%                | GRM21A5C2D680JW01# |
|         |               |         |         |         |                    | 82pF               | ±5%                | GRM21A5C2D820JW01# |
|         |               |         |         |         |                    | 100pF              | ±5%                | GRM21A5C2D101JW01# |
|         |               |         |         |         |                    | 120pF              | ±5%                | GRM21A5C2D121JW01# |
|         |               |         |         |         |                    | 150pF              | ±5%                | GRM21A5C2D151JW01# |
|         |               |         |         |         |                    | 180pF              | ±5%                | GRM21A5C2D181JW01# |
|         |               |         |         |         |                    | 220pF              | ±5%                | GRM21A5C2D221JW01# |
|         |               |         |         |         |                    | 270pF              | ±5%                | GRM21A5C2D271JW01# |
|         |               |         |         |         |                    | 330pF              | ±5%                | GRM21A5C2D331JW01# |
|         |               |         |         |         | U2J                | 100pF              | ±5%                | GRM21A7U2D101JW31# |
|         |               |         |         |         |                    | 120pF              | ±5%                | GRM21A7U2D121JW31# |
|         |               |         |         |         |                    | 150pF              | ±5%                | GRM21A7U2D151JW31# |
|         |               |         |         |         |                    | 180pF              | ±5%                | GRM21A7U2D181JW31# |
|         |               |         |         |         |                    | 220pF              | ±5%                | GRM21A7U2D221JW31# |
|         |               |         |         |         |                    | 270pF              | ±5%                | GRM21A7U2D271JW31# |
|         |               |         |         |         |                    | 330pF              | ±5%                | GRM21A7U2D331JW31# |
|         |               |         |         |         |                    | 390pF              | ±5%                | GRM21A7U2D391JW31# |
|         |               |         |         |         |                    | 470pF              | ±5%                | GRM21A7U2D471JW31# |
|         |               |         |         |         |                    | 560pF              | ±5%                | GRM21A7U2D561JW31# |
|         |               |         |         |         |                    | 680pF              | ±5%                | GRM21A7U2D681JW31# |
|         |               |         |         |         |                    | 820pF              | ±5%                | GRM21A7U2D821JW31# |
|         |               |         |         |         | 1000pF             | ±5%                | GRM21A7U2D102JW31# |                    |
|         |               |         |         |         | 1200pF             | ±5%                | GRM21A7U2D122JW31# |                    |
|         |               |         |         |         | 1500pF             | ±5%                | GRM21A7U2D152JW31# |                    |
|         |               |         | 1800pF  | ±5%     | GRM21A7U2D182JW31# |                    |                    |                    |
|         |               |         | 2200pF  | ±5%     | GRM21A7U2D222JW31# |                    |                    |                    |
|         |               | 50Vdc   | SL      | 33000pF | ±5%                | GRM21A1X1H333JA39# |                    |                    |
|         |               |         | U2J     | 33000pF | ±5%                | GRM21A7U1H333JA39# |                    |                    |
|         |               |         | UJ      | 33000pF | ±5%                | GRM21A3U1H333JA39# |                    |                    |
|         | 1.35mm        | 50Vdc   | COG     | 18000pF | ±5%                | GRM21B5C1H183JA01# |                    |                    |
|         |               |         |         | 22000pF | ±5%                | GRM21B5C1H223JA01# |                    |                    |
|         |               |         |         | CH      | 18000pF            | ±5%                | GRM21B2C1H183JA01# |                    |
|         |               |         |         |         | 22000pF            | ±5%                | GRM21B2C1H223JA01# |                    |
|         |               |         |         | SL      | 39000pF            | ±5%                | GRM21B1X1H393JA01# |                    |
|         |               |         |         |         | 47000pF            | ±5%                | GRM21B1X1H473JA01# |                    |
|         |               |         | U2J     | 39000pF | ±5%                | GRM21B7U1H393JA01# |                    |                    |
| 47000pF |               |         |         | ±5%     | GRM21B7U1H473JA01# |                    |                    |                    |
| UJ      |               |         | 39000pF | ±5%     | GRM21B3U1H393JA01# |                    |                    |                    |
|         |               |         | 47000pF | ±5%     | GRM21B3U1H473JA01# |                    |                    |                    |
|         |               |         |         |         |                    |                    |                    |                    |
| 10Vdc   |               |         | SL      | 68000pF | ±5%                | GRM21B1X1A683JA01# |                    |                    |
|         |               | 82000pF |         | ±5%     | GRM21B1X1A823JA01# |                    |                    |                    |
|         |               | 0.10μF  |         | ±5%     | GRM21B1X1A104JA01# |                    |                    |                    |
|         |               | U2J     | 68000pF | ±5%     | GRM21B7U1A683JA01# |                    |                    |                    |
|         |               |         | 82000pF | ±5%     | GRM21B7U1A823JA01# |                    |                    |                    |
|         |               |         | 0.10μF  | ±5%     | GRM21B7U1A104JA01# |                    |                    |                    |
|         |               |         |         |         |                    |                    |                    |                    |

| T max. | Rated Voltage | TC Code | Cap.               | Tol.               | Part Number        |     |                    |
|--------|---------------|---------|--------------------|--------------------|--------------------|-----|--------------------|
| 1.35mm | 10Vdc         | UJ      | 68000pF            | ±5%                | GRM21B3U1A683JA01# |     |                    |
|        |               |         | 82000pF            | ±5%                | GRM21B3U1A823JA01# |     |                    |
|        |               |         | 0.10μF             | ±5%                | GRM21B3U1A104JA01# |     |                    |
| 1.45mm | 630Vdc        | COG     | 680pF              | ±5%                | GRM21B5C2J681JWA3# |     |                    |
|        |               |         | 820pF              | ±5%                | GRM21B5C2J821JWA3# |     |                    |
|        |               |         | 1000pF             | ±5%                | GRM21B5C2J102JWA3# |     |                    |
|        |               |         | 1200pF             | ±5%                | GRM21B5C2J122JWA3# |     |                    |
|        |               |         | 250Vdc             | COG                | 3300pF             | ±5% | GRM21B5C2E332JWA1# |
|        |               |         |                    |                    | 3900pF             | ±5% | GRM21B5C2E392JWA1# |
|        | 4700pF        | ±5%     |                    |                    | GRM21B5C2E472JWA1# |     |                    |
|        | U2J           | 2700pF  |                    | ±5%                | GRM21B7U2E272JW32# |     |                    |
|        |               | 3300pF  |                    | ±5%                | GRM21B7U2E332JW32# |     |                    |
|        |               | 3900pF  |                    | ±5%                | GRM21B7U2E392JW32# |     |                    |
|        | 200Vdc        | U2J     | 4700pF             | ±5%                | GRM21B7U2E472JW32# |     |                    |
|        |               |         | 5600pF             | ±5%                | GRM21B7U2E562JW32# |     |                    |
| 2700pF |               |         | ±5%                | GRM21B7U2D272JW32# |                    |     |                    |
| 3300pF |               | ±5%     | GRM21B7U2D332JW32# |                    |                    |     |                    |
| 3900pF |               | ±5%     | GRM21B7U2D392JW32# |                    |                    |     |                    |
| 4700pF |               | ±5%     | GRM21B7U2D472JW32# |                    |                    |     |                    |
|        |               |         | 5600pF             | ±5%                | GRM21B7U2D562JW32# |     |                    |

## 3.2×1.6mm

| T max. | Rated Voltage | TC Code | Cap.    | Tol.    | Part Number        |                    |
|--------|---------------|---------|---------|---------|--------------------|--------------------|
| 0.95mm | 100Vdc        | COG     | 1800pF  | ±5%     | GRM3195C2A182JA01# |                    |
|        |               |         | 2200pF  | ±5%     | GRM3195C2A222JA01# |                    |
|        |               |         | 2700pF  | ±5%     | GRM3195C2A272JA01# |                    |
|        |               |         | 3300pF  | ±5%     | GRM3195C2A332JA01# |                    |
|        |               |         | 3900pF  | ±5%     | GRM3195C2A392JA01# |                    |
|        |               |         | 4700pF  | ±5%     | GRM3195C2A472JA01# |                    |
|        |               |         | 5600pF  | ±5%     | GRM3195C2A562JA01# |                    |
|        |               |         | 6800pF  | ±5%     | GRM3195C2A682JA01# |                    |
|        |               |         | 8200pF  | ±5%     | GRM3195C2A822JA01# |                    |
|        |               |         | 10000pF | ±5%     | GRM3195C2A103JA01# |                    |
|        |               |         | 12000pF | ±5%     | GRM3195C2A123JA01# |                    |
|        |               |         | 15000pF | ±5%     | GRM3195C2A153JA01# |                    |
|        |               |         | 18000pF | ±5%     | GRM3195C2A183JA01# |                    |
|        |               |         | 22000pF | ±5%     | GRM3195C2A223JA01# |                    |
|        |               |         | 27000pF | ±5%     | GRM3195C2A273JA01# |                    |
|        |               |         | 33000pF | ±5%     | GRM3195C2A333JA01# |                    |
|        |               |         | 39000pF | ±5%     | GRM3195C2A393JA01# |                    |
|        |               |         | CH      | 1800pF  | ±5%                | GRM3192C2A182JA01# |
|        |               |         |         | 2200pF  | ±5%                | GRM3192C2A222JA01# |
|        |               |         |         | 2700pF  | ±5%                | GRM3192C2A272JA01# |
|        |               |         |         | 3300pF  | ±5%                | GRM3192C2A332JA01# |
|        |               |         |         | 3900pF  | ±5%                | GRM3192C2A392JA01# |
|        |               |         |         | 4700pF  | ±5%                | GRM3192C2A472JA01# |
|        |               |         |         | 5600pF  | ±5%                | GRM3192C2A562JA01# |
|        |               |         |         | 6800pF  | ±5%                | GRM3192C2A682JA01# |
|        |               |         |         | 8200pF  | ±5%                | GRM3192C2A822JA01# |
|        |               |         |         | 10000pF | ±5%                | GRM3192C2A103JA01# |
|        |               |         |         | 12000pF | ±5%                | GRM3192C2A123JA01# |
|        |               |         |         | 15000pF | ±5%                | GRM3192C2A153JA01# |

Part number # indicates the package specification code.



# GRM Series Temperature Compensating Type Part Number List

(→ 3.2×1.6mm)

| T max. | Rated Voltage | TC Code            | Cap.               | Tol.               | Part Number        | T max.             | Rated Voltage      | TC Code            | Cap.               | Tol.   | Part Number        |                    |                    |                    |                    |                    |
|--------|---------------|--------------------|--------------------|--------------------|--------------------|--------------------|--------------------|--------------------|--------------------|--------|--------------------|--------------------|--------------------|--------------------|--------------------|--------------------|
| 0.95mm | 100Vdc        | CH                 | 1800pF             | ±5%                | GRM3192C2A183JA01# | 1.0mm              | 1000Vdc            | U2J                | 10pF               | ±5%    | GRM31A7U3A100JW31# |                    |                    |                    |                    |                    |
|        |               |                    | 2200pF             | ±5%                | GRM3192C2A223JA01# |                    |                    |                    | 12pF               | ±5%    | GRM31A7U3A120JW31# |                    |                    |                    |                    |                    |
|        |               |                    | 2700pF             | ±5%                | GRM3192C2A273JA01# |                    |                    |                    | 15pF               | ±5%    | GRM31A7U3A150JW31# |                    |                    |                    |                    |                    |
|        |               |                    | 3300pF             | ±5%                | GRM3192C2A333JA01# |                    |                    |                    | 18pF               | ±5%    | GRM31A7U3A180JW31# |                    |                    |                    |                    |                    |
|        |               |                    | 3900pF             | ±5%                | GRM3192C2A393JA01# |                    |                    |                    | 22pF               | ±5%    | GRM31A7U3A220JW31# |                    |                    |                    |                    |                    |
|        | 50Vdc         | COG                | 12000pF            | ±5%                | GRM3195C1H123JA01# |                    |                    |                    | 27pF               | ±5%    | GRM31A7U3A270JW31# |                    |                    |                    |                    |                    |
|        |               |                    | 15000pF            | ±5%                | GRM3195C1H153JA01# |                    |                    |                    | 33pF               | ±5%    | GRM31A7U3A330JW31# |                    |                    |                    |                    |                    |
|        |               |                    | 18000pF            | ±5%                | GRM3195C1H183JA01# |                    |                    |                    | 39pF               | ±5%    | GRM31A7U3A390JW31# |                    |                    |                    |                    |                    |
|        |               |                    | 22000pF            | ±5%                | GRM3195C1H223JA01# |                    |                    |                    | 47pF               | ±5%    | GRM31A7U3A470JW31# |                    |                    |                    |                    |                    |
|        |               |                    | 27000pF            | ±5%                | GRM3195C1H273JA01# |                    |                    |                    | 56pF               | ±5%    | GRM31A7U3A560JW31# |                    |                    |                    |                    |                    |
|        |               |                    | 33000pF            | ±5%                | GRM3195C1H333JA01# |                    |                    |                    | 68pF               | ±5%    | GRM31A7U3A680JW31# |                    |                    |                    |                    |                    |
|        |               |                    | 39000pF            | ±5%                | GRM3195C1H393JA01# |                    |                    |                    | 82pF               | ±5%    | GRM31A7U3A820JW31# |                    |                    |                    |                    |                    |
|        |               |                    | CH                 | 12000pF            | ±5%                |                    |                    |                    | GRM3192C1H123JA01# | 100pF  | ±5%                | GRM31A7U3A101JW31# |                    |                    |                    |                    |
|        |               |                    |                    | 15000pF            | ±5%                |                    |                    |                    | GRM3192C1H153JA01# | 120pF  | ±5%                | GRM31A7U3A121JW31# |                    |                    |                    |                    |
|        |               |                    |                    | 18000pF            | ±5%                |                    |                    |                    | GRM3192C1H183JA01# | 150pF  | ±5%                | GRM31A7U3A151JW31# |                    |                    |                    |                    |
|        |               | 22000pF            |                    | ±5%                | GRM3192C1H223JA01# |                    |                    |                    | 180pF              | ±5%    | GRM31A7U3A181JW31# |                    |                    |                    |                    |                    |
|        |               | 27000pF            |                    | ±5%                | GRM3192C1H273JA01# |                    |                    |                    | 220pF              | ±5%    | GRM31A7U3A221JW31# |                    |                    |                    |                    |                    |
|        |               | 33000pF            |                    | ±5%                | GRM3192C1H333JA01# |                    |                    |                    | 270pF              | ±5%    | GRM31A7U3A271JW31# |                    |                    |                    |                    |                    |
|        |               | 39000pF            |                    | ±5%                | GRM3192C1H393JA01# |                    |                    |                    | 330pF              | ±5%    | GRM31A7U3A331JW31# |                    |                    |                    |                    |                    |
|        |               | SL                 |                    | 56000pF            | ±5%                |                    |                    |                    | GRM3191X1H563JA01# | 630Vdc | COG                | 10pF               | ±5%                | GRM31A5C2J100JW01# |                    |                    |
|        |               |                    |                    | U2J                | 56000pF            |                    |                    |                    | ±5%                |        |                    | GRM3197U1H563JA01# | 12pF               | ±5%                | GRM31A5C2J120JW01# |                    |
|        |               | UJ                 |                    | 56000pF            | ±5%                |                    |                    |                    | GRM3193U1H563JA01# |        |                    | 15pF               | ±5%                | GRM31A5C2J150JW01# |                    |                    |
|        |               | 1.0mm              | 2000Vdc            | U2J                | 10pF               |                    |                    |                    | ±5%                |        |                    | GRM31A7U3D100JW31# | 18pF               | ±5%                | GRM31A5C2J180JW01# |                    |
|        |               |                    |                    |                    | 12pF               |                    |                    |                    | ±5%                |        |                    | GRM31A7U3D120JW31# | 22pF               | ±5%                | GRM31A5C2J220JW01# |                    |
|        |               |                    |                    |                    | 15pF               |                    |                    |                    | ±5%                |        |                    | GRM31A7U3D150JW31# | 27pF               | ±5%                | GRM31A5C2J270JW01# |                    |
|        | 18pF          |                    |                    |                    | ±5%                |                    |                    |                    | GRM31A7U3D180JW31# |        |                    | 33pF               | ±5%                | GRM31A5C2J330JW01# |                    |                    |
|        | 22pF          |                    |                    |                    | ±5%                |                    |                    |                    | GRM31A7U3D220JW31# |        |                    | 39pF               | ±5%                | GRM31A5C2J390JW01# |                    |                    |
|        | 27pF          |                    |                    |                    | ±5%                |                    |                    |                    | GRM31A7U3D270JW31# |        |                    | 47pF               | ±5%                | GRM31A5C2J470JW01# |                    |                    |
|        | 33pF          |                    |                    |                    | ±5%                |                    |                    |                    | GRM31A7U3D330JW31# |        |                    | 56pF               | ±5%                | GRM31A5C2J560JW01# |                    |                    |
|        | 39pF          |                    |                    |                    | ±5%                |                    |                    |                    | GRM31A7U3D390JW31# |        |                    | 68pF               | ±5%                | GRM31A5C2J680JW01# |                    |                    |
|        | 47pF          |                    |                    |                    | ±5%                |                    |                    |                    | GRM31A7U3D470JW31# |        |                    | 82pF               | ±5%                | GRM31A5C2J820JW01# |                    |                    |
|        | 56pF          |                    |                    |                    | ±5%                |                    |                    |                    | GRM31A7U3D560JW31# |        |                    | 100pF              | ±5%                | GRM31A5C2J101JW01# |                    |                    |
|        | 68pF          |                    |                    |                    | ±5%                |                    |                    |                    | GRM31A7U3D680JW31# |        |                    | 120pF              | ±5%                | GRM31A5C2J121JW01# |                    |                    |
|        | 1000Vdc       |                    |                    |                    | COG                |                    |                    |                    | 10pF               |        |                    | ±5%                | GRM31A5C3A100JW01# | 150pF              | ±5%                | GRM31A5C2J151JW01# |
|        |               |                    |                    |                    |                    |                    |                    |                    | 12pF               |        |                    | ±5%                | GRM31A5C3A120JW01# | 180pF              | ±5%                | GRM31A5C2J181JW01# |
|        |               |                    |                    |                    |                    |                    |                    |                    | 15pF               |        |                    | ±5%                | GRM31A5C3A150JW01# | 220pF              | ±5%                | GRM31A5C2J221JW01# |
| 18pF   |               |                    | ±5%                | GRM31A5C3A180JW01# |                    | 270pF              | ±5%                | GRM31A5C2J271JW01# |                    |        |                    |                    |                    |                    |                    |                    |
| 22pF   |               |                    | ±5%                | GRM31A5C3A220JW01# |                    | 330pF              | ±5%                | GRM31A5C2J331JW01# |                    |        |                    |                    |                    |                    |                    |                    |
| 27pF   |               |                    | ±5%                | GRM31A5C3A270JW01# |                    | 390pF              | ±5%                | GRM31A5C2J391JW01# |                    |        |                    |                    |                    |                    |                    |                    |
| 33pF   |               |                    | ±5%                | GRM31A5C3A330JW01# |                    | 470pF              | ±5%                | GRM31A5C2J471JW01# |                    |        |                    |                    |                    |                    |                    |                    |
| 39pF   |               |                    | ±5%                | GRM31A5C3A390JW01# |                    | 560pF              | ±5%                | GRM31A5C2J561JW01# |                    |        |                    |                    |                    |                    |                    |                    |
| 47pF   |               |                    | ±5%                | GRM31A5C3A470JW01# |                    | 1200pF             | ±5%                | GRM31A5C2J122JWA1# |                    |        |                    |                    |                    |                    |                    |                    |
| 56pF   |               |                    | ±5%                | GRM31A5C3A560JW01# |                    | 1500pF             | ±5%                | GRM31A5C2J152JWA1# |                    |        |                    |                    |                    |                    |                    |                    |
| U2J    | 68pF          |                    | ±5%                | GRM31A5C3A680JW01# | 1800pF             | ±5%                | GRM31A5C2J182JWA1# |                    |                    |        |                    |                    |                    |                    |                    |                    |
|        | 82pF          |                    | ±5%                | GRM31A5C3A820JW01# | 10pF               | ±5%                | GRM31A7U2J100JW31# |                    |                    |        |                    |                    |                    |                    |                    |                    |
|        | 100pF         |                    | ±5%                | GRM31A5C3A101JW01# | 12pF               | ±5%                | GRM31A7U2J120JW31# |                    |                    |        |                    |                    |                    |                    |                    |                    |
|        | 120pF         | ±5%                | GRM31A5C3A121JW01# | 15pF               | ±5%                | GRM31A7U2J150JW31# |                    |                    |                    |        |                    |                    |                    |                    |                    |                    |
|        | 150pF         | ±5%                | GRM31A5C3A151JW01# | 18pF               | ±5%                | GRM31A7U2J180JW31# |                    |                    |                    |        |                    |                    |                    |                    |                    |                    |
|        | 180pF         | ±5%                | GRM31A5C3A181JW01# | 22pF               | ±5%                | GRM31A7U2J220JW31# |                    |                    |                    |        |                    |                    |                    |                    |                    |                    |
|        | 220pF         | ±5%                | GRM31A5C3A221JW01# | 27pF               | ±5%                | GRM31A7U2J270JW31# |                    |                    |                    |        |                    |                    |                    |                    |                    |                    |
|        | 270pF         | ±5%                | GRM31A5C3A271JWA1# | 33pF               | ±5%                | GRM31A7U2J330JW31# |                    |                    |                    |        |                    |                    |                    |                    |                    |                    |
|        | 330pF         | ±5%                | GRM31A5C3A331JWA1# | 39pF               | ±5%                | GRM31A7U2J390JW31# |                    |                    |                    |        |                    |                    |                    |                    |                    |                    |
|        | 390pF         | ±5%                | GRM31A5C3A391JWA1# | 47pF               | ±5%                | GRM31A7U2J470JW31# |                    |                    |                    |        |                    |                    |                    |                    |                    |                    |
| 470pF  | ±5%           | GRM31A5C3A471JWA1# | 56pF               | ±5%                | GRM31A7U2J560JW31# |                    |                    |                    |                    |        |                    |                    |                    |                    |                    |                    |

- GRM
- GR3
- GRJ
- GR4
- GR7
- GJM
- GQM
- GA2
- GA3 GB
- GA3 GD
- GA3 GF
- LLL
- LLA
- LLM
- LLR
- NFM
- KRM
- KR3
- GMA
- GMD
- ⚠Caution /Notice

Part number # indicates the package specification code.

# GRM Series Temperature Compensating Type Part Number List

(→ 3.2×1.6mm)

| T max. | Rated Voltage | TC Code            | Cap.               | Tol.               | Part Number        | T max. | Rated Voltage      | TC Code            | Cap.               | Tol.               | Part Number        |                    |                    |     |                    |
|--------|---------------|--------------------|--------------------|--------------------|--------------------|--------|--------------------|--------------------|--------------------|--------------------|--------------------|--------------------|--------------------|-----|--------------------|
| 1.0mm  | 630Vdc        | U2J                | 68pF               | ±5%                | GRM31A7U2J680JW31# | 1.0mm  | 500Vdc             | U2J                | 120pF              | ±5%                | GRM31A7U2H121JW31# |                    |                    |     |                    |
|        |               |                    | 82pF               | ±5%                | GRM31A7U2J820JW31# |        |                    |                    | 150pF              | ±5%                | GRM31A7U2H151JW31# |                    |                    |     |                    |
|        |               |                    | 100pF              | ±5%                | GRM31A7U2J101JW31# |        |                    |                    | 180pF              | ±5%                | GRM31A7U2H181JW31# |                    |                    |     |                    |
|        |               |                    | 120pF              | ±5%                | GRM31A7U2J121JW31# |        |                    |                    | 220pF              | ±5%                | GRM31A7U2H221JW31# |                    |                    |     |                    |
|        |               |                    | 150pF              | ±5%                | GRM31A7U2J151JW31# |        |                    |                    | 270pF              | ±5%                | GRM31A7U2H271JW31# |                    |                    |     |                    |
|        |               |                    | 180pF              | ±5%                | GRM31A7U2J181JW31# |        |                    |                    | 330pF              | ±5%                | GRM31A7U2H331JW31# |                    |                    |     |                    |
|        |               |                    | 220pF              | ±5%                | GRM31A7U2J221JW31# |        |                    |                    | 390pF              | ±5%                | GRM31A7U2H391JW31# |                    |                    |     |                    |
|        |               |                    | 270pF              | ±5%                | GRM31A7U2J271JW31# |        |                    |                    | 470pF              | ±5%                | GRM31A7U2H471JW31# |                    |                    |     |                    |
|        |               |                    | 330pF              | ±5%                | GRM31A7U2J331JW31# |        |                    |                    | 560pF              | ±5%                | GRM31A7U2H561JW31# |                    |                    |     |                    |
|        |               |                    | 390pF              | ±5%                | GRM31A7U2J391JW31# |        |                    |                    | 680pF              | ±5%                | GRM31A7U2H681JW31# |                    |                    |     |                    |
|        |               |                    | 470pF              | ±5%                | GRM31A7U2J471JW31# |        |                    |                    | 820pF              | ±5%                | GRM31A7U2H821JW31# |                    |                    |     |                    |
|        |               |                    | 560pF              | ±5%                | GRM31A7U2J561JW31# |        |                    |                    | 1000pF             | ±5%                | GRM31A7U2H102JW31# |                    |                    |     |                    |
|        |               |                    | 680pF              | ±5%                | GRM31A7U2J681JW31# |        |                    |                    | 1200pF             | ±5%                | GRM31A7U2H122JW31# |                    |                    |     |                    |
|        |               |                    | 820pF              | ±5%                | GRM31A7U2J821JW31# |        |                    |                    | 1500pF             | ±5%                | GRM31A7U2H152JW31# |                    |                    |     |                    |
|        |               |                    | 1000pF             | ±5%                | GRM31A7U2J102JW31# |        |                    |                    | 1800pF             | ±5%                | GRM31A7U2H182JW31# |                    |                    |     |                    |
|        |               |                    | 1200pF             | ±5%                | GRM31A7U2J122JW31# |        |                    |                    | 2200pF             | ±5%                | GRM31A7U2H222JW31# |                    |                    |     |                    |
|        |               |                    | 1500pF             | ±5%                | GRM31A7U2J152JW31# |        |                    |                    | 250Vdc             | COG                | 390pF              | ±5%                | GRM31A5C2E391JWA1# |     |                    |
|        |               |                    | 1800pF             | ±5%                | GRM31A7U2J182JW31# |        |                    |                    |                    |                    | 470pF              | ±5%                | GRM31A5C2E471JWA1# |     |                    |
|        |               |                    | 2200pF             | ±5%                | GRM31A7U2J222JW31# |        |                    |                    |                    |                    | 560pF              | ±5%                | GRM31A5C2E561JWA1# |     |                    |
|        |               |                    | 500Vdc             | COG                | 10pF               |        |                    |                    |                    |                    | ±5%                | GRM31A5C2H100JW01# | 680pF              | ±5% | GRM31A5C2E681JWA1# |
|        |               |                    |                    |                    | 12pF               |        |                    |                    |                    |                    | ±5%                | GRM31A5C2H120JW01# | 820pF              | ±5% | GRM31A5C2E821JWA1# |
|        |               |                    |                    |                    | 15pF               |        |                    |                    |                    |                    | ±5%                | GRM31A5C2H150JW01# | 1000pF             | ±5% | GRM31A5C2E102JWA1# |
|        |               |                    |                    |                    | 18pF               |        |                    |                    |                    |                    | ±5%                | GRM31A5C2H180JW01# | 1200pF             | ±5% | GRM31A5C2E122JWA1# |
|        |               |                    |                    |                    | 22pF               |        |                    |                    |                    |                    | ±5%                | GRM31A5C2H220JW01# | 1500pF             | ±5% | GRM31A5C2E152JWA1# |
|        | 27pF          | ±5%                |                    |                    | GRM31A5C2H270JW01# |        | 1800pF             | ±5%                |                    |                    | GRM31A5C2E182JWA1# |                    |                    |     |                    |
|        | 33pF          | ±5%                |                    |                    | GRM31A5C2H330JW01# |        | 2200pF             | ±5%                |                    |                    | GRM31A5C2E222JWA1# |                    |                    |     |                    |
|        | 39pF          | ±5%                |                    |                    | GRM31A5C2H390JW01# |        | 2700pF             | ±5%                |                    |                    | GRM31A5C2E272JWA1# |                    |                    |     |                    |
|        | 47pF          | ±5%                |                    |                    | GRM31A5C2H470JW01# |        | 3300pF             | ±5%                |                    |                    | GRM31A5C2E332JWA1# |                    |                    |     |                    |
|        | 56pF          | ±5%                |                    |                    | GRM31A5C2H560JW01# |        | 3900pF             | ±5%                | GRM31A5C2E392JWA1# |                    |                    |                    |                    |     |                    |
|        | 68pF          | ±5%                |                    |                    | GRM31A5C2H680JW01# |        | 4700pF             | ±5%                | GRM31A5C2E472JWA1# |                    |                    |                    |                    |     |                    |
|        | 82pF          | ±5%                |                    |                    | GRM31A5C2H820JW01# |        | 5600pF             | ±5%                | GRM31A5C2E562JWA1# |                    |                    |                    |                    |     |                    |
|        | 100pF         | ±5%                | GRM31A5C2H101JW01# | 6800pF             | ±5%                |        | GRM31A5C2E682JWA1# |                    |                    |                    |                    |                    |                    |     |                    |
|        | 120pF         | ±5%                | GRM31A5C2H121JW01# | U2J                | 2700pF             |        | ±5%                | GRM31A7U2E272JW31# |                    |                    |                    |                    |                    |     |                    |
|        | 150pF         | ±5%                | GRM31A5C2H151JW01# |                    | 3300pF             |        | ±5%                | GRM31A7U2E332JW31# |                    |                    |                    |                    |                    |     |                    |
|        | 180pF         | ±5%                | GRM31A5C2H181JW01# |                    | 3900pF             |        | ±5%                | GRM31A7U2E392JW31# |                    |                    |                    |                    |                    |     |                    |
|        | 220pF         | ±5%                | GRM31A5C2H221JW01# |                    | 4700pF             |        | ±5%                | GRM31A7U2E472JW31# |                    |                    |                    |                    |                    |     |                    |
| 270pF  | ±5%           | GRM31A5C2H271JW01# | 5600pF             |                    | ±5%                |        | GRM31A7U2E562JW31# |                    |                    |                    |                    |                    |                    |     |                    |
| 330pF  | ±5%           | GRM31A5C2H331JW01# | 200Vdc             |                    | U2J                |        | 2700pF             | ±5%                | GRM31A7U2D272JW31# |                    |                    |                    |                    |     |                    |
| 390pF  | ±5%           | GRM31A5C2H391JW01# |                    | 3300pF             |                    |        | ±5%                | GRM31A7U2D332JW31# |                    |                    |                    |                    |                    |     |                    |
| 470pF  | ±5%           | GRM31A5C2H471JW01# |                    | 3900pF             |                    |        | ±5%                | GRM31A7U2D392JW31# |                    |                    |                    |                    |                    |     |                    |
| 560pF  | ±5%           | GRM31A5C2H561JW01# |                    | 4700pF             |                    |        | ±5%                | GRM31A7U2D472JW31# |                    |                    |                    |                    |                    |     |                    |
| U2J    | U2J           | 10pF               |                    | ±5%                |                    |        | GRM31A7U2H100JW31# | 5600pF             | ±5%                | GRM31A7U2D562JW31# |                    |                    |                    |     |                    |
|        |               | 12pF               |                    | ±5%                |                    |        | GRM31A7U2H120JW31# | 1.25mm             | 1000Vdc            | COG                | 560pF              | ±5%                | GRM31B5C3A561JWA1# |     |                    |
|        |               | 15pF               | ±5%                | GRM31A7U2H150JW31# | 680pF              |        | ±5%                |                    |                    |                    | GRM31B5C3A681JWA1# |                    |                    |     |                    |
|        |               | 18pF               | ±5%                | GRM31A7U2H180JW31# | U2J                |        | 390pF              |                    |                    |                    | ±5%                | GRM31B7U3A391JW31# |                    |     |                    |
|        |               | 22pF               | ±5%                | GRM31A7U2H220JW31# |                    |        | 470pF              |                    |                    |                    | ±5%                | GRM31B7U3A471JW31# |                    |     |                    |
|        |               | 27pF               | ±5%                | GRM31A7U2H270JW31# |                    |        | 560pF              |                    |                    |                    | ±5%                | GRM31B7U3A561JW31# |                    |     |                    |
|        |               | 33pF               | ±5%                | GRM31A7U2H330JW31# |                    |        | 680pF              |                    |                    |                    | ±5%                | GRM31B7U3A681JW31# |                    |     |                    |
|        |               | 39pF               | ±5%                | GRM31A7U2H390JW31# |                    | 630Vdc | COG                | 680pF              | ±5%                | GRM31B5C2J681JW01# |                    |                    |                    |     |                    |
|        |               | 47pF               | ±5%                | GRM31A7U2H470JW31# |                    |        |                    | 820pF              | ±5%                | GRM31B5C2J821JW01# |                    |                    |                    |     |                    |
|        |               | 56pF               | ±5%                | GRM31A7U2H560JW31# | 1000pF             |        |                    | ±5%                | GRM31B5C2J102JW01# |                    |                    |                    |                    |     |                    |
|        |               | 68pF               | ±5%                | GRM31A7U2H680JW31# | 2200pF             |        |                    | ±5%                | GRM31B5C2J222JWA1# |                    |                    |                    |                    |     |                    |
|        |               | 82pF               | ±5%                | GRM31A7U2H820JW31# | 2700pF             |        |                    | ±5%                | GRM31B5C2J272JWA1# |                    |                    |                    |                    |     |                    |
| 100pF  | ±5%           | GRM31A7U2H101JW31# | U2J                | 2700pF             | ±5%                |        |                    | GRM31B7U2J272JW31# |                    |                    |                    |                    |                    |     |                    |

Part number # indicates the package specification code.



# GRM Series Temperature Compensating Type Part Number List

(→ 3.2×1.6mm)

| T max. | Rated Voltage | TC Code | Cap.               | Tol.               | Part Number        |                    |                    |  |
|--------|---------------|---------|--------------------|--------------------|--------------------|--------------------|--------------------|--|
| 1.25mm | 630Vdc        | U2J     | 3300pF             | ±5%                | GRM31B7U2J332JW31# |                    |                    |  |
|        |               | 500Vdc  | COG                | 680pF              | ±5%                | GRM31B5C2H681JW01# |                    |  |
|        | 820pF         |         |                    | ±5%                | GRM31B5C2H821JW01# |                    |                    |  |
|        | 1000pF        |         |                    | ±5%                | GRM31B5C2H102JW01# |                    |                    |  |
|        | U2J           |         | 2700pF             | ±5%                | GRM31B7U2H272JW31# |                    |                    |  |
|        | 250Vdc        | COG     | 8200pF             | ±5%                | GRM31B5C2E822JWA1# |                    |                    |  |
|        |               |         | 10000pF            | ±5%                | GRM31B5C2E103JWA1# |                    |                    |  |
|        |               |         | 12000pF            | ±5%                | GRM31B5C2E123JWA1# |                    |                    |  |
|        |               | U2J     | 6800pF             | ±5%                | GRM31B7U2E682JW31# |                    |                    |  |
|        |               |         | 8200pF             | ±5%                | GRM31B7U2E822JW31# |                    |                    |  |
|        |               |         | 10000pF            | ±5%                | GRM31B7U2E103JW31# |                    |                    |  |
|        |               | 12000pF | ±5%                | GRM31B7U2E123JW31# |                    |                    |                    |  |
|        |               |         | 200Vdc             | U2J                | 6800pF             | ±5%                | GRM31B7U2D682JW31# |  |
|        |               |         |                    |                    | 8200pF             | ±5%                | GRM31B7U2D822JW31# |  |
|        |               | 10000pF |                    |                    | ±5%                | GRM31B7U2D103JW31# |                    |  |
|        | 100Vdc        | COG     | 47000pF            | ±5%                | GRM31M5C2A473JA01# | <b>D1</b>          |                    |  |
|        |               |         | 56000pF            | ±5%                | GRM31M5C2A563JA01# | <b>D1</b>          |                    |  |
|        |               | CH      | 47000pF            | ±5%                | GRM31M2C2A473JA01# | <b>D1</b>          |                    |  |
|        |               |         | 56000pF            | ±5%                | GRM31M2C2A563JA01# | <b>D1</b>          |                    |  |
|        | 50Vdc         | COG     | 47000pF            | ±5%                | GRM31M5C1H473JA01# |                    |                    |  |
|        |               |         | 56000pF            | ±5%                | GRM31M5C1H563JA01# |                    |                    |  |
|        |               | CH      | 47000pF            | ±5%                | GRM31M2C1H473JA01# |                    |                    |  |
|        |               |         | 56000pF            | ±5%                | GRM31M2C1H563JA01# |                    |                    |  |
|        |               |         | SL                 | 68000pF            | ±5%                | GRM31M1X1H683JA01# |                    |  |
|        |               | 82000pF |                    | ±5%                | GRM31M1X1H823JA01# |                    |                    |  |
|        |               | 0.10µF  | ±5%                | GRM31M1X1H104JA01# |                    |                    |                    |  |
|        |               |         | U2J                | 68000pF            | ±5%                | GRM31M7U1H683JA01# |                    |  |
|        |               |         |                    | 82000pF            | ±5%                | GRM31M7U1H823JA01# |                    |  |
| 0.10µF |               | ±5%     |                    | GRM31M7U1H104JA01# |                    |                    |                    |  |
| UJ     |               | 68000pF | ±5%                | GRM31M3U1H683JA01# |                    |                    |                    |  |
|        |               | 82000pF | ±5%                | GRM31M3U1H823JA01# |                    |                    |                    |  |
|        |               | 0.10µF  | ±5%                | GRM31M3U1H104JA01# |                    |                    |                    |  |
| 1.8mm  |               | 1000Vdc | COG                | 820pF              | ±5%                | GRM31C5C3A821JWA3# |                    |  |
|        | 1000pF        |         |                    | ±5%                | GRM31C5C3A102JWA3# |                    |                    |  |
|        | U2J           |         | 820pF              | ±5%                | GRM31C7U3A821JW32# |                    |                    |  |
|        |               |         | 1000pF             | ±5%                | GRM31C7U3A102JW32# |                    |                    |  |
|        | 630Vdc        | COG     | 3300pF             | ±5%                | GRM31C5C2J332JWA3# |                    |                    |  |
|        |               |         | U2J                | 3900pF             | ±5%                | GRM31C7U2J392JW32# |                    |  |
|        | 4700pF        | ±5%     |                    | GRM31C7U2J472JW32# |                    |                    |                    |  |
|        | 500Vdc        | U2J     | 3900pF             | ±5%                | GRM31C7U2H392JW32# |                    |                    |  |
|        |               |         | 4700pF             | ±5%                | GRM31C7U2H472JW32# |                    |                    |  |
|        | 250Vdc        | COG     | 15000pF            | ±5%                | GRM31C5C2E153JWA3# |                    |                    |  |
|        |               |         | U2J                | 15000pF            | ±5%                | GRM31C7U2E153JW32# |                    |  |
|        |               |         |                    | 18000pF            | ±5%                | GRM31C7U2E183JW32# |                    |  |
|        | 22000pF       | ±5%     | GRM31C7U2E223JW32# |                    |                    |                    |                    |  |
|        | 100Vdc        | COG     | 68000pF            | ±5%                | GRM31C5C2A683JA01# | <b>D1</b>          |                    |  |
|        |               |         | 82000pF            | ±5%                | GRM31C5C2A823JA01# | <b>D1</b>          |                    |  |
|        |               |         | 0.10µF             | ±5%                | GRM31C5C2A104JA01# | <b>D1</b>          |                    |  |
|        |               | CH      | 68000pF            | ±5%                | GRM31C2C2A683JA01# | <b>D1</b>          |                    |  |
|        |               |         | 82000pF            | ±5%                | GRM31C2C2A823JA01# | <b>D1</b>          |                    |  |
|        |               |         | 0.10µF             | ±5%                | GRM31C2C2A104JA01# | <b>D1</b>          |                    |  |
|        | 50Vdc         | COG     | 68000pF            | ±5%                | GRM31C5C1H683JA01# |                    |                    |  |
|        |               |         | 82000pF            | ±5%                | GRM31C5C1H823JA01# |                    |                    |  |

| T max. | Rated Voltage | TC Code | Cap.   | Tol.               | Part Number        |                    |  |
|--------|---------------|---------|--------|--------------------|--------------------|--------------------|--|
| 1.8mm  | 50Vdc         | COG     | 0.10µF | ±5%                | GRM31C5C1H104JA01# |                    |  |
|        |               |         | CH     | 68000pF            | ±5%                | GRM31C2C1H683JA01# |  |
|        |               | 82000pF |        | ±5%                | GRM31C2C1H823JA01# |                    |  |
|        |               | 0.10µF  | ±5%    | GRM31C2C1H104JA01# |                    |                    |  |
|        | 25Vdc         | COG     | 0.12µF | ±5%                | GRM31C5C1E124JA01# |                    |  |
|        |               |         | CH     | 0.12µF             | ±5%                | GRM31C2C1E124JA01# |  |
|        | 16Vdc         | COG     | 0.12µF | ±5%                | GRM31C5C1C124JA01# |                    |  |
|        |               |         | CH     | 0.12µF             | ±5%                | GRM31C2C1C124JA01# |  |

## 3.2×2.5mm

| T max.  | Rated Voltage | TC Code | Cap.               | Tol.               | Part Number        |                    |                    |  |
|---------|---------------|---------|--------------------|--------------------|--------------------|--------------------|--------------------|--|
| 1.0mm   | 2000Vdc       | U2J     | 82pF               | ±5%                | GRM32A7U3D820JW31# |                    |                    |  |
|         |               |         | 100pF              | ±5%                | GRM32A7U3D101JW31# |                    |                    |  |
|         |               |         | 120pF              | ±5%                | GRM32A7U3D121JW31# |                    |                    |  |
|         |               |         | 150pF              | ±5%                | GRM32A7U3D151JW31# |                    |                    |  |
|         | 630Vdc        | U2J     | 1200pF             | ±5%                | GRM32A7U2J122JW31# |                    |                    |  |
|         |               |         | 1500pF             | ±5%                | GRM32A7U2J152JW31# |                    |                    |  |
|         |               |         | 1800pF             | ±5%                | GRM32A7U2J182JW31# |                    |                    |  |
|         |               |         | 2200pF             | ±5%                | GRM32A7U2J222JW31# |                    |                    |  |
|         |               |         | 500Vdc             | U2J                | 1200pF             | ±5%                | GRM32A7U2H122JW31# |  |
|         |               |         |                    |                    | 1500pF             | ±5%                | GRM32A7U2H152JW31# |  |
|         | 1800pF        | ±5%     | GRM32A7U2H182JW31# |                    |                    |                    |                    |  |
|         | 2200pF        | ±5%     | GRM32A7U2H222JW31# |                    |                    |                    |                    |  |
|         | 1.25mm        | 2000Vdc | U2J                | 180pF              | ±5%                | GRM32B7U3D181JW31# |                    |  |
|         |               |         |                    | 220pF              | ±5%                | GRM32B7U3D221JW31# |                    |  |
| 1000Vdc |               | U2J     | 1200pF             | ±5%                | GRM32B7U3A122JW31# |                    |                    |  |
|         |               |         | 630Vdc             | U2J                | 5600pF             | ±5%                | GRM32B7U2J562JW31# |  |
| 500Vdc  | U2J           | 5600pF  | ±5%                | GRM32B7U2H562JW31# |                    |                    |                    |  |
| 1.5mm   | 1000Vdc       | U2J     | 1500pF             | ±5%                | GRM32Q7U3A152JW31# |                    |                    |  |
|         | 630Vdc        | U2J     | 6800pF             | ±5%                | GRM32Q7U2J682JW31# |                    |                    |  |
|         | 500Vdc        | U2J     | 6800pF             | ±5%                | GRM32Q7U2H682JW31# |                    |                    |  |
|         | 250Vdc        | U2J     | 27000pF            | ±5%                | GRM32Q7U2E273JW31# |                    |                    |  |
|         |               |         | 2200pF             | ±5%                | GRM32D7U3A222JW31# |                    |                    |  |
| 2.0mm   | 1000Vdc       | U2J     | 1800pF             | ±5%                | GRM32D7U3A182JW31# |                    |                    |  |
|         |               |         | 2200pF             | ±5%                | GRM32D7U3A222JW31# |                    |                    |  |
|         | 630Vdc        | U2J     | 8200pF             | ±5%                | GRM32D7U2J822JW31# |                    |                    |  |
|         |               |         | 10000pF            | ±5%                | GRM32D7U2J103JW31# |                    |                    |  |
|         | 500Vdc        | U2J     | 8200pF             | ±5%                | GRM32D7U2H822JW31# |                    |                    |  |
|         |               |         | 10000pF            | ±5%                | GRM32D7U2H103JW31# |                    |                    |  |
|         | 250Vdc        | U2J     | 33000pF            | ±5%                | GRM32D7U2E333JW31# |                    |                    |  |
|         |               |         | 39000pF            | ±5%                | GRM32D7U2E393JW31# |                    |                    |  |
|         |               |         | 47000pF            | ±5%                | GRM32D7U2E473JW31# |                    |                    |  |

## 4.5×2.0mm

| T max. | Rated Voltage | TC Code | Cap. | Tol. | Part Number        |  |
|--------|---------------|---------|------|------|--------------------|--|
| 1.0mm  | 3150Vdc       | U2J     | 10pF | ±5%  | GRM42A7U3F100JW31# |  |
|        |               |         | 12pF | ±5%  | GRM42A7U3F120JW31# |  |
|        |               |         | 15pF | ±5%  | GRM42A7U3F150JW31# |  |
|        |               |         | 18pF | ±5%  | GRM42A7U3F180JW31# |  |
|        |               |         | 22pF | ±5%  | GRM42A7U3F220JW31# |  |
|        |               |         | 27pF | ±5%  | GRM42A7U3F270JW31# |  |

Part number # indicates the package specification code.

GRM  
 GR3  
 GRJ  
 GR4  
 GR7  
 GJM  
 GQM  
 GA2  
 GA3 GB  
 GA3 GD  
 GA3 GF  
 LLL  
 LLA  
 LLM  
 LLR  
 NFM  
 KRM  
 KR3  
 GMA  
 GMD  
 ⚠Caution /Notice

## GRM Series Temperature Compensating Type Part Number List

(→ 4.5×2.0mm)

| T max. | Rated Voltage | TC Code | Cap.  | Tol. | Part Number        |
|--------|---------------|---------|-------|------|--------------------|
| 1.0mm  | 3150Vdc       | U2J     | 33pF  | ±5%  | GRM42A7U3F330JW31# |
|        |               |         | 39pF  | ±5%  | GRM42A7U3F390JW31# |
|        |               |         | 47pF  | ±5%  | GRM42A7U3F470JW31# |
|        |               |         | 56pF  | ±5%  | GRM42A7U3F560JW31# |
|        |               |         | 68pF  | ±5%  | GRM42A7U3F680JW31# |
|        |               |         | 82pF  | ±5%  | GRM42A7U3F820JW31# |
|        |               |         | 100pF | ±5%  | GRM42A7U3F101JW31# |

4.5×3.2mm

| T max. | Rated Voltage | TC Code | Cap.    | Tol. | Part Number        |
|--------|---------------|---------|---------|------|--------------------|
| 1.5mm  | 1000Vdc       | U2J     | 2700pF  | ±5%  | GRM43Q7U3A272JW31# |
|        |               |         | 3300pF  | ±5%  | GRM43Q7U3A332JW31# |
|        | 630Vdc        | U2J     | 12000pF | ±5%  | GRM43Q7U2J123JW31# |
|        |               |         | 500Vdc  | U2J  | 12000pF            |
| 2.0mm  | 1000Vdc       | U2J     | 3900pF  | ±5%  | GRM43D7U3A392JW31# |
|        |               |         | 4700pF  | ±5%  | GRM43D7U3A472JW31# |
|        | 630Vdc        | U2J     | 15000pF | ±5%  | GRM43D7U2J153JW31# |
|        |               |         | 18000pF | ±5%  | GRM43D7U2J183JW31# |
|        |               |         | 22000pF | ±5%  | GRM43D7U2J223JW31# |
|        | 500Vdc        | U2J     | 15000pF | ±5%  | GRM43D7U2H153JW31# |
|        |               |         | 18000pF | ±5%  | GRM43D7U2H183JW31# |
|        |               |         | 22000pF | ±5%  | GRM43D7U2H223JW31# |

5.7×5.0mm

| T max. | Rated Voltage | TC Code | Cap.    | Tol. | Part Number        |
|--------|---------------|---------|---------|------|--------------------|
| 1.5mm  | 1000Vdc       | U2J     | 5600pF  | ±5%  | GRM55Q7U3A562JW31# |
|        |               |         | 6800pF  | ±5%  | GRM55Q7U3A682JW31# |
|        | 630Vdc        | U2J     | 27000pF | ±5%  | GRM55Q7U2J273JW31# |
|        |               |         | 500Vdc  | U2J  | 27000pF            |
| 2.0mm  | 1000Vdc       | U2J     | 8200pF  | ±5%  | GRM55D7U3A822JW31# |
|        |               |         | 10000pF | ±5%  | GRM55D7U3A103JW31# |
|        | 630Vdc        | U2J     | 33000pF | ±5%  | GRM55D7U2J333JW31# |
|        |               |         | 39000pF | ±5%  | GRM55D7U2J393JW31# |
|        |               |         | 47000pF | ±5%  | GRM55D7U2J473JW31# |
|        | 500Vdc        | U2J     | 33000pF | ±5%  | GRM55D7U2H333JW31# |
|        |               |         | 39000pF | ±5%  | GRM55D7U2H393JW31# |
|        |               |         | 47000pF | ±5%  | GRM55D7U2H473JW31# |

Part number # indicates the package specification code.



**GRM, GR3, GRJ, GR4, GR7, GJM,  
 GQM, GA2, GA3, LLL, LLA, LLM,  
 LLR, NFM, KRM, KR3, GMA, GMD**

**⚠️ Caution/Notice**

**WEB** 

**⚠️ Caution**

**Notice**

Storage and Operation Conditions ..... 266

Rating ..... 266

1. Temperature Dependent Characteristics ..... 266
2. Measurement of Capacitance ..... 266
3. Applied Voltage and Applied Current ..... 267
4. Type of Applied Voltage and Self-heating Temperature ..... 267
5. DC Voltage and AC Voltage Characteristics ..... 270
6. Capacitance Aging ..... 270
7. Vibration and Shock ..... 271

Soldering and Mounting ..... 271

1. Mounting Position ..... 271
2. Information before Mounting ..... 272
3. Maintenance of the Mounting (pick and place) Machine ..... 272
- 4-1. Reflow Soldering ..... 273
- 4-2. Flow Soldering ..... 275
- 4-3. Correction of Soldered Portion ..... 276
5. Washing ..... 277
6. Electrical Test on Printed Circuit Board ..... 277
7. Printed Circuit Board Cropping ..... 277
8. Assembly ..... 280
9. Die Bonding/Wire Bonding ..... 281

Other ..... 281

1. Under Operation of Equipment ..... 281
2. Other ..... 282

Rating ..... 283

1. Operating Temperature ..... 283
2. Atmosphere Surroundings (gaseous and liquid) ..... 283
3. Piezo-electric Phenomenon ..... 283

Soldering and Mounting ..... 283

1. PCB Design ..... 283
1. Notice for Pattern Forms ..... 283
2. Land Dimensions ..... 284
3. Board Design ..... 288
2. Adhesive Application ..... 288
3. Adhesive Curing ..... 289
4. Flux for Flow Soldering ..... 289
5. Flow Soldering ..... 289
6. Reflow Soldering ..... 289
7. Washing ..... 290
8. Coating ..... 290

Other ..... 290

1. Transportation ..... 290
2. Characteristics Evaluation in the Actual System ..... 290

- GRM
- GR3
- GRJ
- GR4
- GR7
- GJM
- GQM
- GA2
- GA3 GB
- GA3 GD
- GA3 GF
- LLL
- LLA
- LLM
- LLR
- NFM
- KRM
- KR3
- GMA
- GMD

⚠️ Caution / Notice



## ⚠Caution

### Storage and Operation Conditions

1. The performance of chip multilayer ceramic capacitors and chip EMIFIL NFM series (henceforth just “capacitors”) may be affected by the storage conditions.

Please use them promptly after delivery.

1-1. Maintain appropriate storage for the capacitors using the following conditions: Room Temperature of +5 to +40°C and a Relative Humidity of 20 to 70%.

High temperature and humidity conditions and/or prolonged storage may cause deterioration of the packaging materials. If more than six months have elapsed since delivery, check packaging, mounting, etc. before use.

In addition, this may cause oxidation of the electrodes. If more than one year has elapsed since delivery, also check the solderability before use.

1-2. Corrosive gas can react with the termination (external) electrodes or lead wires of capacitors, and result in poor solderability. Do not store the capacitors in an atmosphere consisting of corrosive gas (e.g., hydrogen sulfide, sulfur dioxide, chlorine, ammonia gas, etc.).

1-3. Due to moisture condensation caused by rapid humidity changes, or the photochemical change caused by direct sunlight on the terminal electrodes and/or the resin/epoxy coatings, the solderability and electrical performance may deteriorate. Do not store capacitors under direct sunlight or in high humidity conditions.

### Rating

#### 1. Temperature Dependent Characteristics

1. The electrical characteristics of a capacitor can change with temperature.

1-1. For capacitors having larger temperature dependency, the capacitance may change with temperature changes.

The following actions are recommended in order to ensure suitable capacitance values.

(1) Select a suitable capacitance for the operating temperature range.

(2) The capacitance may change within the rated temperature.

When you use a high dielectric constant type capacitor in a circuit that needs a tight (narrow) capacitance tolerance (e.g., a time-constant circuit), please carefully consider the temperature characteristics, and carefully confirm the various characteristics in actual use conditions and the actual system.

[Example of Temperature Characteristics X7R (R7)]

Sample: 0.1μF, Rated Voltage 50VDC

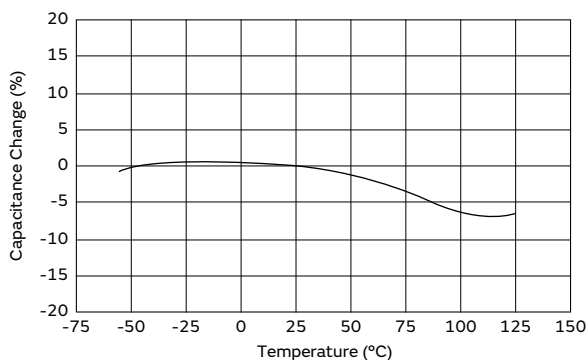

[Example of Temperature Characteristics X5R (R6)]

Sample: 22μF, Rated Voltage 4VDC

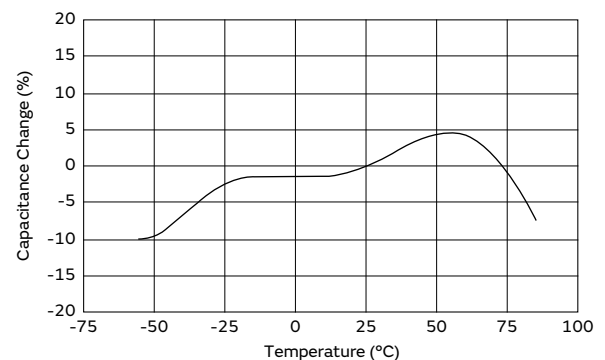

#### 2. Measurement of Capacitance

1. Measure capacitance with the voltage and frequency specified in the product specifications.

1-1. The output voltage of the measuring equipment may decrease occasionally when capacitance is high.

Please confirm whether a prescribed measured voltage is impressed to the capacitor.

1-2. The capacitance values of high dielectric constant type capacitors change depending on the AC voltage applied. Please consider the AC voltage characteristics when selecting a capacitor to be used in an AC circuit.

Continued on the following page. ↗

**Caution**

Continued from the preceding page. ↘

**3. Applied Voltage and Applied Current**

1. Do not apply a voltage to the capacitor that exceeds the rated voltage as called out in the specifications.
  - 1-1. Applied voltage between the terminals of a capacitor shall be less than or equal to the rated voltage.
    - (1) When AC voltage is superimposed on DC voltage, the zero-to-peak voltage shall not exceed the rated DC voltage.  
 When AC voltage or pulse voltage is applied, the peak-to-peak voltage shall not exceed the rated DC voltage.
    - (2) Abnormal voltages (surge voltage, static electricity, pulse voltage, etc.) shall not exceed the rated DC voltage.

**Typical Voltage Applied to the DC Capacitor**

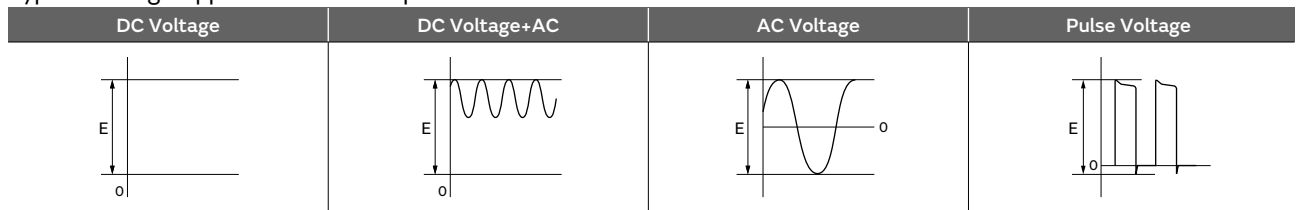

(E: Maximum possible applied voltage.)

- 1-2. Influence of over voltage  
 Over voltage that is applied to the capacitor may result in an electrical short circuit caused by the breakdown of the internal dielectric layers. The time duration until breakdown depends on the applied voltage and the ambient temperature.
2. Use a safety standard certified capacitor in a power supply input circuit (AC filter), as it is also necessary to consider the withstand voltage and impulse withstand voltage defined for each device.

**4. Type of Applied Voltage and Self-heating Temperature**

1. Confirm the operating conditions to make sure that no large current is flowing into the capacitor due to the continuous application of an AC voltage or pulse voltage.  
 When a DC rated voltage product is used in an AC voltage circuit or a pulse voltage circuit, the AC current or pulse current will flow into the capacitor; therefore check the self-heating condition.  
 Please confirm the surface temperature of the capacitor so that the temperature remains within the upper limits of the operating temperature, including the rise in temperature due to self-heating. When the capacitor is used with a high-frequency voltage or pulse voltage, heat may be generated by dielectric loss.  
**<Applicable to Rated Voltage of less than 100VDC>**
  - 1-1. The load should be contained so that the self-heating of the capacitor body remains below 20°C, when measuring at an ambient temperature of 25°C.

**<Applicable to NFM Series>**

3. The capacitors also have rated currents.  
 The current flowing between the terminals of a capacitor shall be less than or equal to the rated current. Using the capacitor beyond this range could lead to excessive heat.

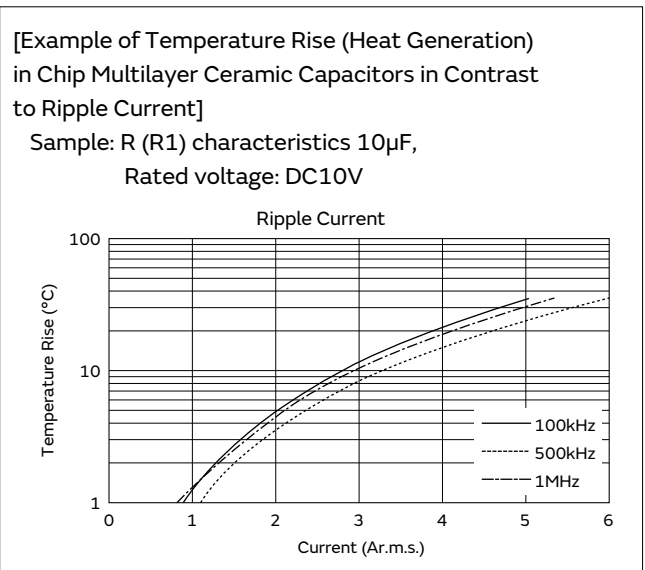

Continued on the following page. ↗

**⚠Caution**

Continued from the preceding page. ↘

**<Applicable to Temperature Characteristics X7R (R7), X7T (D7), X7T (W0) beyond Rated Voltage of 200VDC>**

1-2. The load should be contained so that the self-heating of the capacitor body remains below 20°C, when measuring at an ambient temperature of 25°C. In addition, use a K thermocouple of  $\phi 0.1\text{mm}$  with less heat capacity when measuring, and measure in a condition where there is no effect from the radiant heat of other components or air flow caused by convection. Excessive generation of heat may cause deterioration of the characteristics and reliability of the capacitor. (Absolutely do not perform measurements while the cooling fan is operating, as an accurate measurement may not be performed.)

**<Applicable to Temperature Characteristics U2J (7U), COG (5C) beyond Rated Voltage of 200VDC>**

1-3. Since the self-heating is low in the low loss series, the allowable power becomes extremely high compared to the common X7R (R7) characteristics. However, when a load with self-heating of 20°C is applied at the rated voltage, the allowable power may be exceeded. When the capacitor is used in a high-frequency voltage circuit of 1kHz or more, the frequency of the applied voltage should be less than 500kHz sine wave (less than 100kHz for a product with rated voltage of DC3.15kV), to limit the voltage load so that the load remains within the derating shown in the following figure. In the case of non-sine wave, high-frequency components exceeding the fundamental frequency may be included. In such a case, please contact Murata. The excessive generation of heat may cause deterioration of the characteristics and reliability of the capacitor. (Absolutely do not perform measurements while the cooling fan is operating, as an accurate measurement may not be performed.)

[The sine-wave frequency VS allowable voltage]

The surface temperature of the capacitor: 125°C or less (including self-heating)

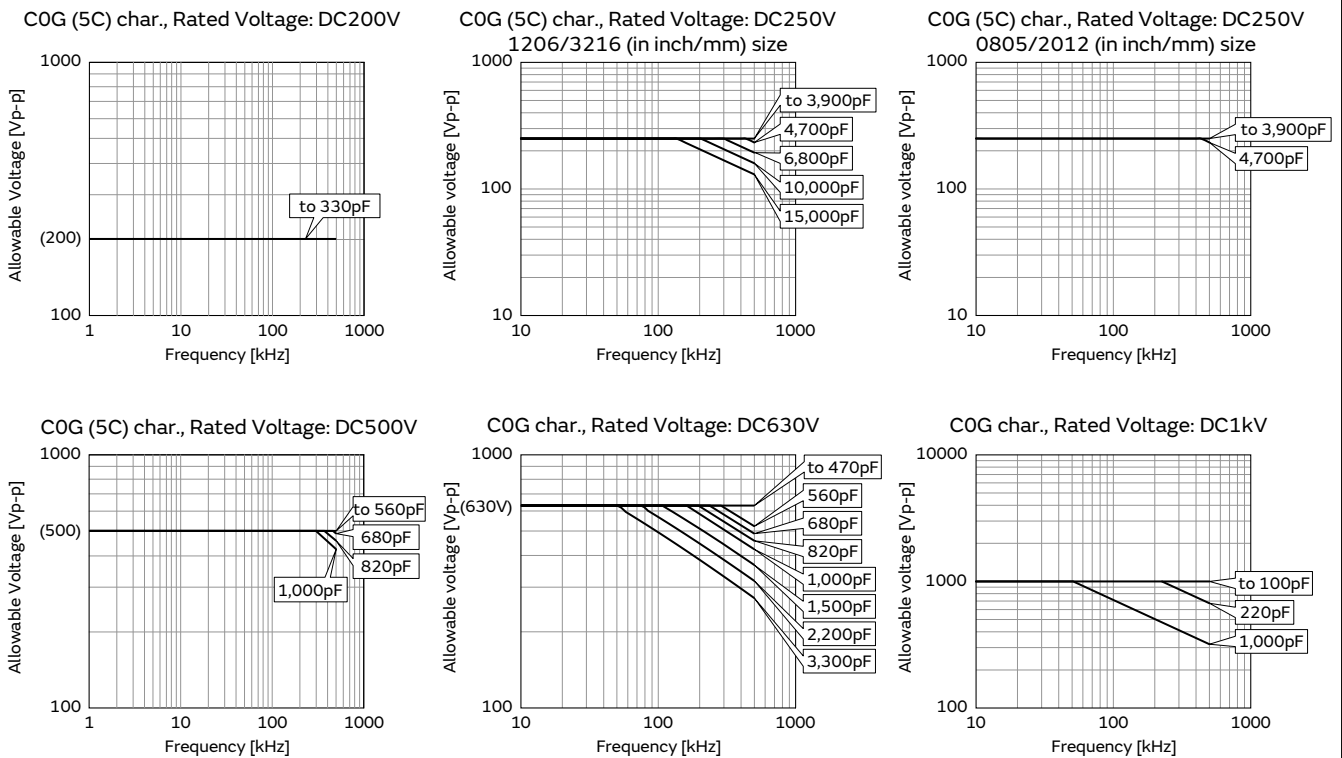

Continued on the following page. ↗

GRM

GR3

GRJ

GR4

GR7

GJM

GQM

GA2

GA3

GB

GA3

GD

GA3

GF

LLL

LLA

LLM

LLR

NFM

KRM

KR3

GMA

GMD

⚠Caution

**Caution**

Continued from the preceding page. ↘

[The sine-wave frequency VS allowable voltage]

The surface temperature of the capacitor: 125°C or less  
 (including self-heating)

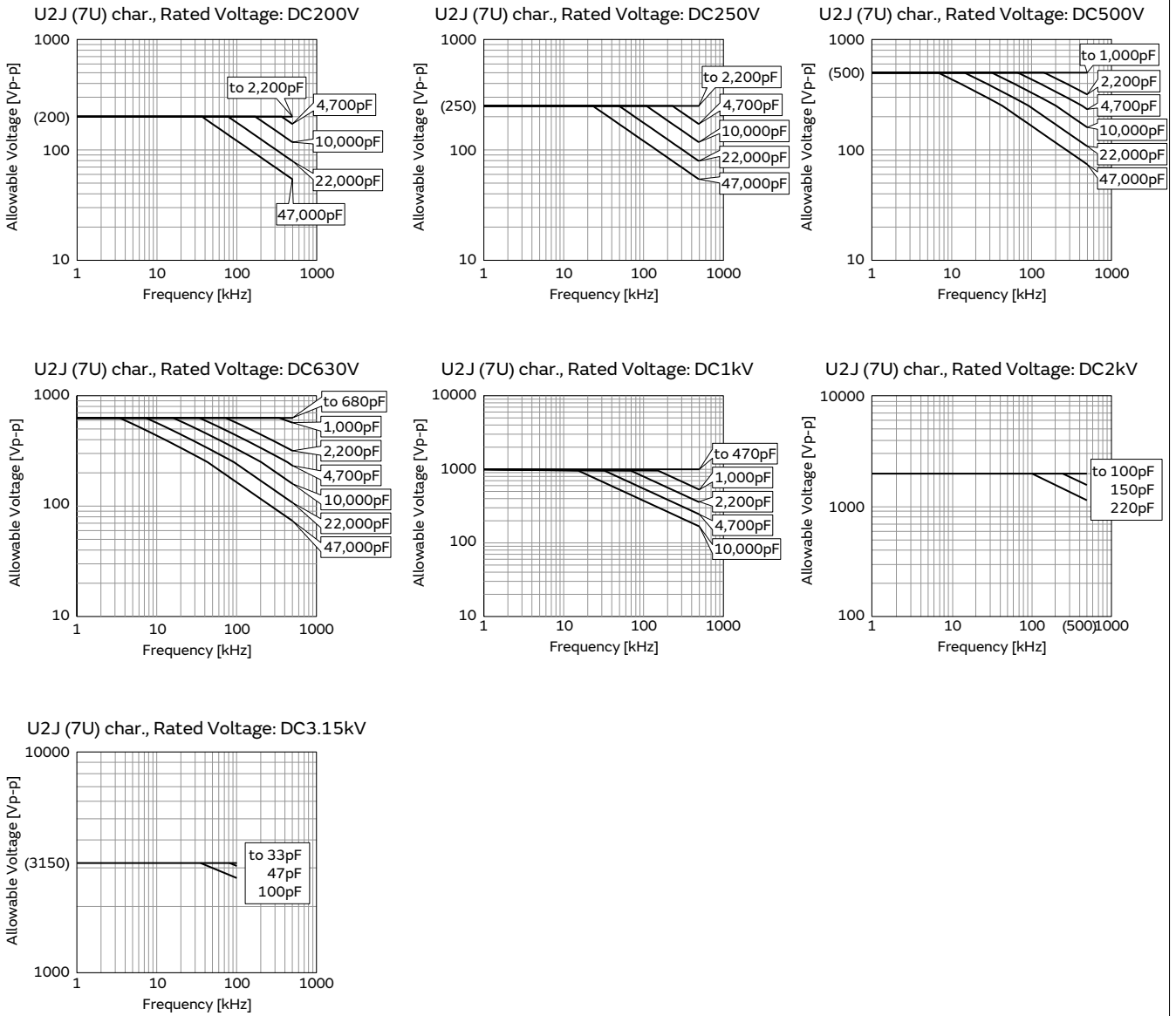

Continued on the following page. ↗

- GRM
- GR3
- GRJ
- GR4
- GR7
- GJM
- GQM
- GA2
- GA3 GB
- GA3 GD
- GA3 GF
- LLL
- LLA
- LLM
- LLR
- NFM
- KRM
- KR3
- GMA
- GMD

**Caution**

**⚠Caution**

Continued from the preceding page. ↘

**5. DC Voltage and AC Voltage Characteristics**

1. The capacitance value of a high dielectric constant type capacitor changes depending on the DC voltage applied. Please consider the DC voltage characteristics when a capacitor is selected for use in a DC circuit.

1-1. The capacitance of ceramic capacitors may change sharply depending on the applied voltage (see figure). Please confirm the following in order to secure the capacitance.

- (1) Determine whether the capacitance change caused by the applied voltage is within the allowed range.
- (2) In the DC voltage characteristics, the rate of capacitance change becomes larger as voltage increases, even if the applied voltage is below the rated voltage. When a high dielectric constant type capacitor is used in a circuit that requires a tight (narrow) capacitance tolerance (e.g., a time constant circuit), please carefully consider the voltage characteristics, and confirm the various characteristics in the actual operating conditions of the system.

2. The capacitance values of high dielectric constant type capacitors changes depending on the AC voltage applied. Please consider the AC voltage characteristics when selecting a capacitor to be used in an AC circuit.

**6. Capacitance Aging**

1. The high dielectric constant type capacitors have an Aging characteristic in which the capacitance value decreases with the passage of time. When you use high dielectric constant type capacitors in a circuit that needs a tight (narrow) capacitance tolerance (e.g., a time-constant circuit), please carefully consider the characteristics of these capacitors, such as their aging, voltage, and temperature characteristics. In addition, check capacitors using your actual appliances at the intended environment and operating conditions.

[Example of DC Voltage Characteristics]  
 Sample: X7R (R7) Characteristics 0.1μF,  
 Rated Voltage 50VDC

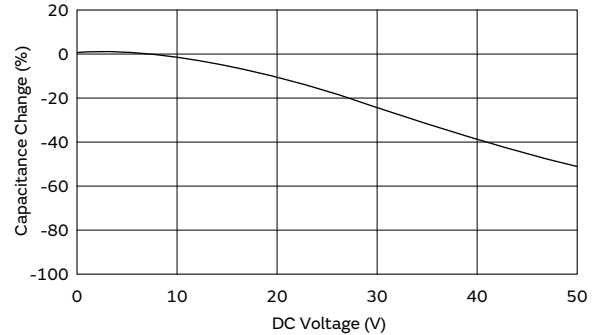

[Example of AC Voltage Characteristics]  
 Sample: X7R (R7) Characteristics 10μF,  
 Rated Voltage 6.3VDC

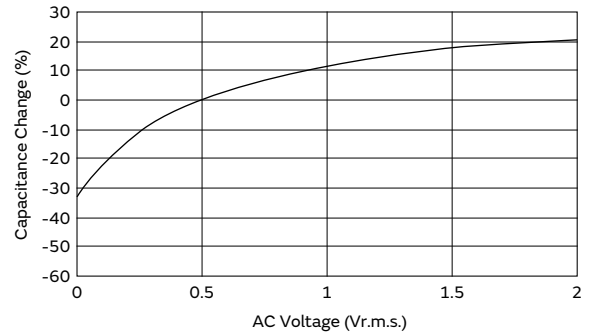

[Example of Change Over Time (Aging Characteristics)]

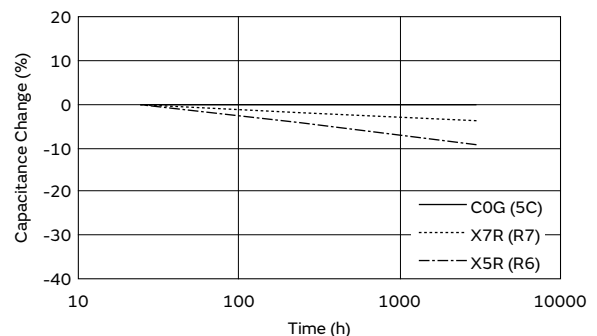

Continued on the following page. ↗

- GRM
- GR3
- GRJ
- GR4
- GR7
- GJM
- GQM
- GA2
- GA3 GB
- GA3 GD
- GA3 GF
- LLL
- LLA
- LLM
- LLR
- NFM
- KRM
- KR3
- GMA
- GMD
- ⚠Caution

**⚠Caution**

Continued from the preceding page. ↘

**7. Vibration and Shock**

1. Please confirm the kind of vibration and/or shock, its condition, and any generation of resonance.  
 Please mount the capacitor so as not to generate resonance, and do not allow any impact on the terminals.
2. Mechanical shock due to being dropped may cause damage or a crack in the dielectric material of the capacitor.  
 Do not use a dropped capacitor because the quality and reliability may be deteriorated.
3. When printed circuit boards are piled up or handled, the corner of another printed circuit board should not be allowed to hit the capacitor, in order to avoid a crack or other damage to the capacitor.

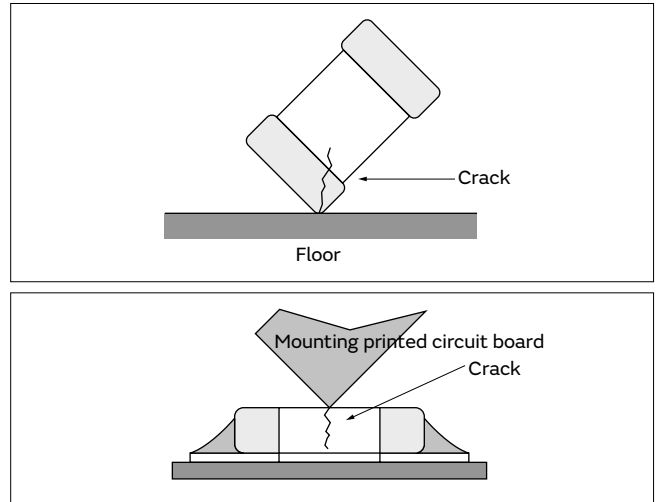

**Soldering and Mounting**

**1. Mounting Position**

1. Confirm the best mounting position and direction that minimizes the stress imposed on the capacitor during flexing or bending the printed circuit board.
  - 1-1. Choose a mounting position that minimizes the stress imposed on the chip during flexing or bending of the board.

**<Applicable to NFM Series>**

2. If you mount the capacitor near components that generate heat, take note of the heat from the other components and carefully check the self-heating of the capacitor before using.  
 If there is significant heat radiation from other components, it could lower the insulation resistance of the capacitor or produce excessive heat.

**[Component Direction]**

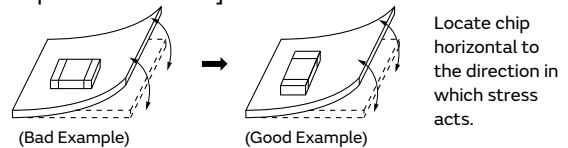

**[Chip Mounting Close to Board Separation Point]**

It is effective to implement the following measures, to reduce stress in separating the board.

It is best to implement all of the following three measures; however, implement as many measures as possible to reduce stress.

| Contents of Measures   | Stress Level |
|--|--------------|
| (1) Turn the mounting direction of the component parallel to the board separation surface. | A > D *1     |
| (2) Add slits in the board separation part.  | A > B        |
| (3) Keep the mounting position of the component away from the board separation surface.    | A > C        |

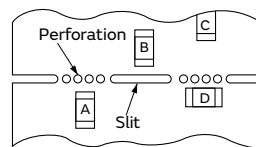

\*1 A > D is valid when stress is added vertically to the perforation as with Hand Separation.  
 If a Cutting Disc is used, stress will be diagonal to the PCB, therefore A > D is invalid.

**[Mounting Capacitors Near Screw Holes]**

When a capacitor is mounted near a screw hole, it may be affected by the board deflection that occurs during the tightening of the screw. Mount the capacitor in a position as far away from the screw holes as possible.

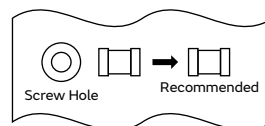

Continued on the following page. ↗

GRM  
 GR3  
 GRJ  
 GR4  
 GR7  
 GJM  
 GQM  
 GA2  
 GA3 GB  
 GA3 GD  
 GA3 GF  
 LLL  
 LLA  
 LLM  
 LLR  
 NFM  
 KPM  
 KR3  
 GMA  
 GMD  
 ⚠Caution

## ⚠Caution

Continued from the preceding page. ↘

### 2. Information before Mounting

1. Do not re-use capacitors that were removed from the equipment.
2. Confirm capacitance characteristics under actual applied voltage.
3. Confirm the mechanical stress under actual process and equipment use.
4. Confirm the rated capacitance, rated voltage and other electrical characteristics before assembly.
5. Prior to use, confirm the solderability of capacitors that were in long-term storage.
6. Prior to measuring capacitance, carry out a heat treatment for capacitors that were in long-term storage.
7. The use of Sn-Zn based solder will deteriorate the reliability of the MLCC.  
Please contact our sales representative or product engineers on the use of Sn-Zn based solder in advance.
8. We have also produced a DVD which shows a summary of our recommendations, regarding the precautions for mounting. Please contact our sales representative to request the DVD.

### 3. Maintenance of the Mounting (pick and place) Machine

1. Make sure that the following excessive forces are not applied to the capacitors. Check the mounting in the actual device under actual use conditions ahead of time.
  - 1-1. In mounting the capacitors on the printed circuit board, any bending force against them shall be kept to a minimum to prevent them from any damage or cracking. Please take into account the following precautions and recommendations for use in your process.
    - (1) Adjust the lowest position of the pickup nozzle so as not to bend the printed circuit board.
2. Dirt particles and dust accumulated in the suction nozzle and suction mechanism prevent the nozzle from moving smoothly. This creates excessive force on the capacitor during mounting, causing cracked chips. Also, the locating claw, when worn out, imposes uneven forces on the chip when positioning, causing cracked chips. The suction nozzle and the locating claw must be maintained, checked, and replaced periodically.

#### <Applicable to ZRB Series>

3. To adjust the inspection tolerance for automated appearance sorting machine of mounting position, because ZRB series are easier to shift the mounting position than standard MLCC.
4. To check the overturn and reverse of chip.
5. To control mounting speed carefully, because ZRB series is heavier than standard MLCC.

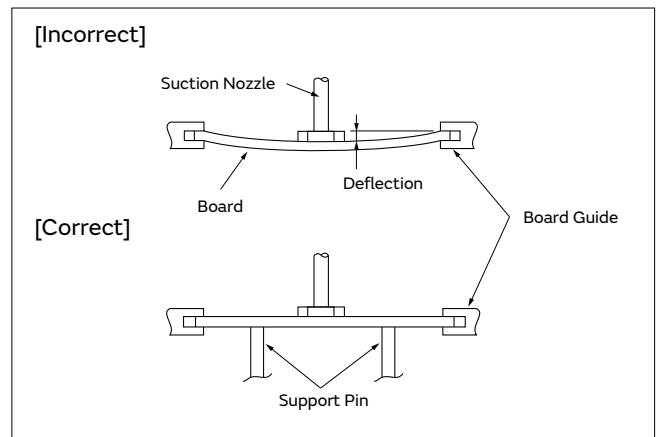

Continued on the following page. ↗

**⚠Caution**

Continued from the preceding page. ↘

**4-1. Reflow Soldering**

1. When sudden heat is applied to the components, the mechanical strength of the components will decrease because a sudden temperature change causes deformation inside the components. In order to prevent mechanical damage to the components, preheating is required for both the components and the PCB. Preheating conditions are shown in table 1. It is required to keep the temperature differential between the solder and the components surface ( $\Delta T$ ) as small as possible.
2. When components are immersed in solvent after mounting, be sure to maintain the temperature difference ( $\Delta T$ ) between the component and the solvent within the range shown in table 1.

**Table 1**

| Series                              | Chip Dimension Code (L/W) | Temperature Differential          |
|-------------------------------------|---------------------------|-----------------------------------|
| GRM/GJM/GQM/GR3/GRJ/KRM/LLR/NFM/GR7 | 02/03/15/18/21/31         | $\Delta T \leq 190^\circ\text{C}$ |
| LLL                                 | 02/03/15/18/1U/21/31      |                                   |
| ZRB                                 | 15/18                     |                                   |
| GR3/GRJ/GRM/KR3/KRM GA2/GA3/GR4     | 32/42/43/52/55            | $\Delta T \leq 130^\circ\text{C}$ |
| LLA/LLM                             | 18/21/31                  |                                   |
| GQM                                 | 22                        |                                   |

**Recommended Conditions**

|                  | Pb-Sn Solder | Lead Free Solder      |
|------------------|--------------|-----------------------|
| Peak Temperature | 230 to 250°C | 240 to 260°C          |
| Atmosphere       | Air          | Air or N <sub>2</sub> |

Pb-Sn Solder: Sn-37Pb  
 Lead Free Solder: Sn-3.0Ag-0.5Cu

3. When a capacitor is mounted at a temperature lower than the peak reflow temperature recommended by the solder manufacturer, the following quality problems can occur. Consider factors such as the placement of peripheral components and the reflow temperature setting to prevent the capacitor's reflow temperature from dropping below the peak temperature specified. Be sure to evaluate the mounting situation beforehand and verify that none of the following problems occur.
  - Drop in solder wettability
  - Solder voids
  - Possible occurrence of whiskering
  - Drop in bonding strength
  - Drop in self-alignment properties
  - Possible occurrence of tombstones and/or shifting on the land patterns of the circuit board

**[Example of Temperature Conditions for Reflow Soldering]**

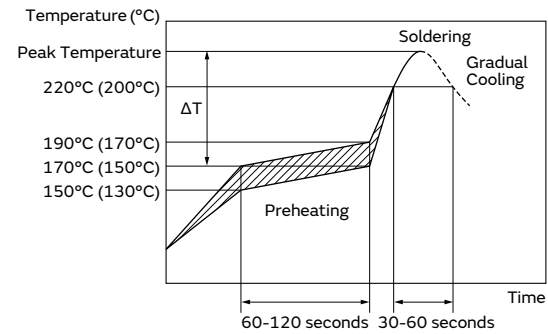

Temperature  
 Incase of Lead Free Solder  
 ( ): In case of Pb-Sn Solder

**[Allowable Reflow Soldering Temperature and Time]**

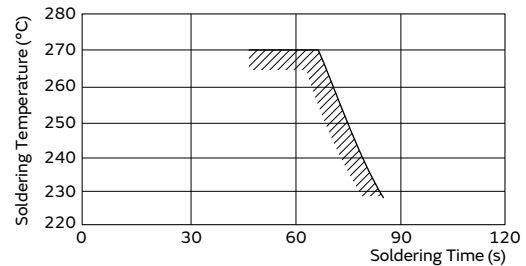

In the case of repeated soldering, the accumulated soldering time must be within the range shown above.

Continued on the following page. ↗

- GRM
- GR3
- GRJ
- GR4
- GR7
- GJM
- GQM
- GA2
- GA3 GB
- GA3 GD
- GA3 GF
- LLL
- LLA
- LLM
- LLR
- NFM
- KRM
- KR3
- GMA
- GMD



**Caution**

Continued from the preceding page. ↘

**4. Optimum Solder Amount for Reflow Soldering**

- 4-1. Overly thick application of solder paste results in a excessive solder fillet height.  
 This makes the chip more susceptible to mechanical and thermal stress on the board and may cause the chips to crack.
- 4-2. Too little solder paste results in a lack of adhesive strength on the termination, which may result in chips breaking loose from the PCB.
- 4-3. Please confirm that solder has been applied smoothly to the termination.

**<Applicable to NFM Series>**

[Guideline of solder paste thickness]  
 100-150 $\mu$ m: NFM15/18/21/3D/31  
 100-200 $\mu$ m: NFM41

NFM15CC/15PC

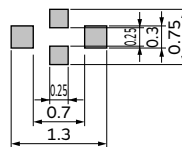

NFM18CC/18PC

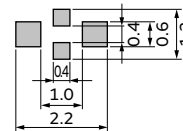

NFM18PS

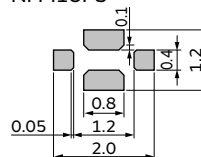

NFM21CC/21PC

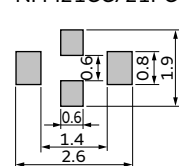

NFM21PS

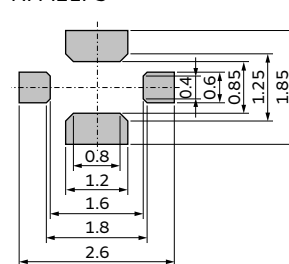

NFM3DCC/3DPC

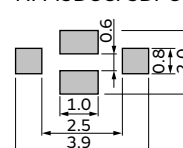

NFM31PC/31KC

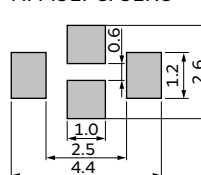

NFM41CC/41PC

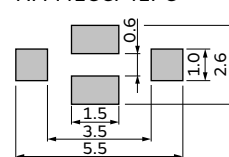

**Inverting the PCB**

Make sure not to impose any abnormal mechanical shocks to the PCB.

Continued on the following page. ↗

GRM

GR3

GRJ

GR4

GR7

GJM

GQM

GA2

GA3  
GB

GA3  
GD

GA3  
GF

LLL

LLA

LLM

LLR

NFM

KRM

KR3

GMA

GMD

Caution

**⚠Caution**

Continued from the preceding page. ↘

**4-2. Flow Soldering**

1. Do not apply flow soldering to chips not listed in table 2.

**Table 2**

| Series  | Chip Dimension Code (L/W) | Temperature Differential          |
|---------|---------------------------|-----------------------------------|
| GR3/GRM | 18/21/31                  | $\Delta T \leq 150^\circ\text{C}$ |
| GQM     | 18/21                     |                                   |
| LLL     | 21/31                     |                                   |
| GRJ     | 18/21/31                  |                                   |
| NFM     | 3D/31/41                  |                                   |

- When sudden heat is applied to the components, the mechanical strength of the components will decrease because a sudden temperature change causes deformation inside the components. In order to prevent mechanical damage to the components, preheating is required for both of the components and the PCB. Preheating conditions are shown in table 2. It is required to keep the temperature differential between the solder and the components surface ( $\Delta T$ ) as low as possible.
- Excessively long soldering time or high soldering temperature can result in leaching of the terminations, causing poor adhesion or a reduction in capacitance value due to loss of contact between the inner electrodes and terminations.
- When components are immersed in solvent after mounting, be sure to maintain the temperature differential ( $\Delta T$ ) between the component and solvent within the range shown in the table 2.

**Recommended Conditions**

|                             | Pb-Sn Solder | Lead Free Solder                   |
|-----------------------------|--------------|------------------------------------|
| Preheating Peak Temperature | 90 to 110°C  | 100 to 120°C<br>140 to 160°C (NFM) |
| Soldering Peak Temperature  | 240 to 250°C | 250 to 260°C                       |
| Atmosphere                  | Air          | Air or N <sub>2</sub>              |

Pb-Sn Solder: Sn-37Pb

Lead Free Solder: Sn-3.0Ag-0.5Cu

**5. Optimum Solder Amount for Flow Soldering**

- The top of the solder fillet should be lower than the thickness of the components. If the solder amount is excessive, the risk of cracking is higher during board bending or any other stressful condition.

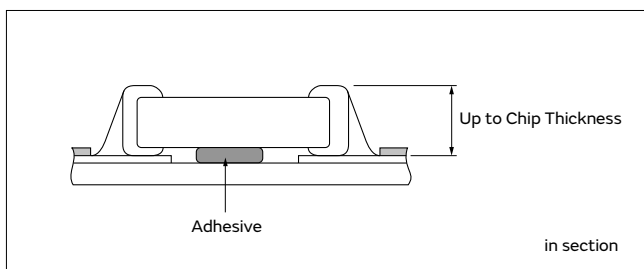

**[Example of Temperature Conditions for Flow Soldering]**

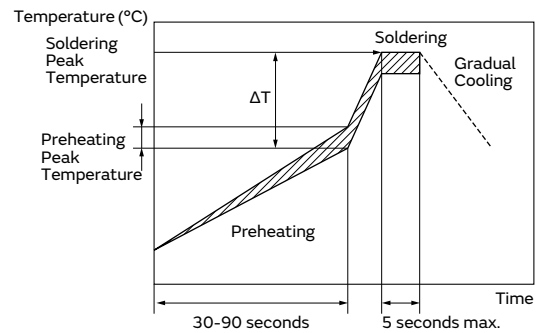

**[Allowable Flow Soldering Temperature and Time]**

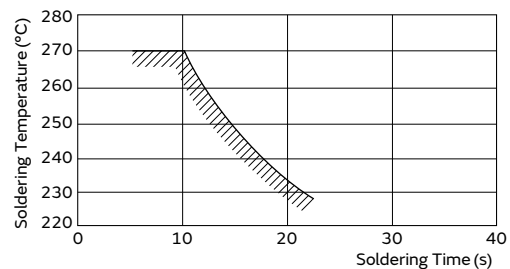

In the case of repeated soldering, the accumulated soldering time must be within the range shown above.

Continued on the following page. ↗

- GRM
- GR3
- GRJ
- GR4
- GR7
- GJM
- GQM
- GA2
- GA3 GB
- GA3 GD
- GA3 GF
- LLL
- LLA
- LLM
- LLR
- NFM
- KRM
- KR3
- GMA
- GMD
- ⚠Caution

GRM  
 GR3  
 GRJ  
 GR4  
 GR7  
 GJM  
 GQM  
 GA2  
 GA3 GB  
 GA3 GD  
 GA3 GF  
 LLL  
 LLA  
 LLM  
 LLR  
 NFM  
 KRM  
 KR3  
 GMA  
 GMD  
 ⚠Caution

## ⚠Caution

Continued from the preceding page. ↘

### 4-3. Correction of Soldered Portion

When sudden heat is applied to the capacitor, distortion caused by the large temperature difference occurs internally, and can be the cause of cracks. Capacitors also tend to be affected by mechanical and thermal stress depending on the board preheating temperature or the soldering fillet shape, and can be the cause of cracks. Please refer to "1. PCB Design" or "3. Optimum solder amount" for the solder amount and the fillet shapes.

Do not correct with a soldering iron for ZRB series.  
 Correction with a soldering iron for ZRB series may cause loss suppress acoustic noise, because the solder amount become excessive.

#### 1. Correction with a Soldering Iron

- 1-1. In order to reduce damage to the capacitor, be sure to preheat the capacitor and the mounting board. Preheat to the temperature range shown in Table 3. A hot plate, hot air type preheater, etc. can be used for preheating.
- 1-2. After soldering, do not allow the component/PCB to cool down rapidly.
- 1-3. Perform the corrections with a soldering iron as quickly as possible. If the soldering iron is applied too long, there is a possibility of causing solder leaching on the terminal electrodes, which will cause deterioration of the adhesive strength and other problems.

Table 3

| Series                  | Chip Dimension Code (L/W) | Temperature of Soldering Iron Tip | Preheating Temperature | Temperature Differential ( $\Delta T$ ) | Atmosphere |
|-------------------------|---------------------------|-----------------------------------|------------------------|---|------------|
| GJM/GQM/GR3/GRJ/GRM/GR7 | 03/15/18/21/31            | 350°C max.                        | 150°C min.             | $\Delta T \leq 190^\circ\text{C}$       | Air        |
| GRJ/GRM/GR4/GA2/GA3     | 32/42/43/52/55            | 280°C max.                        | 150°C min.             | $\Delta T \leq 130^\circ\text{C}$       | Air        |
| GQM                     | 22                        |                                   |                        |   |            |
| NFM                     | 3D/41                     | 350°C max.                        | 150°C min.             | $\Delta T \leq 190^\circ\text{C}$       | Air        |
|                         | 15                        | 340°C max.                        |                        |   |            |

\*Applicable for both Pb-Sn and Lead Free Solder.  
 Pb-Sn Solder: Sn-37Pb  
 Lead Free Solder: Sn-3.0Ag-0.5Cu  
 \*Please manage  $\Delta T$  in the temperature of soldering iron and the preheating temperature.

#### 2. Correction with Spot Heater

Compared to local heating with a soldering iron, hot air heating by a spot heater heats the overall component and board, therefore, it tends to lessen the thermal shock. In the case of a high density mounted board, a spot heater can also prevent concerns of the soldering iron making direct contact with the component.

2-1. If the distance from the hot air outlet of the spot heater to the component is too close, cracks may occur due to thermal shock. To prevent this problem, follow the conditions shown in Table 4.

2-2. In order to create an appropriate solder fillet shape, it is recommended that hot air be applied at the angle shown in Figure 1.

Table 4

|                                   |  |
|-----------------------------------|--|
| Distance                          | 5mm or more  |
| Hot Air Application Angle         | 45° *Figure 1  |
| Hot Air Temperature Nozzle Outlet | 400°C max.   |
| Application Time                  | Less than 10 seconds<br>(1206 (3216M) size or smaller) |
|                                   | Less than 30 seconds<br>(1210 (3225M) size or larger)  |

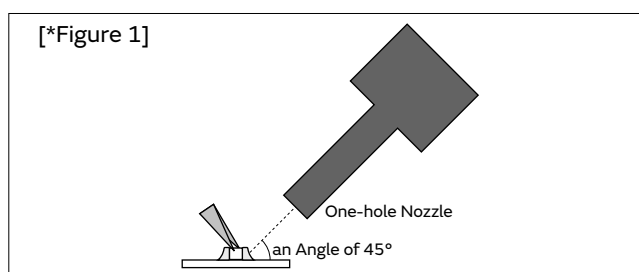

#### 3. Optimum solder amount when re-working with a soldering iron

3-1. If the solder amount is excessive, the risk of cracking is higher during board bending or any other stressful condition.

Too little solder amount results in a lack of adhesive strength on the termination, which may result in chips breaking loose from the PCB.

Please confirm that solder has been applied smoothly and rising to the end surface of the chip.

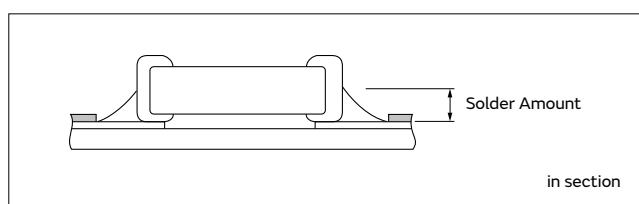

Continued on the following page. ↗

**⚠Caution**

Continued from the preceding page. ↘

- 3-2. A soldering iron with a tip of  $\phi 3\text{mm}$  or smaller should be used. It is also necessary to keep the soldering iron from touching the components during the re-work.
- 3-3. Solder wire with  $\phi 0.5\text{mm}$  or smaller is required for soldering.

**<Applicable to KR3/KRM Series>**

4. For the shape of the soldering iron tip, refer to the figure on the right.

Regarding the type of solder, use a wire diameter of  $\phi 0.5\text{mm}$  or less (rosin core wire solder).

**4-1. How to Apply the Soldering Iron**

Apply the tip of the soldering iron against the lower end of the metal terminal.

- 1) In order to prevent cracking caused by sudden heating of the ceramic device, do not touch the ceramic base directly.
- 2) In order to prevent deviations and dislocating of the chip, do not touch the junction of the chip and the metal terminal, and the metal portion on the outside directly.

**4-2. Appropriate Amount of Solder**

The amount of solder for corrections by soldering iron, should be lower than the height of the lower side of the chip.

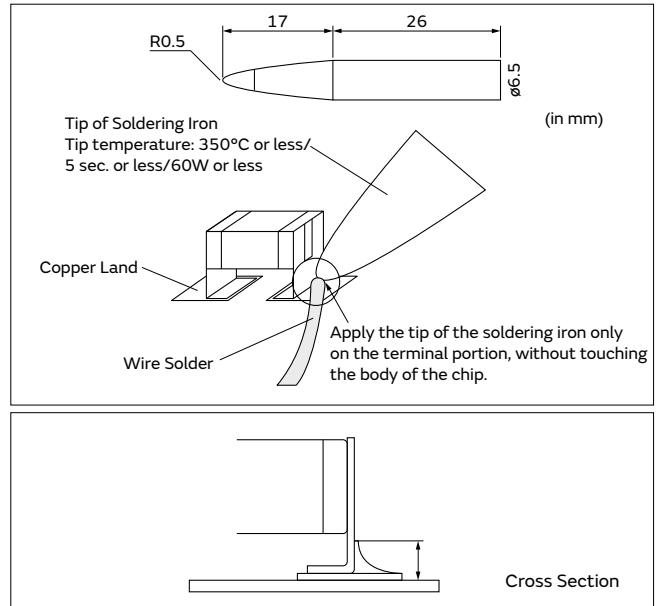

**5. Washing**

Excessive ultrasonic oscillation during cleaning can cause the PCBs to resonate, resulting in cracked chips or broken solder joints. Before starting your production process, test your cleaning equipment/process to insure it does not degrade the capacitors.

**6. Electrical Test on Printed Circuit Board**

1. Confirm position of the support pin or specific jig, when inspecting the electrical performance of a capacitor after mounting on the printed circuit board.

1-1. Avoid bending the printed circuit board by the pressure of a test-probe, etc.

The thrusting force of the test probe can flex the PCB, resulting in cracked chips or open solder joints. Provide support pins on the back side of the PCB to prevent warping or flexing. Install support pins as close to the test-probe as possible.

1-2. Avoid vibration of the board by shock when a test-probe contacts a printed circuit board.

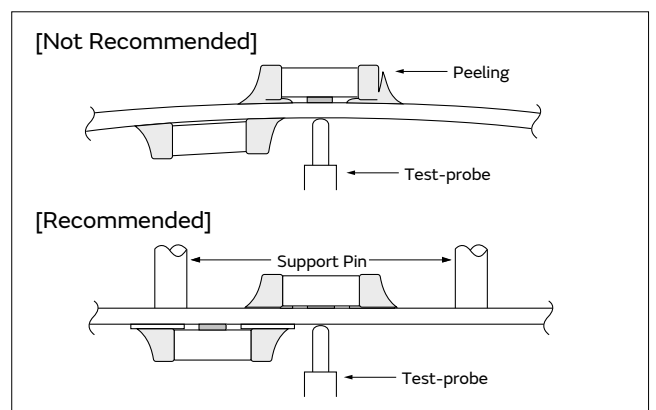

**7. Printed Circuit Board Cropping**

1. After mounting a capacitor on a printed circuit board, do not apply any stress to the capacitor that causes bending or twisting the board.

- 1-1. In cropping the board, the stress as shown at right may cause the capacitor to crack. Cracked capacitors may cause deterioration of the insulation resistance, and result in a short. Avoid this type of stress to a capacitor.

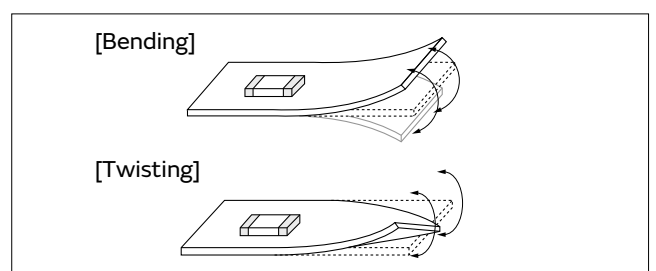

Continued on the following page. ↗

**Caution**

Continued from the preceding page. ↘

2. Check the cropping method for the printed circuit board in advance.

2-1. Printed circuit board cropping shall be carried out by using a jig or an apparatus (Disc separator, router type separator, etc.) to prevent the mechanical stress that can occur to the board.

| Board Separation Method  | Hand Separation<br>Nipper Separation   | (1) Board Separation Jig  | Board Separation Apparatus   |                           |
|--------------------------|--|---|--|---------------------------|
|                          |  |   | (2) Disc Separator   | (3) Router Type Separator |
| Level of stress on board | High   | Medium  | Medium   | Low                       |
| Recommended              | ×  | △*  | △*   | ○                         |
| Notes                    | Hand and nipper separation apply a high level of stress. Use another method. | <ul style="list-style-type: none"> <li>· Board handling</li> <li>· Board bending direction</li> <li>· Layout of capacitors</li> </ul> | <ul style="list-style-type: none"> <li>· Board handling</li> <li>· Layout of slits</li> <li>· Design of V groove</li> <li>· Arrangement of blades</li> <li>· Controlling blade life</li> </ul> | Board handling            |

\* When a board separation jig or disc separator is used, if the following precautions are not observed, a large board deflection stress will occur and the capacitors may crack. Use router type separator if at all possible.

(1) Example of a suitable jig

[In the case of Single-side Mounting]

An outline of the board separation jig is shown as follows. Recommended example: Stress on the component mounting position can be minimized by holding the portion close to the jig, and bend in the direction towards the side where the capacitors are mounted. Not recommended example: The risk of cracks occurring in the capacitors increases due to large stress being applied to the component mounting position, if the portion away from the jig is held and bent in the direction opposite the side where the capacitors are mounted.

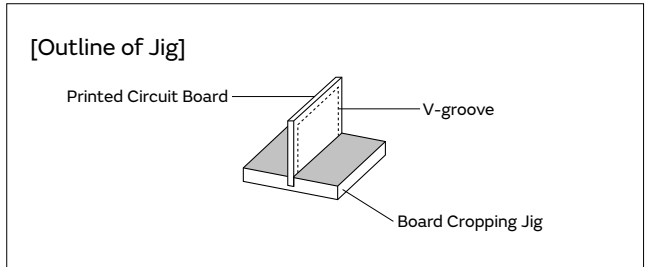

**Hand Separation**

| Recommended | Not Recommended |
|-------------|-----------------|
|             |                 |

[In the case of Double-sided Mounting]

Since components are mounted on both sides of the board, the risk of cracks occurring can not be avoided with the above method. Therefore, implement the following measures to prevent stress from being applied to the components.

(Measures)

- (1) Consider introducing a router type separator. If it is difficult to introduce a router type separator, implement the following measures. (Refer to item 1. Mounting Position)
- (2) Mount the components parallel to the board separation surface.
- (3) When mounting components near the board separation point, add slits in the separation position near the component.
- (4) Keep the mounting position of the components away from the board separation point.

Continued on the following page. ↗

GRM  
GR3  
GRJ  
GR4  
GR7  
GJM  
GQM  
GA2  
GA3 GB  
GA3 GD  
GA3 GF  
LLL  
LLA  
LLM  
LLR  
NFM  
KRM  
KR3  
GMA  
GMD  
Caution

**⚠Caution**

Continued from the preceding page. ↘

**(2) Example of a Disc Separator**

An outline of a disc separator is shown as follows. As shown in the Principle of Operation, the top blade and bottom blade are aligned with the V-grooves on the printed circuit board to separate the board.

In the following case, board deflection stress will be applied and cause cracks in the capacitors.

- (1) When the adjustment of the top and bottom blades are misaligned, such as deviating in the top-bottom, left-right or front-rear directions
- (2) The angle of the V groove is too low, depth of the V groove is too shallow, or the V groove is misaligned top-bottom

IF V groove is too deep, it is possible to brake when you handle and carry it. Carefully design depth of the V groove with consideration about strength of material of the printed circuit board.

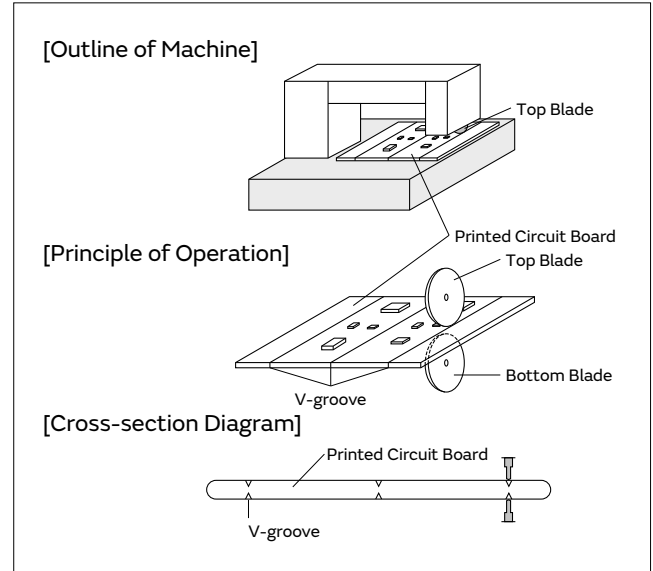

**Disc Separator**

| Recommended                          | Not Recommended                      |                                      |                                      |
|--------------------------------------|--------------------------------------|--------------------------------------|--------------------------------------|
|                                      | Top-bottom Misalignment              | Left-right Misalignment              | Front-rear Misalignment              |
| <p>Top Blade</p> <p>Bottom Blade</p> | <p>Top Blade</p> <p>Bottom Blade</p> | <p>Top Blade</p> <p>Bottom Blade</p> | <p>Top Blade</p> <p>Bottom Blade</p> |

**V-groove Design**

| Example of Recommended V-groove Design | Not Recommended         |           |                   |                |
|--|-------------------------|-----------|-------------------|----------------|
|  | Left-right Misalignment | Low-Angle | Depth too Shallow | Depth too Deep |
|  |                         |           |                   |                |

**(3) Example of Router Type Separator**

The router type separator performs cutting by a router rotating at a high speed. Since the board does not bend in the cutting process, stress on the board can be suppressed during board separation.

When attaching or removing boards to/from the router type separator, carefully handle the boards to prevent bending.

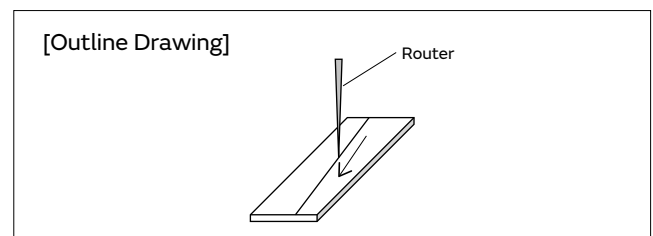

Continued on the following page. ↗

GRM  
 GR3  
 GRJ  
 GR4  
 GR7  
 GJM  
 GQM  
 GA2  
 GA3 GB  
 GA3 GD  
 GA3 GF  
 LLL  
 LLA  
 LLM  
 LLR  
 NFM  
 KRM  
 KR3  
 GMA  
 GMD  
 ⚠Caution

GRM  
GR3  
GRJ  
GR4  
GR7  
GJM  
GQM  
GA2  
GA3 GB  
GA3 GD  
GA3 GF  
LLL  
LLA  
LLM  
LLR  
NFM  
KRM  
KR3  
GMA  
GMD  
Caution

## ⚠Caution

Continued from the preceding page. ↘

### 8. Assembly

#### 1. Handling

If a board mounted with capacitors is held with one hand, the board may bend. Firmly hold the edges of the board with both hands when handling.

If a board mounted with capacitors is dropped, cracks may occur in the capacitors.

Do not use dropped boards, as there is a possibility that the quality of the capacitors may be impaired.

#### 2. Attachment of Other Components

##### 2-1. Mounting of Other Components

Pay attention to the following items, when mounting other components on the back side of the board after capacitors have been mounted on the opposite side.

When the bottom dead point of the suction nozzle is set too low, board deflection stress may be applied to the capacitors on the back side (bottom side), and cracks may occur in the capacitors.

- After the board is straightened, set the bottom dead point of the nozzle on the upper surface of the board.
- Periodically check and adjust the bottom dead point.

##### 2-2. Inserting Components with Leads into Boards

When inserting components (transformers, IC, etc.) into boards, bending the board may cause cracks in the capacitors or cracks in the solder.

Pay attention to the following.

- Increase the size of the holes to insert the leads, to reduce the stress on the board during insertion.
- Fix the board with support pins or a dedicated jig before insertion.
- Support below the board so that the board does not bend. When using support pins on the board, periodically confirm that there is no difference in the height of each support pin.

##### 2-3. Attaching/Removing Sockets and/or Connectors

Insertion and removal of sockets and connectors, etc., might cause the board to bend. Please insure that the board does not warp during insertion and removal of sockets and connectors, etc., or the bending may damage mounted components on the board.

##### 2-4. Tightening Screws

The board may be bent, when tightening screws, etc. during the attachment of the board to a shield or chassis.

Pay attention to the following items before performing the work.

- Plan the work to prevent the board from bending.
- Use a torque screwdriver, to prevent over-tightening of the screws.
- The board may bend after mounting by reflow soldering, etc. Please note, as stress may be applied to the chips by forcibly flattening the board when tightening the screws.

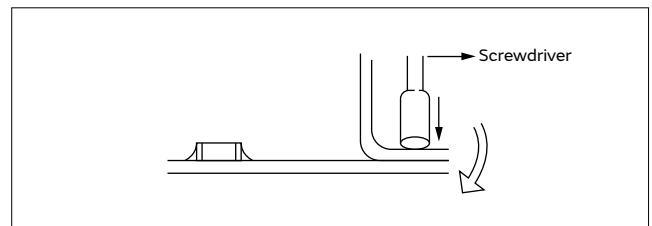
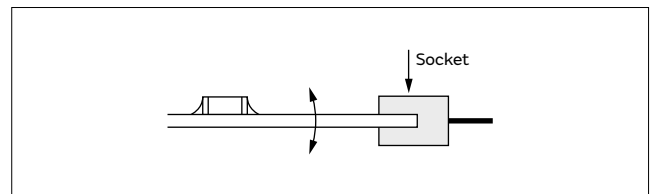
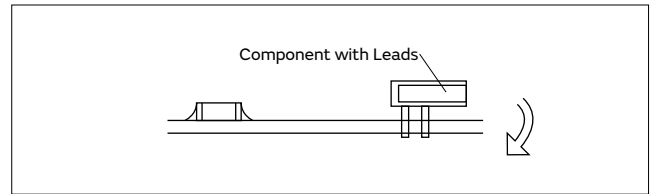
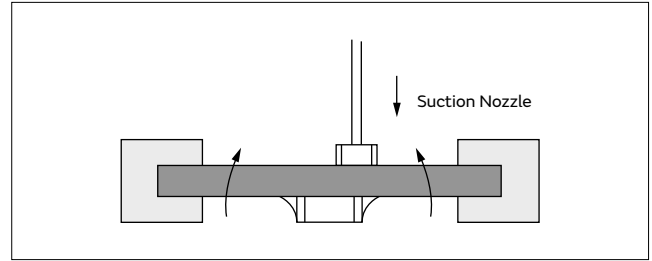

## ⚠Caution

Continued from the preceding page. ↘

<Applicable to GMA or GMD Series>

### 9. Die Bonding/Wire Bonding

#### 1. Die Bonding of Capacitors

1-1. Use the following materials for the Brazing alloys:

Au-Sn (80/20) 300 to 320 °C in N<sub>2</sub> atmosphere

1-2. Mounting

- (1) Control the temperature of the substrate so it matches the temperature of the brazing alloy.
- (2) Place the brazing alloy on the substrate and place the capacitor on the alloy. Hold the capacitor and gently apply the load. Be sure to complete the operation within 1 minute.

#### 2. Wire Bonding

2-1. Wire

Gold wire: 25 micro m (0.001 inch) diameter

2-2. Bonding

- (1) Thermo compression, ultrasonic ball bonding.
- (2) Required stage temperature: 150 to 200 °C
- (3) Required wedge or capillary weight: 0.2N to 0.5N
- (4) Bond the capacitor and base substrate or other devices with gold wire.

## Other

### 1. Under Operation of Equipment

- 1-1. Do not touch a capacitor directly with bare hands during operation in order to avoid the danger of an electric shock.
- 1-2. Do not allow the terminals of a capacitor to come in contact with any conductive objects (short-circuit). Do not expose a capacitor to a conductive liquid, including any acid or alkali solutions.
- 1-3. Confirm the environment in which the equipment will operate is under the specified conditions. Do not use the equipment under the following environments.
  - (1) Being splattered with water or oil.
  - (2) Being exposed to direct sunlight.
  - (3) Being exposed to ozone, ultraviolet rays, or radiation.
  - (4) Being exposed to toxic gas (e.g., hydrogen sulfide, sulfur dioxide, chlorine, ammonia gas, etc.)
  - (5) Any vibrations or mechanical shocks exceeding the specified limits.
  - (6) Moisture condensing environments.
- 1-4. Use damp proof countermeasures if using under any conditions that can cause condensation.

Continued on the following page. ↗

GRM

GR3

GRJ

GR4

GR7

GJM

GQM

GA2

GA3  
GB

GA3  
GD

GA3  
GF

LLL

LLA

LLM

LLR

NFM

KRM

KR3

GMA

GMD

⚠Caution

281



## ⚠Caution

Continued from the preceding page. ↘

### 2. Other

#### 2-1. In an Emergency

- (1) If the equipment should generate smoke, fire, or smell, immediately turn off or unplug the equipment.  
If the equipment is not turned off or unplugged, the hazards may be worsened by supplying continuous power.
- (2) In this type of situation, do not allow face and hands to come in contact with the capacitor or burns may be caused by the capacitor's high temperature.

#### 2-2. Disposal of Waste

When capacitors are disposed of, they must be burned or buried by an industrial waste vendor with the appropriate licenses.

#### 2-3. Circuit Design

##### (1) Addition of Fail Safe Function

Capacitors that are cracked by dropping or bending of the board may cause deterioration of the insulation resistance, and result in a short.  
If the circuit being used may cause an electrical shock, smoke or fire when a capacitor is shorted, be sure to install fail-safe functions, such as a fuse, to prevent secondary accidents.

- (2) Capacitors used to prevent electromagnetic interference in the primary AC side circuit, or as a connection/insulation, must be a safety standard certified product, or satisfy the contents stipulated in the Electrical Appliance and Material Safety Law. Install a fuse for each line in case of a short.
- (3) The GJM, GMA, GMD, GQM, GR3, GRJ, GRM, KR3, KRM, LLA, LLL, LLM, LLR, NFM and ZRB series are not safety standard certified products.

#### 2-4. Test Condition for AC Withstanding Voltage

##### (1) Test Equipment

Test equipment for AC withstanding voltage should be made with equipment capable of creating a wave similar to a 50/60Hz sine wave.

##### (2) Voltage Applied Method

The capacitor's lead or terminal should be firmly connected to the output of the withstanding voltage test equipment, and then the voltage should be raised from near zero to the test voltage.

If the test voltage is applied directly to the capacitor without raising it from near zero, it should be applied with the zero cross. \*At the end of the test time, the test voltage should be reduced to near zero, and then capacitor's lead or terminals should be taken off the output of the withstanding voltage test equipment.

If the test voltage applied directly to the capacitor without raising it from near zero, surge voltage may occur and cause a defect.

\*ZERO CROSS is the point where voltage sine wave passes 0V. - See the figure at right -

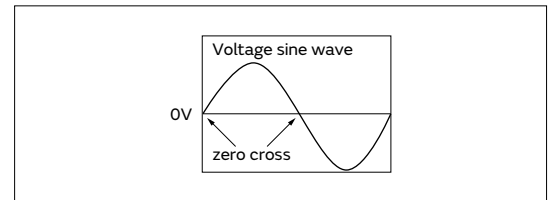

#### 2-5. Remarks

Failure to follow the cautions may result, worst case, in a short circuit and smoking when the product is used.

The above notices are for standard applications and conditions. Contact us when the products are used in special mounting conditions.

Select optimum conditions for operation as they determine the reliability of the product after assembly.

The data herein are given in typical values, not guaranteed ratings.

GRM

GR3

GRJ

GR4

GR7

GJM

GQM

GA2

GA3

GB

GA3

GD

GA3

GF

LLL

LLA

LLM

LLR

NFM

KRM

KR3

GMA

GMD

⚠Caution

## Notice

### Rating

#### 1. Operating Temperature

1. The operating temperature limit depends on the capacitor.

1-1. Do not apply temperatures exceeding the maximum operating temperature.

It is necessary to select a capacitor with a suitable rated temperature that will cover the operating temperature range.

It is also necessary to consider the temperature distribution in equipment and the seasonal temperature variable factor.

1-2. Consider the self-heating factor of the capacitor.

The surface temperature of the capacitor shall not exceed the maximum operating temperature including self-heating.

#### 2. Atmosphere Surroundings (gaseous and liquid)

1. Restriction on the operating environment of capacitors.

1-1. Capacitors, when used in the above, unsuitable, operating environments may deteriorate due to the corrosion of the terminations and the penetration of moisture into the capacitor.

1-2. The same phenomenon as the above may occur when the electrodes or terminals of the capacitor are subject to moisture condensation.

1-3. The deterioration of characteristics and insulation resistance due to the oxidization or corrosion of terminal electrodes may result in breakdown when the capacitor is exposed to corrosive or volatile gases or solvents for long periods of time.

#### 3. Piezo-electric Phenomenon

1. When using high dielectric constant type capacitors in AC or pulse circuits, the capacitor itself vibrates at specific frequencies and noise may be generated.

Moreover, when the mechanical vibration or shock is added to the capacitor, noise may occur.

### Soldering and Mounting

#### 1. PCB Design

1. Notice for Pattern Forms

1-1. Unlike leaded components, chip components are susceptible to flexing stresses since they are mounted directly on the substrate. They are also more sensitive to mechanical and thermal stresses than leaded components. Excess solder fillet height can multiply these stresses and cause chip cracking. When designing substrates, take land patterns and dimensions into consideration to eliminate the possibility of excess solder fillet height.

1-2. There is a possibility of chip cracking caused by PCB expansion/contraction with heat, because stress on a chip is different depending on PCB material and structure. When the thermal expansion coefficient greatly differs between the board used for mounting and the chip, it will cause cracking of the chip due to the thermal expansion and contraction.

When capacitors are mounted on a fluorine resin printed circuit board or on a single-layered glass epoxy board, it may also cause cracking of the chip for the same reason.

#### <Applicable to NFM Series>



1-3. Because noise is suppressed by shunting unwanted high-frequency components to the ground, when designing a land for the NFM series, design the ground pattern to be as large as possible in order to better bring out this characteristic. As shown in the figure below, noise countermeasures can be made more effective by using a via to connect the ground pattern on the chip mounting surface to a larger ground pattern on the inner layer.

Continued on the following page. ↗

## Notice

Continued from the preceding page. ↘

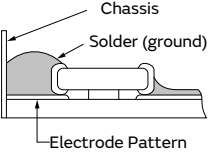
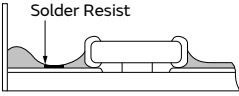
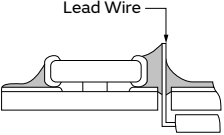
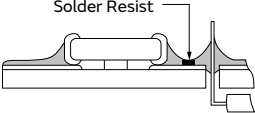
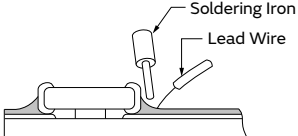
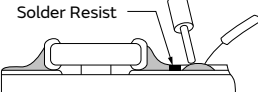
### Pattern Forms

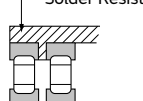
|   | Prohibited   | Correct  |
|---|--|--|
| Placing Close to Chassis                          |  <p style="text-align: right;">in section</p> |  <p style="text-align: right;">in section</p> |
| Placing of Chip Components and Leaded Components  |  <p style="text-align: right;">in section</p> |  <p style="text-align: right;">in section</p> |
| Placing of Leaded Components after Chip Component |  <p style="text-align: right;">in section</p> |  <p style="text-align: right;">in section</p> |
| Lateral Mounting                                  |    |    |

### 2. Land Dimensions

2-1. Please refer to the land dimensions in table 1 for flow soldering, table 2 for reflow soldering, table 3 for reflow soldering for ZRB Series, table 4 for reflow soldering for LLA Series, table 5 for reflow soldering for LLM Series.

Please confirm the suitable land dimension by evaluating of the actual SET / PCB.

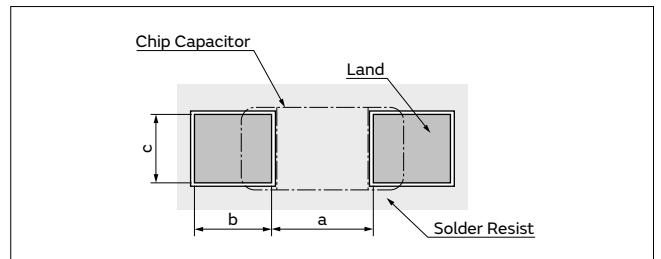

**Table 1 Flow Soldering Method**

| Series          | Chip Dimension Code (L/W) | Chip (L×W) | a          | b          | c          |
|-----------------|---------------------------|------------|------------|------------|------------|
| GQM/GR3/GRJ/GRM | 18                        | 1.6×0.8    | 0.6 to 1.0 | 0.8 to 0.9 | 0.6 to 0.8 |
| GQM/GR3/GRJ/GRM | 21                        | 2.0×1.25   | 1.0 to 1.2 | 0.9 to 1.0 | 0.8 to 1.1 |
| GR3/GRJ/GRM     | 31                        | 3.2×1.6    | 2.2 to 2.6 | 1.0 to 1.1 | 1.0 to 1.4 |
| LLL             | 21                        | 1.25×2.0   | 0.4 to 0.7 | 0.5 to 0.7 | 1.4 to 1.8 |
| LLL             | 31                        | 1.6×3.2    | 0.6 to 1.0 | 0.8 to 0.9 | 2.6 to 2.8 |

Flow soldering can only be used for products with a chip size from 1.6x0.8mm to 3.2x1.6mm.

(in mm)

Continued on the following page. ↗

## Notice

Continued from the preceding page. ↘

**Table 2 Reflow Soldering Method**

| Series                  | Chip Dimension Code (L/W) | Chip (L×W)              | a            | b            | c            |
|-------------------------|---------------------------|-------------------------|--------------|--------------|--------------|
| GJM/GRM                 | 02                        | 0.4×0.2                 | 0.16 to 0.2  | 0.12 to 0.18 | 0.2 to 0.23  |
| GJM/GRM                 | 03                        | 0.6×0.3 (±0.03)         | 0.2 to 0.25  | 0.2 to 0.3   | 0.25 to 0.35 |
|                         |                           | 0.6×0.3 (±0.05)         | 0.2 to 0.25  | 0.25 to 0.35 | 0.3 to 0.4   |
|                         |                           | 0.6×0.3 (±0.09)         | 0.23 to 0.3  | 0.25 to 0.35 | 0.3 to 0.4   |
| GJM/GRM                 | 15                        | 1.0×0.5 (within ±0.10)  | 0.3 to 0.5   | 0.35 to 0.45 | 0.4 to 0.6   |
|                         |                           | 1.0×0.5 (±0.15/±0.20)   | 0.4 to 0.6   | 0.4 to 0.5   | 0.5 to 0.7   |
| GQM/GR3/GRJ/GRM         | 18                        | 1.6×0.8 (within ±0.10)  | 0.6 to 0.8   | 0.6 to 0.7   | 0.6 to 0.8   |
|                         |                           | 1.6×0.8 (±0.15/±0.20)   | 0.7 to 0.9   | 0.7 to 0.8   | 0.8 to 1.0   |
| GQM                     | 21                        | 2.0×1.25                | 1.0 to 1.2   | 0.6 to 0.7   | 0.8 to 1.1   |
| GR3/GRJ/GRM/GR7         | 21                        | 2.0×1.25 (within ±0.10) | 1.2          | 0.6          | 1.25         |
|                         |                           | 2.0×1.25 (±0.15)        | 1.2          | 0.6 to 0.8   | 1.2 to 1.4   |
|                         |                           | 2.0×1.25 (±0.20)        | 1.0 to 1.4   | 0.6 to 0.8   | 1.2 to 1.4   |
| GQM                     | 22                        | 2.8×2.8                 | 2.2 to 2.5   | 0.8 to 1.0   | 1.9 to 2.3   |
| GR3/GRJ/GRM/GR7         | 31                        | 3.2×1.6 (within ±0.20)  | 1.8 to 2.0   | 0.9 to 1.2   | 1.5 to 1.7   |
|                         |                           | 3.2×1.6 (±0.30)         | 1.9 to 2.1   | 1.0 to 1.3   | 1.7 to 1.9   |
| GR3/GRJ/GRM             | 32                        | 3.2×2.5                 | 2.0 to 2.4   | 1.0 to 1.2   | 1.8 to 2.3   |
| GA2/GA3/GR4             | 42                        | 4.5×2.0                 | 2.8 to 3.4   | 1.2 to 1.4   | 1.4 to 1.8   |
| GR3/GRJ/GRM/GA2/GA3/GR4 | 43                        | 4.5×3.2                 | 3.0 to 3.5   | 1.2 to 1.4   | 2.3 to 3.0   |
| GA2/GA3                 | 52                        | 5.7×2.8                 | 4.0 to 4.6   | 1.4 to 1.6   | 2.1 to 2.6   |
| GR3/GRJ/GRM/GA2/GA3/GR4 | 55                        | 5.7×5.0                 | 4.0 to 4.6   | 1.4 to 1.6   | 3.5 to 4.8   |
| LLL                     | 15                        | 0.5×1.0                 | 0.15 to 0.2  | 0.2 to 0.25  | 0.7 to 1.0   |
| LLL                     | 1U                        | 0.6×1.0                 | 0.20 to 0.25 | 0.25 to 0.35 | 0.7 to 1.0   |
| LLL/LLR                 | 18                        | 0.8×1.6                 | 0.2 to 0.3   | 0.3 to 0.4   | 1.4 to 1.6   |
| LLL                     | 21                        | 1.25×2.0                | 0.4 to 0.5   | 0.4 to 0.5   | 1.4 to 1.8   |
| LLL                     | 31                        | 1.6×3.2                 | 0.6 to 0.8   | 0.6 to 0.7   | 2.6 to 2.8   |

(in mm)

<Applicable to Part Number KR3/KRM>

| Series  | Chip Dimension Code (L/W) | Chip (L×W) | a          | b          | c          |
|---------|---------------------------|------------|------------|------------|------------|
| KRM     | 21                        | 2.0×1.25   | 1.0 to 1.2 | 0.6 to 0.7 | 0.8 to 1.1 |
| KRM     | 31                        | 3.2×1.6    | 2.2 to 2.4 | 0.8 to 0.9 | 1.0 to 1.4 |
| KR3/KRM | 55                        | 5.7×5.0    | 2.6        | 2.7        | 5.6        |

(in mm)

**Table 3 ZRB Series Reflow Soldering Method**

| Series | Chip Dimension Code (L/W) | Chip (L×W) | a          | b          | c          |
|--------|---------------------------|------------|------------|------------|------------|
| ZRB    | 15                        | 1.0×0.5    | 0.4 to 0.6 | 0.4 to 0.5 | 0.5 to 0.7 |
| ZRB    | 18*                       | 1.6×0.8    | 0.7 to 0.9 | 0.7 to 0.8 | 0.8 to 1.0 |

\*If distance between parts is too short, there is risk to cause electrical short. Please confirm the mounting pitch (distance between centers of parts) has 1.275mm or more. (ZRB18 only)

[Land for ZRB Series]

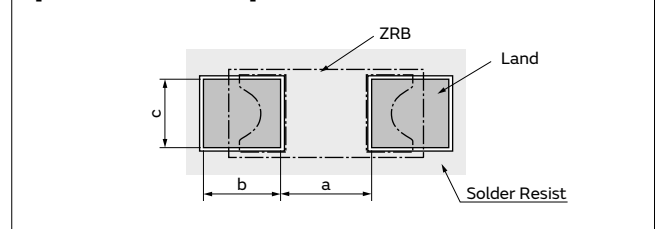

**Table 4 LLA Series Reflow Soldering Method**

| Series | Chip Dimension Code (L/W) | Chip (L×W) | a          | b            | c            | p   |
|--------|---------------------------|------------|------------|--------------|--------------|-----|
| LLA    | 18                        | 1.6×0.8    | 0.3 to 0.4 | 0.25 to 0.35 | 0.15 to 0.25 | 0.4 |
| LLA    | 21                        | 2.0×1.25   | 0.5 to 0.7 | 0.35 to 0.6  | 0.2 to 0.3   | 0.5 |

(in mm)

Continued on the following page. ↗

## Notice

Continued from the preceding page. ↘

**Table 5 LLM Series Reflow Soldering Method**

| Series | Chip Dimension Code (L/W) | Chip (L×W) | a          | b, b'        | c, c' | d          | e          | f          | p   |
|--------|---------------------------|------------|------------|--------------|-------|------------|------------|------------|-----|
| LLM    | 21                        | 2.0×1.25   | 0.6 to 0.8 | (0.3 to 0.5) | 0.3   | 2.0 to 2.6 | 1.3 to 1.8 | 1.4 to 1.6 | 0.5 |

$b=(c-e)/2, b'=(d-f)/2$  (in mm)

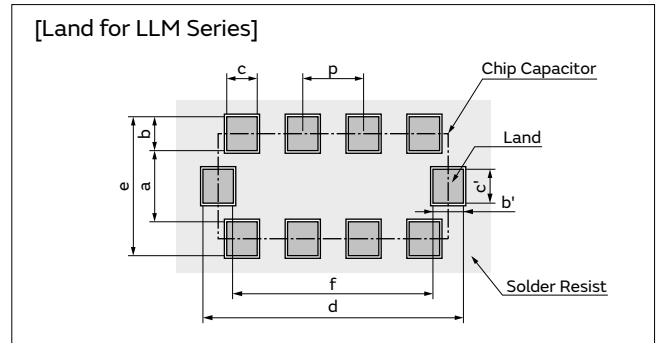
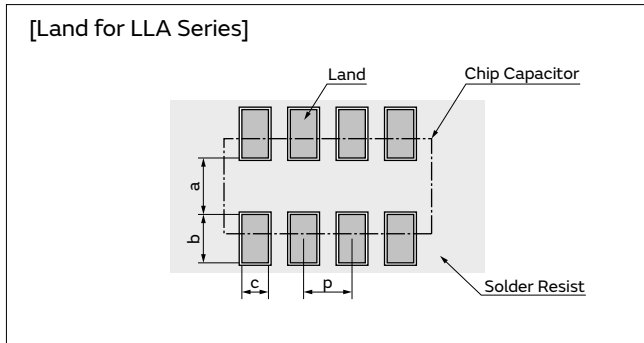

### <Applicable to beyond Rated Voltage of 200VDC>

#### 2-2. Dimensions of Slit (Example)

Preparing the slit helps flux cleaning and resin coating on the back of the capacitor.

However, the length of the slit design should be as short as possible to prevent mechanical damage in the capacitor.

A longer slit design might receive more severe mechanical stress from the PCB.

Recommended slit design is shown in the Table.

| L×W      | d          | e          |
|----------|------------|------------|
| 1.6×0.8  | -          | -          |
| 2.0×1.25 | -          | -          |
| 3.2×1.6  | 1.0 to 2.0 | 3.2 to 3.7 |
| 3.2×2.5  | 1.0 to 2.0 | 4.1 to 4.6 |
| 4.5×2.0  | 1.0 to 2.8 | 3.6 to 4.1 |
| 4.5×3.2  | 1.0 to 2.8 | 4.8 to 5.3 |
| 5.7×2.8  | 1.0 to 4.0 | 4.4 to 4.9 |
| 5.7×5.0  | 1.0 to 4.0 | 6.6 to 7.1 |

(in mm)

Continued on the following page. ↗

**Notice**

Continued from the preceding page. ↘

<Applicable to NFM Series>

■ Land Pattern + Solder Resist    ■ Land Pattern    □ Solder Resist (in mm)

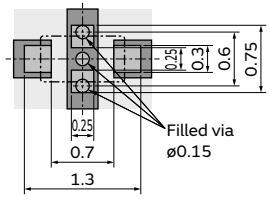
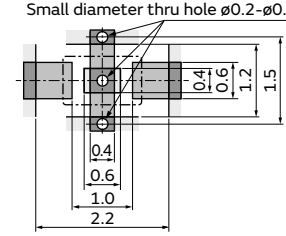
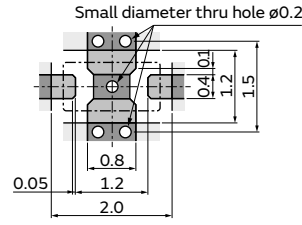
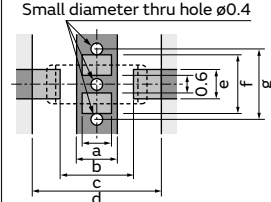
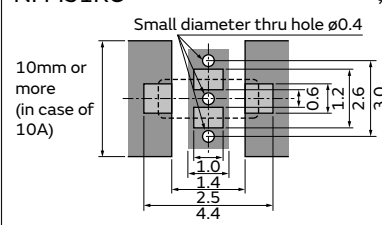
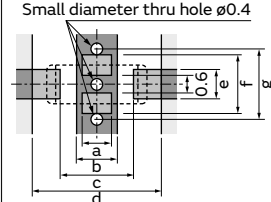
| Series  | Land Dimensions   |           |     |             |           |     |     |     |  |  |  |   |   |   |   |   |   |   |                    |     |     |     |     |     |     |     |         |     |     |     |     |     |     |     |                    |     |     |     |     |     |     |     |
|---|---|-----------|-----|-------------|-----------|-----|-----|-----|--|--|--|---|---|---|---|---|---|---|--------------------|-----|-----|-----|-----|-----|-----|-----|---------|-----|-----|-----|-----|-----|-----|-----|--------------------|-----|-----|-----|-----|-----|-----|-----|
| NFM15CC<br>NFM15PC<br>NFM18CC<br>NFM18PC<br>NFM18PS<br>NFM21CC<br>NFM21PC<br>NFM21PS  | ● Reflow Soldering<br>NFM15CC/NFM15PC   |           |     |             |           |     |     |     |  |  |  |   |   |   |   |   |   |   |                    |     |     |     |     |     |     |     |         |     |     |     |     |     |     |     |                    |     |     |     |     |     |     |     |
|   |    |           |     |             |           |     |     |     |  |  |  |   |   |   |   |   |   |   |                    |     |     |     |     |     |     |     |         |     |     |     |     |     |     |     |                    |     |     |     |     |     |     |     |
|   | NFM18CC/NFM18PC   |           |     |             |           |     |     |     |  |  |  |   |   |   |   |   |   |   |                    |     |     |     |     |     |     |     |         |     |     |     |     |     |     |     |                    |     |     |     |     |     |     |     |
|   |   |           |     |             |           |     |     |     |  |  |  |   |   |   |   |   |   |   |                    |     |     |     |     |     |     |     |         |     |     |     |     |     |     |     |                    |     |     |     |     |     |     |     |
|   | NFM18PS   |           |     |             |           |     |     |     |  |  |  |   |   |   |   |   |   |   |                    |     |     |     |     |     |     |     |         |     |     |     |     |     |     |     |                    |     |     |     |     |     |     |     |
|   |    |           |     |             |           |     |     |     |  |  |  |   |   |   |   |   |   |   |                    |     |     |     |     |     |     |     |         |     |     |     |     |     |     |     |                    |     |     |     |     |     |     |     |
| NFM3DCC<br>NFM3DPC<br>NFM31PC<br>NFM31KC<br>NFM41CC<br>NFM41PC  | ● Reflow Soldering    Chip mounting side<br>NFM3DCC/NFM3DPC/NFM31PC/NFM41CC/NFM41PC   |           |     |             |           |     |     |     |  |  |  |   |   |   |   |   |   |   |                    |     |     |     |     |     |     |     |         |     |     |     |     |     |     |     |                    |     |     |     |     |     |     |     |
|   |    |           |     |             |           |     |     |     |  |  |  |   |   |   |   |   |   |   |                    |     |     |     |     |     |     |     |         |     |     |     |     |     |     |     |                    |     |     |     |     |     |     |     |
|   | <table border="1"> <thead> <tr> <th rowspan="2">Part Number</th> <th colspan="7">Size (mm)</th> </tr> <tr> <th>a</th> <th>b</th> <th>c</th> <th>d</th> <th>e</th> <th>f</th> <th>g</th> </tr> </thead> <tbody> <tr> <td>NFM3DCC<br/>NFM3DPC</td> <td>1.0</td> <td>1.4</td> <td>2.5</td> <td>4.4</td> <td>1.0</td> <td>2.0</td> <td>2.4</td> </tr> <tr> <td>NFM31PC</td> <td>1.0</td> <td>1.4</td> <td>2.5</td> <td>4.4</td> <td>1.2</td> <td>2.6</td> <td>3.0</td> </tr> <tr> <td>NFM41CC<br/>NFM41PC</td> <td>1.5</td> <td>2.0</td> <td>3.5</td> <td>6.0</td> <td>1.2</td> <td>2.6</td> <td>3.0</td> </tr> </tbody> </table> |           |     | Part Number | Size (mm) |     |     |     |  |  |  | a | b | c | d | e | f | g | NFM3DCC<br>NFM3DPC | 1.0 | 1.4 | 2.5 | 4.4 | 1.0 | 2.0 | 2.4 | NFM31PC | 1.0 | 1.4 | 2.5 | 4.4 | 1.2 | 2.6 | 3.0 | NFM41CC<br>NFM41PC | 1.5 | 2.0 | 3.5 | 6.0 | 1.2 | 2.6 | 3.0 |
|   | Part Number   | Size (mm) |     |             |           |     |     |     |  |  |  |   |   |   |   |   |   |   |                    |     |     |     |     |     |     |     |         |     |     |     |     |     |     |     |                    |     |     |     |     |     |     |     |
|   |   | a         | b   | c           | d         | e   | f   | g   |  |  |  |   |   |   |   |   |   |   |                    |     |     |     |     |     |     |     |         |     |     |     |     |     |     |     |                    |     |     |     |     |     |     |     |
|   | NFM3DCC<br>NFM3DPC  | 1.0       | 1.4 | 2.5         | 4.4       | 1.0 | 2.0 | 2.4 |  |  |  |   |   |   |   |   |   |   |                    |     |     |     |     |     |     |     |         |     |     |     |     |     |     |     |                    |     |     |     |     |     |     |     |
| NFM31PC   | 1.0   | 1.4       | 2.5 | 4.4         | 1.2       | 2.6 | 3.0 |     |  |  |  |   |   |   |   |   |   |   |                    |     |     |     |     |     |     |     |         |     |     |     |     |     |     |     |                    |     |     |     |     |     |     |     |
| NFM41CC<br>NFM41PC  | 1.5   | 2.0       | 3.5 | 6.0         | 1.2       | 2.6 | 3.0 |     |  |  |  |   |   |   |   |   |   |   |                    |     |     |     |     |     |     |     |         |     |     |     |     |     |     |     |                    |     |     |     |     |     |     |     |
| NFM31KC*1   |   |           |     |             |           |     |     |     |  |  |  |   |   |   |   |   |   |   |                    |     |     |     |     |     |     |     |         |     |     |     |     |     |     |     |                    |     |     |     |     |     |     |     |
|    |   |           |     |             |           |     |     |     |  |  |  |   |   |   |   |   |   |   |                    |     |     |     |     |     |     |     |         |     |     |     |     |     |     |     |                    |     |     |     |     |     |     |     |
| *1 For large current design, width of signal land pattern should be wider not less than 1mm per 1A (1mm/A). For example, in case of 10A, signal land pattern width should be 10mm or more. (1mm/A*10A=10mm) |   |           |     |             |           |     |     |     |  |  |  |   |   |   |   |   |   |   |                    |     |     |     |     |     |     |     |         |     |     |     |     |     |     |     |                    |     |     |     |     |     |     |     |
| ● Flow Soldering    Chip mounting side<br>NFM31KC*1   |   |           |     |             |           |     |     |     |  |  |  |   |   |   |   |   |   |   |                    |     |     |     |     |     |     |     |         |     |     |     |     |     |     |     |                    |     |     |     |     |     |     |     |
|   |   |           |     |             |           |     |     |     |  |  |  |   |   |   |   |   |   |   |                    |     |     |     |     |     |     |     |         |     |     |     |     |     |     |     |                    |     |     |     |     |     |     |     |
| *1 For large current design, width of signal land pattern should be wider not less than 1mm per 1A (1mm/A). For example, in case of 10A, signal land pattern width should be 10mm or more. (1mm/A*10A=10mm) |   |           |     |             |           |     |     |     |  |  |  |   |   |   |   |   |   |   |                    |     |     |     |     |     |     |     |         |     |     |     |     |     |     |     |                    |     |     |     |     |     |     |     |

Continued on the following page. ↗

GRM  
 GR3  
 GRJ  
 GR4  
 GR7  
 GJM  
 GQM  
 GA2  
 GA3 GB  
 GA3 GD  
 GA3 GF  
 LLL  
 LLA  
 LLM  
 LLR  
 NFM  
 KRM  
 KR3  
 GMA  
 GMD  
 Notice  
 287

## Notice

Continued from the preceding page. ↘

### 3. Board Design

When designing the board, keep in mind that the amount of strain which occurs will increase depending on the size and material of the board.

[Relationship with amount of strain to the board thickness, length, width, etc.]

$$\epsilon = \frac{3PL}{2Ewh^2} \quad \text{Relationship between load and strain}$$

$\epsilon$ : Strain on center of board ( $\mu\text{st}$ )  
 $L$ : Distance between supporting points (mm)  
 $w$ : Board width (mm)  
 $h$ : Board thickness (mm)  
 $E$ : Elastic modulus of board ( $\text{N}/\text{m}^2=\text{Pa}$ )  
 $Y$ : Deflection (mm)  
 $P$ : Load (N)

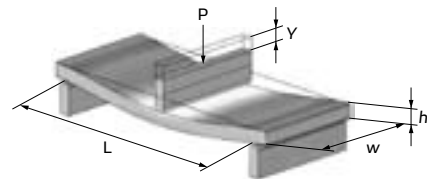

When the load is constant, the following relationship can be established.

- As the distance between the supporting points ( $L$ ) increases, the amount of strain also increases.  
 →Reduce the distance between the supporting points.
  - As the elastic modulus ( $E$ ) decreases, the amount of strain increases.  
 →Increase the elastic modulus.
  - As the board width ( $w$ ) decreases, the amount of strain increases.  
 →Increase the width of the board.
  - As the board thickness ( $h$ ) decreases, the amount of strain increases.  
 →Increase the thickness of the board.
- Since the board thickness is squared, the effect on the amount of strain becomes even greater.

## 2. Adhesive Application

If you want to temporarily attach the capacitor to the board using an adhesive agent before soldering the capacitor, first be sure that the conditions are appropriate for affixing the capacitor. If the dimensions of the land, the type of adhesive, the amount of coating, the contact surface area, the curing temperature, or other conditions are inappropriate, the characteristics of the capacitor may deteriorate.

### 1. Selection of Adhesive

1-1. Depending on the type of adhesive, there may be a decrease in insulation resistance. In addition, there is a chance that the capacitor might crack from contractile stress due to the difference in the contraction rate of the capacitor and the adhesive.

1-2. If there is not enough adhesive, the contact surface area is too small, or the curing temperature or curing time are inadequate, the adhesive strength will be insufficient and the capacitor may loosen or become disconnected during transportation or soldering.

If there is too much adhesive, for example if it overflows onto the land, the result could be soldering defects, loss of electrical connection, insufficient curing, or slippage after the capacitor is mounted.

Furthermore, if the curing temperature is too high or the curing time is too long, not only will the adhesive

strength be reduced, but solderability may also suffer due to the effects of oxidation on the terminations (outer electrodes) of the capacitor and the land surface on the board.

#### (1) Selection of Adhesive

Epoxy resins are a typical class of adhesive.

To select the proper adhesive, consider the following points.

- 1) There must be enough adhesive strength to prevent the component from loosening or slipping during the mounting process.
- 2) The adhesive strength must not decrease when exposed to moisture during soldering.
- 3) The adhesive must have good coatability and shape retention properties.
- 4) The adhesive must have a long pot life.
- 5) The curing time must be short.
- 6) The adhesive must not be corrosive to the exterior of the capacitor or the board.
- 7) The adhesive must have good insulation properties.
- 8) The adhesive must not emit toxic gases or otherwise be harmful to health.
- 9) The adhesive must be free of halogenated compounds.

Continued on the following page. ↗

GRM

GR3

GRJ

GR4

GR7

GJM

GQM

GA2

GA3  
GB

GA3  
GD

GA3  
GF

LLL

LLA

LLM

LLR

NFM

KRM

KR3

GMA

GMD

Notice

## Notice

Continued from the preceding page. ↘

(2) Use the following illustration as a guide to the amount of adhesive to apply.

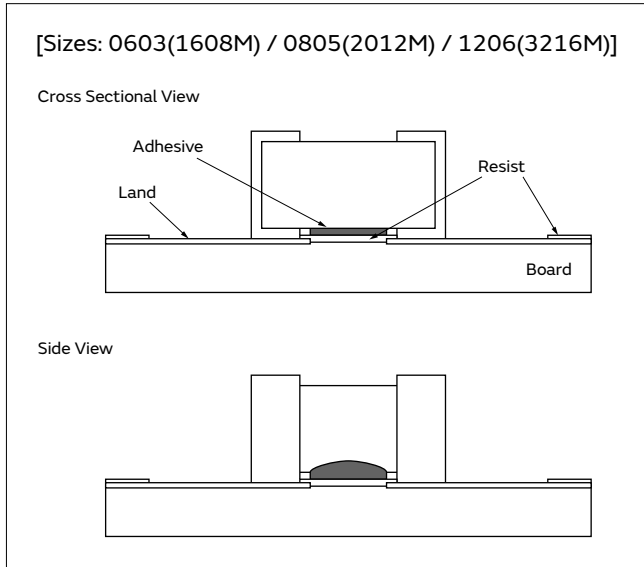

<Applicable to NFM Series>

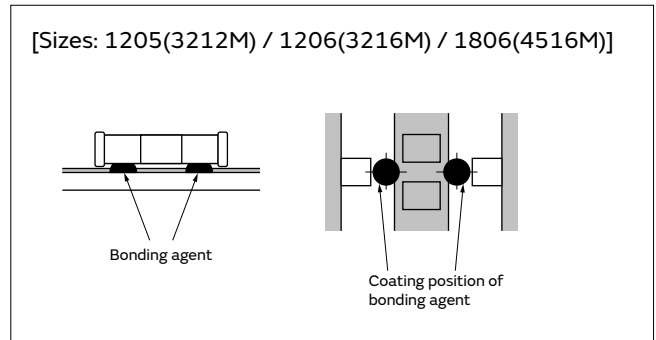

### 3. Adhesive Curing

1. Insufficient curing of the adhesive can cause chips to disconnect during flow soldering and causes deterioration in the insulation resistance between the terminations due to moisture absorption.

Control curing temperature and time in order to prevent insufficient hardening.

### 4. Flux for Flow Soldering

1. An excessive amount of flux generates a large quantity of flux gas, which can cause a deterioration of solderability, so apply flux thinly and evenly throughout. (A foaming system is generally used for flow soldering.)

2. Flux containing too high a percentage of halide may cause corrosion of the terminations unless there is sufficient cleaning. Use flux with a halide content of 0.1% max.  
 3. Strong acidic flux can corrode the capacitor and degrade its performance.  
 Please check the quality of capacitor after mounting.

### 5. Flow Soldering

● Set temperature and time to ensure that leaching of the terminations does not exceed 25% of the chip end area as a single chip (full length of the edge A-B-C-D shown at right) and 25% of the length A-B shown as mounted on substrate.

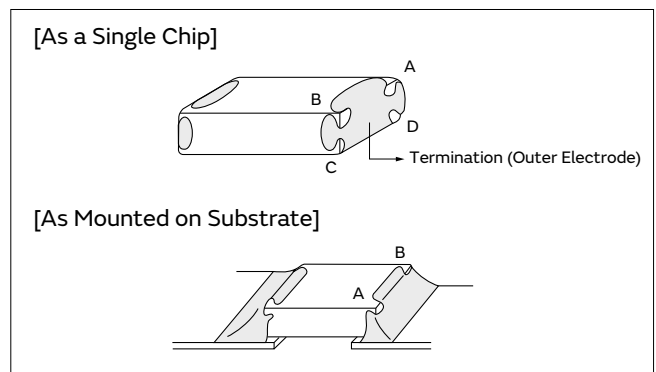

### 6. Reflow Soldering

The flux in the solder paste contains halogen-based substances and organic acids as activators. Strong acidic flux can corrode the capacitor and degrade its performance.

Please check the quality after mounting, please use.

Continued on the following page. ↗



## Notice

Continued from the preceding page. ↘

### 7. Washing

1. Please evaluate the capacitor using actual cleaning equipment and conditions to confirm the quality, and select the solvent for cleaning.

2. Unsuitable cleaning may leave residual flux or other foreign substances, causing deterioration of electrical characteristics and the reliability of the capacitors.

### 8. Coating

1. A crack may be caused in the capacitor due to the stress of the thermal contraction of the resin during curing process.  
The stress is affected by the amount of resin and curing contraction.  
Select a resin with low curing contraction.  
The difference in the thermal expansion coefficient between a coating resin or a molding resin and the capacitor may cause the destruction and deterioration of the capacitor such as a crack or peeling, and lead to the deterioration of insulation resistance or dielectric breakdown.  
Select a resin for which the thermal expansion coefficient is as close to that of the capacitor as possible.  
A silicone resin can be used as an under-coating to buffer against the stress.

2. Select a resin that is less hygroscopic.  
Using hygroscopic resins under high humidity conditions may cause the deterioration of the insulation resistance of a capacitor.  
An epoxy resin can be used as a less hygroscopic resin.
3. The halogen system substance and organic acid are included in coating material, and a chip corrodes by the kind of Coating material.  
Do not use strong acid type.

#### <Applicable to ZRB Series>

4. Loss suppress acoustic noise may be caused in ZRB series due to the resin during curing process. Please contact our sales representative or product engineers on the apply to resin during curing process.

### Other

#### 1. Transportation

1. The performance of a capacitor may be affected by the conditions during transportation.
  - 1-1. The capacitors shall be protected against excessive temperature, humidity, and mechanical force during transportation.
    - (1) Climatic condition
      - low air temperature: -40°C
      - change of temperature air/air: -25°C/+25°C
      - low air pressure: 30 kPa
      - change of air pressure: 6 kPa/min.
    - (2) Mechanical condition  
Transportation shall be done in such a way that the boxes are not deformed and forces are not directly passed on to the inner packaging.
  - 1-2. Do not apply excessive vibration, shock, or pressure to the capacitor.
    - (1) When excessive mechanical shock or pressure is applied to a capacitor, chipping or cracking may occur in the ceramic body of the capacitor.
    - (2) When the sharp edge of an air driver, a soldering iron, tweezers, a chassis, etc. impacts strongly on the surface of the capacitor, the capacitor may crack and short-circuit.
  - 1-3. Do not use a capacitor to which excessive shock was applied by dropping, etc.  
A capacitor dropped accidentally during processing may be damaged.

#### 2. Characteristics Evaluation in the Actual System

1. Evaluate the capacitor in the actual system, to confirm that there is no problem with the performance and specification values in a finished product before using.
2. Since a voltage dependency and temperature dependency exists in the capacitance of high dielectric type ceramic capacitors, the capacitance may change depending on the operating conditions in the actual system. Therefore, be sure to evaluate the various characteristics, such as the leakage current and noise absorptivity, which will affect the capacitance value of the capacitor.
3. In addition, voltages exceeding the predetermined surge may be applied to the capacitor by the inductance in the actual system. Evaluate the surge resistance in the actual system as required.

#### <Applicable to NFM Series>

4. The effects of noise suppression can vary depending on the usage conditions, including differences in the circuit or IC to be used, the type of noise, the shape of the pattern to be mounted, and the mounting location. Be sure to verify the effect on the actual device in advance.

GRM

GR3

GRJ

GR4

GR7

GJM

GQM

GA2

GA3  
GB

GA3  
GD

GA3  
GF

LLL

LLA

LLM

LLR

NFM

KRM

KR3

GMA

GMD

Notice

## X-ON Electronics

Largest Supplier of Electrical and Electronic Components

*Click to view similar products for [Multilayer Ceramic Capacitors MLCC - SMD/SMT](#) category:*

*Click to view products by [Murata](#) manufacturer:*

Other Similar products are found below :

[M39014/02-1218V](#) [M39014/02-1225V](#) [M39014/22-0631](#) [D55342E07B523DR-T/R](#) [NIN-FB391JTRF](#) [NIN-FC2R7JTRF](#)  
[NMC0402NPO220J50TRPF](#) [NMC0402X5R105K6.3TRPF](#) [NMC0402X5R224K6.3TRPF](#) [NMC0402X7R103J25TRPF](#)  
[NMC0402X7R392K50TRPF](#) [NMC0603NPO201J50TRPF](#) [NMC0603NPO330G50TRPF](#) [NMC0603NPO331F50TRPF](#)  
[NMC0603X5R475M6.3TRPF](#) [NMC0603X7R333K16TRPF](#) [NMC0805NPO220J100TRPF](#) [NMC0805NPO820J50TRPF](#)  
[NMC1206X7R102K50TRPF](#) [NMC1206X7R106K10TRPLPF](#) [NMC-H0805X7R472K250TRPF](#) [C1608C0G2A221J](#) [C1608X7R1E334K](#)  
[C2012C0G2A472J](#) [2220J2K00562KXT](#) [CCR06CG153FSV](#) [CDR33BX104AKUR](#) [CDR33BX683AKUS](#) [CGA3E1X7R1C684K](#)  
[CL10C0R8BB8ANNC](#) [M55342H06B20G0R-T/R](#) [C1005X5R0G225M](#) [C2012X7R2E223K](#) [C3216C0G2J272J](#) [D55342E07B35E7R-T/R](#)  
[CDR34BX563BKUS](#) [CDR34BX563BKWS](#) [NMC0402NPO220F50TRPF](#) [NMC0402X7R562J25TRPF](#) [NMC0603NPO102J25TRPF](#)  
[NMC1206X7R332K50TRPF](#) [NMC-P1206X7R104K250TRPLPF](#) [726632-1](#) [CGA6M3X7R1H225K](#) [CGA5L2X7R2A105K](#)  
[CGA3E2X8R1H223K](#) [CDR33BX823AKUR\M500](#) [CDR33BP132BJUR](#) [CDR35BX474AKUR\M500](#) [CDR35BX104BKUR\M500](#)