

# Chip Multilayer Ceramic Capacitors for Automotive



2020

# Contents

Product specifications are as of May 2020.

|   |          |
|---|----------|
| Explanation of Symbols in This Catalog .....  | p3       |
| Selection Guide for Capacitors .....  | p4       |
| Catalog Information .....   | p5       |
| Part Numbering .....  | p6       |
| Capacitance Table .....   | p10      |
| Search Capacitors .....   | p44      |
| <b>Cap. Table</b>   |          |
| <hr/>   |          |
| AEC-Q200 Compliant Chip Multilayer Ceramic Capacitors for Infotainment<br>GRT Series .....  | p45 p11  |
| <hr/>   |          |
| Chip Multilayer Ceramic Capacitors for Automotive<br>GCM Series .....   | p57 p20  |
| <hr/>   |          |
| High Effective Capacitance & High Ripple Current Chip Multilayer Ceramic<br>Capacitors for Automotive GC3 Series .....                          | p90 p31  |
| <hr/>   |          |
| Soft Termination Chip Multilayer Ceramic Capacitors for Automotive<br>GCJ Series .....  | p92 p32  |
| <hr/>   |          |
| High Q Chip Multilayer Ceramic Capacitors for Automotive<br>GCQ Series .....  | p99 p36  |
| <hr/>   |          |
| MLSC Design Chip Multilayer Ceramic Capacitors for Automotive<br>GCD Series .....   | p106 p36 |
| <hr/>   |          |
| Soft Termination MLSC Design Chip Multilayer Ceramic Capacitors for Automotive<br>GCE Series .....  | p109 p37 |
| <hr/>   |          |
| Very Large Current 3 Terminals Low ESL Chip Multilayer Ceramic Capacitors<br>for Automotive NFM Series .....                                    | p112 p37 |
| <hr/>   |          |
| Metal Terminal Type Multilayer Ceramic Capacitors for Automotive<br>KCM Series .....  | p115 p37 |
| <hr/>   |          |
| High Effective Capacitance & High Allowable Ripple Current Metal Terminal Type<br>Multilayer Ceramic Capacitors for Automotive KC3 Series ..... | p119 p38 |
| <hr/>   |          |
| Safety Standard Certified Metal Terminal Type Multilayer Ceramic Capacitors<br>for Automotive KCA Series .....                                  | p122 p38 |
| <hr/>   |          |
| Ni Plating + Pd Plating Termination Conductive Glue Mounting Chip Multilayer<br>Ceramic Capacitors for Automotive GCB Series .....              | p125 p38 |
| <hr/>   |          |
| AgPd Termination Conductive Glue Mounting Chip Multilayer Ceramic Capacitors<br>for Automotive GCG Series .....                                 | p127 p39 |
| <hr/>   |          |
| ⚠Caution/Notice .....   | p147     |
| Web page SimSurfing .....   | p168     |
| Introduction .....  | p169     |

Please check the MURATA website (<https://www.murata.com/>)  
 if you cannot find a part number in this catalog.

## EU RoHS Compliant

- All the products in this catalog comply with EU RoHS.
- EU RoHS is "the European Directive 2011/65/EU on the Restriction of the Use of Certain Hazardous Substances in Electrical and Electronic Equipment."
- For more details, please refer to our web page, "Murata's Approach for EU RoHS" (<https://www.murata.com/en-eu/support/compliance/rohs>).

GRT Series  
 GCM Series  
 GC3 Series  
 GCJ Series  
 GCQ Series  
 GCD Series  
 GCE Series  
 NFM Series  
 KCM Series  
 KC3 Series  
 KCA Series  
 GCB Series  
 GCG Series  
 ⚠Caution/Notice

# Explanation of Symbols in This Catalog



Links are provided to the latest information from the PDF version of the catalog, which is available on the web.

|                            |   |
|----------------------------|---|
| <b>General</b>             | For applications that do not require the particular reliability such as the general equipment   |
| <b>Info-tainment</b>       | Infotainment for Automotive<br>The product for entertainment equipment like car navigations, car audios, and body control equipment like wipers, power windows.   |
| <b>Power-train</b>         | Powertrain/Safety for Automotive<br>Product used for applications (running, turning, stopping and safety devices) which particularly concern human life, such as in devices for automobiles.  |
| <b>Medical Device</b>      | Medical-grade products for Implanted Medical Devices<br>These products are intended for use in implanted medical devices such as cardiac pacemakers, cochlear implants, insulin pumps and gastric electrostimulators.<br>They are suitable for use in non-critical circuits. *1<br>*1 Non-critical circuits<br>This term refers to circuits in implanted medical devices that are not directly linked to life support, i.e. circuits that will not directly endanger the life of the patient should the functionality of the device be reduced or halted by failure of the circuit. |
| <b>AEC-Q200</b>            | AEC-Q200 compliant product  |
| <b>Safety standard</b>     | Safety Standard Certified Product<br>Products that acquired safety standard certification IEC60384-14 and products based on the Electrical Appliance and Material Safety Law of Japan.  |
| <b>Japanese Safety Law</b> | Based on the Electrical Appliance and Material Safety Law of Japan<br>Products that are based on the electrical appliance and material safety law of Japan.   |
| <b>High Q</b>              | Low dissipation for high frequency<br>By devising ceramic materials and electrode materials, low dissipation is achieved in frequency bands of VHF, UHF and microwave or beyond.  |
| <b>Low ESL</b>             | Low inductance<br>This capacitor is designed so that the parasitic inductance component (ESL) that the capacitor has on the high frequency side becomes lower.  |
| <b>Deflecting crack</b>    | Product resistant to deflection cracking<br>This capacitor is designed to prevent failures as much as possible by short mode caused by cracking when there is board deflection.   |
| <b>Soldering crack</b>     | Product with solder cracking suppression<br>"This capacitor is configured with metal terminals and leads connected to the chip. The metal terminals and leads relieve the stress from expansion and contraction of the solder, to suppress solder cracking."  |
| <b>Anti-noise</b>          | Product suitable for acoustic noise reduction and low distortion<br>This product suppresses acoustic noise, which occurs when a ceramic capacitor is used, by devising the materials and configuration.   |
| <b>Effective Cap</b>       | No DC bias characteristics<br>Polymer capacitor is no capacitance change with DC bias due to aluminum oxidized film for dielectric.   |
| <b>EMI Filter</b>          | Low-inductance product suitable for noise suppression.<br>This product has extremely low ESL and is suitable for suppression of noise, including high frequencies.<br>This product can also be used as a low-ESL, high-performance bypass capacitor.  |
| <b>Bonding</b>             | Product for bonding<br>Since gold is used for the external electrodes, the capacitor can be mounted by die bonding/wire bonding.  |

|                         |   |
|-------------------------|---|
| <b>D1</b><br>Derating 1 | <p><b>Derating 1</b><br/>Murata's General MLCC products are designed for use in devices with a typical lifetime around 10 years.<br/>Murata's general MLCC products are designed so that the useful lifetime can be extended longer than 10 years under the following conditions:<br/>"80% of the rated voltage or less, Maximum operating temperature -20 degree C or less"<br/>Extended useful lifetime, under specific operating conditions, can be estimated from the chart.<br/>• The useful lifetime is the time when cumulative failure rate becomes 1%.<br/>• Please note that the useful lifetime data is for reference only and not guaranteed.</p> <p>at rated voltage x 80%</p> |
| <b>D2</b><br>Derating 2 | <p><b>Derating 2</b><br/>When the product temperature exceeds 105°C, please use this product within the voltage and temperature derated conditions in the figure below.</p>   |
| <b>D3</b><br>Derating 3 | <p><b>Derating 3</b><br/>Please apply the derating curve according to the operating temperature.<br/>Please refer to detailed specifications sheet for details.</p>   |
| <b>D4</b><br>Derating 4 | <p><b>Derating 4</b><br/>When the product temperature exceeds 125°C, please use this product within the voltage and temperature derated conditions in the figure below.</p>   |
| <b>D5</b><br>Derating 5 | <p><b>Derating 5</b><br/>Please apply the rated voltage derating over 150 °C.<br/>Please refer to detailed specifications sheet for details.</p>  |

# Selection Guide for Ceramic Capacitors

| Infotainment for automotive |  |
|-----------------------------|--|
| Info-Infotainment           | SMD  |
| AEC-Q200                    | Solder mounting                            |
|                             | Chip type                                  |
|                             | GRT <span style="float: right;">p45</span> |

| Powertrain/Safety for automotive    |   |
|-------------------------------------|---|
| Powertrain                          | SMD   |
| AEC-Q200                            | Solder mounting   |
|                                     | Chip type   |
|                                     | GCM <span style="float: right;">p57</span>  |
|                                     | GC3 <span>Anti-noise</span> High effective capacitance & high ripple current <span style="float: right;">p90</span>   |
|                                     | GCJ <span>Deflecting crack</span> Soft termination <span style="float: right;">p92</span>   |
|                                     | GCQ <span>High Q</span> <span style="float: right;">p99</span>  |
|                                     | GCD <span>Deflecting crack</span> MLSC design <span style="float: right;">p106</span>   |
|                                     | GCE <span>Deflecting crack</span> Soft termination MLSC design <span style="float: right;">p109</span>  |
|                                     | NFM <span>Low ESL</span> <span>EMI Filter</span> 3 terminals <span style="float: right;">p112</span>  |
|                                     | Metal terminal type   |
|                                     | KCM <span>Anti-noise</span> <span>Deflecting crack</span> <span>Soldering crack</span> <span style="float: right;">p115</span>  |
|                                     | KC3 <span>Anti-noise</span> <span>Deflecting crack</span> <span>Soldering crack</span> High effective capacitance & high ripple current <span style="float: right;">p119</span> |
|                                     | KCA <span>Safety standard</span> <span>Anti-noise</span> <span>Deflecting crack</span> <span>Soldering crack</span> <span style="float: right;">p122</span>                     |
|                                     | Limited to Conductive Glue Mounting   |
| Limited to conductive glue mounting | Chip type   |
|                                     | GCB <span>Deflecting crack</span> <span>Soldering crack</span> Ni plating + Pd plating termination conductive glue mounting <span style="float: right;">p125</span>             |
|                                     | GCG <span>Deflecting crack</span> <span>Soldering crack</span> AgPd termination conductive glue mounting <span style="float: right;">p127</span>                                |
|                                     | Lead type   |
|                                     | Solder mounting   |
|                                     | RCE <span>Anti-noise</span> <span>Deflecting crack</span> <span>Soldering crack</span> <span style="float: right;">WEB</span>   |
|                                     | RHE <span>Anti-noise</span> <span>Deflecting crack</span> <span>Soldering crack</span> 150°C operation leaded <span style="float: right;">WEB</span>                            |
|                                     | RHS <span>Anti-noise</span> <span>Deflecting crack</span> <span>Soldering crack</span> 200°C operation leaded <span style="float: right;">WEB</span>                            |
|                                     | DE6 <span>Safety standard</span> <span style="float: right;">WEB</span>   |

| Medical-grade products for implanted medical devices |  |
|--|--|
| Medical Device                                       | SMD  |
|  | Solder mounting                            |
|  | Chip type                                  |
|  | GCH <span style="float: right;">WEB</span> |

| For general |  |
|-------------|--|
| General     | SMD  |
|             | Solder mounting  |
|             | Chip type  |
|             | GRM <span style="float: right;">WEB</span>   |
|             | GR3 <span>Anti-noise</span> High effective capacitance & high ripple current <span style="float: right;">WEB</span>  |
|             | GRJ <span>Deflecting crack</span> Soft termination <span style="float: right;">WEB</span>  |
|             | GR4 For information devices only <span style="float: right;">WEB</span>  |
|             | GJM <span>High Q</span> <span style="float: right;">WEB</span>   |
|             | GQM <span>High Q</span> High power <span style="float: right;">WEB</span>  |
|             | GA2 <span>Japanese Safety Law</span> Based on the Electrical Appliance and Material Safety Law of Japan <span style="float: right;">WEB</span>                                 |
|             | GA3 <span>Safety standard</span> <span style="float: right;">WEB</span>  |
|             | LLL <span>Low ESL</span> LW reversed <span style="float: right;">WEB</span>  |
|             | LLA <span>Low ESL</span> 8 terminals <span style="float: right;">WEB</span>  |
|             | LLM <span>Low ESL</span> 10 terminals <span style="float: right;">WEB</span>   |
|             | LLR <span>Low ESL</span> LW reversed controlled ESR <span style="float: right;">WEB</span>   |
|             | NFM <span>Low ESL</span> <span>EMI Filter</span> 3 terminals <span style="float: right;">WEB</span>  |
|             | GJ4 <span>Anti-noise</span> Low distortion <span style="float: right;">WEB</span>  |
|             | On interposer board  |
|             | ZRA <span>Anti-noise</span> <span style="float: right;">WEB</span>   |
|             | ZRB <span>Anti-noise</span> <span style="float: right;">WEB</span>   |
|             | Metal terminal type  |
|             | KRM <span>Anti-noise</span> <span>Deflecting crack</span> <span>Soldering crack</span> <span style="float: right;">WEB</span>  |
|             | KR3 <span>Anti-noise</span> <span>Deflecting crack</span> <span>Soldering crack</span> High effective capacitance & high ripple current <span style="float: right;">WEB</span> |
|             | Resin molding SMD type   |
|             | DK1 <span>Safety standard</span> <span style="float: right;">WEB</span>  |
|             | Wire bonding mounting  |
| Bonding     | Chip type  |
|             | GMA Microchip <span style="float: right;">WEB</span>   |
|             | GMD <span style="float: right;">WEB</span>   |
|             | Lead type  |
|             | Solder mounting  |
|             | RDE <span>Anti-noise</span> <span>Deflecting crack</span> <span>Soldering crack</span> <span style="float: right;">WEB</span>  |
|             | DE1 <span>Safety standard</span> X1/Y1 Class certified product <span style="float: right;">WEB</span>  |
|             | DE2 <span>Safety standard</span> X1/Y2 Class certified product <span style="float: right;">WEB</span>  |



# Catalog Information

Catalog relates to a multilayer ceramic capacitor is below.

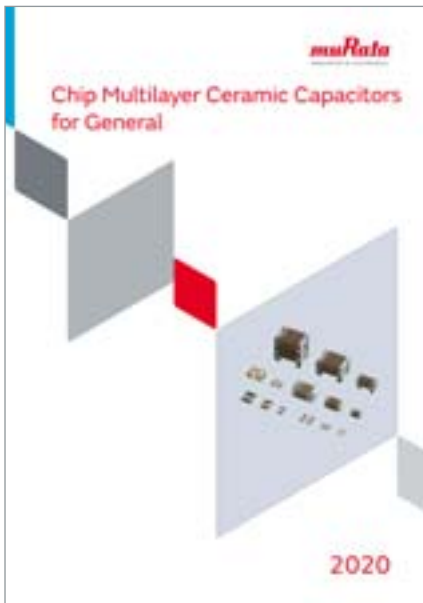

## Chip Multilayer Ceramic Capacitors for General

Cat No. C02E-22

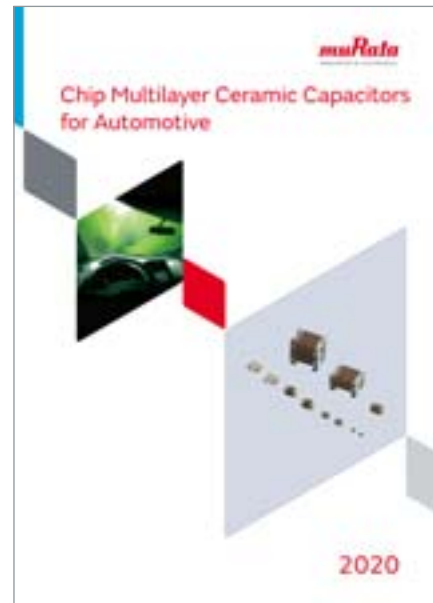

## Chip Multilayer Ceramic Capacitors for Automotive

Cat No. C03E-11



## Lead Type Disc Ceramic Capacitors (Safety Standard Certified) Resin Molding SMD Type Ceramic Capacitors (Safety Standard Certified)

Cat No. C85E-7

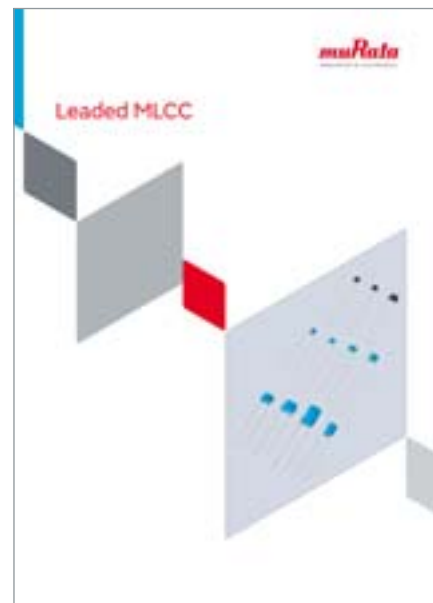

## Leaded MLCC

Cat No. C49E-25

● Part Numbering

Chip Multilayer Ceramic Capacitors for Automotive



(Part Number)

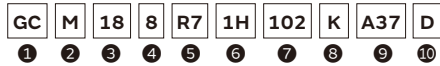

① Product ID ② Series

| Product ID | Code | Series  |
|------------|------|---|
| GC         | 3    | High Effective Capacitance & High Ripple Current Chip Multilayer Ceramic Capacitors for Automotive                          |
|            | B    | Ni Plating + Pd Plating termination Conductive Glue Mounting Chip Multilayer Ceramic Capacitors for Automotive              |
|            | D    | MLSC Design Chip Multilayer Ceramic Capacitors for Automotive   |
|            | E    | Soft Termination MLSC Design Chip Multilayer Ceramic Capacitors for Automotive  |
|            | G    | AgPd Termination Conductive Glue Mounting Chip Multilayer Ceramic Capacitors for Automotive                                 |
|            | J    | Soft Termination Chip Multilayer Ceramic Capacitors for Automotive  |
|            | M    | Chip Multilayer Ceramic Capacitors for Automotive   |
|            | Q    | High Q Chip Multilayer Ceramic Capacitors for Automotive  |
| GR         | T    | AEC-Q200 Compliant Chip Multilayer Ceramic Capacitors for Infotainment  |
| KC         | 3    | High Effective Capacitance & High Allowable Ripple Current Metal Terminal Type Multilayer Ceramic Capacitors for Automotive |
|            | A    | Safety Standard Certified Metal Terminal Type Multilayer Ceramic Capacitors for Automotive                                  |
|            | M    | Metal Terminal Type Multilayer Ceramic Capacitors for Automotive  |

③ Chip Dimension (L x W)

| Code | Dimension (L x W) | EIA  |
|------|-------------------|------|
| 03   | 0.6 x 0.3mm       | 0201 |
| 15   | 1.0 x 0.5mm       | 0402 |
| 18   | 1.6 x 0.8mm       | 0603 |
| 21   | 2.0 x 1.25mm      | 0805 |
| 31   | 3.2 x 1.6mm       | 1206 |
| 32   | 3.2 x 2.5mm       | 1210 |
| 43   | 4.5 x 3.2mm       | 1812 |
| 55   | 5.7 x 5.0mm       | 2220 |

④ Height Dimension (T) (Except KC□)

| Code | Dimension (T)                    |
|------|----------------------------------|
| 2    | 0.2mm                            |
| 3    | 0.3mm                            |
| 5    | 0.5mm                            |
| 6    | 0.6mm                            |
| 8    | 0.8mm                            |
| 9    | 0.85mm                           |
| A    | 1.0mm                            |
| B    | 1.25mm                           |
| C    | 1.6mm                            |
| D    | 2.0mm                            |
| E    | 2.5mm                            |
| M    | 1.15mm                           |
| N    | 1.35mm                           |
| Q    | 1.5mm                            |
| X    | Depends on individual standards. |

④ Height Dimension (T) (KC□ Only)

| Code | Dimension (T) |
|------|---------------|
| L    | 2.8mm         |
| R    | 3.6mm         |
| Q    | 3.7mm         |
| T    | 4.8mm         |
| V    | 6.2mm         |
| W    | 6.4mm         |

Continued on the following page. ↗

(Part Number)

|    |   |    |   |    |    |     |   |     |    |
|----|---|----|---|----|----|-----|---|-----|----|
| GC | M | 18 | 8 | R7 | 1H | 102 | K | A37 | D  |
| 1  | 2 | 3  | 4 | 5  | 6  | 7   | 8 | 9   | 10 |

Continued from the preceding page. ↘

⑤ Temperature Characteristics

| Temperature Characteristic Codes |                 |                       | Temperature Characteristics |   |                        | Operating Temperature Range | Capacitance Change Each Temperature (%) |       |       |       |      |       |
|----------------------------------|-----------------|-----------------------|-----------------------------|---|------------------------|-----------------------------|---|-------|-------|-------|------|-------|
| Code                             | Public STD Code | Reference Temperature | Temperature Range           | Capacitance Change or Temperature Coefficient | -55°C                  |                             | *3                                      |       | -10°C |       |      |       |
|                                  |                 |                       |                             |   | Max.                   |                             | Min.                                    | Max.  | Min.  | Max.  | Min. |       |
| 0C                               | CHA             | *1                    | 20°C                        | 20 to 150°C                                   | 0±60ppm/°C             | -55 to 150°C                | 0.82                                    | -0.45 | 0.49  | -0.27 | 0.33 | -0.18 |
| 2C                               | CH              | JIS                   | 20°C                        | 20 to 125°C                                   | 0±60ppm/°C             | -55 to 125°C                | 0.82                                    | -0.45 | 0.49  | -0.27 | 0.33 | -0.18 |
| 3C                               | CJ              | JIS                   | 20°C                        | 20 to 125°C                                   | 0±120ppm/°C            | -55 to 125°C                | 1.37                                    | -0.9  | 0.82  | -0.54 | 0.55 | -0.36 |
| 4C                               | CK              | JIS                   | 20°C                        | 20 to 125°C                                   | 0±250ppm/°C            | -55 to 125°C                | 2.56                                    | -1.88 | 1.54  | -1.13 | 1.02 | -0.75 |
| 5C                               | C0G             | EIA                   | 25°C                        | 25 to 125°C                                   | 0±30ppm/°C             | -55 to 125°C                | 0.58                                    | -0.24 | 0.4   | -0.17 | 0.25 | -0.11 |
| 5G                               | X8G             | *1                    | 25°C                        | 25 to 150°C                                   | 0±30ppm/°C             | -55 to 150°C                | 0.58                                    | -0.24 | 0.4   | -0.17 | 0.25 | -0.11 |
| 7U                               | U2J             | EIA                   | 25°C                        | 25 to 125°C *2                                | -750±120ppm/°C         | -55 to 125°C                | 8.78                                    | 5.04  | 6.04  | 3.47  | 3.84 | 2.21  |
| 9E                               | ZLM             | *1                    | 20°C                        | -55 to -40°C                                  | -4700+1000/-2500ppm/°C | -55 to 125°C                | -                                       | -     | -     | -     | -    | -     |
|                                  |                 |                       |                             | -40 to 20°C                                   | -5350±750ppm/°C        |                             | -                                       | -     | -     | -     | -    | -     |
|                                  |                 |                       |                             | 20 to 85°C                                    | -4700±500ppm/°C        |                             | -                                       | -     | -     | -     | -    | -     |
|                                  |                 |                       |                             | 85 to 125°C                                   | -4700+2000/-1000ppm/°C |                             | -                                       | -     | -     | -     | -    | -     |
| C7                               | X7S             | EIA                   | 25°C                        | -55 to 125°C                                  | ±22%                   | -55 to 125°C                | -                                       | -     | -     | -     | -    | -     |
| C8                               | X6S             | EIA                   | 25°C                        | -55 to 105°C                                  | ±22%                   | -55 to 105°C                | -                                       | -     | -     | -     | -    | -     |
| D7                               | X7T             | EIA                   | 25°C                        | -55 to 125°C                                  | +22%, -33%             | -55 to 125°C                | -                                       | -     | -     | -     | -    | -     |
| L8                               | X8L             | *1                    | 25°C                        | -55 to 150°C                                  | +15%, -40%             | -55 to 150°C                | -                                       | -     | -     | -     | -    | -     |
| M8                               | X8M             | *1                    | 25°C                        | -55 to 150°C                                  | +15%, -50%             | -55 to 150°C                | -                                       | -     | -     | -     | -    | -     |
| R6                               | X5R             | EIA                   | 25°C                        | -55 to 85°C                                   | ±15%                   | -55 to 85°C                 | -                                       | -     | -     | -     | -    | -     |
| R7                               | X7R             | EIA                   | 25°C                        | -55 to 125°C                                  | ±15%                   | -55 to 125°C                | -                                       | -     | -     | -     | -    | -     |
| R9                               | X8R             | EIA                   | 25°C                        | -55 to 150°C                                  | ±15%                   | -55 to 150°C                | -                                       | -     | -     | -     | -    | -     |

\*1 Murata Temperature Characteristic Code.

\*2 Rated Voltage 100Vdc max: 25 to 85°C

\*3 -25°C (Reference Temperature 20°C) / -30°C (Reference Temperature 25°C)

⑥ Rated Voltage

| Code             |                         | Rated Voltage  |
|------------------|-------------------------|--|
| Standard Product | Voltage Derated Product |  |
| 0E               | -                       | DC2.5V   |
| 0G               | -                       | DC4V   |
| 0J               | EC                      | DC6.3V   |
| 1A               | ED                      | DC10V  |
| 1C               | EE                      | DC16V  |
| 1E               | EF                      | DC25V  |
| YA               | EG                      | DC35V  |
| 1H               | EH                      | DC50V  |
| 1J               | -                       | DC63V  |
| 1K               | -                       | DC80V  |
| 2A               | EL                      | DC100V   |
| 2E               | -                       | DC250V   |
| 2W               | LP                      | DC450V   |
| 2J               | LQ                      | DC630V   |
| 3A               | -                       | DC1kV  |
| MF               | -                       | X1/Y2: AC250V<br>(Safety Standard Certified Type MF) |

⑦ Capacitance

Expressed by three-digit alphanumerics. The unit is pico-farad (pF). The first and second figures are significant digits, and the third figure expresses the number of zeros that follow the two numbers.

If there is a decimal point, it is expressed by the capital letter "R." In this case, all figures are significant digits.

If any letter, other than "R" is included, this indicates the specific part number is a non-standard part.

Ex.)

| Code | Capacitance |
|------|-------------|
| R50  | 0.50pF      |
| 1R0  | 1.0pF       |
| 100  | 10pF        |
| 103  | 10000pF     |

Continued on the following page. ↗

(Part Number)

|    |   |    |   |    |    |     |   |     |    |
|----|---|----|---|----|----|-----|---|-----|----|
| GC | M | 18 | 8 | R7 | 1H | 102 | K | A37 | D  |
| 1  | 2 | 3  | 4 | 5  | 6  | 7   | 8 | 9   | 10 |

Continued from the preceding page. ↘

③ Capacitance Tolerance

| Code | Capacitance Tolerance            |
|------|----------------------------------|
| B    | ±0.1pF                           |
| C    | ±0.25pF                          |
| D    | ±0.5pF                           |
| F    | ±1%                              |
| G    | ±2%                              |
| J    | ±5%                              |
| K    | ±10%                             |
| M    | ±20%                             |
| R    | Depends on individual standards. |
| W    | ±0.05pF                          |

⑨ Individual Specification Code

Expressed by three figures.

⑩ Package

| Code | Package                |
|------|------------------------|
| L    | ø180mm Embossed Taping |
| D/W  | ø180mm Paper Taping    |
| K    | ø330mm Embossed Taping |
| J    | ø330mm Paper Taping    |

Please contact us if you find any part number not provided in this table.

### 3 Terminal Low ESL Multilayer Ceramic Capacitors



(Part Number)

|    |   |    |    |     |   |    |   |   |
|----|---|----|----|-----|---|----|---|---|
| NF | M | 3D | CC | 102 | R | 1H | 3 | L |
| ①  | ② | ③  | ④  | ⑤   | ⑥ | ⑦  | ⑧ | ⑨ |

#### ① Product ID ② Series

| Product ID | Series                  |
|------------|-------------------------|
| NFM        | 3 Terminal Low ESL Type |

#### ③ Dimensions (LxW)

| Code | Dimensions (LxW) | EIA  |
|------|------------------|------|
| 18   | 1.6x0.8mm        | 0603 |
| 21   | 2.0x1.25mm       | 0805 |
| 31   | 3.2x1.6mm        | 1206 |

#### ④ Features

| Code | Features                         |                                      |
|------|----------------------------------|--------------------------------------|
| HC   | Powertrain/Safety for Automotive | For Signal Lines / For Large Current |
| HK   |                                  | For Very Large Current               |

#### ⑤ Capacitance

Expressed by three figures. The unit is in pico-farad (pF). The first and second figures are significant digits, and the third figure expresses the number of zeros that follow the two figures.

#### ⑥ Characteristics

| Code | Capacitance Temperature Characteristics |
|------|---|
| C    | ±22%                                    |
| R    | ±15%, +15/-18%                          |

#### ⑦ Rated Voltage

| Code | Rated Voltage |
|------|---------------|
| 0J   | 6.3V          |
| 1A   | 10V           |
| 1C   | 16V           |
| 1H   | 50V           |
| 2A   | 100V          |

#### ⑧ Electrode

| Code | Electrode  |
|------|------------|
| 3    | Sn Plating |

#### ⑨ Packaging

| Code | Packaging                     |
|------|-------------------------------|
| L    | Embossed Taping (ø180mm Reel) |
| D    | Paper Taping (ø180mm Reel)    |

Please contact us if you find any part number not provided in this table.

# Capacitance Table

## How to read the Capacitance Table

| L×W (mm)            | 0.6×0.3 |     |     | 1.0×0.5 |     |
|---------------------|---------|-----|-----|---------|-----|
| T max. (mm)         | 0.33    |     |     | 0.5     |     |
| Rated Voltage (Vdc) | 100     | 50  | 25  | 100     | 50  |
| Cap. / TC Code      | COG     | COG | COG | COG     | COG |
| 0.10pF              | p46     | p47 | p48 |         |     |
| 0.11pF              |         |     | p48 |         | p50 |
| 0.12pF              |         |     |     |         | p50 |
| 0.13pF              |         |     | p48 |         | p50 |
| 0.15pF              |         |     | p48 |         | p50 |

The values can be narrowed down in the order of size, rated voltage, and temperature characteristics.

Refers to the page of the part number list.  
 Check the part number list for the applicable product number.

## Temperature Characteristics Table

The Table is colored by temperature characteristic codes. Refer to the following Table for the meaning of each code.

| Temperature Characteristic Codes |                       | Temperature Characteristics |   |                        | Operating Temperature Range | Capacitance Change Each Temperature (%) |       |       |       |      |       |
|----------------------------------|-----------------------|-----------------------------|---|------------------------|-----------------------------|---|-------|-------|-------|------|-------|
| Public STD Code                  | Reference Temperature | Temperature Range           | Capacitance Change or Temperature Coefficient | -55°C                  |                             | *3                                      |       | -10°C |       |      |       |
|                                  |                       |                             |   | Max.                   |                             | Min.                                    | Max.  | Min.  | Max.  | Min. |       |
| CHA                              | *1                    | 20°C                        | 20 to 150°C                                   | 0±60ppm/°C             | -55 to 150°C                | 0.82                                    | -0.45 | 0.49  | -0.27 | 0.33 | -0.18 |
| CH                               | JIS                   | 20°C                        | 20 to 125°C                                   | 0±60ppm/°C             | -55 to 125°C                | 0.82                                    | -0.45 | 0.49  | -0.27 | 0.33 | -0.18 |
| CJ                               | JIS                   | 20°C                        | 20 to 125°C                                   | 0±120ppm/°C            | -55 to 125°C                | 1.37                                    | -0.9  | 0.82  | -0.54 | 0.55 | -0.36 |
| CK                               | JIS                   | 20°C                        | 20 to 125°C                                   | 0±250ppm/°C            | -55 to 125°C                | 2.56                                    | -1.88 | 1.54  | -1.13 | 1.02 | -0.75 |
| COG                              | EIA                   | 25°C                        | 25 to 125°C                                   | 0±30ppm/°C             | -55 to 125°C                | 0.58                                    | -0.24 | 0.4   | -0.17 | 0.25 | -0.11 |
| X8G                              | *1                    | 25°C                        | 25 to 150°C                                   | 0±30ppm/°C             | -55 to 150°C                | 0.58                                    | -0.24 | 0.4   | -0.17 | 0.25 | -0.11 |
| U2J                              | EIA                   | 25°C                        | 25 to 125°C *2                                | -750±120ppm/°C         | -55 to 125°C                | 8.78                                    | 5.04  | 6.04  | 3.47  | 3.84 | 2.21  |
| ZLM                              | *1                    | 20°C                        | -55 to -40°C                                  | -4700+1000/-2500ppm/°C | -55 to 125°C                | -                                       | -     | -     | -     | -    | -     |
|                                  |                       |                             | -40 to 20°C                                   | -5350±750ppm/°C        |                             | -                                       | -     | -     | -     | -    |       |
|                                  |                       |                             | 20 to 85°C                                    | -4700±500ppm/°C        |                             | -                                       | -     | -     | -     | -    |       |
|                                  |                       |                             | 85 to 125°C                                   | -4700+2000/-1000ppm/°C |                             | -                                       | -     | -     | -     | -    |       |
| X7S                              | EIA                   | 25°C                        | -55 to 125°C                                  | ±22%                   | -55 to 125°C                | -                                       | -     | -     | -     | -    | -     |
| X6S                              | EIA                   | 25°C                        | -55 to 105°C                                  | ±22%                   | -55 to 105°C                | -                                       | -     | -     | -     | -    | -     |
| X7T                              | EIA                   | 25°C                        | -55 to 125°C                                  | +22%, -33%             | -55 to 125°C                | -                                       | -     | -     | -     | -    | -     |
| X8L                              | *1                    | 25°C                        | -55 to 150°C                                  | +15%, -40%             | -55 to 150°C                | -                                       | -     | -     | -     | -    | -     |
| X8M                              | *1                    | 25°C                        | -55 to 150°C                                  | +15%, -50%             | -55 to 150°C                | -                                       | -     | -     | -     | -    | -     |
| X5R                              | EIA                   | 25°C                        | -55 to 85°C                                   | ±15%                   | -55 to 85°C                 | -                                       | -     | -     | -     | -    | -     |
| X7R                              | EIA                   | 25°C                        | -55 to 125°C                                  | ±15%                   | -55 to 125°C                | -                                       | -     | -     | -     | -    | -     |
| X8R                              | EIA                   | 25°C                        | -55 to 150°C                                  | ±15%                   | -55 to 150°C                | -                                       | -     | -     | -     | -    | -     |

\*1 Murata Temperature Characteristic Code.

\*2 Rated Voltage 100Vdc max: 25 to 85°C

\*3 -25°C (Reference Temperature 20°C) / -30°C (Reference Temperature 25°C)

# Capacitance Table

## GRT Series Temperature Compensating Type

p00 ← Part Number List      EIA: COG

| L×W (mm)            | 0.6×0.3 |     |     | 1.0×0.5 |     |     | 1.6×0.8 |     |     | 2.0×1.25 |     |      | 3.2×1.6 |     |     |     |     |
|---------------------|---------|-----|-----|---------|-----|-----|---------|-----|-----|----------|-----|------|---------|-----|-----|-----|-----|
| T max. (mm)         | 0.33    |     |     | 0.55    |     |     | 0.9     |     |     | 0.6      | 0.7 | 1.35 | 0.95    | 1.8 |     |     |     |
| Rated Voltage (Vdc) | 100     | 50  | 25  | 100     | 50  | 25  | 100     | 50  | 25  | 25       | 100 | 50   | 100     | 100 | 50  | 25  | 16  |
| Cap. / TC Code      | COG     | COG | COG | COG     | COG | COG | COG     | COG | COG | COG      | COG | COG  | COG     | COG | COG | COG | COG |
| 0.10pF              | p46     | p47 | p48 |         |     |     |         |     |     |          |     |      |         |     |     |     |     |
| 0.11pF              |         |     | p48 |         | p50 |     |         |     |     |          |     |      |         |     |     |     |     |
| 0.12pF              |         |     | p48 |         | p50 |     |         |     |     |          |     |      |         |     |     |     |     |
| 0.13pF              |         |     | p48 |         | p50 |     |         |     |     |          |     |      |         |     |     |     |     |
| 0.15pF              |         |     | p48 |         | p50 |     |         |     |     |          |     |      |         |     |     |     |     |
| 0.16pF              |         |     | p48 |         | p50 |     |         |     |     |          |     |      |         |     |     |     |     |
| 0.18pF              |         |     | p48 |         | p50 |     |         |     |     |          |     |      |         |     |     |     |     |
| 0.20pF              | p46     | p47 | p48 | p50     | p50 |     |         |     |     |          |     |      |         |     |     |     |     |
| 0.22pF              |         |     | p48 |         | p50 |     |         |     |     |          |     |      |         |     |     |     |     |
| 0.24pF              |         |     | p48 |         | p50 |     |         |     |     |          |     |      |         |     |     |     |     |
| 0.27pF              |         |     | p48 |         | p50 |     |         |     |     |          |     |      |         |     |     |     |     |
| 0.30pF              | p46     | p47 | p48 | p50     | p50 |     |         |     |     |          |     |      |         |     |     |     |     |
| 0.33pF              |         |     | p48 |         | p50 |     |         |     |     |          |     |      |         |     |     |     |     |
| 0.36pF              |         |     | p48 |         | p50 |     |         |     |     |          |     |      |         |     |     |     |     |
| 0.39pF              |         |     | p48 |         | p50 |     |         |     |     |          |     |      |         |     |     |     |     |
| 0.43pF              |         |     | p48 |         | p50 |     |         |     |     |          |     |      |         |     |     |     |     |
| 0.47pF              |         | p47 | p48 |         | p50 |     |         |     |     |          |     |      |         |     |     |     |     |
| 0.51pF              |         |     | p48 |         | p50 |     |         |     |     |          |     |      |         |     |     |     |     |
| 0.56pF              |         | p47 | p48 |         | p50 |     |         |     |     |          |     |      |         |     |     |     |     |
| 0.62pF              |         |     | p48 |         | p50 |     |         |     |     |          |     |      |         |     |     |     |     |
| 0.68pF              |         | p47 | p48 |         | p50 |     |         |     |     |          |     |      |         |     |     |     |     |
| 0.75pF              |         | p47 | p48 |         | p50 |     |         |     |     |          |     |      |         |     |     |     |     |
| 0.82pF              |         | p47 | p48 |         | p50 |     |         |     |     |          |     |      |         |     |     |     |     |
| 0.91pF              |         | p47 | p48 |         | p50 |     |         |     |     |          |     |      |         |     |     |     |     |
| 1.0pF               | p46     | p47 | p48 | p50     | p50 |     |         |     |     |          |     |      |         |     |     |     |     |
| 1.1pF               | p46     | p47 | p48 | p50     | p50 |     |         |     |     |          |     |      |         |     |     |     |     |
| 1.2pF               | p46     | p47 | p48 | p50     | p50 |     |         |     |     |          |     |      |         |     |     |     |     |
| 1.3pF               | p46     | p47 | p48 | p50     | p50 |     |         |     |     |          |     |      |         |     |     |     |     |
| 1.5pF               | p46     | p47 | p48 | p50     | p50 |     |         |     |     |          |     |      |         |     |     |     |     |
| 1.6pF               | p46     | p47 | p48 | p50     | p50 |     |         |     |     |          |     |      |         |     |     |     |     |
| 1.8pF               | p46     | p47 | p48 | p50     | p50 |     |         |     |     |          |     |      |         |     |     |     |     |
| 2.0pF               | p46     | p47 | p48 | p50     | p50 |     |         |     |     |          |     |      |         |     |     |     |     |
| 2.2pF               | p46     | p47 | p48 | p50     | p50 |     |         |     |     |          |     |      |         |     |     |     |     |
| 2.4pF               | p46     | p47 | p48 | p50     | p50 |     |         |     |     |          |     |      |         |     |     |     |     |
| 2.7pF               | p46     | p47 | p48 | p50     | p50 |     |         |     |     |          |     |      |         |     |     |     |     |
| 3.0pF               | p46     | p47 | p48 | p50     | p50 |     |         |     |     |          |     |      |         |     |     |     |     |
| 3.3pF               | p46     | p47 | p48 | p50     | p50 |     |         |     |     |          |     |      |         |     |     |     |     |
| 3.6pF               | p46     | p47 | p48 | p50     | p50 |     |         |     |     |          |     |      |         |     |     |     |     |
| 3.9pF               | p46     | p47 | p48 | p50     | p50 |     |         |     |     |          |     |      |         |     |     |     |     |
| 4.0pF               | p46     | p47 | p48 | p50     | p50 |     |         |     |     |          |     |      |         |     |     |     |     |
| 4.3pF               | p46     | p47 | p48 | p50     | p50 |     |         |     |     |          |     |      |         |     |     |     |     |
| 4.7pF               | p46     | p47 | p48 | p50     | p50 |     |         |     |     |          |     |      |         |     |     |     |     |
| 5.0pF               | p46     | p47 | p48 | p50     | p50 |     |         |     |     |          |     |      |         |     |     |     |     |
| 5.1pF               | p46     | p47 | p48 | p50     | p50 |     |         |     |     |          |     |      |         |     |     |     |     |
| 5.6pF               | p46     | p47 | p48 | p50     | p50 |     |         |     |     |          |     |      |         |     |     |     |     |
| 6.0pF               | p46     | p47 | p48 | p50     | p50 |     |         |     |     |          |     |      |         |     |     |     |     |
| 6.2pF               | p46     | p47 | p48 | p50     | p50 |     |         |     |     |          |     |      |         |     |     |     |     |
| 6.8pF               | p46     | p47 | p48 | p50     | p50 |     |         |     |     |          |     |      |         |     |     |     |     |
| 7.0pF               | p46     | p47 | p48 | p50     | p50 |     |         |     |     |          |     |      |         |     |     |     |     |
| 7.5pF               | p46     | p47 | p48 | p50     | p50 |     |         |     |     |          |     |      |         |     |     |     |     |
| 8.0pF               | p46     | p47 | p48 | p50     | p50 |     |         |     |     |          |     |      |         |     |     |     |     |
| 8.2pF               | p46     | p47 | p48 | p50     | p50 |     |         |     |     |          |     |      |         |     |     |     |     |
| 9.0pF               | p46     | p47 | p48 | p50     | p50 |     |         |     |     |          |     |      |         |     |     |     |     |
| 9.1pF               | p46     | p47 | p48 | p50     | p50 |     |         |     |     |          |     |      |         |     |     |     |     |
| 10pF                | p46     | p47 | p48 | p50     | p50 | p52 |         |     |     |          |     |      |         |     |     |     |     |

↓ Continued on the following page.



# Capacitance Table

(→ GRT Series Temperature Compensating Type)

p00 ← Part Number List      EIA: COG

| L×W (mm)            | 0.6×0.3 |     |     | 1.0×0.5 |     |     | 1.6×0.8 |     |     | 2.0×1.25 |     |      | 3.2×1.6 |     |     |     |     |
|---------------------|---------|-----|-----|---------|-----|-----|---------|-----|-----|----------|-----|------|---------|-----|-----|-----|-----|
| T max. (mm)         | 0.33    |     |     | 0.55    |     |     | 0.9     |     |     | 0.6      | 0.7 | 1.35 | 0.95    | 1.8 |     |     |     |
| Rated Voltage (Vdc) | 100     | 50  | 25  | 100     | 50  | 25  | 100     | 50  | 25  | 25       | 100 | 50   | 100     | 100 | 50  | 25  | 16  |
| Cap. / TC Code      | COG     | COG | COG | COG     | COG | COG | COG     | COG | COG | COG      | COG | COG  | COG     | COG | COG | COG | COG |
| 11pF                | p46     | p47 | p49 |         | p51 |     |         |     |     |          |     |      |         |     |     |     |     |
| 12pF                | p46     | p47 | p49 | p50     | p51 | p52 |         |     |     |          |     |      |         |     |     |     |     |
| 13pF                | p46     | p47 | p49 |         | p51 |     |         |     |     |          |     |      |         |     |     |     |     |
| 15pF                | p46     | p47 | p49 | p50     | p51 | p52 |         |     |     |          |     |      |         |     |     |     |     |
| 16pF                | p46     | p47 | p49 |         | p51 |     |         |     |     |          |     |      |         |     |     |     |     |
| 18pF                | p46     | p47 | p49 | p50     | p51 | p52 |         |     |     |          |     |      |         |     |     |     |     |
| 20pF                | p46     | p47 | p49 |         | p51 |     |         |     |     |          |     |      |         |     |     |     |     |
| 22pF                | p46     | p47 | p49 | p50     | p51 | p52 |         |     |     |          |     |      |         |     |     |     |     |
| 24pF                | p46     | p47 | p49 |         | p51 |     |         |     |     |          |     |      |         |     |     |     |     |
| 27pF                | p46     | p47 | p49 | p50     | p51 | p52 |         |     |     |          |     |      |         |     |     |     |     |
| 30pF                | p46     | p47 | p49 |         | p51 |     |         |     |     |          |     |      |         |     |     |     |     |
| 33pF                | p46     | p47 | p49 | p50     | p51 | p52 |         |     |     |          |     |      |         |     |     |     |     |
| 36pF                | p46     | p47 | p49 |         | p51 |     |         |     |     |          |     |      |         |     |     |     |     |
| 39pF                | p46     | p47 | p49 | p50     | p51 | p52 |         |     |     |          |     |      |         |     |     |     |     |
| 43pF                | p46     | p47 | p49 |         | p51 |     |         |     |     |          |     |      |         |     |     |     |     |
| 47pF                | p46     | p47 | p49 | p50     | p51 | p52 |         |     |     |          |     |      |         |     |     |     |     |
| 51pF                | p46     | p47 | p49 |         | p51 |     |         |     |     |          |     |      |         |     |     |     |     |
| 56pF                | p46     | p47 | p49 | p50     | p51 | p52 |         |     |     |          |     |      |         |     |     |     |     |
| 62pF                | p46     | p47 | p49 |         | p51 |     |         |     |     |          |     |      |         |     |     |     |     |
| 68pF                | p46     | p47 | p49 | p50     | p51 | p52 |         |     |     |          |     |      |         |     |     |     |     |
| 75pF                | p46     | p48 | p49 |         | p51 |     |         |     |     |          |     |      |         |     |     |     |     |
| 82pF                | p46     | p48 | p49 | p50     | p51 | p52 |         |     |     |          |     |      |         |     |     |     |     |
| 91pF                | p46     | p48 | p49 |         | p51 |     |         |     |     |          |     |      |         |     |     |     |     |
| 100pF               | p46     | p48 | p49 | p50     | p51 | p52 |         |     |     |          |     |      |         |     |     |     |     |
| 110pF               |         | p48 | p49 |         | p51 |     |         |     |     |          |     |      |         |     |     |     |     |
| 120pF               |         | p48 |     |         | p51 | p52 | p52     |     |     |          |     |      |         |     |     |     |     |
| 130pF               |         |     |     |         | p51 |     |         |     |     |          |     |      |         |     |     |     |     |
| 150pF               |         | p48 | p49 |         | p51 | p52 | p52     |     |     |          |     |      |         |     |     |     |     |
| 160pF               |         |     |     |         | p51 |     |         |     |     |          |     |      |         |     |     |     |     |
| 180pF               |         | p48 | p49 |         | p51 | p52 | p52     |     |     |          |     |      |         |     |     |     |     |
| 200pF               |         |     |     |         | p51 |     |         |     |     |          |     |      |         |     |     |     |     |
| 220pF               |         | p48 | p49 |         | p51 | p52 | p52     |     |     |          |     |      |         |     |     |     |     |
| 240pF               |         |     |     |         | p51 |     |         |     |     |          |     |      |         |     |     |     |     |
| 270pF               |         |     | p49 |         | p51 | p52 | p52     |     |     |          |     |      |         |     |     |     |     |
| 300pF               |         |     |     |         | p51 |     |         |     |     |          |     |      |         |     |     |     |     |
| 330pF               |         |     | p49 |         | p51 | p52 | p52     |     |     |          |     |      |         |     |     |     |     |
| 360pF               |         |     |     |         | p52 |     |         |     |     |          |     |      |         |     |     |     |     |
| 390pF               |         |     | p49 |         | p52 | p52 | p52     |     |     |          |     |      |         |     |     |     |     |
| 430pF               |         |     |     |         | p52 |     |         |     |     |          |     |      |         |     |     |     |     |
| 470pF               |         |     | p49 |         | p52 | p52 | p52     |     |     |          |     |      |         |     |     |     |     |
| 510pF               |         |     |     |         | p52 |     |         |     |     |          |     |      |         |     |     |     |     |
| 560pF               |         |     | p49 |         | p52 | p52 | p52     |     |     |          |     |      |         |     |     |     |     |
| 620pF               |         |     |     |         | p52 |     |         |     |     |          |     |      |         |     |     |     |     |
| 680pF               |         |     | p49 |         | p52 | p52 | p52     |     |     |          |     |      |         |     |     |     |     |
| 750pF               |         |     |     |         | p52 |     |         |     |     |          |     |      |         |     |     |     |     |
| 820pF               |         |     | p49 |         | p52 | p52 | p52     |     |     |          |     |      |         |     |     |     |     |
| 910pF               |         |     | p49 |         | p52 |     |         |     |     |          |     |      |         |     |     |     |     |
| 1000pF              |         |     | p50 |         | p52 | p52 | p52     |     |     |          |     |      |         |     |     |     |     |
| 1200pF              |         |     |     |         |     |     | p52     | p52 | p52 |          |     |      |         |     |     |     |     |
| 1500pF              |         |     |     |         |     |     | p52     | p52 | p52 |          |     |      |         |     |     |     |     |
| 1800pF              |         |     |     |         |     |     |         | p52 |     | p53      | p53 |      |         |     |     |     |     |
| 2200pF              |         |     |     |         |     |     |         | p52 |     | p53      | p53 |      |         |     |     |     |     |
| 2700pF              |         |     |     |         |     |     |         | p52 |     |          | p53 |      |         |     |     |     |     |
| 3300pF              |         |     |     |         |     |     |         | p52 |     |          | p53 |      |         |     |     |     |     |
| 3900pF              |         |     |     |         |     |     |         | p52 |     |          |     | p53  |         |     |     |     |     |

↓ Continued on the following page.

# Capacitance Table

(→ GRT Series Temperature Compensating Type)

p00 ← Part Number List      EIA: C0G

| L×W (mm)            | 0.6×0.3 |     |     | 1.0×0.5 |     |     | 1.6×0.8 |     |     | 2.0×1.25 |     |      |      | 3.2×1.6 |     |     |         |
|---------------------|---------|-----|-----|---------|-----|-----|---------|-----|-----|----------|-----|------|------|---------|-----|-----|---------|
| T max. (mm)         | 0.33    |     |     | 0.55    |     |     | 0.9     |     |     | 0.6      | 0.7 | 1.35 | 0.95 | 1.8     |     |     |         |
| Rated Voltage (Vdc) | 100     | 50  | 25  | 100     | 50  | 25  | 100     | 50  | 25  | 25       | 100 | 50   | 100  | 100     | 50  | 25  | 16      |
| Cap. / TC Code      | C0G     | C0G | C0G | C0G     | C0G | C0G | C0G     | C0G | C0G | C0G      | C0G | C0G  | C0G  | C0G     | C0G | C0G | C0G     |
| 4300pF              |         |     |     |         |     |     |         | p52 |     |          |     |      |      |         |     |     |         |
| 4700pF              |         |     |     |         |     |     |         | p52 | p52 |          |     |      |      | p53     |     |     |         |
| 5100pF              |         |     |     |         |     |     |         | p52 |     |          |     |      |      |         |     |     |         |
| 5600pF              |         |     |     |         |     |     |         | p52 | p52 |          |     |      |      | p53     |     |     |         |
| 6800pF              |         |     |     |         |     |     |         | p52 | p52 |          |     |      |      | p53     |     |     |         |
| 8200pF              |         |     |     |         |     |     |         | p52 | p52 |          |     |      |      | p53     |     |     |         |
| 10000pF             |         |     |     |         |     |     |         | p52 | p52 |          |     |      |      | p53     |     |     |         |
| 18000pF             |         |     |     |         |     |     |         |     |     |          |     |      | p53  | p53     |     |     |         |
| 22000pF             |         |     |     |         |     |     |         |     |     |          |     |      | p53  | p53     |     |     |         |
| 56000pF             |         |     |     |         |     |     |         |     |     |          |     |      |      |         |     | p53 |         |
| 68000pF             |         |     |     |         |     |     |         |     |     |          |     |      |      |         |     | p53 |         |
| 82000pF             |         |     |     |         |     |     |         |     |     |          |     |      |      |         |     | p53 |         |
| 0.10μF              |         |     |     |         |     |     |         |     |     |          |     |      |      |         | p53 | p53 | p53     |
| 0.12μF              |         |     |     |         |     |     |         |     |     |          |     |      |      |         |     |     | p53 p53 |

# Capacitance Table

## GRT Series High Dielectric Constant Type

p00 ← Part Number List    EIA: X6S X7S X5R X7R X7T

| L×W (mm)            | 0.6×0.3 |     |     |     |     |     |     |     |     |     |     |     |     |      |     |      |     | 1.0×0.5 |      |     |     |     |     |     |     |     |
|---------------------|---------|-----|-----|-----|-----|-----|-----|-----|-----|-----|-----|-----|-----|------|-----|------|-----|---------|------|-----|-----|-----|-----|-----|-----|-----|
| T max. (mm)         | 0.33    |     |     |     |     |     |     |     |     |     |     |     |     | 0.35 |     | 0.39 |     |         | 0.22 |     |     |     |     |     |     |     |
| Rated Voltage (Vdc) | 35      |     |     | 25  |     |     | 16  |     |     | 10  |     |     | 6.3 |      |     | 4    | 6.3 | 4       | 10   | 6.3 | 4   | 2.5 | 6.3 | 4   |     |     |
| Cap. / TC Code      | X5R     | X7R | X6S | X5R | X7S | X6S | X5R | X7R | X7S | X6S | X5R | X7R | X7S | X6S  | X5R | X6S  | X5R | X6S     | X7T  | X6S | X7T | X7T | X6S | X5R | X6S |     |
| 100pF               |         |     |     | p54 |     |     |     |     |     |     |     |     |     |      |     |      |     |         |      |     |     |     |     |     |     |     |
| 150pF               |         | p54 | p54 | p54 |     |     |     |     |     |     |     |     |     |      |     |      |     |         |      |     |     |     |     |     |     |     |
| 220pF               |         |     |     | p54 |     |     |     |     |     |     |     |     |     |      |     |      |     |         |      |     |     |     |     |     |     |     |
| 270pF               |         |     |     |     |     |     |     |     |     |     |     |     |     |      |     |      |     |         |      |     |     |     |     |     |     |     |
| 330pF               |         |     |     | p54 |     |     |     |     |     |     |     |     |     |      |     |      |     |         |      |     |     |     |     |     |     |     |
| 470pF               |         | p54 | p54 | p54 |     |     |     |     |     |     |     |     |     |      |     |      |     |         |      |     |     |     |     |     |     |     |
| 680pF               |         |     |     | p54 |     |     |     |     |     |     |     |     |     |      |     |      |     |         |      |     |     |     |     |     |     |     |
| 820pF               |         |     |     |     |     |     |     |     |     |     |     |     |     |      |     |      |     |         |      |     |     |     |     |     |     |     |
| 1000pF              |         | p54 | p54 | p54 |     |     |     |     |     |     |     |     |     |      |     |      |     |         |      |     |     |     |     |     |     |     |
| 1500pF              |         |     |     |     |     |     |     |     |     |     | p54 |     |     |      |     |      |     |         |      |     |     |     |     |     |     |     |
| 2200pF              |         |     |     |     |     |     |     |     |     |     | p54 | p54 |     |      |     | p54  |     |         |      |     |     |     |     |     |     |     |
| 2700pF              |         |     |     |     |     |     |     |     |     |     |     |     |     |      |     |      |     |         |      |     |     |     |     |     |     |     |
| 3300pF              |         |     |     |     |     |     |     |     |     |     | p54 | p54 |     |      |     | p54  |     |         |      |     |     |     |     |     |     |     |
| 4700pF              |         |     |     | p54 |     |     |     |     |     |     | p54 | p54 |     |      |     | p54  |     |         |      |     |     |     |     |     |     |     |
| 5600pF              |         |     |     |     |     |     |     |     |     |     |     |     |     |      |     |      |     |         |      |     |     |     |     |     |     |     |
| 6800pF              |         |     |     | p54 |     |     |     |     |     |     | p54 | p54 |     |      |     | p54  |     |         |      |     |     |     |     |     |     |     |
| 10000pF             |         |     |     | p54 |     |     | p54 | p54 |     |     | p54 | p54 |     |      |     | p54  | p54 |         |      |     |     |     |     |     |     |     |
| 15000pF             |         |     |     |     |     |     | p54 |     |     |     | p54 |     |     |      |     | p54  | p54 |         |      |     |     |     |     |     |     |     |
| 22000pF             |         |     |     |     |     |     | p54 |     |     |     | p54 |     |     |      |     | p54  | p54 |         |      |     |     |     |     |     |     |     |
| 33000pF             |         |     |     |     |     |     | p54 |     |     |     | p54 |     |     |      |     | p54  | p54 |         |      |     |     |     |     |     |     |     |
| 39000pF             |         |     |     |     |     |     |     |     |     |     |     |     |     |      |     |      |     |         |      |     |     |     |     |     |     |     |
| 47000pF             |         |     |     |     |     |     | p54 |     |     |     | p54 |     |     |      |     | p54  | p54 |         |      |     |     |     |     |     |     |     |
| 56000pF             |         |     |     |     |     |     |     |     |     |     |     |     |     |      |     |      |     |         |      |     |     |     |     |     |     |     |
| 68000pF             |         |     |     |     |     |     | p54 |     |     |     | p54 |     |     |      |     | p54  | p54 | p54     |      |     |     |     |     |     |     |     |
| 82000pF             |         |     |     |     |     |     |     |     |     |     |     |     |     |      |     |      |     | p54     |      |     |     |     |     |     |     |     |
| 0.10μF              | p54     |     | p54 | p54 | p54 | p54 | p54 |     | p54 | p54 | p54 |     | p54 | p54  | p54 | p54  |     |         |      |     |     |     |     |     |     |     |
| 0.15μF              |         |     |     |     |     |     |     |     |     |     |     |     |     |      |     |      |     |         |      |     |     |     |     |     |     |     |
| 0.22μF              |         |     |     |     |     |     |     |     |     |     | p54 |     |     |      |     | p54  | p54 | p54     |      |     |     |     |     | p54 | p54 | p54 |
| 0.33μF              |         |     |     |     |     |     |     |     |     |     |     |     |     |      |     |      |     | p54     |      |     |     |     |     |     |     |     |
| 0.47μF              |         |     |     |     |     |     |     |     |     |     |     |     |     |      |     |      |     | p54     |      |     |     |     |     |     |     |     |
| 0.68μF              |         |     |     |     |     |     |     |     |     |     |     |     |     |      |     |      |     |         |      |     |     |     |     |     |     |     |
| 1.0μF               |         |     |     |     |     |     |     |     |     |     |     |     |     |      |     |      |     | p54     | p54  | p54 | p54 | p54 | p54 |     |     |     |
| 1.5μF               |         |     |     |     |     |     |     |     |     |     |     |     |     |      |     |      |     |         |      |     |     |     |     |     |     |     |
| 2.2μF               |         |     |     |     |     |     |     |     |     |     |     |     |     |      |     |      |     |         |      |     |     |     |     |     |     |     |
| 3.3μF               |         |     |     |     |     |     |     |     |     |     |     |     |     |      |     |      |     |         |      |     |     |     |     |     |     |     |
| 4.7μF               |         |     |     |     |     |     |     |     |     |     |     |     |     |      |     |      |     |         |      |     |     |     |     |     |     |     |
| 6.8μF               |         |     |     |     |     |     |     |     |     |     |     |     |     |      |     |      |     |         |      |     |     |     |     |     |     |     |
| 10μF                |         |     |     |     |     |     |     |     |     |     |     |     |     |      |     |      |     |         |      |     |     |     |     |     |     |     |
| 15μF                |         |     |     |     |     |     |     |     |     |     |     |     |     |      |     |      |     |         |      |     |     |     |     |     |     |     |
| 22μF                |         |     |     |     |     |     |     |     |     |     |     |     |     |      |     |      |     |         |      |     |     |     |     |     |     |     |
| 33μF                |         |     |     |     |     |     |     |     |     |     |     |     |     |      |     |      |     |         |      |     |     |     |     |     |     |     |
| 47μF                |         |     |     |     |     |     |     |     |     |     |     |     |     |      |     |      |     |         |      |     |     |     |     |     |     |     |
| 100μF               |         |     |     |     |     |     |     |     |     |     |     |     |     |      |     |      |     |         |      |     |     |     |     |     |     |     |

Continued on the following page. ↗

# Capacitance Table

(→ GRT Series High Dielectric Constant Type)

p00 ← Part Number List    EIA: X6S X7S X5R X7R X7T

| L×W (mm)            | 1.0×0.5 |     |     |     |      |     |     |     |     |     |     |     |     |     |     |     |     |     |     |     |     |     |     |     |     |    |      |   |    |
|---------------------|---------|-----|-----|-----|------|-----|-----|-----|-----|-----|-----|-----|-----|-----|-----|-----|-----|-----|-----|-----|-----|-----|-----|-----|-----|----|------|---|----|
|                     | 0.33    |     |     |     | 0.55 |     |     |     |     |     |     |     |     |     |     |     |     |     |     |     | 0.6 |     |     |     |     |    | 0.65 |   |    |
| T max. (mm)         | 10      | 6.3 | 50  | 35  | 25   |     |     |     | 16  |     |     |     | 10  |     |     |     | 6.3 |     |     |     | 4   |     | 35  | 25  | 16  | 10 | 6.3  | 4 | 10 |
| Rated Voltage (Vdc) | 10      | 6.3 | 50  | 35  | 25   |     |     |     | 16  |     |     |     | 10  |     |     |     | 6.3 |     |     |     | 4   |     | 35  | 25  | 16  | 10 | 6.3  | 4 | 10 |
| Cap. / TC Code      | X5R     | X5R | X7R | X6S | X5R  | X7R | X6S | X5R | X7R | X6S | X5R | X7R | X6S | X5R | X7R | X6S | X5R | X7R | X6S | X5R | X6S | X7S | X5R | X5R | X5R |    |      |   |    |
| 100pF               |         |     |     |     |      |     |     |     |     |     |     |     |     |     |     |     |     |     |     |     |     |     |     |     |     |    |      |   |    |
| 150pF               |         |     |     |     |      |     |     |     |     |     |     |     |     |     |     |     |     |     |     |     |     |     |     |     |     |    |      |   |    |
| 220pF               |         |     | p54 |     |      |     |     |     |     |     |     |     |     |     |     |     |     |     |     |     |     |     |     |     |     |    |      |   |    |
| 270pF               |         |     | p54 |     |      |     |     |     |     |     |     |     |     |     |     |     |     |     |     |     |     |     |     |     |     |    |      |   |    |
| 330pF               |         |     | p54 |     |      |     |     |     |     |     |     |     |     |     |     |     |     |     |     |     |     |     |     |     |     |    |      |   |    |
| 470pF               |         |     | p54 |     |      |     |     |     |     |     |     |     |     |     |     |     |     |     |     |     |     |     |     |     |     |    |      |   |    |
| 680pF               |         |     | p54 |     |      |     |     |     |     |     |     |     |     |     |     |     |     |     |     |     |     |     |     |     |     |    |      |   |    |
| 820pF               |         |     | p54 |     |      |     |     |     |     |     |     |     |     |     |     |     |     |     |     |     |     |     |     |     |     |    |      |   |    |
| 1000pF              |         |     | p54 |     |      |     |     |     |     |     |     |     |     |     |     |     |     |     |     |     |     |     |     |     |     |    |      |   |    |
| 1500pF              |         |     | p54 |     |      |     |     |     |     |     |     |     |     |     |     |     |     |     |     |     |     |     |     |     |     |    |      |   |    |
| 2200pF              |         |     | p54 |     |      |     |     |     |     |     |     |     |     |     |     |     |     |     |     |     |     |     |     |     |     |    |      |   |    |
| 2700pF              |         |     | p54 |     |      |     |     |     |     |     |     |     |     |     |     |     |     |     |     |     |     |     |     |     |     |    |      |   |    |
| 3300pF              |         |     | p54 |     |      |     |     |     |     |     |     |     |     |     |     |     |     |     |     |     |     |     |     |     |     |    |      |   |    |
| 4700pF              |         |     | p54 |     |      |     |     |     |     |     |     |     |     |     |     |     |     |     |     |     |     |     |     |     |     |    |      |   |    |
| 5600pF              |         |     |     |     |      | p55 |     |     |     |     |     |     |     |     |     |     |     |     |     |     |     |     |     |     |     |    |      |   |    |
| 6800pF              |         |     | p55 |     |      |     |     |     |     |     |     |     |     |     |     |     |     |     |     |     |     |     |     |     |     |    |      |   |    |
| 10000pF             |         |     | p55 |     |      | p55 |     |     | p55 |     |     |     |     |     |     |     |     |     |     |     |     |     |     |     |     |    |      |   |    |
| 15000pF             |         |     | p55 |     |      |     |     |     |     |     |     |     |     |     |     |     |     |     |     |     |     |     |     |     |     |    |      |   |    |
| 22000pF             |         |     | p55 |     |      | p55 |     |     | p55 |     |     |     |     |     |     |     |     | p55 |     |     |     |     |     |     |     |    |      |   |    |
| 33000pF             |         |     | p55 |     |      | p55 |     |     | p55 |     |     |     |     |     |     |     |     |     |     |     |     |     |     |     |     |    |      |   |    |
| 39000pF             |         |     | p55 |     |      |     |     |     |     |     |     |     |     |     |     |     |     |     |     |     |     |     |     |     |     |    |      |   |    |
| 47000pF             |         |     | p55 |     |      | p55 |     |     | p55 |     |     |     |     |     |     |     |     |     |     |     |     |     |     |     |     |    |      |   |    |
| 56000pF             |         |     | p55 |     |      |     |     |     |     |     |     |     |     |     |     |     |     |     |     |     |     |     |     |     |     |    |      |   |    |
| 68000pF             |         |     | p55 |     |      |     |     |     | p55 |     |     |     |     |     |     |     |     |     |     |     |     |     |     |     |     |    |      |   |    |
| 82000pF             |         |     | p55 |     |      |     |     |     |     |     |     |     |     |     |     |     |     |     |     |     |     |     |     |     |     |    |      |   |    |
| 0.10μF              |         |     | p55 |     |      | p55 |     |     | p55 |     |     |     |     |     |     |     |     |     |     |     |     |     |     |     |     |    |      |   |    |
| 0.15μF              |         |     |     |     |      |     |     |     |     |     |     |     |     |     |     |     |     |     |     |     |     |     |     |     |     |    |      |   |    |
| 0.22μF              |         |     |     | p55 | p55  |     | p55 | p55 | p55 |     | p55 | p55 |     | p55 |     | p55 | p55 |     |     |     |     |     |     |     |     |    |      |   |    |
| 0.33μF              |         |     |     |     |      |     |     |     |     |     |     |     |     |     |     |     |     | p55 | p55 |     |     |     |     |     |     |    |      |   |    |
| 0.47μF              |         |     |     | p55 |      |     |     | p55 |     | p55 | p55 |     | p55 |     | p55 | p55 |     |     |     |     |     |     |     |     |     |    |      |   |    |
| 0.68μF              |         |     |     |     |      |     |     |     |     |     |     |     |     |     |     |     |     | p55 | p55 |     |     |     |     |     |     |    |      |   |    |
| 1.0μF               | p54     | p54 |     |     |      |     |     | p55 |     |     | p55 |     |     | p55 | p55 | p55 | p55 | p55 |     |     |     | p55 | p55 | p55 | p55 |    |      |   |    |
| 1.5μF               |         |     |     |     |      |     |     |     |     |     |     |     |     |     |     |     |     |     |     |     |     |     |     |     |     |    |      |   |    |
| 2.2μF               |         | p54 |     |     |      |     |     |     |     |     |     |     |     |     |     |     |     | p55 | p55 |     |     |     |     |     |     |    |      |   |    |
| 3.3μF               |         |     |     |     |      |     |     |     |     |     |     |     |     |     |     |     |     |     |     |     |     |     |     |     |     |    |      |   |    |
| 4.7μF               |         |     |     |     |      |     |     |     |     |     |     |     |     |     |     |     |     |     |     |     |     |     |     |     |     |    |      |   |    |
| 6.8μF               |         |     |     |     |      |     |     |     |     |     |     |     |     |     |     |     |     |     |     |     |     |     |     |     |     |    |      |   |    |
| 10μF                |         |     |     |     |      |     |     |     |     |     |     |     |     |     |     |     |     |     |     |     |     |     |     |     |     |    |      |   |    |
| 15μF                |         |     |     |     |      |     |     |     |     |     |     |     |     |     |     |     |     |     |     |     |     |     |     |     |     |    |      |   |    |
| 22μF                |         |     |     |     |      |     |     |     |     |     |     |     |     |     |     |     |     |     |     |     |     |     |     |     |     |    |      |   |    |
| 33μF                |         |     |     |     |      |     |     |     |     |     |     |     |     |     |     |     |     |     |     |     |     |     |     |     |     |    |      |   |    |
| 47μF                |         |     |     |     |      |     |     |     |     |     |     |     |     |     |     |     |     |     |     |     |     |     |     |     |     |    |      |   |    |
| 100μF               |         |     |     |     |      |     |     |     |     |     |     |     |     |     |     |     |     |     |     |     |     |     |     |     |     |    |      |   |    |

Continued on the following page. ↗

# Capacitance Table

(→ GRT Series High Dielectric Constant Type)

p00 ← Part Number List    EIA: X6S X7S X5R X7R X7T

| L×W (mm)            | 1.0×0.5 |     |     |     |     |     |     |     |     |     | 1.6×0.8 |     |     |     |      |     |     |     |     |     |     |     |     |     |     |     |     |
|---------------------|---------|-----|-----|-----|-----|-----|-----|-----|-----|-----|---------|-----|-----|-----|------|-----|-----|-----|-----|-----|-----|-----|-----|-----|-----|-----|-----|
|                     | 0.65    |     | 0.7 |     |     |     |     |     | 0.9 |     |         |     |     |     | 0.95 |     |     |     | 1.0 |     |     |     |     |     |     |     |     |
| T max. (mm)         | 6.3     | 4   | 25  | 16  | 10  | 6.3 | 2.5 | 100 | 50  | 35  | 25      | 16  | 6.3 | 4   | 25   | 16  | 10  | 2.5 | 50  | 35  |     |     |     |     |     |     |     |
| Rated Voltage (Vdc) | 6.3     | 4   | 25  | 16  | 10  | 6.3 | 2.5 | 100 | 50  | 35  | 25      | 16  | 6.3 | 4   | 25   | 16  | 10  | 2.5 | 50  | 35  |     |     |     |     |     |     |     |
| Cap. / TC Code      | X6S     | X6S | X5R | X6S | X5R | X7S | X6S | X7S | X6S | X7R | X5R     | X6S | X5R | X7R | X7R  | X5R | X6S | X5R | X5R | X6S | X5R | X5R | X5R | X5R | X5R | X6S | X5R |
| 100pF               |         |     |     |     |     |     |     |     |     |     |         |     |     |     |      |     |     |     |     |     |     |     |     |     |     |     |     |
| 150pF               |         |     |     |     |     |     |     |     |     |     |         |     |     |     |      |     |     |     |     |     |     |     |     |     |     |     |     |
| 220pF               |         |     |     |     |     |     |     |     |     |     |         |     |     |     |      |     |     |     |     |     |     |     |     |     |     |     |     |
| 270pF               |         |     |     |     |     |     |     |     |     |     |         |     |     |     |      |     |     |     |     |     |     |     |     |     |     |     |     |
| 330pF               |         |     |     |     |     |     |     |     |     |     |         |     |     |     |      |     |     |     |     |     |     |     |     |     |     |     |     |
| 470pF               |         |     |     |     |     |     |     |     |     |     |         |     |     |     |      |     |     |     |     |     |     |     |     |     |     |     |     |
| 680pF               |         |     |     |     |     |     |     |     |     |     |         |     |     |     |      |     |     |     |     |     |     |     |     |     |     |     |     |
| 820pF               |         |     |     |     |     |     |     |     |     |     |         |     |     |     |      |     |     |     |     |     |     |     |     |     |     |     |     |
| 1000pF              |         |     |     |     |     |     |     |     |     |     |         |     |     |     |      |     |     |     |     |     |     |     |     |     |     |     |     |
| 1500pF              |         |     |     |     |     |     |     |     |     |     |         |     |     |     |      |     |     |     |     |     |     |     |     |     |     |     |     |
| 2200pF              |         |     |     |     |     |     |     |     |     |     |         |     |     |     |      |     |     |     |     |     |     |     |     |     |     |     |     |
| 2700pF              |         |     |     |     |     |     |     |     |     |     |         |     |     |     |      |     |     |     |     |     |     |     |     |     |     |     |     |
| 3300pF              |         |     |     |     |     |     |     |     |     |     |         |     |     |     |      |     |     |     |     |     |     |     |     |     |     |     |     |
| 4700pF              |         |     |     |     |     |     |     |     |     |     |         |     |     |     |      |     |     |     |     |     |     |     |     |     |     |     |     |
| 5600pF              |         |     |     |     |     |     |     |     |     |     |         |     |     |     |      |     |     |     |     |     |     |     |     |     |     |     |     |
| 6800pF              |         |     |     |     |     |     |     |     |     |     |         |     |     |     |      |     |     |     |     |     |     |     |     |     |     |     |     |
| 10000pF             |         |     |     |     |     |     |     |     |     |     |         |     |     |     |      |     |     |     |     |     |     |     |     |     |     |     |     |
| 15000pF             |         |     |     |     |     |     |     |     |     |     |         |     |     |     |      |     |     |     |     |     |     |     |     |     |     |     |     |
| 22000pF             |         |     |     |     |     |     |     |     |     |     |         |     |     |     |      |     |     |     |     |     |     |     |     |     |     |     |     |
| 33000pF             |         |     |     |     |     |     |     |     |     |     |         |     |     |     |      |     |     |     |     |     |     |     |     |     |     |     |     |
| 39000pF             |         |     |     |     |     |     |     |     |     |     |         |     |     |     |      |     |     |     |     |     |     |     |     |     |     |     |     |
| 47000pF             |         |     |     |     |     |     |     |     |     |     |         |     |     |     |      |     |     |     |     |     |     |     |     |     |     |     |     |
| 56000pF             |         |     |     |     |     |     |     |     |     |     |         |     |     |     |      |     |     |     |     |     |     |     |     |     |     |     |     |
| 68000pF             |         |     |     |     |     |     |     |     |     |     |         |     |     |     |      |     |     |     |     |     |     |     |     |     |     |     |     |
| 82000pF             |         |     |     |     |     |     |     |     |     |     |         |     |     |     |      |     |     |     |     |     |     |     |     |     |     |     |     |
| 0.10μF              |         |     |     |     |     |     |     |     |     |     |         |     |     |     |      |     |     |     |     |     |     |     |     |     |     |     |     |
| 0.15μF              |         |     |     |     |     |     |     |     |     |     |         |     |     |     |      |     |     |     |     |     |     |     |     |     |     |     |     |
| 0.22μF              |         |     |     |     |     |     |     |     |     |     |         |     |     |     |      |     |     |     |     |     |     |     |     |     |     |     |     |
| 0.33μF              |         |     |     |     |     |     |     |     |     |     |         |     |     |     |      |     |     |     |     |     |     |     |     |     |     |     |     |
| 0.47μF              |         |     |     |     |     |     |     |     |     |     |         |     |     |     |      |     |     |     |     |     |     |     |     |     |     |     |     |
| 0.68μF              |         |     |     |     |     |     |     |     |     |     |         |     |     |     |      |     |     |     |     |     |     |     |     |     |     |     |     |
| 1.0μF               |         |     |     |     |     |     |     |     |     |     |         |     |     |     |      |     |     |     |     |     |     |     |     |     |     |     |     |
| 1.5μF               |         |     |     |     |     |     |     |     |     |     |         |     |     |     |      |     |     |     |     |     |     |     |     |     |     |     |     |
| 2.2μF               |         |     |     |     |     |     |     |     |     |     |         |     |     |     |      |     |     |     |     |     |     |     |     |     |     |     |     |
| 3.3μF               |         |     |     |     |     |     |     |     |     |     |         |     |     |     |      |     |     |     |     |     |     |     |     |     |     |     |     |
| 4.7μF               |         |     |     |     |     |     |     |     |     |     |         |     |     |     |      |     |     |     |     |     |     |     |     |     |     |     |     |
| 6.8μF               |         |     |     |     |     |     |     |     |     |     |         |     |     |     |      |     |     |     |     |     |     |     |     |     |     |     |     |
| 10μF                |         |     |     |     |     |     |     |     |     |     |         |     |     |     |      |     |     |     |     |     |     |     |     |     |     |     |     |
| 15μF                |         |     |     |     |     |     |     |     |     |     |         |     |     |     |      |     |     |     |     |     |     |     |     |     |     |     |     |
| 22μF                |         |     |     |     |     |     |     |     |     |     |         |     |     |     |      |     |     |     |     |     |     |     |     |     |     |     |     |
| 33μF                |         |     |     |     |     |     |     |     |     |     |         |     |     |     |      |     |     |     |     |     |     |     |     |     |     |     |     |
| 47μF                |         |     |     |     |     |     |     |     |     |     |         |     |     |     |      |     |     |     |     |     |     |     |     |     |     |     |     |
| 100μF               |         |     |     |     |     |     |     |     |     |     |         |     |     |     |      |     |     |     |     |     |     |     |     |     |     |     |     |

Continued on the following page. ↗

# Capacitance Table

(→ GRT Series High Dielectric Constant Type)

p00 ← Part Number List      EIA: X6S X7S X5R X7R X7T

| L×W (mm)            | 1.6×0.8 |     |     |     |     |     |     |     |     |     |     |     | 2.0×1.25 |     |     |      |     |     |     |     |     |     |     |     |     |     |
|---------------------|---------|-----|-----|-----|-----|-----|-----|-----|-----|-----|-----|-----|----------|-----|-----|------|-----|-----|-----|-----|-----|-----|-----|-----|-----|-----|
|                     | 1.0     |     |     |     |     |     |     |     |     |     |     |     | 0.95     |     |     | 1.35 |     |     | 1.4 |     |     |     |     |     |     |     |
| T max. (mm)         | 1.0     |     |     |     |     |     |     |     |     |     |     |     | 0.95     |     |     | 1.35 |     |     | 1.4 |     |     |     |     |     |     |     |
| Rated Voltage (Vdc) | 25      |     |     | 16  |     |     | 10  |     |     | 6.3 |     |     | 4        |     |     | 16   | 10  | 100 | 50  | 16  | 50  | 35  | 25  | 16  | 10  |     |
| Cap. / TC Code      | X7S     | X6S | X5R | X7S | X6S | X7T | X6S | X5R | X7T | X6S | X5R | X6S | X5R      | X6S | X5R | X7R  | X7R | X7R | X5R | X6S | X7R | X6S | X7R | X6S | X7R | X5R |
| 100pF               |         |     |     |     |     |     |     |     |     |     |     |     |          |     |     |      |     |     |     |     |     |     |     |     |     |     |
| 150pF               |         |     |     |     |     |     |     |     |     |     |     |     |          |     |     |      |     |     |     |     |     |     |     |     |     |     |
| 220pF               |         |     |     |     |     |     |     |     |     |     |     |     |          |     |     |      |     |     |     |     |     |     |     |     |     |     |
| 270pF               |         |     |     |     |     |     |     |     |     |     |     |     |          |     |     |      |     |     |     |     |     |     |     |     |     |     |
| 330pF               |         |     |     |     |     |     |     |     |     |     |     |     |          |     |     |      |     |     |     |     |     |     |     |     |     |     |
| 470pF               |         |     |     |     |     |     |     |     |     |     |     |     |          |     |     |      |     |     |     |     |     |     |     |     |     |     |
| 680pF               |         |     |     |     |     |     |     |     |     |     |     |     |          |     |     |      |     |     |     |     |     |     |     |     |     |     |
| 820pF               |         |     |     |     |     |     |     |     |     |     |     |     |          |     |     |      |     |     |     |     |     |     |     |     |     |     |
| 1000pF              |         |     |     |     |     |     |     |     |     |     |     |     |          |     |     |      |     |     |     |     |     |     |     |     |     |     |
| 1500pF              |         |     |     |     |     |     |     |     |     |     |     |     |          |     |     |      |     |     |     |     |     |     |     |     |     |     |
| 2200pF              |         |     |     |     |     |     |     |     |     |     |     |     |          |     |     |      |     |     |     |     |     |     |     |     |     |     |
| 2700pF              |         |     |     |     |     |     |     |     |     |     |     |     |          |     |     |      |     |     |     |     |     |     |     |     |     |     |
| 3300pF              |         |     |     |     |     |     |     |     |     |     |     |     |          |     |     |      |     |     |     |     |     |     |     |     |     |     |
| 4700pF              |         |     |     |     |     |     |     |     |     |     |     |     |          |     |     |      |     |     |     |     |     |     |     |     |     |     |
| 5600pF              |         |     |     |     |     |     |     |     |     |     |     |     |          |     |     |      |     |     |     |     |     |     |     |     |     |     |
| 6800pF              |         |     |     |     |     |     |     |     |     |     |     |     |          |     |     |      |     |     |     |     |     |     |     |     |     |     |
| 10000pF             |         |     |     |     |     |     |     |     |     |     |     |     |          |     |     |      |     |     |     |     |     |     |     |     |     |     |
| 15000pF             |         |     |     |     |     |     |     |     |     |     |     |     |          |     |     |      |     |     |     |     |     |     |     |     |     |     |
| 22000pF             |         |     |     |     |     |     |     |     |     |     |     |     |          |     |     |      |     |     |     |     |     |     |     |     |     |     |
| 33000pF             |         |     |     |     |     |     |     |     |     |     |     |     |          |     |     |      |     |     |     |     |     |     |     |     |     |     |
| 39000pF             |         |     |     |     |     |     |     |     |     |     |     |     |          |     |     |      |     |     |     |     |     |     |     |     |     |     |
| 47000pF             |         |     |     |     |     |     |     |     |     |     |     |     |          |     |     |      |     |     |     |     |     |     |     |     |     |     |
| 56000pF             |         |     |     |     |     |     |     |     |     |     |     |     |          |     |     |      |     |     |     |     |     |     |     |     |     |     |
| 68000pF             |         |     |     |     |     |     |     |     |     |     |     |     |          |     |     |      |     |     |     |     |     |     |     |     |     |     |
| 82000pF             |         |     |     |     |     |     |     |     |     |     |     |     |          |     |     |      |     |     |     |     |     |     |     |     |     |     |
| 0.10μF              |         |     |     |     |     |     |     |     |     |     |     |     |          |     |     |      |     |     |     |     |     |     |     |     |     |     |
| 0.15μF              |         |     |     |     |     |     |     |     |     |     |     |     |          |     |     |      |     |     |     |     |     |     |     |     |     |     |
| 0.22μF              |         |     |     |     |     |     |     |     |     |     |     |     |          |     |     |      |     |     |     |     |     |     |     |     |     |     |
| 0.33μF              |         |     |     |     |     |     |     |     |     |     |     |     |          |     |     |      |     |     |     |     |     |     |     |     |     |     |
| 0.47μF              |         |     |     |     |     |     |     |     |     |     |     |     |          |     |     |      |     |     |     |     |     |     |     |     |     |     |
| 0.68μF              |         |     |     |     |     |     |     |     |     |     |     |     |          |     |     |      |     |     |     |     |     |     |     |     |     |     |
| 1.0μF               |         |     |     |     |     |     |     |     |     |     |     |     |          |     |     |      |     |     |     |     |     |     |     |     |     |     |
| 1.5μF               |         |     |     |     |     |     |     |     |     |     |     |     |          |     |     |      |     |     |     |     |     |     |     |     |     |     |
| 2.2μF               | p55     | p56 |     |     |     |     |     |     |     |     |     |     |          |     |     |      |     |     |     |     |     |     |     |     |     |     |
| 3.3μF               |         |     |     |     |     |     |     |     |     |     |     |     |          |     |     |      |     |     |     |     |     |     |     |     |     |     |
| 4.7μF               |         | p56 |     |     |     |     |     |     |     |     |     |     |          |     |     |      |     |     |     |     |     |     |     |     |     |     |
| 6.8μF               |         |     |     |     |     |     |     |     |     |     |     |     |          |     |     |      |     |     |     |     |     |     |     |     |     |     |
| 10μF                |         |     | p56 |     |     |     |     |     |     |     |     |     |          |     |     |      |     |     |     |     |     |     |     |     |     |     |
| 15μF                |         |     |     |     |     |     |     |     |     |     |     |     |          |     |     |      |     |     |     |     |     |     |     |     |     |     |
| 22μF                |         |     |     |     |     |     |     |     |     |     |     |     |          |     |     |      |     |     |     |     |     |     |     |     |     |     |
| 33μF                |         |     |     |     |     |     |     |     |     |     |     |     |          |     |     |      |     |     |     |     |     |     |     |     |     |     |
| 47μF                |         |     |     |     |     |     |     |     |     |     |     |     |          |     |     |      |     |     |     |     |     |     |     |     |     |     |
| 100μF               |         |     |     |     |     |     |     |     |     |     |     |     |          |     |     |      |     |     |     |     |     |     |     |     |     |     |

Continued on the following page. ↗

# Capacitance Table

(→ GRT Series High Dielectric Constant Type)

p00 ← Part Number List      EIA: X6S X7S X5R X7R X7T

| L×W (mm)            | 2.0×1.25 |      |     |     |     |     |     |     |     |     |     |     | 3.2×1.6 |      |     |     |     |     |     |     |     |     |     |     |     |     |     |     |     |
|---------------------|----------|------|-----|-----|-----|-----|-----|-----|-----|-----|-----|-----|---------|------|-----|-----|-----|-----|-----|-----|-----|-----|-----|-----|-----|-----|-----|-----|-----|
|                     | 1.4      | 1.45 |     |     |     |     |     |     |     |     |     |     | 0.95    | 1.25 |     |     |     |     |     | 1.8 |     |     |     |     |     |     |     |     |     |
| T max. (mm)         | 6.3      | 50   |     | 25  |     | 16  |     | 10  |     | 6.3 |     | 4   |         | 2.5  |     | 35  | 50  |     | 25  |     | 16  |     | 50  |     |     | 35  |     | 25  |     |
| Rated Voltage (Vdc) | 6.3      | 50   |     | 25  |     | 16  |     | 10  |     | 6.3 |     | 4   |         | 2.5  |     | 35  | 50  |     | 25  |     | 16  |     | 50  |     |     | 35  |     | 25  |     |
| Cap. / TC Code      | X5R      | X7S  | X7S | X5R | X7S | X5R | X7T | X6S | X7T | X5R | X6S | X5R | X6S     | X5R  | X6S | X5R | X6S | X5R | X6S | X5R | X6S | X7R | X6S | X5R | X6S | X5R | X6S | X5R |     |
| 100pF               |          |      |     |     |     |     |     |     |     |     |     |     |         |      |     |     |     |     |     |     |     |     |     |     |     |     |     |     |     |
| 150pF               |          |      |     |     |     |     |     |     |     |     |     |     |         |      |     |     |     |     |     |     |     |     |     |     |     |     |     |     |     |
| 220pF               |          |      |     |     |     |     |     |     |     |     |     |     |         |      |     |     |     |     |     |     |     |     |     |     |     |     |     |     |     |
| 270pF               |          |      |     |     |     |     |     |     |     |     |     |     |         |      |     |     |     |     |     |     |     |     |     |     |     |     |     |     |     |
| 330pF               |          |      |     |     |     |     |     |     |     |     |     |     |         |      |     |     |     |     |     |     |     |     |     |     |     |     |     |     |     |
| 470pF               |          |      |     |     |     |     |     |     |     |     |     |     |         |      |     |     |     |     |     |     |     |     |     |     |     |     |     |     |     |
| 680pF               |          |      |     |     |     |     |     |     |     |     |     |     |         |      |     |     |     |     |     |     |     |     |     |     |     |     |     |     |     |
| 820pF               |          |      |     |     |     |     |     |     |     |     |     |     |         |      |     |     |     |     |     |     |     |     |     |     |     |     |     |     |     |
| 1000pF              |          |      |     |     |     |     |     |     |     |     |     |     |         |      |     |     |     |     |     |     |     |     |     |     |     |     |     |     |     |
| 1500pF              |          |      |     |     |     |     |     |     |     |     |     |     |         |      |     |     |     |     |     |     |     |     |     |     |     |     |     |     |     |
| 2200pF              |          |      |     |     |     |     |     |     |     |     |     |     |         |      |     |     |     |     |     |     |     |     |     |     |     |     |     |     |     |
| 2700pF              |          |      |     |     |     |     |     |     |     |     |     |     |         |      |     |     |     |     |     |     |     |     |     |     |     |     |     |     |     |
| 3300pF              |          |      |     |     |     |     |     |     |     |     |     |     |         |      |     |     |     |     |     |     |     |     |     |     |     |     |     |     |     |
| 4700pF              |          |      |     |     |     |     |     |     |     |     |     |     |         |      |     |     |     |     |     |     |     |     |     |     |     |     |     |     |     |
| 5600pF              |          |      |     |     |     |     |     |     |     |     |     |     |         |      |     |     |     |     |     |     |     |     |     |     |     |     |     |     |     |
| 6800pF              |          |      |     |     |     |     |     |     |     |     |     |     |         |      |     |     |     |     |     |     |     |     |     |     |     |     |     |     |     |
| 10000pF             |          |      |     |     |     |     |     |     |     |     |     |     |         |      |     |     |     |     |     |     |     |     |     |     |     |     |     |     |     |
| 15000pF             |          |      |     |     |     |     |     |     |     |     |     |     |         |      |     |     |     |     |     |     |     |     |     |     |     |     |     |     |     |
| 22000pF             |          |      |     |     |     |     |     |     |     |     |     |     |         |      |     |     |     |     |     |     |     |     |     |     |     |     |     |     |     |
| 33000pF             |          |      |     |     |     |     |     |     |     |     |     |     |         |      |     |     |     |     |     |     |     |     |     |     |     |     |     |     |     |
| 39000pF             |          |      |     |     |     |     |     |     |     |     |     |     |         |      |     |     |     |     |     |     |     |     |     |     |     |     |     |     |     |
| 47000pF             |          |      |     |     |     |     |     |     |     |     |     |     |         |      |     |     |     |     |     |     |     |     |     |     |     |     |     |     |     |
| 56000pF             |          |      |     |     |     |     |     |     |     |     |     |     |         |      |     |     |     |     |     |     |     |     |     |     |     |     |     |     |     |
| 68000pF             |          |      |     |     |     |     |     |     |     |     |     |     |         |      |     |     |     |     |     |     |     |     |     |     |     |     |     |     |     |
| 82000pF             |          |      |     |     |     |     |     |     |     |     |     |     |         |      |     |     |     |     |     |     |     |     |     |     |     |     |     |     |     |
| 0.10μF              |          |      |     |     |     |     |     |     |     |     |     |     |         |      |     |     |     |     |     |     |     |     |     |     |     |     |     |     |     |
| 0.15μF              |          |      |     |     |     |     |     |     |     |     |     |     |         |      |     |     |     |     |     |     |     |     |     |     |     |     |     |     |     |
| 0.22μF              |          |      |     |     |     |     |     |     |     |     |     |     |         |      |     |     |     |     |     |     |     |     |     |     |     |     |     |     |     |
| 0.33μF              |          |      |     |     |     |     |     |     |     |     |     |     |         |      |     |     |     |     |     |     |     |     |     |     |     |     |     |     |     |
| 0.47μF              |          |      |     |     |     |     |     |     |     |     |     |     |         |      |     |     |     |     |     |     |     |     |     |     |     |     |     |     |     |
| 0.68μF              |          |      |     |     |     |     |     |     |     |     |     |     |         |      |     |     |     |     |     |     |     |     |     |     |     |     |     |     |     |
| 1.0μF               |          |      |     |     |     |     |     |     |     |     |     |     |         |      |     |     |     | p56 |     |     |     |     |     |     |     |     |     |     |     |
| 1.5μF               |          |      |     |     |     |     |     |     |     |     |     |     |         |      |     |     |     | p56 | p56 | p56 | p56 |     |     | p56 | p56 |     |     |     |     |
| 2.2μF               |          |      |     |     |     |     |     |     |     |     |     |     |         |      |     |     |     |     |     |     |     |     | p56 | p56 |     |     |     |     |     |
| 3.3μF               | p56      |      |     |     |     |     |     |     |     |     |     |     |         |      |     |     |     |     |     |     |     |     |     |     |     |     |     | p56 |     |
| 4.7μF               |          | p56  | p56 |     |     |     |     |     |     |     |     |     |         |      |     |     |     |     |     |     |     |     |     |     |     |     |     |     |     |
| 6.8μF               |          |      |     |     |     |     |     |     |     |     |     |     |         |      |     |     |     |     |     |     |     |     |     |     |     |     |     |     |     |
| 10μF                |          |      | p56 |     |     | p56 |     |     |     |     |     |     |         |      |     |     |     |     |     |     |     |     |     |     |     |     |     |     |     |
| 15μF                |          |      |     |     |     |     |     |     |     |     |     |     |         |      |     | p56 |     |     |     |     |     |     |     |     |     | p56 | p56 | p56 | p56 |
| 22μF                |          |      |     | p56 |     | p56 | p56 | p56 | p56 |     |     |     |         |      |     |     |     |     |     |     |     |     |     |     |     |     |     |     |     |
| 33μF                |          |      |     |     |     |     |     |     |     |     |     |     |         |      |     |     |     |     |     |     |     |     |     |     |     |     |     |     |     |
| 47μF                |          |      |     |     |     |     |     |     |     |     |     |     |         | p56  | p56 | p56 | p56 |     |     |     |     |     |     |     |     |     |     |     |     |
| 100μF               |          |      |     |     |     |     |     |     |     |     |     |     |         |      |     |     |     |     |     |     |     |     |     |     |     |     |     |     |     |

Continued on the following page. ↗



# Capacitance Table

(→ GRT Series High Dielectric Constant Type)

p00 ← Part Number List    EIA: X6S X7S X5R X7R X7T

| L×W (mm)            | 3.2×1.6 |     |     |     | 3.2×2.5 |     |     |     |     |     |     |     |     |     |     |     |
|---------------------|---------|-----|-----|-----|---------|-----|-----|-----|-----|-----|-----|-----|-----|-----|-----|-----|
|                     | 1.8     |     |     |     | 1.5     | 2.2 |     |     | 2.7 |     |     |     |     |     |     |     |
| T max. (mm)         | 16      | 10  | 6.3 |     | 25      | 50  | 6.3 | 50  | 16  | 10  | 6.3 |     | 4   |     |     |     |
| Rated Voltage (Vdc) | 16      | 10  | 6.3 |     | 25      | 50  | 6.3 | 50  | 16  | 10  | 6.3 |     | 4   |     |     |     |
| Cap. / TC Code      | X6S     | X5R | X6S | X5R | X5R     | X6S | X5R | X5R | X7R | X6S | X6S | X6S | X7R | X7S | X5R | X7S |
| 100pF               |         |     |     |     |         |     |     |     |     |     |     |     |     |     |     |     |
| 150pF               |         |     |     |     |         |     |     |     |     |     |     |     |     |     |     |     |
| 220pF               |         |     |     |     |         |     |     |     |     |     |     |     |     |     |     |     |
| 270pF               |         |     |     |     |         |     |     |     |     |     |     |     |     |     |     |     |
| 330pF               |         |     |     |     |         |     |     |     |     |     |     |     |     |     |     |     |
| 470pF               |         |     |     |     |         |     |     |     |     |     |     |     |     |     |     |     |
| 680pF               |         |     |     |     |         |     |     |     |     |     |     |     |     |     |     |     |
| 820pF               |         |     |     |     |         |     |     |     |     |     |     |     |     |     |     |     |
| 1000pF              |         |     |     |     |         |     |     |     |     |     |     |     |     |     |     |     |
| 1500pF              |         |     |     |     |         |     |     |     |     |     |     |     |     |     |     |     |
| 2200pF              |         |     |     |     |         |     |     |     |     |     |     |     |     |     |     |     |
| 2700pF              |         |     |     |     |         |     |     |     |     |     |     |     |     |     |     |     |
| 3300pF              |         |     |     |     |         |     |     |     |     |     |     |     |     |     |     |     |
| 4700pF              |         |     |     |     |         |     |     |     |     |     |     |     |     |     |     |     |
| 5600pF              |         |     |     |     |         |     |     |     |     |     |     |     |     |     |     |     |
| 6800pF              |         |     |     |     |         |     |     |     |     |     |     |     |     |     |     |     |
| 10000pF             |         |     |     |     |         |     |     |     |     |     |     |     |     |     |     |     |
| 15000pF             |         |     |     |     |         |     |     |     |     |     |     |     |     |     |     |     |
| 22000pF             |         |     |     |     |         |     |     |     |     |     |     |     |     |     |     |     |
| 33000pF             |         |     |     |     |         |     |     |     |     |     |     |     |     |     |     |     |
| 39000pF             |         |     |     |     |         |     |     |     |     |     |     |     |     |     |     |     |
| 47000pF             |         |     |     |     |         |     |     |     |     |     |     |     |     |     |     |     |
| 56000pF             |         |     |     |     |         |     |     |     |     |     |     |     |     |     |     |     |
| 68000pF             |         |     |     |     |         |     |     |     |     |     |     |     |     |     |     |     |
| 82000pF             |         |     |     |     |         |     |     |     |     |     |     |     |     |     |     |     |
| 0.10μF              |         |     |     |     |         |     |     |     |     |     |     |     |     |     |     |     |
| 0.15μF              |         |     |     |     |         |     |     |     |     |     |     |     |     |     |     |     |
| 0.22μF              |         |     |     |     |         |     |     |     |     |     |     |     |     |     |     |     |
| 0.33μF              |         |     |     |     |         |     |     |     |     |     |     |     |     |     |     |     |
| 0.47μF              |         |     |     |     |         |     |     |     |     |     |     |     |     |     |     |     |
| 0.68μF              |         |     |     |     |         |     |     |     |     |     |     |     |     |     |     |     |
| 1.0μF               |         |     |     |     |         |     |     |     |     |     |     |     |     |     |     |     |
| 1.5μF               |         |     |     |     |         |     |     |     |     |     |     |     |     |     |     |     |
| 2.2μF               |         |     |     |     |         |     |     |     |     |     |     |     |     |     |     |     |
| 3.3μF               |         |     |     |     |         |     |     |     |     |     |     |     |     |     |     |     |
| 4.7μF               |         |     |     |     |         |     |     |     |     |     |     |     |     |     |     |     |
| 6.8μF               |         |     |     |     |         |     |     |     |     |     |     |     |     |     |     |     |
| 10μF                |         |     |     |     |         |     |     |     |     |     |     |     |     |     |     |     |
| 15μF                |         |     |     |     |         |     |     |     |     |     |     |     |     |     |     |     |
| 22μF                |         |     |     |     |         |     |     |     |     |     |     |     |     |     |     |     |
| 33μF                |         |     |     |     |         |     |     |     |     |     |     |     |     |     |     |     |
| 47μF                |         |     |     |     |         |     |     |     |     |     |     |     |     |     |     |     |
| 100μF               |         |     |     |     |         |     |     |     |     |     |     |     |     |     |     |     |

# Capacitance Table

## GCM Series Temperature Compensating Type (3.2×1.6mm: p.24 to 25, 3.2×2.5 – 5.7×5.0mm: p.26)

p00 ← Part Number List    EIA: **COG** **U2J**    Murata Temperature Characteristic: **X8G** **ZLM**

| L×W (mm)            | 0.6×0.3 |     |      | 1.0×0.5 |     |     | 1.6×0.8 |     |     |     |     |     | 2.0×1.25 |      |     |     |     |     |     |     |      |     |     |     |     |     |     |     |     |
|---------------------|---------|-----|------|---------|-----|-----|---------|-----|-----|-----|-----|-----|----------|------|-----|-----|-----|-----|-----|-----|------|-----|-----|-----|-----|-----|-----|-----|-----|
| T max. (mm)         | 0.33    |     | 0.55 |         | 0.9 |     |         |     |     |     | 0.7 |     |          | 0.95 |     |     | 1.0 |     | 1.4 |     | 1.45 |     |     |     |     |     |     |     |     |
| Rated Voltage (Vdc) | 50      | 25  | 50   |         |     | 100 |         | 80  | 63  | 50  |     | 100 | 80       | 50   | 100 | 80  | 50  | 630 | 250 | 80  | 50   | 630 | 250 |     |     |     |     |     |     |
| Cap. / TC Code      | COG     | COG | COG  | X8G     | COG | U2J | X8G     | COG | COG | COG | U2J | X8G | COG      | COG  | X8G | X8G | ZLM | COG | COG | X8G | COG  | COG | U2J | COG | COG | X8G | COG | COG | U2J |
| 0.10pF              | p58     | p59 | p61  | p64     |     |     |         |     |     |     |     |     |          |      |     |     |     |     |     |     |      |     |     |     |     |     |     |     |     |
| 0.11pF              | p58     | p59 | p61  |         |     |     |         |     |     |     |     |     |          |      |     |     |     |     |     |     |      |     |     |     |     |     |     |     |     |
| 0.12pF              | p58     | p59 | p61  |         |     |     |         |     |     |     |     |     |          |      |     |     |     |     |     |     |      |     |     |     |     |     |     |     |     |
| 0.13pF              | p58     | p59 | p61  |         |     |     |         |     |     |     |     |     |          |      |     |     |     |     |     |     |      |     |     |     |     |     |     |     |     |
| 0.15pF              | p58     | p59 | p61  |         |     |     |         |     |     |     |     |     |          |      |     |     |     |     |     |     |      |     |     |     |     |     |     |     |     |
| 0.16pF              | p58     | p59 | p61  |         |     |     |         |     |     |     |     |     |          |      |     |     |     |     |     |     |      |     |     |     |     |     |     |     |     |
| 0.18pF              | p58     | p59 | p61  |         |     |     |         |     |     |     |     |     |          |      |     |     |     |     |     |     |      |     |     |     |     |     |     |     |     |
| 0.20pF              | p58     | p59 | p61  | p64     |     |     |         |     |     |     |     |     |          |      |     |     |     |     |     |     |      |     |     |     |     |     |     |     |     |
| 0.22pF              | p58     | p59 | p61  |         |     |     |         |     |     |     |     |     |          |      |     |     |     |     |     |     |      |     |     |     |     |     |     |     |     |
| 0.24pF              | p58     | p59 | p61  |         |     |     |         |     |     |     |     |     |          |      |     |     |     |     |     |     |      |     |     |     |     |     |     |     |     |
| 0.27pF              | p58     | p59 |      |         |     |     |         |     |     |     |     |     |          |      |     |     |     |     |     |     |      |     |     |     |     |     |     |     |     |
| 0.30pF              | p58     | p59 | p61  | p64     |     |     |         |     |     |     |     |     |          |      |     |     |     |     |     |     |      |     |     |     |     |     |     |     |     |
| 0.33pF              | p58     | p59 | p61  |         |     |     |         |     |     |     |     |     |          |      |     |     |     |     |     |     |      |     |     |     |     |     |     |     |     |
| 0.36pF              | p58     | p59 | p61  |         |     |     |         |     |     |     |     |     |          |      |     |     |     |     |     |     |      |     |     |     |     |     |     |     |     |
| 0.39pF              | p58     | p59 | p61  |         |     |     |         |     |     |     |     |     |          |      |     |     |     |     |     |     |      |     |     |     |     |     |     |     |     |
| 0.40pF              | p58     | p59 | p61  | p64     |     |     |         |     |     |     |     |     |          |      |     |     |     |     |     |     |      |     |     |     |     |     |     |     |     |
| 0.43pF              | p58     | p59 | p61  |         |     |     |         |     |     |     |     |     |          |      |     |     |     |     |     |     |      |     |     |     |     |     |     |     |     |
| 0.47pF              | p58     | p59 | p61  |         | p67 |     |         |     |     |     |     |     |          |      |     |     |     |     |     |     |      |     |     |     |     |     |     |     |     |
| 0.50pF              | p58     | p59 | p61  | p64     |     | p67 |         |     |     |     |     |     |          |      |     |     |     |     |     |     |      |     |     |     |     |     |     |     |     |
| 0.51pF              | p58     | p59 | p61  |         |     | p67 |         |     |     |     |     |     |          |      |     |     |     |     |     |     |      |     |     |     |     |     |     |     |     |
| 0.56pF              | p58     | p59 | p61  |         |     | p67 |         |     |     |     |     |     |          |      |     |     |     |     |     |     |      |     |     |     |     |     |     |     |     |
| 0.60pF              | p58     | p59 | p61  | p64     |     | p67 |         |     |     |     |     |     |          |      |     |     |     |     |     |     |      |     |     |     |     |     |     |     |     |
| 0.62pF              | p58     | p59 | p61  |         |     | p67 |         |     |     |     |     |     |          |      |     |     |     |     |     |     |      |     |     |     |     |     |     |     |     |
| 0.68pF              | p58     | p59 | p61  |         |     | p67 |         |     |     |     |     |     |          |      |     |     |     |     |     |     |      |     |     |     |     |     |     |     |     |
| 0.70pF              | p58     | p59 | p61  | p64     |     | p67 |         |     |     |     |     |     |          |      |     |     |     |     |     |     |      |     |     |     |     |     |     |     |     |
| 0.75pF              | p58     | p59 | p61  | p64     |     | p67 |         |     |     |     |     |     |          |      |     |     |     |     |     |     |      |     |     |     |     |     |     |     |     |
| 0.80pF              | p58     | p60 | p61  | p64     |     | p67 |         |     |     |     |     |     |          |      |     |     |     |     |     |     |      |     |     |     |     |     |     |     |     |
| 0.82pF              | p58     | p60 | p61  |         |     | p67 |         |     |     |     |     |     |          |      |     |     |     |     |     |     |      |     |     |     |     |     |     |     |     |
| 0.90pF              | p58     | p60 | p61  | p64     |     | p67 |         |     |     |     |     |     |          |      |     |     |     |     |     |     |      |     |     |     |     |     |     |     |     |
| 0.91pF              | p58     | p60 | p61  |         |     | p67 |         |     |     |     |     |     |          |      |     |     |     |     |     |     |      |     |     |     |     |     |     |     |     |
| 1.0pF               | p58     | p60 | p61  | p64     |     | p68 |         |     |     |     |     |     |          |      |     |     |     |     |     |     |      |     |     |     |     |     |     |     |     |
| 1.1pF               | p58     | p60 | p61  | p64     |     | p68 |         |     |     |     |     |     |          |      |     |     |     |     |     |     |      |     |     |     |     |     |     |     |     |
| 1.2pF               | p58     | p60 | p61  | p64     |     | p68 |         |     |     |     |     |     |          |      |     |     |     |     |     |     |      |     |     |     |     |     |     |     |     |
| 1.3pF               | p58     | p60 | p61  | p64     |     | p68 |         |     |     |     |     |     |          |      |     |     |     |     |     |     |      |     |     |     |     |     |     |     |     |
| 1.4pF               |         |     | p61  | p64     |     | p68 |         |     |     |     |     |     |          |      |     |     |     |     |     |     |      |     |     |     |     |     |     |     |     |
| 1.5pF               | p58     | p60 | p61  | p64     |     | p68 |         |     |     |     |     |     |          |      |     |     |     |     |     |     |      |     |     |     |     |     |     |     |     |
| 1.6pF               | p58     | p60 | p61  | p64     |     | p68 |         |     |     |     |     |     |          |      |     |     |     |     |     |     |      |     |     |     |     |     |     |     |     |
| 1.7pF               |         |     | p61  | p64     |     | p68 |         |     |     |     |     |     |          |      |     |     |     |     |     |     |      |     |     |     |     |     |     |     |     |
| 1.8pF               | p58     | p60 | p61  | p64     |     | p68 |         |     |     |     |     |     |          |      |     |     |     |     |     |     |      |     |     |     |     |     |     |     |     |
| 1.9pF               |         |     | p61  | p64     |     | p68 |         |     |     |     |     |     |          |      |     |     |     |     |     |     |      |     |     |     |     |     |     |     |     |
| 2.0pF               | p58     | p60 | p61  | p64     |     | p68 |         |     |     |     |     |     |          |      |     |     |     |     |     |     |      |     |     |     |     |     |     |     |     |
| 2.1pF               |         |     | p61  | p64     |     | p68 |         |     |     |     |     |     |          |      |     |     |     |     |     |     |      |     |     |     |     |     |     |     |     |
| 2.2pF               | p58     | p60 | p61  | p64     |     | p68 |         |     |     |     |     |     |          |      |     |     |     |     |     |     |      |     |     |     |     |     |     |     |     |
| 2.3pF               |         |     | p61  | p64     |     | p68 |         |     |     |     |     |     |          |      |     |     |     |     |     |     |      |     |     |     |     |     |     |     |     |
| 2.4pF               | p58     | p60 | p61  | p64     |     | p68 |         |     |     |     |     |     |          |      |     |     |     |     |     |     |      |     |     |     |     |     |     |     |     |
| 2.5pF               |         |     | p61  | p64     |     | p68 |         |     |     |     |     |     |          |      |     |     |     |     |     |     |      |     |     |     |     |     |     |     |     |
| 2.6pF               |         |     | p61  | p64     |     | p68 |         |     |     |     |     |     |          |      |     |     |     |     |     |     |      |     |     |     |     |     |     |     |     |
| 2.7pF               | p58     | p60 | p61  | p65     |     | p68 |         |     |     |     |     |     |          |      |     |     |     |     |     |     |      |     |     |     |     |     |     |     |     |
| 2.8pF               |         |     | p61  | p65     |     | p68 |         |     |     |     |     |     |          |      |     |     |     |     |     |     |      |     |     |     |     |     |     |     |     |
| 2.9pF               |         |     | p61  | p65     |     | p68 |         |     |     |     |     |     |          |      |     |     |     |     |     |     |      |     |     |     |     |     |     |     |     |
| 3.0pF               | p58     | p60 | p61  | p65     |     | p68 |         |     |     |     |     |     |          |      |     |     |     |     |     |     |      |     |     |     |     |     |     |     |     |
| 3.1pF               |         |     | p61  | p65     |     | p68 |         |     |     |     |     |     |          |      |     |     |     |     |     |     |      |     |     |     |     |     |     |     |     |
| 3.2pF               |         |     | p61  | p65     |     | p68 |         |     |     |     |     |     |          |      |     |     |     |     |     |     |      |     |     |     |     |     |     |     |     |
| 3.3pF               | p58     | p60 | p61  | p65     |     | p68 |         |     |     |     |     |     |          |      |     |     |     |     |     |     |      |     |     |     |     |     |     |     |     |
| 3.4pF               |         |     | p62  | p65     |     | p68 |         |     |     |     |     |     |          |      |     |     |     |     |     |     |      |     |     |     |     |     |     |     |     |

↓ Continued on the following page.

# Capacitance Table

(→ GCM Series Temperature Compensating Type) (3.2×1.6mm: p.24 to 25, 3.2×2.5 – 5.7×5.0mm: p.26)

p00 ← Part Number List    EIA: **COG** **U2J**    Murata Temperature Characteristic: **X8G** **ZLM**

| L×W (mm)            | 0.6×0.3     |     | 1.0×0.5 |     | 1.6×0.8 |     |     |     |     |     |     |     | 2.0×1.25 |     |     |     |     |      |     |     |     |     |     |     |      |     |     |     |     |     |     |     |     |
|---------------------|-------------|-----|---------|-----|---------|-----|-----|-----|-----|-----|-----|-----|----------|-----|-----|-----|-----|------|-----|-----|-----|-----|-----|-----|------|-----|-----|-----|-----|-----|-----|-----|-----|
|                     | T max. (mm) |     | 0.33    |     | 0.55    |     | 0.9 |     |     |     |     |     |          |     | 0.7 |     |     | 0.95 |     |     | 1.0 |     | 1.4 |     | 1.45 |     |     |     |     |     |     |     |     |
| Rated Voltage (Vdc) | 50          | 25  | 50      |     | 100     |     | 80  | 63  | 50  |     | X8G | COG | COG      | COG | U2J | X8G | COG | COG  | X8G | X8G | ZLM | COG | COG | X8G | COG  | COG | U2J | COG | COG | X8G | COG | COG | U2J |
| Cap. / TC Code      | COG         | COG | COG     | X8G | COG     | U2J | X8G | COG | COG | COG | U2J | X8G | COG      | COG | X8G | X8G | ZLM | COG  | COG | X8G | COG | COG | U2J | COG | COG  | X8G | COG | COG | U2J | COG | COG | U2J |     |
| 3.5pF               |             |     | p62     | p65 | p68     |     |     |     |     |     |     |     |          |     |     |     |     |      |     |     |     |     |     |     |      |     |     |     |     |     |     |     |     |
| 3.6pF               | p58         | p60 | p62     | p65 | p68     |     |     |     |     |     |     |     |          |     |     |     |     |      |     |     |     |     |     |     |      |     |     |     |     |     |     |     |     |
| 3.7pF               |             |     | p62     | p65 | p68     |     |     |     |     |     |     |     |          |     |     |     |     |      |     |     |     |     |     |     |      |     |     |     |     |     |     |     |     |
| 3.8pF               |             |     | p62     | p65 | p68     |     |     |     |     |     |     |     |          |     |     |     |     |      |     |     |     |     |     |     |      |     |     |     |     |     |     |     |     |
| 3.9pF               | p58         | p60 | p62     | p65 | p68     |     |     |     |     |     |     |     |          |     |     |     |     |      |     |     |     |     |     |     |      |     |     |     |     |     |     |     |     |
| 4.0pF               | p58         | p60 | p62     | p65 | p68     |     |     |     |     |     |     |     |          |     |     |     |     |      |     |     |     |     |     |     |      |     |     |     |     |     |     |     |     |
| 4.1pF               |             |     | p62     | p65 | p68     |     |     |     |     |     |     |     |          |     |     |     |     |      |     |     |     |     |     |     |      |     |     |     |     |     |     |     |     |
| 4.2pF               |             |     | p62     | p65 | p68     |     |     |     |     |     |     |     |          |     |     |     |     |      |     |     |     |     |     |     |      |     |     |     |     |     |     |     |     |
| 4.3pF               | p58         | p60 | p62     | p65 | p68     |     |     |     |     |     |     |     |          |     |     |     |     |      |     |     |     |     |     |     |      |     |     |     |     |     |     |     |     |
| 4.4pF               |             |     | p62     | p65 | p68     |     |     |     |     |     |     |     |          |     |     |     |     |      |     |     |     |     |     |     |      |     |     |     |     |     |     |     |     |
| 4.5pF               |             |     | p62     | p65 | p68     |     |     |     |     |     |     |     |          |     |     |     |     |      |     |     |     |     |     |     |      |     |     |     |     |     |     |     |     |
| 4.6pF               |             |     | p62     | p65 | p68     |     |     |     |     |     |     |     |          |     |     |     |     |      |     |     |     |     |     |     |      |     |     |     |     |     |     |     |     |
| 4.7pF               | p58         | p60 | p62     | p65 | p68     |     |     |     |     |     |     |     |          |     |     |     |     |      |     |     |     |     |     |     |      |     |     |     |     |     |     |     |     |
| 4.8pF               |             |     | p62     | p65 | p68     |     |     |     |     |     |     |     |          |     |     |     |     |      |     |     |     |     |     |     |      |     |     |     |     |     |     |     |     |
| 4.9pF               |             |     | p62     | p65 | p68     |     |     |     |     |     |     |     |          |     |     |     |     |      |     |     |     |     |     |     |      |     |     |     |     |     |     |     |     |
| 5.0pF               | p58         | p60 | p62     | p65 | p68     |     |     |     |     |     |     |     |          |     |     |     |     |      |     |     |     |     |     |     |      |     |     |     |     |     |     |     |     |
| 5.1pF               | p58         | p60 | p62     | p65 | p68     |     |     |     |     |     |     |     |          |     |     |     |     |      |     |     |     |     |     |     |      |     |     |     |     |     |     |     |     |
| 5.2pF               |             |     | p62     | p65 | p68     |     |     |     |     |     |     |     |          |     |     |     |     |      |     |     |     |     |     |     |      |     |     |     |     |     |     |     |     |
| 5.3pF               |             |     | p62     | p65 | p68     |     |     |     |     |     |     |     |          |     |     |     |     |      |     |     |     |     |     |     |      |     |     |     |     |     |     |     |     |
| 5.4pF               |             |     | p62     | p65 | p68     |     |     |     |     |     |     |     |          |     |     |     |     |      |     |     |     |     |     |     |      |     |     |     |     |     |     |     |     |
| 5.5pF               |             |     | p62     | p65 | p68     |     |     |     |     |     |     |     |          |     |     |     |     |      |     |     |     |     |     |     |      |     |     |     |     |     |     |     |     |
| 5.6pF               | p58         | p60 | p62     | p65 | p69     |     |     |     |     |     |     |     |          |     |     |     |     |      |     |     |     |     |     |     |      |     |     |     |     |     |     |     |     |
| 5.7pF               |             |     | p62     | p65 | p69     |     |     |     |     |     |     |     |          |     |     |     |     |      |     |     |     |     |     |     |      |     |     |     |     |     |     |     |     |
| 5.8pF               |             |     | p62     | p65 | p69     |     |     |     |     |     |     |     |          |     |     |     |     |      |     |     |     |     |     |     |      |     |     |     |     |     |     |     |     |
| 5.9pF               |             |     | p62     | p65 | p69     |     |     |     |     |     |     |     |          |     |     |     |     |      |     |     |     |     |     |     |      |     |     |     |     |     |     |     |     |
| 6.0pF               | p58         | p60 | p62     | p65 | p69     |     |     |     |     |     |     |     |          |     |     |     |     |      |     |     |     |     |     |     |      |     |     |     |     |     |     |     |     |
| 6.1pF               |             |     | p62     | p65 | p69     |     |     |     |     |     |     |     |          |     |     |     |     |      |     |     |     |     |     |     |      |     |     |     |     |     |     |     |     |
| 6.2pF               | p58         | p60 | p62     | p65 | p69     |     |     |     |     |     |     |     |          |     |     |     |     |      |     |     |     |     |     |     |      |     |     |     |     |     |     |     |     |
| 6.3pF               |             |     | p62     | p65 | p69     |     |     |     |     |     |     |     |          |     |     |     |     |      |     |     |     |     |     |     |      |     |     |     |     |     |     |     |     |
| 6.4pF               |             |     | p62     | p65 | p69     |     |     |     |     |     |     |     |          |     |     |     |     |      |     |     |     |     |     |     |      |     |     |     |     |     |     |     |     |
| 6.5pF               |             |     | p62     | p65 | p69     |     |     |     |     |     |     |     |          |     |     |     |     |      |     |     |     |     |     |     |      |     |     |     |     |     |     |     |     |
| 6.6pF               |             |     | p62     | p65 | p69     |     |     |     |     |     |     |     |          |     |     |     |     |      |     |     |     |     |     |     |      |     |     |     |     |     |     |     |     |
| 6.7pF               |             |     | p62     | p65 | p69     |     |     |     |     |     |     |     |          |     |     |     |     |      |     |     |     |     |     |     |      |     |     |     |     |     |     |     |     |
| 6.8pF               | p58         | p60 | p62     | p65 | p69     |     |     |     |     |     |     |     |          |     |     |     |     |      |     |     |     |     |     |     |      |     |     |     |     |     |     |     |     |
| 6.9pF               |             |     | p62     | p65 | p69     |     |     |     |     |     |     |     |          |     |     |     |     |      |     |     |     |     |     |     |      |     |     |     |     |     |     |     |     |
| 7.0pF               | p58         | p60 | p62     | p65 | p69     |     |     |     |     |     |     |     |          |     |     |     |     |      |     |     |     |     |     |     |      |     |     |     |     |     |     |     |     |
| 7.1pF               |             |     | p62     | p65 | p69     |     |     |     |     |     |     |     |          |     |     |     |     |      |     |     |     |     |     |     |      |     |     |     |     |     |     |     |     |
| 7.2pF               |             |     | p62     | p65 | p69     |     |     |     |     |     |     |     |          |     |     |     |     |      |     |     |     |     |     |     |      |     |     |     |     |     |     |     |     |
| 7.3pF               |             |     | p62     | p65 | p69     |     |     |     |     |     |     |     |          |     |     |     |     |      |     |     |     |     |     |     |      |     |     |     |     |     |     |     |     |
| 7.4pF               |             |     | p62     | p65 | p69     |     |     |     |     |     |     |     |          |     |     |     |     |      |     |     |     |     |     |     |      |     |     |     |     |     |     |     |     |
| 7.5pF               | p58         | p60 | p62     | p65 | p69     |     |     |     |     |     |     |     |          |     |     |     |     |      |     |     |     |     |     |     |      |     |     |     |     |     |     |     |     |
| 7.6pF               |             |     | p62     | p65 | p69     |     |     |     |     |     |     |     |          |     |     |     |     |      |     |     |     |     |     |     |      |     |     |     |     |     |     |     |     |
| 7.7pF               |             |     | p62     | p65 | p69     |     |     |     |     |     |     |     |          |     |     |     |     |      |     |     |     |     |     |     |      |     |     |     |     |     |     |     |     |
| 7.8pF               |             |     | p62     | p65 | p69     |     |     |     |     |     |     |     |          |     |     |     |     |      |     |     |     |     |     |     |      |     |     |     |     |     |     |     |     |
| 7.9pF               |             |     | p62     | p65 | p69     |     |     |     |     |     |     |     |          |     |     |     |     |      |     |     |     |     |     |     |      |     |     |     |     |     |     |     |     |
| 8.0pF               | p58         | p60 | p62     | p65 | p69     |     |     |     |     |     |     |     |          |     |     |     |     |      |     |     |     |     |     |     |      |     |     |     |     |     |     |     |     |
| 8.1pF               |             |     | p62     | p66 | p69     |     |     |     |     |     |     |     |          |     |     |     |     |      |     |     |     |     |     |     |      |     |     |     |     |     |     |     |     |
| 8.2pF               | p58         | p60 | p62     | p66 | p69     |     |     |     |     |     |     |     |          |     |     |     |     |      |     |     |     |     |     |     |      |     |     |     |     |     |     |     |     |
| 8.3pF               |             |     | p62     | p66 | p69     |     |     |     |     |     |     |     |          |     |     |     |     |      |     |     |     |     |     |     |      |     |     |     |     |     |     |     |     |
| 8.4pF               |             |     | p62     | p66 | p69     |     |     |     |     |     |     |     |          |     |     |     |     |      |     |     |     |     |     |     |      |     |     |     |     |     |     |     |     |
| 8.5pF               |             |     | p62     | p66 | p69     |     |     |     |     |     |     |     |          |     |     |     |     |      |     |     |     |     |     |     |      |     |     |     |     |     |     |     |     |
| 8.6pF               |             |     | p62     | p66 | p69     |     |     |     |     |     |     |     |          |     |     |     |     |      |     |     |     |     |     |     |      |     |     |     |     |     |     |     |     |
| 8.7pF               |             |     | p62     | p66 | p69     |     |     |     |     |     |     |     |          |     |     |     |     |      |     |     |     |     |     |     |      |     |     |     |     |     |     |     |     |
| 8.8pF               |             |     | p62     | p66 | p69     |     |     |     |     |     |     |     |          |     |     |     |     |      |     |     |     |     |     |     |      |     |     |     |     |     |     |     |     |
| 8.9pF               |             |     | p62     | p66 | p69     |     |     |     |     |     |     |     |          |     |     |     |     |      |     |     |     |     |     |     |      |     |     |     |     |     |     |     |     |

↓ Continued on the following page.

# Capacitance Table

(→ GCM Series Temperature Compensating Type) ( 3.2×1.6mm: p.24 to 25, 3.2×2.5 – 5.7×5.0mm: p.26)

p00 ← Part Number List      EIA: **COG** **U2J**      Murata Temperature Characteristic: **X8G** **ZLM**

| L×W (mm)       | 0.6×0.3             |     | 1.0×0.5 |     | 1.6×0.8 |     |     |     |     |     | 2.0×1.25 |     |     |     |     |      |     |     |     |     |     |     |      |     |     |     |     |     |     |
|----------------|---------------------|-----|---------|-----|---------|-----|-----|-----|-----|-----|----------|-----|-----|-----|-----|------|-----|-----|-----|-----|-----|-----|------|-----|-----|-----|-----|-----|-----|
|                | T max. (mm)         |     | 0.33    |     | 0.55    |     | 0.9 |     |     |     |          |     | 0.7 |     |     | 0.95 |     |     | 1.0 |     | 1.4 |     | 1.45 |     |     |     |     |     |     |
|                | Rated Voltage (Vdc) |     | 50      | 25  | 50      |     | 100 |     | 80  | 63  | 50       |     | 100 | 80  | 50  | 100  | 80  | 50  | 630 | 250 | 80  | 50  | 630  | 250 |     |     |     |     |     |
| Cap. / TC Code | COG                 | COG | COG     | X8G | COG     | U2J | X8G | COG | COG | COG | U2J      | X8G | COG | COG | X8G | X8G  | ZLM | COG | COG | X8G | COG | COG | U2J  | COG | COG | X8G | COG | COG | U2J |
| 9.0pF          | p58                 | p60 | p62     | p66 | p69     |     |     |     |     |     |          |     |     |     |     |      |     |     |     |     |     |     |      |     |     |     |     |     |     |
| 9.1pF          | p58                 | p60 | p63     | p66 | p69     |     |     |     |     |     |          |     |     |     |     |      |     |     |     |     |     |     |      |     |     |     |     |     |     |
| 9.2pF          |                     |     | p63     | p66 | p70     |     |     |     |     |     |          |     |     |     |     |      |     |     |     |     |     |     |      |     |     |     |     |     |     |
| 9.3pF          |                     |     | p63     | p66 | p70     |     |     |     |     |     |          |     |     |     |     |      |     |     |     |     |     |     |      |     |     |     |     |     |     |
| 9.4pF          |                     |     | p63     | p66 | p70     |     |     |     |     |     |          |     |     |     |     |      |     |     |     |     |     |     |      |     |     |     |     |     |     |
| 9.5pF          |                     |     | p63     | p66 | p70     |     |     |     |     |     |          |     |     |     |     |      |     |     |     |     |     |     |      |     |     |     |     |     |     |
| 9.6pF          |                     |     | p63     | p66 | p70     |     |     |     |     |     |          |     |     |     |     |      |     |     |     |     |     |     |      |     |     |     |     |     |     |
| 9.7pF          |                     |     | p63     | p66 | p70     |     |     |     |     |     |          |     |     |     |     |      |     |     |     |     |     |     |      |     |     |     |     |     |     |
| 9.8pF          |                     |     | p63     | p66 | p70     |     |     |     |     |     |          |     |     |     |     |      |     |     |     |     |     |     |      |     |     |     |     |     |     |
| 9.9pF          |                     |     | p63     | p66 | p70     |     |     |     |     |     |          |     |     |     |     |      |     |     |     |     |     |     |      |     |     |     |     |     |     |
| 10pF           | p58                 | p60 | p63     | p66 | p70     | p71 |     |     |     |     |          |     |     |     |     |      |     |     |     |     |     |     | p75  | p76 |     |     |     |     |     |
| 11pF           | p58                 | p60 | p63     | p66 | p70     | p71 |     |     |     |     |          |     |     |     |     |      |     |     |     |     |     |     |      |     |     |     |     |     |     |
| 12pF           | p58                 | p60 | p63     | p66 | p70     | p71 |     |     |     |     |          |     |     |     |     |      |     |     |     |     |     |     | p75  | p76 |     |     |     |     |     |
| 13pF           | p58                 | p60 | p63     | p66 | p70     | p71 |     |     |     |     |          |     |     |     |     |      |     |     |     |     |     |     |      |     |     |     |     |     |     |
| 15pF           | p58                 | p60 | p63     | p66 | p70     | p72 |     |     |     |     |          |     |     |     |     |      |     |     |     |     |     |     | p75  | p76 |     |     |     |     |     |
| 16pF           | p58                 | p60 | p63     | p66 | p70     | p72 |     |     |     |     |          |     |     |     |     |      |     |     |     |     |     |     |      |     |     |     |     |     |     |
| 18pF           | p59                 | p60 | p63     | p66 | p70     | p72 |     |     |     |     |          |     |     |     |     |      |     |     |     |     |     |     | p75  | p76 |     |     |     |     |     |
| 20pF           | p59                 | p60 | p63     | p66 | p70     | p72 |     |     |     |     |          |     |     |     |     |      |     |     |     |     |     |     |      |     |     |     |     |     |     |
| 22pF           | p59                 | p60 | p63     | p66 | p70     | p72 |     |     |     |     |          |     |     |     |     |      |     |     |     |     |     |     | p75  | p76 |     |     |     |     |     |
| 24pF           | p59                 | p60 | p63     | p66 | p70     | p72 |     |     |     |     |          |     |     |     |     |      |     |     |     |     |     |     |      |     |     |     |     |     |     |
| 27pF           | p59                 | p60 | p63     | p66 | p70     | p72 |     |     |     |     |          |     |     |     |     |      |     |     |     |     |     |     | p75  | p76 |     |     |     |     |     |
| 30pF           | p59                 | p60 | p63     | p66 | p70     | p72 |     |     |     |     |          |     |     |     |     |      |     |     |     |     |     |     |      |     |     |     |     |     |     |
| 33pF           | p59                 | p60 | p63     | p66 | p70     | p72 |     |     |     |     |          |     |     |     |     |      |     |     |     |     |     |     | p76  | p76 |     |     |     |     |     |
| 36pF           | p59                 | p60 | p63     | p66 | p70     | p72 |     |     |     |     |          |     |     |     |     |      |     |     |     |     |     |     |      |     |     |     |     |     |     |
| 39pF           | p59                 | p60 | p63     | p66 | p70     | p72 |     |     |     |     |          |     |     |     |     |      |     |     |     |     |     |     | p76  | p76 |     |     |     |     |     |
| 43pF           | p59                 | p60 | p63     | p66 | p70     | p72 |     |     |     |     |          |     |     |     |     |      |     |     |     |     |     |     |      |     |     |     |     |     |     |
| 47pF           | p59                 | p60 | p63     | p66 | p70     | p72 |     |     |     |     |          |     |     |     |     |      |     |     |     |     |     |     | p76  | p76 |     |     |     |     |     |
| 51pF           | p59                 | p60 | p63     | p66 | p70     | p72 |     |     |     |     |          |     |     |     |     |      |     |     |     |     |     |     |      |     |     |     |     |     |     |
| 56pF           | p59                 | p60 | p63     | p66 | p70     | p72 |     |     |     |     |          |     |     |     |     |      |     |     |     |     |     |     | p76  | p76 |     |     |     |     |     |
| 62pF           | p59                 | p60 | p63     | p66 | p70     | p72 |     |     |     |     |          |     |     |     |     |      |     |     |     |     |     |     |      |     |     |     |     |     |     |
| 68pF           | p59                 | p60 | p63     | p66 | p70     | p72 |     |     |     |     |          |     |     |     |     |      |     |     |     |     |     |     | p76  | p76 |     |     |     |     |     |
| 75pF           | p59                 | p60 | p63     | p66 | p70     | p72 |     |     |     |     |          |     |     |     |     |      |     |     |     |     |     |     |      |     |     |     |     |     |     |
| 82pF           | p59                 | p61 | p63     | p66 | p70     | p72 |     |     |     |     |          |     |     |     |     |      |     |     |     |     |     |     | p76  | p76 |     |     |     |     |     |
| 91pF           | p59                 | p61 | p63     | p67 | p70     | p72 |     |     |     |     |          |     |     |     |     |      |     |     |     |     |     |     |      |     |     |     |     |     |     |
| 100pF          | p59                 | p61 | p63     | p67 | p70     | p72 |     |     |     |     |          |     |     |     |     |      |     |     |     |     |     |     | p76  | p76 | p77 |     |     |     |     |
| 110pF          |                     |     | p63     | p67 | p70     | p72 |     |     |     |     |          |     |     |     |     |      |     |     |     |     |     |     |      |     |     |     |     |     |     |
| 120pF          |                     |     | p63     | p67 | p70     | p72 |     |     |     |     |          |     |     |     |     |      |     |     |     |     |     |     | p76  | p76 | p77 |     |     |     |     |
| 130pF          |                     |     | p63     | p67 | p70     | p72 |     |     |     |     |          |     |     |     |     |      |     |     |     |     |     |     |      |     |     |     |     |     |     |
| 150pF          |                     |     | p63     | p67 | p71     | p72 |     |     |     |     |          |     |     |     |     |      |     |     |     |     |     |     | p76  | p76 | p77 |     |     |     |     |
| 160pF          |                     |     | p63     | p67 | p71     | p72 |     |     |     |     |          |     |     |     |     |      |     |     |     |     |     |     |      |     |     |     |     |     |     |
| 180pF          |                     |     | p63     | p67 | p71     | p72 |     |     |     |     |          |     |     |     |     |      |     |     |     |     |     |     | p76  | p76 | p77 |     |     |     |     |
| 200pF          |                     |     | p64     | p67 | p71     | p72 |     |     |     |     |          |     |     |     |     |      |     |     |     |     |     |     |      |     |     |     |     |     |     |
| 220pF          |                     |     | p64     | p67 | p71     | p72 |     |     |     |     |          |     |     |     |     |      |     |     |     |     |     |     | p76  | p76 | p77 |     |     |     |     |
| 240pF          |                     |     | p64     | p67 | p71     | p72 |     |     |     |     |          |     |     |     |     |      |     |     |     |     |     |     |      |     |     |     |     |     |     |
| 270pF          |                     |     | p64     | p67 | p71     | p72 |     |     |     |     |          |     |     |     |     |      |     |     |     |     |     |     | p76  | p76 | p77 |     |     |     |     |
| 300pF          |                     |     | p64     | p67 | p71     | p72 |     |     |     |     |          |     |     |     |     |      |     |     |     |     |     |     |      |     |     |     |     |     |     |
| 330pF          |                     |     | p64     | p67 | p71     | p72 |     |     |     |     |          |     |     |     |     |      |     |     |     |     |     |     | p76  | p76 | p77 |     |     |     |     |
| 360pF          |                     |     | p64     | p67 | p71     | p72 |     |     |     |     |          |     |     |     |     |      |     |     |     |     |     |     |      |     |     |     |     |     |     |
| 390pF          |                     |     | p64     | p67 | p71     | p72 |     |     |     |     |          |     |     |     |     |      |     |     |     |     |     |     | p76  | p76 | p77 |     |     |     |     |
| 430pF          |                     |     | p64     | p67 | p71     | p72 |     |     |     |     |          |     |     |     |     |      |     |     |     |     |     |     |      |     |     |     |     |     |     |
| 470pF          |                     |     | p64     | p67 | p71     | p73 |     |     |     |     |          |     |     |     |     |      |     |     |     |     |     |     | p76  | p77 | p77 |     |     |     |     |
| 510pF          |                     |     | p64     | p67 | p71     | p73 |     |     |     |     |          |     |     |     |     |      |     |     |     |     |     |     |      |     |     |     |     |     |     |
| 560pF          |                     |     | p64     | p67 | p71     | p73 |     |     |     |     |          |     |     |     |     |      |     |     |     |     |     |     | p76  | p77 | p77 |     |     |     |     |
| 620pF          |                     |     | p64     | p67 | p71     | p73 |     |     |     |     |          |     |     |     |     |      |     |     |     |     |     |     |      |     |     |     |     |     |     |
| 680pF          |                     |     | p64     | p67 | p71     | p73 |     |     |     |     |          |     |     |     |     |      |     |     |     |     |     |     |      | p77 | p77 |     |     | p77 |     |

↓ Continued on the following page.

# Capacitance Table

(→ GCM Series Temperature Compensating Type) (3.2×1.6mm: p.24 to 25, 3.2×2.5 – 5.7×5.0mm: p.26)

p00 ← Part Number List    EIA: **COG** **U2J**    Murata Temperature Characteristic: **X8G** **ZLM**

| L×W (mm)            | 0.6×0.3     |     | 1.0×0.5 |     | 1.6×0.8 |     |     |     |     |     | 2.0×1.25 |     |     |     |     |      |     |     |     |     |     |     |      |     |     |     |     |     |
|---------------------|-------------|-----|---------|-----|---------|-----|-----|-----|-----|-----|----------|-----|-----|-----|-----|------|-----|-----|-----|-----|-----|-----|------|-----|-----|-----|-----|-----|
|                     | T max. (mm) |     | 0.33    |     | 0.55    |     | 0.9 |     |     |     |          |     | 0.7 |     |     | 0.95 |     |     | 1.0 |     | 1.4 |     | 1.45 |     |     |     |     |     |
| Rated Voltage (Vdc) | 50          | 25  | 50      |     | 100     |     | 80  | 63  | 50  |     | 100      | 80  | 50  | 100 | 80  | 50   | 630 | 250 | 80  | 50  | 630 | 250 |      |     |     |     |     |     |
| Cap. / TC Code      | COG         | COG | COG     | X8G | COG     | U2J | X8G | COG | COG | U2J | X8G      | COG | COG | X8G | X8G | ZLM  | COG | COG | X8G | COG | COG | U2J | COG  | COG | X8G | COG | COG | U2J |
| 750pF               |             |     | p64     | p67 | p71     |     | p73 |     |     |     |          |     |     |     |     |      |     |     |     |     |     |     |      |     |     |     |     |     |
| 820pF               |             |     | p64     | p67 | p71     |     | p73 |     |     |     |          |     |     |     |     |      |     |     | p77 | p77 |     |     |      |     |     | p77 |     |     |
| 910pF               |             |     | p64     | p67 | p71     |     | p73 |     |     |     |          |     |     |     |     |      |     |     |     |     |     |     |      |     |     |     |     |     |
| 1000pF              |             |     | p64     | p67 | p71     | p71 | p73 |     |     |     | p74      |     |     |     |     | p75  |     |     |     | p77 | p77 |     |      |     |     | p77 |     |     |
| 1100pF              |             |     |         |     |         | p71 |     |     |     | p73 | p74      | p74 |     |     |     | p75  | p75 |     |     |     |     |     |      |     |     |     |     |     |
| 1200pF              |             |     |         |     | p71     | p71 |     |     |     | p73 | p74      | p74 |     |     |     | p75  | p75 |     |     | p77 | p77 |     |      |     |     | p77 |     |     |
| 1300pF              |             |     |         |     | p71     | p71 |     |     |     | p73 | p74      | p74 |     |     |     | p75  | p75 |     |     |     |     |     |      |     |     |     |     |     |
| 1500pF              |             |     |         |     | p71     | p71 |     |     |     | p73 | p74      | p74 |     |     |     | p75  | p75 |     |     | p77 | p77 |     |      |     |     | p77 |     |     |
| 1600pF              |             |     |         |     |         | p71 |     | p73 | p73 | p73 | p74      | p74 | p74 |     |     |      |     |     |     |     |     |     |      |     |     |     |     |     |
| 1800pF              |             |     |         |     |         | p71 |     | p73 | p73 | p73 | p74      | p74 | p74 |     |     |      |     |     |     | p77 | p77 |     |      |     |     | p77 |     |     |
| 2000pF              |             |     |         |     |         | p71 |     | p73 | p73 | p73 | p74      | p74 | p74 |     |     |      |     |     |     |     |     |     |      |     |     |     |     |     |
| 2200pF              |             |     |         |     |         | p71 |     | p73 | p73 | p73 | p74      | p74 | p74 |     |     |      |     |     |     | p77 | p77 |     |      |     |     | p77 |     |     |
| 2400pF              |             |     |         |     |         | p71 |     | p73 | p73 | p73 | p74      | p74 | p74 |     |     |      |     |     |     |     |     |     |      |     |     |     |     |     |
| 2700pF              |             |     |         |     |         | p71 |     | p73 | p73 | p73 | p74      | p74 | p74 |     |     |      |     |     |     | p77 |     |     |      |     |     |     |     | p78 |
| 3000pF              |             |     |         |     |         | p71 |     | p73 | p73 | p73 | p74      |     | p74 |     |     | p75  |     |     |     |     |     |     |      |     |     |     |     |     |
| 3300pF              |             |     |         |     |         | p71 |     | p73 | p73 | p73 | p74      |     | p74 |     |     | p75  |     |     |     |     |     |     |      |     |     |     | p77 | p78 |
| 3600pF              |             |     |         |     |         | p71 |     | p73 | p73 | p73 | p74      |     |     |     |     | p75  |     |     |     |     |     |     |      |     |     |     |     |     |
| 3900pF              |             |     |         |     |         | p71 |     | p73 | p73 | p73 | p74      |     |     |     |     | p75  |     |     |     |     |     |     |      |     |     |     | p77 | p78 |
| 4300pF              |             |     |         |     |         | p71 |     |     |     | p74 | p74      |     |     | p74 | p75 |      |     |     |     | p75 |     |     |      |     |     |     |     |     |
| 4700pF              |             |     |         |     |         | p71 |     |     |     | p74 | p74      |     |     | p75 | p75 |      |     |     |     |     |     |     |      |     |     |     | p77 | p78 |
| 5100pF              |             |     |         |     |         | p71 |     |     |     | p74 | p74      |     |     |     |     |      | p75 |     |     | p75 |     |     |      |     |     |     |     |     |
| 5600pF              |             |     |         |     |         | p71 |     |     |     | p74 | p74      |     |     |     |     |      | p75 |     |     | p75 |     |     |      |     |     |     | p78 | p78 |
| 6200pF              |             |     |         |     |         | p71 |     |     |     | p74 | p74      |     |     |     |     |      | p75 |     |     | p75 |     |     |      |     |     |     | p77 |     |
| 6800pF              |             |     |         |     |         | p71 |     |     |     | p74 | p74      |     |     |     |     |      | p75 |     |     | p75 |     |     |      |     |     |     | p77 | p78 |
| 7500pF              |             |     |         |     |         | p71 |     |     |     | p74 | p74      |     |     |     |     |      | p75 |     |     | p75 |     |     |      |     |     |     | p77 |     |
| 8200pF              |             |     |         |     |         | p71 |     |     |     | p74 | p74      |     |     |     |     |      | p75 |     |     | p75 |     |     |      |     |     |     | p77 | p78 |
| 9100pF              |             |     |         |     |         | p71 |     |     |     | p74 | p74      |     |     |     |     |      | p75 |     |     | p75 |     |     |      |     |     |     | p77 |     |
| 10000pF             |             |     |         |     |         | p71 |     |     |     | p74 | p74      |     |     |     |     |      | p75 |     |     | p75 |     |     |      |     |     |     | p77 | p78 |
| 11000pF             |             |     |         |     |         |     |     |     |     |     |          |     |     |     |     |      | p75 |     |     |     |     |     |      |     |     |     |     |     |
| 12000pF             |             |     |         |     |         |     |     |     |     |     |          |     |     |     |     |      | p75 | p75 |     |     |     |     |      |     |     |     |     |     |
| 13000pF             |             |     |         |     |         |     |     |     |     |     |          |     |     |     |     |      | p75 | p75 |     |     |     |     |      |     |     |     |     |     |
| 15000pF             |             |     |         |     |         |     |     |     |     |     |          |     |     |     |     |      | p75 | p75 |     |     |     |     |      |     |     |     |     |     |
| 16000pF             |             |     |         |     |         |     |     |     |     |     |          |     |     |     |     |      |     |     |     |     |     |     |      |     |     |     |     |     |
| 18000pF             |             |     |         |     |         |     |     |     |     |     |          |     |     |     |     |      |     |     |     |     |     |     |      |     |     |     | p77 | p77 |
| 20000pF             |             |     |         |     |         |     |     |     |     |     |          |     |     |     |     |      |     |     |     |     |     |     |      |     |     |     | p77 | p77 |
| 22000pF             |             |     |         |     |         |     |     |     |     |     |          |     |     |     |     |      |     |     |     |     |     |     |      |     |     |     | p77 | p77 |
| 27000pF             |             |     |         |     |         |     |     |     |     |     |          |     |     |     |     |      |     |     |     |     |     |     |      |     |     |     |     |     |
| 33000pF             |             |     |         |     |         |     |     |     |     |     |          |     |     |     |     |      |     |     |     |     |     |     |      |     |     |     |     |     |
| 39000pF             |             |     |         |     |         |     |     |     |     |     |          |     |     |     |     |      |     |     |     |     |     |     |      |     |     |     |     |     |
| 43000pF             |             |     |         |     |         |     |     |     |     |     |          |     |     |     |     |      |     |     |     |     |     |     |      |     |     |     |     |     |
| 47000pF             |             |     |         |     |         |     |     |     |     |     |          |     |     |     |     |      |     |     |     |     |     |     |      |     |     |     |     |     |
| 51000pF             |             |     |         |     |         |     |     |     |     |     |          |     |     |     |     |      |     |     |     |     |     |     |      |     |     |     |     |     |
| 56000pF             |             |     |         |     |         |     |     |     |     |     |          |     |     |     |     |      |     |     |     |     |     |     |      |     |     |     |     |     |
| 62000pF             |             |     |         |     |         |     |     |     |     |     |          |     |     |     |     |      |     |     |     |     |     |     |      |     |     |     |     |     |
| 68000pF             |             |     |         |     |         |     |     |     |     |     |          |     |     |     |     |      |     |     |     |     |     |     |      |     |     |     |     |     |
| 75000pF             |             |     |         |     |         |     |     |     |     |     |          |     |     |     |     |      |     |     |     |     |     |     |      |     |     |     |     |     |
| 82000pF             |             |     |         |     |         |     |     |     |     |     |          |     |     |     |     |      |     |     |     |     |     |     |      |     |     |     |     |     |
| 91000pF             |             |     |         |     |         |     |     |     |     |     |          |     |     |     |     |      |     |     |     |     |     |     |      |     |     |     |     |     |
| 0.10μF              |             |     |         |     |         |     |     |     |     |     |          |     |     |     |     |      |     |     |     |     |     |     |      |     |     |     |     |     |

Continued on the following page. ↗

# Capacitance Table

(→ GCM Series Temperature Compensating Type) (0.6×0.3 – 2.0×1.25mm: p.20 to 23, 3.2×2.5 – 5.7×5.0mm: p.26)

p00 ← Part Number List    EIA: **COG** **U2J**    Murata Temperature Characteristic: **X8G** **ZLM**

| L×W (mm)            | 3.2×1.6 |     |     |     |     |     |      |     |      |     |      |     |     |     |     |     |     |     |      |     |     |     |     |     |     |     |     |     |  |
|---------------------|---------|-----|-----|-----|-----|-----|------|-----|------|-----|------|-----|-----|-----|-----|-----|-----|-----|------|-----|-----|-----|-----|-----|-----|-----|-----|-----|--|
|                     | 0.95    |     |     |     | 1.0 |     |      |     | 1.25 |     |      |     | 1.8 |     |     |     |     |     |      |     |     |     |     |     |     |     |     |     |  |
| T max. (mm)         | 100     |     | 80  |     | 50  |     | 1000 |     | 630  |     | 1000 |     | 630 |     | 250 |     | 50  |     | 1000 |     | 630 |     | 250 |     | 100 |     | 50  |     |  |
| Rated Voltage (Vdc) | COG     | X8G | COG | COG | X8G | COG | U2J  | COG | U2J  | COG | U2J  | COG | U2J | COG | U2J | COG | COG | U2J | COG  | U2J | COG | COG | COG | COG | COG | COG | COG | COG |  |
| Cap. / TC Code      | COG     | X8G | COG | COG | X8G | COG | U2J  | COG | U2J  | COG | U2J  | COG | U2J | COG | U2J | COG | COG | U2J | COG  | U2J | COG | COG | COG | COG | COG | COG | COG | COG |  |
| 9.0pF               |         |     |     |     |     |     |      |     |      |     |      |     |     |     |     |     |     |     |      |     |     |     |     |     |     |     |     |     |  |
| 9.1pF               |         |     |     |     |     |     |      |     |      |     |      |     |     |     |     |     |     |     |      |     |     |     |     |     |     |     |     |     |  |
| 9.2pF               |         |     |     |     |     |     |      |     |      |     |      |     |     |     |     |     |     |     |      |     |     |     |     |     |     |     |     |     |  |
| 9.3pF               |         |     |     |     |     |     |      |     |      |     |      |     |     |     |     |     |     |     |      |     |     |     |     |     |     |     |     |     |  |
| 9.4pF               |         |     |     |     |     |     |      |     |      |     |      |     |     |     |     |     |     |     |      |     |     |     |     |     |     |     |     |     |  |
| 9.5pF               |         |     |     |     |     |     |      |     |      |     |      |     |     |     |     |     |     |     |      |     |     |     |     |     |     |     |     |     |  |
| 9.6pF               |         |     |     |     |     |     |      |     |      |     |      |     |     |     |     |     |     |     |      |     |     |     |     |     |     |     |     |     |  |
| 9.7pF               |         |     |     |     |     |     |      |     |      |     |      |     |     |     |     |     |     |     |      |     |     |     |     |     |     |     |     |     |  |
| 9.8pF               |         |     |     |     |     |     |      |     |      |     |      |     |     |     |     |     |     |     |      |     |     |     |     |     |     |     |     |     |  |
| 9.9pF               |         |     |     |     |     |     |      |     |      |     |      |     |     |     |     |     |     |     |      |     |     |     |     |     |     |     |     |     |  |
| 10pF                |         |     |     |     |     |     |      | p79 | p79  | p79 | p80  |     |     |     |     |     |     |     |      |     |     |     |     |     |     |     |     |     |  |
| 11pF                |         |     |     |     |     |     |      |     |      |     |      |     |     |     |     |     |     |     |      |     |     |     |     |     |     |     |     |     |  |
| 12pF                |         |     |     |     |     |     |      | p79 | p79  | p79 | p80  |     |     |     |     |     |     |     |      |     |     |     |     |     |     |     |     |     |  |
| 13pF                |         |     |     |     |     |     |      |     |      |     |      |     |     |     |     |     |     |     |      |     |     |     |     |     |     |     |     |     |  |
| 15pF                |         |     |     |     |     |     |      | p79 | p79  | p79 | p80  |     |     |     |     |     |     |     |      |     |     |     |     |     |     |     |     |     |  |
| 16pF                |         |     |     |     |     |     |      |     |      |     |      |     |     |     |     |     |     |     |      |     |     |     |     |     |     |     |     |     |  |
| 18pF                |         |     |     |     |     |     |      | p79 | p79  | p79 | p80  |     |     |     |     |     |     |     |      |     |     |     |     |     |     |     |     |     |  |
| 20pF                |         |     |     |     |     |     |      |     |      |     |      |     |     |     |     |     |     |     |      |     |     |     |     |     |     |     |     |     |  |
| 22pF                |         |     |     |     |     |     |      | p79 | p79  | p79 | p80  |     |     |     |     |     |     |     |      |     |     |     |     |     |     |     |     |     |  |
| 24pF                |         |     |     |     |     |     |      |     |      |     |      |     |     |     |     |     |     |     |      |     |     |     |     |     |     |     |     |     |  |
| 27pF                |         |     |     |     |     |     |      | p79 | p79  | p79 | p80  |     |     |     |     |     |     |     |      |     |     |     |     |     |     |     |     |     |  |
| 30pF                |         |     |     |     |     |     |      |     |      |     |      |     |     |     |     |     |     |     |      |     |     |     |     |     |     |     |     |     |  |
| 33pF                |         |     |     |     |     |     |      | p79 | p79  | p79 | p80  |     |     |     |     |     |     |     |      |     |     |     |     |     |     |     |     |     |  |
| 36pF                |         |     |     |     |     |     |      |     |      |     |      |     |     |     |     |     |     |     |      |     |     |     |     |     |     |     |     |     |  |
| 39pF                |         |     |     |     |     |     |      | p79 | p79  | p79 | p80  |     |     |     |     |     |     |     |      |     |     |     |     |     |     |     |     |     |  |
| 43pF                |         |     |     |     |     |     |      |     |      |     |      |     |     |     |     |     |     |     |      |     |     |     |     |     |     |     |     |     |  |
| 47pF                |         |     |     |     |     |     |      | p79 | p79  | p80 | p80  |     |     |     |     |     |     |     |      |     |     |     |     |     |     |     |     |     |  |
| 51pF                |         |     |     |     |     |     |      |     |      |     |      |     |     |     |     |     |     |     |      |     |     |     |     |     |     |     |     |     |  |
| 56pF                |         |     |     |     |     |     |      | p79 | p79  | p80 | p80  |     |     |     |     |     |     |     |      |     |     |     |     |     |     |     |     |     |  |
| 62pF                |         |     |     |     |     |     |      |     |      |     |      |     |     |     |     |     |     |     |      |     |     |     |     |     |     |     |     |     |  |
| 68pF                |         |     |     |     |     |     |      | p79 | p79  | p80 | p80  |     |     |     |     |     |     |     |      |     |     |     |     |     |     |     |     |     |  |
| 75pF                |         |     |     |     |     |     |      |     |      |     |      |     |     |     |     |     |     |     |      |     |     |     |     |     |     |     |     |     |  |
| 82pF                |         |     |     |     |     |     |      | p79 | p79  | p80 | p80  |     |     |     |     |     |     |     |      |     |     |     |     |     |     |     |     |     |  |
| 91pF                |         |     |     |     |     |     |      |     |      |     |      |     |     |     |     |     |     |     |      |     |     |     |     |     |     |     |     |     |  |
| 100pF               |         |     |     |     |     |     |      | p79 | p79  | p80 | p80  |     |     |     |     |     |     |     |      |     |     |     |     |     |     |     |     |     |  |
| 110pF               |         |     |     |     |     |     |      |     |      |     |      |     |     |     |     |     |     |     |      |     |     |     |     |     |     |     |     |     |  |
| 120pF               |         |     |     |     |     |     |      | p79 | p79  | p80 | p80  |     |     |     |     |     |     |     |      |     |     |     |     |     |     |     |     |     |  |
| 130pF               |         |     |     |     |     |     |      |     |      |     |      |     |     |     |     |     |     |     |      |     |     |     |     |     |     |     |     |     |  |
| 150pF               |         |     |     |     |     |     |      | p79 | p79  | p80 | p80  |     |     |     |     |     |     |     |      |     |     |     |     |     |     |     |     |     |  |
| 160pF               |         |     |     |     |     |     |      |     |      |     |      |     |     |     |     |     |     |     |      |     |     |     |     |     |     |     |     |     |  |
| 180pF               |         |     |     |     |     |     |      | p79 | p79  | p80 | p80  |     |     |     |     |     |     |     |      |     |     |     |     |     |     |     |     |     |  |
| 200pF               |         |     |     |     |     |     |      |     |      |     |      |     |     |     |     |     |     |     |      |     |     |     |     |     |     |     |     |     |  |
| 220pF               |         |     |     |     |     |     |      | p79 | p79  | p80 | p80  |     |     |     |     |     |     |     |      |     |     |     |     |     |     |     |     |     |  |
| 240pF               |         |     |     |     |     |     |      |     |      |     |      |     |     |     |     |     |     |     |      |     |     |     |     |     |     |     |     |     |  |
| 270pF               |         |     |     |     |     |     |      | p79 | p79  | p80 | p80  |     |     |     |     |     |     |     |      |     |     |     |     |     |     |     |     |     |  |
| 300pF               |         |     |     |     |     |     |      |     |      |     |      |     |     |     |     |     |     |     |      |     |     |     |     |     |     |     |     |     |  |
| 330pF               |         |     |     |     |     |     |      | p79 | p79  | p80 | p80  |     |     |     |     |     |     |     |      |     |     |     |     |     |     |     |     |     |  |
| 360pF               |         |     |     |     |     |     |      |     |      |     |      |     |     |     |     |     |     |     |      |     |     |     |     |     |     |     |     |     |  |
| 390pF               |         |     |     |     |     |     |      | p79 |      | p80 | p80  |     |     |     |     |     |     |     |      |     |     |     |     |     |     |     |     |     |  |
| 430pF               |         |     |     |     |     |     |      |     |      |     |      |     |     |     |     |     |     |     |      |     |     |     |     |     |     |     |     |     |  |
| 470pF               |         |     |     |     |     |     |      | p79 |      | p80 | p80  |     |     |     |     |     |     |     |      |     |     |     |     |     |     |     |     |     |  |
| 510pF               |         |     |     |     |     |     |      |     |      |     |      |     |     |     |     |     |     |     |      |     |     |     |     |     |     |     |     |     |  |
| 560pF               |         |     |     |     |     |     |      |     |      | p80 | p80  | p80 | p80 |     |     |     |     |     |      |     |     |     |     |     |     |     |     |     |  |
| 620pF               |         |     |     |     |     |     |      |     |      |     |      |     |     |     |     |     |     |     |      |     |     |     |     |     |     |     |     |     |  |
| 680pF               |         |     |     |     |     |     |      |     |      | p80 | p80  | p80 | p80 |     |     |     |     |     |      |     |     |     |     |     |     |     |     |     |  |

↓ Continued on the following page.

# Capacitance Table

(→ GCM Series Temperature Compensating Type) (0.6×0.3 – 2.0×1.25mm: p.20 to 23, 3.2×2.5 – 5.7×5.0mm: p.26)

p00 ← Part Number List    EIA: **COG** **U2J**    Murata Temperature Characteristic: **X8G** **ZLM**

| L×W (mm)            | 3.2×1.6 |     |     |     |     |     |      |     |     |      |      |     |     |     |     |     |     |     |      |     |     |     |     |     |     |     |     |     |
|---------------------|---------|-----|-----|-----|-----|-----|------|-----|-----|------|------|-----|-----|-----|-----|-----|-----|-----|------|-----|-----|-----|-----|-----|-----|-----|-----|-----|
|                     | 0.95    |     |     |     |     | 1.0 |      |     |     | 1.25 |      |     |     | 1.8 |     |     |     |     |      |     |     |     |     |     |     |     |     |     |
| T max. (mm)         | 100     |     | 80  |     | 50  |     | 1000 |     | 630 |      | 1000 |     | 630 |     | 250 |     | 50  |     | 1000 |     | 630 |     | 250 |     | 100 |     | 50  |     |
| Rated Voltage (Vdc) | COG     | X8G | COG | COG | X8G | COG | U2J  | COG | U2J | COG  | U2J  | COG | U2J | COG | U2J | COG | U2J | COG | COG  | U2J | COG | U2J | COG | COG | COG | COG | COG | COG |
| Cap. / TC Code      | COG     | X8G | COG | COG | X8G | COG | U2J  | COG | U2J | COG  | U2J  | COG | U2J | COG | U2J | COG | U2J | COG | COG  | U2J | COG | U2J | COG | COG | COG | COG | COG | COG |
| 750pF               |         |     |     |     |     |     |      |     |     |      |      |     |     |     |     |     |     |     |      |     |     |     |     |     |     |     |     |     |
| 820pF               |         |     |     |     |     |     |      | p80 | p80 |      |      |     |     |     |     |     |     |     |      | p81 | p81 |     |     |     |     |     |     |     |
| 910pF               |         |     |     |     |     |     |      |     |     |      |      |     |     |     |     |     |     |     |      |     |     |     |     |     |     |     |     |     |
| 1000pF              |         |     |     |     |     |     |      | p80 | p80 |      |      |     |     |     |     |     |     |     |      |     | p81 | p81 |     |     |     |     |     |     |
| 1100pF              |         |     |     |     |     |     |      |     |     |      |      |     |     |     |     |     |     |     |      |     |     |     |     |     |     |     |     |     |
| 1200pF              |         |     |     |     |     |     |      | p80 | p80 |      |      |     |     |     |     |     |     |     |      |     |     |     |     |     |     |     |     |     |
| 1300pF              |         |     |     |     |     |     |      |     |     |      |      |     |     |     |     |     |     |     |      |     |     |     |     |     |     |     |     |     |
| 1500pF              |         |     |     |     |     |     |      | p80 | p80 |      |      |     |     |     |     |     |     |     |      |     |     |     |     |     |     |     |     |     |
| 1600pF              |         | p78 |     |     |     |     |      |     |     |      |      |     |     |     |     |     |     |     |      |     |     |     |     |     |     |     |     |     |
| 1800pF              |         | p78 |     |     |     |     |      | p80 | p80 |      |      |     |     |     |     |     |     |     |      |     |     |     |     |     |     |     |     |     |
| 2000pF              |         | p78 |     |     |     |     |      |     |     |      |      |     |     |     |     |     |     |     |      |     |     |     |     |     |     |     |     |     |
| 2200pF              |         | p78 |     |     |     |     |      |     | p80 |      |      |     |     |     |     |     |     |     |      |     |     |     |     |     |     |     |     |     |
| 2400pF              |         | p78 |     |     |     |     |      |     |     |      |      |     |     |     |     |     |     |     |      |     |     |     |     |     |     |     |     |     |
| 2700pF              |         | p78 |     |     |     |     |      |     |     |      |      |     |     |     |     |     |     |     |      |     |     |     |     |     |     |     |     |     |
| 3000pF              |         | p78 |     |     |     |     |      |     |     |      |      |     |     |     |     |     |     |     |      |     |     |     |     |     |     |     |     |     |
| 3300pF              |         | p78 |     |     |     |     |      |     |     |      |      |     |     |     |     |     |     |     |      |     |     |     |     |     |     |     |     |     |
| 3600pF              | p78     | p78 |     |     |     |     |      |     |     |      |      |     |     |     |     |     |     |     |      |     |     |     |     |     |     |     |     |     |
| 3900pF              | p78     | p78 |     |     |     |     |      |     |     |      |      |     |     |     |     |     |     |     |      |     |     |     |     |     |     |     |     |     |
| 4300pF              | p78     | p78 |     |     |     |     |      |     |     |      |      |     |     |     |     |     |     |     |      |     |     |     |     |     |     |     |     |     |
| 4700pF              | p78     | p78 |     |     |     |     |      |     |     |      |      |     |     |     |     |     |     |     |      |     |     |     |     |     |     |     |     |     |
| 5100pF              | p78     | p78 |     |     |     |     |      |     |     |      |      |     |     |     |     |     |     |     |      |     |     |     |     |     |     |     |     |     |
| 5600pF              | p78     | p78 |     |     |     |     |      |     |     |      |      |     |     |     |     |     |     |     |      |     |     |     |     |     |     |     |     |     |
| 6200pF              |         |     |     |     |     |     |      |     |     |      |      |     |     |     |     |     |     |     |      |     |     |     |     |     |     |     |     |     |
| 6800pF              | p78     |     |     |     |     |     |      |     |     |      |      |     |     |     |     |     |     |     |      |     |     |     |     |     |     |     |     |     |
| 7500pF              | p78     |     |     |     |     |     |      |     |     |      |      |     |     |     |     |     |     |     |      |     |     |     |     |     |     |     |     |     |
| 8200pF              | p78     |     |     |     |     |     |      |     |     |      |      |     |     |     |     |     |     |     |      |     |     |     |     |     |     |     |     |     |
| 9100pF              | p78     |     |     |     |     |     |      |     |     |      |      |     |     |     |     |     |     |     |      |     |     |     |     |     |     |     |     |     |
| 10000pF             | p78     |     |     |     |     |     |      |     |     |      |      |     |     |     |     |     |     |     |      |     |     |     |     |     |     |     |     |     |
| 11000pF             |         |     |     |     |     |     |      |     |     |      |      |     |     |     |     |     |     |     |      |     |     |     |     |     |     |     |     |     |
| 12000pF             |         |     |     |     |     |     |      |     |     |      |      |     |     |     |     |     |     |     |      |     |     |     |     |     |     |     |     |     |
| 13000pF             |         |     |     |     |     |     |      |     |     |      |      |     |     |     |     |     |     |     |      |     |     |     |     |     |     |     |     |     |
| 15000pF             |         |     |     |     |     |     |      |     |     |      |      |     |     |     |     |     |     |     |      |     |     |     |     |     |     |     |     |     |
| 16000pF             |         |     |     |     |     |     |      |     |     |      |      |     |     |     |     |     |     |     |      |     |     |     |     |     |     |     |     |     |
| 18000pF             |         |     |     |     |     |     |      |     |     |      |      |     |     |     |     |     |     |     |      |     |     |     |     |     |     |     |     |     |
| 20000pF             |         |     |     |     |     |     |      |     |     |      |      |     |     |     |     |     |     |     |      |     |     |     |     |     |     |     |     |     |
| 22000pF             |         |     |     |     |     |     |      |     |     |      |      |     |     |     |     |     |     |     |      |     |     |     |     |     |     |     |     |     |
| 27000pF             |         |     | p78 | p78 |     |     |      |     |     |      |      |     |     |     |     |     |     |     |      |     |     |     |     |     |     |     |     |     |
| 33000pF             |         |     | p78 | p78 |     |     |      |     |     |      |      |     |     |     |     |     |     |     |      |     |     |     |     |     |     |     |     |     |
| 39000pF             |         |     |     | p78 |     |     |      |     |     |      |      |     |     |     |     |     |     |     |      |     |     |     |     |     |     |     |     |     |
| 43000pF             |         |     |     |     |     |     |      |     |     |      |      |     |     |     |     |     |     |     |      |     |     |     |     |     |     |     |     |     |
| 47000pF             |         |     |     |     |     |     |      |     |     |      |      |     |     |     |     |     |     |     |      |     |     |     |     |     |     |     |     |     |
| 51000pF             |         |     |     |     |     |     |      |     |     |      |      |     |     |     |     |     |     |     |      |     |     |     |     |     |     |     |     |     |
| 56000pF             |         |     |     |     |     |     |      |     |     |      |      |     |     |     |     |     |     |     |      |     |     |     |     |     |     |     |     |     |
| 62000pF             |         |     |     |     |     |     |      |     |     |      |      |     |     |     |     |     |     |     |      |     |     |     |     |     |     |     |     |     |
| 68000pF             |         |     |     |     |     |     |      |     |     |      |      |     |     |     |     |     |     |     |      |     |     |     |     |     |     |     |     |     |
| 75000pF             |         |     |     |     |     |     |      |     |     |      |      |     |     |     |     |     |     |     |      |     |     |     |     |     |     |     |     |     |
| 82000pF             |         |     |     |     |     |     |      |     |     |      |      |     |     |     |     |     |     |     |      |     |     |     |     |     |     |     |     |     |
| 91000pF             |         |     |     |     |     |     |      |     |     |      |      |     |     |     |     |     |     |     |      |     |     |     |     |     |     |     |     |     |
| 0.10μF              |         |     |     |     |     |     |      |     |     |      |      |     |     |     |     |     |     |     |      |     |     |     |     |     |     |     |     |     |

Continued on the following page. ↗



# Capacitance Table

(→ GCM Series Temperature Compensating Type) (0.6×0.3 – 2.0×1.25mm: p.20 to 23, 3.2×1.6mm: p.24 to 25)

p00 ← Part Number List    EIA: **COG** **U2J**    Murata Temperature Characteristic: **X8G** **ZLM**

| L×W (mm)            | 3.2×2.5 |      |      |      |     |      |     | 4.5×3.2 |      |     |      | 5.7×5.0 |      |     |      |     |
|---------------------|---------|------|------|------|-----|------|-----|---------|------|-----|------|---------|------|-----|------|-----|
|                     | 1.0     |      | 1.25 |      | 1.5 |      | 2.0 | 2.85    | 1.5  |     | 2.0  |         | 1.5  |     | 2.0  |     |
| T max. (mm)         | 630     | 1000 | 630  | 1000 | 630 | 1000 | 630 | 630     | 1000 | 630 | 1000 | 630     | 1000 | 630 | 1000 | 630 |
| Rated Voltage (Vdc) | 630     | 1000 | 630  | 1000 | 630 | 1000 | 630 | 630     | 1000 | 630 | 1000 | 630     | 1000 | 630 | 1000 | 630 |
| Cap. / TC Code      | U2J     | U2J  | U2J  | U2J  | U2J | U2J  | COG | U2J     | U2J  | U2J | U2J  | U2J     | U2J  | U2J | U2J  | U2J |
| 750pF               |         |      |      |      |     |      |     |         |      |     |      |         |      |     |      |     |
| 820pF               |         |      |      |      |     |      |     |         |      |     |      |         |      |     |      |     |
| 910pF               |         |      |      |      |     |      |     |         |      |     |      |         |      |     |      |     |
| 1000pF              |         |      |      |      |     |      |     |         |      |     |      |         |      |     |      |     |
| 1100pF              |         |      |      |      |     |      |     |         |      |     |      |         |      |     |      |     |
| 1200pF              | p81     | p81  |      |      |     |      |     |         |      |     |      |         |      |     |      |     |
| 1300pF              |         |      |      |      |     |      |     |         |      |     |      |         |      |     |      |     |
| 1500pF              | p81     |      |      | p81  |     |      |     |         |      |     |      |         |      |     |      |     |
| 1600pF              |         |      |      |      |     |      |     |         |      |     |      |         |      |     |      |     |
| 1800pF              | p81     |      |      |      |     | p81  |     |         |      |     |      |         |      |     |      |     |
| 2000pF              |         |      |      |      |     |      |     |         |      |     |      |         |      |     |      |     |
| 2200pF              | p81     |      |      |      |     | p81  |     |         |      |     |      |         |      |     |      |     |
| 2400pF              |         |      |      |      |     |      |     |         |      |     |      |         |      |     |      |     |
| 2700pF              |         |      |      |      |     |      |     |         | p82  |     |      |         |      |     |      |     |
| 3000pF              |         |      |      |      |     |      |     |         |      |     |      |         |      |     |      |     |
| 3300pF              |         |      |      |      |     |      |     |         | p82  |     |      |         |      |     |      |     |
| 3600pF              |         |      |      |      |     |      |     |         |      |     |      |         |      |     |      |     |
| 3900pF              |         |      |      |      |     |      |     |         |      |     | p82  |         |      |     |      |     |
| 4300pF              |         |      |      |      |     |      |     |         |      |     |      |         |      |     |      |     |
| 4700pF              |         |      |      |      |     |      |     |         |      |     | p82  |         |      |     |      |     |
| 5100pF              |         |      |      |      |     |      |     |         |      |     |      |         |      |     |      |     |
| 5600pF              |         |      | p81  |      |     |      |     |         |      |     |      |         | p82  |     |      |     |
| 6200pF              |         |      |      |      |     |      |     |         |      |     |      |         |      |     |      |     |
| 6800pF              |         |      |      | p81  |     |      |     |         |      |     |      |         | p82  |     |      |     |
| 7500pF              |         |      |      |      |     |      |     |         |      |     |      |         |      |     |      |     |
| 8200pF              |         |      |      |      |     |      |     |         |      |     | p81  |         |      |     | p82  |     |
| 9100pF              |         |      |      |      |     |      |     |         |      |     |      |         |      |     |      |     |
| 10000pF             |         |      |      |      |     |      |     |         |      |     | p81  |         |      |     | p82  |     |
| 11000pF             |         |      |      |      |     |      |     |         |      |     |      |         |      |     |      |     |
| 12000pF             |         |      |      |      |     |      |     |         |      |     | p82  |         |      |     |      |     |
| 13000pF             |         |      |      |      |     |      |     |         |      |     |      |         |      |     |      |     |
| 15000pF             |         |      |      |      |     |      |     |         |      |     |      |         | p82  |     |      |     |
| 16000pF             |         |      |      |      |     |      |     |         |      |     |      |         |      |     |      |     |
| 18000pF             |         |      |      |      |     |      |     |         |      |     |      |         | p82  |     |      |     |
| 20000pF             |         |      |      |      |     |      |     |         |      |     |      |         |      |     |      |     |
| 22000pF             |         |      |      |      |     |      |     |         |      |     |      |         | p82  |     |      |     |
| 27000pF             |         |      |      |      |     |      |     |         |      |     |      |         |      | p82 |      |     |
| 33000pF             |         |      |      |      |     |      |     |         |      | p81 |      |         |      |     | p82  |     |
| 39000pF             |         |      |      |      |     |      |     |         |      |     |      |         |      |     | p82  |     |
| 43000pF             |         |      |      |      |     |      |     |         |      |     |      |         |      |     |      |     |
| 47000pF             |         |      |      |      |     |      |     |         |      |     |      |         |      |     |      | p82 |
| 51000pF             |         |      |      |      |     |      |     |         |      |     |      |         |      |     |      |     |
| 56000pF             |         |      |      |      |     |      |     |         |      |     |      |         |      |     |      |     |
| 62000pF             |         |      |      |      |     |      |     |         |      |     |      |         |      |     |      |     |
| 68000pF             |         |      |      |      |     |      |     |         |      |     |      |         |      |     |      |     |
| 75000pF             |         |      |      |      |     |      |     |         |      |     |      |         |      |     |      |     |
| 82000pF             |         |      |      |      |     |      |     |         |      |     |      |         |      |     |      |     |
| 91000pF             |         |      |      |      |     |      |     |         |      |     |      |         |      |     |      |     |
| 0.10μF              |         |      |      |      |     |      |     |         |      |     |      |         |      |     |      |     |

# Capacitance Table

## GCM Series High Dielectric Constant Type

p00 ← Part Number List    EIA: X7S X7T X7R X8R    Murata Temperature Characteristic: X8L X8M

| L×W (mm)            | 0.6×0.3 |     |     | 1.0×0.5 |     |     |     |     |     |     |     |     |     | 1.6×0.8 |     |     |     |     |     |     |     |     |     |     |     |     |
|---------------------|---------|-----|-----|---------|-----|-----|-----|-----|-----|-----|-----|-----|-----|---------|-----|-----|-----|-----|-----|-----|-----|-----|-----|-----|-----|-----|
|                     | 0.33    |     |     | 0.55    |     |     |     |     | 0.6 | 0.7 | 0.9 |     |     |         |     |     |     |     |     |     | 1.0 |     |     |     |     |     |
| T max. (mm)         | 25      | 16  | 10  | 100     | 50  | 25  | 16  | 10  | 10  | 10  | 100 | 50  | 25  | 16      | 6.3 | 6.3 | 100 | 50  | 25  | 16  | 6.3 | 6.3 |     |     |     |     |
| Rated Voltage (Vdc) | X7R     | X7R | X7R | X7R     | X8L | X7R | X8L | X7R | X8L | X7R | X7S | X7S | X8R | X7R     | X8L | X8R | X7R | X8L | X8R | X7R | X8L | X7R | X7S | X7R | X7T |     |
| Cap. / TC Code      | X7R     | X7R | X7R | X7R     | X8L | X7R | X8L | X7R | X8L | X7R | X7S | X7S | X8R | X7R     | X8L | X8R | X7R | X8L | X8R | X7R | X8L | X7R | X7S | X7R | X7T |     |
| 100pF               | p83     |     |     |         |     |     |     |     |     |     |     |     |     |         |     |     |     |     |     |     |     |     |     |     |     |     |
| 120pF               | p83     |     |     |         |     |     |     |     |     |     |     |     |     |         |     |     |     |     |     |     |     |     |     |     |     |     |
| 150pF               | p83     |     |     |         |     |     |     |     |     |     |     |     |     |         |     |     |     |     |     |     |     |     |     |     |     |     |
| 180pF               | p83     |     |     |         |     |     |     |     |     |     |     |     |     |         |     |     |     |     |     |     |     |     |     |     |     |     |
| 220pF               | p83     |     |     | p83     | p84 | p84 |     |     |     |     |     |     |     |         |     |     |     |     |     |     |     |     |     |     |     |     |
| 270pF               | p83     |     |     | p83     | p84 | p84 |     |     |     |     |     |     |     |         |     |     |     |     |     |     |     |     |     |     |     |     |
| 330pF               | p83     | p83 |     | p83     | p84 | p84 |     |     |     |     |     |     |     |         |     |     |     |     |     |     |     |     |     |     |     |     |
| 390pF               | p83     |     |     | p83     | p84 | p84 |     |     |     |     |     |     |     |         |     |     |     |     |     |     |     |     |     |     |     |     |
| 470pF               | p83     |     |     | p83     | p84 | p84 |     |     |     |     |     |     |     |         |     |     |     |     |     |     |     |     |     |     |     |     |
| 560pF               | p83     |     |     | p83     | p84 | p84 |     |     |     |     |     |     |     |         |     |     |     |     |     |     |     |     |     |     |     |     |
| 680pF               | p83     | p83 |     | p83     | p84 | p84 |     |     |     |     |     |     |     |         |     |     |     |     |     |     |     |     |     |     |     |     |
| 820pF               | p83     |     |     | p83     | p84 | p84 |     |     |     |     |     |     |     |         |     |     |     |     |     |     |     |     |     |     |     |     |
| 1000pF              | p83     |     |     | p83     | p84 | p84 |     |     |     |     |     |     | p85 |         |     | p86 |     |     |     |     |     |     |     |     |     |     |
| 1200pF              | p83     |     | p83 | p83     | p84 | p84 |     |     |     |     |     |     | p85 |         |     | p86 |     |     |     |     |     |     |     |     |     |     |
| 1500pF              | p83     |     | p83 | p83     | p84 | p84 |     |     |     |     |     |     | p85 |         |     | p86 |     |     |     |     |     |     |     |     |     |     |
| 1800pF              | p83     | p83 | p83 | p83     | p84 | p84 |     |     |     |     |     |     | p85 |         |     | p86 |     |     |     |     |     |     |     |     |     |     |
| 2200pF              | p83     | p83 | p83 | p83     | p84 | p84 |     |     |     |     |     |     | p85 |         |     | p86 |     |     |     |     |     |     |     |     |     |     |
| 2700pF              | p83     | p83 | p83 | p83     | p84 | p84 |     |     |     |     |     |     | p85 |         |     | p86 |     |     |     |     |     |     |     |     |     |     |
| 3300pF              | p83     | p83 | p83 | p83     | p84 | p84 |     |     |     |     |     |     | p85 |         |     | p86 |     |     |     |     |     |     |     |     |     |     |
| 3900pF              |         |     | p83 | p83     | p84 | p84 |     |     |     |     |     |     |     |         |     |     |     |     |     |     |     |     |     |     |     |     |
| 4700pF              |         |     | p83 | p83     | p84 | p84 |     |     | p84 |     |     |     | p85 |         |     | p86 |     |     |     |     |     |     |     |     |     |     |
| 5600pF              |         |     | p83 |         |     | p84 | p84 | p84 |     |     |     |     |     |         | p85 | p85 |     |     |     |     |     |     |     |     |     |     |
| 6800pF              |         |     | p83 |         |     | p84 | p84 | p85 |     |     |     |     |     |         | p85 | p85 | p86 |     |     |     |     |     |     |     |     |     |
| 8200pF              |         |     | p83 |         |     | p84 | p84 | p85 |     |     |     |     |     |         | p85 | p85 |     |     |     |     |     |     |     |     |     |     |
| 10000pF             |         |     | p83 |         |     | p84 | p84 | p85 |     |     |     |     |     |         | p85 | p85 | p86 |     |     |     |     |     |     |     |     |     |
| 12000pF             |         |     |     |         |     | p84 |     | p85 |     |     |     |     |     |         | p85 | p86 |     |     |     |     |     |     |     |     |     |     |
| 15000pF             |         |     |     |         |     | p84 |     | p85 | p85 |     |     |     |     |         | p85 | p86 | p86 |     |     |     |     |     |     |     |     |     |
| 18000pF             |         |     |     |         |     | p84 |     | p85 | p85 |     |     |     |     |         | p85 | p86 |     |     |     |     |     |     |     |     |     |     |
| 22000pF             |         |     |     |         |     | p84 |     | p85 | p85 |     |     |     |     |         | p85 | p86 | p86 |     |     |     |     |     |     |     |     |     |
| 27000pF             |         |     |     |         |     |     |     | p85 | p85 | p85 |     |     |     |         |     | p86 |     |     |     |     |     |     |     |     |     |     |
| 33000pF             |         |     |     |         | p84 | p84 |     | p85 | p85 | p85 |     |     |     |         | p86 | p86 |     |     |     |     |     |     |     |     |     |     |
| 39000pF             |         |     |     |         |     |     |     | p85 | p85 | p85 |     |     |     |         | p86 |     |     |     |     |     |     |     |     |     |     |     |
| 47000pF             |         |     |     |         | p84 | p84 |     | p85 | p85 | p85 |     |     |     |         | p86 | p86 |     |     |     |     |     |     |     |     |     |     |
| 56000pF             |         |     |     |         |     |     |     |     |     | p85 |     |     |     |         |     | p86 |     |     |     |     |     |     |     |     |     |     |
| 68000pF             |         |     |     |         | p84 | p84 |     |     |     | p85 |     |     |     |         | p86 |     |     |     |     |     |     |     |     |     |     |     |
| 82000pF             |         |     |     |         |     |     |     |     |     | p85 |     |     |     |         | p86 |     |     |     |     |     |     |     |     |     |     |     |
| 0.10μF              |         |     |     |         | p84 | p84 | p84 | p85 |     | p85 | p85 |     |     |         | p86 |     |     |     |     |     |     |     |     |     |     |     |
| 0.12μF              |         |     |     |         |     |     |     |     |     |     |     |     |     |         |     |     |     |     |     |     |     |     |     |     |     |     |
| 0.15μF              |         |     |     |         |     |     |     |     |     | p85 |     |     |     |         |     |     |     |     |     | p86 |     |     | p86 | p86 |     |     |
| 0.18μF              |         |     |     |         |     |     |     |     |     |     |     |     |     |         |     |     |     |     |     | p86 |     |     | p86 | p86 |     |     |
| 0.22μF              |         |     |     |         |     |     |     |     |     | p85 |     |     |     |         |     |     |     |     |     | p86 | p86 |     | p86 | p86 |     |     |
| 0.27μF              |         |     |     |         |     |     |     |     |     |     |     |     |     |         |     |     |     |     |     |     |     |     |     |     | p86 |     |
| 0.33μF              |         |     |     |         |     |     |     |     |     |     |     |     |     |         |     |     |     |     |     |     |     |     |     |     | p86 |     |
| 0.39μF              |         |     |     |         |     |     |     |     |     |     |     |     |     |         |     |     |     |     |     |     |     |     |     |     | p86 |     |
| 0.47μF              |         |     |     |         |     |     |     |     |     |     |     |     | p85 |         |     |     |     |     |     |     |     |     |     |     | p86 |     |
| 0.56μF              |         |     |     |         |     |     |     |     |     |     |     |     |     |         |     |     |     |     |     |     |     |     |     |     |     |     |
| 0.68μF              |         |     |     |         |     |     |     |     |     |     |     |     |     |         |     |     |     |     |     |     |     |     |     |     |     |     |
| 0.82μF              |         |     |     |         |     |     |     |     |     |     |     |     |     |         |     |     |     |     |     |     |     |     |     |     |     | p86 |
| 1.0μF               |         |     |     |         |     |     |     |     |     |     |     |     |     |         |     |     |     |     |     |     |     |     |     |     |     | p86 |
| 1.5μF               |         |     |     |         |     |     |     |     |     |     |     |     |     |         |     |     |     |     |     |     |     |     |     |     |     |     |
| 2.2μF               |         |     |     |         |     |     |     |     |     |     |     |     |     |         |     |     |     |     |     |     |     |     |     |     |     | p86 |
| 3.3μF               |         |     |     |         |     |     |     |     |     |     |     |     |     |         |     |     |     |     |     |     |     |     |     |     |     |     |
| 4.7μF               |         |     |     |         |     |     |     |     |     |     |     |     |     |         |     |     |     |     |     |     |     |     |     |     |     |     |
| 10μF                |         |     |     |         |     |     |     |     |     |     |     |     |     |         |     |     |     |     |     |     |     |     |     |     |     | p86 |
| 22μF                |         |     |     |         |     |     |     |     |     |     |     |     |     |         |     |     |     |     |     |     |     |     |     |     |     |     |
| 47μF                |         |     |     |         |     |     |     |     |     |     |     |     |     |         |     |     |     |     |     |     |     |     |     |     |     |     |
| 100μF               |         |     |     |         |     |     |     |     |     |     |     |     |     |         |     |     |     |     |     |     |     |     |     |     |     |     |

Continued on the following page. ↗

# Capacitance Table

(→ GCM Series High Dielectric Constant Type)

p00 ← Part Number List    EIA: X7S X7T X7R X8R    Murata Temperature Characteristic: X8L X8M

| L×W (mm)            | 1.6×0.8     | 2.0×1.25 |     |     |     |     |     |     |     |     |     |     |     |     |     |     |     |     |     |     |     |      |     |     |     |  |  |
|---------------------|-------------|----------|-----|-----|-----|-----|-----|-----|-----|-----|-----|-----|-----|-----|-----|-----|-----|-----|-----|-----|-----|------|-----|-----|-----|--|--|
|                     | T max. (mm) | 0.95     |     |     |     |     | 1.4 |     |     |     |     |     |     |     |     |     |     |     |     |     |     | 1.45 |     |     |     |  |  |
| Rated Voltage (Vdc) | 4           | 100      | 50  | 25  | 16  | 100 | 50  | 35  | 25  | 16  | 10  | 6.3 | 100 | 35  |     |     |     |     |     |     |     |      |     |     |     |  |  |
| Cap. / TC Code      | X7T         | X8R      | X7R | X8R | X7R | X7R | X8R | X7R | X8L | X8R | X7R | X8L | X7R | X7S | X8L | X8R | X7R | X8L | X7R | X7R | X7S | X7R  | X7S | X8L | X7S |  |  |
| 100pF               |             |          |     |     |     |     |     |     |     |     |     |     |     |     |     |     |     |     |     |     |     |      |     |     |     |  |  |
| 120pF               |             |          |     |     |     |     |     |     |     |     |     |     |     |     |     |     |     |     |     |     |     |      |     |     |     |  |  |
| 150pF               |             |          |     |     |     |     |     |     |     |     |     |     |     |     |     |     |     |     |     |     |     |      |     |     |     |  |  |
| 180pF               |             |          |     |     |     |     |     |     |     |     |     |     |     |     |     |     |     |     |     |     |     |      |     |     |     |  |  |
| 220pF               |             |          |     |     |     |     |     |     |     |     |     |     |     |     |     |     |     |     |     |     |     |      |     |     |     |  |  |
| 270pF               |             |          |     |     |     |     |     |     |     |     |     |     |     |     |     |     |     |     |     |     |     |      |     |     |     |  |  |
| 330pF               |             |          |     |     |     |     |     |     |     |     |     |     |     |     |     |     |     |     |     |     |     |      |     |     |     |  |  |
| 390pF               |             |          |     |     |     |     |     |     |     |     |     |     |     |     |     |     |     |     |     |     |     |      |     |     |     |  |  |
| 470pF               |             |          |     |     |     |     |     |     |     |     |     |     |     |     |     |     |     |     |     |     |     |      |     |     |     |  |  |
| 560pF               |             |          |     |     |     |     |     |     |     |     |     |     |     |     |     |     |     |     |     |     |     |      |     |     |     |  |  |
| 680pF               |             |          |     |     |     |     |     |     |     |     |     |     |     |     |     |     |     |     |     |     |     |      |     |     |     |  |  |
| 820pF               |             |          |     |     |     |     |     |     |     |     |     |     |     |     |     |     |     |     |     |     |     |      |     |     |     |  |  |
| 1000pF              |             |          |     |     |     |     |     |     |     |     |     |     |     |     |     |     |     |     |     |     |     |      |     |     |     |  |  |
| 1200pF              |             |          |     |     |     |     |     |     |     |     |     |     |     |     |     |     |     |     |     |     |     |      |     |     |     |  |  |
| 1500pF              |             |          |     |     |     |     |     |     |     |     |     |     |     |     |     |     |     |     |     |     |     |      |     |     |     |  |  |
| 1800pF              |             |          |     |     |     |     |     |     |     |     |     |     |     |     |     |     |     |     |     |     |     |      |     |     |     |  |  |
| 2200pF              |             |          |     |     |     |     |     |     |     |     |     |     |     |     |     |     |     |     |     |     |     |      |     |     |     |  |  |
| 2700pF              |             |          |     |     |     |     |     |     |     |     |     |     |     |     |     |     |     |     |     |     |     |      |     |     |     |  |  |
| 3300pF              |             |          |     |     |     |     |     |     |     |     |     |     |     |     |     |     |     |     |     |     |     |      |     |     |     |  |  |
| 3900pF              |             |          |     |     |     |     |     |     |     |     |     |     |     |     |     |     |     |     |     |     |     |      |     |     |     |  |  |
| 4700pF              |             |          |     |     |     |     |     |     |     |     |     |     |     |     |     |     |     |     |     |     |     |      |     |     |     |  |  |
| 5600pF              |             |          |     |     |     |     |     |     |     |     |     |     |     |     |     |     |     |     |     |     |     |      |     |     |     |  |  |
| 6800pF              |             |          |     |     |     |     |     |     |     |     |     |     |     |     |     |     |     |     |     |     |     |      |     |     |     |  |  |
| 8200pF              |             |          |     |     |     |     |     |     |     |     |     |     |     |     |     |     |     |     |     |     |     |      |     |     |     |  |  |
| 10000pF             |             | p86      |     |     | p87 |     |     |     |     |     |     |     |     |     |     |     |     |     |     |     |     |      |     |     |     |  |  |
| 12000pF             |             |          |     |     |     |     |     |     |     |     |     |     |     |     |     |     |     |     |     |     |     |      |     |     |     |  |  |
| 15000pF             |             | p86      |     |     | p87 |     |     |     |     |     |     |     |     |     |     |     |     |     |     |     |     |      |     |     |     |  |  |
| 18000pF             |             |          |     |     |     |     |     |     |     |     |     |     |     |     |     |     |     |     |     |     |     |      |     |     |     |  |  |
| 22000pF             |             | p86      |     |     | p87 |     |     |     |     |     |     |     |     |     |     |     |     |     |     |     |     |      |     |     |     |  |  |
| 27000pF             |             |          | p86 |     |     |     |     |     |     | p87 |     |     |     |     |     |     |     |     |     |     |     |      |     |     |     |  |  |
| 33000pF             |             |          | p86 |     |     |     |     |     | p87 | p87 |     | p87 |     |     |     |     |     |     |     |     |     |      |     |     |     |  |  |
| 39000pF             |             |          | p86 |     |     |     |     |     |     | p87 |     |     |     |     |     |     |     |     |     |     |     |      |     |     |     |  |  |
| 47000pF             |             |          |     |     |     |     |     |     | p87 | p87 |     | p87 |     |     |     |     |     |     |     |     |     |      |     |     |     |  |  |
| 56000pF             |             |          |     |     |     |     |     |     |     | p87 |     |     |     |     |     |     |     |     |     |     |     |      |     |     |     |  |  |
| 68000pF             |             |          |     |     |     |     |     |     |     | p87 |     | p87 |     |     |     |     |     |     |     |     |     |      |     |     |     |  |  |
| 82000pF             |             |          |     |     |     |     |     |     |     | p87 |     |     |     |     |     |     |     |     |     |     |     |      |     |     |     |  |  |
| 0.10μF              |             |          |     |     |     |     |     |     |     | p87 |     | p87 |     |     |     |     |     |     |     |     |     |      |     |     |     |  |  |
| 0.12μF              |             |          |     |     |     |     |     |     |     |     | p87 |     |     |     |     |     |     |     |     |     |     |      |     |     |     |  |  |
| 0.15μF              |             |          |     |     |     |     |     |     |     |     | p87 |     |     |     |     |     |     |     |     |     |     |      |     |     |     |  |  |
| 0.18μF              |             |          |     |     |     |     |     |     |     |     | p87 |     |     |     |     |     |     |     |     |     |     |      |     |     |     |  |  |
| 0.22μF              |             |          |     |     |     |     |     |     |     |     |     | p87 |     |     |     |     |     |     |     |     |     |      |     |     |     |  |  |
| 0.27μF              |             |          |     |     |     |     |     |     |     |     |     |     | p87 |     |     |     |     |     |     |     |     |      |     |     |     |  |  |
| 0.33μF              |             |          |     |     |     |     |     |     |     |     |     |     |     | p87 |     |     |     |     |     |     |     |      |     |     |     |  |  |
| 0.39μF              |             |          |     |     |     |     |     |     |     |     |     |     |     |     | p87 |     |     |     |     |     |     |      |     |     |     |  |  |
| 0.47μF              |             |          |     |     |     |     |     |     |     |     |     |     |     |     |     | p87 |     |     |     |     |     |      |     |     |     |  |  |
| 0.56μF              |             |          |     |     |     |     |     |     |     |     |     |     |     |     |     |     | p87 |     |     |     |     |      |     |     |     |  |  |
| 0.68μF              |             |          |     |     |     |     |     |     |     |     |     |     |     |     |     |     |     | p87 |     |     |     |      |     |     |     |  |  |
| 0.82μF              |             |          |     |     |     |     |     |     |     |     |     |     |     |     |     |     |     |     | p87 |     |     |      |     |     |     |  |  |
| 1.0μF               |             |          |     |     |     |     |     |     |     |     |     |     |     |     |     |     |     |     |     | p87 |     |      |     |     |     |  |  |
| 1.5μF               |             |          |     |     |     |     |     |     |     |     |     |     |     |     |     |     |     |     |     |     | p87 |      |     |     |     |  |  |
| 2.2μF               |             |          |     |     |     |     |     |     |     |     |     |     |     |     |     |     |     |     |     |     |     | p87  |     |     |     |  |  |
| 3.3μF               |             |          |     |     |     |     |     |     |     |     |     |     |     |     |     |     |     |     |     |     |     |      | p87 |     |     |  |  |
| 4.7μF               |             |          |     |     |     |     |     |     |     |     |     |     |     |     |     |     |     |     |     |     |     |      |     | p87 |     |  |  |
| 10μF                |             | p86      |     |     |     |     |     |     |     |     |     |     |     |     |     |     |     |     |     |     |     |      |     |     |     |  |  |
| 22μF                |             |          |     |     |     |     |     |     |     |     |     |     |     |     |     |     |     |     |     |     |     |      |     |     |     |  |  |
| 47μF                |             |          |     |     |     |     |     |     |     |     |     |     |     |     |     |     |     |     |     |     |     |      |     |     |     |  |  |
| 100μF               |             |          |     |     |     |     |     |     |     |     |     |     |     |     |     |     |     |     |     |     |     |      |     |     |     |  |  |

Continued on the following page. ↗

# Capacitance Table

(→ GCM Series High Dielectric Constant Type)

p00 ← Part Number List    EIA: X7S X7T X7R X8R    Murata Temperature Characteristic: X8L X8M

| L×W (mm)            | 2.0×1.25 |     |     |     | 3.2×1.6 |     |     |     |     |     |     |     |     |     |     |     | 3.2×2.5 |     |     |     |     |     |     |     |     |     |    |
|---------------------|----------|-----|-----|-----|---------|-----|-----|-----|-----|-----|-----|-----|-----|-----|-----|-----|---------|-----|-----|-----|-----|-----|-----|-----|-----|-----|----|
|                     | 1.45     |     |     |     | 1.25    |     |     |     | 1.8 |     |     |     |     |     |     |     | 1.9     |     |     | 2.2 |     |     |     |     |     |     |    |
| T max. (mm)         |          |     |     |     |         |     |     |     |     |     |     |     |     |     |     |     |         |     |     |     |     |     |     |     |     |     |    |
| Rated Voltage (Vdc) | 25       |     | 16  |     | 100     | 50  |     |     | 25  | 100 |     |     |     | 50  |     |     |         | 25  | 16  | 10  | 6.3 | 35  |     | 25  | 100 |     | 10 |
| Cap. / TC Code      | X8L      | X7S | X8M | X7S | X7R     | X8L | X8R | X8L | X8R | X8L | X7S | X8L | X8R | X7R | X7S | X8R | X7R     | X7R | X7R | X7R | X8M | X7T | X7S | X8L | X7S | X8L |    |
| 100pF               |          |     |     |     |         |     |     |     |     |     |     |     |     |     |     |     |         |     |     |     |     |     |     |     |     |     |    |
| 120pF               |          |     |     |     |         |     |     |     |     |     |     |     |     |     |     |     |         |     |     |     |     |     |     |     |     |     |    |
| 150pF               |          |     |     |     |         |     |     |     |     |     |     |     |     |     |     |     |         |     |     |     |     |     |     |     |     |     |    |
| 180pF               |          |     |     |     |         |     |     |     |     |     |     |     |     |     |     |     |         |     |     |     |     |     |     |     |     |     |    |
| 220pF               |          |     |     |     |         |     |     |     |     |     |     |     |     |     |     |     |         |     |     |     |     |     |     |     |     |     |    |
| 270pF               |          |     |     |     |         |     |     |     |     |     |     |     |     |     |     |     |         |     |     |     |     |     |     |     |     |     |    |
| 330pF               |          |     |     |     |         |     |     |     |     |     |     |     |     |     |     |     |         |     |     |     |     |     |     |     |     |     |    |
| 390pF               |          |     |     |     |         |     |     |     |     |     |     |     |     |     |     |     |         |     |     |     |     |     |     |     |     |     |    |
| 470pF               |          |     |     |     |         |     |     |     |     |     |     |     |     |     |     |     |         |     |     |     |     |     |     |     |     |     |    |
| 560pF               |          |     |     |     |         |     |     |     |     |     |     |     |     |     |     |     |         |     |     |     |     |     |     |     |     |     |    |
| 680pF               |          |     |     |     |         |     |     |     |     |     |     |     |     |     |     |     |         |     |     |     |     |     |     |     |     |     |    |
| 820pF               |          |     |     |     |         |     |     |     |     |     |     |     |     |     |     |     |         |     |     |     |     |     |     |     |     |     |    |
| 1000pF              |          |     |     |     |         |     |     |     |     |     |     |     |     |     |     |     |         |     |     |     |     |     |     |     |     |     |    |
| 1200pF              |          |     |     |     |         |     |     |     |     |     |     |     |     |     |     |     |         |     |     |     |     |     |     |     |     |     |    |
| 1500pF              |          |     |     |     |         |     |     |     |     |     |     |     |     |     |     |     |         |     |     |     |     |     |     |     |     |     |    |
| 1800pF              |          |     |     |     |         |     |     |     |     |     |     |     |     |     |     |     |         |     |     |     |     |     |     |     |     |     |    |
| 2200pF              |          |     |     |     |         |     |     |     |     |     |     |     |     |     |     |     |         |     |     |     |     |     |     |     |     |     |    |
| 2700pF              |          |     |     |     |         |     |     |     |     |     |     |     |     |     |     |     |         |     |     |     |     |     |     |     |     |     |    |
| 3300pF              |          |     |     |     |         |     |     |     |     |     |     |     |     |     |     |     |         |     |     |     |     |     |     |     |     |     |    |
| 3900pF              |          |     |     |     |         |     |     |     |     |     |     |     |     |     |     |     |         |     |     |     |     |     |     |     |     |     |    |
| 4700pF              |          |     |     |     |         |     |     |     |     |     |     |     |     |     |     |     |         |     |     |     |     |     |     |     |     |     |    |
| 5600pF              |          |     |     |     |         |     |     |     |     |     |     |     |     |     |     |     |         |     |     |     |     |     |     |     |     |     |    |
| 6800pF              |          |     |     |     |         |     |     |     |     |     |     |     |     |     |     |     |         |     |     |     |     |     |     |     |     |     |    |
| 8200pF              |          |     |     |     |         |     |     |     |     |     |     |     |     |     |     |     |         |     |     |     |     |     |     |     |     |     |    |
| 0.10μF              |          |     |     |     |         |     |     |     |     |     |     |     |     |     |     |     |         |     |     |     |     |     |     |     |     |     |    |
| 0.12μF              |          |     |     |     |         |     |     |     |     |     |     |     |     |     |     |     |         |     |     |     |     |     |     |     |     |     |    |
| 0.15μF              |          |     |     |     |         |     |     |     |     |     |     |     |     |     |     |     |         |     |     |     |     |     |     |     |     |     |    |
| 0.18μF              |          |     |     |     |         |     |     |     |     |     |     |     |     |     |     |     |         |     |     |     |     |     |     |     |     |     |    |
| 0.22μF              |          |     |     |     |         | p88 |     |     |     |     |     |     |     |     |     |     |         |     |     |     |     |     |     |     |     |     |    |
| 0.27μF              |          |     |     |     |         |     |     |     |     |     |     |     |     |     |     |     |         |     |     |     |     |     |     |     |     |     |    |
| 0.33μF              |          |     |     |     |         |     |     |     |     |     |     |     |     |     |     |     |         |     |     |     |     |     |     |     |     |     |    |
| 0.39μF              |          |     |     |     |         |     |     |     |     |     |     |     |     |     |     |     |         |     |     |     |     |     |     |     |     |     |    |
| 0.47μF              |          |     |     |     |         |     |     |     |     |     |     |     |     |     |     |     |         |     |     |     |     |     |     |     |     |     |    |
| 0.56μF              |          |     |     |     |         |     |     |     |     |     |     |     |     |     |     |     |         |     |     |     |     |     |     |     |     |     |    |
| 0.68μF              |          |     |     |     |         |     |     |     |     |     |     |     |     |     |     |     |         |     |     |     |     |     |     |     |     |     |    |
| 0.82μF              |          |     |     |     |         |     |     |     |     |     |     |     |     |     |     |     |         |     |     |     |     |     |     |     |     |     |    |
| 1.0μF               |          |     |     |     |         |     |     |     |     |     |     |     |     |     |     |     |         |     |     |     |     |     |     |     |     |     |    |
| 1.5μF               |          |     |     |     |         |     |     |     |     |     |     |     |     |     |     |     |         |     |     |     |     |     |     |     |     |     |    |
| 2.2μF               |          |     |     |     |         |     |     |     |     |     |     |     |     |     |     |     |         |     |     |     |     |     |     |     |     |     |    |
| 3.3μF               |          |     |     |     |         |     |     |     |     |     |     |     |     |     |     |     |         |     |     |     |     |     |     |     |     |     |    |
| 4.7μF               |          | p88 |     |     |         |     |     |     |     |     |     |     |     |     |     |     |         |     |     |     |     |     |     |     |     |     |    |
| 10μF                |          |     |     |     |         |     |     |     |     |     |     |     |     |     |     |     |         |     |     |     |     |     |     |     |     |     |    |
| 22μF                |          |     |     |     |         |     |     |     |     |     |     |     |     |     |     |     |         |     |     |     |     |     |     |     |     |     |    |
| 47μF                |          |     |     |     |         |     |     |     |     |     |     |     |     |     |     |     |         |     |     |     |     |     |     |     |     |     |    |
| 100μF               |          |     |     |     |         |     |     |     |     |     |     |     |     |     |     |     |         |     |     |     |     |     |     |     |     |     |    |

Continued on the following page. ↗

# Capacitance Table

(→ GCM Series High Dielectric Constant Type)

p00 ← Part Number List    EIA: X7S X7T X7R X8R    Murata Temperature Characteristic: X8L X8M

| L×W (mm)            | 3.2×2.5 |     |     |     |     |     |      |     |     |     |     |  |
|---------------------|---------|-----|-----|-----|-----|-----|------|-----|-----|-----|-----|--|
|                     | 2.7     |     |     |     |     |     | 2.85 |     |     |     |     |  |
| T max. (mm)         | 50      |     |     |     |     |     | 25   |     |     |     |     |  |
| Rated Voltage (Vdc) | 35      |     |     | 16  |     |     | 10   |     |     | 6.3 |     |  |
| Cap. / TC Code      | X8L     | X7R | X7S | X7S | X7R | X7R | X7S  | X7R | X8L | X7S | X7T |  |
| 100pF               |         |     |     |     |     |     |      |     |     |     |     |  |
| 120pF               |         |     |     |     |     |     |      |     |     |     |     |  |
| 150pF               |         |     |     |     |     |     |      |     |     |     |     |  |
| 180pF               |         |     |     |     |     |     |      |     |     |     |     |  |
| 220pF               |         |     |     |     |     |     |      |     |     |     |     |  |
| 270pF               |         |     |     |     |     |     |      |     |     |     |     |  |
| 330pF               |         |     |     |     |     |     |      |     |     |     |     |  |
| 390pF               |         |     |     |     |     |     |      |     |     |     |     |  |
| 470pF               |         |     |     |     |     |     |      |     |     |     |     |  |
| 560pF               |         |     |     |     |     |     |      |     |     |     |     |  |
| 680pF               |         |     |     |     |     |     |      |     |     |     |     |  |
| 820pF               |         |     |     |     |     |     |      |     |     |     |     |  |
| 1000pF              |         |     |     |     |     |     |      |     |     |     |     |  |
| 1200pF              |         |     |     |     |     |     |      |     |     |     |     |  |
| 1500pF              |         |     |     |     |     |     |      |     |     |     |     |  |
| 1800pF              |         |     |     |     |     |     |      |     |     |     |     |  |
| 2200pF              |         |     |     |     |     |     |      |     |     |     |     |  |
| 2700pF              |         |     |     |     |     |     |      |     |     |     |     |  |
| 3300pF              |         |     |     |     |     |     |      |     |     |     |     |  |
| 3900pF              |         |     |     |     |     |     |      |     |     |     |     |  |
| 4700pF              |         |     |     |     |     |     |      |     |     |     |     |  |
| 5600pF              |         |     |     |     |     |     |      |     |     |     |     |  |
| 6800pF              |         |     |     |     |     |     |      |     |     |     |     |  |
| 8200pF              |         |     |     |     |     |     |      |     |     |     |     |  |
| 10000pF             |         |     |     |     |     |     |      |     |     |     |     |  |
| 12000pF             |         |     |     |     |     |     |      |     |     |     |     |  |
| 15000pF             |         |     |     |     |     |     |      |     |     |     |     |  |
| 18000pF             |         |     |     |     |     |     |      |     |     |     |     |  |
| 22000pF             |         |     |     |     |     |     |      |     |     |     |     |  |
| 27000pF             |         |     |     |     |     |     |      |     |     |     |     |  |
| 33000pF             |         |     |     |     |     |     |      |     |     |     |     |  |
| 39000pF             |         |     |     |     |     |     |      |     |     |     |     |  |
| 47000pF             |         |     |     |     |     |     |      |     |     |     |     |  |
| 56000pF             |         |     |     |     |     |     |      |     |     |     |     |  |
| 68000pF             |         |     |     |     |     |     |      |     |     |     |     |  |
| 82000pF             |         |     |     |     |     |     |      |     |     |     |     |  |
| 0.10μF              |         |     |     |     |     |     |      |     |     |     |     |  |
| 0.12μF              |         |     |     |     |     |     |      |     |     |     |     |  |
| 0.15μF              |         |     |     |     |     |     |      |     |     |     |     |  |
| 0.18μF              |         |     |     |     |     |     |      |     |     |     |     |  |
| 0.22μF              |         |     |     |     |     |     |      |     |     |     |     |  |
| 0.27μF              |         |     |     |     |     |     |      |     |     |     |     |  |
| 0.33μF              |         |     |     |     |     |     |      |     |     |     |     |  |
| 0.39μF              |         |     |     |     |     |     |      |     |     |     |     |  |
| 0.47μF              |         |     |     |     |     |     |      |     |     |     |     |  |
| 0.56μF              |         |     |     |     |     |     |      |     |     |     |     |  |
| 0.68μF              |         |     |     |     |     |     |      |     |     |     |     |  |
| 0.82μF              |         |     |     |     |     |     |      |     |     |     |     |  |
| 1.0μF               |         |     |     |     |     |     |      |     |     |     |     |  |
| 1.5μF               |         |     |     |     |     |     |      |     |     |     |     |  |
| 2.2μF               |         |     |     |     |     |     |      |     |     |     |     |  |
| 3.3μF               |         |     |     |     |     |     |      |     |     |     |     |  |
| 4.7μF               |         | p88 |     |     |     |     |      |     |     |     |     |  |
| 10μF                | p88     |     | p88 | p88 | p88 |     |      |     |     |     |     |  |
| 22μF                |         |     |     |     |     | p89 | p89  |     | p89 | p89 |     |  |
| 47μF                |         |     |     |     |     |     |      | p89 | p89 |     |     |  |
| 100μF               |         |     |     |     |     |     |      |     |     |     | p89 |  |

# Capacitance Table

## GC3 Series High Dielectric Constant Type

p00 ← Part Number List      EIA: X7T

| L×W (mm)            | 2.0×1.25 |      | 3.2×1.6 |      |     |     |     |     | 3.2×2.5 |     |     |     | 4.5×3.2 |     |     |     | 5.7×5.0 |     |     |     |     |     |
|---------------------|----------|------|---------|------|-----|-----|-----|-----|---------|-----|-----|-----|---------|-----|-----|-----|---------|-----|-----|-----|-----|-----|
|                     | 1.0      | 1.45 | 1.0     | 1.25 |     | 1.8 |     | 1.5 | 2.0     |     | 1.5 | 2.0 |         | 2.0 |     | 2.7 |         |     |     |     |     |     |
| T max. (mm)         | 250      | 250  | 450     | 250  | 630 | 450 | 250 | 630 | 450     | 250 | 630 | 250 | 630     | 450 | 250 | 630 | 450     | 250 | 630 | 250 | 630 | 250 |
| Rated Voltage (Vdc) | 250      | 250  | 450     | 250  | 630 | 450 | 250 | 630 | 450     | 250 | 630 | 250 | 630     | 450 | 250 | 630 | 450     | 250 | 630 | 250 | 630 | 250 |
| Cap. / TC Code      | X7T      | X7T  | X7T     | X7T  | X7T | X7T | X7T | X7T | X7T     | X7T | X7T | X7T | X7T     | X7T | X7T | X7T | X7T     | X7T | X7T | X7T | X7T | X7T |
| 10000pF             | p91      |      | p91     |      | p91 |     |     |     |         |     |     |     |         |     |     |     |         |     |     |     |     |     |
| 15000pF             | p91      |      | p91     |      |     |     | p91 |     |         |     |     |     |         |     |     |     |         |     |     |     |     |     |
| 22000pF             |          | p91  |         |      |     |     |     |     |         | p91 |     |     |         |     |     |     |         |     |     |     |     |     |
| 33000pF             |          |      | p91     |      |     |     |     |     |         |     |     |     | p91     |     |     |     |         |     |     |     |     |     |
| 47000pF             |          |      |         |      |     |     | p91 |     |         |     |     |     |         | p91 |     |     |         |     |     |     |     |     |
| 68000pF             |          |      |         |      |     |     |     |     |         |     |     |     | p91     |     |     |     |         |     |     |     |     |     |
| 0.10μF              |          |      |         |      |     |     |     |     |         |     |     | p91 |         |     |     |     |         |     |     |     |     |     |
| 0.15μF              |          |      |         |      |     |     |     |     |         |     |     |     |         | p91 |     |     |         |     |     |     |     |     |
| 0.22μF              |          |      |         |      |     |     |     |     |         |     |     |     |         |     | p91 |     |         |     |     |     |     |     |
| 0.33μF              |          |      |         |      |     |     |     |     |         |     |     |     |         |     |     | p91 |         |     |     |     |     |     |
| 0.47μF              |          |      |         |      |     |     |     |     |         |     |     |     |         |     |     |     | p91     |     |     |     |     |     |
| 0.68μF              |          |      |         |      |     |     |     |     |         |     |     |     |         |     |     |     |         | p91 |     |     |     |     |
| 1.0μF               |          |      |         |      |     |     |     |     |         |     |     |     |         |     |     |     |         |     |     |     |     | p91 |

# Capacitance Table

## GCJ Series High Dielectric Constant Type

p00 ← Part Number List    EIA: X7S X7T X7R X8R    Murata Temperature Characteristic: X8L X8M

| L×W (mm)            | 1.6×0.8 |     |     |     |     |     |     |     |     |     |     |     |     |     | 2.0×1.25 |     |     |      |     |     |     |      |     |     |     |     |     |     |     |
|---------------------|---------|-----|-----|-----|-----|-----|-----|-----|-----|-----|-----|-----|-----|-----|----------|-----|-----|------|-----|-----|-----|------|-----|-----|-----|-----|-----|-----|-----|
| T max. (mm)         | 0.9     |     |     |     |     |     |     |     |     |     |     |     |     |     | 1.0      |     |     | 0.95 |     | 1.0 |     | 1.45 |     |     |     |     |     |     |     |
| Rated Voltage (Vdc) | 100     |     |     | 50  |     |     | 35  |     | 25  |     |     | 16  |     | 10  |          | 6.3 |     | 6.3  |     |     | 100 | 50   | 25  | 16  | 250 | 250 | 100 | 50  |     |
| Cap. / TC Code      | X8L     | X8R | X7R | X8L | X8R | X7R | X8L | X8L | X8R | X7R | X8L | X7R | X7R | X7R | X8L      | X8M | X7S | X7R  | X7R | X7R | X7R | X7R  | X7R | X7R | X7R | X7R | X7R | X8L | X7R |
| 1000pF              |         | p93 | p93 |     |     | p93 |     |     |     |     |     |     |     |     |          |     |     |      |     |     |     |      |     |     |     |     |     |     |     |
| 1200pF              |         | p93 | p93 |     |     | p93 |     |     |     |     |     |     |     |     |          |     |     |      |     |     |     |      |     |     |     |     |     |     |     |
| 1500pF              |         | p93 | p93 |     |     | p93 |     |     |     |     |     |     |     |     |          |     |     |      |     |     |     |      |     |     |     |     |     |     |     |
| 1800pF              |         | p93 | p93 |     |     | p93 |     |     |     |     |     |     |     |     |          |     |     |      |     |     |     |      |     |     |     |     |     |     |     |
| 2200pF              |         | p93 | p93 |     |     | p94 |     |     |     |     |     |     |     |     |          |     |     |      |     |     |     |      |     |     |     |     |     |     |     |
| 2700pF              |         | p93 | p93 |     |     | p94 |     |     |     |     |     |     |     |     |          |     |     |      |     |     |     |      |     |     |     |     |     |     |     |
| 3300pF              |         | p93 | p93 |     |     | p94 |     |     |     |     |     |     |     |     |          |     |     |      |     |     |     |      |     |     |     |     |     |     |     |
| 3900pF              |         | p93 | p93 |     |     | p94 |     |     |     |     |     |     |     |     |          |     |     |      |     |     |     |      |     |     |     |     |     |     |     |
| 4700pF              |         | p93 | p93 |     | p93 | p94 |     |     |     |     |     |     |     |     |          |     |     |      |     |     |     |      |     |     |     |     |     |     |     |
| 5600pF              |         | p93 | p93 |     |     | p94 |     |     |     |     |     |     |     |     |          |     |     |      |     |     |     |      |     |     |     |     |     |     |     |
| 6800pF              |         | p93 | p93 |     |     | p94 |     |     |     |     |     |     |     |     |          |     |     |      |     |     |     |      |     |     |     |     |     |     |     |
| 8200pF              |         | p93 | p93 |     |     | p94 |     |     |     |     |     |     |     |     |          |     |     |      |     |     |     |      |     |     |     |     |     |     |     |
| 10000pF             |         | p93 | p93 |     | p93 | p94 |     |     |     |     |     |     |     |     |          |     |     |      |     |     |     |      |     |     |     |     |     |     |     |
| 12000pF             |         | p93 | p93 |     |     | p94 |     |     |     |     |     |     |     |     |          |     |     |      |     |     |     |      |     |     |     |     |     |     |     |
| 15000pF             |         | p93 | p93 |     |     | p94 |     |     |     |     |     |     |     |     |          |     |     |      |     |     |     |      |     |     |     |     |     |     |     |
| 18000pF             |         | p93 | p93 |     |     | p94 |     |     |     |     |     |     |     |     |          |     |     |      |     |     |     |      |     |     |     |     |     |     |     |
| 22000pF             |         | p93 | p93 |     |     | p94 |     |     |     |     |     |     |     |     |          |     |     |      |     |     |     |      |     |     |     |     |     |     |     |
| 27000pF             |         | p93 |     |     |     |     |     |     |     |     |     |     |     |     |          |     |     |      |     |     |     |      |     |     |     |     |     |     |     |
| 33000pF             |         | p93 |     |     |     | p94 | p94 | p94 |     |     |     |     |     |     |          |     |     |      |     |     |     |      |     |     |     |     |     |     |     |
| 39000pF             |         | p93 |     |     |     | p94 | p94 | p94 |     |     |     |     |     |     |          |     |     |      |     |     |     |      |     |     |     |     |     |     |     |
| 47000pF             |         | p93 |     |     |     | p94 |     |     |     |     |     |     |     |     |          |     |     |      |     |     |     |      |     |     |     |     |     |     |     |
| 56000pF             |         | p93 |     |     |     | p94 | p94 | p94 |     |     |     |     |     |     |          |     |     |      |     |     |     |      |     |     |     |     |     |     |     |
| 68000pF             |         | p93 |     |     |     | p94 | p94 | p94 |     |     |     |     |     |     |          |     |     |      |     |     |     |      |     |     |     |     |     |     |     |
| 82000pF             |         |     |     |     |     | p94 |     | p94 |     |     |     |     |     |     |          |     |     |      |     |     |     |      |     |     |     |     |     |     |     |
| 0.10μF              | p93     |     | p93 |     | p93 | p94 |     |     |     |     |     |     |     |     |          |     |     |      |     |     |     |      |     |     |     |     |     |     |     |
| 0.12μF              |         |     |     |     | p93 |     |     |     |     |     |     |     |     |     |          |     |     |      |     |     |     |      |     |     |     |     |     |     |     |
| 0.15μF              |         |     |     | p93 | p93 | p94 |     |     |     |     |     |     |     |     |          |     |     |      |     |     |     |      |     |     |     |     |     |     |     |
| 0.18μF              |         |     |     |     | p93 |     |     |     |     |     |     |     |     |     |          |     |     |      |     |     |     |      |     |     |     |     |     |     |     |
| 0.22μF              |         |     |     | p93 | p93 | p94 |     |     |     |     |     |     |     |     |          |     |     |      |     |     |     |      |     |     |     |     |     |     |     |
| 0.27μF              |         |     |     |     |     |     |     |     |     |     |     |     |     |     |          |     |     |      |     |     |     |      |     |     |     |     |     |     |     |
| 0.33μF              |         |     |     |     |     |     |     |     |     |     |     |     |     |     |          |     |     |      |     |     |     |      |     |     |     |     |     |     |     |
| 0.39μF              |         |     |     |     |     |     |     |     |     |     |     |     |     |     |          |     |     |      |     |     |     |      |     |     |     |     |     |     |     |
| 0.47μF              |         |     |     |     |     |     |     |     |     |     |     |     |     |     |          |     |     |      |     |     |     |      |     |     |     |     |     |     |     |
| 0.56μF              |         |     |     |     |     |     |     |     |     |     |     |     |     |     |          |     |     |      |     |     |     |      |     |     |     |     |     |     |     |
| 0.68μF              |         |     |     |     |     |     |     |     |     |     |     |     |     |     |          |     |     |      |     |     |     |      |     |     |     |     |     |     |     |
| 0.82μF              |         |     |     |     |     |     |     |     |     |     |     |     |     |     |          |     |     |      |     |     |     |      |     |     |     |     |     |     |     |
| 1.0μF               |         |     |     |     |     |     |     |     |     |     |     |     |     |     |          |     |     |      |     |     |     |      |     |     |     |     |     |     |     |
| 1.5μF               |         |     |     |     |     |     |     |     |     |     |     |     |     |     |          |     |     |      |     |     |     |      |     |     |     |     |     |     |     |
| 2.2μF               |         |     |     |     |     |     |     |     |     |     |     |     |     |     |          |     |     |      |     |     |     |      |     |     |     |     |     |     |     |
| 3.3μF               |         |     |     |     |     |     |     |     |     |     |     |     |     |     |          |     |     |      |     |     |     |      |     |     |     |     |     |     |     |
| 4.7μF               |         |     |     |     |     |     |     |     |     |     |     |     |     |     |          |     |     |      |     |     |     |      |     |     |     |     |     |     |     |
| 6.8μF               |         |     |     |     |     |     |     |     |     |     |     |     |     |     |          |     |     |      |     |     |     |      |     |     |     |     |     |     |     |
| 10μF                |         |     |     |     |     |     |     |     |     |     |     |     |     |     |          |     |     |      |     |     |     |      |     |     |     |     |     |     |     |
| 22μF                |         |     |     |     |     |     |     |     |     |     |     |     |     |     |          |     |     |      |     |     |     |      |     |     |     |     |     |     |     |
| 47μF                |         |     |     |     |     |     |     |     |     |     |     |     |     |     |          |     |     |      |     |     |     |      |     |     |     |     |     |     |     |

Continued on the following page. ↗



# Capacitance Table

(→ GCJ Series High Dielectric Constant Type)

p00 ← Part Number List    EIA: X7S X7T X7R X8R    Murata Temperature Characteristic: X8L X8M

| L×W (mm)            | 2.0×1.25 |     |     |     |     |      |     | 3.2×1.6 |      |     |     |     |     |     |     |     |      |     |     |     |     |     |     |     |     |     |     |
|---------------------|----------|-----|-----|-----|-----|------|-----|---------|------|-----|-----|-----|-----|-----|-----|-----|------|-----|-----|-----|-----|-----|-----|-----|-----|-----|-----|
|                     | 1.45     |     |     |     | 1.5 | 1.25 |     |         | 1.35 |     |     |     |     |     | 1.8 |     |      | 1.9 |     |     |     |     |     |     |     |     |     |
| T max. (mm)         | 35       |     | 25  |     | 16  |      | 10  | 100     | 1000 | 630 | 250 | 100 | 50  | 35  | 25  | 16  | 1000 | 630 | 250 | 100 |     | 50  |     | 35  | 25  |     |     |
| Rated Voltage (Vdc) | X8L      | X8L | X7R | X8L | X7R | X7R  | X7S | X7R     | X7R  | X7R | X7R | X7R | X7R | X8L | X7R | X8L | X7R  | X7R | X7R | X8L | X7R | X7S | X7R | X7S | X8L | X7R |     |
| Cap. / TC Code      | X8L      | X8L | X7R | X8L | X7R | X7R  | X7S | X7R     | X7R  | X7R | X7R | X7R | X7R | X8L | X7R | X8L | X7R  | X7R | X7R | X8L | X7R | X7S | X7R | X7S | X8L | X7R |     |
| 1000pF              |          |     |     |     |     |      |     | p97     | p97  |     |     |     |     |     |     |     |      |     |     |     |     |     |     |     |     |     |     |
| 1200pF              |          |     |     |     |     |      |     |         |      |     |     |     |     |     |     |     |      |     |     |     |     |     |     |     |     |     |     |
| 1500pF              |          |     |     |     |     |      |     | p97     | p97  |     |     |     |     |     |     |     |      |     |     |     |     |     |     |     |     |     |     |
| 1800pF              |          |     |     |     |     |      |     |         |      |     |     |     |     |     |     |     |      |     |     |     |     |     |     |     |     |     |     |
| 2200pF              |          |     |     |     |     |      |     | p97     | p97  |     |     |     |     |     |     |     |      |     |     |     |     |     |     |     |     |     |     |
| 2700pF              |          |     |     |     |     |      |     |         |      |     |     |     |     |     |     |     |      |     |     |     |     |     |     |     |     |     |     |
| 3300pF              |          |     |     |     |     |      |     | p97     | p97  |     |     |     |     |     |     |     |      |     |     |     |     |     |     |     |     |     |     |
| 3900pF              |          |     |     |     |     |      |     |         |      |     |     |     |     |     |     |     |      |     |     |     |     |     |     |     |     |     |     |
| 4700pF              |          |     |     |     |     |      |     | p97     | p97  |     |     |     |     |     |     |     |      |     |     |     |     |     |     |     |     |     |     |
| 5600pF              |          |     |     |     |     |      |     |         |      |     |     |     |     |     |     |     |      |     |     |     |     |     |     |     |     |     |     |
| 6800pF              |          |     |     |     |     |      |     |         | p97  |     |     |     |     |     |     |     |      | p97 |     |     |     |     |     |     |     |     |     |
| 8200pF              |          |     |     |     |     |      |     |         |      |     |     |     |     |     |     |     |      |     |     |     |     |     |     |     |     |     |     |
| 10000pF             |          |     |     |     |     |      |     | p97     |      |     |     |     |     |     |     |     |      | p97 |     |     |     |     |     |     |     |     |     |
| 12000pF             |          |     |     |     |     |      |     |         |      |     |     |     |     |     |     |     |      |     |     |     |     |     |     |     |     |     |     |
| 15000pF             |          |     |     |     |     |      |     |         | p97  |     |     |     |     |     |     |     |      |     | p97 |     |     |     |     |     |     |     |     |
| 18000pF             |          |     |     |     |     |      |     |         |      |     |     |     |     |     |     |     |      |     |     |     |     |     |     |     |     |     |     |
| 22000pF             |          |     |     |     |     |      |     |         | p97  |     |     |     |     |     |     |     |      |     | p97 |     |     |     |     |     |     |     |     |
| 27000pF             |          |     |     |     |     |      |     |         |      |     |     |     |     |     |     |     |      |     |     |     |     |     |     |     |     |     |     |
| 33000pF             |          |     |     |     |     |      |     |         |      |     |     |     |     |     |     |     |      |     |     |     |     |     | p97 |     |     |     |     |
| 39000pF             |          |     |     |     |     |      |     |         |      |     |     |     |     |     |     |     |      |     |     |     |     |     |     |     |     |     |     |
| 47000pF             |          |     |     |     |     |      |     |         |      |     |     |     |     |     |     |     |      |     |     |     |     |     |     | p97 |     |     |     |
| 56000pF             |          |     |     |     |     |      |     |         |      |     |     |     |     |     |     |     |      |     |     |     |     |     |     |     |     |     |     |
| 68000pF             |          |     |     |     |     |      |     |         | p97  |     |     |     |     |     |     |     |      |     |     |     |     |     |     |     |     |     |     |
| 82000pF             |          |     |     |     |     |      |     |         |      |     |     |     |     |     |     |     |      |     |     |     |     |     |     |     |     |     |     |
| 0.10μF              |          |     |     |     |     |      |     |         |      |     |     |     |     |     |     |     |      |     |     |     |     |     |     |     |     | p97 |     |
| 0.12μF              | p96      | p96 |     |     |     |      |     |         |      |     |     |     |     |     |     |     |      |     |     |     |     |     |     |     |     |     |     |
| 0.15μF              | p96      | p96 |     |     |     |      |     |         |      |     |     | p97 |     |     |     |     |      |     |     |     |     |     |     |     |     |     |     |
| 0.18μF              | p96      | p96 |     |     |     |      |     |         |      |     |     | p97 |     |     |     |     |      |     |     |     |     |     |     |     |     |     |     |
| 0.22μF              | p96      | p96 |     |     |     |      |     |         |      |     |     | p97 |     |     |     |     |      |     |     |     |     |     |     |     |     |     |     |
| 0.27μF              |          | p96 | p96 |     |     | p96  |     |         |      |     |     |     |     |     |     |     |      |     |     |     |     |     |     |     |     |     |     |
| 0.33μF              | p96      | p96 | p96 |     |     | p96  |     |         |      |     |     |     |     |     |     |     |      |     |     |     |     |     |     |     |     |     |     |
| 0.39μF              |          | p96 | p96 |     |     | p96  |     |         |      |     |     |     |     |     |     |     |      |     |     |     |     |     |     |     |     |     |     |
| 0.47μF              | p96      | p96 | p96 |     |     | p96  |     |         |      |     |     | p97 | p97 |     |     |     |      |     |     |     |     |     |     |     |     |     |     |
| 0.56μF              |          |     | p96 | p96 | p96 |      |     |         |      |     |     | p97 |     |     |     |     |      |     |     |     |     |     |     |     |     | p97 |     |
| 0.68μF              | p96      | p96 | p96 | p96 |     |      |     |         |      |     |     | p97 |     |     |     |     |      |     |     |     |     |     |     |     |     | p97 | p97 |
| 0.82μF              | p96      | p96 | p96 | p96 |     |      |     |         |      |     |     | p97 |     |     |     |     |      |     |     |     |     |     |     |     |     | p97 | p97 |
| 1.0μF               | p96      | p96 | p96 | p96 |     |      | p97 |         |      |     |     | p97 |     |     |     |     |      |     |     |     | p97 | p97 |     |     |     | p97 | p97 |
| 1.5μF               |          |     | p96 |     |     | p96  |     |         |      |     |     |     |     |     |     |     |      |     |     |     |     |     |     |     |     |     | p97 |
| 2.2μF               |          |     | p96 |     |     | p96  | p96 |         |      |     |     |     |     |     | p97 | p97 | p97  |     |     |     |     |     |     | p97 | p97 |     |     |
| 3.3μF               |          |     |     |     |     |      |     |         |      |     |     |     |     |     | p97 |     |      |     |     |     |     |     |     |     |     |     |     |
| 4.7μF               |          |     |     |     |     | p96  |     |         |      |     |     |     |     |     |     |     |      |     |     |     |     |     |     |     |     | p97 | p97 |
| 6.8μF               |          |     |     |     |     |      |     |         |      |     |     |     |     |     |     |     |      |     |     |     |     |     |     |     |     |     |     |
| 10μF                |          |     |     |     |     |      | p97 |         |      |     |     |     |     |     |     |     |      |     |     |     |     |     |     |     |     |     |     |
| 22μF                |          |     |     |     |     |      |     |         |      |     |     |     |     |     |     |     |      |     |     |     |     |     |     |     |     |     |     |
| 47μF                |          |     |     |     |     |      |     |         |      |     |     |     |     |     |     |     |      |     |     |     |     |     |     |     |     |     |     |

Continued on the following page. ↗

# Capacitance Table

(→ GCJ Series High Dielectric Constant Type)

p00 ← Part Number List

EIA: X7S X7T X7R X8R

Murata Temperature Characteristic: X8L X8M

| L×W (mm)            | 3.2×1.6 |     |     |     |     |     |     |     |     |     | 3.2×2.5 |      |     |     |     |     |     |     |     |     | 4.5×3.2 |      |     |     |     |     |
|---------------------|---------|-----|-----|-----|-----|-----|-----|-----|-----|-----|---------|------|-----|-----|-----|-----|-----|-----|-----|-----|---------|------|-----|-----|-----|-----|
| T max. (mm)         | 1.9     |     |     |     |     | 2.0 |     |     |     |     | 1.5     |      | 2.0 |     | 2.3 |     |     | 2.8 |     |     |         | 2.85 | 1.5 |     |     |     |
| Rated Voltage (Vdc) | 16      |     | 10  |     | 6.3 | 35  |     | 25  |     | 630 | 250     | 1000 | 630 | 250 | 100 |     |     | 50  | 25  | 16  |         | 6.3  | 25  | 630 |     |     |
| Cap. / TC Code      | X8L     | X7R | X8L | X7R | X7R | X7T | X8L | X7S | X7R | X7R | X7R     | X7R  | X7R | X8L | X7R | X7S | X7R | X7S | X8L | X7R | X8R     | X7R  | X7R | X8L | X7S | X7R |
| 1000pF              |         |     |     |     |     |     |     |     |     |     |         |      |     |     |     |     |     |     |     |     |         |      |     |     |     |     |
| 1200pF              |         |     |     |     |     |     |     |     |     |     |         |      |     |     |     |     |     |     |     |     |         |      |     |     |     |     |
| 1500pF              |         |     |     |     |     |     |     |     |     |     |         |      |     |     |     |     |     |     |     |     |         |      |     |     |     |     |
| 1800pF              |         |     |     |     |     |     |     |     |     |     |         |      |     |     |     |     |     |     |     |     |         |      |     |     |     |     |
| 2200pF              |         |     |     |     |     |     |     |     |     |     |         |      |     |     |     |     |     |     |     |     |         |      |     |     |     |     |
| 2700pF              |         |     |     |     |     |     |     |     |     |     |         |      |     |     |     |     |     |     |     |     |         |      |     |     |     |     |
| 3300pF              |         |     |     |     |     |     |     |     |     |     |         |      |     |     |     |     |     |     |     |     |         |      |     |     |     |     |
| 3900pF              |         |     |     |     |     |     |     |     |     |     |         |      |     |     |     |     |     |     |     |     |         |      |     |     |     |     |
| 4700pF              |         |     |     |     |     |     |     |     |     |     |         |      |     |     |     |     |     |     |     |     |         |      |     |     |     |     |
| 5600pF              |         |     |     |     |     |     |     |     |     |     |         |      |     |     |     |     |     |     |     |     |         |      |     |     |     |     |
| 6800pF              |         |     |     |     |     |     |     |     |     |     |         |      |     |     |     |     |     |     |     |     |         |      |     |     |     |     |
| 8200pF              |         |     |     |     |     |     |     |     |     |     |         |      |     |     |     |     |     |     |     |     |         |      |     |     |     |     |
| 10000pF             |         |     |     |     |     |     |     |     |     |     |         |      |     |     |     |     |     |     |     |     |         |      |     |     |     |     |
| 12000pF             |         |     |     |     |     |     |     |     |     |     |         |      |     |     |     |     |     |     |     |     |         |      |     |     |     |     |
| 15000pF             |         |     |     |     |     |     |     |     |     |     |         |      |     |     |     |     |     |     |     |     |         |      |     |     |     |     |
| 18000pF             |         |     |     |     |     |     |     |     |     |     |         |      |     |     |     |     |     |     |     |     |         |      |     |     |     |     |
| 22000pF             |         |     |     |     |     |     |     |     |     |     |         |      |     |     |     |     |     |     |     |     |         |      |     |     |     |     |
| 27000pF             |         |     |     |     |     |     |     |     |     |     |         |      |     |     |     |     |     |     |     |     |         |      |     |     |     |     |
| 33000pF             |         |     |     |     |     |     |     |     |     |     |         |      |     |     |     |     |     |     |     |     |         |      |     |     |     |     |
| 39000pF             |         |     |     |     |     |     |     |     |     |     |         |      |     |     |     |     |     |     |     |     |         |      |     |     |     |     |
| 47000pF             |         |     |     |     |     |     |     |     |     |     |         |      |     |     |     |     |     |     |     |     |         |      |     |     |     |     |
| 56000pF             |         |     |     |     |     |     |     |     |     |     |         |      |     |     |     |     |     |     |     |     |         |      |     |     |     |     |
| 68000pF             |         |     |     |     |     |     |     |     |     |     |         |      |     |     |     |     |     |     |     |     |         |      |     |     |     |     |
| 82000pF             |         |     |     |     |     |     |     |     |     |     |         |      |     |     |     |     |     |     |     |     |         |      |     |     |     |     |
| 0.10μF              |         |     |     |     |     |     |     |     |     |     |         |      |     |     |     |     |     |     |     |     |         |      |     |     |     |     |
| 0.12μF              |         |     |     |     |     |     |     |     |     |     |         |      |     |     |     |     |     |     |     |     |         |      |     |     |     |     |
| 0.15μF              |         |     |     |     |     |     |     |     |     |     |         |      |     |     |     |     |     |     |     |     |         |      |     |     |     |     |
| 0.18μF              |         |     |     |     |     |     |     |     |     |     |         |      |     |     |     |     |     |     |     |     |         |      |     |     |     |     |
| 0.22μF              |         |     |     |     |     |     |     |     |     |     |         |      |     |     |     |     |     |     |     |     |         |      |     |     |     |     |
| 0.27μF              |         |     |     |     |     |     |     |     |     |     |         |      |     |     |     |     |     |     |     |     |         |      |     |     |     |     |
| 0.33μF              |         |     |     |     |     |     |     |     |     |     |         |      |     |     |     |     |     |     |     |     |         |      |     |     |     |     |
| 0.39μF              |         |     |     |     |     |     |     |     |     |     |         |      |     |     |     |     |     |     |     |     |         |      |     |     |     |     |
| 0.47μF              |         |     |     |     |     |     |     |     |     |     |         |      |     |     |     |     |     |     |     |     |         |      |     |     |     |     |
| 0.56μF              |         |     |     |     |     |     |     |     |     |     |         |      |     |     |     |     |     |     |     |     |         |      |     |     |     |     |
| 0.68μF              |         |     |     |     |     |     |     |     |     |     |         |      |     |     |     |     |     |     |     |     |         |      |     |     |     |     |
| 0.82μF              |         |     |     |     |     |     |     |     |     |     |         |      |     |     |     |     |     |     |     |     |         |      |     |     |     |     |
| 1.0μF               |         |     |     |     |     |     |     |     |     |     |         |      |     |     |     |     |     |     |     |     |         |      |     |     |     |     |
| 1.5μF               |         |     |     |     |     |     |     |     |     |     |         |      |     |     |     |     |     |     |     |     |         |      |     |     |     |     |
| 2.2μF               |         |     |     |     |     |     |     |     |     |     |         |      |     |     |     |     |     |     |     |     |         |      |     |     |     |     |
| 3.3μF               | p97     | p97 |     |     |     |     |     |     |     |     |         |      |     |     |     |     |     |     |     |     |         |      |     |     |     |     |
| 4.7μF               | p97     | p97 |     |     |     |     |     |     |     |     |         |      |     |     |     |     |     |     |     |     |         |      |     |     |     |     |
| 6.8μF               |         |     |     |     | p97 |     |     |     |     |     |         |      |     |     |     |     |     |     |     |     |         |      |     |     |     |     |
| 10μF                |         | p97 |     |     | p97 |     | p97 | p98 | p98 |     |         |      |     |     |     |     |     |     |     |     |         |      |     |     |     |     |
| 22μF                |         |     | p97 | p97 | p97 |     |     |     |     |     |         |      |     |     |     |     |     |     |     |     |         |      |     |     |     |     |
| 47μF                |         |     |     |     |     |     |     |     |     |     |         |      |     |     |     |     |     |     |     |     |         |      |     |     |     |     |

Continued on the following page. ↗

# Capacitance Table

(→ GCJ Series High Dielectric Constant Type)

p00 ← Part Number List    EIA: X7S X7T X7R X8R

Murata Temperature Characteristic: X8L X8M

| L×W (mm)            | 4.5×3.2     |      |     |     | 5.7×5.0 |     |     |
|---------------------|-------------|------|-----|-----|---------|-----|-----|
|                     | T max. (mm) | 2.0  |     |     | 2.0     |     |     |
| Rated Voltage (Vdc) | 250         | 1000 | 630 | 250 | 1000    | 630 | 250 |
| Cap. / TC Code      | X7R         | X7R  | X7R | X7R | X7R     | X7R | X7R |
| 1000pF              |             |      |     |     |         |     |     |
| 1200pF              |             |      |     |     |         |     |     |
| 1500pF              |             |      |     |     |         |     |     |
| 1800pF              |             |      |     |     |         |     |     |
| 2200pF              |             |      |     |     |         |     |     |
| 2700pF              |             |      |     |     |         |     |     |
| 3300pF              |             |      |     |     |         |     |     |
| 3900pF              |             |      |     |     |         |     |     |
| 4700pF              |             |      |     |     |         |     |     |
| 5600pF              |             |      |     |     |         |     |     |
| 6800pF              |             |      |     |     |         |     |     |
| 8200pF              |             |      |     |     |         |     |     |
| 10000pF             |             |      |     |     |         |     |     |
| 12000pF             |             |      |     |     |         |     |     |
| 15000pF             |             |      |     |     |         |     |     |
| 18000pF             |             |      |     |     |         |     |     |
| 22000pF             |             |      |     |     |         |     |     |
| 27000pF             |             |      |     |     |         |     |     |
| 33000pF             |             | p98  | p98 |     |         |     |     |
| 39000pF             |             |      |     |     |         |     |     |
| 47000pF             |             | p98  | p98 |     |         |     |     |
| 56000pF             |             |      |     |     |         |     |     |
| 68000pF             |             |      |     |     | p98     |     |     |
| 82000pF             |             |      |     |     |         |     |     |
| 0.10μF              |             |      | p98 |     | p98     | p98 |     |
| 0.12μF              |             |      |     |     |         |     |     |
| 0.15μF              | p98         |      |     |     |         | p98 |     |
| 0.18μF              |             |      |     |     |         |     |     |
| 0.22μF              |             |      |     | p98 |         | p98 |     |
| 0.27μF              |             |      |     |     |         |     |     |
| 0.33μF              |             |      |     | p98 |         |     | p98 |
| 0.39μF              |             |      |     |     |         |     |     |
| 0.47μF              |             |      |     | p98 |         |     | p98 |
| 0.56μF              |             |      |     |     |         |     |     |
| 0.68μF              |             |      |     |     |         |     | p98 |
| 0.82μF              |             |      |     |     |         |     |     |
| 1.0μF               |             |      |     |     |         |     | p98 |
| 1.5μF               |             |      |     |     |         |     |     |
| 2.2μF               |             |      |     |     |         |     |     |
| 3.3μF               |             |      |     |     |         |     |     |
| 4.7μF               |             |      |     |     |         |     |     |
| 6.8μF               |             |      |     |     |         |     |     |
| 10μF                |             |      |     |     |         |     |     |
| 22μF                |             |      |     |     |         |     |     |
| 47μF                |             |      |     |     |         |     |     |

# Capacitance Table

## GCQ Series Temperature Compensating Type

p00 ← Part Number List

EIA: **COG**

| L×W (mm)            | 1.0×0.5 | L×W (mm)            | 1.0×0.5 | L×W (mm)            | 1.0×0.5 |
|---------------------|---------|---------------------|---------|---------------------|---------|
| T max. (mm)         | 0.55    | T max. (mm)         | 0.55    | T max. (mm)         | 0.55    |
| Rated Voltage (Vdc) | 50      | Rated Voltage (Vdc) | 50      | Rated Voltage (Vdc) | 50      |
| Cap. / TC Code      | COG     | Cap. / TC Code      | COG     | Cap. / TC Code      | COG     |
| 0.10pF              | p101    | 3.1pF               | p102    | 8.6pF               | p104    |
| 0.11pF              | p101    | 3.2pF               | p102    | 8.7pF               | p104    |
| 0.12pF              | p101    | 3.3pF               | p102    | 8.8pF               | p104    |
| 0.13pF              | p101    | 3.4pF               | p102    | 8.9pF               | p104    |
| 0.15pF              | p101    | 3.5pF               | p102    | 9.0pF               | p104    |
| 0.16pF              | p101    | 3.6pF               | p102    | 9.1pF               | p104    |
| 0.18pF              | p101    | 3.7pF               | p102    | 9.2pF               | p104    |
| 0.20pF              | p101    | 3.8pF               | p102    | 9.3pF               | p104    |
| 0.22pF              | p101    | 3.9pF               | p102    | 9.4pF               | p105    |
| 0.24pF              | p101    | 4.0pF               | p103    | 9.5pF               | p105    |
| 0.25pF              | p101    | 4.1pF               | p103    | 9.6pF               | p105    |
| 0.27pF              | p101    | 4.2pF               | p103    | 9.7pF               | p105    |
| 0.30pF              | p101    | 4.3pF               | p103    | 9.8pF               | p105    |
| 0.33pF              | p101    | 4.4pF               | p103    | 9.9pF               | p105    |
| 0.36pF              | p101    | 4.5pF               | p103    | 10pF                | p105    |
| 0.39pF              | p101    | 4.6pF               | p103    | 11pF                | p105    |
| 0.40pF              | p101    | 4.7pF               | p103    | 12pF                | p105    |
| 0.43pF              | p101    | 4.8pF               | p103    | 13pF                | p105    |
| 0.45pF              | p101    | 4.9pF               | p103    | 14pF                | p105    |
| 0.47pF              | p101    | 5.0pF               | p103    | 15pF                | p105    |
| 0.50pF              | p101    | 5.1pF               | p103    | 16pF                | p105    |
| 0.51pF              | p101    | 5.2pF               | p103    | 17pF                | p105    |
| 0.56pF              | p101    | 5.3pF               | p103    | 18pF                | p105    |
| 0.60pF              | p101    | 5.4pF               | p103    | 19pF                | p105    |
| 0.62pF              | p101    | 5.5pF               | p103    | 20pF                | p105    |
| 0.68pF              | p101    | 5.6pF               | p103    | 22pF                | p105    |
| 0.70pF              | p101    | 5.7pF               | p103    | 24pF                | p105    |
| 0.75pF              | p101    | 5.8pF               | p103    | 27pF                | p105    |
| 0.80pF              | p101    | 5.9pF               | p103    | 30pF                | p105    |
| 0.82pF              | p101    | 6.0pF               | p103    | 33pF                | p105    |
| 0.85pF              | p101    | 6.1pF               | p103    | 36pF                | p105    |
| 0.90pF              | p101    | 6.2pF               | p103    | 39pF                | p105    |
| 0.91pF              | p101    | 6.3pF               | p103    | 43pF                | p105    |
| 0.95pF              | p101    | 6.4pF               | p103    | 47pF                | p105    |
| 1.0pF               | p101    | 6.5pF               | p103    |                     |         |
| 1.1pF               | p101    | 6.6pF               | p103    |                     |         |
| 1.2pF               | p101    | 6.7pF               | p104    |                     |         |
| 1.3pF               | p102    | 6.8pF               | p104    |                     |         |
| 1.4pF               | p102    | 6.9pF               | p104    |                     |         |
| 1.5pF               | p102    | 7.0pF               | p104    |                     |         |
| 1.6pF               | p102    | 7.1pF               | p104    |                     |         |
| 1.7pF               | p102    | 7.2pF               | p104    |                     |         |
| 1.8pF               | p102    | 7.3pF               | p104    |                     |         |
| 1.9pF               | p102    | 7.4pF               | p104    |                     |         |
| 2.0pF               | p102    | 7.5pF               | p104    |                     |         |
| 2.1pF               | p102    | 7.6pF               | p104    |                     |         |
| 2.2pF               | p102    | 7.7pF               | p104    |                     |         |
| 2.3pF               | p102    | 7.8pF               | p104    |                     |         |
| 2.4pF               | p102    | 7.9pF               | p104    |                     |         |
| 2.5pF               | p102    | 8.0pF               | p104    |                     |         |
| 2.6pF               | p102    | 8.1pF               | p104    |                     |         |
| 2.7pF               | p102    | 8.2pF               | p104    |                     |         |
| 2.8pF               | p102    | 8.3pF               | p104    |                     |         |
| 2.9pF               | p102    | 8.4pF               | p104    |                     |         |
| 3.0pF               | p102    | 8.5pF               | p104    |                     |         |

## GCD Series High Dielectric Constant Type

p00 ← Part Number List

EIA: **X7S X7R**

| L×W (mm)            | 1.6×0.8 |      |      | 2.0×1.25 |      |      |
|---------------------|---------|------|------|----------|------|------|
| T max. (mm)         | 0.9     |      |      | 1.4      |      |      |
| Rated Voltage (Vdc) | 100     | 50   | 25   | 100      | 50   | 16   |
| Cap. / TC Code      | X7R     | X7R  | X7R  | X7R      | X7R  | X7S  |
| 1000pF              | p107    | p107 |      |          |      |      |
| 1200pF              | p107    | p107 |      |          |      |      |
| 1500pF              | p107    | p107 |      |          |      |      |
| 1800pF              | p107    | p107 |      |          |      |      |
| 2200pF              | p107    | p107 |      |          |      |      |
| 2700pF              | p107    | p107 |      |          |      |      |
| 3300pF              | p107    | p107 |      |          |      |      |
| 3900pF              | p107    | p107 |      |          |      |      |
| 4700pF              | p107    | p107 |      |          |      |      |
| 5600pF              | p107    | p107 |      |          |      |      |
| 6800pF              | p107    | p107 |      |          |      |      |
| 8200pF              | p107    | p107 |      |          |      |      |
| 10000pF             | p107    | p107 |      |          |      |      |
| 12000pF             | p107    | p107 |      |          |      |      |
| 15000pF             | p107    | p107 |      |          |      |      |
| 18000pF             | p107    | p107 |      |          |      |      |
| 22000pF             | p107    | p107 |      |          |      |      |
| 27000pF             |         |      | p107 | p107     | p107 |      |
| 33000pF             |         |      | p107 | p107     | p107 |      |
| 39000pF             |         |      | p107 | p107     | p107 |      |
| 47000pF             |         |      | p107 | p107     | p107 |      |
| 56000pF             |         |      |      | p107     | p107 |      |
| 68000pF             |         |      |      | p107     | p108 |      |
| 82000pF             |         |      |      | p107     | p108 |      |
| 0.10μF              |         |      |      | p107     | p108 |      |
| 0.47μF              |         |      |      |          |      | p108 |

# Capacitance Table

## GCE Series High Dielectric Constant Type

p00 ← Part Number List      EIA: X7R

| L×W (mm)            | 1.6×0.8     |      |      | 2.0×1.25 |      |     |
|---------------------|-------------|------|------|----------|------|-----|
|                     | T max. (mm) |      |      |          |      |     |
| T max. (mm)         |             | 0.9  |      |          | 1.45 |     |
| Rated Voltage (Vdc) |             | 100  | 50   | 25       | 100  | 50  |
| Cap. / TC Code      |             | X7R  | X7R  | X7R      | X7R  | X7R |
| 1000pF              | p110        | p110 |      |          |      |     |
| 1200pF              | p110        | p110 |      |          |      |     |
| 1500pF              | p110        | p110 |      |          |      |     |
| 1800pF              | p110        | p110 |      |          |      |     |
| 2200pF              | p110        | p110 |      |          |      |     |
| 2700pF              | p110        | p110 |      |          |      |     |
| 3300pF              | p110        | p110 |      |          |      |     |
| 3900pF              | p110        | p110 |      |          |      |     |
| 4700pF              | p110        | p110 |      |          |      |     |
| 5600pF              | p110        | p110 |      |          |      |     |
| 6800pF              | p110        | p110 |      |          |      |     |
| 8200pF              | p110        | p110 |      |          |      |     |
| 10000pF             | p110        | p110 |      |          |      |     |
| 12000pF             | p110        | p110 |      |          |      |     |
| 15000pF             | p110        | p110 |      |          |      |     |
| 18000pF             | p110        | p110 |      |          |      |     |
| 22000pF             | p110        | p110 |      |          |      |     |
| 27000pF             |             |      | p110 | p110     | p110 |     |
| 33000pF             |             |      | p110 | p110     | p110 |     |
| 39000pF             |             |      | p110 | p110     | p110 |     |
| 47000pF             |             |      | p110 | p110     | p110 |     |
| 56000pF             |             |      |      | p110     | p110 |     |
| 68000pF             |             |      |      | p110     | p111 |     |
| 82000pF             |             |      |      | p110     | p111 |     |
| 0.10μF              |             |      |      | p110     | p111 |     |

## NFM Series

p00 ← Part Number List

| L×W (mm)            | 1.6×0.8     |      | 2.0×1.25 |      | 3.2×1.6 |      |      |    |
|---------------------|-------------|------|----------|------|---------|------|------|----|
|                     | T max. (mm) |      |          |      |         |      |      |    |
| T max. (mm)         |             | 0.7  |          | 0.95 |         | 1.5  |      |    |
| Rated Voltage (Vdc) |             | 16   | 6.3      | 50   | 16      | 10   | 100  | 50 |
| Cap. / TC Code      |             | -    | -        | -    | -       | -    | -    | -  |
| 220pF               |             |      |          | p114 |         |      |      |    |
| 470pF               |             |      |          | p114 |         |      |      |    |
| 1000pF              |             |      |          | p114 |         |      |      |    |
| 2200pF              |             |      |          | p114 |         |      |      |    |
| 10000pF             |             |      |          |      |         | p114 | p114 |    |
| 15000pF             |             |      |          |      |         |      | p114 |    |
| 22000pF             |             |      |          | p114 |         |      | p114 |    |
| 0.10μF              |             |      |          |      |         | p114 | p114 |    |
| 0.22μF              |             |      |          |      |         | p114 |      |    |
| 0.47μF              |             |      |          |      |         | p114 |      |    |
| 1.0μF               | p114        | p114 |          | p114 |         |      |      |    |

## KCM Series Temperature Compensating Type

p00 ← Part Number List      EIA: COG U2J

| L×W (mm)            | 6.1×5.1     |      |      |     |      |      |      |      |      |
|---------------------|-------------|------|------|-----|------|------|------|------|------|
|                     | T max. (mm) |      |      |     |      |      |      |      |      |
| T max. (mm)         |             | 3.1  |      | 3.9 |      | 5.1  |      | 6.6  |      |
| Rated Voltage (Vdc) |             | 1000 | 630  | 630 | 1000 | 630  | 630  | 1000 | 630  |
| Cap. / TC Code      |             | U2J  | COG  | U2J | COG  | U2J  | COG  | U2J  | COG  |
| 8200pF              | p117        |      |      |     |      |      |      |      |      |
| 10000pF             | p117        |      |      |     |      |      |      |      |      |
| 0.015μF             |             | p117 |      |     |      |      |      |      |      |
| 0.016μF             |             |      |      |     |      | p117 |      |      |      |
| 0.018μF             |             | p117 |      |     |      |      |      |      |      |
| 0.020μF             |             |      |      |     |      | p117 |      |      |      |
| 0.022μF             |             |      |      |     |      | p117 |      |      |      |
| 0.027μF             |             |      |      |     |      | p117 |      |      |      |
| 0.030μF             |             |      |      |     |      |      | p117 |      |      |
| 33000pF             |             |      | p117 |     |      |      |      |      |      |
| 0.036μF             |             |      |      |     |      |      | p117 |      |      |
| 39000pF             |             |      | p117 |     |      |      |      |      |      |
| 0.044μF             |             |      |      |     |      |      |      |      | p117 |
| 47000pF             |             |      | p117 |     |      |      |      |      |      |
| 0.054μF             |             |      |      |     |      |      |      |      | p117 |
| 66000pF             |             |      |      |     |      |      |      | p117 |      |
| 78000pF             |             |      |      |     |      |      |      | p117 |      |
| 94000pF             |             |      |      |     |      |      |      | p117 |      |

## KCM Series High Dielectric Constant Type

p00 ← Part Number List      EIA: X7S X7R

| L×W (mm)            | 6.1×5.3     |      |      |      |      |      |      |      |      |      |      |      |      |      |      |      |      |      |      |      |      |
|---------------------|-------------|------|------|------|------|------|------|------|------|------|------|------|------|------|------|------|------|------|------|------|------|
|                     | T max. (mm) |      |      |      |      |      |      |      |      |      |      |      |      |      |      |      |      |      |      |      |      |
| T max. (mm)         |             | 3.0  |      |      |      |      | 3.9  |      |      |      |      | 5.0  |      |      |      | 6.7  |      |      |      |      |      |
| Rated Voltage (Vdc) |             | 100  | 63   | 50   | 35   | 25   | 100  | 63   | 50   | 35   | 25   | 100  | 50   | 35   | 25   | 100  | 63   | 50   | 35   | 25   |      |
| Cap. / TC Code      |             | X7R  | X7R  | X7R  | X7R  | X7R  | X7R  | X7R  | X7R  | X7R  | X7S  | X7R  | X7R  | X7R  | X7R  | X7R  | X7R  | X7R  | X7R  | X7R  | X7S  |
| 4.7μF               | p118        | p118 | p118 |      |      |      |      |      |      |      |      |      |      |      |      |      |      |      |      |      |      |
| 6.8μF               |             |      |      |      |      | p118 |      |      |      |      |      |      |      |      |      |      |      |      |      |      |      |
| 10μF                |             |      | p118 | p118 |      | p118 | p118 | p118 |      |      |      | p118 |      |      |      |      |      |      |      |      |      |
| 15μF                |             |      |      | p118 | p118 |      |      |      |      |      |      |      |      |      |      | p118 |      |      |      |      |      |
| 17μF                |             |      |      |      |      |      |      | p118 | p118 |      |      |      |      |      |      |      |      |      |      |      |      |
| 22μF                |             |      |      |      |      |      |      |      | p118 | p118 |      |      | p118 | p118 |      | p118 | p118 | p118 |      |      |      |
| 33μF                |             |      |      |      |      |      |      |      |      | p118 |      |      |      | p118 | p118 |      |      | p118 | p118 |      |      |
| 47μF                |             |      |      |      |      |      |      |      |      |      | p118 |      |      |      |      |      |      |      | p118 | p118 |      |
| 68μF                |             |      |      |      |      |      |      |      |      |      |      |      |      |      |      |      |      |      |      | p118 |      |
| 100μF               |             |      |      |      |      |      |      |      |      |      |      |      |      |      |      |      |      |      |      |      | p118 |

## Capacitance Table

### KC3 Series High Dielectric Constant Type

p00 ← Part Number List      EIA: X7T

| L×W (mm)            | 6.1×5.3 |      |      |      |      |      |      |      |      |      |      |     |
|---------------------|---------|------|------|------|------|------|------|------|------|------|------|-----|
|                     | 3.0     |      |      | 3.9  |      |      | 5.0  |      |      | 6.7  |      |     |
| T max. (mm)         | 3.0     |      |      | 3.9  |      |      | 5.0  |      |      | 6.7  |      |     |
| Rated Voltage (Vdc) | 630     | 450  | 250  | 630  | 450  | 250  | 630  | 450  | 250  | 630  | 450  | 250 |
| Cap. / TC Code      | X7T     | X7T  | X7T  | X7T  | X7T  | X7T  | X7T  | X7T  | X7T  | X7T  | X7T  | X7T |
| 0.10μF              | p121    |      |      |      |      |      |      |      |      |      |      |     |
| 0.15μF              | p121    |      |      |      |      |      |      |      |      |      |      |     |
| 0.22μF              |         | p121 |      | p121 |      |      |      |      |      |      |      |     |
| 0.27μF              |         |      |      | p121 |      |      |      |      |      |      |      |     |
| 0.33μF              | p121    | p121 |      |      |      |      |      |      |      |      |      |     |
| 0.47μF              | p121    | p121 | p121 |      |      |      |      |      |      | p121 |      |     |
| 0.56μF              |         |      |      | p121 | p121 |      |      |      |      | p121 |      |     |
| 0.68μF              |         | p121 | p121 |      |      |      | p121 | p121 |      |      |      |     |
| 1.0μF               |         |      |      | p121 | p121 | p121 | p121 |      |      |      |      |     |
| 1.2μF               |         |      |      |      |      |      |      |      |      | p121 | p121 |     |
| 1.5μF               |         |      |      |      |      |      |      | p121 | p121 |      |      |     |
| 2.2μF               |         |      |      |      |      |      |      |      |      | p121 | p121 |     |

### KCA Series Temperature Compensating Type

p00 ← Part Number List      EIA: U2J

| L×W (mm)                     | 6.1×5.1 |      |      |      |
|------------------------------|---------|------|------|------|
|                              | 3.0     | 3.9  | 5.0  | 6.7  |
| T max. (mm)                  | 0.55    |      |      |      |
| Rated Voltage (Vac (r.m.s.)) | 250     | 250  | 250  | 250  |
| Cap. / TC Code               | U2J     | U2J  | U2J  | U2J  |
| 100pF                        | p124    |      |      |      |
| 150pF                        | p124    |      |      |      |
| 220pF                        | p124    |      |      |      |
| 330pF                        | p124    |      |      |      |
| 470pF                        | p124    |      |      |      |
| 680pF                        | p124    |      |      |      |
| 1000pF                       | p124    |      |      |      |
| 1500pF                       | p124    |      |      |      |
| 2200pF                       | p124    |      |      |      |
| 3300pF                       | p124    |      |      |      |
| 4700pF                       |         | p124 |      |      |
| 6800pF                       |         |      | p124 |      |
| 10000pF                      |         |      |      | p124 |

### GCB Series High Dielectric Constant Type

p00 ← Part Number List      EIA: X8R

| L×W (mm)            | 1.0×0.5 |      |      |      |
|---------------------|---------|------|------|------|
|                     | 0.55    |      |      |      |
| T max. (mm)         | 0.55    |      |      |      |
| Rated Voltage (Vdc) | 100     | 50   | 25   | 16   |
| Cap. / TC Code      | X8R     | X8R  | X8R  | X8R  |
| 1000pF              | p126    | p126 |      |      |
| 1500pF              | p126    | p126 |      |      |
| 2200pF              | p126    | p126 |      |      |
| 3300pF              | p126    | p126 |      |      |
| 4700pF              | p126    | p126 |      |      |
| 6800pF              | p126    |      | p126 |      |
| 10000pF             | p126    |      | p126 |      |
| 15000pF             |         | p126 |      | p126 |
| 22000pF             |         | p126 |      | p126 |
| 33000pF             |         | p126 |      | p126 |
| 47000pF             |         | p126 | p126 | p126 |
| 68000pF             |         |      | p126 | p126 |
| 0.10μF              |         |      | p126 | p126 |

# Capacitance Table

## GCG Series Temperature Compensating Type

p00 ← Part Number List    JIS: CH CJ CK    EIA: COG U2J    Murata Temperature Characteristic: CHA X8G

| L×W (mm)            | 1.0×0.5 |      |      |      |      | 1.6×0.8 |     |     | 2.0×1.25 |      |
|---------------------|---------|------|------|------|------|---------|-----|-----|----------|------|
| T max. (mm)         | 0.55    |      |      |      |      | 0.9     |     |     | 0.7      | 0.95 |
| Rated Voltage (Vdc) | 50      |      |      |      |      | 100     | 50  | 50  | 50       |      |
| Cap. / TC Code      | COG     | CH   | CJ   | CK   | CHA  | X8G     | U2J | X8G | X8G      | X8G  |
| 1.0pF               | p128    | p130 |      | p133 | p133 | p136    |     |     |          |      |
| 1.1pF               | p128    | p130 |      | p133 | p133 | p136    |     |     |          |      |
| 1.2pF               | p128    | p130 |      | p133 | p133 | p136    |     |     |          |      |
| 1.3pF               | p128    | p130 |      | p133 | p133 | p136    |     |     |          |      |
| 1.4pF               | p128    | p130 |      | p133 | p134 | p136    |     |     |          |      |
| 1.5pF               | p128    | p130 |      | p133 | p134 | p137    |     |     |          |      |
| 1.6pF               | p128    | p130 |      | p133 | p134 | p137    |     |     |          |      |
| 1.7pF               | p128    | p130 |      | p133 | p134 | p137    |     |     |          |      |
| 1.8pF               | p128    | p130 |      | p133 | p134 | p137    |     |     |          |      |
| 1.9pF               | p128    | p130 |      | p133 | p134 | p137    |     |     |          |      |
| 2.0pF               | p128    | p130 |      | p133 | p134 | p137    |     |     |          |      |
| 2.1pF               | p128    | p130 | p133 |      | p134 | p137    |     |     |          |      |
| 2.2pF               | p128    | p130 | p133 |      | p134 | p137    |     |     |          |      |
| 2.3pF               | p128    | p130 | p133 |      | p134 | p137    |     |     |          |      |
| 2.4pF               | p128    | p130 | p133 |      | p134 | p137    |     |     |          |      |
| 2.5pF               | p128    | p130 | p133 |      | p134 | p137    |     |     |          |      |
| 2.6pF               | p128    | p130 | p133 |      | p134 | p137    |     |     |          |      |
| 2.7pF               | p128    | p131 | p133 |      | p134 | p137    |     |     |          |      |
| 2.8pF               | p128    | p131 | p133 |      | p134 | p137    |     |     |          |      |
| 2.9pF               | p128    | p131 | p133 |      | p134 | p137    |     |     |          |      |
| 3.0pF               | p128    | p131 | p133 |      | p134 | p137    |     |     |          |      |
| 3.1pF               | p128    | p131 | p133 |      | p134 | p137    |     |     |          |      |
| 3.2pF               | p128    | p131 | p133 |      | p134 | p137    |     |     |          |      |
| 3.3pF               | p128    | p131 | p133 |      | p134 | p137    |     |     |          |      |
| 3.4pF               | p128    | p131 | p133 |      | p134 | p137    |     |     |          |      |
| 3.5pF               | p128    | p131 | p133 |      | p134 | p137    |     |     |          |      |
| 3.6pF               | p128    | p131 | p133 |      | p134 | p137    |     |     |          |      |
| 3.7pF               | p128    | p131 | p133 |      | p134 | p137    |     |     |          |      |
| 3.8pF               | p128    | p131 | p133 |      | p134 | p137    |     |     |          |      |
| 3.9pF               | p128    | p131 | p133 |      | p134 | p137    |     |     |          |      |
| 4.0pF               | p128    | p131 |      |      | p134 | p137    |     |     |          |      |
| 4.1pF               | p128    | p131 |      |      | p134 | p137    |     |     |          |      |
| 4.2pF               | p128    | p131 |      |      | p134 | p137    |     |     |          |      |
| 4.3pF               | p128    | p131 |      |      | p134 | p137    |     |     |          |      |
| 4.4pF               | p128    | p131 |      |      | p134 | p137    |     |     |          |      |
| 4.5pF               | p128    | p131 |      |      | p134 | p137    |     |     |          |      |
| 4.6pF               | p129    | p131 |      |      | p134 | p137    |     |     |          |      |
| 4.7pF               | p129    | p131 |      |      | p134 | p137    |     |     |          |      |
| 4.8pF               | p129    | p131 |      |      | p134 | p137    |     |     |          |      |
| 4.9pF               | p129    | p131 |      |      | p134 | p137    |     |     |          |      |
| 5.0pF               | p129    | p131 |      |      | p135 | p137    |     |     |          |      |
| 5.1pF               | p129    | p131 |      |      | p135 | p138    |     |     |          |      |
| 5.2pF               | p129    | p131 |      |      | p135 | p138    |     |     |          |      |
| 5.3pF               | p129    | p131 |      |      | p135 | p138    |     |     |          |      |
| 5.4pF               | p129    | p131 |      |      | p135 | p138    |     |     |          |      |
| 5.5pF               | p129    | p131 |      |      | p135 | p138    |     |     |          |      |
| 5.6pF               | p129    | p131 |      |      | p135 | p138    |     |     |          |      |
| 5.7pF               | p129    | p131 |      |      | p135 | p138    |     |     |          |      |
| 5.8pF               | p129    | p131 |      |      | p135 | p138    |     |     |          |      |
| 5.9pF               | p129    | p131 |      |      | p135 | p138    |     |     |          |      |
| 6.0pF               | p129    | p131 |      |      | p135 | p138    |     |     |          |      |
| 6.1pF               | p129    | p131 |      |      | p135 | p138    |     |     |          |      |
| 6.2pF               | p129    | p131 |      |      | p135 | p138    |     |     |          |      |
| 6.3pF               | p129    | p132 |      |      | p135 | p138    |     |     |          |      |
| 6.4pF               | p129    | p132 |      |      | p135 | p138    |     |     |          |      |

↓ Continued on the following page.

# Capacitance Table

(→ GCG Series Temperature Compensating Type)

p00 ← Part Number List      JIS: CH CJ CK      EIA: C0G U2J      Murata Temperature Characteristic: CHA X8G

| L×W (mm)            | 1.0×0.5 |      |    |    |      | 1.6×0.8 |      |      | 2.0×1.25 |      |
|---------------------|---------|------|----|----|------|---------|------|------|----------|------|
| T max. (mm)         | 0.55    |      |    |    |      | 0.9     |      |      | 0.7      | 0.95 |
| Rated Voltage (Vdc) | 50      |      |    |    |      | 100     | 50   | 50   | 50       |      |
| Cap. / TC Code      | COG     | CH   | CJ | CK | CHA  | X8G     | U2J  | X8G  | X8G      | X8G  |
| 6.5pF               | p129    | p132 |    |    | p135 | p138    |      |      |          |      |
| 6.6pF               | p129    | p132 |    |    | p135 | p138    |      |      |          |      |
| 6.7pF               | p129    | p132 |    |    | p135 | p138    |      |      |          |      |
| 6.8pF               | p129    | p132 |    |    | p135 | p138    |      |      |          |      |
| 6.9pF               | p129    | p132 |    |    | p135 | p138    |      |      |          |      |
| 7.0pF               | p129    | p132 |    |    | p135 | p138    |      |      |          |      |
| 7.1pF               | p129    | p132 |    |    | p135 | p138    |      |      |          |      |
| 7.2pF               | p129    | p132 |    |    | p135 | p138    |      |      |          |      |
| 7.3pF               | p129    | p132 |    |    | p135 | p138    |      |      |          |      |
| 7.4pF               | p129    | p132 |    |    | p135 | p138    |      |      |          |      |
| 7.5pF               | p129    | p132 |    |    | p135 | p138    |      |      |          |      |
| 7.6pF               | p129    | p132 |    |    | p135 | p138    |      |      |          |      |
| 7.7pF               | p129    | p132 |    |    | p135 | p138    |      |      |          |      |
| 7.8pF               | p129    | p132 |    |    | p135 | p138    |      |      |          |      |
| 7.9pF               | p129    | p132 |    |    | p135 | p138    |      |      |          |      |
| 8.0pF               | p129    | p132 |    |    | p135 | p138    |      |      |          |      |
| 8.1pF               | p129    | p132 |    |    | p135 | p138    |      |      |          |      |
| 8.2pF               | p130    | p132 |    |    | p135 | p138    |      |      |          |      |
| 8.3pF               | p130    | p132 |    |    | p135 | p138    |      |      |          |      |
| 8.4pF               | p130    | p132 |    |    | p135 | p138    |      |      |          |      |
| 8.5pF               | p130    | p132 |    |    | p135 | p138    |      |      |          |      |
| 8.6pF               | p130    | p132 |    |    | p136 | p138    |      |      |          |      |
| 8.7pF               | p130    | p132 |    |    | p136 | p139    |      |      |          |      |
| 8.8pF               | p130    | p132 |    |    | p136 | p139    |      |      |          |      |
| 8.9pF               | p130    | p132 |    |    | p136 | p139    |      |      |          |      |
| 9.0pF               | p130    | p132 |    |    | p136 | p139    |      |      |          |      |
| 9.1pF               | p130    | p132 |    |    | p136 | p139    |      |      |          |      |
| 9.2pF               | p130    | p132 |    |    | p136 | p139    |      |      |          |      |
| 9.3pF               | p130    | p132 |    |    | p136 | p139    |      |      |          |      |
| 9.4pF               | p130    | p132 |    |    | p136 | p139    |      |      |          |      |
| 9.5pF               | p130    | p132 |    |    | p136 | p139    |      |      |          |      |
| 9.6pF               | p130    | p132 |    |    | p136 | p139    |      |      |          |      |
| 9.7pF               | p130    | p132 |    |    | p136 | p139    |      |      |          |      |
| 9.8pF               | p130    | p132 |    |    | p136 | p139    |      |      |          |      |
| 9.9pF               | p130    | p133 |    |    | p136 | p139    |      |      |          |      |
| 10pF                | p130    | p133 |    |    | p136 | p139    | p140 | p141 |          |      |
| 11pF                |         |      |    |    | p136 | p139    | p140 |      |          |      |
| 12pF                |         |      |    |    | p136 | p139    | p140 | p141 |          |      |
| 13pF                |         |      |    |    | p136 | p139    | p140 |      |          |      |
| 15pF                |         |      |    |    | p136 | p139    | p140 | p141 |          |      |
| 16pF                |         |      |    |    | p136 | p139    | p140 |      |          |      |
| 18pF                |         |      |    |    | p136 | p139    | p140 | p141 |          |      |
| 20pF                |         |      |    |    | p136 | p139    | p140 |      |          |      |
| 22pF                |         |      |    |    | p136 | p139    | p140 | p141 |          |      |
| 24pF                |         |      |    |    | p136 | p139    | p140 |      |          |      |
| 27pF                |         |      |    |    | p136 | p139    | p140 | p141 |          |      |
| 30pF                |         |      |    |    | p136 | p139    | p140 |      |          |      |
| 33pF                |         |      |    |    | p136 | p139    | p140 | p141 |          |      |
| 36pF                |         |      |    |    | p136 | p139    | p140 |      |          |      |
| 39pF                |         |      |    |    | p136 | p139    | p140 | p141 |          |      |
| 43pF                |         |      |    |    | p136 | p139    | p140 |      |          |      |
| 47pF                |         |      |    |    | p136 | p139    | p140 | p141 |          |      |
| 51pF                |         |      |    |    | p136 | p139    | p140 |      |          |      |
| 56pF                |         |      |    |    | p136 | p139    | p140 | p141 |          |      |
| 62pF                |         |      |    |    | p136 | p139    | p140 |      |          |      |

↓ Continued on the following page.



# Capacitance Table

(→ GCG Series Temperature Compensating Type)

p00 ← Part Number List      JIS: CH CJ CK      EIA: COG U2J      Murata Temperature Characteristic: CHA X8G

| L×W (mm)            | 1.0×0.5 |    |    |    |      | 1.6×0.8 |      |      | 2.0×1.25 |      |
|---------------------|---------|----|----|----|------|---------|------|------|----------|------|
| T max. (mm)         | 0.55    |    |    |    |      | 0.9     |      |      | 0.7      | 0.95 |
| Rated Voltage (Vdc) | 50      |    |    |    |      | 100     | 50   | 50   | 50       |      |
| Cap. / TC Code      | COG     | CH | CJ | CK | CHA  | X8G     | U2J  | X8G  | X8G      | X8G  |
| 68pF                |         |    |    |    | p136 | p139    |      | p140 | p141     |      |
| 75pF                |         |    |    |    | p136 | p139    |      | p141 |          |      |
| 82pF                |         |    |    |    | p136 | p139    |      | p141 | p142     |      |
| 91pF                |         |    |    |    | p136 | p139    |      | p141 |          |      |
| 100pF               |         |    |    |    | p136 | p139    |      | p141 | p142     |      |
| 110pF               |         |    |    |    |      | p139    |      | p141 |          |      |
| 120pF               |         |    |    |    |      | p139    |      | p141 | p142     |      |
| 130pF               |         |    |    |    |      | p139    |      | p141 |          |      |
| 150pF               |         |    |    |    |      | p139    |      | p141 | p142     |      |
| 160pF               |         |    |    |    |      | p139    |      | p141 |          |      |
| 180pF               |         |    |    |    |      | p139    |      | p141 | p142     |      |
| 200pF               |         |    |    |    |      | p139    |      | p141 |          |      |
| 220pF               |         |    |    |    |      | p139    |      | p141 | p142     |      |
| 240pF               |         |    |    |    |      | p140    |      | p141 |          |      |
| 270pF               |         |    |    |    |      | p140    |      | p141 | p142     |      |
| 300pF               |         |    |    |    |      | p140    |      | p141 |          |      |
| 330pF               |         |    |    |    |      | p140    |      | p141 | p142     |      |
| 360pF               |         |    |    |    |      | p140    |      | p141 |          |      |
| 390pF               |         |    |    |    |      | p140    |      | p141 | p142     |      |
| 430pF               |         |    |    |    |      | p140    |      | p141 |          |      |
| 470pF               |         |    |    |    |      | p140    |      | p141 | p142     |      |
| 510pF               |         |    |    |    |      |         |      | p141 |          |      |
| 560pF               |         |    |    |    |      |         |      | p141 | p142     |      |
| 620pF               |         |    |    |    |      |         |      | p141 |          |      |
| 680pF               |         |    |    |    |      |         |      | p141 | p142     |      |
| 750pF               |         |    |    |    |      |         |      | p141 |          |      |
| 820pF               |         |    |    |    |      |         |      | p141 | p142     |      |
| 910pF               |         |    |    |    |      |         |      | p141 |          |      |
| 1000pF              |         |    |    |    |      |         | p140 | p141 | p142     | p142 |
| 1100pF              |         |    |    |    |      |         | p140 |      |          |      |
| 1200pF              |         |    |    |    |      |         | p140 |      | p142     | p142 |
| 1300pF              |         |    |    |    |      |         | p140 |      |          |      |
| 1500pF              |         |    |    |    |      |         | p140 |      | p142     | p142 |
| 1600pF              |         |    |    |    |      |         | p140 |      |          |      |
| 1800pF              |         |    |    |    |      |         | p140 |      | p142     | p142 |
| 2000pF              |         |    |    |    |      |         | p140 |      |          |      |
| 2200pF              |         |    |    |    |      |         | p140 |      | p142     | p142 |
| 2400pF              |         |    |    |    |      |         | p140 |      |          |      |
| 2700pF              |         |    |    |    |      |         | p140 |      |          | p142 |
| 3000pF              |         |    |    |    |      |         | p140 |      |          |      |
| 3300pF              |         |    |    |    |      |         | p140 |      |          | p142 |
| 3600pF              |         |    |    |    |      |         | p140 |      |          |      |
| 3900pF              |         |    |    |    |      |         | p140 |      |          | p142 |
| 4300pF              |         |    |    |    |      |         | p140 |      |          |      |
| 4700pF              |         |    |    |    |      |         | p140 |      |          | p142 |
| 5100pF              |         |    |    |    |      |         | p140 |      |          |      |
| 5600pF              |         |    |    |    |      |         | p140 |      |          | p142 |
| 6200pF              |         |    |    |    |      |         | p140 |      |          |      |
| 6800pF              |         |    |    |    |      |         | p140 |      |          | p142 |
| 7500pF              |         |    |    |    |      |         | p140 |      |          |      |
| 8200pF              |         |    |    |    |      |         | p140 |      |          | p142 |
| 9100pF              |         |    |    |    |      |         | p140 |      |          |      |
| 10000pF             |         |    |    |    |      |         | p140 |      |          | p142 |

# Capacitance Table

## GCG Series High Dielectric Constant Type

p00 ← Part Number List    EIA: X7S X7R X8R    Murata Temperature Characteristic: X8L

| L×W (mm)            | 1.0×0.5 |      |      |      |      |      | 1.6×0.8 |      |      |      |      |     | 2.0×1.25 |      |      |     |     |     |     |      |      |      |      |     |      |      |      |      |
|---------------------|---------|------|------|------|------|------|---------|------|------|------|------|-----|----------|------|------|-----|-----|-----|-----|------|------|------|------|-----|------|------|------|------|
| T max. (mm)         | 0.55    |      |      |      |      |      | 0.9     |      |      |      |      |     | 1.45     |      |      |     |     |     |     |      |      |      |      |     |      |      |      |      |
| Rated Voltage (Vdc) | 50      |      | 25   |      | 16   |      | 100     |      | 50   |      | 25   |     | 16       |      | 10   |     | 6.3 |     | 50  |      | 35   |      | 25   |     | 16   |      | 10   |      |
| Cap. / TC Code      | X8L     | X7R  | X8L  | X7R  | X8L  | X7R  | X8R     | X8L  | X8R  | X7R  | X8R  | X7R | X8L      | X7R  | X7S  | X7R | X8L | X7R | X8L | X7R  | X8L  | X8R  | X7R  | X8L | X7R  | X7R  | X7R  |      |
| 220pF               | p143    | p143 |      |      |      |      |         |      |      |      |      |     |          |      |      |     |     |     |     |      |      |      |      |     |      |      |      |      |
| 270pF               | p143    | p143 |      |      |      |      |         |      |      |      |      |     |          |      |      |     |     |     |     |      |      |      |      |     |      |      |      |      |
| 330pF               | p143    | p143 |      |      |      |      |         |      |      |      |      |     |          |      |      |     |     |     |     |      |      |      |      |     |      |      |      |      |
| 390pF               | p143    | p143 |      |      |      |      |         |      |      |      |      |     |          |      |      |     |     |     |     |      |      |      |      |     |      |      |      |      |
| 470pF               | p143    | p143 |      |      |      |      |         |      |      |      |      |     |          |      |      |     |     |     |     |      |      |      |      |     |      |      |      |      |
| 560pF               | p143    | p143 |      |      |      |      |         |      |      |      |      |     |          |      |      |     |     |     |     |      |      |      |      |     |      |      |      |      |
| 680pF               | p143    | p143 |      |      |      |      |         |      |      |      |      |     |          |      |      |     |     |     |     |      |      |      |      |     |      |      |      |      |
| 820pF               | p143    | p143 |      |      |      |      |         |      |      |      |      |     |          |      |      |     |     |     |     |      |      |      |      |     |      |      |      |      |
| 1000pF              | p143    | p143 |      |      |      |      |         | p144 |      | p144 |      |     |          |      |      |     |     |     |     |      |      |      |      |     |      |      |      |      |
| 1200pF              | p143    | p143 |      |      |      |      |         | p144 |      | p144 |      |     |          |      |      |     |     |     |     |      |      |      |      |     |      |      |      |      |
| 1500pF              | p143    | p143 |      |      |      |      |         | p144 |      | p144 |      |     |          |      |      |     |     |     |     |      |      |      |      |     |      |      |      |      |
| 1800pF              | p143    | p143 |      |      |      |      |         | p144 |      | p144 |      |     |          |      |      |     |     |     |     |      |      |      |      |     |      |      |      |      |
| 2200pF              | p143    | p143 |      |      |      |      |         | p144 |      | p144 |      |     |          |      |      |     |     |     |     |      |      |      |      |     |      |      |      |      |
| 2700pF              | p143    | p143 |      |      |      |      |         | p144 |      | p144 |      |     |          |      |      |     |     |     |     |      |      |      |      |     |      |      |      |      |
| 3300pF              | p143    | p143 |      |      |      |      |         | p144 |      | p144 |      |     |          |      |      |     |     |     |     |      |      |      |      |     |      |      |      |      |
| 3900pF              | p143    | p143 |      |      |      |      |         | p144 |      | p144 |      |     |          |      |      |     |     |     |     |      |      |      |      |     |      |      |      |      |
| 4700pF              | p143    | p143 |      |      |      |      |         | p144 |      | p144 |      |     |          |      |      |     |     |     |     |      |      |      |      |     |      |      |      |      |
| 5600pF              |         |      | p143 | p143 |      |      |         | p144 |      | p144 |      |     |          |      |      |     |     |     |     |      |      |      |      |     |      |      |      |      |
| 6800pF              |         |      | p143 | p143 |      |      |         | p144 |      | p144 |      |     |          |      |      |     |     |     |     |      |      |      |      |     |      |      |      |      |
| 8200pF              |         |      | p143 | p143 |      |      |         | p144 |      | p144 |      |     |          |      |      |     |     |     |     |      |      |      |      |     |      |      |      |      |
| 10000pF             |         |      | p143 | p143 |      |      |         | p144 |      | p144 |      |     |          |      |      |     |     |     |     |      |      |      |      |     |      |      |      |      |
| 12000pF             |         |      |      |      |      |      |         | p144 |      |      |      |     |          |      |      |     |     |     |     |      |      |      |      |     |      |      |      |      |
| 15000pF             |         |      |      |      | p143 | p143 |         | p144 |      | p144 |      |     |          |      |      |     |     |     |     |      |      |      |      |     |      |      |      |      |
| 18000pF             |         |      |      |      | p143 | p143 |         | p144 |      |      |      |     |          |      |      |     |     |     |     |      |      |      |      |     |      |      |      |      |
| 22000pF             |         |      |      |      | p143 | p143 |         | p144 |      | p144 |      |     |          |      |      |     |     |     |     |      |      |      |      |     |      |      |      |      |
| 27000pF             |         |      |      |      | p143 | p143 |         | p144 |      |      |      |     |          |      |      |     |     |     |     |      |      |      |      |     |      |      |      |      |
| 33000pF             |         |      |      |      | p143 | p143 |         | p144 |      | p144 |      |     |          |      |      |     |     |     |     |      |      |      |      |     |      |      |      |      |
| 39000pF             |         |      |      |      | p143 | p143 |         | p144 |      |      |      |     |          |      |      |     |     |     |     |      |      |      |      |     |      |      |      |      |
| 47000pF             |         |      |      |      | p143 | p143 |         | p144 |      | p144 |      |     |          |      |      |     |     |     |     |      |      |      |      |     |      |      |      |      |
| 56000pF             |         |      |      |      |      | p143 | p144    |      |      |      |      |     |          |      |      |     |     |     |     |      |      |      |      |     |      |      |      |      |
| 68000pF             |         |      |      |      |      | p143 | p144    |      |      |      |      |     |          |      |      |     |     |     |     |      |      |      |      |     |      |      |      |      |
| 82000pF             |         |      |      |      |      | p143 |         |      |      |      |      |     |          |      |      |     |     |     |     |      |      |      |      |     |      |      |      |      |
| 0.10μF              |         |      |      |      |      | p143 | p144    |      |      | p144 |      |     |          |      |      |     |     |     |     |      |      |      |      |     |      |      |      |      |
| 0.12μF              |         |      |      |      |      |      |         |      |      | p144 |      |     |          |      |      |     |     |     |     |      |      |      |      |     |      |      |      |      |
| 0.15μF              |         |      |      |      |      |      |         | p144 | p144 | p144 |      |     |          |      |      |     |     |     |     |      | p145 |      |      |     |      |      |      |      |
| 0.18μF              |         |      |      |      |      |      |         |      | p144 |      |      |     |          |      |      |     |     |     |     |      | p145 |      |      |     |      |      |      |      |
| 0.22μF              |         |      |      |      |      |      |         | p144 | p144 | p144 |      |     |          |      |      |     |     |     |     |      | p145 |      |      |     |      |      |      |      |
| 0.27μF              |         |      |      |      |      |      |         |      |      |      |      |     |          |      |      |     |     |     |     |      |      |      |      |     |      |      |      |      |
| 0.33μF              |         |      |      |      |      |      |         |      |      |      | p144 |     |          |      |      |     |     |     |     |      | p145 |      |      |     |      | p145 | p145 |      |
| 0.39μF              |         |      |      |      |      |      |         |      |      |      | p144 |     |          |      |      |     |     |     |     |      |      |      |      |     |      | p145 | p145 |      |
| 0.47μF              |         |      |      |      |      |      |         |      |      |      | p144 |     |          |      |      |     |     |     |     |      | p145 |      |      |     |      | p145 | p145 |      |
| 0.56μF              |         |      |      |      |      |      |         |      |      |      |      |     |          |      |      |     |     |     |     |      |      |      |      |     |      | p145 | p145 |      |
| 0.68μF              |         |      |      |      |      |      |         |      |      |      |      |     |          |      |      |     |     |     |     |      | p145 | p145 |      |     | p145 | p145 | p145 |      |
| 0.82μF              |         |      |      |      |      |      |         |      |      |      |      |     |          |      |      |     |     |     |     |      |      |      |      |     | p145 | p145 | p145 |      |
| 1.0μF               |         |      |      |      |      |      |         |      |      |      |      |     |          | p145 | p145 |     |     |     |     | p145 | p145 | p145 | p145 |     | p145 | p145 |      |      |
| 1.2μF               |         |      |      |      |      |      |         |      |      |      |      |     |          |      |      |     |     |     |     |      |      |      |      |     |      |      |      |      |
| 1.5μF               |         |      |      |      |      |      |         |      |      |      |      |     |          |      |      |     |     |     |     |      |      |      |      |     |      |      |      |      |
| 2.2μF               |         |      |      |      |      |      |         |      |      |      |      |     |          |      |      |     |     |     |     |      |      |      |      |     |      |      |      |      |
| 3.3μF               |         |      |      |      |      |      |         |      |      |      |      |     |          |      |      |     |     |     |     |      |      |      |      |     |      |      |      |      |
| 3.9μF               |         |      |      |      |      |      |         |      |      |      |      |     |          |      |      |     |     |     |     |      |      |      |      |     |      |      |      |      |
| 4.7μF               |         |      |      |      |      |      |         |      |      |      |      |     |          |      |      |     |     |     |     |      |      |      |      |     |      |      |      | p145 |
| 6.8μF               |         |      |      |      |      |      |         |      |      |      |      |     |          |      |      |     |     |     |     |      |      |      |      |     |      |      |      |      |
| 10μF                |         |      |      |      |      |      |         |      |      |      |      |     |          |      |      |     |     |     |     |      |      |      |      |     |      |      |      | p145 |
| 22μF                |         |      |      |      |      |      |         |      |      |      |      |     |          |      |      |     |     |     |     |      |      |      |      |     |      |      |      |      |
| 47μF                |         |      |      |      |      |      |         |      |      |      |      |     |          |      |      |     |     |     |     |      |      |      |      |     |      |      |      |      |

Continued on the following page. ↗

# Capacitance Table

(→ GCG Series High Dielectric Constant Type)

p00 ← Part Number List    EIA: X7S X7R X8R    Murata Temperature Characteristic: X8L

| L×W (mm)            | 2.0×1.25 |      |      |     | 3.2×1.6 |      |      |     |     |     | 3.2×2.5 |     |     |     |     |     |     |     |     |
|---------------------|----------|------|------|-----|---------|------|------|-----|-----|-----|---------|-----|-----|-----|-----|-----|-----|-----|-----|
| T max. (mm)         | 1.45     |      |      |     | 1.35    |      | 1.9  |     |     |     | 2.8     |     |     |     |     |     |     |     |     |
| Rated Voltage (Vdc) | 6.3      |      | 50   | 25  | 16      | 25   |      | 16  | 6.3 | 50  | 35      |     | 25  |     | 16  | 6.3 |     |     |     |
| Cap. / TC Code      | X8L      | X7R  | X8R  | X7R | X8L     | X8R  | X7R  | X8L | X8R | X7R | X8L     | X7S | X8L | X7S | X8L | X7R | X7S | X8R | X7R |
| 220pF               |          |      |      |     |         |      |      |     |     |     |         |     |     |     |     |     |     |     |     |
| 270pF               |          |      |      |     |         |      |      |     |     |     |         |     |     |     |     |     |     |     |     |
| 330pF               |          |      |      |     |         |      |      |     |     |     |         |     |     |     |     |     |     |     |     |
| 390pF               |          |      |      |     |         |      |      |     |     |     |         |     |     |     |     |     |     |     |     |
| 470pF               |          |      |      |     |         |      |      |     |     |     |         |     |     |     |     |     |     |     |     |
| 560pF               |          |      |      |     |         |      |      |     |     |     |         |     |     |     |     |     |     |     |     |
| 680pF               |          |      |      |     |         |      |      |     |     |     |         |     |     |     |     |     |     |     |     |
| 820pF               |          |      |      |     |         |      |      |     |     |     |         |     |     |     |     |     |     |     |     |
| 1000pF              |          |      |      |     |         |      |      |     |     |     |         |     |     |     |     |     |     |     |     |
| 1200pF              |          |      |      |     |         |      |      |     |     |     |         |     |     |     |     |     |     |     |     |
| 1500pF              |          |      |      |     |         |      |      |     |     |     |         |     |     |     |     |     |     |     |     |
| 1800pF              |          |      |      |     |         |      |      |     |     |     |         |     |     |     |     |     |     |     |     |
| 2200pF              |          |      |      |     |         |      |      |     |     |     |         |     |     |     |     |     |     |     |     |
| 2700pF              |          |      |      |     |         |      |      |     |     |     |         |     |     |     |     |     |     |     |     |
| 3300pF              |          |      |      |     |         |      |      |     |     |     |         |     |     |     |     |     |     |     |     |
| 3900pF              |          |      |      |     |         |      |      |     |     |     |         |     |     |     |     |     |     |     |     |
| 4700pF              |          |      |      |     |         |      |      |     |     |     |         |     |     |     |     |     |     |     |     |
| 5600pF              |          |      |      |     |         |      |      |     |     |     |         |     |     |     |     |     |     |     |     |
| 6800pF              |          |      |      |     |         |      |      |     |     |     |         |     |     |     |     |     |     |     |     |
| 8200pF              |          |      |      |     |         |      |      |     |     |     |         |     |     |     |     |     |     |     |     |
| 10000pF             |          |      |      |     |         |      |      |     |     |     |         |     |     |     |     |     |     |     |     |
| 12000pF             |          |      |      |     |         |      |      |     |     |     |         |     |     |     |     |     |     |     |     |
| 15000pF             |          |      |      |     |         |      |      |     |     |     |         |     |     |     |     |     |     |     |     |
| 18000pF             |          |      |      |     |         |      |      |     |     |     |         |     |     |     |     |     |     |     |     |
| 22000pF             |          |      |      |     |         |      |      |     |     |     |         |     |     |     |     |     |     |     |     |
| 27000pF             |          |      |      |     |         |      |      |     |     |     |         |     |     |     |     |     |     |     |     |
| 33000pF             |          |      |      |     |         |      |      |     |     |     |         |     |     |     |     |     |     |     |     |
| 39000pF             |          |      |      |     |         |      |      |     |     |     |         |     |     |     |     |     |     |     |     |
| 47000pF             |          |      |      |     |         |      |      |     |     |     |         |     |     |     |     |     |     |     |     |
| 56000pF             |          |      |      |     |         |      |      |     |     |     |         |     |     |     |     |     |     |     |     |
| 68000pF             |          |      |      |     |         |      |      |     |     |     |         |     |     |     |     |     |     |     |     |
| 82000pF             |          |      |      |     |         |      |      |     |     |     |         |     |     |     |     |     |     |     |     |
| 0.10μF              |          |      |      |     |         |      |      |     |     |     |         |     |     |     |     |     |     |     |     |
| 0.12μF              |          |      |      |     |         |      |      |     |     |     |         |     |     |     |     |     |     |     |     |
| 0.15μF              |          |      |      |     |         |      |      |     |     |     |         |     |     |     |     |     |     |     |     |
| 0.18μF              |          |      |      |     |         |      |      |     |     |     |         |     |     |     |     |     |     |     |     |
| 0.22μF              |          |      | p145 |     |         |      |      |     |     |     |         |     |     |     |     |     |     |     |     |
| 0.27μF              |          |      |      |     |         |      |      |     |     |     |         |     |     |     |     |     |     |     |     |
| 0.33μF              |          |      | p145 |     |         |      |      |     |     |     |         |     |     |     |     |     |     |     |     |
| 0.39μF              |          |      |      |     |         |      |      |     |     |     |         |     |     |     |     |     |     |     |     |
| 0.47μF              |          |      |      |     |         |      |      |     |     |     |         |     |     |     |     |     |     |     |     |
| 0.56μF              |          |      |      |     |         |      |      |     |     |     |         |     |     |     |     |     |     |     |     |
| 0.68μF              |          |      |      |     |         |      |      |     |     |     |         |     |     |     |     |     |     |     |     |
| 0.82μF              |          |      |      |     |         |      |      |     |     |     |         |     |     |     |     |     |     |     |     |
| 1.0μF               |          |      |      |     |         | p146 | p146 |     |     |     |         |     |     |     |     |     |     |     |     |
| 1.2μF               |          |      |      |     |         |      |      |     |     |     |         |     |     |     |     |     |     |     |     |
| 1.5μF               |          |      |      |     |         | p145 |      |     |     |     |         |     |     |     |     |     |     |     |     |
| 2.2μF               |          |      |      |     |         | p146 | p146 |     |     |     |         |     |     |     |     |     |     |     |     |
| 3.3μF               |          |      |      |     |         |      |      |     |     |     |         |     |     |     |     |     |     |     |     |
| 3.9μF               |          |      |      |     |         |      |      |     |     |     |         |     |     |     |     |     |     |     |     |
| 4.7μF               |          |      |      |     |         |      |      |     |     |     |         |     |     |     |     |     |     |     |     |
| 6.8μF               |          |      |      |     |         |      |      |     |     |     |         |     |     |     |     |     |     |     |     |
| 10μF                | p145     | p145 |      |     |         |      |      |     |     |     |         |     |     |     |     |     |     |     |     |
| 22μF                |          |      |      |     |         |      |      |     |     |     |         |     |     |     |     |     |     |     |     |
| 47μF                |          |      |      |     |         |      |      |     |     |     |         |     |     |     |     |     |     |     |     |

# Search Capacitors

Specifications and Test Methods, Package, Chart of Characteristic Data, please refer to the search web page.  
<https://www.murata.com/en-global/products/capacitor>

Links are provided to the product detail pages on the web, and are shown below in the product number table from the PDF version of the catalog which is available on the web.

**GRM Series Temperature Compensating**

0.25×0.125mm

| T max.  | Rated Voltage | TC Code | Cap.   | Tol.   | Part Number       |
|---------|---------------|---------|--------|--------|-------------------|
| 0.138mm | 25Vdc         | COG     | 0.20pF | ±0.1pF | GRM015C1ER20BE11# |
|         |               |         | 0.30pF | ±0.1pF | GRM015C1ER30BE11# |
|         |               |         | 0.40pF | ±0.1pF | GRM015C1ER40BE11# |
|         |               |         | 0.50pF | ±0.1pF | GRM015C1ER50BE11# |
|         |               |         | 0.60pF | ±0.1pF | GRM015C1ER60BE11# |
|         |               |         | 0.70pF | ±0.1pF | GRM015C1ER70BE11# |
|         |               |         | 0.80pF | ±0.1pF | GRM015C1ER80BE11# |
|         |               |         | 0.90pF | ±0.1pF | GRM015C1ER90BE11# |

The screenshot shows a detailed product page for GRM0332C1E102JA01#. The page is divided into several sections, each highlighted with a red dashed box and a green dot:

- Status and Features Icons:** Located at the top left, showing icons for sample request, inventory, data sheet, and PDF output.
- Appearance & Shape:** Shows images of the capacitor and its dimensions.
- Specifications:** Lists technical specifications such as capacitance, tolerance, and temperature range.
- References:** Provides links to related documents and standards.
- Characteristic Data:** Contains multiple graphs showing the capacitor's performance under various conditions.

## Status and Features Icons

The status and features of products can be checked at once. When ? is clicked, a description of each icon will be displayed

## Stock Check (Where to buy)

Some products can request free samples. Reference inventory information from agents and web-based companies.

## Data Sheet

The product details page can be output in PDF.

## How to read part numbers

Describes the meaning of the part number

## Series Information

This links to the introduction page of each series.

## Detailed Specifications Sheet

- Rated value
- Specifications and Test Methods
- Package
- Caution, Notice (Storage, Soldering and Mounting, ....etc.)

## Characteristics Data

The following characteristics data of the main products can be acquired.

- SPICE Netlist (mod type)
- S parameter (S2P type)
- Reliability Test Data \*Typical data

- Shape (Dimensions)
- Rated Values

- Specification by Packaging Code/ Minimum Order Quantity
- Weight (1 pc/ø180mm reel)

## Chart of Characteristic Data

The main products published characteristic data.

- Frequency characteristics (ESR, Impedance)
- DC bias characteristics
- AC voltage characteristics
- Capacitance - temperature characteristics
- Calorific property by ripple current

AEC-Q200 Compliant Chip Multilayer Ceramic Capacitors for Infotainment

**GRT Series**



**AEC-Q200 compliant capacitor (Grade2 or Grade3).**

**Features**

① **This product has cleared AEC-Q200 compliant test conditions.**

This series is designed for use in Car Multimedia, Car Interior, Car Comfort application and General Electronic equipment. It is not appropriate for use in applications critical to passenger safety and car driving function (e.g. ABS, AIRBAG, etc.). Please use the GCM series is in critical applications.

|                   | General Purpose GRM Series<br>Maximum operating temperature: <b>125°C</b>                    | AEC-Q200 compliant GRT Series<br>Maximum operating temperature: <b>125°C</b>                   |
|-------------------|--|--|
| Items             | Test Method  | Test Method  |
| Temperature Cycle | Temperature Cycle: <b>5 cycles</b>   | Temperature Cycle: <b>1,000 cycles</b>   |
| Humidity Loading  | Test temperature: <b>40±2°C</b><br>Test humidity: <b>90 to 95%RH</b><br>Test time: 500 hours | Test temperature: <b>85±2°C</b><br>Test humidity: <b>80 to 85%RH</b><br>Test time: 1,000 hours |

② **AEC-Q200 compliant (Grade2 or Grade3)**

105°C product: Grade2.  
 85°C product: Grade3.

③ **Sn plating is applied to the external electrodes; excellent solderability.**

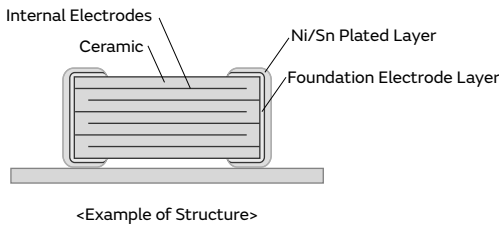

**Specifications**

|                   |  |
|-------------------|--|
| Size              | 0.6×0.3mm to 3.2×2.5mm   |
| Rated Voltage     | 2.5Vdc to 100Vdc   |
| Capacitance       | 0.10pF to 100μF  |
| Main Applications | Such as Information and Comfort equipment, car navigation, communication module and entertainment system |

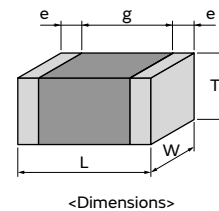

GRT Series

GCM Series

GC3 Series

GCJ Series

GCQ Series

GCD Series

GCE Series

NMF Series

KCM Series

KC3 Series

KCA Series

GCB Series

GCG Series

△Caution / Notice

# GRT Series Temperature Compensating Type Part Number List

0.6×0.3mm

| T max. | Rated Voltage | TC Code | Cap.   | Tol.    | Part Number        |           |
|--------|---------------|---------|--------|---------|--------------------|-----------|
| 0.33mm | 100Vdc        | COG     | 0.10pF | ±0.05pF | GRT0335C2AR10WA02# | <b>D1</b> |
|        |               |         |        | ±0.1pF  | GRT0335C2AR20BA02# | <b>D1</b> |
|        |               |         | 0.20pF | ±0.05pF | GRT0335C2AR20WA02# | <b>D1</b> |
|        |               |         |        | ±0.1pF  | GRT0335C2AR30BA02# | <b>D1</b> |
|        |               |         | 0.30pF | ±0.05pF | GRT0335C2AR30WA02# | <b>D1</b> |
|        |               |         |        | ±0.1pF  | GRT0335C2AR30BA02# | <b>D1</b> |
|        |               |         | 1.0pF  | ±0.25pF | GRT0335C2A1R0CA02# | <b>D1</b> |
|        |               |         | 1.1pF  | ±0.25pF | GRT0335C2A1R1CA02# | <b>D1</b> |
|        |               |         | 1.2pF  | ±0.25pF | GRT0335C2A1R2CA02# | <b>D1</b> |
|        |               |         | 1.3pF  | ±0.25pF | GRT0335C2A1R3CA02# | <b>D1</b> |
|        |               |         | 1.5pF  | ±0.25pF | GRT0335C2A1R5CA02# | <b>D1</b> |
|        |               |         | 1.6pF  | ±0.25pF | GRT0335C2A1R6CA02# | <b>D1</b> |
|        |               |         | 1.8pF  | ±0.25pF | GRT0335C2A1R8CA02# | <b>D1</b> |
|        |               |         | 2.0pF  | ±0.25pF | GRT0335C2A2R0CA02# | <b>D1</b> |
|        |               |         | 2.2pF  | ±0.25pF | GRT0335C2A2R2CA02# | <b>D1</b> |
|        |               |         | 2.4pF  | ±0.25pF | GRT0335C2A2R4CA02# | <b>D1</b> |
|        |               |         | 2.7pF  | ±0.25pF | GRT0335C2A2R7CA02# | <b>D1</b> |
|        |               |         | 3.0pF  | ±0.25pF | GRT0335C2A3R0CA02# | <b>D1</b> |
|        |               |         | 3.3pF  | ±0.25pF | GRT0335C2A3R3CA02# | <b>D1</b> |
|        |               |         | 3.6pF  | ±0.25pF | GRT0335C2A3R6CA02# | <b>D1</b> |
|        |               |         | 3.9pF  | ±0.25pF | GRT0335C2A3R9CA02# | <b>D1</b> |
|        |               |         | 4.0pF  | ±0.25pF | GRT0335C2A4R0CA02# | <b>D1</b> |
|        |               |         | 4.3pF  | ±0.25pF | GRT0335C2A4R3CA02# | <b>D1</b> |
|        |               |         | 4.7pF  | ±0.25pF | GRT0335C2A4R7CA02# | <b>D1</b> |
|        |               |         | 5.0pF  | ±0.25pF | GRT0335C2A5R0CA02# | <b>D1</b> |
|        |               |         | 5.1pF  | ±0.5pF  | GRT0335C2A5R1DA02# | <b>D1</b> |
|        |               |         | 5.6pF  | ±0.5pF  | GRT0335C2A5R6DA02# | <b>D1</b> |
|        |               |         | 6.0pF  | ±0.5pF  | GRT0335C2A6R0DA02# | <b>D1</b> |
|        |               |         | 6.2pF  | ±0.5pF  | GRT0335C2A6R2DA02# | <b>D1</b> |
|        |               |         | 6.8pF  | ±0.5pF  | GRT0335C2A6R8DA02# | <b>D1</b> |
|        |               |         | 7.0pF  | ±0.5pF  | GRT0335C2A7R0DA02# | <b>D1</b> |
|        |               |         | 7.5pF  | ±0.5pF  | GRT0335C2A7R5DA02# | <b>D1</b> |
|        |               |         | 8.0pF  | ±0.5pF  | GRT0335C2A8R0DA02# | <b>D1</b> |
|        |               |         | 8.2pF  | ±0.5pF  | GRT0335C2A8R2DA02# | <b>D1</b> |
|        |               |         | 9.0pF  | ±0.5pF  | GRT0335C2A9R0DA02# | <b>D1</b> |
|        |               |         | 9.1pF  | ±0.5pF  | GRT0335C2A9R1DA02# | <b>D1</b> |
|        |               |         | 10pF   | ±1%     | GRT0335C2A100FA02# | <b>D1</b> |
|        |               |         |        | ±2%     | GRT0335C2A100GA02# | <b>D1</b> |
|        |               |         |        | ±5%     | GRT0335C2A100JA02# | <b>D1</b> |
|        |               |         | 11pF   | ±2%     | GRT0335C2A110GA02# | <b>D1</b> |
|        |               |         |        | ±5%     | GRT0335C2A110JA02# | <b>D1</b> |
|        |               |         | 12pF   | ±1%     | GRT0335C2A120FA02# | <b>D1</b> |
|        |               |         |        | ±2%     | GRT0335C2A120GA02# | <b>D1</b> |
|        |               |         |        | ±5%     | GRT0335C2A120JA02# | <b>D1</b> |
|        |               |         | 13pF   | ±2%     | GRT0335C2A130GA02# | <b>D1</b> |
|        |               |         |        | ±5%     | GRT0335C2A130JA02# | <b>D1</b> |
|        |               |         | 15pF   | ±1%     | GRT0335C2A150FA02# | <b>D1</b> |
|        |               |         |        | ±2%     | GRT0335C2A150GA02# | <b>D1</b> |
|        |               |         |        | ±5%     | GRT0335C2A150JA02# | <b>D1</b> |
|        |               |         | 16pF   | ±2%     | GRT0335C2A160GA02# | <b>D1</b> |
|        |               |         |        | ±5%     | GRT0335C2A160JA02# | <b>D1</b> |
|        |               |         | 18pF   | ±1%     | GRT0335C2A180FA02# | <b>D1</b> |
|        |               |         |        | ±2%     | GRT0335C2A180GA02# | <b>D1</b> |

| T max. | Rated Voltage | TC Code            | Cap.      | Tol. | Part Number        |                    |
|--------|---------------|--------------------|-----------|------|--------------------|--------------------|
| 0.33mm | 100Vdc        | COG                | 18pF      | ±5%  | GRT0335C2A180JA02# | <b>D1</b>          |
|        |               |                    |           | ±1%  | GRT0335C2A200FA02# | <b>D1</b>          |
|        |               |                    |           |      | ±2%                | GRT0335C2A200GA02# |
|        |               |                    | 20pF      | ±2%  | GRT0335C2A200JA02# | <b>D1</b>          |
|        |               |                    |           | ±5%  | GRT0335C2A220FA02# | <b>D1</b>          |
|        |               |                    |           |      | ±1%                | GRT0335C2A220GA02# |
|        |               |                    | 22pF      | ±2%  | GRT0335C2A220JA02# | <b>D1</b>          |
|        |               |                    |           | ±5%  | GRT0335C2A240FA02# | <b>D1</b>          |
|        |               |                    |           |      | ±1%                | GRT0335C2A240GA02# |
|        |               |                    | 24pF      | ±2%  | GRT0335C2A240JA02# | <b>D1</b>          |
|        |               |                    |           | ±5%  | GRT0335C2A240FA02# | <b>D1</b>          |
|        |               |                    |           |      | ±1%                | GRT0335C2A270FA02# |
|        |               |                    | 27pF      | ±2%  | GRT0335C2A270GA02# | <b>D1</b>          |
|        |               |                    |           | ±5%  | GRT0335C2A270JA02# | <b>D1</b>          |
|        |               |                    |           |      | ±1%                | GRT0335C2A300FA02# |
|        |               |                    | 30pF      | ±2%  | GRT0335C2A300GA02# | <b>D1</b>          |
|        |               |                    |           | ±5%  | GRT0335C2A300JA02# | <b>D1</b>          |
|        |               |                    |           |      | ±1%                | GRT0335C2A330FA02# |
|        |               |                    | 33pF      | ±2%  | GRT0335C2A330GA02# | <b>D1</b>          |
|        |               |                    |           | ±5%  | GRT0335C2A330JA02# | <b>D1</b>          |
|        |               |                    |           |      | ±1%                | GRT0335C2A360FA02# |
|        |               |                    | 36pF      | ±2%  | GRT0335C2A360GA02# | <b>D1</b>          |
|        |               |                    |           | ±5%  | GRT0335C2A360JA02# | <b>D1</b>          |
|        |               |                    |           |      | ±1%                | GRT0335C2A390FA02# |
|        |               |                    | 39pF      | ±2%  | GRT0335C2A390GA02# | <b>D1</b>          |
|        |               |                    |           | ±5%  | GRT0335C2A390JA02# | <b>D1</b>          |
|        |               |                    |           |      | ±1%                | GRT0335C2A430FA02# |
|        |               |                    | 43pF      | ±2%  | GRT0335C2A430GA02# | <b>D1</b>          |
|        |               |                    |           | ±5%  | GRT0335C2A430JA02# | <b>D1</b>          |
|        |               |                    |           |      | ±1%                | GRT0335C2A470FA02# |
|        |               |                    | 47pF      | ±2%  | GRT0335C2A470GA02# | <b>D1</b>          |
|        |               |                    |           | ±5%  | GRT0335C2A470JA02# | <b>D1</b>          |
|        |               |                    |           |      | ±1%                | GRT0335C2A510FA02# |
|        |               |                    | 51pF      | ±2%  | GRT0335C2A510GA02# | <b>D1</b>          |
|        |               |                    |           | ±5%  | GRT0335C2A510JA02# | <b>D1</b>          |
|        |               |                    |           |      | ±1%                | GRT0335C2A560FA02# |
|        |               |                    | 56pF      | ±2%  | GRT0335C2A560GA02# | <b>D1</b>          |
|        |               |                    |           | ±5%  | GRT0335C2A560JA02# | <b>D1</b>          |
|        |               |                    |           |      | ±1%                | GRT0335C2A620FA02# |
|        |               |                    | 62pF      | ±2%  | GRT0335C2A620GA02# | <b>D1</b>          |
|        |               |                    |           | ±5%  | GRT0335C2A620JA02# | <b>D1</b>          |
|        |               |                    |           |      | ±1%                | GRT0335C2A680FA02# |
|        |               |                    | 68pF      | ±2%  | GRT0335C2A680GA02# | <b>D1</b>          |
|        |               |                    |           | ±5%  | GRT0335C2A680JA02# | <b>D1</b>          |
|        |               |                    |           |      | ±1%                | GRT0335C2A750FA02# |
|        |               |                    | 75pF      | ±2%  | GRT0335C2A750GA02# | <b>D1</b>          |
|        |               |                    |           | ±5%  | GRT0335C2A750JA02# | <b>D1</b>          |
|        |               |                    |           |      | ±1%                | GRT0335C2A820FA02# |
|        |               |                    | 82pF      | ±2%  | GRT0335C2A820GA02# | <b>D1</b>          |
|        |               |                    |           | ±5%  | GRT0335C2A820JA02# | <b>D1</b>          |
|        |               |                    |           |      | ±1%                | GRT0335C2A910FA02# |
|        |               |                    | 91pF      | ±2%  | GRT0335C2A910GA02# | <b>D1</b>          |
|        |               |                    |           | ±5%  | GRT0335C2A910JA02# | <b>D1</b>          |
|        |               |                    |           |      | ±1%                | GRT0335C2A101FA02# |
| 100pF  | ±2%           | GRT0335C2A101GA02# | <b>D1</b> |      |                    |                    |

Part number # indicates the package specification code.

GRT Series  
 GCM Series  
 GC3 Series  
 GCJ Series  
 GCQ Series  
 GCD Series  
 GCE Series  
 NMF Series  
 KCM Series  
 KC3 Series  
 KCA Series  
 GCB Series  
 GCG Series  
 △Caution /Notice

# GRT Series Temperature Compensating Type Part Number List

(→ 0.6×0.3mm)

| T max. | Rated Voltage      | TC Code            | Cap.               | Tol.               | Part Number        |                    | T max.    | Rated Voltage | TC Code | Cap.               | Tol.               | Part Number        |                    |
|--------|--------------------|--------------------|--------------------|--------------------|--------------------|--------------------|-----------|---------------|---------|--------------------|--------------------|--------------------|--------------------|
| 0.33mm | 100Vdc             | COG                | 100pF              | ±5%                | GRT0335C2A101JA02# | <b>D1</b>          | 0.33mm    | 50Vdc         | COG     | 12pF               | ±5%                | GRT0335C1H120JA02# | <b>D1</b>          |
|        | 50Vdc              | COG                | 0.10pF             | ±0.05pF            | GRT0335C1HR10WA02# | <b>D1</b>          |           |               |         | 13pF               | ±1%                | GRT0335C1H130FA02# | <b>D1</b>          |
|        |                    |                    |                    | ±0.05pF            | GRT0335C1HR20WA02# | <b>D1</b>          |           |               |         |                    | ±2%                | GRT0335C1H130GA02# | <b>D1</b>          |
|        |                    |                    | ±0.1pF             | GRT0335C1HR20BA02# | <b>D1</b>          | ±5%                |           |               |         |                    | GRT0335C1H130JA02# | <b>D1</b>          |                    |
|        |                    |                    |                    | 0.30pF             | ±0.05pF            | GRT0335C1HR30WA02# |           |               |         | <b>D1</b>          | 15pF               | ±1%                | GRT0335C1H150FA02# |
|        |                    |                    | ±0.1pF             |                    | GRT0335C1HR30BA02# | <b>D1</b>          |           |               |         | ±2%                |                    | GRT0335C1H150GA02# | <b>D1</b>          |
|        |                    |                    | ±0.05pF            |                    | GRT0335C1HR47WA02# | <b>D1</b>          |           |               |         | ±5%                |                    | GRT0335C1H150JA02# | <b>D1</b>          |
|        |                    |                    | ±0.1pF             | GRT0335C1HR47BA02# | <b>D1</b>          | 16pF               |           |               |         | ±1%                | GRT0335C1H160FA02# | <b>D1</b>          |                    |
|        |                    |                    |                    | ±0.05pF            | GRT0335C1HR56WA02# |                    |           |               |         | <b>D1</b>          | ±2%                | GRT0335C1H160GA02# | <b>D1</b>          |
|        |                    |                    | ±0.1pF             | GRT0335C1HR56BA02# | <b>D1</b>          |                    |           |               |         | ±5%                | GRT0335C1H160JA02# | <b>D1</b>          |                    |
|        |                    |                    | 0.68pF             | ±0.05pF            | GRT0335C1HR68WA02# | <b>D1</b>          |           |               |         | 18pF               | ±1%                | GRT0335C1H180FA02# | <b>D1</b>          |
|        |                    |                    |                    | ±0.1pF             | GRT0335C1HR68BA02# | <b>D1</b>          |           |               |         |                    | ±2%                | GRT0335C1H180GA02# | <b>D1</b>          |
|        |                    |                    | ±0.05pF            | GRT0335C1HR75WA02# | <b>D1</b>          | ±5%                |           |               |         |                    | GRT0335C1H180JA02# | <b>D1</b>          |                    |
|        |                    |                    | ±0.1pF             | GRT0335C1HR75BA02# | <b>D1</b>          | 20pF               |           |               |         | ±1%                | GRT0335C1H200FA02# | <b>D1</b>          |                    |
|        |                    |                    |                    | ±0.05pF            | GRT0335C1HR82WA02# |                    |           |               |         | <b>D1</b>          | ±2%                | GRT0335C1H200GA02# | <b>D1</b>          |
|        |                    |                    | ±0.1pF             | GRT0335C1HR82BA02# | <b>D1</b>          |                    |           |               |         | ±5%                | GRT0335C1H200JA02# | <b>D1</b>          |                    |
|        |                    |                    | 0.91pF             | ±0.05pF            | GRT0335C1HR91WA02# | <b>D1</b>          |           |               |         | 22pF               | ±1%                | GRT0335C1H220FA02# | <b>D1</b>          |
|        |                    |                    |                    | ±0.1pF             | GRT0335C1HR91BA02# | <b>D1</b>          |           |               |         |                    | ±2%                | GRT0335C1H220GA02# | <b>D1</b>          |
|        |                    |                    | ±0.25pF            | GRT0335C1H1R0CA02# | <b>D1</b>          | ±5%                |           |               |         |                    | GRT0335C1H220JA02# | <b>D1</b>          |                    |
|        |                    |                    | ±0.25pF            | GRT0335C1H1R1CA02# | <b>D1</b>          | 24pF               |           |               |         | ±1%                | GRT0335C1H240FA02# | <b>D1</b>          |                    |
|        |                    |                    | ±0.25pF            | GRT0335C1H1R2CA02# | <b>D1</b>          |                    |           |               |         | ±2%                | GRT0335C1H240GA02# | <b>D1</b>          |                    |
|        |                    |                    | ±0.25pF            | GRT0335C1H1R3CA02# | <b>D1</b>          |                    |           |               |         | ±5%                | GRT0335C1H240JA02# | <b>D1</b>          |                    |
|        |                    |                    | ±0.25pF            | GRT0335C1H1R5CA02# | <b>D1</b>          | 27pF               |           |               |         | ±1%                | GRT0335C1H270FA02# | <b>D1</b>          |                    |
|        |                    |                    | ±0.25pF            | GRT0335C1H1R6CA02# | <b>D1</b>          |                    |           |               |         | ±2%                | GRT0335C1H270GA02# | <b>D1</b>          |                    |
|        |                    |                    | ±0.25pF            | GRT0335C1H1R8CA02# | <b>D1</b>          |                    |           |               |         | ±5%                | GRT0335C1H270JA02# | <b>D1</b>          |                    |
|        |                    |                    | ±0.25pF            | GRT0335C1H2R0CA02# | <b>D1</b>          | 30pF               |           |               |         | ±1%                | GRT0335C1H300FA02# | <b>D1</b>          |                    |
|        |                    |                    | ±0.25pF            | GRT0335C1H2R2CA02# | <b>D1</b>          |                    |           |               |         | ±2%                | GRT0335C1H300GA02# | <b>D1</b>          |                    |
|        |                    |                    | ±0.25pF            | GRT0335C1H2R4CA02# | <b>D1</b>          |                    |           |               |         | ±5%                | GRT0335C1H300JA02# | <b>D1</b>          |                    |
|        |                    |                    | ±0.25pF            | GRT0335C1H2R7CA02# | <b>D1</b>          | 33pF               |           |               |         | ±1%                | GRT0335C1H330FA02# | <b>D1</b>          |                    |
|        |                    |                    | ±0.25pF            | GRT0335C1H3R0CA02# | <b>D1</b>          |                    |           |               |         | ±2%                | GRT0335C1H330GA02# | <b>D1</b>          |                    |
|        |                    |                    | ±0.25pF            | GRT0335C1H3R3CA02# | <b>D1</b>          |                    |           |               |         | ±5%                | GRT0335C1H330JA02# | <b>D1</b>          |                    |
|        |                    |                    | ±0.25pF            | GRT0335C1H3R6CA02# | <b>D1</b>          | 36pF               |           |               |         | ±1%                | GRT0335C1H360FA02# | <b>D1</b>          |                    |
|        |                    |                    | ±0.25pF            | GRT0335C1H3R9CA02# | <b>D1</b>          |                    |           |               |         | ±2%                | GRT0335C1H360GA02# | <b>D1</b>          |                    |
|        |                    |                    | ±0.25pF            | GRT0335C1H4R0CA02# | <b>D1</b>          |                    |           |               |         | ±5%                | GRT0335C1H360JA02# | <b>D1</b>          |                    |
|        |                    |                    | ±0.25pF            | GRT0335C1H4R3CA02# | <b>D1</b>          | 39pF               |           |               |         | ±1%                | GRT0335C1H390FA02# | <b>D1</b>          |                    |
|        |                    |                    | ±0.25pF            | GRT0335C1H4R7CA02# | <b>D1</b>          |                    |           |               |         | ±2%                | GRT0335C1H390GA02# | <b>D1</b>          |                    |
|        |                    |                    | ±0.25pF            | GRT0335C1H5R0CA02# | <b>D1</b>          |                    |           |               |         | ±5%                | GRT0335C1H390JA02# | <b>D1</b>          |                    |
|        |                    |                    | ±0.5pF             | GRT0335C1H5R1DA02# | <b>D1</b>          | 43pF               |           |               |         | ±1%                | GRT0335C1H430FA02# | <b>D1</b>          |                    |
|        |                    |                    | ±0.5pF             | GRT0335C1H5R6DA02# | <b>D1</b>          |                    |           |               |         | ±2%                | GRT0335C1H430GA02# | <b>D1</b>          |                    |
|        |                    |                    | ±0.5pF             | GRT0335C1H6R0DA02# | <b>D1</b>          |                    |           |               |         | ±5%                | GRT0335C1H430JA02# | <b>D1</b>          |                    |
|        |                    |                    | ±0.5pF             | GRT0335C1H6R2DA02# | <b>D1</b>          | 47pF               |           |               |         | ±1%                | GRT0335C1H470FA02# | <b>D1</b>          |                    |
|        |                    |                    | ±0.5pF             | GRT0335C1H6R8DA02# | <b>D1</b>          |                    |           |               |         | ±2%                | GRT0335C1H470GA02# | <b>D1</b>          |                    |
|        |                    |                    | ±0.5pF             | GRT0335C1H7R0DA02# | <b>D1</b>          |                    |           |               |         | ±5%                | GRT0335C1H470JA02# | <b>D1</b>          |                    |
|        |                    |                    | ±0.5pF             | GRT0335C1H7R5DA02# | <b>D1</b>          | 51pF               |           |               |         | ±1%                | GRT0335C1H510FA02# | <b>D1</b>          |                    |
|        |                    |                    | ±0.5pF             | GRT0335C1H8R0DA02# | <b>D1</b>          |                    |           |               |         | ±2%                | GRT0335C1H510GA02# | <b>D1</b>          |                    |
|        |                    |                    | ±0.5pF             | GRT0335C1H8R2DA02# | <b>D1</b>          |                    |           |               |         | ±5%                | GRT0335C1H510JA02# | <b>D1</b>          |                    |
|        |                    |                    | ±0.5pF             | GRT0335C1H9R0DA02# | <b>D1</b>          | 56pF               |           |               |         | ±1%                | GRT0335C1H560FA02# | <b>D1</b>          |                    |
|        |                    |                    | ±0.5pF             | GRT0335C1H9R1DA02# | <b>D1</b>          |                    |           |               |         | ±2%                | GRT0335C1H560GA02# | <b>D1</b>          |                    |
|        |                    |                    | ±5%                | GRT0335C1H100JA02# | <b>D1</b>          |                    |           |               |         | ±5%                | GRT0335C1H560JA02# | <b>D1</b>          |                    |
|        | ±1%                | GRT0335C1H110FA02# | <b>D1</b>          | 62pF               | ±1%                | GRT0335C1H620FA02# |           |               |         | <b>D1</b>          |                    |                    |                    |
|        |                    | ±2%                | GRT0335C1H110GA02# |                    | <b>D1</b>          | ±2%                |           |               |         | GRT0335C1H620GA02# | <b>D1</b>          |                    |                    |
|        |                    | ±5%                | GRT0335C1H110JA02# |                    | <b>D1</b>          | ±5%                |           |               |         | GRT0335C1H620JA02# | <b>D1</b>          |                    |                    |
| ±1%    | GRT0335C1H120FA02# | <b>D1</b>          | 68pF               | ±1%                | GRT0335C1H680FA02# | <b>D1</b>          |           |               |         |                    |                    |                    |                    |
|        | ±2%                | GRT0335C1H120GA02# |                    | <b>D1</b>          | ±2%                | GRT0335C1H680GA02# | <b>D1</b> |               |         |                    |                    |                    |                    |

Part number # indicates the package specification code.

GRT Series  
 GCM Series  
 GC3 Series  
 GCJ Series  
 GCQ Series  
 GCD Series  
 GCE Series  
 NMF Series  
 KCM Series  
 KC3 Series  
 KCA Series  
 GCB Series  
 GCG Series  
 ⚠Caution / Notice

# GRT Series Temperature Compensating Type Part Number List

(→ 0.6×0.3mm)

| T max. | Rated Voltage | TC Code | Cap.   | Tol.    | Part Number        |           |                    |           |
|--------|---------------|---------|--------|---------|--------------------|-----------|--------------------|-----------|
| 0.33mm | 50Vdc         | COG     | 68pF   | ±5%     | GRT0335C1H680JA02# | <b>D1</b> |                    |           |
|        |               |         |        | ±1%     | GRT0335C1H750FA02# | <b>D1</b> |                    |           |
|        |               |         |        |         | GRT0335C1H750GA02# | <b>D1</b> |                    |           |
|        |               |         |        |         | GRT0335C1H750JA02# | <b>D1</b> |                    |           |
|        |               |         | 82pF   | ±1%     | GRT0335C1H820FA02# | <b>D1</b> |                    |           |
|        |               |         |        | ±2%     | GRT0335C1H820GA02# | <b>D1</b> |                    |           |
|        |               |         |        | ±5%     | GRT0335C1H820JA02# | <b>D1</b> |                    |           |
|        |               |         | 91pF   | ±1%     | GRT0335C1H910FA02# | <b>D1</b> |                    |           |
|        |               |         |        | ±2%     | GRT0335C1H910GA02# | <b>D1</b> |                    |           |
|        |               |         |        | ±5%     | GRT0335C1H910JA02# | <b>D1</b> |                    |           |
|        |               |         | 100pF  | ±1%     | GRT0335C1H101FA02# | <b>D1</b> |                    |           |
|        |               |         |        | ±2%     | GRT0335C1H101GA02# | <b>D1</b> |                    |           |
|        |               |         |        | ±5%     | GRT0335C1H101JA02# | <b>D1</b> |                    |           |
|        |               |         | 110pF  | ±1%     | GRT0335C1H111FA02# | <b>D1</b> |                    |           |
|        |               |         |        | ±2%     | GRT0335C1H111GA02# | <b>D1</b> |                    |           |
|        |               |         |        | ±5%     | GRT0335C1H111JA02# | <b>D1</b> |                    |           |
|        |               |         | 120pF  | ±1%     | GRT0335C1H121FA02# | <b>D1</b> |                    |           |
|        |               |         |        | ±2%     | GRT0335C1H121GA02# | <b>D1</b> |                    |           |
|        |               |         |        | ±5%     | GRT0335C1H121JA02# | <b>D1</b> |                    |           |
|        |               |         | 150pF  | ±1%     | GRT0335C1H151FA02# | <b>D1</b> |                    |           |
|        |               |         |        | ±2%     | GRT0335C1H151GA02# | <b>D1</b> |                    |           |
|        |               |         |        | ±5%     | GRT0335C1H151JA02# | <b>D1</b> |                    |           |
|        |               |         | 180pF  | ±1%     | GRT0335C1H181FA02# | <b>D1</b> |                    |           |
|        |               |         |        | ±2%     | GRT0335C1H181GA02# | <b>D1</b> |                    |           |
|        |               |         |        | ±5%     | GRT0335C1H181JA02# | <b>D1</b> |                    |           |
|        |               |         | 220pF  | ±1%     | GRT0335C1H221FA02# | <b>D1</b> |                    |           |
|        |               |         |        | ±2%     | GRT0335C1H221GA02# | <b>D1</b> |                    |           |
|        |               |         |        | ±5%     | GRT0335C1H221JA02# | <b>D1</b> |                    |           |
|        |               |         | 25Vdc  | COG     | 0.10pF             | ±0.05pF   | GRT0335C1ER10WA02# | <b>D1</b> |
|        |               |         |        |         |                    | ±0.1pF    | GRT0335C1ER11BA02# | <b>D1</b> |
|        |               |         |        |         | 0.12pF             | ±0.05pF   | GRT0335C1ER12WA02# | <b>D1</b> |
|        |               |         |        |         |                    | ±0.1pF    | GRT0335C1ER12BA02# | <b>D1</b> |
|        |               |         |        |         | 0.13pF             | ±0.05pF   | GRT0335C1ER13WA02# | <b>D1</b> |
|        |               |         |        |         |                    | ±0.1pF    | GRT0335C1ER13BA02# | <b>D1</b> |
|        |               |         |        |         | 0.15pF             | ±0.05pF   | GRT0335C1ER15WA02# | <b>D1</b> |
|        |               |         |        |         |                    | ±0.1pF    | GRT0335C1ER15BA02# | <b>D1</b> |
|        |               |         |        |         | 0.16pF             | ±0.05pF   | GRT0335C1ER16WA02# | <b>D1</b> |
|        |               |         |        |         |                    | ±0.1pF    | GRT0335C1ER16BA02# | <b>D1</b> |
|        |               |         |        |         | 0.18pF             | ±0.05pF   | GRT0335C1ER18WA02# | <b>D1</b> |
|        |               |         |        |         |                    | ±0.1pF    | GRT0335C1ER18BA02# | <b>D1</b> |
|        |               |         |        |         | 0.20pF             | ±0.05pF   | GRT0335C1ER20WA02# | <b>D1</b> |
|        |               |         |        |         |                    | ±0.1pF    | GRT0335C1ER20BA02# | <b>D1</b> |
|        |               |         |        |         | 0.22pF             | ±0.05pF   | GRT0335C1ER22WA02# | <b>D1</b> |
|        |               |         |        |         |                    | ±0.1pF    | GRT0335C1ER22BA02# | <b>D1</b> |
|        |               |         |        |         | 0.24pF             | ±0.05pF   | GRT0335C1ER24WA02# | <b>D1</b> |
|        |               |         |        |         |                    | ±0.1pF    | GRT0335C1ER24BA02# | <b>D1</b> |
|        |               |         |        |         | 0.27pF             | ±0.05pF   | GRT0335C1ER27WA02# | <b>D1</b> |
|        |               |         |        |         |                    | ±0.1pF    | GRT0335C1ER27BA02# | <b>D1</b> |
|        |               |         |        |         | 0.30pF             | ±0.05pF   | GRT0335C1ER30WA02# | <b>D1</b> |
|        |               |         |        |         |                    | ±0.1pF    | GRT0335C1ER30BA02# | <b>D1</b> |
|        |               |         |        |         | 0.33pF             | ±0.05pF   | GRT0335C1ER33WA02# | <b>D1</b> |
|        |               |         |        |         |                    | ±0.1pF    | GRT0335C1ER33BA02# | <b>D1</b> |
|        |               |         | 0.36pF | ±0.05pF | GRT0335C1ER36WA02# | <b>D1</b> |                    |           |

| T max.  | Rated Voltage      | TC Code            | Cap.      | Tol.    | Part Number        |                    |
|---------|--------------------|--------------------|-----------|---------|--------------------|--------------------|
| 0.33mm  | 25Vdc              | COG                | 0.36pF    | ±0.1pF  | GRT0335C1ER36BA02# | <b>D1</b>          |
|         |                    |                    |           | ±0.05pF | GRT0335C1ER39WA02# | <b>D1</b>          |
|         |                    |                    |           |         | ±0.1pF             | GRT0335C1ER39BA02# |
|         |                    |                    | 0.43pF    | ±0.05pF | GRT0335C1ER43WA02# | <b>D1</b>          |
|         |                    |                    |           | ±0.1pF  | GRT0335C1ER43BA02# | <b>D1</b>          |
|         |                    |                    | 0.47pF    | ±0.05pF | GRT0335C1ER47WA02# | <b>D1</b>          |
|         |                    |                    |           | ±0.1pF  | GRT0335C1ER47BA02# | <b>D1</b>          |
|         |                    |                    | 0.51pF    | ±0.05pF | GRT0335C1ER51WA02# | <b>D1</b>          |
|         |                    |                    |           | ±0.1pF  | GRT0335C1ER51BA02# | <b>D1</b>          |
|         |                    |                    | 0.56pF    | ±0.05pF | GRT0335C1ER56WA02# | <b>D1</b>          |
|         |                    |                    |           | ±0.1pF  | GRT0335C1ER56BA02# | <b>D1</b>          |
|         |                    |                    | 0.62pF    | ±0.05pF | GRT0335C1ER62WA02# | <b>D1</b>          |
|         |                    |                    |           | ±0.1pF  | GRT0335C1ER62BA02# | <b>D1</b>          |
|         |                    |                    | 0.68pF    | ±0.05pF | GRT0335C1ER68WA02# | <b>D1</b>          |
|         |                    |                    |           | ±0.1pF  | GRT0335C1ER68BA02# | <b>D1</b>          |
|         |                    |                    | 0.75pF    | ±0.05pF | GRT0335C1ER75WA02# | <b>D1</b>          |
|         |                    |                    |           | ±0.1pF  | GRT0335C1ER75BA02# | <b>D1</b>          |
|         |                    |                    | 0.82pF    | ±0.05pF | GRT0335C1ER82WA02# | <b>D1</b>          |
|         |                    |                    |           | ±0.1pF  | GRT0335C1ER82BA02# | <b>D1</b>          |
|         |                    |                    | 0.91pF    | ±0.05pF | GRT0335C1ER91WA02# | <b>D1</b>          |
|         |                    |                    |           | ±0.1pF  | GRT0335C1ER91BA02# | <b>D1</b>          |
|         |                    |                    | 1.0pF     | ±0.25pF | GRT0335C1E1R0CA02# | <b>D1</b>          |
|         |                    |                    |           | ±0.25pF | GRT0335C1E1R1CA02# | <b>D1</b>          |
|         |                    |                    | 1.1pF     | ±0.25pF | GRT0335C1E1R2CA02# | <b>D1</b>          |
|         |                    |                    |           | ±0.25pF | GRT0335C1E1R3CA02# | <b>D1</b>          |
|         |                    |                    | 1.2pF     | ±0.25pF | GRT0335C1E1R4CA02# | <b>D1</b>          |
|         |                    |                    |           | ±0.25pF | GRT0335C1E1R5CA02# | <b>D1</b>          |
|         |                    |                    | 1.3pF     | ±0.25pF | GRT0335C1E1R6CA02# | <b>D1</b>          |
|         |                    |                    |           | ±0.25pF | GRT0335C1E1R7CA02# | <b>D1</b>          |
|         |                    |                    | 1.5pF     | ±0.25pF | GRT0335C1E1R8CA02# | <b>D1</b>          |
|         |                    |                    |           | ±0.25pF | GRT0335C1E1R9CA02# | <b>D1</b>          |
|         |                    |                    | 1.6pF     | ±0.25pF | GRT0335C1E1R0CA02# | <b>D1</b>          |
|         |                    |                    |           | ±0.25pF | GRT0335C1E1R1CA02# | <b>D1</b>          |
|         |                    |                    | 1.8pF     | ±0.25pF | GRT0335C1E1R2CA02# | <b>D1</b>          |
|         |                    |                    |           | ±0.25pF | GRT0335C1E1R3CA02# | <b>D1</b>          |
|         |                    |                    | 2.0pF     | ±0.25pF | GRT0335C1E1R4CA02# | <b>D1</b>          |
|         |                    |                    |           | ±0.25pF | GRT0335C1E1R5CA02# | <b>D1</b>          |
|         |                    |                    | 2.2pF     | ±0.25pF | GRT0335C1E1R6CA02# | <b>D1</b>          |
|         |                    |                    |           | ±0.25pF | GRT0335C1E1R7CA02# | <b>D1</b>          |
|         |                    |                    | 2.4pF     | ±0.25pF | GRT0335C1E1R8CA02# | <b>D1</b>          |
|         |                    |                    |           | ±0.25pF | GRT0335C1E1R9CA02# | <b>D1</b>          |
|         |                    |                    | 2.7pF     | ±0.25pF | GRT0335C1E1R0CA02# | <b>D1</b>          |
|         |                    |                    |           | ±0.25pF | GRT0335C1E1R1CA02# | <b>D1</b>          |
|         |                    |                    | 3.0pF     | ±0.25pF | GRT0335C1E1R2CA02# | <b>D1</b>          |
|         |                    |                    |           | ±0.25pF | GRT0335C1E1R3CA02# | <b>D1</b>          |
|         |                    |                    | 3.3pF     | ±0.25pF | GRT0335C1E1R4CA02# | <b>D1</b>          |
|         |                    |                    |           | ±0.25pF | GRT0335C1E1R5CA02# | <b>D1</b>          |
|         |                    |                    | 3.6pF     | ±0.25pF | GRT0335C1E1R6CA02# | <b>D1</b>          |
|         |                    |                    |           | ±0.25pF | GRT0335C1E1R7CA02# | <b>D1</b>          |
|         |                    |                    | 3.9pF     | ±0.25pF | GRT0335C1E1R8CA02# | <b>D1</b>          |
|         |                    |                    |           | ±0.25pF | GRT0335C1E1R9CA02# | <b>D1</b>          |
|         |                    |                    | 4.0pF     | ±0.25pF | GRT0335C1E1R0CA02# | <b>D1</b>          |
|         |                    |                    |           | ±0.25pF | GRT0335C1E1R1CA02# | <b>D1</b>          |
|         |                    |                    | 4.3pF     | ±0.25pF | GRT0335C1E1R2CA02# | <b>D1</b>          |
| ±0.25pF | GRT0335C1E1R3CA02# | <b>D1</b>          |           |         |                    |                    |
| 4.7pF   | ±0.25pF            | GRT0335C1E1R4CA02# | <b>D1</b> |         |                    |                    |
|         | ±0.25pF            | GRT0335C1E1R5CA02# | <b>D1</b> |         |                    |                    |
| 5.0pF   | ±0.25pF            | GRT0335C1E1R6CA02# | <b>D1</b> |         |                    |                    |
|         | ±0.5pF             | GRT0335C1E1R7CA02# | <b>D1</b> |         |                    |                    |
| 5.1pF   | ±0.5pF             | GRT0335C1E1R8CA02# | <b>D1</b> |         |                    |                    |
|         | ±0.5pF             | GRT0335C1E1R9CA02# | <b>D1</b> |         |                    |                    |
| 5.6pF   | ±0.5pF             | GRT0335C1E1R0CA02# | <b>D1</b> |         |                    |                    |
|         | ±0.5pF             | GRT0335C1E1R1CA02# | <b>D1</b> |         |                    |                    |
| 6.0pF   | ±0.5pF             | GRT0335C1E1R2CA02# | <b>D1</b> |         |                    |                    |
|         | ±0.5pF             | GRT0335C1E1R3CA02# | <b>D1</b> |         |                    |                    |
| 6.2pF   | ±0.5pF             | GRT0335C1E1R4CA02# | <b>D1</b> |         |                    |                    |
|         | ±0.5pF             | GRT0335C1E1R5CA02# | <b>D1</b> |         |                    |                    |
| 6.8pF   | ±0.5pF             | GRT0335C1E1R6CA02# | <b>D1</b> |         |                    |                    |
|         | ±0.5pF             | GRT0335C1E1R7CA02# | <b>D1</b> |         |                    |                    |
| 7.0pF   | ±0.5pF             | GRT0335C1E1R8CA02# | <b>D1</b> |         |                    |                    |
|         | ±0.5pF             | GRT0335C1E1R9CA02# | <b>D1</b> |         |                    |                    |
| 7.5pF   | ±0.5pF             | GRT0335C1E1R0CA02# | <b>D1</b> |         |                    |                    |
|         | ±0.5pF             | GRT0335C1E1R1CA02# | <b>D1</b> |         |                    |                    |
| 8.0pF   | ±0.5pF             | GRT0335C1E1R2CA02# | <b>D1</b> |         |                    |                    |
|         | ±0.5pF             | GRT0335C1E1R3CA02# | <b>D1</b> |         |                    |                    |
| 8.2pF   | ±0.5pF             | GRT0335C1E1R4CA02# | <b>D1</b> |         |                    |                    |
|         | ±0.5pF             | GRT0335C1E1R5CA02# | <b>D1</b> |         |                    |                    |
| 9.0pF   | ±0.5pF             | GRT0335C1E1R6CA02# | <b>D1</b> |         |                    |                    |
|         | ±0.5pF             | GRT0335C1E1R7CA02# | <b>D1</b> |         |                    |                    |
| 9.1pF   | ±0.5pF             | GRT0335C1E1R8CA02# | <b>D1</b> |         |                    |                    |
|         | ±0.5pF             | GRT0335C1E1R9CA02# | <b>D1</b> |         |                    |                    |
| 10pF    | ±1%                | GRT0335C1E100FA02# | <b>D1</b> |         |                    |                    |
|         | ±2%                | GRT0335C1E100GA02# | <b>D1</b> |         |                    |                    |
|         | ±5%                | GRT0335C1E100JA02# | <b>D1</b> |         |                    |                    |

Part number # indicates the package specification code.

GRT Series  
 GCM Series  
 GC3 Series  
 GCJ Series  
 GCQ Series  
 GCD Series  
 GCE Series  
 NMF Series  
 KCM Series  
 KC3 Series  
 KCA Series  
 GCB Series  
 GCG Series  
 △Caution / Notice



# GRT Series Temperature Compensating Type Part Number List

(→ 0.6×0.3mm)

| T max. | Rated Voltage | TC Code | Cap. | Tol. | Part Number        |           |
|--------|---------------|---------|------|------|--------------------|-----------|
| 0.33mm | 25Vdc         | COG     | 11pF | ±1%  | GRT0335C1E110FA02# | <b>D1</b> |
|        |               |         |      | ±2%  | GRT0335C1E110GA02# | <b>D1</b> |
|        |               |         |      | ±5%  | GRT0335C1E110JA02# | <b>D1</b> |
|        |               |         | 12pF | ±1%  | GRT0335C1E120FA02# | <b>D1</b> |
|        |               |         |      | ±2%  | GRT0335C1E120GA02# | <b>D1</b> |
|        |               |         |      | ±5%  | GRT0335C1E120JA02# | <b>D1</b> |
|        |               |         | 13pF | ±1%  | GRT0335C1E130FA02# | <b>D1</b> |
|        |               |         |      | ±2%  | GRT0335C1E130GA02# | <b>D1</b> |
|        |               |         |      | ±5%  | GRT0335C1E130JA02# | <b>D1</b> |
|        |               |         | 15pF | ±1%  | GRT0335C1E150FA02# | <b>D1</b> |
|        |               |         |      | ±2%  | GRT0335C1E150GA02# | <b>D1</b> |
|        |               |         |      | ±5%  | GRT0335C1E150JA02# | <b>D1</b> |
|        |               |         | 16pF | ±1%  | GRT0335C1E160FA02# | <b>D1</b> |
|        |               |         |      | ±2%  | GRT0335C1E160GA02# | <b>D1</b> |
|        |               |         |      | ±5%  | GRT0335C1E160JA02# | <b>D1</b> |
|        |               |         | 18pF | ±1%  | GRT0335C1E180FA02# | <b>D1</b> |
|        |               |         |      | ±2%  | GRT0335C1E180GA02# | <b>D1</b> |
|        |               |         |      | ±5%  | GRT0335C1E180JA02# | <b>D1</b> |
|        |               |         | 20pF | ±1%  | GRT0335C1E200FA02# | <b>D1</b> |
|        |               |         |      | ±2%  | GRT0335C1E200GA02# | <b>D1</b> |
|        |               |         |      | ±5%  | GRT0335C1E200JA02# | <b>D1</b> |
|        |               |         | 22pF | ±1%  | GRT0335C1E220FA02# | <b>D1</b> |
|        |               |         |      | ±2%  | GRT0335C1E220GA02# | <b>D1</b> |
|        |               |         |      | ±5%  | GRT0335C1E220JA02# | <b>D1</b> |
|        |               |         | 24pF | ±1%  | GRT0335C1E240FA02# | <b>D1</b> |
|        |               |         |      | ±2%  | GRT0335C1E240GA02# | <b>D1</b> |
|        |               |         |      | ±5%  | GRT0335C1E240JA02# | <b>D1</b> |
|        |               |         | 27pF | ±1%  | GRT0335C1E270FA02# | <b>D1</b> |
|        |               |         |      | ±2%  | GRT0335C1E270GA02# | <b>D1</b> |
|        |               |         |      | ±5%  | GRT0335C1E270JA02# | <b>D1</b> |
|        |               |         | 30pF | ±1%  | GRT0335C1E300FA02# | <b>D1</b> |
|        |               |         |      | ±2%  | GRT0335C1E300GA02# | <b>D1</b> |
|        |               |         |      | ±5%  | GRT0335C1E300JA02# | <b>D1</b> |
|        |               |         | 33pF | ±1%  | GRT0335C1E330FA02# | <b>D1</b> |
|        |               |         |      | ±2%  | GRT0335C1E330GA02# | <b>D1</b> |
|        |               |         |      | ±5%  | GRT0335C1E330JA02# | <b>D1</b> |
|        |               |         | 36pF | ±1%  | GRT0335C1E360FA02# | <b>D1</b> |
|        |               |         |      | ±2%  | GRT0335C1E360GA02# | <b>D1</b> |
|        |               |         |      | ±5%  | GRT0335C1E360JA02# | <b>D1</b> |
|        |               |         | 39pF | ±1%  | GRT0335C1E390FA02# | <b>D1</b> |
|        |               |         |      | ±2%  | GRT0335C1E390GA02# | <b>D1</b> |
|        |               |         |      | ±5%  | GRT0335C1E390JA02# | <b>D1</b> |
|        |               |         | 43pF | ±1%  | GRT0335C1E430FA02# | <b>D1</b> |
|        |               |         |      | ±2%  | GRT0335C1E430GA02# | <b>D1</b> |
|        |               |         |      | ±5%  | GRT0335C1E430JA02# | <b>D1</b> |
|        |               |         | 47pF | ±1%  | GRT0335C1E470FA02# | <b>D1</b> |
|        |               |         |      | ±2%  | GRT0335C1E470GA02# | <b>D1</b> |
|        |               |         |      | ±5%  | GRT0335C1E470JA02# | <b>D1</b> |
|        |               |         | 51pF | ±1%  | GRT0335C1E510FA02# | <b>D1</b> |
|        |               |         |      | ±2%  | GRT0335C1E510GA02# | <b>D1</b> |
|        |               |         |      | ±5%  | GRT0335C1E510JA02# | <b>D1</b> |
|        |               |         | 56pF | ±1%  | GRT0335C1E560FA02# | <b>D1</b> |
|        |               |         |      | ±2%  | GRT0335C1E560GA02# | <b>D1</b> |
|        |               |         |      | ±5%  | GRT0335C1E560JA02# | <b>D1</b> |

| T max. | Rated Voltage | TC Code | Cap.  | Tol. | Part Number        |           |
|--------|---------------|---------|-------|------|--------------------|-----------|
| 0.33mm | 25Vdc         | COG     | 62pF  | ±1%  | GRT0335C1E620FA02# | <b>D1</b> |
|        |               |         |       | ±2%  | GRT0335C1E620GA02# | <b>D1</b> |
|        |               |         |       | ±5%  | GRT0335C1E620JA02# | <b>D1</b> |
|        |               |         | 68pF  | ±1%  | GRT0335C1E680FA02# | <b>D1</b> |
|        |               |         |       | ±2%  | GRT0335C1E680GA02# | <b>D1</b> |
|        |               |         |       | ±5%  | GRT0335C1E680JA02# | <b>D1</b> |
|        |               |         | 75pF  | ±1%  | GRT0335C1E750FA02# | <b>D1</b> |
|        |               |         |       | ±2%  | GRT0335C1E750GA02# | <b>D1</b> |
|        |               |         |       | ±5%  | GRT0335C1E750JA02# | <b>D1</b> |
|        |               |         | 82pF  | ±1%  | GRT0335C1E820FA02# | <b>D1</b> |
|        |               |         |       | ±2%  | GRT0335C1E820GA02# | <b>D1</b> |
|        |               |         |       | ±5%  | GRT0335C1E820JA02# | <b>D1</b> |
|        |               |         | 91pF  | ±1%  | GRT0335C1E910FA02# | <b>D1</b> |
|        |               |         |       | ±2%  | GRT0335C1E910GA02# | <b>D1</b> |
|        |               |         |       | ±5%  | GRT0335C1E910JA02# | <b>D1</b> |
|        |               |         | 100pF | ±1%  | GRT0335C1E101FA02# | <b>D1</b> |
|        |               |         |       | ±2%  | GRT0335C1E101GA02# | <b>D1</b> |
|        |               |         |       | ±5%  | GRT0335C1E101JA02# | <b>D1</b> |
|        |               |         | 110pF | ±1%  | GRT0335C1E111FA02# | <b>D1</b> |
|        |               |         |       | ±2%  | GRT0335C1E111GA02# | <b>D1</b> |
|        |               |         |       | ±5%  | GRT0335C1E111JA02# | <b>D1</b> |
|        |               |         | 150pF | ±1%  | GRT0335C1E151FA02# | <b>D1</b> |
|        |               |         |       | ±2%  | GRT0335C1E151GA02# | <b>D1</b> |
|        |               |         |       | ±5%  | GRT0335C1E151JA02# | <b>D1</b> |
|        |               |         | 180pF | ±1%  | GRT0335C1E181FA02# | <b>D1</b> |
|        |               |         |       | ±2%  | GRT0335C1E181GA02# | <b>D1</b> |
|        |               |         |       | ±5%  | GRT0335C1E181JA02# | <b>D1</b> |
|        |               |         | 220pF | ±1%  | GRT0335C1E221FA02# | <b>D1</b> |
|        |               |         |       | ±2%  | GRT0335C1E221GA02# | <b>D1</b> |
|        |               |         |       | ±5%  | GRT0335C1E221JA02# | <b>D1</b> |
|        |               |         | 270pF | ±1%  | GRT0335C1E271FA02# | <b>D1</b> |
|        |               |         |       | ±2%  | GRT0335C1E271GA02# | <b>D1</b> |
|        |               |         |       | ±5%  | GRT0335C1E271JA02# | <b>D1</b> |
|        |               |         | 330pF | ±1%  | GRT0335C1E331FA02# | <b>D1</b> |
|        |               |         |       | ±2%  | GRT0335C1E331GA02# | <b>D1</b> |
|        |               |         |       | ±5%  | GRT0335C1E331JA02# | <b>D1</b> |
|        |               |         | 390pF | ±1%  | GRT0335C1E391FA02# | <b>D1</b> |
|        |               |         |       | ±2%  | GRT0335C1E391GA02# | <b>D1</b> |
|        |               |         |       | ±5%  | GRT0335C1E391JA02# | <b>D1</b> |
|        |               |         | 470pF | ±1%  | GRT0335C1E471FA02# | <b>D1</b> |
|        |               |         |       | ±2%  | GRT0335C1E471GA02# | <b>D1</b> |
|        |               |         |       | ±5%  | GRT0335C1E471JA02# | <b>D1</b> |
|        |               |         | 560pF | ±1%  | GRT0335C1E561FA02# | <b>D1</b> |
|        |               |         |       | ±2%  | GRT0335C1E561GA02# | <b>D1</b> |
|        |               |         |       | ±5%  | GRT0335C1E561JA02# | <b>D1</b> |
|        |               |         | 680pF | ±1%  | GRT0335C1E681FA02# | <b>D1</b> |
|        |               |         |       | ±2%  | GRT0335C1E681GA02# | <b>D1</b> |
|        |               |         |       | ±5%  | GRT0335C1E681JA02# | <b>D1</b> |
|        |               |         | 820pF | ±1%  | GRT0335C1E821FA02# | <b>D1</b> |
|        |               |         |       | ±2%  | GRT0335C1E821GA02# | <b>D1</b> |
|        |               |         |       | ±5%  | GRT0335C1E821JA02# | <b>D1</b> |
|        |               |         | 910pF | ±1%  | GRT0335C1E911FA02# | <b>D1</b> |
|        |               |         |       | ±2%  | GRT0335C1E911GA02# | <b>D1</b> |
|        |               |         |       | ±5%  | GRT0335C1E911JA02# | <b>D1</b> |

Part number # indicates the package specification code.

# GRT Series Temperature Compensating Type Part Number List

(→ 0.6×0.3mm)

| T max. | Rated Voltage | TC Code | Cap.   | Tol. | Part Number        |           |
|--------|---------------|---------|--------|------|--------------------|-----------|
| 0.33mm | 25Vdc         | COG     | 1000pF | ±1%  | GRT0335C1E102FA02# | <b>D1</b> |
|        |               |         |        | ±2%  | GRT0335C1E102GA02# | <b>D1</b> |
|        |               |         |        | ±5%  | GRT0335C1E102JA02# | <b>D1</b> |

1.0×0.5mm

| T max. | Rated Voltage | TC Code | Cap.   | Tol.    | Part Number        |           |        |                    |           |
|--------|---------------|---------|--------|---------|--------------------|-----------|--------|--------------------|-----------|
| 0.55mm | 100Vdc        | COG     | 0.20pF | ±0.1pF  | GRT1555C2AR20BA02# | <b>D1</b> |        |                    |           |
|        |               |         | 0.30pF | ±0.1pF  | GRT1555C2AR30BA02# | <b>D1</b> |        |                    |           |
|        |               |         | 1.0pF  | ±0.25pF | GRT1555C2A1R0CA02# | <b>D1</b> |        |                    |           |
|        |               |         | 1.1pF  | ±0.25pF | GRT1555C2A1R1CA02# | <b>D1</b> |        |                    |           |
|        |               |         | 1.2pF  | ±0.25pF | GRT1555C2A1R2CA02# | <b>D1</b> |        |                    |           |
|        |               |         | 1.3pF  | ±0.25pF | GRT1555C2A1R3CA02# | <b>D1</b> |        |                    |           |
|        |               |         | 1.5pF  | ±0.25pF | GRT1555C2A1R5CA02# | <b>D1</b> |        |                    |           |
|        |               |         | 1.6pF  | ±0.25pF | GRT1555C2A1R6CA02# | <b>D1</b> |        |                    |           |
|        |               |         | 1.8pF  | ±0.25pF | GRT1555C2A1R8CA02# | <b>D1</b> |        |                    |           |
|        |               |         | 2.0pF  | ±0.25pF | GRT1555C2A2R0CA02# | <b>D1</b> |        |                    |           |
|        |               |         | 2.2pF  | ±0.25pF | GRT1555C2A2R2CA02# | <b>D1</b> |        |                    |           |
|        |               |         | 2.4pF  | ±0.25pF | GRT1555C2A2R4CA02# | <b>D1</b> |        |                    |           |
|        |               |         | 2.7pF  | ±0.25pF | GRT1555C2A2R7CA02# | <b>D1</b> |        |                    |           |
|        |               |         | 3.0pF  | ±0.25pF | GRT1555C2A3R0CA02# | <b>D1</b> |        |                    |           |
|        |               |         | 3.3pF  | ±0.25pF | GRT1555C2A3R3CA02# | <b>D1</b> |        |                    |           |
|        |               |         | 3.6pF  | ±0.25pF | GRT1555C2A3R6CA02# | <b>D1</b> |        |                    |           |
|        |               |         | 3.9pF  | ±0.25pF | GRT1555C2A3R9CA02# | <b>D1</b> |        |                    |           |
|        |               |         | 4.0pF  | ±0.25pF | GRT1555C2A4R0CA02# | <b>D1</b> |        |                    |           |
|        |               |         | 4.3pF  | ±0.25pF | GRT1555C2A4R3CA02# | <b>D1</b> |        |                    |           |
|        |               |         | 4.7pF  | ±0.25pF | GRT1555C2A4R7CA02# | <b>D1</b> |        |                    |           |
|        |               |         | 5.0pF  | ±0.25pF | GRT1555C2A5R0CA02# | <b>D1</b> |        |                    |           |
|        |               |         | 5.1pF  | ±0.5pF  | GRT1555C2A5R1DA02# | <b>D1</b> |        |                    |           |
|        |               |         | 5.6pF  | ±0.5pF  | GRT1555C2A5R6DA02# | <b>D1</b> |        |                    |           |
|        |               |         | 6.0pF  | ±0.5pF  | GRT1555C2A6R0DA02# | <b>D1</b> |        |                    |           |
|        |               |         | 6.2pF  | ±0.5pF  | GRT1555C2A6R2DA02# | <b>D1</b> |        |                    |           |
|        |               |         | 6.8pF  | ±0.5pF  | GRT1555C2A6R8DA02# | <b>D1</b> |        |                    |           |
|        |               |         | 7.0pF  | ±0.5pF  | GRT1555C2A7R0DA02# | <b>D1</b> |        |                    |           |
|        |               |         | 7.5pF  | ±0.5pF  | GRT1555C2A7R5DA02# | <b>D1</b> |        |                    |           |
|        |               |         | 8.0pF  | ±0.5pF  | GRT1555C2A8R0DA02# | <b>D1</b> |        |                    |           |
|        |               |         | 8.2pF  | ±0.5pF  | GRT1555C2A8R2DA02# | <b>D1</b> |        |                    |           |
|        |               |         | 9.0pF  | ±0.5pF  | GRT1555C2A9R0DA02# | <b>D1</b> |        |                    |           |
|        |               |         | 9.1pF  | ±0.5pF  | GRT1555C2A9R1DA02# | <b>D1</b> |        |                    |           |
|        |               |         | 10pF   | ±5%     | GRT1555C2A100JA02# | <b>D1</b> |        |                    |           |
|        |               |         | 12pF   | ±5%     | GRT1555C2A120JA02# | <b>D1</b> |        |                    |           |
|        |               |         | 15pF   | ±5%     | GRT1555C2A150JA02# | <b>D1</b> |        |                    |           |
|        |               |         | 18pF   | ±5%     | GRT1555C2A180JA02# | <b>D1</b> |        |                    |           |
|        |               |         | 22pF   | ±5%     | GRT1555C2A220JA02# | <b>D1</b> |        |                    |           |
|        |               |         | 27pF   | ±5%     | GRT1555C2A270JA02# | <b>D1</b> |        |                    |           |
|        |               |         | 33pF   | ±5%     | GRT1555C2A330JA02# | <b>D1</b> |        |                    |           |
|        |               |         | 39pF   | ±5%     | GRT1555C2A390JA02# | <b>D1</b> |        |                    |           |
|        |               |         | 47pF   | ±5%     | GRT1555C2A470JA02# | <b>D1</b> |        |                    |           |
|        |               |         | 56pF   | ±5%     | GRT1555C2A560JA02# | <b>D1</b> |        |                    |           |
|        |               |         | 68pF   | ±5%     | GRT1555C2A680JA02# | <b>D1</b> |        |                    |           |
|        |               |         | 82pF   | ±5%     | GRT1555C2A820JA02# | <b>D1</b> |        |                    |           |
|        |               |         | 100pF  | ±5%     | GRT1555C2A101JA02# | <b>D1</b> |        |                    |           |
|        |               |         |        | 50Vdc   | COG                | 0.11pF    | ±0.1pF | GRT1555C1HR11BA02# | <b>D1</b> |

| T max. | Rated Voltage | TC Code            | Cap.               | Tol.      | Part Number        |           |
|--------|---------------|--------------------|--------------------|-----------|--------------------|-----------|
| 0.55mm | 50Vdc         | COG                | 0.12pF             | ±0.1pF    | GRT1555C1HR12BA02# | <b>D1</b> |
|        |               |                    | 0.13pF             | ±0.1pF    | GRT1555C1HR13BA02# | <b>D1</b> |
|        |               |                    | 0.15pF             | ±0.1pF    | GRT1555C1HR15BA02# | <b>D1</b> |
|        |               |                    | 0.16pF             | ±0.1pF    | GRT1555C1HR16BA02# | <b>D1</b> |
|        |               |                    | 0.18pF             | ±0.1pF    | GRT1555C1HR18BA02# | <b>D1</b> |
|        |               |                    | 0.20pF             | ±0.1pF    | GRT1555C1HR20BA02# | <b>D1</b> |
|        |               |                    | 0.22pF             | ±0.1pF    | GRT1555C1HR22BA02# | <b>D1</b> |
|        |               |                    | 0.24pF             | ±0.1pF    | GRT1555C1HR24BA02# | <b>D1</b> |
|        |               |                    | 0.27pF             | ±0.1pF    | GRT1555C1HR27BA02# | <b>D1</b> |
|        |               |                    | 0.30pF             | ±0.1pF    | GRT1555C1HR30BA02# | <b>D1</b> |
|        |               |                    | 0.33pF             | ±0.1pF    | GRT1555C1HR33BA02# | <b>D1</b> |
|        |               |                    | 0.36pF             | ±0.1pF    | GRT1555C1HR36BA02# | <b>D1</b> |
|        |               |                    | 0.39pF             | ±0.1pF    | GRT1555C1HR39BA02# | <b>D1</b> |
|        |               |                    | 0.43pF             | ±0.1pF    | GRT1555C1HR43BA02# | <b>D1</b> |
|        |               |                    | 0.47pF             | ±0.1pF    | GRT1555C1HR47BA02# | <b>D1</b> |
|        |               |                    | 0.51pF             | ±0.1pF    | GRT1555C1HR51BA02# | <b>D1</b> |
|        |               |                    | 0.56pF             | ±0.1pF    | GRT1555C1HR56BA02# | <b>D1</b> |
|        |               |                    | 0.62pF             | ±0.1pF    | GRT1555C1HR62BA02# | <b>D1</b> |
|        |               |                    | 0.68pF             | ±0.1pF    | GRT1555C1HR68BA02# | <b>D1</b> |
|        |               |                    | 0.75pF             | ±0.1pF    | GRT1555C1HR75BA02# | <b>D1</b> |
|        |               |                    | 0.82pF             | ±0.1pF    | GRT1555C1HR82BA02# | <b>D1</b> |
|        |               |                    | 0.91pF             | ±0.1pF    | GRT1555C1HR91BA02# | <b>D1</b> |
|        |               |                    | 1.0pF              | ±0.25pF   | GRT1555C1H1R0CA02# | <b>D1</b> |
|        |               |                    | 1.1pF              | ±0.25pF   | GRT1555C1H1R1CA02# | <b>D1</b> |
|        |               |                    | 1.2pF              | ±0.25pF   | GRT1555C1H1R2CA02# | <b>D1</b> |
|        |               |                    | 1.3pF              | ±0.25pF   | GRT1555C1H1R3CA02# | <b>D1</b> |
|        |               |                    | 1.5pF              | ±0.25pF   | GRT1555C1H1R5CA02# | <b>D1</b> |
|        |               |                    | 1.6pF              | ±0.25pF   | GRT1555C1H1R6CA02# | <b>D1</b> |
|        |               |                    | 1.8pF              | ±0.25pF   | GRT1555C1H1R8CA02# | <b>D1</b> |
|        |               |                    | 2.0pF              | ±0.25pF   | GRT1555C1H2R0CA02# | <b>D1</b> |
|        |               |                    | 2.2pF              | ±0.25pF   | GRT1555C1H2R2CA02# | <b>D1</b> |
|        |               |                    | 2.4pF              | ±0.25pF   | GRT1555C1H2R4CA02# | <b>D1</b> |
|        |               |                    | 2.7pF              | ±0.25pF   | GRT1555C1H2R7CA02# | <b>D1</b> |
|        |               |                    | 3.0pF              | ±0.25pF   | GRT1555C1H3R0CA02# | <b>D1</b> |
|        |               |                    | 3.3pF              | ±0.25pF   | GRT1555C1H3R3CA02# | <b>D1</b> |
|        |               |                    | 3.6pF              | ±0.25pF   | GRT1555C1H3R6CA02# | <b>D1</b> |
|        |               |                    | 3.9pF              | ±0.25pF   | GRT1555C1H3R9CA02# | <b>D1</b> |
|        |               |                    | 4.0pF              | ±0.25pF   | GRT1555C1H4R0CA02# | <b>D1</b> |
|        |               |                    | 4.3pF              | ±0.25pF   | GRT1555C1H4R3CA02# | <b>D1</b> |
|        |               |                    | 4.7pF              | ±0.25pF   | GRT1555C1H4R7CA02# | <b>D1</b> |
| 5.0pF  | ±0.25pF       | GRT1555C1H5R0CA02# | <b>D1</b>          |           |                    |           |
| 5.1pF  | ±0.5pF        | GRT1555C1H5R1DA02# | <b>D1</b>          |           |                    |           |
| 5.6pF  | ±0.5pF        | GRT1555C1H5R6DA02# | <b>D1</b>          |           |                    |           |
| 6.0pF  | ±0.5pF        | GRT1555C1H6R0DA02# | <b>D1</b>          |           |                    |           |
| 6.2pF  | ±0.5pF        | GRT1555C1H6R2DA02# | <b>D1</b>          |           |                    |           |
| 6.8pF  | ±0.5pF        | GRT1555C1H6R8DA02# | <b>D1</b>          |           |                    |           |
| 7.0pF  | ±0.5pF        | GRT1555C1H7R0DA02# | <b>D1</b>          |           |                    |           |
| 7.5pF  | ±0.5pF        | GRT1555C1H7R5DA02# | <b>D1</b>          |           |                    |           |
| 8.0pF  | ±0.5pF        | GRT1555C1H8R0DA02# | <b>D1</b>          |           |                    |           |
| 8.2pF  | ±0.5pF        | GRT1555C1H8R2DA02# | <b>D1</b>          |           |                    |           |
| 9.0pF  | ±0.5pF        | GRT1555C1H9R0DA02# | <b>D1</b>          |           |                    |           |
| 9.1pF  | ±0.5pF        | GRT1555C1H9R1DA02# | <b>D1</b>          |           |                    |           |
| 10pF   | ±1%           | GRT1555C1H100FA02# | <b>D1</b>          |           |                    |           |
|        |               | ±2%                | GRT1555C1H100GA02# | <b>D1</b> |                    |           |

Part number # indicates the package specification code.

GRT Series  
 GCM Series  
 GC3 Series  
 GCJ Series  
 GCQ Series  
 GCD Series  
 GCE Series  
 NMF Series  
 KCM Series  
 KC3 Series  
 KCA Series  
 GCB Series  
 GCG Series  
 △Caution / Notice

# GRT Series Temperature Compensating Type Part Number List

(→ 1.0×0.5mm)

| T max. | Rated Voltage | TC Code | Cap. | Tol. | Part Number        |                    |
|--------|---------------|---------|------|------|--------------------|--------------------|
| 0.55mm | 50Vdc         | COG     | 10pF | ±5%  | GRT1555C1H100JA02# | <b>D1</b>          |
|        |               |         |      | ±1%  | GRT1555C1H110FA02# | <b>D1</b>          |
|        |               |         |      |      | ±2%                | GRT1555C1H110GA02# |
|        |               |         | ±5%  |      | GRT1555C1H110JA02# | <b>D1</b>          |
|        |               |         | 12pF | ±1%  | GRT1555C1H120FA02# | <b>D1</b>          |
|        |               |         |      | ±2%  | GRT1555C1H120GA02# | <b>D1</b>          |
|        |               |         |      | ±5%  | GRT1555C1H120JA02# | <b>D1</b>          |
|        |               |         | 13pF | ±1%  | GRT1555C1H130FA02# | <b>D1</b>          |
|        |               |         |      | ±2%  | GRT1555C1H130GA02# | <b>D1</b>          |
|        |               |         |      | ±5%  | GRT1555C1H130JA02# | <b>D1</b>          |
|        |               |         | 15pF | ±1%  | GRT1555C1H150FA02# | <b>D1</b>          |
|        |               |         |      | ±2%  | GRT1555C1H150GA02# | <b>D1</b>          |
|        |               |         |      | ±5%  | GRT1555C1H150JA02# | <b>D1</b>          |
|        |               |         | 16pF | ±1%  | GRT1555C1H160FA02# | <b>D1</b>          |
|        |               |         |      | ±2%  | GRT1555C1H160GA02# | <b>D1</b>          |
|        |               |         |      | ±5%  | GRT1555C1H160JA02# | <b>D1</b>          |
|        |               |         | 18pF | ±1%  | GRT1555C1H180FA02# | <b>D1</b>          |
|        |               |         |      | ±2%  | GRT1555C1H180GA02# | <b>D1</b>          |
|        |               |         |      | ±5%  | GRT1555C1H180JA02# | <b>D1</b>          |
|        |               |         | 20pF | ±1%  | GRT1555C1H200FA02# | <b>D1</b>          |
|        |               |         |      | ±2%  | GRT1555C1H200GA02# | <b>D1</b>          |
|        |               |         |      | ±5%  | GRT1555C1H200JA02# | <b>D1</b>          |
|        |               |         | 22pF | ±1%  | GRT1555C1H220FA02# | <b>D1</b>          |
|        |               |         |      | ±2%  | GRT1555C1H220GA02# | <b>D1</b>          |
|        |               |         |      | ±5%  | GRT1555C1H220JA02# | <b>D1</b>          |
|        |               |         | 24pF | ±1%  | GRT1555C1H240FA02# | <b>D1</b>          |
|        |               |         |      | ±2%  | GRT1555C1H240GA02# | <b>D1</b>          |
|        |               |         |      | ±5%  | GRT1555C1H240JA02# | <b>D1</b>          |
|        |               |         | 27pF | ±1%  | GRT1555C1H270FA02# | <b>D1</b>          |
|        |               |         |      | ±2%  | GRT1555C1H270GA02# | <b>D1</b>          |
|        |               |         |      | ±5%  | GRT1555C1H270JA02# | <b>D1</b>          |
|        |               |         | 30pF | ±1%  | GRT1555C1H300FA02# | <b>D1</b>          |
|        |               |         |      | ±2%  | GRT1555C1H300GA02# | <b>D1</b>          |
|        |               |         |      | ±5%  | GRT1555C1H300JA02# | <b>D1</b>          |
|        |               |         | 33pF | ±1%  | GRT1555C1H330FA02# | <b>D1</b>          |
|        |               |         |      | ±2%  | GRT1555C1H330GA02# | <b>D1</b>          |
|        |               |         |      | ±5%  | GRT1555C1H330JA02# | <b>D1</b>          |
|        |               |         | 36pF | ±1%  | GRT1555C1H360FA02# | <b>D1</b>          |
|        |               |         |      | ±2%  | GRT1555C1H360GA02# | <b>D1</b>          |
|        |               |         |      | ±5%  | GRT1555C1H360JA02# | <b>D1</b>          |
|        |               |         | 39pF | ±1%  | GRT1555C1H390FA02# | <b>D1</b>          |
|        |               |         |      | ±2%  | GRT1555C1H390GA02# | <b>D1</b>          |
|        |               |         |      | ±5%  | GRT1555C1H390JA02# | <b>D1</b>          |
|        |               |         | 43pF | ±1%  | GRT1555C1H430FA02# | <b>D1</b>          |
|        |               |         |      | ±2%  | GRT1555C1H430GA02# | <b>D1</b>          |
|        |               |         |      | ±5%  | GRT1555C1H430JA02# | <b>D1</b>          |
|        |               |         | 47pF | ±1%  | GRT1555C1H470FA02# | <b>D1</b>          |
|        |               |         |      | ±2%  | GRT1555C1H470GA02# | <b>D1</b>          |
|        |               |         |      | ±5%  | GRT1555C1H470JA02# | <b>D1</b>          |
|        |               |         | 51pF | ±1%  | GRT1555C1H510FA02# | <b>D1</b>          |
|        |               |         |      | ±2%  | GRT1555C1H510GA02# | <b>D1</b>          |
|        |               |         |      | ±5%  | GRT1555C1H510JA02# | <b>D1</b>          |
|        |               |         | 56pF | ±1%  | GRT1555C1H560FA02# | <b>D1</b>          |
|        |               |         |      | ±2%  | GRT1555C1H560GA02# | <b>D1</b>          |

| T max. | Rated Voltage | TC Code | Cap.  | Tol. | Part Number        |                    |
|--------|---------------|---------|-------|------|--------------------|--------------------|
| 0.55mm | 50Vdc         | COG     | 56pF  | ±5%  | GRT1555C1H560JA02# | <b>D1</b>          |
|        |               |         |       | ±1%  | GRT1555C1H620FA02# | <b>D1</b>          |
|        |               |         |       |      | ±2%                | GRT1555C1H620GA02# |
|        |               |         | ±5%   |      | GRT1555C1H620JA02# | <b>D1</b>          |
|        |               |         | 68pF  | ±1%  | GRT1555C1H680FA02# | <b>D1</b>          |
|        |               |         |       | ±2%  | GRT1555C1H680GA02# | <b>D1</b>          |
|        |               |         |       | ±5%  | GRT1555C1H680JA02# | <b>D1</b>          |
|        |               |         | 75pF  | ±1%  | GRT1555C1H750FA02# | <b>D1</b>          |
|        |               |         |       | ±2%  | GRT1555C1H750GA02# | <b>D1</b>          |
|        |               |         |       | ±5%  | GRT1555C1H750JA02# | <b>D1</b>          |
|        |               |         | 82pF  | ±1%  | GRT1555C1H820FA02# | <b>D1</b>          |
|        |               |         |       | ±2%  | GRT1555C1H820GA02# | <b>D1</b>          |
|        |               |         |       | ±5%  | GRT1555C1H820JA02# | <b>D1</b>          |
|        |               |         | 91pF  | ±1%  | GRT1555C1H910FA02# | <b>D1</b>          |
|        |               |         |       | ±2%  | GRT1555C1H910GA02# | <b>D1</b>          |
|        |               |         |       | ±5%  | GRT1555C1H910JA02# | <b>D1</b>          |
|        |               |         | 100pF | ±1%  | GRT1555C1H101FA02# | <b>D1</b>          |
|        |               |         |       | ±2%  | GRT1555C1H101GA02# | <b>D1</b>          |
|        |               |         |       | ±5%  | GRT1555C1H101JA02# | <b>D1</b>          |
|        |               |         | 110pF | ±1%  | GRT1555C1H111FA02# | <b>D1</b>          |
|        |               |         |       | ±2%  | GRT1555C1H111GA02# | <b>D1</b>          |
|        |               |         |       | ±5%  | GRT1555C1H111JA02# | <b>D1</b>          |
|        |               |         | 120pF | ±1%  | GRT1555C1H121FA02# | <b>D1</b>          |
|        |               |         |       | ±2%  | GRT1555C1H121GA02# | <b>D1</b>          |
|        |               |         |       | ±5%  | GRT1555C1H121JA02# | <b>D1</b>          |
|        |               |         | 130pF | ±1%  | GRT1555C1H131FA02# | <b>D1</b>          |
|        |               |         |       | ±2%  | GRT1555C1H131GA02# | <b>D1</b>          |
|        |               |         |       | ±5%  | GRT1555C1H131JA02# | <b>D1</b>          |
|        |               |         | 150pF | ±1%  | GRT1555C1H151FA02# | <b>D1</b>          |
|        |               |         |       | ±2%  | GRT1555C1H151GA02# | <b>D1</b>          |
|        |               |         |       | ±5%  | GRT1555C1H151JA02# | <b>D1</b>          |
|        |               |         | 160pF | ±1%  | GRT1555C1H161FA02# | <b>D1</b>          |
|        |               |         |       | ±2%  | GRT1555C1H161GA02# | <b>D1</b>          |
|        |               |         |       | ±5%  | GRT1555C1H161JA02# | <b>D1</b>          |
|        |               |         | 180pF | ±1%  | GRT1555C1H181FA02# | <b>D1</b>          |
|        |               |         |       | ±2%  | GRT1555C1H181GA02# | <b>D1</b>          |
|        |               |         |       | ±5%  | GRT1555C1H181JA02# | <b>D1</b>          |
|        |               |         | 200pF | ±1%  | GRT1555C1H201FA02# | <b>D1</b>          |
|        |               |         |       | ±2%  | GRT1555C1H201GA02# | <b>D1</b>          |
|        |               |         |       | ±5%  | GRT1555C1H201JA02# | <b>D1</b>          |
|        |               |         | 220pF | ±1%  | GRT1555C1H221FA02# | <b>D1</b>          |
|        |               |         |       | ±2%  | GRT1555C1H221GA02# | <b>D1</b>          |
|        |               |         |       | ±5%  | GRT1555C1H221JA02# | <b>D1</b>          |
|        |               |         | 240pF | ±1%  | GRT1555C1H241FA02# | <b>D1</b>          |
|        |               |         |       | ±2%  | GRT1555C1H241GA02# | <b>D1</b>          |
|        |               |         |       | ±5%  | GRT1555C1H241JA02# | <b>D1</b>          |
|        |               |         | 270pF | ±1%  | GRT1555C1H271FA02# | <b>D1</b>          |
|        |               |         |       | ±2%  | GRT1555C1H271GA02# | <b>D1</b>          |
|        |               |         |       | ±5%  | GRT1555C1H271JA02# | <b>D1</b>          |
|        |               |         | 300pF | ±1%  | GRT1555C1H301FA02# | <b>D1</b>          |
|        |               |         |       | ±2%  | GRT1555C1H301GA02# | <b>D1</b>          |
|        |               |         |       | ±5%  | GRT1555C1H301JA02# | <b>D1</b>          |
|        |               |         | 330pF | ±1%  | GRT1555C1H331FA02# | <b>D1</b>          |
|        |               |         |       | ±2%  | GRT1555C1H331GA02# | <b>D1</b>          |

GRT Series  
 GCM Series  
 GC3 Series  
 GCJ Series  
 GCQ Series  
 GCD Series  
 GCE Series  
 NMF Series  
 KCM Series  
 KC3 Series  
 KCA Series  
 GCB Series  
 GCG Series  
 △Caution /Notice

Part number # indicates the package specification code.

# GRT Series Temperature Compensating Type Part Number List

(→ 1.0×0.5mm)

| T max. | Rated Voltage | TC Code            | Cap.      | Tol. | Part Number        |                    |                    |           |
|--------|---------------|--------------------|-----------|------|--------------------|--------------------|--------------------|-----------|
| 0.55mm | 50Vdc         | COG                | 330pF     | ±5%  | GRT1555C1H331JA02# | <b>D1</b>          |                    |           |
|        |               |                    |           | ±1%  | GRT1555C1H361FA02# | <b>D1</b>          |                    |           |
|        |               |                    |           |      | ±2%                | GRT1555C1H361GA02# | <b>D1</b>          |           |
|        |               |                    |           |      | ±5%                | GRT1555C1H361JA02# | <b>D1</b>          |           |
|        |               |                    | 390pF     | ±1%  | GRT1555C1H391FA02# | <b>D1</b>          |                    |           |
|        |               |                    |           | ±2%  | GRT1555C1H391GA02# | <b>D1</b>          |                    |           |
|        |               |                    |           | ±5%  | GRT1555C1H391JA02# | <b>D1</b>          |                    |           |
|        |               |                    | 430pF     | ±1%  | GRT1555C1H431FA02# | <b>D1</b>          |                    |           |
|        |               |                    |           | ±2%  | GRT1555C1H431GA02# | <b>D1</b>          |                    |           |
|        |               |                    |           | ±5%  | GRT1555C1H431JA02# | <b>D1</b>          |                    |           |
|        |               |                    | 470pF     | ±1%  | GRT1555C1H471FA02# | <b>D1</b>          |                    |           |
|        |               |                    |           | ±2%  | GRT1555C1H471GA02# | <b>D1</b>          |                    |           |
|        |               |                    |           | ±5%  | GRT1555C1H471JA02# | <b>D1</b>          |                    |           |
|        |               |                    | 510pF     | ±1%  | GRT1555C1H511FA02# | <b>D1</b>          |                    |           |
|        |               |                    |           | ±2%  | GRT1555C1H511GA02# | <b>D1</b>          |                    |           |
|        |               |                    |           | ±5%  | GRT1555C1H511JA02# | <b>D1</b>          |                    |           |
|        |               |                    | 560pF     | ±1%  | GRT1555C1H561FA02# | <b>D1</b>          |                    |           |
|        |               |                    |           | ±2%  | GRT1555C1H561GA02# | <b>D1</b>          |                    |           |
|        |               |                    |           | ±5%  | GRT1555C1H561JA02# | <b>D1</b>          |                    |           |
|        |               |                    | 620pF     | ±1%  | GRT1555C1H621FA02# | <b>D1</b>          |                    |           |
|        |               |                    |           | ±2%  | GRT1555C1H621GA02# | <b>D1</b>          |                    |           |
|        |               |                    |           | ±5%  | GRT1555C1H621JA02# | <b>D1</b>          |                    |           |
|        |               |                    | 680pF     | ±1%  | GRT1555C1H681FA02# | <b>D1</b>          |                    |           |
|        |               |                    |           | ±2%  | GRT1555C1H681GA02# | <b>D1</b>          |                    |           |
|        |               |                    |           | ±5%  | GRT1555C1H681JA02# | <b>D1</b>          |                    |           |
|        |               |                    | 750pF     | ±1%  | GRT1555C1H751FA02# | <b>D1</b>          |                    |           |
|        |               |                    |           | ±2%  | GRT1555C1H751GA02# | <b>D1</b>          |                    |           |
|        |               |                    |           | ±5%  | GRT1555C1H751JA02# | <b>D1</b>          |                    |           |
|        |               |                    | 820pF     | ±1%  | GRT1555C1H821FA02# | <b>D1</b>          |                    |           |
|        |               |                    |           | ±2%  | GRT1555C1H821GA02# | <b>D1</b>          |                    |           |
|        |               |                    |           | ±5%  | GRT1555C1H821JA02# | <b>D1</b>          |                    |           |
|        |               |                    | 910pF     | ±1%  | GRT1555C1H911FA02# | <b>D1</b>          |                    |           |
|        |               |                    |           | ±2%  | GRT1555C1H911GA02# | <b>D1</b>          |                    |           |
|        |               |                    |           | ±5%  | GRT1555C1H911JA02# | <b>D1</b>          |                    |           |
|        |               |                    | 1000pF    | ±1%  | GRT1555C1H102FA02# | <b>D1</b>          |                    |           |
|        |               |                    |           | ±2%  | GRT1555C1H102GA02# | <b>D1</b>          |                    |           |
|        |               |                    |           | ±5%  | GRT1555C1H102JA02# | <b>D1</b>          |                    |           |
|        |               |                    | 25Vdc     | COG  | 10pF               | ±5%                | GRT1555C1E100JA02# | <b>D1</b> |
|        |               |                    |           |      | 12pF               | ±5%                | GRT1555C1E120JA02# | <b>D1</b> |
|        |               |                    |           |      | 15pF               | ±5%                | GRT1555C1E150JA02# | <b>D1</b> |
|        |               |                    |           |      | 18pF               | ±5%                | GRT1555C1E180JA02# | <b>D1</b> |
|        |               |                    |           |      | 22pF               | ±5%                | GRT1555C1E220JA02# | <b>D1</b> |
|        |               |                    |           |      | 27pF               | ±5%                | GRT1555C1E270JA02# | <b>D1</b> |
|        |               |                    |           |      | 33pF               | ±5%                | GRT1555C1E330JA02# | <b>D1</b> |
|        |               |                    |           |      | 39pF               | ±5%                | GRT1555C1E390JA02# | <b>D1</b> |
|        |               |                    |           |      | 47pF               | ±5%                | GRT1555C1E470JA02# | <b>D1</b> |
|        |               |                    |           |      | 56pF               | ±5%                | GRT1555C1E560JA02# | <b>D1</b> |
|        |               |                    |           |      | 68pF               | ±5%                | GRT1555C1E680JA02# | <b>D1</b> |
| 82pF   | ±5%           | GRT1555C1E820JA02# |           |      | <b>D1</b>          |                    |                    |           |
| 100pF  | ±5%           | GRT1555C1E101JA02# |           |      | <b>D1</b>          |                    |                    |           |
| 120pF  | ±5%           | GRT1555C1E121JA02# |           |      | <b>D1</b>          |                    |                    |           |
| 150pF  | ±5%           | GRT1555C1E151JA02# | <b>D1</b> |      |                    |                    |                    |           |
| 180pF  | ±5%           | GRT1555C1E181JA02# | <b>D1</b> |      |                    |                    |                    |           |
| 220pF  | ±1%           | GRT1555C1E221FA02# | <b>D1</b> |      |                    |                    |                    |           |

| T max. | Rated Voltage | TC Code | Cap.   | Tol.               | Part Number        |                    |
|--------|---------------|---------|--------|--------------------|--------------------|--------------------|
| 0.55mm | 25Vdc         | COG     | 220pF  | ±5%                | GRT1555C1E221JA02# | <b>D1</b>          |
|        |               |         |        | ±1%                | GRT1555C1E271FA02# | <b>D1</b>          |
|        |               |         | ±5%    | GRT1555C1E271JA02# | <b>D1</b>          |                    |
|        |               |         |        | 330pF              | ±5%                | GRT1555C1E331JA02# |
|        |               |         | 390pF  | ±5%                | GRT1555C1E391JA02# | <b>D1</b>          |
|        |               |         | 470pF  | ±5%                | GRT1555C1E471JA02# | <b>D1</b>          |
|        |               |         | 560pF  | ±5%                | GRT1555C1E561JA02# | <b>D1</b>          |
|        |               |         | 680pF  | ±5%                | GRT1555C1E681JA02# | <b>D1</b>          |
|        |               |         | 820pF  | ±5%                | GRT1555C1E821JA02# | <b>D1</b>          |
|        |               |         | 1000pF | ±5%                | GRT1555C1E102JA02# | <b>D1</b>          |

1.6×0.8mm

| T max. | Rated Voltage | TC Code | Cap.               | Tol.               | Part Number        |                    |                    |                    |
|--------|---------------|---------|--------------------|--------------------|--------------------|--------------------|--------------------|--------------------|
| 0.9mm  | 100Vdc        | COG     | 120pF              | ±5%                | GRT1885C2A121JA02# | <b>D1</b>          |                    |                    |
|        |               |         |                    | ±5%                | GRT1885C2A151JA02# | <b>D1</b>          |                    |                    |
|        |               |         | 180pF              | ±5%                | GRT1885C2A181JA02# | <b>D1</b>          |                    |                    |
|        |               |         |                    | ±5%                | GRT1885C2A221JA02# | <b>D1</b>          |                    |                    |
|        |               |         | 270pF              | ±5%                | GRT1885C2A271JA02# | <b>D1</b>          |                    |                    |
|        |               |         |                    | ±5%                | GRT1885C2A331JA02# | <b>D1</b>          |                    |                    |
|        |               |         | 390pF              | ±5%                | GRT1885C2A391JA02# | <b>D1</b>          |                    |                    |
|        |               |         |                    | ±5%                | GRT1885C2A471JA02# | <b>D1</b>          |                    |                    |
|        |               |         | 560pF              | ±5%                | GRT1885C2A561JA02# | <b>D1</b>          |                    |                    |
|        |               |         |                    | ±5%                | GRT1885C2A681JA02# | <b>D1</b>          |                    |                    |
|        |               |         | 820pF              | ±5%                | GRT1885C2A821JA02# | <b>D1</b>          |                    |                    |
|        |               |         |                    | ±5%                | GRT1885C2A102JA02# | <b>D1</b>          |                    |                    |
|        |               |         | 1200pF             | ±5%                | GRT1885C2A122JA02# | <b>D1</b>          |                    |                    |
|        |               |         |                    | ±5%                | GRT1885C2A152JA02# | <b>D1</b>          |                    |                    |
|        |               |         | 50Vdc              | COG                | 1200pF             | ±5%                | GRT1885C1H122JA02# | <b>D1</b>          |
|        |               |         |                    |                    |                    | ±2%                | GRT1885C1H152GA02# | <b>D1</b>          |
|        |               |         |                    |                    | ±5%                | GRT1885C1H152JA02# | <b>D1</b>          |                    |
|        |               |         |                    |                    |                    | 1800pF             | ±5%                | GRT1885C1H182JA02# |
|        |               |         |                    |                    | 2200pF             | ±2%                | GRT1885C1H222GA02# | <b>D1</b>          |
|        |               |         |                    |                    | ±5%                | GRT1885C1H222JA02# | <b>D1</b>          |                    |
|        |               |         |                    |                    |                    | 2700pF             | ±5%                | GRT1885C1H272JA02# |
|        |               |         |                    |                    | 3300pF             | ±5%                | GRT1885C1H332JA02# | <b>D1</b>          |
|        |               |         |                    |                    | 3900pF             | ±5%                | GRT1885C1H392JA02# | <b>D1</b>          |
|        |               |         |                    |                    | 4300pF             | ±5%                | GRT1885C1H432JA02# | <b>D1</b>          |
|        | 4700pF        | ±5%     |                    |                    | GRT1885C1H472JA02# | <b>D1</b>          |                    |                    |
|        | 5100pF        | ±5%     |                    |                    | GRT1885C1H512JA02# | <b>D1</b>          |                    |                    |
|        | 5600pF        | ±5%     |                    |                    | GRT1885C1H562JA02# | <b>D1</b>          |                    |                    |
|        | 6800pF        | ±5%     |                    |                    | GRT1885C1H682JA02# | <b>D1</b>          |                    |                    |
|        | 8200pF        | ±5%     | GRT1885C1H822JA02# | <b>D1</b>          |                    |                    |                    |                    |
|        | 10000pF       | ±5%     | GRT1885C1H103JA02# | <b>D1</b>          |                    |                    |                    |                    |
|        | 25Vdc         | COG     | 1200pF             | ±5%                | GRT1885C1E122JA02# | <b>D1</b>          |                    |                    |
|        |               |         |                    | ±5%                | GRT1885C1E152JA02# | <b>D1</b>          |                    |                    |
|        |               |         | 4700pF             | ±5%                | GRT1885C1E472JA02# | <b>D1</b>          |                    |                    |
|        |               |         |                    | ±5%                | GRT1885C1E562JA02# | <b>D1</b>          |                    |                    |
|        |               |         | 6800pF             | ±5%                | GRT1885C1E682JA02# | <b>D1</b>          |                    |                    |
|        |               |         |                    | ±5%                | GRT1885C1E822JA02# | <b>D1</b>          |                    |                    |
|        |               |         | 8200pF             | ±5%                | GRT1885C1E822JA02# | <b>D1</b>          |                    |                    |
|        |               |         |                    | ±1%                | GRT1885C1E103FA02# | <b>D1</b>          |                    |                    |
|        |               |         | ±5%                | GRT1885C1E103JA02# | <b>D1</b>          |                    |                    |                    |

Part number # indicates the package specification code.

GRT Series  
 GCM Series  
 GC3 Series  
 GCJ Series  
 GCQ Series  
 GCD Series  
 GCE Series  
 NMF Series  
 KCM Series  
 KC3 Series  
 KCA Series  
 GCB Series  
 GCG Series  
 ⚠Caution /Notice

# GRT Series Temperature Compensating Type Part Number List

## 2.0×1.25mm

| T max. | Rated Voltage | TC Code | Cap.    | Tol. | Part Number        |           |
|--------|---------------|---------|---------|------|--------------------|-----------|
| 0.6mm  | 25Vdc         | COG     | 1800pF  | ±5%  | GRT2165C1E182JA12# | <b>D1</b> |
|        |               |         | 2200pF  | ±5%  | GRT2165C1E222JA12# | <b>D1</b> |
| 0.7mm  | 100Vdc        | COG     | 1800pF  | ±5%  | GRT2165C2A182JA02# | <b>D1</b> |
|        |               |         | 2200pF  | ±5%  | GRT2165C2A222JA02# | <b>D1</b> |
|        |               |         | 2700pF  | ±5%  | GRT2165C2A272JA02# | <b>D1</b> |
|        |               |         | 3300pF  | ±5%  | GRT2165C2A332JA02# | <b>D1</b> |
| 1.35mm | 50Vdc         | COG     | 18000pF | ±5%  | GRT21B5C1H183JA02# | <b>D1</b> |
|        |               |         | 22000pF | ±5%  | GRT21B5C1H223JA02# | <b>D1</b> |

## 3.2×1.6mm

| T max. | Rated Voltage | TC Code            | Cap.    | Tol.               | Part Number        |           |
|--------|---------------|--------------------|---------|--------------------|--------------------|-----------|
| 0.95mm | 100Vdc        | COG                | 3900pF  | ±5%                | GRT3195C2A392JA02# | <b>D1</b> |
|        |               |                    | 4700pF  | ±5%                | GRT3195C2A472JA02# | <b>D1</b> |
|        |               |                    | 5600pF  | ±5%                | GRT3195C2A562JA02# | <b>D1</b> |
|        |               |                    | 6800pF  | ±5%                | GRT3195C2A682JA02# | <b>D1</b> |
|        |               |                    | 8200pF  | ±5%                | GRT3195C2A822JA02# | <b>D1</b> |
|        |               |                    | 10000pF | ±5%                | GRT3195C2A103JA02# | <b>D1</b> |
|        |               |                    | 18000pF | ±5%                | GRT3195C2A183JA02# | <b>D1</b> |
|        |               |                    | 22000pF | ±5%                | GRT3195C2A223JA02# | <b>D1</b> |
| 1.8mm  | 100Vdc        | COG                | 0.10μF  | ±5%                | GRT31C5C2A104JA12# | <b>D1</b> |
|        | 50Vdc         | COG                | 56000pF | ±5%                | GRT31C5C1H563JA02# | <b>D1</b> |
|        |               |                    | 68000pF | ±1%                | GRT31C5C1H683FA02# | <b>D1</b> |
|        |               |                    |         | ±5%                | GRT31C5C1H683JA02# | <b>D1</b> |
|        |               |                    | 82000pF | ±5%                | GRT31C5C1H823JA02# | <b>D1</b> |
|        |               |                    | 0.10μF  | ±1%                | GRT31C5C1H104FA02# | <b>D1</b> |
|        | ±5%           | GRT31C5C1H104JA02# |         | <b>D1</b>          |                    |           |
|        | 25Vdc         | COG                | 0.10μF  | ±1%                | GRT31C5C1E104FA02# | <b>D1</b> |
|        |               |                    |         | ±5%                | GRT31C5C1E104JA02# | <b>D1</b> |
|        |               |                    | 0.12μF  | ±5%                | GRT31C5C1E124JA02# | <b>D1</b> |
| 16Vdc  | COG           | 0.12μF             | ±5%     | GRT31C5C1C124JA02# | <b>D1</b>          |           |

GRT Series  
 GCM Series  
 GC3 Series  
 GCJ Series  
 GCQ Series  
 GCD Series  
 GCE Series  
 NMF Series  
 KCM Series  
 KC3 Series  
 KCA Series  
 GCB Series  
 GCG Series  
 ⚠Caution /Notice

# GRT Series High Dielectric Constant Type Part Number List

## 0.6×0.3mm

| T max. | Rated Voltage | TC Code | Cap.               | Tol.               | Part Number        |                    |                    |           |
|--------|---------------|---------|--------------------|--------------------|--------------------|--------------------|--------------------|-----------|
| 0.33mm | 35Vdc         | X5R     | 0.10μF             | ±10%               | GRT033R6YA104KE01# | <b>D1</b>          |                    |           |
|        |               |         | 25Vdc              | X7R                | 150pF              | ±10%               | GRT033R71E151KE01# | <b>D1</b> |
|        |               |         |                    |                    | 470pF              | ±10%               | GRT033R71E471KE01# | <b>D1</b> |
|        | 1000pF        | ±10%    |                    |                    | GRT033R71E102KE01# | <b>D1</b>          |                    |           |
|        | 16Vdc         | X6S     | 150pF              | ±10%               | GRT033C81E151KE01# | <b>D1</b>          |                    |           |
|        |               |         | 470pF              | ±10%               | GRT033C81E471KE01# | <b>D1</b>          |                    |           |
|        |               |         | 1000pF             | ±10%               | GRT033C81E102KE01# | <b>D1</b>          |                    |           |
|        |               | X5R     | 100pF              | ±10%               | GRT033R61E101KE01# | <b>D1</b>          |                    |           |
|        |               |         | 150pF              | ±10%               | GRT033R61E151KE01# | <b>D1</b>          |                    |           |
|        |               |         | 220pF              | ±10%               | GRT033R61E221KE01# | <b>D1</b>          |                    |           |
|        |               |         | 330pF              | ±10%               | GRT033R61E331KE01# | <b>D1</b>          |                    |           |
|        |               |         | 470pF              | ±10%               | GRT033R61E471KE01# | <b>D1</b>          |                    |           |
|        |               |         | 680pF              | ±10%               | GRT033R61E681KE01# | <b>D1</b>          |                    |           |
|        |               |         | 1000pF             | ±10%               | GRT033R61E102KE01# | <b>D1</b>          |                    |           |
|        |               |         | 4700pF             | ±10%               | GRT033R61E472KE01# | <b>D1</b>          |                    |           |
|        |               |         | 6800pF             | ±10%               | GRT033R61E682KE01# | <b>D1</b>          |                    |           |
|        |               |         | 10000pF            | ±10%               | GRT033R61E103KE01# | <b>D1</b>          |                    |           |
|        |               |         | 0.10μF             | ±10%               | GRT033R61E104KE01# | <b>D1</b>          |                    |           |
|        |               |         | 10Vdc              | X7S                | 0.10μF             | ±10%               | GRT033C71C104KE01# | <b>D1</b> |
|        | X6S           | 0.10μF  |                    |                    | ±10%               | GRT033C81C104KE01# | <b>D1</b>          |           |
|        |               | X5R     |                    |                    | 1000pF             | ±10%               | GRT033R61C103KE01# | <b>D1</b> |
|        |               |         |                    | 1500pF             | ±10%               | GRT033R61C153KE01# | <b>D1</b>          |           |
|        | 2200pF        |         |                    | ±10%               | GRT033R61C223KE01# | <b>D1</b>          |                    |           |
|        | 3300pF        | ±10%    |                    | GRT033R61C333KE01# | <b>D1</b>          |                    |                    |           |
|        | 4700pF        | ±10%    |                    | GRT033R61C473KE01# | <b>D1</b>          |                    |                    |           |
|        | 6800pF        | ±10%    |                    | GRT033R61C683KE01# | <b>D1</b>          |                    |                    |           |
|        | 0.10μF        | ±10%    |                    | GRT033R61C104KE01# | <b>D1</b>          |                    |                    |           |
|        | 6.3Vdc        | X7R     | 1000pF             | ±10%               | GRT033R71A103KE01# | <b>D1</b>          |                    |           |
|        |               |         | 0.10μF             | ±10%               | GRT033C71A104KE01# | <b>D1</b>          |                    |           |
|        |               |         | X6S                | 0.10μF             | ±10%               | GRT033C81A104KE01# | <b>D1</b>          |           |
|        |               | X5R     |                    | 1500pF             | ±10%               | GRT033R61A152KE01# | <b>D1</b>          |           |
|        |               |         |                    | 2200pF             | ±10%               | GRT033R61A222KE01# | <b>D1</b>          |           |
|        |               |         | 3300pF             | ±10%               | GRT033R61A332KE01# | <b>D1</b>          |                    |           |
|        |               | 4700pF  | ±10%               | GRT033R61A472KE01# | <b>D1</b>          |                    |                    |           |
|        |               | 6800pF  | ±10%               | GRT033R61A682KE01# | <b>D1</b>          |                    |                    |           |
|        |               | 10000pF | ±10%               | GRT033R61A103KE01# | <b>D1</b>          |                    |                    |           |
|        |               | 15000pF | ±10%               | GRT033R61A153KE01# | <b>D1</b>          |                    |                    |           |
|        |               | 22000pF | ±10%               | GRT033R61A223KE01# | <b>D1</b>          |                    |                    |           |
|        |               | 33000pF | ±10%               | GRT033R61A333KE01# | <b>D1</b>          |                    |                    |           |
|        |               | 47000pF | ±10%               | GRT033R61A473KE01# | <b>D1</b>          |                    |                    |           |
|        |               | 68000pF | ±10%               | GRT033R61A683KE01# | <b>D1</b>          |                    |                    |           |
|        |               | 0.10μF  | ±10%               | GRT033R61A104KE01# | <b>D1</b>          |                    |                    |           |
|        | 0.22μF        | ±10%    | GRT033R61A224KE01# | <b>D1</b>          |                    |                    |                    |           |
|        | 10Vdc         | X7R     | 2200pF             | ±10%               | GRT033R70J222KE01# | <b>D1</b>          |                    |           |
|        |               |         | 3300pF             | ±10%               | GRT033R70J332KE01# | <b>D1</b>          |                    |           |
| 4700pF |               |         | ±10%               | GRT033R70J472KE01# | <b>D1</b>          |                    |                    |           |
| X7S    |               | 6800pF  | ±10%               | GRT033R70J682KE01# | <b>D1</b>          |                    |                    |           |
|        |               | 10000pF | ±10%               | GRT033R70J103KE01# | <b>D1</b>          |                    |                    |           |
|        |               | 0.10μF  | ±10%               | GRT033C70J104KE01# | <b>D1</b>          |                    |                    |           |
| X6S    |               | 2200pF  | ±10%               | GRT033C80J222KE01# | <b>D1</b>          |                    |                    |           |
|        |               | 3300pF  | ±10%               | GRT033C80J332KE01# | <b>D1</b>          |                    |                    |           |

| T max. | Rated Voltage | TC Code | Cap.    | Tol.   | Part Number        |           |                    |                    |                    |                    |
|--------|---------------|---------|---------|--------|--------------------|-----------|--------------------|--------------------|--------------------|--------------------|
| 0.33mm | 6.3Vdc        | X6S     | 4700pF  | ±10%   | GRT033C80J472KE01# | <b>D1</b> |                    |                    |                    |                    |
|        |               |         | 6800pF  | ±10%   | GRT033C80J682KE01# | <b>D1</b> |                    |                    |                    |                    |
|        |               |         | 10000pF | ±10%   | GRT033C80J103KE01# | <b>D1</b> |                    |                    |                    |                    |
|        |               |         | 15000pF | ±10%   | GRT033C80J153KE01# | <b>D1</b> |                    |                    |                    |                    |
|        |               |         | 22000pF | ±10%   | GRT033C80J223KE01# | <b>D1</b> |                    |                    |                    |                    |
|        |               |         | 33000pF | ±10%   | GRT033C80J333KE01# | <b>D1</b> |                    |                    |                    |                    |
|        |               |         | 47000pF | ±10%   | GRT033C80J473KE01# | <b>D1</b> |                    |                    |                    |                    |
|        |               |         | 68000pF | ±10%   | GRT033C80J683KE01# | <b>D1</b> |                    |                    |                    |                    |
|        |               |         | 0.10μF  | ±10%   | GRT033C80J104KE01# | <b>D1</b> |                    |                    |                    |                    |
|        |               |         | 0.22μF  | ±10%   | GRT033C80J224KE01# | <b>D1</b> |                    |                    |                    |                    |
|        |               |         | 4Vdc    | X5R    | 10000pF            | ±10%      | GRT033R60J103KE01# | <b>D1</b>          |                    |                    |
|        |               |         |         |        | 15000pF            | ±10%      | GRT033R60J153KE01# | <b>D1</b>          |                    |                    |
|        | 22000pF       | ±10%    |         |        | GRT033R60J223KE01# | <b>D1</b> |                    |                    |                    |                    |
|        | 33000pF       | ±10%    |         |        | GRT033R60J333KE01# | <b>D1</b> |                    |                    |                    |                    |
|        | 47000pF       | ±10%    |         |        | GRT033R60J473KE01# | <b>D1</b> |                    |                    |                    |                    |
|        | 68000pF       | ±10%    |         |        | GRT033R60J683KE01# | <b>D1</b> |                    |                    |                    |                    |
|        | X6S           | 68000pF |         | ±10%   | GRT033C80G683KE01# | <b>D1</b> |                    |                    |                    |                    |
|        |               | 0.10μF  |         | ±10%   | GRT033C80G104KE01# | <b>D1</b> |                    |                    |                    |                    |
|        |               | 0.22μF  |         | ±20%   | GRT033C80G224ME01# | <b>D1</b> |                    |                    |                    |                    |
|        |               | 0.35mm  |         | 6.3Vdc | X5R                | 1.0μF     | ±20%               | GRT033R60J105ME13# | <b>D1</b>          |                    |
|        |               |         |         |        |                    | 4Vdc      | X5R                | 1.0μF              | ±20%               | GRT033R60G105ME13# |
|        |               |         |         | 0.39mm | 10Vdc              | X6S       | 1.0μF              | ±20%               | GRT033C81A105ME13# | <b>D1</b>          |
|        | 6.3Vdc        |         | X7T     |        |                    |           | 1.0μF              | ±20%               | GRT033D70J105ME13# | <b>D1</b>          |
|        |               |         |         |        |                    |           | X6S                | 1.0μF              | ±20%               | GRT033C80J105ME13# |
| 4Vdc   |               |         |         |        | X7T                | 1.0μF     |                    | ±20%               | GRT033D70G105ME13# | <b>D1</b>          |
|        | 2.5Vdc        |         | X7T     |        |                    | 1.0μF     |                    | ±20%               | GRT033D70E105ME18# | <b>D1</b>          |

## 1.0×0.5mm

| T max. | Rated Voltage | TC Code | Cap.   | Tol.   | Part Number        |                    |
|--------|---------------|---------|--------|--------|--------------------|--------------------|
| 0.22mm | 6.3Vdc        | X6S     | 0.22μF | ±10%   | GRT152C80J224KE13# | <b>D1</b>          |
|        |               |         | X5R    | 0.22μF | ±10%               | GRT152R60J224KE13# |
|        | 4Vdc          | X6S     | 0.22μF | ±10%   | GRT152C80G224KE13# | <b>D1</b>          |
| 0.33mm | 10Vdc         | X5R     | 1.0μF  | ±20%   | GRT153R61A105ME13# | <b>D1</b>          |
|        | 6.3Vdc        | X5R     | 1.0μF  | ±20%   | GRT153R60J105ME13# | <b>D1</b>          |
| 0.55mm | 50Vdc         | X7R     | 220pF  | ±10%   | GRT155R71H221KE01# | <b>D1</b>          |
|        |               |         | 270pF  | ±10%   | GRT155R71H271KE01# | <b>D1</b>          |
|        |               |         | 330pF  | ±10%   | GRT155R71H331KE01# | <b>D1</b>          |
|        |               |         | 470pF  | ±10%   | GRT155R71H471KE01# | <b>D1</b>          |
|        |               |         | 680pF  | ±10%   | GRT155R71H681KE01# | <b>D1</b>          |
|        |               |         | 820pF  | ±10%   | GRT155R71H821KE01# | <b>D1</b>          |
|        |               |         | 1000pF | ±10%   | GRT155R71H102KE01# | <b>D1</b>          |
|        |               |         | 1500pF | ±10%   | GRT155R71H152KE01# | <b>D1</b>          |
|        |               |         | 2200pF | ±10%   | GRT155R71H222KE01# | <b>D1</b>          |
|        |               |         | 2700pF | ±10%   | GRT155R71H272KE01# | <b>D1</b>          |
|        |               |         | 3300pF | ±10%   | GRT155R71H332KE01# | <b>D1</b>          |
|        |               |         | 4700pF | ±10%   | GRT155R71H472KE01# | <b>D1</b>          |

Part number # indicates the package specification code.

GRT Series  
 GCM Series  
 GC3 Series  
 GCJ Series  
 GCQ Series  
 GCD Series  
 GCE Series  
 NMF Series  
 KCM Series  
 KC3 Series  
 KCA Series  
 GCB Series  
 GCG Series  
 △Caution / Notice

# GRT Series High Dielectric Constant Type Part Number List

(→ 1.0×0.5mm)

| T max. | Rated Voltage | TC Code | Cap.    | Tol.   | Part Number        |                    |                    |           |
|--------|---------------|---------|---------|--------|--------------------|--------------------|--------------------|-----------|
| 0.55mm | 50Vdc         | X7R     | 6800pF  | ±10%   | GRT155R71H682KE01# | <b>D1</b>          |                    |           |
|        |               |         | 10000pF | ±10%   | GRT155R71H103KE01# | <b>D1</b>          |                    |           |
|        |               |         | 15000pF | ±10%   | GRT155R71H153KE01# | <b>D1</b>          |                    |           |
|        |               |         | 22000pF | ±10%   | GRT155R71H223KE01# | <b>D1</b>          |                    |           |
|        |               |         | 33000pF | ±10%   | GRT155R71H333KE01# | <b>D1</b>          |                    |           |
|        |               |         | 39000pF | ±10%   | GRT155R71H393KE01# | <b>D1</b>          |                    |           |
|        |               |         | 47000pF | ±10%   | GRT155R71H473KE01# | <b>D1</b>          |                    |           |
|        |               |         | 56000pF | ±10%   | GRT155R71H563KE01# | <b>D1</b>          |                    |           |
|        |               |         | 68000pF | ±10%   | GRT155R71H683KE01# | <b>D1</b>          |                    |           |
|        |               |         | 82000pF | ±10%   | GRT155R71H823KE01# | <b>D1</b>          |                    |           |
|        |               |         | 0.10μF  | ±10%   | GRT155R71H104KE01# | <b>D1</b>          |                    |           |
| 35Vdc  | X6S           | X5R     | 0.22μF  | ±10%   | GRT155C8YA224KE01# | <b>D1</b>          |                    |           |
|        |               |         | 0.47μF  | ±10%   | GRT155R6YA474KE01# | <b>D1</b>          |                    |           |
|        |               |         | 0.22μF  | ±10%   | GRT155R6YA224KE01# | <b>D1</b>          |                    |           |
| 25Vdc  | X7R           | X5R     | 5600pF  | ±10%   | GRT155R71E562KE01# | <b>D1</b>          |                    |           |
|        |               |         | 10000pF | ±10%   | GRT155R71E103KE01# | <b>D1</b>          |                    |           |
|        |               |         | 22000pF | ±10%   | GRT155R71E223KE01# | <b>D1</b>          |                    |           |
|        |               |         | 33000pF | ±10%   | GRT155R71E333KE01# | <b>D1</b>          |                    |           |
|        |               |         | 47000pF | ±10%   | GRT155R71E473KE01# | <b>D1</b>          |                    |           |
|        |               |         |         | 0.10μF | ±10%               | GRT155R71E104KE01# | <b>D1</b>          |           |
|        |               | X6S     |         | 0.22μF | ±10%               | GRT155C81E224KE01# | <b>D1</b>          |           |
|        |               | X5R     |         | 0.22μF | ±10%               | GRT155R61E224KE01# | <b>D1</b>          |           |
|        |               |         |         | 0.47μF | ±10%               | GRT155R61E474KE01# | <b>D1</b>          |           |
|        |               |         |         | 1.0μF  | ±10%               | GRT155R61E105KE01# | <b>D1</b>          |           |
| 16Vdc  | X7R           | X5R     | 10000pF | ±10%   | GRT155R71C103KE01# | <b>D1</b>          |                    |           |
|        |               |         | 22000pF | ±10%   | GRT155R71C223KE01# | <b>D1</b>          |                    |           |
|        |               |         | 33000pF | ±10%   | GRT155R71C333KE01# | <b>D1</b>          |                    |           |
|        |               |         | 47000pF | ±10%   | GRT155R71C473KE01# | <b>D1</b>          |                    |           |
|        |               |         | 68000pF | ±10%   | GRT155R71C683KE01# | <b>D1</b>          |                    |           |
|        |               |         |         | 0.10μF | ±10%               | GRT155R71C104KE01# | <b>D1</b>          |           |
|        |               |         |         | 0.22μF | ±10%               | GRT155R71C224KE01# | <b>D1</b>          |           |
|        |               | X6S     |         | 0.47μF | ±10%               | GRT155C81C474KE01# | <b>D1</b>          |           |
|        |               | X5R     |         | 0.22μF | ±10%               | GRT155R61C224KE01# | <b>D1</b>          |           |
|        |               |         |         | 0.47μF | ±10%               | GRT155R61C474KE01# | <b>D1</b>          |           |
|        |               |         | 1.0μF   | ±10%   | GRT155R61C105KE01# | <b>D1</b>          |                    |           |
| 10Vdc  | X7R           | X5R     | 0.22μF  | ±10%   | GRT155R71A224KE01# | <b>D1</b>          |                    |           |
|        |               |         | 0.47μF  | ±10%   | GRT155R71A474KE01# | <b>D1</b>          |                    |           |
|        |               | X6S     |         | 1.0μF  | ±10%               | GRT155C81A105KE01# | <b>D1</b>          |           |
|        |               | X5R     |         | 0.22μF | ±10%               | GRT155R61A224KE01# | <b>D1</b>          |           |
|        |               |         |         | 0.33μF | ±10%               | GRT155R61A334KE01# | <b>D1</b>          |           |
|        |               |         |         | 0.47μF | ±10%               | GRT155R61A474KE01# | <b>D1</b>          |           |
|        |               |         |         | 0.68μF | ±10%               | GRT155R61A684KE01# | <b>D1</b>          |           |
|        |               |         |         | 1.0μF  | ±10%               | GRT155R61A105KE01# | <b>D1</b>          |           |
|        |               |         |         | 2.2μF  | ±10%               | GRT155R61A225KE01# | <b>D1</b>          |           |
|        | 6.3Vdc        |         | X7R     | X5R    | 22000pF            | ±10%               | GRT155R70J223KE01# | <b>D1</b> |
| 1.0μF  |               |         |         |        | ±10%               | GRT155R70J105KE01# | <b>D1</b>          |           |
|        |               | X6S     |         | 0.22μF | ±10%               | GRT155C80J224KE01# | <b>D1</b>          |           |
|        |               |         |         | 0.33μF | ±10%               | GRT155C80J334KE01# | <b>D1</b>          |           |
|        |               |         |         | 0.47μF | ±10%               | GRT155C80J474KE01# | <b>D1</b>          |           |
|        |               |         |         | 0.68μF | ±10%               | GRT155C80J684KE01# | <b>D1</b>          |           |
|        |               |         |         | 1.0μF  | ±10%               | GRT155C80J105KE01# | <b>D1</b>          |           |
|        |               |         |         | 2.2μF  | ±10%               | GRT155C80J225KE01# | <b>D1</b>          |           |
|        |               |         | X5R     |        | 0.22μF             | ±10%               | GRT155R60J224KE01# | <b>D1</b> |
|        |               |         |         |        | 0.33μF             | ±10%               | GRT155R60J334KE01# | <b>D1</b> |

| T max. | Rated Voltage | TC Code | Cap.   | Tol.               | Part Number        |           |
|--------|---------------|---------|--------|--------------------|--------------------|-----------|
| 0.55mm | 6.3Vdc        | X5R     | 0.47μF | ±10%               | GRT155R60J474KE01# | <b>D1</b> |
|        |               |         | 0.68μF | ±10%               | GRT155R60J684KE01# | <b>D1</b> |
|        |               |         | 1.0μF  | ±10%               | GRT155R60J105KE01# | <b>D1</b> |
|        |               |         | 2.2μF  | ±10%               | GRT155R60J225KE01# | <b>D1</b> |
|        | 4Vdc          | X7R     | 1.0μF  | ±10%               | GRT155R70G105KE01# | <b>D1</b> |
|        |               | X6S     | 2.2μF  | ±10%               | GRT155C80G225KE13# | <b>D1</b> |
| 0.6mm  | 35Vdc         | X5R     | 1.0μF  | ±10%               | GRT155R6YA105KE13# | <b>D1</b> |
|        | 25Vdc         | X6S     | 1.0μF  | ±10%               | GRT155C81E105KE13# | <b>D1</b> |
|        | 16Vdc         | X6S     | 1.0μF  | ±10%               | GRT155C81C105KE13# | <b>D1</b> |
|        | 10Vdc         | X7S     | 1.0μF  | ±10%               | GRT155C71A105KE13# | <b>D1</b> |
|        | 6.3Vdc        | X5R     | 4.7μF  | ±20%               | GRT155R60J475ME13# | <b>D1</b> |
| 4Vdc   | X5R           | 4.7μF   | ±20%   | GRT155R60G475ME13# | <b>D1</b>          |           |
|        | 10Vdc         | X5R     | 4.7μF  | ±20%               | GRT155R61A475ME13# | <b>D1</b> |
| 0.65mm | 6.3Vdc        | X6S     | 4.7μF  | ±20%               | GRT155C80J475ME13# | <b>D1</b> |
|        | 4Vdc          | X6S     | 4.7μF  | ±20%               | GRT155C80G475ME13# | <b>D1</b> |
| 0.7mm  | 25Vdc         | X5R     | 2.2μF  | ±10%               | GRT155R61E225KE13# | <b>D1</b> |
|        |               | X6S     | 2.2μF  | ±10%               | GRT155C81C225KE13# | <b>D1</b> |
|        | 16Vdc         | X5R     | 2.2μF  | ±10%               | GRT155R61C225KE13# | <b>D1</b> |
|        |               | X7S     | 2.2μF  | ±10%               | GRT155C71A225KE13# | <b>D1</b> |
|        | 10Vdc         | X6S     | 2.2μF  | ±10%               | GRT155C81A225KE13# | <b>D1</b> |
|        |               | X7S     | 2.2μF  | ±10%               | GRT155C70J225KE13# | <b>D1</b> |
| 2.5Vdc | X6S           | 10μF    | ±20%   | GRT155C80E106ME13# | <b>D1</b>          |           |

## 1.6×0.8mm

| T max. | Rated Voltage | TC Code | Cap.    | Tol.               | Part Number        |                    |                    |           |
|--------|---------------|---------|---------|--------------------|--------------------|--------------------|--------------------|-----------|
| 0.9mm  | 100Vdc        | X7R     | 3300pF  | ±10%               | GRT188R72A332KE01# | <b>D1</b>          |                    |           |
|        |               |         | 10000pF | ±10%               | GRT188R72A103KE01# | <b>D1</b>          |                    |           |
|        | 50Vdc         | X5R     | 1.0μF   | ±10%               | GRT188R61H105KE13# | <b>D1</b>          |                    |           |
|        |               |         | 35Vdc   | X6S                | 1.0μF              | ±10%               | GRT188C8YA105KE13# | <b>D1</b> |
|        | 25Vdc         | X5R     | 2.2μF   | ±10%               | GRT188R6YA225KE13# | <b>D1</b>          |                    |           |
|        |               |         | X7R     | 0.15μF             | ±10%               | GRT188R71E154KE01# | <b>D1</b>          |           |
|        | 16Vdc         | X7R     | 0.22μF  | ±10%               | GRT188R71E224KE01# | <b>D1</b>          |                    |           |
|        |               |         | 0.47μF  | ±10%               | GRT188R71E474KE13# | <b>D1</b>          |                    |           |
|        |               |         | 1.0μF   | ±10%               | GRT188R71E105KE13# | <b>D1</b>          |                    |           |
|        |               |         | 0.33μF  | ±10%               | GRT188R71C334KE01# | <b>D1</b>          |                    |           |
| 0.47μF |               |         | ±10%    | GRT188R71C474KE01# | <b>D1</b>          |                    |                    |           |
| 1.0μF  |               |         | ±10%    | GRT188R71C105KE13# | <b>D1</b>          |                    |                    |           |
| 6.3Vdc | X5R           | 10μF    | ±20%    | GRT188R60J106ME13# | <b>D1</b>          |                    |                    |           |
|        |               | 4Vdc    | X6S     | 1.0μF              | ±20%               | GRT188C80G105ME01# | <b>D1</b>          |           |
| 4Vdc   | X6S           | 4.7μF   | ±10%    | GRT188C80G475KE01# | <b>D1</b>          |                    |                    |           |
|        |               | 10μF    | ±20%    | GRT188C80G106ME13# | <b>D1</b>          |                    |                    |           |
|        |               | 10μF    | ±20%    | GRT188R60G106ME13# | <b>D1</b>          |                    |                    |           |
|        |               | X5R     | 10μF    | ±20%               | GRT188R60G106ME13# | <b>D1</b>          |                    |           |
| 0.95mm | 25Vdc         | X5R     | 4.7μF   | ±10%               | GRT188R61E475KE13# | <b>D1</b>          |                    |           |
|        |               | X6S     | 4.7μF   | ±10%               | GRT188C81C475KE13# | <b>D1</b>          |                    |           |
|        | 16Vdc         | X5R     | 4.7μF   | ±10%               | GRT188R61C475KE13# | <b>D1</b>          |                    |           |
| 1.0mm  | 10Vdc         | X5R     | 10μF    | ±10%               | GRT188R61A106KE13# | <b>D1</b>          |                    |           |
|        |               |         | 2.5Vdc  | X5R                | 22μF               | ±20%               | GRT188R60E226ME13# | <b>D1</b> |
|        |               |         | 50Vdc   | X5R                | 2.2μF              | ±10%               | GRT188R61H225KE13# | <b>D1</b> |
|        | 35Vdc         | X6S     | 2.2μF   | ±10%               | GRT188C8YA225KE13# | <b>D1</b>          |                    |           |
|        |               |         | X5R     | 4.7μF              | ±10%               | GRT188R6YA475KE13# | <b>D1</b>          |           |
|        |               |         | X7S     | 2.2μF              | ±10%               | GRT188C71E225KE13# | <b>D1</b>          |           |

Part number # indicates the package specification code.

GRT Series  
 GCM Series  
 GC3 Series  
 GCJ Series  
 GCQ Series  
 GCD Series  
 GCE Series  
 NMF Series  
 KCM Series  
 KC3 Series  
 KCA Series  
 GCB Series  
 GCG Series  
 ⚠Caution /Notice

# GRT Series High Dielectric Constant Type Part Number List

(→ 1.6×0.8mm)

| T max. | Rated Voltage | TC Code | Cap.  | Tol. | Part Number        |                    |
|--------|---------------|---------|-------|------|--------------------|--------------------|
| 1.0mm  | 25Vdc         | X6S     | 2.2μF | ±10% | GRT188C81E225KE13# | <b>D1</b>          |
|        |               |         | 4.7μF | ±10% | GRT188C81E475KE13# | <b>D1</b>          |
|        |               | X5R     | 10μF  | ±20% | GRT188R61E106ME13# | <b>D1</b>          |
|        | 16Vdc         | X7S     | 2.2μF | ±10% | GRT188C71C225KE13# | <b>D1</b>          |
|        |               | X6S     | 10μF  | ±20% | GRT188C81C106ME13# | <b>D1</b>          |
|        | 10Vdc         | X7T     | 10μF  | ±20% | GRT188D71A106ME13# | <b>D1</b>          |
|        |               | X6S     | 10μF  | ±20% | GRT188C81A106ME13# | <b>D1</b>          |
|        |               | X5R     | 22μF  | ±20% | GRT188R61A226ME13# | <b>D1</b>          |
|        | 6.3Vdc        | X7T     | 10μF  | ±20% | GRT188D70J106ME13# | <b>D1</b>          |
|        |               |         | X6S   | 10μF | ±20%               | GRT188C80J106ME13# |
|        |               | X5R     | 22μF  | ±20% | GRT188R60J226ME13# | <b>D1</b>          |
|        | 4Vdc          | X6S     | 22μF  | ±20% | GRT188C80G226ME13# | <b>D1</b>          |

2.0×1.25mm

| T max. | Rated Voltage | TC Code | Cap.    | Tol.               | Part Number        |                    |
|--------|---------------|---------|---------|--------------------|--------------------|--------------------|
| 0.95mm | 16Vdc         | X5R     | 3.3μF   | ±10%               | GRT219R61C335KE01# | <b>D1</b>          |
|        | 10Vdc         | X6S     | 4.7μF   | ±10%               | GRT219C81A475KE01# | <b>D1</b>          |
|        |               | X5R     | 3.3μF   | ±10%               | GRT219R61A335KE01# | <b>D1</b>          |
| 1.35mm | 100Vdc        | X7R     | 47000pF | ±10%               | GRT21BR72A473KE01# | <b>D1</b>          |
|        | 50Vdc         | X7R     | 0.47μF  | ±10%               | GRT21BR71H474KE01# | <b>D1</b>          |
|        |               |         | 1.0μF   | ±10%               | GRT21BR71H105KE01# | <b>D1</b>          |
| 16Vdc  | X7R           | 2.2μF   | ±10%    | GRT21BR71C225KE01# | <b>D1</b>          |                    |
| 1.4mm  | 50Vdc         | X5R     | 4.7μF   | ±10%               | GRT21BR61H475KE13# | <b>D1</b>          |
|        | 35Vdc         | X6S     | 4.7μF   | ±10%               | GRT21BC8YA475KE13# | <b>D1</b>          |
|        | 25Vdc         | X7R     | 2.2μF   | ±10%               | GRT21BR71E225KE13# | <b>D1</b>          |
|        |               | X6S     | 3.3μF   | ±10%               | GRT21BC81E335KE13# | <b>D1</b>          |
|        | 16Vdc         | X7R     | 4.7μF   | ±10%               | GRT21BR71C475KE13# | <b>D1</b>          |
|        |               | X6S     | 3.3μF   | ±10%               | GRT21BC81C335KE13# | <b>D1</b>          |
|        | 10Vdc         | X7R     | 4.7μF   | ±10%               | GRT21BR71A475KE13# | <b>D1</b>          |
|        |               | X5R     | 3.3μF   | ±10%               | GRT21BR61A335KE13# | <b>D1</b>          |
|        | 6.3Vdc        | X5R     | 3.3μF   | ±10%               | GRT21BR60J335KE13# | <b>D1</b>          |
| 1.45mm | 50Vdc         | X7S     | 4.7μF   | ±10%               | GRT21BC71H475KE13# | <b>D1</b>          |
|        | 25Vdc         | X7S     | 4.7μF   | ±10%               | GRT21BC71E475KE13# | <b>D1</b>          |
|        |               |         | 10μF    | ±10%               | GRT21BC71E106KE13# | <b>D1</b>          |
|        | X5R           | 22μF    | ±20%    | GRT21BR61E226ME13# | <b>D1</b>          |                    |
|        |               | 16Vdc   | X7S     | 10μF               | ±10%               | GRT21BC71C106KE13# |
|        | X5R           | 22μF    | ±20%    | GRT21BR61C226ME13# | <b>D1</b>          |                    |
|        | 10Vdc         | X7T     | 22μF    | ±20%               | GRT21BD71A226ME13# | <b>D1</b>          |
|        |               | X6S     | 22μF    | ±20%               | GRT21BC81A226ME13# | <b>D1</b>          |
|        | 6.3Vdc        | X7T     | 22μF    | ±20%               | GRT21BD70J226ME13# | <b>D1</b>          |
| X5R    |               | 47μF    | ±20%    | GRT21BR60J476ME13# | <b>D1</b>          |                    |
| 4Vdc   | X6S           | 47μF    | ±20%    | GRT21BC80G476ME13# | <b>D1</b>          |                    |
|        | X5R           | 47μF    | ±20%    | GRT21BR60G476ME13# | <b>D1</b>          |                    |
| 2.5Vdc | X6S           | 47μF    | ±20%    | GRT21BC80E476ME13# | <b>D1</b>          |                    |

3.2×1.6mm

| T max. | Rated Voltage | TC Code | Cap.  | Tol. | Part Number        |           |
|--------|---------------|---------|-------|------|--------------------|-----------|
| 0.95mm | 35Vdc         | X5R     | 10μF  | ±10% | GRT319R6YA106KE01# | <b>D1</b> |
| 1.25mm | 50Vdc         | X6S     | 1.0μF | ±10% | GRT31MC81H105KE01# | <b>D1</b> |

| T max. | Rated Voltage | TC Code | Cap.               | Tol.               | Part Number        |                    |
|--------|---------------|---------|--------------------|--------------------|--------------------|--------------------|
| 1.25mm | 25Vdc         | X6S     | 1.5μF              | ±10%               | GRT31MC81E155KE01# | <b>D1</b>          |
|        |               |         | 10μF               | ±10%               | GRT31MC81E106KE01# | <b>D1</b>          |
|        |               | X5R     | 1.5μF              | ±10%               | GRT31MR61E155KE01# | <b>D1</b>          |
|        | 16Vdc         | X6S     | 1.5μF              | ±10%               | GRT31MC81C155KE01# | <b>D1</b>          |
|        |               |         | 6.8μF              | ±10%               | GRT31MC81C685KE01# | <b>D1</b>          |
|        |               | X5R     | 1.5μF              | ±10%               | GRT31MR61C155KE01# | <b>D1</b>          |
| X5R    | 6.8μF         | ±10%    | GRT31MR61C685KE01# | <b>D1</b>          |                    |                    |
|        | 1.8mm         | 50Vdc   | X7R                | 2.2μF              | ±10%               | GRT31CR71H225KE13# |
| X6S    |               |         | 1.5μF              | ±10%               | GRT31CC81H155KE01# | <b>D1</b>          |
|        |               |         | 2.2μF              | ±10%               | GRT31CC81H225KE01# | <b>D1</b>          |
| X5R    |               | 1.5μF   | ±10%               | GRT31CR61H155KE01# | <b>D1</b>          |                    |
|        |               | 10μF    | ±10%               | GRT31CR61H106KE01# | <b>D1</b>          |                    |
| 35Vdc  |               | X6S     | 10μF               | ±10%               | GRT31CC8YA106KE01# | <b>D1</b>          |
|        | X5R           |         | 10μF               | ±10%               | GRT31CR6YA106KE01# | <b>D1</b>          |
| 25Vdc  | X6S           | 10μF    | ±10%               | GRT31CC81E106KE01# | <b>D1</b>          |                    |
|        |               | X5R     | 3.3μF              | ±10%               | GRT31CR61E335KE01# | <b>D1</b>          |
|        | X6S           | 22μF    | ±10%               | GRT31CC81C226KE01# | <b>D1</b>          |                    |
| 10Vdc  | X5R           | 47μF    | ±10%               | GRT31CR61A476KE13# | <b>D1</b>          |                    |
| 6.3Vdc | X6S           | 47μF    | ±10%               | GRT31CC80J476KE13# | <b>D1</b>          |                    |
|        |               | X5R     | 15μF               | ±10%               | GRT31CR60J156KE01# | <b>D1</b>          |

3.2×2.5mm

| T max. | Rated Voltage | TC Code | Cap.               | Tol.               | Part Number        |           |
|--------|---------------|---------|--------------------|--------------------|--------------------|-----------|
| 1.5mm  | 25Vdc         | X5R     | 6.8μF              | ±10%               | GRT32NR61E685KE01# | <b>D1</b> |
| 2.2mm  | 50Vdc         | X6S     | 3.3μF              | ±10%               | GRT32DC81H335KE01# | <b>D1</b> |
|        |               | X5R     | 3.3μF              | ±10%               | GRT32DR61H335KE01# | <b>D1</b> |
| 2.7mm  | 6.3Vdc        | X5R     | 33μF               | ±20%               | GRT32DR60J336ME01# | <b>D1</b> |
|        |               |         | 50Vdc              | X7R                | 4.7μF              | ±10%      |
|        | X6S           | 4.7μF   | ±10%               | GRT32EC81H475KE01# | <b>D1</b>          |           |
|        |               | ±20%    | GRT32EC81C476ME13# | <b>D1</b>          |                    |           |
|        | 16Vdc         | X6S     | 47μF               | ±10%               | GRT32EC81C476KE13# | <b>D1</b> |
|        | 10Vdc         | X6S     | 47μF               | ±10%               | GRT32EC81A476KE13# | <b>D1</b> |
| 6.3Vdc | X7R           | 47μF    | ±10%               | GRT32ER70J476KE13# | <b>D1</b>          |           |
|        |               | X7S     | 100μF              | ±20%               | GRT32EC70J107ME13# | <b>D1</b> |
|        | X5R           | 100μF   | ±20%               | GRT32ER60J107ME13# | <b>D1</b>          |           |
| 4Vdc   | X7S           | 100μF   | ±20%               | GRT32EC70G107ME13# | <b>D1</b>          |           |

Part number # indicates the package specification code.



Chip Multilayer Ceramic Capacitors for Automotive

**GCM Series**



Capacitor for automotive applications such as power train and safety equipment.

Features

① Ideal for powertrains and safety devices in automotive.

This product can be used for safety devices, such as the drive system control for engine ECU, air bags, and ABS. This product has cleared test conditions more severe than that of general products (GRM Series) even in temperature cycle and humidity load tests.

|                   | General Purpose GRM Series<br>Maximum operating temperature: 125°C             | GCM Series for Automotive<br>Maximum operating temperature: 150°C  |
|-------------------|--|--|
| Items             | Test Method  | Test Method  |
| Temperature Cycle | Temperature Cycle: 5 cycles  | Temperature Cycle: 100 cycles<br>(1,000 cycles for AEC-Q200 conforming products)   |
| Humidity Loading  | Test temperature: 40±2°C<br>Test humidity: 90 to 95%RH<br>Test time: 500 hours | Test temperature: 85±2°C<br>Test humidity: 80 to 85%RH<br>Test time: 500 hours<br>(1,000 hours for AEC-Q200 conforming products) |

② Can be used at 125°C and 150°C temperatures.

We also offer a lineup for 150°C that can be used in the engine room.

③ Sn plating is applied to the external electrodes; excellent solderability.

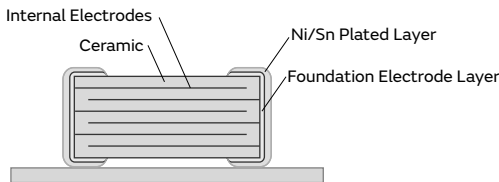

<Example of Structure>

Specifications

|                   |   |
|-------------------|---|
| Size              | 0.6×0.3mm to 5.7×5.0mm  |
| Rated Voltage     | 2.5Vdc to 1000Vdc   |
| Capacitance       | 0.10pF to 100μF   |
| Main Applications | Safety equipment, such as drive system control, air bags, and ABS of engine ECU |

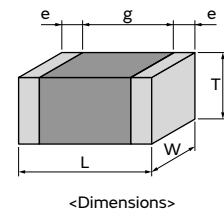

GRT Series  
 GCM Series  
 GC3 Series  
 GCJ Series  
 GCQ Series  
 GCD Series  
 GCE Series  
 NMF Series  
 KCM Series  
 KC3 Series  
 KCA Series  
 GCB Series  
 GCG Series  
 △Caution / Notice

# GCM Series Temperature Compensating Type Part Number List

0.6×0.3mm

| T max. | Rated Voltage | TC Code            | Cap.   | Tol.    | Part Number        |
|--------|---------------|--------------------|--------|---------|--------------------|
| 0.33mm | 50Vdc         | COG                | 0.10pF | ±0.05pF | GCM0335C1HR10WA16# |
|        |               |                    |        | ±0.1pF  | GCM0335C1HR11BA16# |
|        |               |                    | 0.11pF | ±0.05pF | GCM0335C1HR11WA16# |
|        |               |                    |        | ±0.1pF  | GCM0335C1HR11BA16# |
|        |               |                    | 0.12pF | ±0.05pF | GCM0335C1HR12WA16# |
|        |               |                    |        | ±0.1pF  | GCM0335C1HR12BA16# |
|        |               |                    | 0.13pF | ±0.05pF | GCM0335C1HR13WA16# |
|        |               |                    |        | ±0.1pF  | GCM0335C1HR13BA16# |
|        |               |                    | 0.15pF | ±0.05pF | GCM0335C1HR15WA16# |
|        |               |                    |        | ±0.1pF  | GCM0335C1HR15BA16# |
|        |               |                    | 0.16pF | ±0.05pF | GCM0335C1HR16WA16# |
|        |               |                    |        | ±0.1pF  | GCM0335C1HR16BA16# |
|        |               |                    | 0.18pF | ±0.05pF | GCM0335C1HR18WA16# |
|        |               |                    |        | ±0.1pF  | GCM0335C1HR18BA16# |
|        |               |                    | 0.20pF | ±0.05pF | GCM0335C1HR20WA16# |
|        |               |                    |        | ±0.1pF  | GCM0335C1HR20BA16# |
|        |               |                    | 0.22pF | ±0.05pF | GCM0335C1HR22WA16# |
|        |               |                    |        | ±0.1pF  | GCM0335C1HR22BA16# |
|        |               |                    | 0.24pF | ±0.05pF | GCM0335C1HR24WA16# |
|        |               |                    |        | ±0.1pF  | GCM0335C1HR24BA16# |
|        |               |                    | 0.27pF | ±0.05pF | GCM0335C1HR27WA16# |
|        |               |                    |        | ±0.1pF  | GCM0335C1HR27BA16# |
|        |               |                    | 0.30pF | ±0.05pF | GCM0335C1HR30WA16# |
|        |               |                    |        | ±0.1pF  | GCM0335C1HR30BA16# |
|        |               |                    | 0.33pF | ±0.05pF | GCM0335C1HR33WA16# |
|        |               |                    |        | ±0.1pF  | GCM0335C1HR33BA16# |
|        |               |                    | 0.36pF | ±0.05pF | GCM0335C1HR36WA16# |
|        |               |                    |        | ±0.1pF  | GCM0335C1HR36BA16# |
|        |               |                    | 0.39pF | ±0.05pF | GCM0335C1HR39WA16# |
|        |               |                    |        | ±0.1pF  | GCM0335C1HR39BA16# |
|        |               |                    | 0.40pF | ±0.05pF | GCM0335C1HR40WA16# |
|        |               |                    |        | ±0.1pF  | GCM0335C1HR40BA16# |
|        |               |                    | 0.43pF | ±0.05pF | GCM0335C1HR43WA16# |
|        |               |                    |        | ±0.1pF  | GCM0335C1HR43BA16# |
|        |               |                    | 0.47pF | ±0.05pF | GCM0335C1HR47WA16# |
|        |               |                    |        | ±0.1pF  | GCM0335C1HR47BA16# |
|        |               |                    | 0.50pF | ±0.05pF | GCM0335C1HR50WA16# |
|        |               |                    |        | ±0.1pF  | GCM0335C1HR50BA16# |
|        |               |                    | 0.51pF | ±0.05pF | GCM0335C1HR51WA16# |
|        |               |                    |        | ±0.1pF  | GCM0335C1HR51BA16# |
| 0.56pF | ±0.05pF       | GCM0335C1HR56WA16# |        |         |                    |
|        | ±0.1pF        | GCM0335C1HR56BA16# |        |         |                    |
| 0.60pF | ±0.05pF       | GCM0335C1HR60WA16# |        |         |                    |
|        | ±0.1pF        | GCM0335C1HR60BA16# |        |         |                    |
| 0.62pF | ±0.05pF       | GCM0335C1HR62WA16# |        |         |                    |
|        | ±0.1pF        | GCM0335C1HR62BA16# |        |         |                    |
| 0.68pF | ±0.05pF       | GCM0335C1HR68WA16# |        |         |                    |
|        | ±0.1pF        | GCM0335C1HR68BA16# |        |         |                    |
| 0.70pF | ±0.05pF       | GCM0335C1HR70WA16# |        |         |                    |
|        | ±0.1pF        | GCM0335C1HR70BA16# |        |         |                    |
| 0.75pF | ±0.05pF       | GCM0335C1HR75WA16# |        |         |                    |
|        | ±0.1pF        | GCM0335C1HR75BA16# |        |         |                    |
| 0.80pF | ±0.05pF       | GCM0335C1HR80WA16# |        |         |                    |

| T max. | Rated Voltage | TC Code            | Cap.               | Tol.    | Part Number        |
|--------|---------------|--------------------|--------------------|---------|--------------------|
| 0.33mm | 50Vdc         | COG                | 0.80pF             | ±0.1pF  | GCM0335C1HR80BA16# |
|        |               |                    |                    | ±0.05pF | GCM0335C1HR82WA16# |
|        |               |                    | 0.82pF             | ±0.1pF  | GCM0335C1HR82BA16# |
|        |               |                    |                    | ±0.05pF | GCM0335C1HR90WA16# |
|        |               |                    | 0.90pF             | ±0.05pF | GCM0335C1HR90WA16# |
|        |               |                    |                    | ±0.1pF  | GCM0335C1HR90BA16# |
|        |               |                    | 0.91pF             | ±0.05pF | GCM0335C1HR91WA16# |
|        |               |                    |                    | ±0.1pF  | GCM0335C1HR91BA16# |
|        |               |                    | 1.0pF              | ±0.25pF | GCM0335C1H1R0CA16# |
|        |               |                    |                    | ±0.25pF | GCM0335C1H1R1CA16# |
|        |               |                    | 1.1pF              | ±0.25pF | GCM0335C1H1R1CA16# |
|        |               |                    |                    | ±0.25pF | GCM0335C1H1R2CA16# |
|        |               |                    | 1.2pF              | ±0.25pF | GCM0335C1H1R2CA16# |
|        |               |                    |                    | ±0.25pF | GCM0335C1H1R3CA16# |
|        |               |                    | 1.3pF              | ±0.25pF | GCM0335C1H1R3CA16# |
|        |               |                    |                    | ±0.25pF | GCM0335C1H1R5CA16# |
|        |               |                    | 1.5pF              | ±0.25pF | GCM0335C1H1R5CA16# |
|        |               |                    |                    | ±0.25pF | GCM0335C1H1R6CA16# |
|        |               |                    | 1.6pF              | ±0.25pF | GCM0335C1H1R6CA16# |
|        |               |                    |                    | ±0.25pF | GCM0335C1H1R8CA16# |
|        |               |                    | 1.8pF              | ±0.25pF | GCM0335C1H1R8CA16# |
|        |               |                    |                    | ±0.25pF | GCM0335C1H2R0CA16# |
|        |               |                    | 2.0pF              | ±0.25pF | GCM0335C1H2R0CA16# |
|        |               |                    |                    | ±0.25pF | GCM0335C1H2R2CA16# |
|        |               |                    | 2.2pF              | ±0.25pF | GCM0335C1H2R2CA16# |
|        |               |                    |                    | ±0.25pF | GCM0335C1H2R4CA16# |
|        |               |                    | 2.4pF              | ±0.25pF | GCM0335C1H2R4CA16# |
|        |               |                    |                    | ±0.25pF | GCM0335C1H2R7CA16# |
|        |               |                    | 2.7pF              | ±0.25pF | GCM0335C1H2R7CA16# |
|        |               |                    |                    | ±0.25pF | GCM0335C1H3R0CA16# |
|        |               |                    | 3.0pF              | ±0.25pF | GCM0335C1H3R0CA16# |
|        |               |                    |                    | ±0.25pF | GCM0335C1H3R3CA16# |
|        |               |                    | 3.3pF              | ±0.25pF | GCM0335C1H3R3CA16# |
|        |               |                    |                    | ±0.25pF | GCM0335C1H3R6CA16# |
|        |               |                    | 3.6pF              | ±0.25pF | GCM0335C1H3R6CA16# |
|        |               |                    |                    | ±0.25pF | GCM0335C1H3R9CA16# |
|        |               |                    | 3.9pF              | ±0.25pF | GCM0335C1H3R9CA16# |
|        |               |                    |                    | ±0.25pF | GCM0335C1H4R0CA16# |
|        |               |                    | 4.0pF              | ±0.25pF | GCM0335C1H4R0CA16# |
|        |               |                    |                    | ±0.25pF | GCM0335C1H4R3CA16# |
| 4.3pF  | ±0.25pF       | GCM0335C1H4R3CA16# |                    |         |                    |
|        | ±0.25pF       | GCM0335C1H4R7CA16# |                    |         |                    |
| 4.7pF  | ±0.25pF       | GCM0335C1H4R7CA16# |                    |         |                    |
|        | ±0.25pF       | GCM0335C1H5R0CA16# |                    |         |                    |
| 5.0pF  | ±0.25pF       | GCM0335C1H5R0CA16# |                    |         |                    |
|        | ±0.5pF        | GCM0335C1H5R1DA16# |                    |         |                    |
| 5.1pF  | ±0.5pF        | GCM0335C1H5R1DA16# |                    |         |                    |
|        | ±0.5pF        | GCM0335C1H5R6DA16# |                    |         |                    |
| 5.6pF  | ±0.5pF        | GCM0335C1H5R6DA16# |                    |         |                    |
|        | ±0.5pF        | GCM0335C1H6R0DA16# |                    |         |                    |
| 6.0pF  | ±0.5pF        | GCM0335C1H6R0DA16# |                    |         |                    |
|        | ±0.5pF        | GCM0335C1H6R2DA16# |                    |         |                    |
| 6.2pF  | ±0.5pF        | GCM0335C1H6R2DA16# |                    |         |                    |
|        | ±0.5pF        | GCM0335C1H6R8DA16# |                    |         |                    |
| 6.8pF  | ±0.5pF        | GCM0335C1H6R8DA16# |                    |         |                    |
|        | ±0.5pF        | GCM0335C1H7R0DA16# |                    |         |                    |
| 7.0pF  | ±0.5pF        | GCM0335C1H7R0DA16# |                    |         |                    |
|        | ±0.5pF        | GCM0335C1H7R5DA16# |                    |         |                    |
| 7.5pF  | ±0.5pF        | GCM0335C1H7R5DA16# |                    |         |                    |
|        | ±0.5pF        | GCM0335C1H8R0DA16# |                    |         |                    |
| 8.0pF  | ±0.5pF        | GCM0335C1H8R0DA16# |                    |         |                    |
|        | ±0.5pF        | GCM0335C1H8R2DA16# |                    |         |                    |
| 8.2pF  | ±0.5pF        | GCM0335C1H8R2DA16# |                    |         |                    |
|        | ±0.5pF        | GCM0335C1H9R0DA16# |                    |         |                    |
| 9.0pF  | ±0.5pF        | GCM0335C1H9R0DA16# |                    |         |                    |
|        | ±0.5pF        | GCM0335C1H9R1DA16# |                    |         |                    |
| 9.1pF  | ±0.5pF        | GCM0335C1H9R1DA16# |                    |         |                    |
|        | 10pF          | ±1%                | GCM0335C1H100FA16# |         |                    |
| ±2%    |               | GCM0335C1H100GA16# |                    |         |                    |
| ±5%    |               | GCM0335C1H100JA16# |                    |         |                    |
| 11pF   | ±1%           | GCM0335C1H110FA16# |                    |         |                    |
|        | ±2%           | GCM0335C1H110GA16# |                    |         |                    |
|        | ±5%           | GCM0335C1H110JA16# |                    |         |                    |
| 12pF   | ±1%           | GCM0335C1H120FA16# |                    |         |                    |
|        | ±2%           | GCM0335C1H120GA16# |                    |         |                    |
|        | ±5%           | GCM0335C1H120JA16# |                    |         |                    |
| 13pF   | ±1%           | GCM0335C1H130FA16# |                    |         |                    |
|        | ±2%           | GCM0335C1H130GA16# |                    |         |                    |
|        | ±5%           | GCM0335C1H130JA16# |                    |         |                    |
| 15pF   | ±1%           | GCM0335C1H150FA16# |                    |         |                    |
|        | ±2%           | GCM0335C1H150GA16# |                    |         |                    |
|        | ±5%           | GCM0335C1H150JA16# |                    |         |                    |
| 16pF   | ±1%           | GCM0335C1H160FA16# |                    |         |                    |
|        | ±2%           | GCM0335C1H160GA16# |                    |         |                    |

Part number # indicates the package specification code.

GRT Series  
 GCM Series  
 GC3 Series  
 GCJ Series  
 GCQ Series  
 GCD Series  
 GCE Series  
 NMF Series  
 KCM Series  
 KC3 Series  
 KCA Series  
 GCB Series  
 GCG Series  
 ⚠Caution /Notice

# GCM Series Temperature Compensating Type Power-train AEC-Q200 Part Number List

(→ 0.6×0.3mm)

| T max. | Rated Voltage | TC Code | Cap. | Tol.               | Part Number        |
|--------|---------------|---------|------|--------------------|--------------------|
| 0.33mm | 50Vdc         | COG     | 16pF | ±5%                | GCM0335C1H160JA16# |
|        |               |         |      | ±1%                | GCM0335C1H180FA16# |
|        |               |         |      |                    | ±2%                |
|        |               |         | ±5%  | GCM0335C1H180JA16# |                    |
|        |               |         |      | ±1%                | GCM0335C1H200FA16# |
|        |               |         |      |                    | ±2%                |
|        |               |         | ±5%  |                    | GCM0335C1H200JA16# |
|        |               |         | ±1%  | GCM0335C1H220FA16# |                    |
|        |               |         |      | ±2%                | GCM0335C1H220GA16# |
|        |               |         |      | ±5%                | GCM0335C1H220JA16# |
|        |               |         | ±1%  | GCM0335C1H240FA16# |                    |
|        |               |         |      | ±2%                | GCM0335C1H240GA16# |
|        |               |         |      | ±5%                | GCM0335C1H240JA16# |
|        |               |         | ±1%  | GCM0335C1H270FA16# |                    |
|        |               |         |      | ±2%                | GCM0335C1H270GA16# |
|        |               |         |      | ±5%                | GCM0335C1H270JA16# |
|        |               |         | ±1%  | GCM0335C1H300FA16# |                    |
|        |               |         |      | ±2%                | GCM0335C1H300GA16# |
|        |               |         |      | ±5%                | GCM0335C1H300JA16# |
|        |               |         | ±1%  | GCM0335C1H330FA16# |                    |
|        |               |         |      | ±2%                | GCM0335C1H330GA16# |
|        |               |         |      | ±5%                | GCM0335C1H330JA16# |
|        |               |         | ±1%  | GCM0335C1H360FA16# |                    |
|        |               |         |      | ±2%                | GCM0335C1H360GA16# |
|        |               |         |      | ±5%                | GCM0335C1H360JA16# |
|        |               |         | ±1%  | GCM0335C1H390FA16# |                    |
|        |               |         |      | ±2%                | GCM0335C1H390GA16# |
|        |               |         |      | ±5%                | GCM0335C1H390JA16# |
|        |               |         | ±1%  | GCM0335C1H430FA16# |                    |
|        |               |         |      | ±2%                | GCM0335C1H430GA16# |
|        |               |         |      | ±5%                | GCM0335C1H430JA16# |
|        |               |         | ±1%  | GCM0335C1H470FA16# |                    |
|        |               |         |      | ±2%                | GCM0335C1H470GA16# |
|        |               |         |      | ±5%                | GCM0335C1H470JA16# |
|        |               |         | ±1%  | GCM0335C1H510FA16# |                    |
|        |               |         |      | ±2%                | GCM0335C1H510GA16# |
|        |               |         |      | ±5%                | GCM0335C1H510JA16# |
|        |               |         | ±1%  | GCM0335C1H560FA16# |                    |
|        |               |         |      | ±2%                | GCM0335C1H560GA16# |
|        |               |         |      | ±5%                | GCM0335C1H560JA16# |
|        |               |         | ±1%  | GCM0335C1H620FA16# |                    |
|        |               |         |      | ±2%                | GCM0335C1H620GA16# |
|        |               |         |      | ±5%                | GCM0335C1H620JA16# |
|        |               |         | ±1%  | GCM0335C1H680FA16# |                    |
|        |               |         |      | ±2%                | GCM0335C1H680GA16# |
|        |               |         |      | ±5%                | GCM0335C1H680JA16# |
|        |               |         | ±1%  | GCM0335C1H750FA16# |                    |
|        |               |         |      | ±2%                | GCM0335C1H750GA16# |
|        |               |         |      | ±5%                | GCM0335C1H750JA16# |
|        |               |         | ±1%  | GCM0335C1H820FA16# |                    |
|        |               |         |      | ±2%                | GCM0335C1H820GA16# |
|        |               |         |      | ±5%                | GCM0335C1H820JA16# |
|        |               |         | ±1%  | GCM0335C1H910FA16# |                    |
|        |               |         |      | ±2%                | GCM0335C1H910GA16# |

| T max. | Rated Voltage | TC Code | Cap.  | Tol. | Part Number        |                    |                    |
|--------|---------------|---------|-------|------|--------------------|--------------------|--------------------|
| 0.33mm | 50Vdc         | COG     | 91pF  | ±5%  | GCM0335C1H910JA16# |                    |                    |
|        |               |         |       | ±1%  | GCM0335C1H101FA16# |                    |                    |
|        |               |         |       |      | ±2%                | GCM0335C1H101GA16# |                    |
|        |               |         |       |      | ±5%                | GCM0335C1H101JA16# |                    |
|        |               |         | 25Vdc | COG  | 0.10pF             | ±0.05pF            | GCM0335C1ER10WA16# |
|        |               |         |       |      |                    | ±0.05pF            | GCM0335C1ER11WA16# |
|        |               |         |       |      |                    |                    | ±0.1pF             |
|        |               |         |       |      | ±0.05pF            | GCM0335C1ER12WA16# |                    |
|        |               |         |       |      |                    | ±0.1pF             | GCM0335C1ER12BA16# |
|        |               |         |       |      | ±0.05pF            | GCM0335C1ER13WA16# |                    |
|        |               |         |       |      |                    | ±0.1pF             | GCM0335C1ER13BA16# |
|        |               |         |       |      | ±0.05pF            | GCM0335C1ER15WA16# |                    |
|        |               |         |       |      |                    | ±0.1pF             | GCM0335C1ER15BA16# |
|        |               |         |       |      | ±0.05pF            | GCM0335C1ER16WA16# |                    |
|        |               |         |       |      |                    | ±0.1pF             | GCM0335C1ER16BA16# |
|        |               |         |       |      | ±0.05pF            | GCM0335C1ER18WA16# |                    |
|        |               |         |       |      |                    | ±0.1pF             | GCM0335C1ER18BA16# |
|        |               |         |       |      | ±0.05pF            | GCM0335C1ER20WA16# |                    |
|        |               |         |       |      |                    | ±0.1pF             | GCM0335C1ER20BA16# |
|        |               |         |       |      | ±0.05pF            | GCM0335C1ER22WA16# |                    |
|        |               |         |       |      |                    | ±0.1pF             | GCM0335C1ER22BA16# |
|        |               |         |       |      | ±0.05pF            | GCM0335C1ER24WA16# |                    |
|        |               |         |       |      |                    | ±0.1pF             | GCM0335C1ER24BA16# |
|        |               |         |       |      | ±0.05pF            | GCM0335C1ER27WA16# |                    |
|        |               |         |       |      |                    | ±0.1pF             | GCM0335C1ER27BA16# |
|        |               |         |       |      | ±0.05pF            | GCM0335C1ER30WA16# |                    |
|        |               |         |       |      |                    | ±0.1pF             | GCM0335C1ER30BA16# |
|        |               |         |       |      | ±0.05pF            | GCM0335C1ER33WA16# |                    |
|        |               |         |       |      |                    | ±0.1pF             | GCM0335C1ER33BA16# |
|        |               |         |       |      | ±0.05pF            | GCM0335C1ER36WA16# |                    |
|        |               |         |       |      |                    | ±0.1pF             | GCM0335C1ER36BA16# |
|        |               |         |       |      | ±0.05pF            | GCM0335C1ER39WA16# |                    |
|        |               |         |       |      |                    | ±0.1pF             | GCM0335C1ER39BA16# |
|        |               |         |       |      | ±0.05pF            | GCM0335C1ER40WA16# |                    |
|        |               |         |       |      |                    | ±0.1pF             | GCM0335C1ER40BA16# |
|        |               |         |       |      | ±0.05pF            | GCM0335C1ER43WA16# |                    |
|        |               |         |       |      |                    | ±0.1pF             | GCM0335C1ER43BA16# |
|        |               |         |       |      | ±0.05pF            | GCM0335C1ER47WA16# |                    |
|        |               |         |       |      |                    | ±0.1pF             | GCM0335C1ER47BA16# |
|        |               |         |       |      | ±0.05pF            | GCM0335C1ER50WA16# |                    |
|        |               |         |       |      |                    | ±0.1pF             | GCM0335C1ER50BA16# |
|        |               |         |       |      | ±0.05pF            | GCM0335C1ER51WA16# |                    |
|        |               |         |       |      |                    | ±0.1pF             | GCM0335C1ER51BA16# |
|        |               |         |       |      | ±0.05pF            | GCM0335C1ER56WA16# |                    |
|        |               |         |       |      |                    | ±0.1pF             | GCM0335C1ER56BA16# |
|        |               |         |       |      | ±0.05pF            | GCM0335C1ER60WA16# |                    |
|        |               |         |       |      |                    | ±0.1pF             | GCM0335C1ER60BA16# |
|        |               |         |       |      | ±0.05pF            | GCM0335C1ER62WA16# |                    |
|        |               |         |       |      |                    | ±0.1pF             | GCM0335C1ER62BA16# |
|        |               |         |       |      | ±0.05pF            | GCM0335C1ER68WA16# |                    |
|        |               |         |       |      |                    | ±0.1pF             | GCM0335C1ER68BA16# |
|        |               |         |       |      | ±0.05pF            | GCM0335C1ER70WA16# |                    |
|        |               |         |       |      |                    | ±0.1pF             | GCM0335C1ER70BA16# |
|        |               |         |       |      | ±0.05pF            | GCM0335C1ER75WA16# |                    |

Part number # indicates the package specification code.

GRT Series  
 GCM Series  
 GC3 Series  
 GCJ Series  
 GCQ Series  
 GCD Series  
 GCE Series  
 NMF Series  
 KCM Series  
 KC3 Series  
 KCA Series  
 GCB Series  
 GCG Series  
 ⚠Caution /Notice

# GCM Series Temperature Compensating Type Part Number List

(→ 0.6×0.3mm)

| T max. | Rated Voltage      | TC Code            | Cap.   | Tol.               | Part Number        | T max. | Rated Voltage | TC Code | Cap. | Tol.               | Part Number        |
|--------|--------------------|--------------------|--------|--------------------|--------------------|--------|---------------|---------|------|--------------------|--------------------|
| 0.33mm | 25Vdc              | COG                | 0.75pF | ±0.1pF             | GCM0335C1ER75BA16# | 0.33mm | 25Vdc         | COG     | 15pF | ±1%                | GCM0335C1E150FA16# |
|        |                    |                    |        | ±0.05pF            | GCM0335C1ER80WA16# |        |               |         |      | ±2%                | GCM0335C1E150GA16# |
|        |                    |                    | ±0.1pF | GCM0335C1ER80BA16# | ±5%                |        |               |         |      | GCM0335C1E150JA16# |                    |
|        |                    |                    | 0.82pF | ±0.05pF            | GCM0335C1ER82WA16# |        |               |         | 16pF | ±1%                | GCM0335C1E160FA16# |
|        |                    |                    |        | ±0.1pF             | GCM0335C1ER82BA16# |        |               |         |      | ±2%                | GCM0335C1E160GA16# |
|        |                    |                    | 0.90pF | ±0.05pF            | GCM0335C1ER90WA16# |        |               |         |      | ±5%                | GCM0335C1E160JA16# |
|        |                    |                    |        | ±0.1pF             | GCM0335C1ER90BA16# |        |               |         | 18pF | ±1%                | GCM0335C1E180FA16# |
|        |                    |                    | 0.91pF | ±0.05pF            | GCM0335C1ER91WA16# |        |               |         |      | ±2%                | GCM0335C1E180GA16# |
|        |                    |                    |        | ±0.1pF             | GCM0335C1ER91BA16# |        |               |         |      | ±5%                | GCM0335C1E180JA16# |
|        |                    |                    | 1.0pF  | ±0.25pF            | GCM0335C1E1R0CA16# |        |               |         | 20pF | ±1%                | GCM0335C1E200FA16# |
|        |                    |                    | 1.1pF  | ±0.25pF            | GCM0335C1E1R1CA16# |        |               |         |      | ±2%                | GCM0335C1E200GA16# |
|        |                    |                    | 1.2pF  | ±0.25pF            | GCM0335C1E1R2CA16# |        |               |         |      | ±5%                | GCM0335C1E200JA16# |
|        |                    |                    | 1.3pF  | ±0.25pF            | GCM0335C1E1R3CA16# |        |               |         | 22pF | ±1%                | GCM0335C1E220FA16# |
|        |                    |                    | 1.5pF  | ±0.25pF            | GCM0335C1E1R5CA16# |        |               |         |      | ±2%                | GCM0335C1E220GA16# |
|        |                    |                    | 1.6pF  | ±0.25pF            | GCM0335C1E1R6CA16# |        |               |         |      | ±5%                | GCM0335C1E220JA16# |
|        |                    |                    | 1.8pF  | ±0.25pF            | GCM0335C1E1R8CA16# |        |               |         | 24pF | ±1%                | GCM0335C1E240FA16# |
|        |                    |                    | 2.0pF  | ±0.25pF            | GCM0335C1E2R0CA16# |        |               |         |      | ±2%                | GCM0335C1E240GA16# |
|        |                    |                    | 2.2pF  | ±0.25pF            | GCM0335C1E2R2CA16# |        |               |         |      | ±5%                | GCM0335C1E240JA16# |
|        |                    |                    | 2.4pF  | ±0.25pF            | GCM0335C1E2R4CA16# |        |               |         | 27pF | ±1%                | GCM0335C1E270FA16# |
|        |                    |                    | 2.7pF  | ±0.25pF            | GCM0335C1E2R7CA16# |        |               |         |      | ±2%                | GCM0335C1E270GA16# |
|        |                    |                    | 3.0pF  | ±0.25pF            | GCM0335C1E3R0CA16# |        |               |         |      | ±5%                | GCM0335C1E270JA16# |
|        |                    |                    | 3.3pF  | ±0.25pF            | GCM0335C1E3R3CA16# |        |               |         | 30pF | ±1%                | GCM0335C1E300FA16# |
|        |                    |                    | 3.6pF  | ±0.25pF            | GCM0335C1E3R6CA16# |        |               |         |      | ±2%                | GCM0335C1E300GA16# |
|        |                    |                    | 3.9pF  | ±0.25pF            | GCM0335C1E3R9CA16# |        |               |         |      | ±5%                | GCM0335C1E300JA16# |
|        |                    |                    | 4.0pF  | ±0.25pF            | GCM0335C1E4R0CA16# |        |               |         | 33pF | ±1%                | GCM0335C1E330FA16# |
|        |                    |                    | 4.3pF  | ±0.25pF            | GCM0335C1E4R3CA16# |        |               |         |      | ±2%                | GCM0335C1E330GA16# |
|        |                    |                    | 4.7pF  | ±0.25pF            | GCM0335C1E4R7CA16# |        |               |         |      | ±5%                | GCM0335C1E330JA16# |
|        |                    |                    | 5.0pF  | ±0.25pF            | GCM0335C1E5R0CA16# |        |               |         | 36pF | ±1%                | GCM0335C1E360FA16# |
|        |                    |                    | 5.1pF  | ±0.5pF             | GCM0335C1E5R1DA16# |        |               |         |      | ±2%                | GCM0335C1E360GA16# |
|        |                    |                    | 5.6pF  | ±0.25pF            | GCM0335C1E5R6CA16# |        |               |         |      | ±5%                | GCM0335C1E360JA16# |
|        |                    |                    |        | ±0.5pF             | GCM0335C1E5R6DA16# |        |               |         | 39pF | ±1%                | GCM0335C1E390FA16# |
|        |                    |                    | 6.0pF  | ±0.5pF             | GCM0335C1E6R0DA16# |        |               |         |      | ±2%                | GCM0335C1E390GA16# |
|        |                    |                    | 6.2pF  | ±0.5pF             | GCM0335C1E6R2DA16# |        |               |         |      | ±5%                | GCM0335C1E390JA16# |
|        |                    |                    | 6.8pF  | ±0.25pF            | GCM0335C1E6R8CA16# |        |               |         | 43pF | ±1%                | GCM0335C1E430FA16# |
|        |                    |                    |        | ±0.5pF             | GCM0335C1E6R8DA16# |        |               |         |      | ±2%                | GCM0335C1E430GA16# |
|        |                    |                    | 7.0pF  | ±0.5pF             | GCM0335C1E7R0DA16# |        |               |         |      | ±5%                | GCM0335C1E430JA16# |
|        |                    |                    | 7.5pF  | ±0.5pF             | GCM0335C1E7R5DA16# |        |               |         | 47pF | ±1%                | GCM0335C1E470FA16# |
|        |                    |                    | 8.0pF  | ±0.5pF             | GCM0335C1E8R0DA16# |        |               |         |      | ±2%                | GCM0335C1E470GA16# |
|        |                    |                    | 8.2pF  | ±0.25pF            | GCM0335C1E8R2CA16# |        |               |         |      | ±5%                | GCM0335C1E470JA16# |
|        |                    |                    |        | ±0.5pF             | GCM0335C1E8R2DA16# |        |               |         | 51pF | ±1%                | GCM0335C1E510FA16# |
|        |                    |                    | 9.0pF  | ±0.5pF             | GCM0335C1E9R0DA16# |        |               |         |      | ±2%                | GCM0335C1E510GA16# |
|        |                    |                    | 9.1pF  | ±0.5pF             | GCM0335C1E9R1DA16# |        |               |         |      | ±5%                | GCM0335C1E510JA16# |
|        |                    |                    | 10pF   | ±1%                | GCM0335C1E100FA16# |        |               |         | 56pF | ±1%                | GCM0335C1E560FA16# |
|        |                    |                    |        | ±2%                | GCM0335C1E100GA16# |        |               |         |      | ±2%                | GCM0335C1E560GA16# |
|        |                    |                    |        | ±5%                | GCM0335C1E100JA16# |        |               |         |      | ±5%                | GCM0335C1E560JA16# |
|        |                    |                    | 11pF   | ±1%                | GCM0335C1E110FA16# |        |               |         | 62pF | ±1%                | GCM0335C1E620FA16# |
|        |                    |                    |        | ±2%                | GCM0335C1E110GA16# |        |               |         |      | ±2%                | GCM0335C1E620GA16# |
|        |                    |                    |        | ±5%                | GCM0335C1E110JA16# |        |               |         |      | ±5%                | GCM0335C1E620JA16# |
|        |                    |                    | 12pF   | ±1%                | GCM0335C1E120FA16# |        |               |         | 68pF | ±1%                | GCM0335C1E680FA16# |
|        |                    |                    |        | ±2%                | GCM0335C1E120GA16# |        |               |         |      | ±2%                | GCM0335C1E680GA16# |
| ±5%    | GCM0335C1E120JA16# | ±5%                |        | GCM0335C1E680JA16# |                    |        |               |         |      |                    |                    |
| 13pF   | ±1%                | GCM0335C1E130FA16# | 75pF   | ±1%                | GCM0335C1E750FA16# |        |               |         |      |                    |                    |
|        | ±2%                | GCM0335C1E130GA16# |        | ±2%                | GCM0335C1E750GA16# |        |               |         |      |                    |                    |
|        | ±5%                | GCM0335C1E130JA16# |        | ±5%                | GCM0335C1E750JA16# |        |               |         |      |                    |                    |

Part number # indicates the package specification code.

GRT Series  
 GCM Series  
 GC3 Series  
 GCJ Series  
 GCQ Series  
 GCD Series  
 GCE Series  
 NMF Series  
 KCM Series  
 KC3 Series  
 KCA Series  
 GCB Series  
 GCG Series  
 ⚠Caution / Notice

# GCM Series Temperature Compensating Type Part Number List

(→ 0.6×0.3mm)

| T max. | Rated Voltage | TC Code | Cap.  | Tol. | Part Number        |
|--------|---------------|---------|-------|------|--------------------|
| 0.33mm | 25Vdc         | COG     | 82pF  | ±1%  | GCM0335C1E820FA16# |
|        |               |         |       | ±2%  | GCM0335C1E820GA16# |
|        |               |         |       | ±5%  | GCM0335C1E820JA16# |
|        |               |         | 91pF  | ±1%  | GCM0335C1E910FA16# |
|        |               |         |       | ±2%  | GCM0335C1E910GA16# |
|        |               |         |       | ±5%  | GCM0335C1E910JA16# |
|        |               |         | 100pF | ±1%  | GCM0335C1E101FA16# |
|        |               |         |       | ±2%  | GCM0335C1E101GA16# |
|        |               |         |       | ±5%  | GCM0335C1E101JA16# |

| T max.  | Rated Voltage      | TC Code            | Cap.    | Tol.    | Part Number        |
|---------|--------------------|--------------------|---------|---------|--------------------|
| 0.55mm  | 50Vdc              | COG                | 1.0pF   | ±0.1pF  | GCM1555C1H1R0BA16# |
|         |                    |                    |         | ±0.25pF | GCM1555C1H1R0CA16# |
|         |                    |                    |         | ±5%     | GCM1555C1H1R0JA16# |
|         |                    |                    | 1.1pF   | ±0.1pF  | GCM1555C1H1R1BA16# |
|         |                    |                    |         | ±0.25pF | GCM1555C1H1R1CA16# |
|         |                    |                    | 1.2pF   | ±0.1pF  | GCM1555C1H1R2BA16# |
|         |                    |                    |         | ±0.25pF | GCM1555C1H1R2CA16# |
|         |                    |                    | 1.3pF   | ±0.1pF  | GCM1555C1H1R3BA16# |
|         |                    |                    |         | ±0.25pF | GCM1555C1H1R3CA16# |
|         |                    |                    | 1.4pF   | ±0.1pF  | GCM1555C1H1R4BA16# |
|         |                    |                    |         | ±0.25pF | GCM1555C1H1R4CA16# |
|         |                    |                    | 1.5pF   | ±0.05pF | GCM1555C1H1R5WA16# |
|         |                    |                    |         | ±0.1pF  | GCM1555C1H1R5BA16# |
|         |                    |                    |         | ±0.25pF | GCM1555C1H1R5CA16# |
|         |                    |                    |         | ±5%     | GCM1555C1H1R5JA16# |
|         |                    |                    | 1.6pF   | ±0.05pF | GCM1555C1H1R6WA16# |
|         |                    |                    |         | ±0.1pF  | GCM1555C1H1R6BA16# |
|         |                    |                    |         | ±0.25pF | GCM1555C1H1R6CA16# |
|         |                    |                    |         | 1.7pF   | ±0.1pF             |
|         |                    |                    | ±0.25pF |         | GCM1555C1H1R7CA16# |
|         |                    |                    | 1.8pF   | ±0.05pF | GCM1555C1H1R8WA16# |
|         |                    |                    |         | ±0.1pF  | GCM1555C1H1R8BA16# |
|         |                    |                    |         | ±0.25pF | GCM1555C1H1R8CA16# |
|         |                    |                    | 1.9pF   | ±0.1pF  | GCM1555C1H1R9BA16# |
|         |                    |                    |         | ±0.25pF | GCM1555C1H1R9CA16# |
|         |                    |                    | 2.0pF   | ±0.1pF  | GCM1555C1H2R0BA16# |
|         |                    |                    |         | ±0.25pF | GCM1555C1H2R0CA16# |
|         |                    |                    | 2.1pF   | ±0.1pF  | GCM1555C1H2R1BA16# |
|         |                    |                    |         | ±0.25pF | GCM1555C1H2R1CA16# |
|         |                    |                    | 2.2pF   | ±0.05pF | GCM1555C1H2R2WA16# |
|         |                    |                    |         | ±0.1pF  | GCM1555C1H2R2BA16# |
|         |                    |                    |         | ±0.25pF | GCM1555C1H2R2CA16# |
|         |                    |                    | 2.3pF   | ±0.1pF  | GCM1555C1H2R3BA16# |
|         |                    |                    |         | ±0.25pF | GCM1555C1H2R3CA16# |
|         |                    |                    | 2.4pF   | ±0.1pF  | GCM1555C1H2R4BA16# |
|         |                    |                    |         | ±0.25pF | GCM1555C1H2R4CA16# |
|         |                    |                    | 2.5pF   | ±0.1pF  | GCM1555C1H2R5BA16# |
|         |                    |                    |         | ±0.25pF | GCM1555C1H2R5CA16# |
|         |                    |                    | 2.6pF   | ±0.1pF  | GCM1555C1H2R6BA16# |
|         |                    |                    |         | ±0.25pF | GCM1555C1H2R6CA16# |
|         |                    |                    | 2.7pF   | ±0.05pF | GCM1555C1H2R7WA16# |
|         |                    |                    |         | ±0.1pF  | GCM1555C1H2R7BA16# |
|         |                    |                    |         | ±0.25pF | GCM1555C1H2R7CA16# |
|         |                    |                    | 2.8pF   | ±0.1pF  | GCM1555C1H2R8BA16# |
|         |                    |                    |         | ±0.25pF | GCM1555C1H2R8CA16# |
|         |                    |                    | 2.9pF   | ±0.1pF  | GCM1555C1H2R9BA16# |
|         |                    |                    |         | ±0.25pF | GCM1555C1H2R9CA16# |
|         |                    |                    | 3.0pF   | ±0.1pF  | GCM1555C1H3R0BA16# |
| ±0.25pF | GCM1555C1H3R0CA16# |                    |         |         |                    |
| 3.1pF   | ±0.1pF             | GCM1555C1H3R1BA16# |         |         |                    |
|         | ±0.25pF            | GCM1555C1H3R1CA16# |         |         |                    |
| 3.2pF   | ±0.1pF             | GCM1555C1H3R2BA16# |         |         |                    |
|         | ±0.25pF            | GCM1555C1H3R2CA16# |         |         |                    |
| 3.3pF   | ±0.1pF             | GCM1555C1H3R3BA16# |         |         |                    |

1.0×0.5mm

| T max.  | Rated Voltage      | TC Code            | Cap.   | Tol.    | Part Number        |
|---------|--------------------|--------------------|--------|---------|--------------------|
| 0.55mm  | 50Vdc              | COG                | 0.10pF | ±0.1pF  | GCM1555C1HR10BA16# |
|         |                    |                    |        | ±20%    | GCM1555C1HR20MA16# |
|         |                    |                    | 0.11pF | ±0.1pF  | GCM1555C1HR11BA16# |
|         |                    |                    |        | ±20%    | GCM1555C1HR20MA16# |
|         |                    |                    | 0.12pF | ±0.1pF  | GCM1555C1HR12BA16# |
|         |                    |                    |        | ±20%    | GCM1555C1HR20MA16# |
|         |                    |                    | 0.13pF | ±0.1pF  | GCM1555C1HR13BA16# |
|         |                    |                    |        | ±20%    | GCM1555C1HR20MA16# |
|         |                    |                    | 0.15pF | ±0.1pF  | GCM1555C1HR15BA16# |
|         |                    |                    |        | ±20%    | GCM1555C1HR20MA16# |
|         |                    |                    | 0.16pF | ±0.1pF  | GCM1555C1HR16BA16# |
|         |                    |                    |        | ±20%    | GCM1555C1HR20MA16# |
|         |                    |                    | 0.18pF | ±0.1pF  | GCM1555C1HR18BA16# |
|         |                    |                    |        | ±20%    | GCM1555C1HR20MA16# |
|         |                    |                    | 0.20pF | ±0.1pF  | GCM1555C1HR20BA16# |
|         |                    |                    |        | ±20%    | GCM1555C1HR20MA16# |
|         |                    |                    | 0.22pF | ±0.1pF  | GCM1555C1HR22BA16# |
|         |                    |                    |        | ±20%    | GCM1555C1HR20MA16# |
|         |                    |                    | 0.24pF | ±0.1pF  | GCM1555C1HR24BA16# |
|         |                    |                    |        | ±20%    | GCM1555C1HR20MA16# |
|         |                    |                    | 0.30pF | ±0.05pF | GCM1555C1HR30WA16# |
|         |                    |                    |        | ±0.1pF  | GCM1555C1HR30BA16# |
|         |                    |                    | 0.33pF | ±0.1pF  | GCM1555C1HR33BA16# |
|         |                    |                    |        | ±20%    | GCM1555C1HR20MA16# |
|         |                    |                    | 0.36pF | ±0.1pF  | GCM1555C1HR36BA16# |
|         |                    |                    |        | ±20%    | GCM1555C1HR20MA16# |
|         |                    |                    | 0.39pF | ±0.1pF  | GCM1555C1HR39BA16# |
|         |                    |                    |        | ±20%    | GCM1555C1HR20MA16# |
|         |                    |                    | 0.40pF | ±0.05pF | GCM1555C1HR40WA16# |
|         |                    |                    |        | ±0.1pF  | GCM1555C1HR40BA16# |
|         |                    |                    | 0.43pF | ±0.1pF  | GCM1555C1HR43BA16# |
|         |                    |                    |        | ±20%    | GCM1555C1HR20MA16# |
|         |                    |                    | 0.47pF | ±0.1pF  | GCM1555C1HR47BA16# |
|         |                    |                    |        | ±0.25pF | GCM1555C1HR47CA16# |
|         |                    |                    | 0.50pF | ±0.05pF | GCM1555C1HR50WA16# |
|         |                    |                    |        | ±0.1pF  | GCM1555C1HR50BA16# |
|         |                    |                    |        | ±0.25pF | GCM1555C1HR50CA16# |
|         |                    |                    | 0.51pF | ±0.1pF  | GCM1555C1HR51BA16# |
|         |                    |                    |        | ±20%    | GCM1555C1HR20MA16# |
|         |                    |                    | 0.56pF | ±0.1pF  | GCM1555C1HR56BA16# |
|         |                    |                    |        | ±20%    | GCM1555C1HR20MA16# |
|         |                    |                    | 0.60pF | ±0.05pF | GCM1555C1HR60WA16# |
|         |                    |                    |        | ±0.1pF  | GCM1555C1HR60BA16# |
|         |                    |                    | 0.62pF | ±0.1pF  | GCM1555C1HR62BA16# |
|         |                    |                    |        | ±20%    | GCM1555C1HR20MA16# |
|         |                    |                    | 0.68pF | ±0.1pF  | GCM1555C1HR68BA16# |
|         |                    |                    |        | ±20%    | GCM1555C1HR20MA16# |
|         |                    |                    | 0.70pF | ±0.05pF | GCM1555C1HR70WA16# |
|         |                    |                    |        | ±0.1pF  | GCM1555C1HR70BA16# |
|         |                    |                    | 0.75pF | ±0.1pF  | GCM1555C1HR75BA16# |
| ±0.25pF | GCM1555C1HR75CA16# |                    |        |         |                    |
| 0.80pF  | ±0.05pF            | GCM1555C1HR80WA16# |        |         |                    |
|         | ±0.1pF             | GCM1555C1HR80BA16# |        |         |                    |
| 0.82pF  | ±0.1pF             | GCM1555C1HR82BA16# |        |         |                    |
|         | ±20%               | GCM1555C1HR20MA16# |        |         |                    |
| 0.90pF  | ±0.05pF            | GCM1555C1HR90WA16# |        |         |                    |
|         | ±0.1pF             | GCM1555C1HR90BA16# |        |         |                    |
| 0.91pF  | ±0.1pF             | GCM1555C1HR91BA16# |        |         |                    |

Part number # indicates the package specification code.

GRT Series  
 GCM Series  
 GC3 Series  
 GCJ Series  
 GCQ Series  
 GCD Series  
 GCE Series  
 NMF Series  
 KCM Series  
 KC3 Series  
 KCA Series  
 GCB Series  
 GCG Series  
 ⚠Caution /Notice

# GCM Series Temperature Compensating Type Part Number List

(→ 1.0×0.5mm)

| T max. | Rated Voltage | TC Code | Cap.  | Tol.    | Part Number        |
|--------|---------------|---------|-------|---------|--------------------|
| 0.55mm | 50Vdc         | COG     | 3.3pF | ±0.25pF | GCM1555C1H3R3CA16# |
|        |               |         |       | ±2%     | GCM1555C1H3R3GA16# |
|        |               |         | 3.4pF | ±0.1pF  | GCM1555C1H3R4BA16# |
|        |               |         |       | ±0.25pF | GCM1555C1H3R4CA16# |
|        |               |         | 3.5pF | ±0.1pF  | GCM1555C1H3R5BA16# |
|        |               |         |       | ±0.25pF | GCM1555C1H3R5CA16# |
|        |               |         | 3.6pF | ±0.1pF  | GCM1555C1H3R6BA16# |
|        |               |         |       | ±0.25pF | GCM1555C1H3R6CA16# |
|        |               |         | 3.7pF | ±0.25pF | GCM1555C1H3R7CA16# |
|        |               |         | 3.8pF | ±0.25pF | GCM1555C1H3R8CA16# |
|        |               |         | 3.9pF | ±0.1pF  | GCM1555C1H3R9BA16# |
|        |               |         |       | ±0.25pF | GCM1555C1H3R9CA16# |
|        |               |         | 4.0pF | ±0.1pF  | GCM1555C1H4R0BA16# |
|        |               |         |       | ±0.25pF | GCM1555C1H4R0CA16# |
|        |               |         |       | ±2%     | GCM1555C1H4R0GA16# |
|        |               |         |       | ±5%     | GCM1555C1H4R0JA16# |
|        |               |         | 4.1pF | ±0.25pF | GCM1555C1H4R1CA16# |
|        |               |         | 4.2pF | ±0.1pF  | GCM1555C1H4R2BA16# |
|        |               |         |       | ±0.25pF | GCM1555C1H4R2CA16# |
|        |               |         | 4.3pF | ±0.1pF  | GCM1555C1H4R3BA16# |
|        |               |         |       | ±0.25pF | GCM1555C1H4R3CA16# |
|        |               |         | 4.4pF | ±0.25pF | GCM1555C1H4R4CA16# |
|        |               |         | 4.5pF | ±0.25pF | GCM1555C1H4R5CA16# |
|        |               |         | 4.6pF | ±0.25pF | GCM1555C1H4R6CA16# |
|        |               |         | 4.7pF | ±0.05pF | GCM1555C1H4R7WA16# |
|        |               |         |       | ±0.1pF  | GCM1555C1H4R7BA16# |
|        |               |         |       | ±0.25pF | GCM1555C1H4R7CA16# |
|        |               |         | 4.8pF | ±0.25pF | GCM1555C1H4R8CA16# |
|        |               |         | 4.9pF | ±0.25pF | GCM1555C1H4R9CA16# |
|        |               |         | 5.0pF | ±0.1pF  | GCM1555C1H5R0BA16# |
|        |               |         |       | ±0.25pF | GCM1555C1H5R0CA16# |
|        |               |         |       | ±1%     | GCM1555C1H5R0FA16# |
|        |               |         | 5.1pF | ±0.1pF  | GCM1555C1H5R1BA16# |
|        |               |         |       | ±0.25pF | GCM1555C1H5R1CA16# |
|        |               |         |       | ±0.5pF  | GCM1555C1H5R1DA16# |
|        |               |         |       | ±1%     | GCM1555C1H5R1FA16# |
|        |               |         | 5.2pF | ±0.25pF | GCM1555C1H5R2CA16# |
|        |               |         |       | ±0.5pF  | GCM1555C1H5R2DA16# |
|        |               |         | 5.3pF | ±0.05pF | GCM1555C1H5R3WA16# |
|        |               |         |       | ±0.5pF  | GCM1555C1H5R3DA16# |
|        |               |         | 5.4pF | ±0.5pF  | GCM1555C1H5R4DA16# |
|        |               |         | 5.5pF | ±0.05pF | GCM1555C1H5R5WA16# |
|        |               |         |       | ±0.5pF  | GCM1555C1H5R5DA16# |
|        |               |         | 5.6pF | ±0.1pF  | GCM1555C1H5R6BA16# |
|        |               |         |       | ±0.25pF | GCM1555C1H5R6CA16# |
|        |               |         |       | ±0.5pF  | GCM1555C1H5R6DA16# |
|        |               |         | 5.7pF | ±0.5pF  | GCM1555C1H5R7DA16# |
|        |               |         | 5.8pF | ±0.5pF  | GCM1555C1H5R8DA16# |
|        |               |         | 5.9pF | ±0.5pF  | GCM1555C1H5R9DA16# |
|        |               |         | 6.0pF | ±0.1pF  | GCM1555C1H6R0BA16# |
|        |               |         |       | ±0.25pF | GCM1555C1H6R0CA16# |
|        |               |         |       | ±0.5pF  | GCM1555C1H6R0DA16# |
|        |               |         |       | ±1%     | GCM1555C1H6R0FA16# |
|        |               |         | 6.1pF | ±0.5pF  | GCM1555C1H6R1DA16# |

| T max. | Rated Voltage | TC Code | Cap.  | Tol.    | Part Number        |
|--------|---------------|---------|-------|---------|--------------------|
| 0.55mm | 50Vdc         | COG     | 6.2pF | ±0.1pF  | GCM1555C1H6R2BA16# |
|        |               |         |       | ±0.25pF | GCM1555C1H6R2CA16# |
|        |               |         |       | ±0.5pF  | GCM1555C1H6R2DA16# |
|        |               |         | 6.3pF | ±0.5pF  | GCM1555C1H6R3DA16# |
|        |               |         | 6.4pF | ±0.5pF  | GCM1555C1H6R4DA16# |
|        |               |         | 6.5pF | ±0.05pF | GCM1555C1H6R5WA16# |
|        |               |         |       | ±0.5pF  | GCM1555C1H6R5DA16# |
|        |               |         | 6.6pF | ±0.5pF  | GCM1555C1H6R6DA16# |
|        |               |         | 6.7pF | ±0.05pF | GCM1555C1H6R7WA16# |
|        |               |         |       | ±0.5pF  | GCM1555C1H6R7DA16# |
|        |               |         | 6.8pF | ±0.05pF | GCM1555C1H6R8WA16# |
|        |               |         |       | ±0.1pF  | GCM1555C1H6R8BA16# |
|        |               |         |       | ±0.25pF | GCM1555C1H6R8CA16# |
|        |               |         |       | ±0.5pF  | GCM1555C1H6R8DA16# |
|        |               |         |       | ±1%     | GCM1555C1H6R8FA16# |
|        |               |         | 6.9pF | ±0.5pF  | GCM1555C1H6R9DA16# |
|        |               |         | 7.0pF | ±0.05pF | GCM1555C1H7R0WA16# |
|        |               |         |       | ±0.1pF  | GCM1555C1H7R0BA16# |
|        |               |         |       | ±0.25pF | GCM1555C1H7R0CA16# |
|        |               |         |       | ±0.5pF  | GCM1555C1H7R0DA16# |
|        |               |         |       | ±1%     | GCM1555C1H7R0FA16# |
|        |               |         | 7.1pF | ±0.5pF  | GCM1555C1H7R1DA16# |
|        |               |         | 7.2pF | ±0.25pF | GCM1555C1H7R2CA16# |
|        |               |         |       | ±0.5pF  | GCM1555C1H7R2DA16# |
|        |               |         | 7.3pF | ±0.5pF  | GCM1555C1H7R3DA16# |
|        |               |         | 7.4pF | ±0.5pF  | GCM1555C1H7R4DA16# |
|        |               |         | 7.5pF | ±0.1pF  | GCM1555C1H7R5BA16# |
|        |               |         |       | ±0.25pF | GCM1555C1H7R5CA16# |
|        |               |         |       | ±0.5pF  | GCM1555C1H7R5DA16# |
|        |               |         | 7.6pF | ±0.5pF  | GCM1555C1H7R6DA16# |
|        |               |         | 7.7pF | ±0.5pF  | GCM1555C1H7R7DA16# |
|        |               |         | 7.8pF | ±0.25pF | GCM1555C1H7R8CA16# |
|        |               |         |       | ±0.5pF  | GCM1555C1H7R8DA16# |
|        |               |         | 7.9pF | ±0.5pF  | GCM1555C1H7R9DA16# |
|        |               |         | 8.0pF | ±0.05pF | GCM1555C1H8R0WA16# |
|        |               |         |       | ±0.1pF  | GCM1555C1H8R0BA16# |
|        |               |         |       | ±0.25pF | GCM1555C1H8R0CA16# |
|        |               |         |       | ±0.5pF  | GCM1555C1H8R0DA16# |
|        |               |         |       | ±1%     | GCM1555C1H8R0FA16# |
|        |               |         | 8.1pF | ±0.5pF  | GCM1555C1H8R1DA16# |
|        |               |         | 8.2pF | ±0.1pF  | GCM1555C1H8R2BA16# |
|        |               |         |       | ±0.25pF | GCM1555C1H8R2CA16# |
|        |               |         |       | ±0.5pF  | GCM1555C1H8R2DA16# |
|        |               |         | 8.3pF | ±0.5pF  | GCM1555C1H8R3DA16# |
|        |               |         | 8.4pF | ±0.1pF  | GCM1555C1H8R4BA16# |
|        |               |         |       | ±0.5pF  | GCM1555C1H8R4DA16# |
|        |               |         | 8.5pF | ±0.5pF  | GCM1555C1H8R5DA16# |
|        |               |         | 8.6pF | ±0.5pF  | GCM1555C1H8R6DA16# |
|        |               |         | 8.7pF | ±0.1pF  | GCM1555C1H8R7BA16# |
|        |               |         |       | ±0.5pF  | GCM1555C1H8R7DA16# |
|        |               |         | 8.8pF | ±0.5pF  | GCM1555C1H8R8DA16# |
|        |               |         | 8.9pF | ±0.5pF  | GCM1555C1H8R9DA16# |
|        |               |         | 9.0pF | ±0.05pF | GCM1555C1H9R0WA16# |
|        |               |         |       | ±0.1pF  | GCM1555C1H9R0BA16# |

Part number # indicates the package specification code.

GRT Series  
 GCM Series  
 GC3 Series  
 GCJ Series  
 GCQ Series  
 GCD Series  
 GCE Series  
 NMF Series  
 KCM Series  
 KC3 Series  
 KCA Series  
 GCB Series  
 GCG Series  
 ⚠Caution /Notice

# GCM Series Temperature Compensating Type Part Number List

(→ 1.0×0.5mm)

| T max. | Rated Voltage | TC Code | Cap.   | Tol.               | Part Number        | T max. | Rated Voltage | TC Code | Cap.  | Tol.               | Part Number        |
|--------|---------------|---------|--------|--------------------|--------------------|--------|---------------|---------|-------|--------------------|--------------------|
| 0.55mm | 50Vdc         | COG     | 9.0pF  | ±0.25pF            | GCM1555C1H9R0CA16# | 0.55mm | 50Vdc         | COG     | 36pF  | ±1%                | GCM1555C1H360FA16# |
|        |               |         |        | ±0.5pF             | GCM1555C1H9R0DA16# |        |               |         |       | ±2%                | GCM1555C1H360GA16# |
|        |               |         | 9.1pF  | ±0.1pF             | GCM1555C1H9R1BA16# |        |               |         |       | ±5%                | GCM1555C1H360JA16# |
|        |               |         |        | ±0.25pF            | GCM1555C1H9R1CA16# |        |               |         | 39pF  | ±1%                | GCM1555C1H390FA16# |
|        |               |         | ±0.5pF | GCM1555C1H9R1DA16# | ±2%                |        |               |         |       | GCM1555C1H390GA16# |                    |
|        |               |         | 9.2pF  | ±0.25pF            | GCM1555C1H9R2CA16# |        |               |         | ±5%   | GCM1555C1H390JA16# |                    |
|        |               |         |        | ±0.5pF             | GCM1555C1H9R2DA16# |        |               |         | 43pF  | ±1%                | GCM1555C1H430FA16# |
|        |               |         | 9.3pF  | ±0.5pF             | GCM1555C1H9R3DA16# |        |               |         |       | ±2%                | GCM1555C1H430GA16# |
|        |               |         | 9.4pF  | ±0.5pF             | GCM1555C1H9R4DA16# |        |               |         | ±5%   | GCM1555C1H430JA16# |                    |
|        |               |         | 9.5pF  | ±0.5pF             | GCM1555C1H9R5DA16# |        |               |         | 47pF  | ±1%                | GCM1555C1H470FA16# |
|        |               |         | 9.6pF  | ±0.5pF             | GCM1555C1H9R6DA16# |        |               |         |       | ±2%                | GCM1555C1H470GA16# |
|        |               |         | 9.7pF  | ±0.5pF             | GCM1555C1H9R7DA16# |        |               |         |       | ±5%                | GCM1555C1H470JA16# |
|        |               |         | 9.8pF  | ±0.5pF             | GCM1555C1H9R8DA16# |        |               |         | 51pF  | ±1%                | GCM1555C1H510FA16# |
|        |               |         | 9.9pF  | ±0.5pF             | GCM1555C1H9R9DA16# |        |               |         |       | ±2%                | GCM1555C1H510GA16# |
|        |               |         | 10pF   | ±1%                | GCM1555C1H100FA16# |        |               |         |       | ±5%                | GCM1555C1H510JA16# |
|        |               |         |        | ±2%                | GCM1555C1H100GA16# |        |               |         | 56pF  | ±1%                | GCM1555C1H560FA16# |
|        |               |         |        | ±2.5%              | GCM1555C1H100RA16# |        |               |         |       | ±2%                | GCM1555C1H560GA16# |
|        |               |         |        | ±5%                | GCM1555C1H100JA16# |        |               |         |       | ±5%                | GCM1555C1H560JA16# |
|        |               |         | 11pF   | ±1%                | GCM1555C1H110FA16# |        |               |         | 62pF  | ±1%                | GCM1555C1H620FA16# |
|        |               |         |        | ±2%                | GCM1555C1H110GA16# |        |               |         |       | ±2%                | GCM1555C1H620GA16# |
|        |               |         |        | ±5%                | GCM1555C1H110JA16# |        |               |         |       | ±5%                | GCM1555C1H620JA16# |
|        |               |         | 12pF   | ±1%                | GCM1555C1H120FA16# |        |               |         | 68pF  | ±1%                | GCM1555C1H680FA16# |
|        |               |         |        | ±2%                | GCM1555C1H120GA16# |        |               |         |       | ±2%                | GCM1555C1H680GA16# |
|        |               |         |        | ±5%                | GCM1555C1H120JA16# |        |               |         |       | ±5%                | GCM1555C1H680JA16# |
|        |               |         | 13pF   | ±1%                | GCM1555C1H130FA16# |        |               |         | 75pF  | ±1%                | GCM1555C1H750FA16# |
|        |               |         |        | ±2%                | GCM1555C1H130GA16# |        |               |         |       | ±2%                | GCM1555C1H750GA16# |
|        |               |         |        | ±5%                | GCM1555C1H130JA16# |        |               |         |       | ±5%                | GCM1555C1H750JA16# |
|        |               |         | 15pF   | ±1%                | GCM1555C1H150FA16# |        |               |         | 82pF  | ±1%                | GCM1555C1H820FA16# |
|        |               |         |        | ±2%                | GCM1555C1H150GA16# |        |               |         |       | ±2%                | GCM1555C1H820GA16# |
|        |               |         |        | ±5%                | GCM1555C1H150JA16# |        |               |         |       | ±5%                | GCM1555C1H820JA16# |
|        |               |         | 16pF   | ±1%                | GCM1555C1H160FA16# |        |               |         | 91pF  | ±1%                | GCM1555C1H910FA16# |
|        |               |         |        | ±2%                | GCM1555C1H160GA16# |        |               |         |       | ±2%                | GCM1555C1H910GA16# |
|        |               |         |        | ±5%                | GCM1555C1H160JA16# |        |               |         |       | ±5%                | GCM1555C1H910JA16# |
|        |               |         | 18pF   | ±1%                | GCM1555C1H180FA16# |        |               |         | 100pF | ±1%                | GCM1555C1H101FA16# |
|        |               |         |        | ±2%                | GCM1555C1H180GA16# |        |               |         |       | ±2%                | GCM1555C1H101GA16# |
|        |               |         |        | ±5%                | GCM1555C1H180JA16# |        |               |         |       | ±5%                | GCM1555C1H101JA16# |
|        |               |         | 20pF   | ±1%                | GCM1555C1H200FA16# |        |               |         | 110pF | ±1%                | GCM1555C1H111FA16# |
|        |               |         |        | ±2%                | GCM1555C1H200GA16# |        |               |         |       | ±2%                | GCM1555C1H111GA16# |
|        |               |         |        | ±5%                | GCM1555C1H200JA16# |        |               |         |       | ±5%                | GCM1555C1H111JA16# |
|        |               |         | 22pF   | ±1%                | GCM1555C1H220FA16# |        |               |         | 120pF | ±1%                | GCM1555C1H121FA16# |
|        |               |         |        | ±2%                | GCM1555C1H220GA16# |        |               |         |       | ±2%                | GCM1555C1H121GA16# |
|        |               |         |        | ±5%                | GCM1555C1H220JA16# |        |               |         |       | ±5%                | GCM1555C1H121JA16# |
|        |               |         | 24pF   | ±1%                | GCM1555C1H240FA16# |        |               |         | 130pF | ±1%                | GCM1555C1H131FA16# |
|        |               |         |        | ±2%                | GCM1555C1H240GA16# |        |               |         |       | ±2%                | GCM1555C1H131GA16# |
|        |               |         |        | ±5%                | GCM1555C1H240JA16# |        |               |         |       | ±5%                | GCM1555C1H131JA16# |
|        |               |         | 27pF   | ±1%                | GCM1555C1H270FA16# |        |               |         | 150pF | ±1%                | GCM1555C1H151FA16# |
|        |               |         |        | ±2%                | GCM1555C1H270GA16# |        |               |         |       | ±2%                | GCM1555C1H151GA16# |
|        |               |         |        | ±5%                | GCM1555C1H270JA16# |        |               |         |       | ±5%                | GCM1555C1H151JA16# |
|        |               |         | 30pF   | ±1%                | GCM1555C1H300FA16# |        |               |         | 160pF | ±1%                | GCM1555C1H161FA16# |
|        |               |         |        | ±2%                | GCM1555C1H300GA16# |        |               |         |       | ±2%                | GCM1555C1H161GA16# |
|        |               |         |        | ±5%                | GCM1555C1H300JA16# |        |               |         |       | ±5%                | GCM1555C1H161JA16# |
|        |               |         | 33pF   | ±1%                | GCM1555C1H330FA16# |        |               |         | 180pF | ±1%                | GCM1555C1H181FA16# |
|        |               |         |        | ±2%                | GCM1555C1H330GA16# |        |               |         |       | ±2%                | GCM1555C1H181GA16# |
|        |               |         |        | ±5%                | GCM1555C1H330JA16# |        |               |         |       | ±5%                | GCM1555C1H181JA16# |

Part number # indicates the package specification code.

GRT Series  
 GCM Series  
 GC3 Series  
 GCJ Series  
 GCQ Series  
 GCD Series  
 GCE Series  
 NMF Series  
 KCM Series  
 KC3 Series  
 KCA Series  
 GCB Series  
 GCG Series  
 ⚠Caution / Notice

# GCM Series Temperature Compensating Type Part Number List

(→ 1.0×0.5mm)

| T max. | Rated Voltage | TC Code | Cap.   | Tol. | Part Number        |
|--------|---------------|---------|--------|------|--------------------|
| 0.55mm | 50Vdc         | COG     | 200pF  | ±1%  | GCM1555C1H201FA16# |
|        |               |         |        | ±2%  | GCM1555C1H201GA16# |
|        |               |         |        | ±5%  | GCM1555C1H201JA16# |
|        |               |         | 220pF  | ±1%  | GCM1555C1H221FA16# |
|        |               |         |        | ±2%  | GCM1555C1H221GA16# |
|        |               |         |        | ±5%  | GCM1555C1H221JA16# |
|        |               |         | 240pF  | ±1%  | GCM1555C1H241FA16# |
|        |               |         |        | ±2%  | GCM1555C1H241GA16# |
|        |               |         |        | ±5%  | GCM1555C1H241JA16# |
|        |               |         | 270pF  | ±1%  | GCM1555C1H271FA16# |
|        |               |         |        | ±2%  | GCM1555C1H271GA16# |
|        |               |         |        | ±5%  | GCM1555C1H271JA16# |
|        |               |         | 300pF  | ±1%  | GCM1555C1H301FA16# |
|        |               |         |        | ±2%  | GCM1555C1H301GA16# |
|        |               |         |        | ±5%  | GCM1555C1H301JA16# |
|        |               |         | 330pF  | ±1%  | GCM1555C1H331FA16# |
|        |               |         |        | ±2%  | GCM1555C1H331GA16# |
|        |               |         |        | ±5%  | GCM1555C1H331JA16# |
|        |               |         | 360pF  | ±1%  | GCM1555C1H361FA16# |
|        |               |         |        | ±2%  | GCM1555C1H361GA16# |
|        |               |         |        | ±5%  | GCM1555C1H361JA16# |
|        |               |         | 390pF  | ±1%  | GCM1555C1H391FA16# |
|        |               |         |        | ±2%  | GCM1555C1H391GA16# |
|        |               |         |        | ±5%  | GCM1555C1H391JA16# |
|        |               |         | 430pF  | ±1%  | GCM1555C1H431FA16# |
|        |               |         |        | ±2%  | GCM1555C1H431GA16# |
|        |               |         |        | ±5%  | GCM1555C1H431JA16# |
|        |               |         | 470pF  | ±1%  | GCM1555C1H471FA16# |
|        |               |         |        | ±2%  | GCM1555C1H471GA16# |
|        |               |         |        | ±5%  | GCM1555C1H471JA16# |
|        |               |         | 510pF  | ±1%  | GCM1555C1H511FA16# |
|        |               |         |        | ±2%  | GCM1555C1H511GA16# |
|        |               |         |        | ±5%  | GCM1555C1H511JA16# |
|        |               |         | 560pF  | ±1%  | GCM1555C1H561FA16# |
|        |               |         |        | ±2%  | GCM1555C1H561GA16# |
|        |               |         |        | ±5%  | GCM1555C1H561JA16# |
|        |               |         | 620pF  | ±1%  | GCM1555C1H621FA16# |
|        |               |         |        | ±2%  | GCM1555C1H621GA16# |
|        |               |         |        | ±5%  | GCM1555C1H621JA16# |
|        |               |         | 680pF  | ±1%  | GCM1555C1H681FA16# |
|        |               |         |        | ±2%  | GCM1555C1H681GA16# |
|        |               |         |        | ±5%  | GCM1555C1H681JA16# |
|        |               |         | 750pF  | ±1%  | GCM1555C1H751FA16# |
|        |               |         |        | ±2%  | GCM1555C1H751GA16# |
|        |               |         |        | ±5%  | GCM1555C1H751JA16# |
|        |               |         | 820pF  | ±1%  | GCM1555C1H821FA16# |
|        |               |         |        | ±2%  | GCM1555C1H821GA16# |
|        |               |         |        | ±5%  | GCM1555C1H821JA16# |
|        |               |         | 910pF  | ±1%  | GCM1555C1H911FA16# |
|        |               |         |        | ±2%  | GCM1555C1H911GA16# |
|        |               |         |        | ±5%  | GCM1555C1H911JA16# |
|        |               |         | 1000pF | ±1%  | GCM1555C1H102FA16# |
|        |               |         |        | ±2%  | GCM1555C1H102GA16# |
|        |               |         |        | ±5%  | GCM1555C1H102JA16# |

| T max. | Rated Voltage | TC Code            | Cap.   | Tol.    | Part Number        |
|--------|---------------|--------------------|--------|---------|--------------------|
| 0.55mm | 50Vdc         | X8G                | 0.10pF | ±0.1pF  | GCM1555G1HR10BA16# |
|        |               |                    |        | ±0.25pF | GCM1555G1HR10CA16# |
|        |               |                    | 0.20pF | ±0.1pF  | GCM1555G1HR20BA16# |
|        |               |                    |        | ±0.25pF | GCM1555G1HR20CA16# |
|        |               |                    | 0.30pF | ±0.1pF  | GCM1555G1HR30BA16# |
|        |               |                    |        | ±0.25pF | GCM1555G1HR30CA16# |
|        |               |                    | 0.40pF | ±0.1pF  | GCM1555G1HR40BA16# |
|        |               |                    |        | ±0.25pF | GCM1555G1HR40CA16# |
|        |               |                    | 0.50pF | ±0.1pF  | GCM1555G1HR50BA16# |
|        |               |                    |        | ±0.25pF | GCM1555G1HR50CA16# |
|        |               |                    | 0.60pF | ±0.1pF  | GCM1555G1HR60BA16# |
|        |               |                    |        | ±0.25pF | GCM1555G1HR60CA16# |
|        |               |                    | 0.70pF | ±0.1pF  | GCM1555G1HR70BA16# |
|        |               |                    |        | ±0.25pF | GCM1555G1HR70CA16# |
|        |               |                    | 0.75pF | ±0.1pF  | GCM1555G1HR75BA16# |
|        |               |                    |        | ±0.25pF | GCM1555G1HR75CA16# |
|        |               |                    | 0.80pF | ±0.1pF  | GCM1555G1HR80BA16# |
|        |               |                    |        | ±0.25pF | GCM1555G1HR80CA16# |
|        |               |                    | 0.90pF | ±0.1pF  | GCM1555G1HR90BA16# |
|        |               |                    |        | ±0.25pF | GCM1555G1HR90CA16# |
|        |               |                    | 1.0pF  | ±0.1pF  | GCM1555G1H1R0BA16# |
|        |               |                    |        | ±0.25pF | GCM1555G1H1R0CA16# |
|        |               |                    | 1.1pF  | ±0.1pF  | GCM1555G1H1R1BA16# |
|        |               |                    |        | ±0.25pF | GCM1555G1H1R1CA16# |
|        |               |                    | 1.2pF  | ±0.1pF  | GCM1555G1H1R2BA16# |
|        |               |                    |        | ±0.25pF | GCM1555G1H1R2CA16# |
|        |               |                    | 1.3pF  | ±0.1pF  | GCM1555G1H1R3BA16# |
|        |               |                    |        | ±0.25pF | GCM1555G1H1R3CA16# |
|        |               |                    | 1.4pF  | ±0.1pF  | GCM1555G1H1R4BA16# |
|        |               |                    |        | ±0.25pF | GCM1555G1H1R4CA16# |
|        |               |                    | 1.5pF  | ±0.1pF  | GCM1555G1H1R5BA16# |
|        |               |                    |        | ±0.25pF | GCM1555G1H1R5CA16# |
|        |               |                    | 1.6pF  | ±0.1pF  | GCM1555G1H1R6BA16# |
|        |               |                    |        | ±0.25pF | GCM1555G1H1R6CA16# |
|        |               |                    | 1.7pF  | ±0.1pF  | GCM1555G1H1R7BA16# |
|        |               |                    |        | ±0.25pF | GCM1555G1H1R7CA16# |
|        |               |                    | 1.8pF  | ±0.1pF  | GCM1555G1H1R8BA16# |
|        |               |                    |        | ±0.25pF | GCM1555G1H1R8CA16# |
|        |               |                    | 1.9pF  | ±0.1pF  | GCM1555G1H1R9BA16# |
|        |               |                    |        | ±0.25pF | GCM1555G1H1R9CA16# |
|        |               |                    | 2.0pF  | ±0.1pF  | GCM1555G1H2R0BA16# |
|        |               |                    |        | ±0.25pF | GCM1555G1H2R0CA16# |
| 2.1pF  | ±0.1pF        | GCM1555G1H2R1BA16# |        |         |                    |
|        | ±0.25pF       | GCM1555G1H2R1CA16# |        |         |                    |
| 2.2pF  | ±0.1pF        | GCM1555G1H2R2BA16# |        |         |                    |
|        | ±0.25pF       | GCM1555G1H2R2CA16# |        |         |                    |
| 2.3pF  | ±0.1pF        | GCM1555G1H2R3BA16# |        |         |                    |
|        | ±0.25pF       | GCM1555G1H2R3CA16# |        |         |                    |
| 2.4pF  | ±0.1pF        | GCM1555G1H2R4BA16# |        |         |                    |
|        | ±0.25pF       | GCM1555G1H2R4CA16# |        |         |                    |
| 2.5pF  | ±0.1pF        | GCM1555G1H2R5BA16# |        |         |                    |
|        | ±0.25pF       | GCM1555G1H2R5CA16# |        |         |                    |
| 2.6pF  | ±0.1pF        | GCM1555G1H2R6BA16# |        |         |                    |
|        | ±0.25pF       | GCM1555G1H2R6CA16# |        |         |                    |

GRT Series  
 GCM Series  
 GC3 Series  
 GCJ Series  
 GCQ Series  
 GCD Series  
 GCE Series  
 NMF Series  
 KCM Series  
 KC3 Series  
 KCA Series  
 GCB Series  
 GCG Series  
 ⚠Caution / Notice

Part number # indicates the package specification code.



# GCM Series Temperature Compensating Type Part Number List

(→ 1.0×0.5mm)

| T max. | Rated Voltage | TC Code            | Cap.  | Tol.    | Part Number        | T max. | Rated Voltage | TC Code | Cap.  | Tol.    | Part Number        |
|--------|---------------|--------------------|-------|---------|--------------------|--------|---------------|---------|-------|---------|--------------------|
| 0.55mm | 50Vdc         | X8G                | 2.7pF | ±0.1pF  | GCM1555G1H2R7BA16# | 0.55mm | 50Vdc         | X8G     | 5.4pF | ±0.1pF  | GCM1555G1H5R4BA16# |
|        |               |                    |       | ±0.25pF | GCM1555G1H2R7CA16# |        |               |         |       | ±0.25pF | GCM1555G1H5R4CA16# |
|        |               |                    | 2.8pF | ±0.1pF  | GCM1555G1H2R8BA16# |        |               |         | 5.5pF | ±0.1pF  | GCM1555G1H5R5BA16# |
|        |               |                    |       | ±0.25pF | GCM1555G1H2R8CA16# |        |               |         |       | ±0.25pF | GCM1555G1H5R5CA16# |
|        |               |                    | 2.9pF | ±0.1pF  | GCM1555G1H2R9BA16# |        |               |         | 5.6pF | ±0.1pF  | GCM1555G1H5R6BA16# |
|        |               |                    |       | ±0.25pF | GCM1555G1H2R9CA16# |        |               |         |       | ±0.25pF | GCM1555G1H5R6CA16# |
|        |               |                    | 3.0pF | ±0.1pF  | GCM1555G1H3R0BA16# |        |               |         | 5.7pF | ±0.1pF  | GCM1555G1H5R7BA16# |
|        |               |                    |       | ±0.25pF | GCM1555G1H3R0CA16# |        |               |         |       | ±0.25pF | GCM1555G1H5R7CA16# |
|        |               |                    | 3.1pF | ±0.1pF  | GCM1555G1H3R1BA16# |        |               |         | 5.8pF | ±0.1pF  | GCM1555G1H5R8BA16# |
|        |               |                    |       | ±0.25pF | GCM1555G1H3R1CA16# |        |               |         |       | ±0.25pF | GCM1555G1H5R8CA16# |
|        |               |                    | 3.2pF | ±0.1pF  | GCM1555G1H3R2BA16# |        |               |         | 5.9pF | ±0.1pF  | GCM1555G1H5R9BA16# |
|        |               |                    |       | ±0.25pF | GCM1555G1H3R2CA16# |        |               |         |       | ±0.25pF | GCM1555G1H5R9CA16# |
|        |               |                    | 3.3pF | ±0.1pF  | GCM1555G1H3R3BA16# |        |               |         | 6.0pF | ±0.1pF  | GCM1555G1H6R0BA16# |
|        |               |                    |       | ±0.25pF | GCM1555G1H3R3CA16# |        |               |         |       | ±0.25pF | GCM1555G1H6R0CA16# |
|        |               |                    | 3.4pF | ±0.1pF  | GCM1555G1H3R4BA16# |        |               |         | 6.1pF | ±0.1pF  | GCM1555G1H6R1BA16# |
|        |               |                    |       | ±0.25pF | GCM1555G1H3R4CA16# |        |               |         |       | ±0.25pF | GCM1555G1H6R1CA16# |
|        |               |                    | 3.5pF | ±0.1pF  | GCM1555G1H3R5BA16# |        |               |         | 6.2pF | ±0.1pF  | GCM1555G1H6R2BA16# |
|        |               |                    |       | ±0.25pF | GCM1555G1H3R5CA16# |        |               |         |       | ±0.25pF | GCM1555G1H6R2CA16# |
|        |               |                    | 3.6pF | ±0.1pF  | GCM1555G1H3R6BA16# |        |               |         | 6.3pF | ±0.1pF  | GCM1555G1H6R3BA16# |
|        |               |                    |       | ±0.25pF | GCM1555G1H3R6CA16# |        |               |         |       | ±0.25pF | GCM1555G1H6R3CA16# |
|        |               |                    | 3.7pF | ±0.1pF  | GCM1555G1H3R7BA16# |        |               |         | 6.4pF | ±0.1pF  | GCM1555G1H6R4BA16# |
|        |               |                    |       | ±0.25pF | GCM1555G1H3R7CA16# |        |               |         |       | ±0.25pF | GCM1555G1H6R4CA16# |
|        |               |                    | 3.8pF | ±0.1pF  | GCM1555G1H3R8BA16# |        |               |         | 6.5pF | ±0.1pF  | GCM1555G1H6R5BA16# |
|        |               |                    |       | ±0.25pF | GCM1555G1H3R8CA16# |        |               |         |       | ±0.25pF | GCM1555G1H6R5CA16# |
|        |               |                    | 3.9pF | ±0.1pF  | GCM1555G1H3R9BA16# |        |               |         | 6.6pF | ±0.1pF  | GCM1555G1H6R6BA16# |
|        |               |                    |       | ±0.25pF | GCM1555G1H3R9CA16# |        |               |         |       | ±0.25pF | GCM1555G1H6R6CA16# |
|        |               |                    | 4.0pF | ±0.1pF  | GCM1555G1H4R0BA16# |        |               |         | 6.7pF | ±0.1pF  | GCM1555G1H6R7BA16# |
|        |               |                    |       | ±0.25pF | GCM1555G1H4R0CA16# |        |               |         |       | ±0.25pF | GCM1555G1H6R7CA16# |
|        |               |                    | 4.1pF | ±0.1pF  | GCM1555G1H4R1BA16# |        |               |         | 6.8pF | ±0.1pF  | GCM1555G1H6R8BA16# |
|        |               |                    |       | ±0.25pF | GCM1555G1H4R1CA16# |        |               |         |       | ±0.25pF | GCM1555G1H6R8CA16# |
|        |               |                    | 4.2pF | ±0.1pF  | GCM1555G1H4R2BA16# |        |               |         | 6.9pF | ±0.1pF  | GCM1555G1H6R9BA16# |
|        |               |                    |       | ±0.25pF | GCM1555G1H4R2CA16# |        |               |         |       | ±0.25pF | GCM1555G1H6R9CA16# |
|        |               |                    | 4.3pF | ±0.1pF  | GCM1555G1H4R3BA16# |        |               |         | 7.0pF | ±0.1pF  | GCM1555G1H7R0BA16# |
|        |               |                    |       | ±0.25pF | GCM1555G1H4R3CA16# |        |               |         |       | ±0.25pF | GCM1555G1H7R0CA16# |
|        |               |                    | 4.4pF | ±0.1pF  | GCM1555G1H4R4BA16# |        |               |         | 7.1pF | ±0.1pF  | GCM1555G1H7R1BA16# |
|        |               |                    |       | ±0.25pF | GCM1555G1H4R4CA16# |        |               |         |       | ±0.25pF | GCM1555G1H7R1CA16# |
|        |               |                    | 4.5pF | ±0.1pF  | GCM1555G1H4R5BA16# |        |               |         | 7.2pF | ±0.1pF  | GCM1555G1H7R2BA16# |
|        |               |                    |       | ±0.25pF | GCM1555G1H4R5CA16# |        |               |         |       | ±0.25pF | GCM1555G1H7R2CA16# |
|        |               |                    | 4.6pF | ±0.1pF  | GCM1555G1H4R6BA16# |        |               |         | 7.3pF | ±0.1pF  | GCM1555G1H7R3BA16# |
|        |               |                    |       | ±0.25pF | GCM1555G1H4R6CA16# |        |               |         |       | ±0.25pF | GCM1555G1H7R3CA16# |
|        |               |                    | 4.7pF | ±0.1pF  | GCM1555G1H4R7BA16# |        |               |         | 7.4pF | ±0.1pF  | GCM1555G1H7R4BA16# |
|        |               |                    |       | ±0.25pF | GCM1555G1H4R7CA16# |        |               |         |       | ±0.25pF | GCM1555G1H7R4CA16# |
| 4.8pF  | ±0.1pF        | GCM1555G1H4R8BA16# | 7.5pF | ±0.1pF  | GCM1555G1H7R5BA16# |        |               |         |       |         |                    |
|        | ±0.25pF       | GCM1555G1H4R8CA16# |       | ±0.25pF | GCM1555G1H7R5CA16# |        |               |         |       |         |                    |
| 4.9pF  | ±0.1pF        | GCM1555G1H4R9BA16# | 7.6pF | ±0.1pF  | GCM1555G1H7R6BA16# |        |               |         |       |         |                    |
|        | ±0.25pF       | GCM1555G1H4R9CA16# |       | ±0.25pF | GCM1555G1H7R6CA16# |        |               |         |       |         |                    |
| 5.0pF  | ±0.1pF        | GCM1555G1H5R0BA16# | 7.7pF | ±0.1pF  | GCM1555G1H7R7BA16# |        |               |         |       |         |                    |
|        | ±0.25pF       | GCM1555G1H5R0CA16# |       | ±0.25pF | GCM1555G1H7R7CA16# |        |               |         |       |         |                    |
| 5.1pF  | ±0.1pF        | GCM1555G1H5R1BA16# | 7.8pF | ±0.1pF  | GCM1555G1H7R8BA16# |        |               |         |       |         |                    |
|        | ±0.25pF       | GCM1555G1H5R1CA16# |       | ±0.25pF | GCM1555G1H7R8CA16# |        |               |         |       |         |                    |
| 5.2pF  | ±0.1pF        | GCM1555G1H5R2BA16# | 7.9pF | ±0.1pF  | GCM1555G1H7R9BA16# |        |               |         |       |         |                    |
|        | ±0.25pF       | GCM1555G1H5R2CA16# |       | ±0.25pF | GCM1555G1H7R9CA16# |        |               |         |       |         |                    |
| 5.3pF  | ±0.1pF        | GCM1555G1H5R3BA16# | 8.0pF | ±0.1pF  | GCM1555G1H8R0BA16# |        |               |         |       |         |                    |
|        | ±0.25pF       | GCM1555G1H5R3CA16# |       | ±0.25pF | GCM1555G1H8R0CA16# |        |               |         |       |         |                    |

Part number # indicates the package specification code.

GRT Series  
 GCM Series  
 GC3 Series  
 GCJ Series  
 GCQ Series  
 GCD Series  
 GCE Series  
 NMF Series  
 KCM Series  
 KC3 Series  
 KCA Series  
 GCB Series  
 GCG Series  
 ⚠Caution /Notice

# GCM Series Temperature Compensating Type Part Number List

(→ 1.0×0.5mm)

| T max. | Rated Voltage | TC Code | Cap.  | Tol.    | Part Number        | T max. | Rated Voltage | TC Code | Cap. | Tol. | Part Number        |
|--------|---------------|---------|-------|---------|--------------------|--------|---------------|---------|------|------|--------------------|
| 0.55mm | 50Vdc         | X8G     | 8.1pF | ±0.1pF  | GCM1555G1H8R1BA16# | 0.55mm | 50Vdc         | X8G     | 16pF | ±1%  | GCM1555G1H160FA16# |
|        |               |         |       | ±0.25pF | GCM1555G1H8R1CA16# |        |               |         |      | ±2%  | GCM1555G1H160GA16# |
|        |               |         | 8.2pF | ±0.1pF  | GCM1555G1H8R2BA16# |        |               |         |      | ±5%  | GCM1555G1H160JA16# |
|        |               |         |       | ±0.25pF | GCM1555G1H8R2CA16# |        |               |         | 18pF | ±1%  | GCM1555G1H180FA16# |
|        |               |         | 8.3pF | ±0.1pF  | GCM1555G1H8R3BA16# |        |               |         |      | ±2%  | GCM1555G1H180GA16# |
|        |               |         |       | ±0.25pF | GCM1555G1H8R3CA16# |        |               |         |      | ±5%  | GCM1555G1H180JA16# |
|        |               |         | 8.4pF | ±0.1pF  | GCM1555G1H8R4BA16# |        |               |         | 20pF | ±1%  | GCM1555G1H200FA16# |
|        |               |         |       | ±0.25pF | GCM1555G1H8R4CA16# |        |               |         |      | ±2%  | GCM1555G1H200GA16# |
|        |               |         | 8.5pF | ±0.1pF  | GCM1555G1H8R5BA16# |        |               |         |      | ±5%  | GCM1555G1H200JA16# |
|        |               |         |       | ±0.25pF | GCM1555G1H8R5CA16# |        |               |         | 22pF | ±1%  | GCM1555G1H220FA16# |
|        |               |         | 8.6pF | ±0.1pF  | GCM1555G1H8R6BA16# |        |               |         |      | ±2%  | GCM1555G1H220GA16# |
|        |               |         |       | ±0.25pF | GCM1555G1H8R6CA16# |        |               |         |      | ±5%  | GCM1555G1H220JA16# |
|        |               |         | 8.7pF | ±0.1pF  | GCM1555G1H8R7BA16# |        |               |         | 24pF | ±1%  | GCM1555G1H240FA16# |
|        |               |         |       | ±0.25pF | GCM1555G1H8R7CA16# |        |               |         |      | ±2%  | GCM1555G1H240GA16# |
|        |               |         | 8.8pF | ±0.1pF  | GCM1555G1H8R8BA16# |        |               |         |      | ±5%  | GCM1555G1H240JA16# |
|        |               |         |       | ±0.25pF | GCM1555G1H8R8CA16# |        |               |         | 27pF | ±1%  | GCM1555G1H270FA16# |
|        |               |         | 8.9pF | ±0.1pF  | GCM1555G1H8R9BA16# |        |               |         |      | ±2%  | GCM1555G1H270GA16# |
|        |               |         |       | ±0.25pF | GCM1555G1H8R9CA16# |        |               |         |      | ±5%  | GCM1555G1H270JA16# |
|        |               |         | 9.0pF | ±0.1pF  | GCM1555G1H9R0BA16# |        |               |         | 30pF | ±1%  | GCM1555G1H300FA16# |
|        |               |         |       | ±0.25pF | GCM1555G1H9R0CA16# |        |               |         |      | ±2%  | GCM1555G1H300GA16# |
|        |               |         | 9.1pF | ±0.1pF  | GCM1555G1H9R1BA16# |        |               |         |      | ±5%  | GCM1555G1H300JA16# |
|        |               |         |       | ±0.25pF | GCM1555G1H9R1CA16# |        |               |         | 33pF | ±1%  | GCM1555G1H330FA16# |
|        |               |         | 9.2pF | ±0.1pF  | GCM1555G1H9R2BA16# |        |               |         |      | ±2%  | GCM1555G1H330GA16# |
|        |               |         |       | ±0.25pF | GCM1555G1H9R2CA16# |        |               |         |      | ±5%  | GCM1555G1H330JA16# |
|        |               |         | 9.3pF | ±0.1pF  | GCM1555G1H9R3BA16# |        |               |         | 36pF | ±1%  | GCM1555G1H360FA16# |
|        |               |         |       | ±0.25pF | GCM1555G1H9R3CA16# |        |               |         |      | ±2%  | GCM1555G1H360GA16# |
|        |               |         | 9.4pF | ±0.1pF  | GCM1555G1H9R4BA16# |        |               |         |      | ±5%  | GCM1555G1H360JA16# |
|        |               |         |       | ±0.25pF | GCM1555G1H9R4CA16# |        |               |         | 39pF | ±1%  | GCM1555G1H390FA16# |
|        |               |         | 9.5pF | ±0.1pF  | GCM1555G1H9R5BA16# |        |               |         |      | ±2%  | GCM1555G1H390GA16# |
|        |               |         |       | ±0.25pF | GCM1555G1H9R5CA16# |        |               |         |      | ±5%  | GCM1555G1H390JA16# |
|        |               |         | 9.6pF | ±0.1pF  | GCM1555G1H9R6BA16# |        |               |         | 43pF | ±1%  | GCM1555G1H430FA16# |
|        |               |         |       | ±0.25pF | GCM1555G1H9R6CA16# |        |               |         |      | ±2%  | GCM1555G1H430GA16# |
|        |               |         | 9.7pF | ±0.1pF  | GCM1555G1H9R7BA16# |        |               |         |      | ±5%  | GCM1555G1H430JA16# |
|        |               |         |       | ±0.25pF | GCM1555G1H9R7CA16# |        |               |         | 47pF | ±1%  | GCM1555G1H470FA16# |
|        |               |         | 9.8pF | ±0.1pF  | GCM1555G1H9R8BA16# |        |               |         |      | ±2%  | GCM1555G1H470GA16# |
|        |               |         |       | ±0.25pF | GCM1555G1H9R8CA16# |        |               |         |      | ±5%  | GCM1555G1H470JA16# |
|        |               |         | 9.9pF | ±0.1pF  | GCM1555G1H9R9BA16# |        |               |         | 51pF | ±1%  | GCM1555G1H510FA16# |
|        |               |         |       | ±0.25pF | GCM1555G1H9R9CA16# |        |               |         |      | ±2%  | GCM1555G1H510GA16# |
|        |               |         | 10pF  | ±1%     | GCM1555G1H100FA16# |        |               |         |      | ±5%  | GCM1555G1H510JA16# |
|        |               |         |       | ±2%     | GCM1555G1H100GA16# |        |               |         | 56pF | ±1%  | GCM1555G1H560FA16# |
|        |               |         |       | ±2.5%   | GCM1555G1H100RA16# |        |               |         |      | ±2%  | GCM1555G1H560GA16# |
|        |               |         |       | ±5%     | GCM1555G1H100JA16# |        |               |         |      | ±5%  | GCM1555G1H560JA16# |
|        |               |         | 11pF  | ±1%     | GCM1555G1H110FA16# |        |               |         |      | 62pF | ±1%                |
|        |               |         |       | ±2%     | GCM1555G1H110GA16# |        |               |         | ±2%  |      | GCM1555G1H620GA16# |
|        |               |         |       | ±5%     | GCM1555G1H110JA16# |        |               |         | ±5%  |      | GCM1555G1H620JA16# |
|        |               |         | 12pF  | ±1%     | GCM1555G1H120FA16# |        |               |         | 68pF | ±1%  | GCM1555G1H680FA16# |
|        |               |         |       | ±2%     | GCM1555G1H120GA16# |        |               |         |      | ±2%  | GCM1555G1H680GA16# |
|        |               |         |       | ±5%     | GCM1555G1H120JA16# |        |               |         |      | ±5%  | GCM1555G1H680JA16# |
|        |               |         | 13pF  | ±1%     | GCM1555G1H130FA16# |        |               |         | 75pF | ±1%  | GCM1555G1H750FA16# |
|        |               |         |       | ±2%     | GCM1555G1H130GA16# |        |               |         |      | ±2%  | GCM1555G1H750GA16# |
|        |               |         |       | ±5%     | GCM1555G1H130JA16# |        |               |         |      | ±5%  | GCM1555G1H750JA16# |
|        |               |         | 15pF  | ±1%     | GCM1555G1H150FA16# |        |               |         | 82pF | ±1%  | GCM1555G1H820FA16# |
|        |               |         |       | ±2%     | GCM1555G1H150GA16# |        |               |         |      | ±2%  | GCM1555G1H820GA16# |
|        |               |         |       | ±5%     | GCM1555G1H150JA16# |        |               |         |      | ±5%  | GCM1555G1H820JA16# |

Part number # indicates the package specification code.

GRT Series  
 GCM Series  
 GC3 Series  
 GCJ Series  
 GCQ Series  
 GCD Series  
 GCE Series  
 NMF Series  
 KCM Series  
 KC3 Series  
 KCA Series  
 GCB Series  
 GCG Series  
 ⚠Caution /Notice

# GCM Series Temperature Compensating Type Part Number List

(→ 1.0×0.5mm)

| T max. | Rated Voltage | TC Code | Cap.  | Tol. | Part Number        |
|--------|---------------|---------|-------|------|--------------------|
| 0.55mm | 50Vdc         | X8G     | 91pF  | ±1%  | GCM1555G1H910FA16# |
|        |               |         |       | ±2%  | GCM1555G1H910GA16# |
|        |               |         |       | ±5%  | GCM1555G1H910JA16# |
|        |               |         | 100pF | ±1%  | GCM1555G1H101FA16# |
|        |               |         |       | ±2%  | GCM1555G1H101GA16# |
|        |               |         |       | ±5%  | GCM1555G1H101JA16# |
|        |               |         | 110pF | ±1%  | GCM1555G1H111FA16# |
|        |               |         |       | ±2%  | GCM1555G1H111GA16# |
|        |               |         |       | ±5%  | GCM1555G1H111JA16# |
|        |               |         | 120pF | ±1%  | GCM1555G1H121FA16# |
|        |               |         |       | ±2%  | GCM1555G1H121GA16# |
|        |               |         |       | ±5%  | GCM1555G1H121JA16# |
|        |               |         | 130pF | ±1%  | GCM1555G1H131FA16# |
|        |               |         |       | ±2%  | GCM1555G1H131GA16# |
|        |               |         |       | ±5%  | GCM1555G1H131JA16# |
|        |               |         | 150pF | ±1%  | GCM1555G1H151FA16# |
|        |               |         |       | ±2%  | GCM1555G1H151GA16# |
|        |               |         |       | ±5%  | GCM1555G1H151JA16# |
|        |               |         | 160pF | ±1%  | GCM1555G1H161FA16# |
|        |               |         |       | ±2%  | GCM1555G1H161GA16# |
|        |               |         |       | ±5%  | GCM1555G1H161JA16# |
|        |               |         | 180pF | ±1%  | GCM1555G1H181FA16# |
|        |               |         |       | ±2%  | GCM1555G1H181GA16# |
|        |               |         |       | ±5%  | GCM1555G1H181JA16# |
|        |               |         | 200pF | ±1%  | GCM1555G1H201FA16# |
|        |               |         |       | ±2%  | GCM1555G1H201GA16# |
|        |               |         |       | ±5%  | GCM1555G1H201JA16# |
|        |               |         | 220pF | ±1%  | GCM1555G1H221FA16# |
|        |               |         |       | ±2%  | GCM1555G1H221GA16# |
|        |               |         |       | ±5%  | GCM1555G1H221JA16# |
|        |               |         | 240pF | ±1%  | GCM1555G1H241FA16# |
|        |               |         |       | ±2%  | GCM1555G1H241GA16# |
|        |               |         |       | ±5%  | GCM1555G1H241JA16# |
|        |               |         | 270pF | ±1%  | GCM1555G1H271FA16# |
|        |               |         |       | ±2%  | GCM1555G1H271GA16# |
|        |               |         |       | ±5%  | GCM1555G1H271JA16# |
|        |               |         | 300pF | ±1%  | GCM1555G1H301FA16# |
|        |               |         |       | ±2%  | GCM1555G1H301GA16# |
|        |               |         |       | ±5%  | GCM1555G1H301JA16# |
|        |               |         | 330pF | ±1%  | GCM1555G1H331FA16# |
|        |               |         |       | ±2%  | GCM1555G1H331GA16# |
|        |               |         |       | ±5%  | GCM1555G1H331JA16# |
|        |               |         | 360pF | ±1%  | GCM1555G1H361FA16# |
|        |               |         |       | ±2%  | GCM1555G1H361GA16# |
|        |               |         |       | ±5%  | GCM1555G1H361JA16# |
|        |               |         | 390pF | ±1%  | GCM1555G1H391FA16# |
|        |               |         |       | ±2%  | GCM1555G1H391GA16# |
|        |               |         |       | ±5%  | GCM1555G1H391JA16# |
|        |               |         | 430pF | ±1%  | GCM1555G1H431FA16# |
|        |               |         |       | ±2%  | GCM1555G1H431GA16# |
|        |               |         |       | ±5%  | GCM1555G1H431JA16# |
|        |               |         | 470pF | ±1%  | GCM1555G1H471FA16# |
|        |               |         |       | ±2%  | GCM1555G1H471GA16# |
|        |               |         |       | ±5%  | GCM1555G1H471JA16# |

| T max. | Rated Voltage | TC Code | Cap.   | Tol. | Part Number        |
|--------|---------------|---------|--------|------|--------------------|
| 0.55mm | 50Vdc         | X8G     | 510pF  | ±1%  | GCM1555G1H511FA16# |
|        |               |         |        | ±2%  | GCM1555G1H511GA16# |
|        |               |         |        | ±5%  | GCM1555G1H511JA16# |
|        |               |         | 560pF  | ±1%  | GCM1555G1H561FA16# |
|        |               |         |        | ±2%  | GCM1555G1H561GA16# |
|        |               |         |        | ±5%  | GCM1555G1H561JA16# |
|        |               |         | 620pF  | ±1%  | GCM1555G1H621FA16# |
|        |               |         |        | ±2%  | GCM1555G1H621GA16# |
|        |               |         |        | ±5%  | GCM1555G1H621JA16# |
|        |               |         | 680pF  | ±1%  | GCM1555G1H681FA16# |
|        |               |         |        | ±2%  | GCM1555G1H681GA16# |
|        |               |         |        | ±5%  | GCM1555G1H681JA16# |
|        |               |         | 750pF  | ±1%  | GCM1555G1H751FA16# |
|        |               |         |        | ±2%  | GCM1555G1H751GA16# |
|        |               |         |        | ±5%  | GCM1555G1H751JA16# |
|        |               |         | 820pF  | ±1%  | GCM1555G1H821FA16# |
|        |               |         |        | ±2%  | GCM1555G1H821GA16# |
|        |               |         |        | ±5%  | GCM1555G1H821JA16# |
|        |               |         | 910pF  | ±1%  | GCM1555G1H911FA16# |
|        |               |         |        | ±2%  | GCM1555G1H911GA16# |
|        |               |         |        | ±5%  | GCM1555G1H911JA16# |
|        |               |         | 1000pF | ±1%  | GCM1555G1H102FA16# |
|        |               |         |        | ±2%  | GCM1555G1H102GA16# |
|        |               |         |        | ±5%  | GCM1555G1H102JA16# |

1.6×0.8mm

| T max. | Rated Voltage | TC Code | Cap.   | Tol.    | Part Number        |
|--------|---------------|---------|--------|---------|--------------------|
| 0.9mm  | 100Vdc        | COG     | 0.47pF | ±0.1pF  | GCM1885C2AR47BA16# |
|        |               |         |        | ±0.25pF | GCM1885C2AR47CA16# |
|        |               |         | 0.50pF | ±0.1pF  | GCM1885C2AR50BA16# |
|        |               |         |        | ±0.25pF | GCM1885C2AR50CA16# |
|        |               |         | 0.51pF | ±0.1pF  | GCM1885C2AR51BA16# |
|        |               |         |        | ±0.25pF | GCM1885C2AR51CA16# |
|        |               |         | 0.56pF | ±0.1pF  | GCM1885C2AR56BA16# |
|        |               |         |        | ±0.25pF | GCM1885C2AR56CA16# |
|        |               |         | 0.60pF | ±0.1pF  | GCM1885C2AR60BA16# |
|        |               |         |        | ±0.25pF | GCM1885C2AR60CA16# |
|        |               |         | 0.62pF | ±0.1pF  | GCM1885C2AR62BA16# |
|        |               |         |        | ±0.25pF | GCM1885C2AR62CA16# |
|        |               |         | 0.68pF | ±0.1pF  | GCM1885C2AR68BA16# |
|        |               |         |        | ±0.25pF | GCM1885C2AR68CA16# |
|        |               |         | 0.70pF | ±0.1pF  | GCM1885C2AR70BA16# |
|        |               |         |        | ±0.25pF | GCM1885C2AR70CA16# |
|        |               |         | 0.75pF | ±0.1pF  | GCM1885C2AR75BA16# |
|        |               |         |        | ±0.25pF | GCM1885C2AR75CA16# |
|        |               |         | 0.80pF | ±0.1pF  | GCM1885C2AR80BA16# |
|        |               |         |        | ±0.25pF | GCM1885C2AR80CA16# |
|        |               |         | 0.82pF | ±0.1pF  | GCM1885C2AR82BA16# |
|        |               |         |        | ±0.25pF | GCM1885C2AR82CA16# |
|        |               |         | 0.90pF | ±0.1pF  | GCM1885C2AR90BA16# |
|        |               |         |        | ±0.25pF | GCM1885C2AR90CA16# |
|        |               |         | 0.91pF | ±0.1pF  | GCM1885C2AR91BA16# |

Part number # indicates the package specification code.

# GCM Series Temperature Compensating Type Part Number List

(→ 1.6×0.8mm)

| T max.  | Rated Voltage      | TC Code            | Cap.    | Tol.               | Part Number        | T max. | Rated Voltage | TC Code | Cap.               | Tol.    | Part Number        |
|---------|--------------------|--------------------|---------|--------------------|--------------------|--------|---------------|---------|--------------------|---------|--------------------|
| 0.9mm   | 100Vdc             | COG                | 0.91pF  | ±0.25pF            | GCM1885C2AR91CA16# | 0.9mm  | 100Vdc        | COG     | 3.6pF              | ±0.25pF | GCM1885C2A3R6CA16# |
|         |                    |                    |         | ±0.1pF             | GCM1885C2A1R0BA16# |        |               |         |                    | ±0.1pF  | GCM1885C2A3R7BA16# |
|         |                    |                    | ±0.25pF | GCM1885C2A1R0CA16# | ±0.25pF            |        |               |         | GCM1885C2A3R7CA16# |         |                    |
|         |                    |                    | 1.1pF   | ±0.1pF             | GCM1885C2A1R1BA16# |        |               |         | 3.8pF              | ±0.1pF  | GCM1885C2A3R8BA16# |
|         |                    |                    |         | ±0.25pF            | GCM1885C2A1R1CA16# |        |               |         |                    | ±0.25pF | GCM1885C2A3R8CA16# |
|         |                    |                    | 1.2pF   | ±0.1pF             | GCM1885C2A1R2BA16# |        |               |         | 3.9pF              | ±0.1pF  | GCM1885C2A3R9BA16# |
|         |                    |                    |         | ±0.25pF            | GCM1885C2A1R2CA16# |        |               |         |                    | ±0.25pF | GCM1885C2A3R9CA16# |
|         |                    |                    | 1.3pF   | ±0.1pF             | GCM1885C2A1R3BA16# |        |               |         | 4.0pF              | ±0.1pF  | GCM1885C2A4R0BA16# |
|         |                    |                    |         | ±0.25pF            | GCM1885C2A1R3CA16# |        |               |         |                    | ±0.25pF | GCM1885C2A4R0CA16# |
|         |                    |                    | 1.4pF   | ±0.1pF             | GCM1885C2A1R4BA16# |        |               |         | 4.1pF              | ±0.5pF  | GCM1885C2A4R0DA16# |
|         |                    |                    |         | ±0.25pF            | GCM1885C2A1R4CA16# |        |               |         |                    | ±0.1pF  | GCM1885C2A4R1BA16# |
|         |                    |                    | 1.5pF   | ±0.1pF             | GCM1885C2A1R5BA16# |        |               |         | 4.2pF              | ±0.25pF | GCM1885C2A4R1CA16# |
|         |                    |                    |         | ±0.25pF            | GCM1885C2A1R5CA16# |        |               |         |                    | ±0.5pF  | GCM1885C2A4R1DA16# |
|         |                    |                    | 1.6pF   | ±0.1pF             | GCM1885C2A1R6BA16# |        |               |         | 4.3pF              | ±0.1pF  | GCM1885C2A4R2BA16# |
|         |                    |                    |         | ±0.25pF            | GCM1885C2A1R6CA16# |        |               |         |                    | ±0.25pF | GCM1885C2A4R2CA16# |
|         |                    |                    | 1.7pF   | ±0.1pF             | GCM1885C2A1R7BA16# |        |               |         | 4.4pF              | ±0.5pF  | GCM1885C2A4R2DA16# |
|         |                    |                    |         | ±0.25pF            | GCM1885C2A1R7CA16# |        |               |         |                    | ±0.1pF  | GCM1885C2A4R3BA16# |
|         |                    |                    | 1.8pF   | ±0.1pF             | GCM1885C2A1R8BA16# |        |               |         | 4.5pF              | ±0.25pF | GCM1885C2A4R3CA16# |
|         |                    |                    |         | ±0.25pF            | GCM1885C2A1R8CA16# |        |               |         |                    | ±0.5pF  | GCM1885C2A4R3DA16# |
|         |                    |                    | 1.9pF   | ±0.1pF             | GCM1885C2A1R9BA16# |        |               |         | 4.6pF              | ±0.1pF  | GCM1885C2A4R4BA16# |
|         |                    |                    |         | ±0.25pF            | GCM1885C2A1R9CA16# |        |               |         |                    | ±0.25pF | GCM1885C2A4R4CA16# |
|         |                    |                    | 2.0pF   | ±0.1pF             | GCM1885C2A2R0BA16# |        |               |         | 4.7pF              | ±0.5pF  | GCM1885C2A4R4DA16# |
|         |                    |                    |         | ±0.25pF            | GCM1885C2A2R0CA16# |        |               |         |                    | ±0.1pF  | GCM1885C2A4R5BA16# |
|         |                    |                    | 2.1pF   | ±0.1pF             | GCM1885C2A2R1BA16# |        |               |         | 4.8pF              | ±0.25pF | GCM1885C2A4R5CA16# |
|         |                    |                    |         | ±0.25pF            | GCM1885C2A2R1CA16# |        |               |         |                    | ±0.5pF  | GCM1885C2A4R5DA16# |
|         |                    |                    | 2.2pF   | ±0.1pF             | GCM1885C2A2R2BA16# |        |               |         | 4.9pF              | ±0.1pF  | GCM1885C2A4R6BA16# |
|         |                    |                    |         | ±0.25pF            | GCM1885C2A2R2CA16# |        |               |         |                    | ±0.25pF | GCM1885C2A4R6CA16# |
|         |                    |                    | 2.3pF   | ±0.1pF             | GCM1885C2A2R3BA16# |        |               |         | 5.0pF              | ±0.5pF  | GCM1885C2A4R6DA16# |
|         |                    |                    |         | ±0.25pF            | GCM1885C2A2R3CA16# |        |               |         |                    | ±0.1pF  | GCM1885C2A5R0BA16# |
|         |                    |                    | 2.4pF   | ±0.1pF             | GCM1885C2A2R4BA16# |        |               |         | 5.1pF              | ±0.25pF | GCM1885C2A5R0CA16# |
|         |                    |                    |         | ±0.25pF            | GCM1885C2A2R4CA16# |        |               |         |                    | ±0.5pF  | GCM1885C2A5R0DA16# |
|         |                    |                    | 2.5pF   | ±0.1pF             | GCM1885C2A2R5BA16# |        |               |         | 5.2pF              | ±0.1pF  | GCM1885C2A5R1BA16# |
|         |                    |                    |         | ±0.25pF            | GCM1885C2A2R5CA16# |        |               |         |                    | ±0.25pF | GCM1885C2A5R1CA16# |
|         |                    |                    | 2.6pF   | ±0.1pF             | GCM1885C2A2R6BA16# |        |               |         | 5.3pF              | ±0.5pF  | GCM1885C2A5R1DA16# |
|         |                    |                    |         | ±0.25pF            | GCM1885C2A2R6CA16# |        |               |         |                    | ±0.1pF  | GCM1885C2A5R2BA16# |
|         |                    |                    | 2.7pF   | ±0.1pF             | GCM1885C2A2R7BA16# |        |               |         | 5.4pF              | ±0.25pF | GCM1885C2A5R2CA16# |
|         |                    |                    |         | ±0.25pF            | GCM1885C2A2R7CA16# |        |               |         |                    | ±0.5pF  | GCM1885C2A5R2DA16# |
|         |                    |                    | 2.8pF   | ±0.1pF             | GCM1885C2A2R8BA16# |        |               |         | 5.5pF              | ±0.1pF  | GCM1885C2A5R3BA16# |
|         |                    |                    |         | ±0.25pF            | GCM1885C2A2R8CA16# |        |               |         |                    | ±0.25pF | GCM1885C2A5R3CA16# |
|         |                    |                    | 2.9pF   | ±0.1pF             | GCM1885C2A2R9BA16# |        |               |         | 5.5pF              | ±0.5pF  | GCM1885C2A5R3DA16# |
|         |                    |                    |         | ±0.25pF            | GCM1885C2A2R9CA16# |        |               |         |                    | ±0.1pF  | GCM1885C2A5R4BA16# |
|         |                    |                    | 3.0pF   | ±0.1pF             | GCM1885C2A3R0BA16# |        |               |         | 5.5pF              | ±0.25pF | GCM1885C2A5R4CA16# |
|         |                    |                    |         | ±0.25pF            | GCM1885C2A3R0CA16# |        |               |         |                    | ±0.5pF  | GCM1885C2A5R4DA16# |
|         |                    |                    | 3.1pF   | ±0.1pF             | GCM1885C2A3R1BA16# |        |               |         | 5.5pF              | ±0.1pF  | GCM1885C2A5R5BA16# |
|         |                    |                    |         | ±0.25pF            | GCM1885C2A3R1CA16# |        |               |         |                    | ±0.25pF | GCM1885C2A5R5CA16# |
|         |                    |                    | 3.2pF   | ±0.1pF             | GCM1885C2A3R2BA16# |        |               |         | 5.5pF              | ±0.5pF  | GCM1885C2A5R5CA16# |
|         |                    |                    |         | ±0.25pF            | GCM1885C2A3R2CA16# |        |               |         |                    | ±0.1pF  | GCM1885C2A3R6BA16# |
|         |                    |                    | 3.3pF   | ±0.1pF             | GCM1885C2A3R3BA16# |        |               |         | 5.5pF              | ±0.25pF | GCM1885C2A3R6BA16# |
| ±0.25pF | GCM1885C2A3R3CA16# | ±0.1pF             |         | GCM1885C2A3R6BA16# |                    |        |               |         |                    |         |                    |
| 3.4pF   | ±0.1pF             | GCM1885C2A3R4BA16# | 5.5pF   | ±0.25pF            | GCM1885C2A3R6BA16# |        |               |         |                    |         |                    |
|         | ±0.25pF            | GCM1885C2A3R4CA16# |         | ±0.1pF             | GCM1885C2A3R6BA16# |        |               |         |                    |         |                    |
| 3.5pF   | ±0.1pF             | GCM1885C2A3R5BA16# | 5.5pF   | ±0.25pF            | GCM1885C2A3R6BA16# |        |               |         |                    |         |                    |
|         | ±0.25pF            | GCM1885C2A3R5CA16# |         | ±0.1pF             | GCM1885C2A3R6BA16# |        |               |         |                    |         |                    |
| 3.6pF   | ±0.1pF             | GCM1885C2A3R6BA16# | 5.5pF   | ±0.25pF            | GCM1885C2A3R6BA16# |        |               |         |                    |         |                    |
|         | ±0.25pF            | GCM1885C2A3R6BA16# |         | ±0.1pF             | GCM1885C2A3R6BA16# |        |               |         |                    |         |                    |

Part number # indicates the package specification code.

GRT Series  
 GCM Series  
 GC3 Series  
 GCJ Series  
 GCQ Series  
 GCD Series  
 GCE Series  
 NMF Series  
 KCM Series  
 KC3 Series  
 KCA Series  
 GCB Series  
 GCG Series  
 ⚠Caution /Notice

# GCM Series Temperature Compensating Type Part Number List

(→ 1.6×0.8mm)

| T max. | Rated Voltage      | TC Code            | Cap.   | Tol.               | Part Number        | T max. | Rated Voltage | TC Code | Cap.   | Tol.               | Part Number        |         |                    |
|--------|--------------------|--------------------|--------|--------------------|--------------------|--------|---------------|---------|--------|--------------------|--------------------|---------|--------------------|
| 0.9mm  | 100Vdc             | COG                | 5.5pF  | ±0.5pF             | GCM1885C2A5R5DA16# | 0.9mm  | 100Vdc        | COG     | 7.3pF  | ±0.5pF             | GCM1885C2A7R3DA16# |         |                    |
|        |                    |                    |        | 5.6pF              | ±0.1pF             |        |               |         |        | GCM1885C2A5R6BA16# | 7.4pF              | ±0.1pF  | GCM1885C2A7R4BA16# |
|        |                    |                    |        |                    | ±0.25pF            |        |               |         |        | GCM1885C2A5R6CA16# |                    | ±0.25pF | GCM1885C2A7R4CA16# |
|        |                    |                    | ±0.5pF |                    | GCM1885C2A5R6DA16# |        |               |         | ±0.5pF | GCM1885C2A7R4DA16# |                    |         |                    |
|        |                    |                    | 5.7pF  | ±0.1pF             | GCM1885C2A5R7BA16# |        |               |         | 7.5pF  | ±0.1pF             | GCM1885C2A7R5BA16# |         |                    |
|        |                    |                    |        | ±0.25pF            | GCM1885C2A5R7CA16# |        |               |         |        | ±0.25pF            | GCM1885C2A7R5CA16# |         |                    |
|        |                    |                    |        | ±0.5pF             | GCM1885C2A5R7DA16# |        |               |         |        | ±0.5pF             | GCM1885C2A7R5DA16# |         |                    |
|        |                    |                    | 5.8pF  | ±0.1pF             | GCM1885C2A5R8BA16# |        |               |         | 7.6pF  | ±0.1pF             | GCM1885C2A7R6BA16# |         |                    |
|        |                    |                    |        | ±0.25pF            | GCM1885C2A5R8CA16# |        |               |         |        | ±0.25pF            | GCM1885C2A7R6CA16# |         |                    |
|        |                    |                    |        | ±0.5pF             | GCM1885C2A5R8DA16# |        |               |         |        | ±0.5pF             | GCM1885C2A7R6DA16# |         |                    |
|        |                    |                    | 5.9pF  | ±0.1pF             | GCM1885C2A5R9BA16# |        |               |         | 7.7pF  | ±0.1pF             | GCM1885C2A7R7BA16# |         |                    |
|        |                    |                    |        | ±0.25pF            | GCM1885C2A5R9CA16# |        |               |         |        | ±0.25pF            | GCM1885C2A7R7CA16# |         |                    |
|        |                    |                    |        | ±0.5pF             | GCM1885C2A5R9DA16# |        |               |         |        | ±0.5pF             | GCM1885C2A7R7DA16# |         |                    |
|        |                    |                    | 6.0pF  | ±0.1pF             | GCM1885C2A6R0BA16# |        |               |         | 7.8pF  | ±0.1pF             | GCM1885C2A7R8BA16# |         |                    |
|        |                    |                    |        | ±0.25pF            | GCM1885C2A6R0CA16# |        |               |         |        | ±0.25pF            | GCM1885C2A7R8CA16# |         |                    |
|        |                    |                    |        | ±0.5pF             | GCM1885C2A6R0DA16# |        |               |         |        | ±0.5pF             | GCM1885C2A7R8DA16# |         |                    |
|        |                    |                    | 6.1pF  | ±0.1pF             | GCM1885C2A6R1BA16# |        |               |         | 7.9pF  | ±0.1pF             | GCM1885C2A7R9BA16# |         |                    |
|        |                    |                    |        | ±0.25pF            | GCM1885C2A6R1CA16# |        |               |         |        | ±0.25pF            | GCM1885C2A7R9CA16# |         |                    |
|        |                    |                    |        | ±0.5pF             | GCM1885C2A6R1DA16# |        |               |         |        | ±0.5pF             | GCM1885C2A7R9DA16# |         |                    |
|        |                    |                    | 6.2pF  | ±0.1pF             | GCM1885C2A6R2BA16# |        |               |         | 8.0pF  | ±0.1pF             | GCM1885C2A8R0BA16# |         |                    |
|        |                    |                    |        | ±0.25pF            | GCM1885C2A6R2CA16# |        |               |         |        | ±0.25pF            | GCM1885C2A8R0CA16# |         |                    |
|        |                    |                    |        | ±0.5pF             | GCM1885C2A6R2DA16# |        |               |         |        | ±0.5pF             | GCM1885C2A8R0DA16# |         |                    |
|        |                    |                    | 6.3pF  | ±0.1pF             | GCM1885C2A6R3BA16# |        |               |         | 8.1pF  | ±0.1pF             | GCM1885C2A8R1BA16# |         |                    |
|        |                    |                    |        | ±0.25pF            | GCM1885C2A6R3CA16# |        |               |         |        | ±0.25pF            | GCM1885C2A8R1CA16# |         |                    |
|        |                    |                    |        | ±0.5pF             | GCM1885C2A6R3DA16# |        |               |         |        | ±0.5pF             | GCM1885C2A8R1DA16# |         |                    |
|        |                    |                    | 6.4pF  | ±0.1pF             | GCM1885C2A6R4BA16# |        |               |         | 8.2pF  | ±0.1pF             | GCM1885C2A8R2BA16# |         |                    |
|        |                    |                    |        | ±0.25pF            | GCM1885C2A6R4CA16# |        |               |         |        | ±0.25pF            | GCM1885C2A8R2CA16# |         |                    |
|        |                    |                    |        | ±0.5pF             | GCM1885C2A6R4DA16# |        |               |         |        | ±0.5pF             | GCM1885C2A8R2DA16# |         |                    |
|        |                    |                    | 6.5pF  | ±0.1pF             | GCM1885C2A6R5BA16# |        |               |         | 8.3pF  | ±0.1pF             | GCM1885C2A8R3BA16# |         |                    |
|        |                    |                    |        | ±0.25pF            | GCM1885C2A6R5CA16# |        |               |         |        | ±0.25pF            | GCM1885C2A8R3CA16# |         |                    |
|        |                    |                    |        | ±0.5pF             | GCM1885C2A6R5DA16# |        |               |         |        | ±0.5pF             | GCM1885C2A8R3DA16# |         |                    |
|        |                    |                    | 6.6pF  | ±0.1pF             | GCM1885C2A6R6BA16# |        |               |         | 8.4pF  | ±0.1pF             | GCM1885C2A8R4BA16# |         |                    |
|        |                    |                    |        | ±0.25pF            | GCM1885C2A6R6CA16# |        |               |         |        | ±0.25pF            | GCM1885C2A8R4CA16# |         |                    |
|        |                    |                    |        | ±0.5pF             | GCM1885C2A6R6DA16# |        |               |         |        | ±0.5pF             | GCM1885C2A8R4DA16# |         |                    |
|        |                    |                    | 6.7pF  | ±0.1pF             | GCM1885C2A6R7BA16# |        |               |         | 8.5pF  | ±0.1pF             | GCM1885C2A8R5BA16# |         |                    |
|        |                    |                    |        | ±0.25pF            | GCM1885C2A6R7CA16# |        |               |         |        | ±0.25pF            | GCM1885C2A8R5CA16# |         |                    |
|        |                    |                    |        | ±0.5pF             | GCM1885C2A6R7DA16# |        |               |         |        | ±0.5pF             | GCM1885C2A8R5DA16# |         |                    |
|        |                    |                    | 6.8pF  | ±0.1pF             | GCM1885C2A6R8BA16# |        |               |         | 8.6pF  | ±0.1pF             | GCM1885C2A8R6BA16# |         |                    |
|        |                    |                    |        | ±0.25pF            | GCM1885C2A6R8CA16# |        |               |         |        | ±0.25pF            | GCM1885C2A8R6CA16# |         |                    |
|        |                    |                    |        | ±0.5pF             | GCM1885C2A6R8DA16# |        |               |         |        | ±0.5pF             | GCM1885C2A8R6DA16# |         |                    |
|        |                    |                    | 6.9pF  | ±0.1pF             | GCM1885C2A6R9BA16# |        |               |         | 8.7pF  | ±0.1pF             | GCM1885C2A8R7BA16# |         |                    |
|        |                    |                    |        | ±0.25pF            | GCM1885C2A6R9CA16# |        |               |         |        | ±0.25pF            | GCM1885C2A8R7CA16# |         |                    |
| ±0.5pF | GCM1885C2A6R9DA16# | ±0.5pF             |        | GCM1885C2A8R7DA16# |                    |        |               |         |        |                    |                    |         |                    |
| 7.0pF  | ±0.1pF             | GCM1885C2A7R0BA16# | 8.8pF  | ±0.1pF             | GCM1885C2A8R8BA16# |        |               |         |        |                    |                    |         |                    |
|        | ±0.25pF            | GCM1885C2A7R0CA16# |        | ±0.25pF            | GCM1885C2A8R8CA16# |        |               |         |        |                    |                    |         |                    |
|        | ±0.5pF             | GCM1885C2A7R0DA16# |        | ±0.5pF             | GCM1885C2A8R8DA16# |        |               |         |        |                    |                    |         |                    |
| 7.1pF  | ±0.1pF             | GCM1885C2A7R1BA16# | 8.9pF  | ±0.1pF             | GCM1885C2A8R9BA16# |        |               |         |        |                    |                    |         |                    |
|        | ±0.25pF            | GCM1885C2A7R1CA16# |        | ±0.25pF            | GCM1885C2A8R9CA16# |        |               |         |        |                    |                    |         |                    |
|        | ±0.5pF             | GCM1885C2A7R1DA16# |        | ±0.5pF             | GCM1885C2A8R9DA16# |        |               |         |        |                    |                    |         |                    |
| 7.2pF  | ±0.1pF             | GCM1885C2A7R2BA16# | 9.0pF  | ±0.1pF             | GCM1885C2A9R0BA16# |        |               |         |        |                    |                    |         |                    |
|        | ±0.25pF            | GCM1885C2A7R2CA16# |        | ±0.25pF            | GCM1885C2A9R0CA16# |        |               |         |        |                    |                    |         |                    |
|        | ±0.5pF             | GCM1885C2A7R2DA16# |        | ±0.5pF             | GCM1885C2A9R0DA16# |        |               |         |        |                    |                    |         |                    |
| 7.3pF  | ±0.1pF             | GCM1885C2A7R3BA16# | 9.1pF  | ±0.1pF             | GCM1885C2A9R1BA16# |        |               |         |        |                    |                    |         |                    |
|        | ±0.25pF            | GCM1885C2A7R3CA16# |        | ±0.25pF            | GCM1885C2A9R1CA16# |        |               |         |        |                    |                    |         |                    |

Part number # indicates the package specification code.

GRT Series  
 GCM Series  
 GC3 Series  
 GCJ Series  
 GCQ Series  
 GCD Series  
 GCE Series  
 NMF Series  
 KCM Series  
 KC3 Series  
 KCA Series  
 GCB Series  
 GCG Series  
 ⚠Caution /Notice

# GCM Series Temperature Compensating Type Part Number List

(→ 1.6×0.8mm)

| T max. | Rated Voltage      | TC Code            | Cap.               | Tol.               | Part Number        | T max. | Rated Voltage | TC Code | Cap.               | Tol. | Part Number        |
|--------|--------------------|--------------------|--------------------|--------------------|--------------------|--------|---------------|---------|--------------------|------|--------------------|
| 0.9mm  | 100Vdc             | COG                | 9.1pF              | ±0.5pF             | GCM1885C2A9R1DA16# | 0.9mm  | 100Vdc        | COG     | 24pF               | ±2%  | GCM1885C2A240GA16# |
|        |                    |                    |                    | ±0.1pF             | GCM1885C2A9R2BA16# |        |               |         |                    | ±5%  | GCM1885C2A240JA16# |
|        |                    |                    |                    | ±0.25pF            | GCM1885C2A9R2CA16# |        |               |         |                    | 27pF | ±1%                |
|        |                    |                    | ±0.5pF             | GCM1885C2A9R2DA16# | ±2%                |        |               |         | GCM1885C2A270GA16# |      |                    |
|        |                    |                    | 9.3pF              | ±0.1pF             | GCM1885C2A9R3BA16# |        |               |         | 30pF               | ±1%  | GCM1885C2A300FA16# |
|        |                    |                    |                    | ±0.25pF            | GCM1885C2A9R3CA16# |        |               |         |                    | ±2%  | GCM1885C2A300GA16# |
|        |                    |                    |                    | ±0.5pF             | GCM1885C2A9R3DA16# |        |               |         |                    | ±5%  | GCM1885C2A270JA16# |
|        |                    |                    | 9.4pF              | ±0.1pF             | GCM1885C2A9R4BA16# |        |               |         | 33pF               | ±1%  | GCM1885C2A330FA16# |
|        |                    |                    |                    | ±0.25pF            | GCM1885C2A9R4CA16# |        |               |         |                    | ±2%  | GCM1885C2A330GA16# |
|        |                    |                    |                    | ±0.5pF             | GCM1885C2A9R4DA16# |        |               |         |                    | ±5%  | GCM1885C2A330JA16# |
|        |                    |                    | 9.5pF              | ±0.1pF             | GCM1885C2A9R5BA16# |        |               |         | 36pF               | ±1%  | GCM1885C2A360FA16# |
|        |                    |                    |                    | ±0.25pF            | GCM1885C2A9R5CA16# |        |               |         |                    | ±2%  | GCM1885C2A360GA16# |
|        |                    |                    |                    | ±0.5pF             | GCM1885C2A9R5DA16# |        |               |         |                    | ±5%  | GCM1885C2A360JA16# |
|        |                    |                    | 9.6pF              | ±0.1pF             | GCM1885C2A9R6BA16# |        |               |         | 39pF               | ±1%  | GCM1885C2A390FA16# |
|        |                    |                    |                    | ±0.25pF            | GCM1885C2A9R6CA16# |        |               |         |                    | ±2%  | GCM1885C2A390GA16# |
|        |                    |                    |                    | ±0.5pF             | GCM1885C2A9R6DA16# |        |               |         |                    | ±5%  | GCM1885C2A390JA16# |
|        |                    |                    | 9.7pF              | ±0.1pF             | GCM1885C2A9R7BA16# |        |               |         | 43pF               | ±1%  | GCM1885C2A430FA16# |
|        |                    |                    |                    | ±0.25pF            | GCM1885C2A9R7CA16# |        |               |         |                    | ±2%  | GCM1885C2A430GA16# |
|        |                    |                    |                    | ±0.5pF             | GCM1885C2A9R7DA16# |        |               |         |                    | ±5%  | GCM1885C2A430JA16# |
|        |                    |                    | 9.8pF              | ±0.1pF             | GCM1885C2A9R8BA16# |        |               |         | 47pF               | ±1%  | GCM1885C2A470FA16# |
|        |                    |                    |                    | ±0.25pF            | GCM1885C2A9R8CA16# |        |               |         |                    | ±2%  | GCM1885C2A470GA16# |
|        |                    |                    |                    | ±0.5pF             | GCM1885C2A9R8DA16# |        |               |         |                    | ±5%  | GCM1885C2A470JA16# |
|        |                    |                    | 9.9pF              | ±0.1pF             | GCM1885C2A9R9BA16# |        |               |         | 51pF               | ±1%  | GCM1885C2A510FA16# |
|        |                    |                    |                    | ±0.25pF            | GCM1885C2A9R9CA16# |        |               |         |                    | ±2%  | GCM1885C2A510GA16# |
|        |                    |                    |                    | ±0.5pF             | GCM1885C2A9R9DA16# |        |               |         |                    | ±5%  | GCM1885C2A510JA16# |
|        |                    |                    | 10pF               | ±1%                | GCM1885C2A100FA16# |        |               |         | 56pF               | ±1%  | GCM1885C2A560FA16# |
|        |                    |                    |                    | ±2%                | GCM1885C2A100GA16# |        |               |         |                    | ±2%  | GCM1885C2A560GA16# |
|        |                    |                    |                    | ±2.5%              | GCM1885C2A100RA16# |        |               |         |                    | ±5%  | GCM1885C2A560JA16# |
|        |                    |                    |                    | ±5%                | GCM1885C2A100JA16# |        |               |         |                    | 62pF | ±1%                |
|        |                    |                    | 11pF               | ±1%                | GCM1885C2A110FA16# |        |               |         | ±2%                |      | GCM1885C2A620GA16# |
|        |                    |                    |                    | ±2%                | GCM1885C2A110GA16# |        |               |         | ±5%                |      | GCM1885C2A620JA16# |
|        |                    |                    |                    | ±5%                | GCM1885C2A110JA16# |        |               |         | 68pF               | ±1%  | GCM1885C2A680FA16# |
|        |                    |                    | 12pF               | ±1%                | GCM1885C2A120FA16# |        |               |         |                    | ±2%  | GCM1885C2A680GA16# |
|        |                    |                    |                    | ±2%                | GCM1885C2A120GA16# |        |               |         |                    | ±5%  | GCM1885C2A680JA16# |
|        |                    |                    |                    | ±5%                | GCM1885C2A120JA16# |        |               |         | 75pF               | ±1%  | GCM1885C2A750FA16# |
|        |                    |                    | 13pF               | ±1%                | GCM1885C2A130FA16# |        |               |         |                    | ±2%  | GCM1885C2A750GA16# |
|        |                    |                    |                    | ±2%                | GCM1885C2A130GA16# |        |               |         |                    | ±5%  | GCM1885C2A750JA16# |
|        |                    |                    |                    | ±5%                | GCM1885C2A130JA16# |        |               |         | 82pF               | ±1%  | GCM1885C2A820FA16# |
|        |                    |                    | 15pF               | ±1%                | GCM1885C2A150FA16# |        |               |         |                    | ±2%  | GCM1885C2A820GA16# |
|        |                    |                    |                    | ±2%                | GCM1885C2A150GA16# |        |               |         |                    | ±5%  | GCM1885C2A820JA16# |
|        |                    |                    |                    | ±5%                | GCM1885C2A150JA16# |        |               |         | 91pF               | ±1%  | GCM1885C2A910FA16# |
|        |                    |                    | 16pF               | ±1%                | GCM1885C2A160FA16# |        |               |         |                    | ±2%  | GCM1885C2A910GA16# |
|        |                    |                    |                    | ±2%                | GCM1885C2A160GA16# |        |               |         |                    | ±5%  | GCM1885C2A910JA16# |
|        |                    |                    |                    | ±5%                | GCM1885C2A160JA16# |        |               |         | 100pF              | ±1%  | GCM1885C2A101FA16# |
|        |                    |                    | 18pF               | ±1%                | GCM1885C2A180FA16# |        |               |         |                    | ±2%  | GCM1885C2A101GA16# |
|        |                    |                    |                    | ±2%                | GCM1885C2A180GA16# |        |               |         |                    | ±5%  | GCM1885C2A101JA16# |
|        |                    |                    |                    | ±5%                | GCM1885C2A180JA16# |        |               |         | 110pF              | ±1%  | GCM1885C2A111FA16# |
|        |                    |                    | 20pF               | ±1%                | GCM1885C2A200FA16# |        |               |         |                    | ±2%  | GCM1885C2A111GA16# |
| ±2%    | GCM1885C2A200GA16# | ±5%                |                    | GCM1885C2A111JA16# |                    |        |               |         |                    |      |                    |
| ±5%    | GCM1885C2A200JA16# | 120pF              |                    | ±1%                | GCM1885C2A121FA16# |        |               |         |                    |      |                    |
| 22pF   | ±1%                |                    | GCM1885C2A220FA16# | ±2%                | GCM1885C2A121GA16# |        |               |         |                    |      |                    |
|        | ±2%                |                    | GCM1885C2A220GA16# | ±5%                | GCM1885C2A121JA16# |        |               |         |                    |      |                    |
|        | ±5%                | GCM1885C2A220JA16# | 130pF              | ±1%                | GCM1885C2A131FA16# |        |               |         |                    |      |                    |
| 24pF   | ±1%                | GCM1885C2A240FA16# |                    |                    |                    |        |               |         |                    |      |                    |

GRT Series  
 GCM Series  
 GC3 Series  
 GCJ Series  
 GCQ Series  
 GCD Series  
 GCE Series  
 NMF Series  
 KCM Series  
 KC3 Series  
 KCA Series  
 GCB Series  
 GCG Series  
 △Caution /Notice

Part number # indicates the package specification code.

# GCM Series Temperature Compensating Type Part Number List

(→ 1.6×0.8mm)

| T max. | Rated Voltage | TC Code | Cap.  | Tol.               | Part Number        | T max. | Rated Voltage | TC Code | Cap.    | Tol.   | Part Number        |                    |
|--------|---------------|---------|-------|--------------------|--------------------|--------|---------------|---------|---------|--------|--------------------|--------------------|
| 0.9mm  | 100Vdc        | COG     | 130pF | ±2%                | GCM1885C2A131GA16# | 0.9mm  | 100Vdc        | COG     | 750pF   | ±2%    | GCM1885C2A751GA16# |                    |
|        |               |         |       | ±5%                | GCM1885C2A131JA16# |        |               |         |         | ±5%    | GCM1885C2A751JA16# |                    |
|        |               |         | 150pF | ±1%                | GCM1885C2A151FA16# |        |               |         | 820pF   | ±1%    | GCM1885C2A821FA16# |                    |
|        |               |         |       | ±2%                | GCM1885C2A151GA16# |        |               |         |         | ±2%    | GCM1885C2A821GA16# |                    |
|        |               |         |       | ±5%                | GCM1885C2A151JA16# |        |               |         |         | ±5%    | GCM1885C2A821JA16# |                    |
|        |               |         | 160pF | ±1%                | GCM1885C2A161FA16# |        |               |         | 910pF   | ±1%    | GCM1885C2A911FA16# |                    |
|        |               |         |       | ±2%                | GCM1885C2A161GA16# |        |               |         |         | ±2%    | GCM1885C2A911GA16# |                    |
|        |               |         |       | ±5%                | GCM1885C2A161JA16# |        |               |         |         | ±5%    | GCM1885C2A911JA16# |                    |
|        |               |         | 180pF | ±1%                | GCM1885C2A181FA16# |        |               |         | 1000pF  | ±1%    | GCM1885C2A102FA16# |                    |
|        |               |         |       | ±2%                | GCM1885C2A181GA16# |        |               |         |         | ±2%    | GCM1885C2A102GA16# |                    |
|        |               |         |       | ±5%                | GCM1885C2A181JA16# |        |               |         |         | ±5%    | GCM1885C2A102JA16# |                    |
|        |               |         | 200pF | ±1%                | GCM1885C2A201FA16# |        |               |         | 1200pF  | ±1%    | GCM1885C2A122FA16# |                    |
|        |               |         |       | ±2%                | GCM1885C2A201GA16# |        |               |         |         | ±2%    | GCM1885C2A122GA16# |                    |
|        |               |         |       | ±5%                | GCM1885C2A201JA16# |        |               |         |         | ±5%    | GCM1885C2A122JA16# |                    |
|        |               |         | 220pF | ±1%                | GCM1885C2A221FA16# |        |               |         | 1300pF  | ±2%    | GCM1885C2A132GA16# |                    |
|        |               |         |       | ±2%                | GCM1885C2A221GA16# |        |               |         |         | ±5%    | GCM1885C2A132JA16# |                    |
|        |               |         |       | ±5%                | GCM1885C2A221JA16# |        |               |         |         | 1500pF | ±2%                | GCM1885C2A152GA16# |
|        |               |         | 240pF | ±1%                | GCM1885C2A241FA16# |        |               |         | ±5%     |        | GCM1885C2A152JA16# |                    |
|        |               |         |       | ±2%                | GCM1885C2A241GA16# |        |               |         | U2J     | 1000pF | ±5%                | GCM1887U2A102JA16# |
|        |               |         | ±5%   | GCM1885C2A241JA16# | 1100pF             |        |               |         |         | ±5%    | GCM1887U2A112JA16# |                    |
|        |               |         | 270pF | ±1%                | GCM1885C2A271FA16# |        |               |         |         | 1200pF | ±5%                | GCM1887U2A122JA16# |
|        |               |         |       | ±2%                | GCM1885C2A271GA16# |        |               |         |         | 1300pF | ±5%                | GCM1887U2A132JA16# |
|        |               |         |       | ±5%                | GCM1885C2A271JA16# |        |               |         |         | 1500pF | ±5%                | GCM1887U2A152JA16# |
|        |               |         | 300pF | ±1%                | GCM1885C2A301FA16# |        |               |         |         | 1600pF | ±5%                | GCM1887U2A162JA16# |
|        |               |         |       | ±2%                | GCM1885C2A301GA16# |        |               |         |         | 1800pF | ±5%                | GCM1887U2A182JA16# |
|        |               |         |       | ±5%                | GCM1885C2A301JA16# |        |               |         |         | 2000pF | ±5%                | GCM1887U2A202JA16# |
|        |               |         | 330pF | ±1%                | GCM1885C2A331FA16# |        |               |         |         | 2200pF | ±5%                | GCM1887U2A222JA16# |
|        |               |         |       | ±2%                | GCM1885C2A331GA16# |        |               |         |         | 2400pF | ±5%                | GCM1887U2A242JA16# |
|        |               |         |       | ±5%                | GCM1885C2A331JA16# |        |               |         |         | 2700pF | ±5%                | GCM1887U2A272JA16# |
|        |               |         | 360pF | ±1%                | GCM1885C2A361FA16# |        |               |         |         | 3000pF | ±5%                | GCM1887U2A302JA16# |
|        |               |         |       | ±2%                | GCM1885C2A361GA16# |        |               |         |         | 3300pF | ±5%                | GCM1887U2A332JA16# |
|        |               |         |       | ±5%                | GCM1885C2A361JA16# |        |               |         |         | 3600pF | ±5%                | GCM1887U2A362JA16# |
|        |               |         | 390pF | ±1%                | GCM1885C2A391FA16# |        |               |         | 3900pF  | ±5%    | GCM1887U2A392JA16# |                    |
|        |               |         |       | ±2%                | GCM1885C2A391GA16# |        |               |         | 4300pF  | ±5%    | GCM1887U2A432JA16# |                    |
|        |               |         |       | ±5%                | GCM1885C2A391JA16# |        |               |         | 4700pF  | ±5%    | GCM1887U2A472JA16# |                    |
|        |               |         | 430pF | ±1%                | GCM1885C2A431FA16# |        |               |         | 5100pF  | ±5%    | GCM1887U2A512JA16# |                    |
|        |               |         |       | ±2%                | GCM1885C2A431GA16# |        |               |         | 5600pF  | ±5%    | GCM1887U2A562JA16# |                    |
|        |               |         |       | ±5%                | GCM1885C2A431JA16# |        |               |         | 6200pF  | ±5%    | GCM1887U2A622JA16# |                    |
|        |               |         | 470pF | ±1%                | GCM1885C2A471FA16# |        |               |         | 6800pF  | ±5%    | GCM1887U2A682JA16# |                    |
|        |               |         |       | ±2%                | GCM1885C2A471GA16# |        |               |         | 7500pF  | ±5%    | GCM1887U2A752JA16# |                    |
|        |               |         |       | ±5%                | GCM1885C2A471JA16# |        |               |         | 8200pF  | ±5%    | GCM1887U2A822JA16# |                    |
|        |               |         | 510pF | ±1%                | GCM1885C2A511FA16# |        |               |         | 9100pF  | ±5%    | GCM1887U2A912JA16# |                    |
|        |               |         |       | ±2%                | GCM1885C2A511GA16# |        |               |         | 10000pF | ±5%    | GCM1887U2A103JA16# |                    |
|        |               |         |       | ±5%                | GCM1885C2A511JA16# |        |               |         | X8G     | 10pF   | ±1%                | GCM1885G2A100FA16# |
|        |               |         | 560pF | ±1%                | GCM1885C2A561FA16# |        |               |         |         |        | ±2.5%              | GCM1885G2A100RA16# |
|        |               |         |       | ±2%                | GCM1885C2A561GA16# |        |               |         |         |        | ±5%                | GCM1885G2A100JA16# |
|        |               |         |       | ±5%                | GCM1885C2A561JA16# |        |               |         |         | 11pF   | ±1%                | GCM1885G2A110FA16# |
|        |               |         | 620pF | ±1%                | GCM1885C2A621FA16# |        |               |         |         |        | ±2%                | GCM1885G2A110GA16# |
|        |               |         |       | ±2%                | GCM1885C2A621GA16# |        |               |         |         |        | ±5%                | GCM1885G2A110JA16# |
|        |               |         |       | ±5%                | GCM1885C2A621JA16# |        |               |         |         | 12pF   | ±1%                | GCM1885G2A120FA16# |
|        |               |         | 680pF | ±1%                | GCM1885C2A681FA16# |        |               |         |         |        | ±2%                | GCM1885G2A120GA16# |
|        |               |         |       | ±2%                | GCM1885C2A681GA16# |        |               |         |         |        | ±5%                | GCM1885G2A120JA16# |
|        |               |         |       | ±5%                | GCM1885C2A681JA16# |        |               |         |         | 13pF   | ±1%                | GCM1885G2A130FA16# |
|        |               |         | 750pF | ±1%                | GCM1885C2A751FA16# |        |               |         |         |        | ±2%                | GCM1885G2A130GA16# |

Part number # indicates the package specification code.

GRT Series  
 GCM Series  
 GC3 Series  
 GCJ Series  
 GCQ Series  
 GCD Series  
 GCE Series  
 NMF Series  
 KCM Series  
 KC3 Series  
 KCA Series  
 GCB Series  
 GCG Series  
 ⚠Caution /Notice

# GCM Series Temperature Compensating Type Part Number List

(→ 1.6×0.8mm)

| T max. | Rated Voltage      | TC Code            | Cap.  | Tol.               | Part Number        | T max. | Rated Voltage | TC Code | Cap.  | Tol.               | Part Number        |     |                    |
|--------|--------------------|--------------------|-------|--------------------|--------------------|--------|---------------|---------|-------|--------------------|--------------------|-----|--------------------|
| 0.9mm  | 100Vdc             | X8G                | 13pF  | ±5%                | GCM1885G2A130JA16# | 0.9mm  | 100Vdc        | X8G     | 75pF  | ±5%                | GCM1885G2A750JA16# |     |                    |
|        |                    |                    |       | 15pF               | ±1%                |        |               |         |       | GCM1885G2A150FA16# | 82pF               | ±1% | GCM1885G2A820FA16# |
|        |                    |                    |       |                    | ±2%                |        |               |         |       | GCM1885G2A150GA16# |                    | ±2% | GCM1885G2A820GA16# |
|        |                    |                    | ±5%   |                    | GCM1885G2A150JA16# |        |               |         | ±5%   | GCM1885G2A820JA16# |                    |     |                    |
|        |                    |                    | 16pF  | ±1%                | GCM1885G2A160FA16# |        |               |         | 91pF  | ±1%                | GCM1885G2A910FA16# |     |                    |
|        |                    |                    |       | ±2%                | GCM1885G2A160GA16# |        |               |         |       | ±2%                | GCM1885G2A910GA16# |     |                    |
|        |                    |                    |       | ±5%                | GCM1885G2A160JA16# |        |               |         |       | ±5%                | GCM1885G2A910JA16# |     |                    |
|        |                    |                    | 18pF  | ±1%                | GCM1885G2A180FA16# |        |               |         | 100pF | ±1%                | GCM1885G2A101FA16# |     |                    |
|        |                    |                    |       | ±2%                | GCM1885G2A180GA16# |        |               |         |       | ±2%                | GCM1885G2A101GA16# |     |                    |
|        |                    |                    |       | ±5%                | GCM1885G2A180JA16# |        |               |         |       | ±5%                | GCM1885G2A101JA16# |     |                    |
|        |                    |                    | 20pF  | ±1%                | GCM1885G2A200FA16# |        |               |         | 110pF | ±1%                | GCM1885G2A111FA16# |     |                    |
|        |                    |                    |       | ±2%                | GCM1885G2A200GA16# |        |               |         |       | ±2%                | GCM1885G2A111GA16# |     |                    |
|        |                    |                    |       | ±5%                | GCM1885G2A200JA16# |        |               |         |       | ±5%                | GCM1885G2A111JA16# |     |                    |
|        |                    |                    | 22pF  | ±1%                | GCM1885G2A220FA16# |        |               |         | 120pF | ±1%                | GCM1885G2A121FA16# |     |                    |
|        |                    |                    |       | ±2%                | GCM1885G2A220GA16# |        |               |         |       | ±2%                | GCM1885G2A121GA16# |     |                    |
|        |                    |                    |       | ±5%                | GCM1885G2A220JA16# |        |               |         |       | ±5%                | GCM1885G2A121JA16# |     |                    |
|        |                    |                    | 24pF  | ±1%                | GCM1885G2A240FA16# |        |               |         | 130pF | ±1%                | GCM1885G2A131FA16# |     |                    |
|        |                    |                    |       | ±2%                | GCM1885G2A240GA16# |        |               |         |       | ±2%                | GCM1885G2A131GA16# |     |                    |
|        |                    |                    |       | ±5%                | GCM1885G2A240JA16# |        |               |         |       | ±5%                | GCM1885G2A131JA16# |     |                    |
|        |                    |                    | 27pF  | ±1%                | GCM1885G2A270FA16# |        |               |         | 150pF | ±1%                | GCM1885G2A151FA16# |     |                    |
|        |                    |                    |       | ±2%                | GCM1885G2A270GA16# |        |               |         |       | ±2%                | GCM1885G2A151GA16# |     |                    |
|        |                    |                    |       | ±5%                | GCM1885G2A270JA16# |        |               |         |       | ±5%                | GCM1885G2A151JA16# |     |                    |
|        |                    |                    | 30pF  | ±1%                | GCM1885G2A300FA16# |        |               |         | 160pF | ±1%                | GCM1885G2A161FA16# |     |                    |
|        |                    |                    |       | ±2%                | GCM1885G2A300GA16# |        |               |         |       | ±2%                | GCM1885G2A161GA16# |     |                    |
|        |                    |                    |       | ±5%                | GCM1885G2A300JA16# |        |               |         |       | ±5%                | GCM1885G2A161JA16# |     |                    |
|        |                    |                    | 33pF  | ±1%                | GCM1885G2A330FA16# |        |               |         | 180pF | ±1%                | GCM1885G2A181FA16# |     |                    |
|        |                    |                    |       | ±2%                | GCM1885G2A330GA16# |        |               |         |       | ±2%                | GCM1885G2A181GA16# |     |                    |
|        |                    |                    |       | ±5%                | GCM1885G2A330JA16# |        |               |         |       | ±5%                | GCM1885G2A181JA16# |     |                    |
|        |                    |                    | 36pF  | ±1%                | GCM1885G2A360FA16# |        |               |         | 200pF | ±1%                | GCM1885G2A201FA16# |     |                    |
|        |                    |                    |       | ±2%                | GCM1885G2A360GA16# |        |               |         |       | ±2%                | GCM1885G2A201GA16# |     |                    |
|        |                    |                    |       | ±5%                | GCM1885G2A360JA16# |        |               |         |       | ±5%                | GCM1885G2A201JA16# |     |                    |
|        |                    |                    | 39pF  | ±1%                | GCM1885G2A390FA16# |        |               |         | 220pF | ±1%                | GCM1885G2A221FA16# |     |                    |
|        |                    |                    |       | ±2%                | GCM1885G2A390GA16# |        |               |         |       | ±2%                | GCM1885G2A221GA16# |     |                    |
|        |                    |                    |       | ±5%                | GCM1885G2A390JA16# |        |               |         |       | ±5%                | GCM1885G2A221JA16# |     |                    |
|        |                    |                    | 43pF  | ±1%                | GCM1885G2A430FA16# |        |               |         | 240pF | ±1%                | GCM1885G2A241FA16# |     |                    |
|        |                    |                    |       | ±2%                | GCM1885G2A430GA16# |        |               |         |       | ±2%                | GCM1885G2A241GA16# |     |                    |
|        |                    |                    |       | ±5%                | GCM1885G2A430JA16# |        |               |         |       | ±5%                | GCM1885G2A241JA16# |     |                    |
|        |                    |                    | 47pF  | ±1%                | GCM1885G2A470FA16# |        |               |         | 270pF | ±1%                | GCM1885G2A271FA16# |     |                    |
|        |                    |                    |       | ±2%                | GCM1885G2A470GA16# |        |               |         |       | ±2%                | GCM1885G2A271GA16# |     |                    |
|        |                    |                    |       | ±5%                | GCM1885G2A470JA16# |        |               |         |       | ±5%                | GCM1885G2A271JA16# |     |                    |
|        |                    |                    | 51pF  | ±1%                | GCM1885G2A510FA16# |        |               |         | 300pF | ±1%                | GCM1885G2A301FA16# |     |                    |
|        |                    |                    |       | ±2%                | GCM1885G2A510GA16# |        |               |         |       | ±2%                | GCM1885G2A301GA16# |     |                    |
| ±5%    | GCM1885G2A510JA16# | ±5%                |       | GCM1885G2A301JA16# |                    |        |               |         |       |                    |                    |     |                    |
| 56pF   | ±1%                | GCM1885G2A560FA16# | 330pF | ±1%                | GCM1885G2A331FA16# |        |               |         |       |                    |                    |     |                    |
|        | ±2%                | GCM1885G2A560GA16# |       | ±2%                | GCM1885G2A331GA16# |        |               |         |       |                    |                    |     |                    |
|        | ±5%                | GCM1885G2A560JA16# |       | ±5%                | GCM1885G2A331JA16# |        |               |         |       |                    |                    |     |                    |
| 62pF   | ±1%                | GCM1885G2A620FA16# | 360pF | ±1%                | GCM1885G2A361FA16# |        |               |         |       |                    |                    |     |                    |
|        | ±2%                | GCM1885G2A620GA16# |       | ±2%                | GCM1885G2A361GA16# |        |               |         |       |                    |                    |     |                    |
|        | ±5%                | GCM1885G2A620JA16# |       | ±5%                | GCM1885G2A361JA16# |        |               |         |       |                    |                    |     |                    |
| 68pF   | ±1%                | GCM1885G2A680FA16# | 390pF | ±1%                | GCM1885G2A391FA16# |        |               |         |       |                    |                    |     |                    |
|        | ±2%                | GCM1885G2A680GA16# |       | ±2%                | GCM1885G2A391GA16# |        |               |         |       |                    |                    |     |                    |
|        | ±5%                | GCM1885G2A680JA16# |       | ±5%                | GCM1885G2A391JA16# |        |               |         |       |                    |                    |     |                    |
| 75pF   | ±1%                | GCM1885G2A750FA16# | 430pF | ±1%                | GCM1885G2A431FA16# |        |               |         |       |                    |                    |     |                    |
|        | ±2%                | GCM1885G2A750GA16# |       | ±2%                | GCM1885G2A431GA16# |        |               |         |       |                    |                    |     |                    |

GRT Series  
 GCM Series  
 GC3 Series  
 GCJ Series  
 GCQ Series  
 GCD Series  
 GCE Series  
 NMF Series  
 KCM Series  
 KC3 Series  
 KCA Series  
 GCB Series  
 GCG Series  
 ⚠Caution / Notice

Part number # indicates the package specification code.



# GCM Series Temperature Compensating Type Part Number List

(→ 1.6×0.8mm)

| T max. | Rated Voltage | TC Code | Cap.   | Tol. | Part Number        | T max. | Rated Voltage | TC Code | Cap.   | Tol.               | Part Number        |                    |                    |                    |                    |                    |
|--------|---------------|---------|--------|------|--------------------|--------|---------------|---------|--------|--------------------|--------------------|--------------------|--------------------|--------------------|--------------------|--------------------|
| 0.9mm  | 100Vdc        | X8G     | 430pF  | ±5%  | GCM1885G2A431JA16# | 0.9mm  | 63Vdc         | COG     | 2200pF | ±2%                | GCM1885C1J222GA16# |                    |                    |                    |                    |                    |
|        |               |         |        | ±1%  | GCM1885G2A471FA16# |        |               |         |        | ±5%                | GCM1885C1J222JA16# |                    |                    |                    |                    |                    |
|        |               |         |        | ±2%  | GCM1885G2A471GA16# |        |               |         |        | 2400pF             | ±2%                | GCM1885C1J242GA16# |                    |                    |                    |                    |
|        |               |         |        | ±5%  | GCM1885G2A471JA16# |        |               |         |        |                    | ±5%                | GCM1885C1J242JA16# |                    |                    |                    |                    |
|        |               |         | 510pF  | ±1%  | GCM1885G2A511FA16# |        |               |         | 2700pF | ±2%                | GCM1885C1J272GA16# |                    |                    |                    |                    |                    |
|        |               |         |        | ±2%  | GCM1885G2A511GA16# |        |               |         |        | ±5%                | GCM1885C1J272JA16# |                    |                    |                    |                    |                    |
|        |               |         |        | ±5%  | GCM1885G2A511JA16# |        |               |         |        | 3000pF             | ±2%                | GCM1885C1J302GA16# |                    |                    |                    |                    |
|        |               |         | 560pF  | ±1%  | GCM1885G2A561FA16# |        |               |         | ±5%    |                    | GCM1885C1J302JA16# |                    |                    |                    |                    |                    |
|        |               |         |        | ±2%  | GCM1885G2A561GA16# |        |               |         | 3300pF | ±2%                | GCM1885C1J332GA16# |                    |                    |                    |                    |                    |
|        |               |         |        | ±5%  | GCM1885G2A561JA16# |        |               |         |        | ±5%                | GCM1885C1J332JA16# |                    |                    |                    |                    |                    |
|        |               |         | 620pF  | ±1%  | GCM1885G2A621FA16# |        |               |         | 3600pF | ±2%                | GCM1885C1J362GA16# |                    |                    |                    |                    |                    |
|        |               |         |        | ±2%  | GCM1885G2A621GA16# |        |               |         |        | ±5%                | GCM1885C1J362JA16# |                    |                    |                    |                    |                    |
|        |               |         |        | ±5%  | GCM1885G2A621JA16# |        |               |         |        | 3900pF             | ±2%                | GCM1885C1J392GA16# |                    |                    |                    |                    |
|        |               |         | 680pF  | ±1%  | GCM1885G2A681FA16# |        |               |         | ±5%    |                    | GCM1885C1J392JA16# |                    |                    |                    |                    |                    |
|        |               |         |        | ±2%  | GCM1885G2A681GA16# |        |               |         | 50Vdc  | COG                | 1100pF             | ±1%                | GCM1885C1H112FA16# |                    |                    |                    |
|        |               |         |        | ±5%  | GCM1885G2A681JA16# |        |               |         |        |                    |                    | ±2%                | GCM1885C1H112GA16# |                    |                    |                    |
|        |               |         | 750pF  | ±1%  | GCM1885G2A751FA16# |        |               |         |        |                    |                    | ±5%                | GCM1885C1H112JA16# |                    |                    |                    |
|        |               |         |        | ±2%  | GCM1885G2A751GA16# |        |               |         | 1200pF | ±1%                | GCM1885C1H122FA16# |                    |                    |                    |                    |                    |
|        |               |         |        | ±5%  | GCM1885G2A751JA16# |        |               |         |        | ±2%                | GCM1885C1H122GA16# |                    |                    |                    |                    |                    |
|        |               |         | 820pF  | ±1%  | GCM1885G2A821FA16# |        |               |         | ±5%    | GCM1885C1H122JA16# | 1300pF             | ±1%                | GCM1885C1H132FA16# |                    |                    |                    |
|        |               |         |        | ±2%  | GCM1885G2A821GA16# |        |               |         | ±2%    | GCM1885C1H132GA16# |                    |                    |                    |                    |                    |                    |
|        |               |         |        | ±5%  | GCM1885G2A821JA16# |        |               |         | ±5%    | GCM1885C1H132JA16# |                    |                    |                    |                    |                    |                    |
|        |               |         | 910pF  | ±1%  | GCM1885G2A911FA16# |        |               |         | 1500pF | ±1%                | GCM1885C1H152FA16# |                    |                    |                    |                    |                    |
|        |               |         |        | ±2%  | GCM1885G2A911GA16# |        |               |         |        | ±2%                | GCM1885C1H152GA16# |                    |                    |                    |                    |                    |
|        |               |         |        | ±5%  | GCM1885G2A911JA16# |        |               |         |        | ±5%                | GCM1885C1H152JA16# |                    |                    |                    |                    |                    |
|        |               |         | 1000pF | ±1%  | GCM1885G2A102FA16# |        |               |         | 1600pF | ±1%                | GCM1885C1H162FA16# |                    |                    |                    |                    |                    |
|        |               |         |        | ±2%  | GCM1885G2A102GA16# |        |               |         |        | ±2%                | GCM1885C1H162GA16# |                    |                    |                    |                    |                    |
|        |               |         |        | ±5%  | GCM1885G2A102JA16# |        |               |         |        | ±5%                | GCM1885C1H162JA16# |                    |                    |                    |                    |                    |
|        |               |         | 80Vdc  | COG  | 1600pF             |        |               |         | ±2%    | GCM1885C1K162GA16# | 1800pF             | ±1%                | GCM1885C1H182FA16# |                    |                    |                    |
|        |               |         |        |      |                    |        |               |         | ±5%    | GCM1885C1K162JA16# |                    | ±2%                | GCM1885C1H182GA16# |                    |                    |                    |
|        |               |         |        |      | 1800pF             |        |               |         | ±2%    | GCM1885C1K182GA16# |                    | ±5%                | GCM1885C1H182JA16# |                    |                    |                    |
|        |               |         |        |      |                    |        |               |         | ±5%    | GCM1885C1K182JA16# |                    | 2000pF             | ±1%                | GCM1885C1H202FA16# |                    |                    |
|        |               |         |        |      | 2000pF             |        |               |         | ±2%    | GCM1885C1K202GA16# |                    |                    | ±2%                | GCM1885C1H202GA16# |                    |                    |
|        |               |         |        |      |                    |        |               |         | ±5%    | GCM1885C1K202JA16# |                    | ±5%                | GCM1885C1H202JA16# |                    |                    |                    |
|        |               |         |        |      | 2200pF             |        |               |         | ±2%    | GCM1885C1K222GA16# |                    | 2200pF             | ±1%                | GCM1885C1H222FA16# |                    |                    |
|        |               |         |        |      |                    |        |               |         | ±5%    | GCM1885C1K222JA16# |                    |                    | ±2%                | GCM1885C1H222GA16# |                    |                    |
|        |               |         |        |      | 2400pF             |        |               |         | ±2%    | GCM1885C1K242GA16# |                    | ±5%                | GCM1885C1H222JA16# | 2400pF             | ±1%                | GCM1885C1H242FA16# |
|        |               |         |        |      |                    |        |               |         | ±5%    | GCM1885C1K242JA16# |                    | ±2%                | GCM1885C1H242GA16# |                    |                    |                    |
|        |               |         |        |      | 2700pF             |        |               |         | ±2%    | GCM1885C1K272GA16# |                    | ±5%                | GCM1885C1H242JA16# | 2700pF             | ±1%                | GCM1885C1H272FA16# |
|        |               |         |        |      |                    |        |               |         | ±5%    | GCM1885C1K272JA16# |                    | ±2%                | GCM1885C1H272GA16# |                    |                    |                    |
|        |               |         |        |      | 3000pF             |        |               |         | ±2%    | GCM1885C1K302GA16# |                    | ±5%                | GCM1885C1K302JA16# | ±5%                | GCM1885C1H272JA16# |                    |
|        |               |         |        |      |                    |        |               |         | ±5%    | GCM1885C1K302JA16# |                    | 3300pF             | ±2%                | GCM1885C1K332GA16# |                    |                    |
|        |               |         |        |      | 3300pF             |        |               |         | ±2%    | GCM1885C1K332GA16# |                    |                    | ±5%                | GCM1885C1K332JA16# | ±2%                | GCM1885C1H332FA16# |
|        |               |         |        |      |                    |        |               |         | 3600pF | ±2%                |                    | GCM1885C1K362GA16# | ±5%                | GCM1885C1K362JA16# | ±5%                | GCM1885C1H332JA16# |
|        |               |         |        |      | 3900pF             |        |               |         |        | ±2%                |                    | GCM1885C1K392GA16# | 63Vdc              | COG                | 1600pF             | ±2%                |
|        |               |         |        |      |                    |        |               |         | ±5%    | GCM1885C1K392JA16# |                    | ±5%                |                    |                    |                    | GCM1885C1J162JA16# |
|        |               |         |        |      | 1800pF             |        |               |         | ±2%    | GCM1885C1J182GA16# |                    | 1800pF             | ±2%                | GCM1885C1J182GA16# |                    |                    |
|        |               |         |        |      |                    |        |               |         | ±5%    | GCM1885C1J182JA16# |                    |                    | ±5%                | GCM1885C1J182JA16# |                    |                    |
|        |               |         |        |      | 2000pF             |        |               |         | ±2%    | GCM1885C1J202GA16# |                    | 2000pF             | ±2%                | GCM1885C1J202GA16# |                    |                    |
|        |               |         |        |      |                    |        |               |         | ±5%    | GCM1885C1J202JA16# |                    |                    | ±5%                | GCM1885C1J202JA16# |                    |                    |

GRT Series  
 GCM Series  
 GC3 Series  
 GCJ Series  
 GCQ Series  
 GCD Series  
 GCE Series  
 NMF Series  
 KCM Series  
 KC3 Series  
 KCA Series  
 GCB Series  
 GCG Series  
 ⚠Caution / Notice

Part number # indicates the package specification code.

# GCM Series Temperature Compensating Type Part Number List

(→ 1.6×0.8mm)

| T max. | Rated Voltage | TC Code | Cap.    | Tol.               | Part Number        |                    |                    |                    |
|--------|---------------|---------|---------|--------------------|--------------------|--------------------|--------------------|--------------------|
| 0.9mm  | 50Vdc         | COG     | 3900pF  | ±2%                | GCM1885C1H392GA16# |                    |                    |                    |
|        |               |         |         | ±5%                | GCM1885C1H392JA16# |                    |                    |                    |
|        |               |         | 4300pF  | ±2%                | GCM1885C1H432GA16# |                    |                    |                    |
|        |               |         |         | ±5%                | GCM1885C1H432JA16# |                    |                    |                    |
|        |               |         | 4700pF  | ±1%                | GCM1885C1H472FA16# |                    |                    |                    |
|        |               |         |         | ±2%                | GCM1885C1H472GA16# |                    |                    |                    |
|        |               |         |         | ±5%                | GCM1885C1H472JA16# |                    |                    |                    |
|        |               |         | 5100pF  | ±2%                | GCM1885C1H512GA16# |                    |                    |                    |
|        |               |         |         | ±5%                | GCM1885C1H512JA16# |                    |                    |                    |
|        |               |         |         | 5600pF             | ±2%                | GCM1885C1H562GA16# |                    |                    |
|        |               |         | ±5%     |                    | GCM1885C1H562JA16# |                    |                    |                    |
|        |               |         | 6200pF  | ±2%                | GCM1885C1H622GA16# |                    |                    |                    |
|        |               |         |         | ±5%                | GCM1885C1H622JA16# |                    |                    |                    |
|        |               |         | 6800pF  | ±2%                | GCM1885C1H682GA16# |                    |                    |                    |
|        |               |         |         | ±5%                | GCM1885C1H682JA16# |                    |                    |                    |
|        |               |         | 7500pF  | ±2%                | GCM1885C1H752GA16# |                    |                    |                    |
|        |               |         |         | ±5%                | GCM1885C1H752JA16# |                    |                    |                    |
|        |               |         | 8200pF  | ±2%                | GCM1885C1H822GA16# |                    |                    |                    |
|        |               |         |         | ±5%                | GCM1885C1H822JA16# |                    |                    |                    |
|        |               |         | 9100pF  | ±2%                | GCM1885C1H912GA16# |                    |                    |                    |
|        |               |         |         | ±5%                | GCM1885C1H912JA16# |                    |                    |                    |
|        |               |         | 10000pF | ±2%                | GCM1885C1H103GA16# |                    |                    |                    |
|        |               |         |         | ±5%                | GCM1885C1H103JA16# |                    |                    |                    |
|        |               |         | U2J     | 50Vdc              | COG                | 1000pF             | ±5%                | GCM1887U1H102JA16# |
|        |               |         |         |                    |                    |                    | ±5%                | GCM1887U1H112JA16# |
|        |               |         |         |                    |                    |                    | ±5%                | GCM1887U1H122JA16# |
|        |               |         |         |                    |                    |                    | ±5%                | GCM1887U1H132JA16# |
|        |               |         |         |                    |                    |                    | ±5%                | GCM1887U1H152JA16# |
|        |               |         |         |                    |                    |                    | ±5%                | GCM1887U1H162JA16# |
|        |               |         |         |                    |                    |                    | ±5%                | GCM1887U1H182JA16# |
|        |               |         |         |                    |                    |                    | ±5%                | GCM1887U1H202JA16# |
|        |               |         |         |                    |                    |                    | ±5%                | GCM1887U1H222JA16# |
|        |               |         |         |                    |                    |                    | ±5%                | GCM1887U1H242JA16# |
|        |               |         |         |                    |                    |                    | ±5%                | GCM1887U1H272JA16# |
|        |               |         |         |                    |                    |                    | ±5%                | GCM1887U1H302JA16# |
|        |               |         |         |                    |                    |                    | ±5%                | GCM1887U1H332JA16# |
|        |               | ±5%     |         |                    |                    |                    | GCM1887U1H362JA16# |                    |
|        |               | ±5%     |         |                    |                    |                    | GCM1887U1H392JA16# |                    |
|        |               | ±5%     |         |                    |                    |                    | GCM1887U1H432JA16# |                    |
|        |               | ±5%     |         |                    |                    |                    | GCM1887U1H472JA16# |                    |
|        |               | ±5%     |         |                    |                    |                    | GCM1887U1H512JA16# |                    |
|        |               | ±5%     |         |                    |                    |                    | GCM1887U1H562JA16# |                    |
|        |               | ±5%     |         |                    |                    |                    | GCM1887U1H622JA16# |                    |
|        |               | X8G     |         |                    |                    |                    | 50Vdc              | COG                |
|        |               |         | ±2%     | GCM1885G1H112GA16# |                    |                    |                    |                    |
|        |               |         | ±5%     | GCM1885G1H112JA16# |                    |                    |                    |                    |
|        |               |         | 1200pF  | ±1%                | GCM1885G1H122FA16# |                    |                    |                    |
|        |               |         |         | ±2%                | GCM1885G1H122GA16# |                    |                    |                    |
|        |               |         |         | ±5%                | GCM1885G1H122JA16# |                    |                    |                    |

| T max. | Rated Voltage | TC Code | Cap.   | Tol. | Part Number        |
|--------|---------------|---------|--------|------|--------------------|
| 0.9mm  | 50Vdc         | X8G     | 1300pF | ±1%  | GCM1885G1H132FA16# |
|        |               |         |        | ±2%  | GCM1885G1H132GA16# |
|        |               |         |        | ±5%  | GCM1885G1H132JA16# |
|        |               |         | 1500pF | ±1%  | GCM1885G1H152FA16# |
|        |               |         |        | ±2%  | GCM1885G1H152GA16# |
|        |               |         |        | ±5%  | GCM1885G1H152JA16# |
|        |               |         | 1600pF | ±1%  | GCM1885G1H162FA16# |
|        |               |         |        | ±2%  | GCM1885G1H162GA16# |
|        |               |         |        | ±5%  | GCM1885G1H162JA16# |
|        |               |         | 1800pF | ±1%  | GCM1885G1H182FA16# |
|        |               |         |        | ±2%  | GCM1885G1H182GA16# |
|        |               |         |        | ±5%  | GCM1885G1H182JA16# |
|        |               |         | 2000pF | ±1%  | GCM1885G1H202FA16# |
|        |               |         |        | ±2%  | GCM1885G1H202GA16# |
|        |               |         |        | ±5%  | GCM1885G1H202JA16# |
|        |               |         | 2200pF | ±1%  | GCM1885G1H222FA16# |
|        |               |         |        | ±2%  | GCM1885G1H222GA16# |
|        |               |         |        | ±5%  | GCM1885G1H222JA16# |
|        |               |         | 2400pF | ±1%  | GCM1885G1H242FA16# |
|        |               |         |        | ±2%  | GCM1885G1H242GA16# |
|        |               |         |        | ±5%  | GCM1885G1H242JA16# |
|        |               |         | 2700pF | ±1%  | GCM1885G1H272FA16# |
|        |               |         |        | ±2%  | GCM1885G1H272GA16# |
|        |               |         |        | ±5%  | GCM1885G1H272JA16# |

## 2.0×1.25mm

| T max. | Rated Voltage | TC Code | Cap.   | Tol. | Part Number        |     |                    |
|--------|---------------|---------|--------|------|--------------------|-----|--------------------|
| 0.7mm  | 100Vdc        | COG     | 1600pF | ±1%  | GCM2165C2A162FA16# |     |                    |
|        |               |         |        | ±2%  | GCM2165C2A162GA16# |     |                    |
|        |               |         |        | ±5%  | GCM2165C2A162JA16# |     |                    |
|        |               |         | 1800pF | ±1%  | GCM2165C2A182FA16# |     |                    |
|        |               |         |        | ±2%  | GCM2165C2A182GA16# |     |                    |
|        |               |         |        | ±5%  | GCM2165C2A182JA16# |     |                    |
|        |               |         | 2000pF | ±1%  | GCM2165C2A202FA16# |     |                    |
|        |               |         |        | ±2%  | GCM2165C2A202GA16# |     |                    |
|        |               |         |        | ±5%  | GCM2165C2A202JA16# |     |                    |
|        |               |         | 2200pF | ±1%  | GCM2165C2A222FA16# |     |                    |
|        |               |         |        | ±2%  | GCM2165C2A222GA16# |     |                    |
|        |               |         |        | ±5%  | GCM2165C2A222JA16# |     |                    |
|        |               |         | 2400pF | ±1%  | GCM2165C2A242FA16# |     |                    |
|        |               |         |        | ±2%  | GCM2165C2A242GA16# |     |                    |
|        |               |         |        | ±5%  | GCM2165C2A242JA16# |     |                    |
|        |               |         | 2700pF | ±1%  | GCM2165C2A272FA16# |     |                    |
|        |               |         |        | ±2%  | GCM2165C2A272GA16# |     |                    |
|        |               |         |        | ±5%  | GCM2165C2A272JA16# |     |                    |
|        |               |         | 3000pF | ±1%  | GCM2165C2A302FA16# |     |                    |
|        |               |         |        | ±2%  | GCM2165C2A302GA16# |     |                    |
|        |               |         |        | ±5%  | GCM2165C2A302JA16# |     |                    |
|        |               |         | 3300pF | ±1%  | GCM2165C2A332FA16# |     |                    |
|        |               |         |        | ±2%  | GCM2165C2A332GA16# |     |                    |
|        |               |         |        | ±5%  | GCM2165C2A332JA16# |     |                    |
|        |               |         | 80Vdc  | COG  | 4300pF             | ±1% | GCM2165C1K432FA16# |

Part number # indicates the package specification code.

GRT Series  
 GCM Series  
 GC3 Series  
 GCJ Series  
 GCQ Series  
 GCD Series  
 GCE Series  
 NMF Series  
 KCM Series  
 KC3 Series  
 KCA Series  
 GCB Series  
 GCG Series  
 ⚠Caution /Notice

# GCM Series Temperature Compensating Type Part Number List

(→ 2.0×1.25mm)

| T max.  | Rated Voltage | TC Code            | Cap.               | Tol.   | Part Number        | T max.             | Rated Voltage      | TC Code            | Cap.               | Tol.               | Part Number        |                    |                    |                    |
|---------|---------------|--------------------|--------------------|--------|--------------------|--------------------|--------------------|--------------------|--------------------|--------------------|--------------------|--------------------|--------------------|--------------------|
| 0.7mm   | 80Vdc         | COG                | 4300pF             | ±2%    | GCM2165C1K432GA16# | 0.95mm             | 80Vdc              | COG                | 13000pF            | ±2%                | GCM2195C1K133GA16# |                    |                    |                    |
|         |               |                    |                    | ±5%    | GCM2165C1K432JA16# |                    |                    |                    |                    | ±2%                | GCM2195C1K133JA16# |                    |                    |                    |
|         |               |                    | 4700pF             | ±1%    | GCM2165C1K472FA16# |                    |                    |                    | 15000pF            | ±1%                | GCM2195C1K153FA16# |                    |                    |                    |
|         |               |                    |                    | ±2%    | GCM2165C1K472GA16# |                    |                    |                    |                    | ±2%                | GCM2195C1K153GA16# |                    |                    |                    |
|         |               |                    |                    | ±5%    | GCM2165C1K472JA16# |                    |                    |                    | ±5%                | GCM2195C1K153JA16# |                    |                    |                    |                    |
|         |               |                    |                    | 50Vdc  | X8G                |                    |                    |                    | 3000pF             | ±2%                | GCM2165G1H302GA16# | 50Vdc              | COG                | 12000pF            |
|         | ±5%           | GCM2165G1H302JA16# | ±2%                |        |                    |                    | GCM2195C1H123GA16# |                    |                    |                    |                    |                    |                    |                    |
|         | 3300pF        | ±2%                | GCM2165G1H332GA16# |        |                    |                    | 13000pF            | ±1%                | GCM2195C1H133FA16# |                    |                    |                    |                    |                    |
|         |               | ±5%                | GCM2165G1H332JA16# |        |                    |                    |                    | ±2%                | GCM2195C1H133GA16# |                    |                    |                    |                    |                    |
|         | 3600pF        | ±2%                | GCM2165G1H362GA16# |        |                    |                    | 15000pF            | ±1%                | GCM2195C1H153FA16# |                    |                    |                    |                    |                    |
|         |               | ±5%                | GCM2165G1H362JA16# |        |                    |                    |                    | ±2%                | GCM2195C1H153GA16# |                    |                    |                    |                    |                    |
|         | 3900pF        | ±2%                | GCM2165G1H392GA16# |        |                    |                    | X8G                | 3900pF             | ±2%                | GCM2195G1H392GA16# |                    |                    |                    |                    |
|         |               | ±5%                | GCM2165G1H392JA16# |        |                    |                    |                    |                    | ±5%                | GCM2195G1H392JA16# |                    |                    |                    |                    |
|         | 4300pF        | ±2%                | GCM2165G1H432GA16# |        |                    |                    | 4300pF             | ±2%                | GCM2195G1H432GA16# |                    |                    |                    |                    |                    |
|         |               | ±5%                | GCM2165G1H432JA16# |        |                    |                    |                    | ±5%                | GCM2195G1H432JA16# |                    |                    |                    |                    |                    |
|         | 4700pF        | ±2%                | GCM2165G1H472GA16# |        |                    |                    | 4700pF             | ±2%                | GCM2195G1H472GA16# |                    |                    |                    |                    |                    |
|         |               | ±5%                | GCM2165G1H472JA16# |        |                    |                    |                    | ±5%                | GCM2195G1H472JA16# |                    |                    |                    |                    |                    |
|         | 0.95mm        | 100Vdc             | X8G                | 1100pF | ±2%                |                    | GCM2195G2A112GA16# | 1.0mm              | 630Vdc             | COG                | 10pF               | ±1%                | GCM21A5C2J100FX01# |                    |
| ±5%     |               |                    |                    |        | GCM2195G2A112JA16# | ±2%                | GCM21A5C2J100GX01# |                    |                    |                    |                    |                    |                    |                    |
| 1200pF  |               |                    |                    | ±2%    | GCM2195G2A122GA16# | ±5%                | GCM21A5C2J100JX01# |                    |                    |                    |                    |                    |                    |                    |
|         |               |                    |                    | ±5%    | GCM2195G2A122JA16# | 12pF               | ±1%                |                    |                    |                    | GCM21A5C2J120FX01# |                    |                    |                    |
| 1300pF  |               |                    |                    | ±2%    | GCM2195G2A132GA16# |                    | ±2%                |                    |                    |                    | GCM21A5C2J120GX01# |                    |                    |                    |
|         |               |                    |                    | ±5%    | GCM2195G2A132JA16# |                    | ±5%                |                    |                    |                    | GCM21A5C2J120JX01# |                    |                    |                    |
| 1500pF  |               |                    |                    | ±2%    | GCM2195G2A152GA16# | 5100pF             | ±2%                |                    |                    |                    | GCM2195G1H512GA16# |                    |                    |                    |
|         |               |                    |                    | ±5%    | GCM2195G2A152JA16# |                    | ±5%                |                    |                    |                    | GCM2195G1H512JA16# |                    |                    |                    |
| ZLM     |               |                    |                    | 1000pF | ±10%               | GCM2199E2A102KA05# | 5600pF             |                    |                    |                    | ±2%                | GCM2195G1H562GA16# |                    |                    |
|         |               |                    |                    |        | ±20%               | GCM2199E2A102MA05# |                    |                    |                    |                    | ±5%                | GCM2195G1H562JA16# |                    |                    |
|         |               |                    |                    |        | 1100pF             | ±10%               |                    |                    |                    |                    | GCM2199E2A112KA05# | 6200pF             | ±2%                | GCM2195G1H622GA16# |
|         |               |                    |                    |        |                    | ±20%               |                    |                    |                    |                    | GCM2199E2A112MA05# |                    | ±5%                | GCM2195G1H622JA16# |
|         |               |                    |                    |        | 1200pF             | ±10%               |                    |                    |                    |                    | GCM2199E2A122KA05# | 6800pF             | ±2%                | GCM2195G1H682GA16# |
|         |               |                    |                    |        |                    | ±20%               |                    |                    |                    |                    | GCM2199E2A122MA05# |                    | ±5%                | GCM2195G1H682JA16# |
|         |               |                    |                    |        | 1300pF             | ±10%               |                    |                    |                    |                    | GCM2199E2A132KA05# | 7500pF             | ±2%                | GCM2195G1H752GA16# |
|         |               |                    |                    |        |                    | ±20%               |                    |                    |                    |                    | GCM2199E2A132MA05# |                    | ±5%                | GCM2195G1H752JA16# |
|         |               |                    |                    |        | 1500pF             | ±10%               |                    |                    |                    |                    | GCM2199E2A152KA05# | 8200pF             | ±2%                | GCM2195G1H822GA16# |
|         |               |                    |                    |        |                    | ±20%               |                    |                    |                    |                    | GCM2199E2A152MA05# |                    | ±5%                | GCM2195G1H822JA16# |
|         |               | 80Vdc              | COG                |        | 5100pF             | ±1%                |                    | GCM2195C1K512FA16# | 9100pF             | ±2%                | GCM2195C1K912GA16# |                    |                    |                    |
|         |               |                    |                    |        |                    | ±1%                |                    | GCM2195C1K562FA16# |                    | ±5%                | GCM2195C1K912JA16# |                    |                    |                    |
| 6200pF  |               |                    |                    | ±2%    | GCM2195C1K622GA16# | 10000pF            | ±1%                | GCM2195C1K103FA16# |                    |                    |                    |                    |                    |                    |
|         |               |                    |                    | ±5%    | GCM2195C1K622JA16# |                    | ±2%                | GCM2195C1K103GA16# |                    |                    |                    |                    |                    |                    |
| 6800pF  |               |                    |                    | ±2%    | GCM2195C1K682GA16# | 11000pF            | ±2%                | GCM2195C1K113GA16# |                    |                    |                    |                    |                    |                    |
|         |               |                    |                    | ±5%    | GCM2195C1K682JA16# |                    | ±5%                | GCM2195C1K113JA16# |                    |                    |                    |                    |                    |                    |
| 7500pF  |               |                    |                    | ±2%    | GCM2195C1K752GA16# | 12000pF            | ±2%                | GCM2195C1K123GA16# |                    |                    |                    |                    |                    |                    |
|         |               |                    |                    | ±5%    | GCM2195C1K752JA16# |                    | ±5%                | GCM2195C1K123JA16# |                    |                    |                    |                    |                    |                    |
| 8200pF  |               |                    |                    | ±2%    | GCM2195C1K822GA16# | 10000pF            | ±2%                | GCM2195C1K103GA16# |                    |                    |                    |                    |                    |                    |
|         |               |                    |                    | ±5%    | GCM2195C1K822JA16# |                    | ±5%                | GCM2195C1K103JA16# |                    |                    |                    |                    |                    |                    |
| 9100pF  |               |                    |                    | ±2%    | GCM2195C1K912GA16# | 11000pF            | ±2%                | GCM2195C1K113GA16# |                    |                    |                    |                    |                    |                    |
|         |               |                    |                    | ±5%    | GCM2195C1K912JA16# |                    | ±5%                | GCM2195C1K113JA16# |                    |                    |                    |                    |                    |                    |
| 10000pF | ±1%           | GCM2195C1K103FA16# | 12000pF            | ±2%    | GCM2195C1K123GA16# |                    |                    |                    |                    |                    |                    |                    |                    |                    |
|         | ±2%           | GCM2195C1K103GA16# |                    | ±5%    | GCM2195C1K123JA16# |                    |                    |                    |                    |                    |                    |                    |                    |                    |
| 11000pF | ±2%           | GCM2195C1K113GA16# | 12000pF            | ±2%    | GCM2195C1K123GA16# |                    |                    |                    |                    |                    |                    |                    |                    |                    |
|         | ±5%           | GCM2195C1K113JA16# |                    | ±5%    | GCM2195C1K123JA16# |                    |                    |                    |                    |                    |                    |                    |                    |                    |
| 12000pF | ±2%           | GCM2195C1K123GA16# | 12000pF            | ±2%    | GCM2195C1K123GA16# |                    |                    |                    |                    |                    |                    |                    |                    |                    |
|         | ±5%           | GCM2195C1K123JA16# |                    | ±5%    | GCM2195C1K123JA16# |                    |                    |                    |                    |                    |                    |                    |                    |                    |

Part number # indicates the package specification code.

GRT Series  
 GCM Series  
 GC3 Series  
 GCJ Series  
 GCQ Series  
 GCD Series  
 GCE Series  
 NMF Series  
 KCM Series  
 KC3 Series  
 KCA Series  
 GCB Series  
 GCG Series  
 ⚠Caution /Notice

# GCM Series Temperature Compensating Type Power-train AEC-Q200 Part Number List

(→ 2.0×1.25mm)

| T max. | Rated Voltage | TC Code | Cap.   | Tol. | Part Number        | T max. | Rated Voltage | TC Code | Cap.  | Tol.               | Part Number        |       |                    |                    |
|--------|---------------|---------|--------|------|--------------------|--------|---------------|---------|-------|--------------------|--------------------|-------|--------------------|--------------------|
| 1.0mm  | 630Vdc        | COG     | 33pF   | ±1%  | GCM21A5C2J330FX01# | 1.0mm  | 250Vdc        | COG     | 15pF  | ±1%                | GCM21A5C2E150FX01# |       |                    |                    |
|        |               |         |        | ±2%  | GCM21A5C2J330GX01# |        |               |         |       | ±2%                | GCM21A5C2E150GX01# |       |                    |                    |
|        |               |         |        | ±5%  | GCM21A5C2J330JX01# |        |               |         |       | ±5%                | GCM21A5C2E150JX01# |       |                    |                    |
|        |               |         | 39pF   | ±1%  | GCM21A5C2J390FX01# |        |               |         | 18pF  | ±1%                | GCM21A5C2E180FX01# |       |                    |                    |
|        |               |         |        | ±2%  | GCM21A5C2J390GX01# |        |               |         |       | ±2%                | GCM21A5C2E180GX01# |       |                    |                    |
|        |               |         |        | ±5%  | GCM21A5C2J390JX01# |        |               |         |       | ±5%                | GCM21A5C2E180JX01# |       |                    |                    |
|        |               |         | 47pF   | ±1%  | GCM21A5C2J470FX01# |        |               |         | 22pF  | ±1%                | GCM21A5C2E220FX01# |       |                    |                    |
|        |               |         |        | ±2%  | GCM21A5C2J470GX01# |        |               |         |       | ±2%                | GCM21A5C2E220GX01# |       |                    |                    |
|        |               |         |        | ±5%  | GCM21A5C2J470JX01# |        |               |         |       | ±5%                | GCM21A5C2E220JX01# |       |                    |                    |
|        |               |         | 56pF   | ±1%  | GCM21A5C2J560FX01# |        |               |         | 27pF  | ±1%                | GCM21A5C2E270FX01# |       |                    |                    |
|        |               |         |        | ±2%  | GCM21A5C2J560GX01# |        |               |         |       | ±2%                | GCM21A5C2E270GX01# |       |                    |                    |
|        |               |         |        | ±5%  | GCM21A5C2J560JX01# |        |               |         |       | ±5%                | GCM21A5C2E270JX01# |       |                    |                    |
|        |               |         | 68pF   | ±1%  | GCM21A5C2J680FX01# |        |               |         | 33pF  | ±1%                | GCM21A5C2E330FX01# |       |                    |                    |
|        |               |         |        | ±2%  | GCM21A5C2J680GX01# |        |               |         |       | ±2%                | GCM21A5C2E330GX01# |       |                    |                    |
|        |               |         |        | ±5%  | GCM21A5C2J680JX01# |        |               |         |       | ±5%                | GCM21A5C2E330JX01# |       |                    |                    |
|        |               |         | 82pF   | ±1%  | GCM21A5C2J820FX01# |        |               |         | 39pF  | ±1%                | GCM21A5C2E390FX01# |       |                    |                    |
|        |               |         |        | ±2%  | GCM21A5C2J820GX01# |        |               |         |       | ±2%                | GCM21A5C2E390GX01# |       |                    |                    |
|        |               |         |        | ±5%  | GCM21A5C2J820JX01# |        |               |         |       | ±5%                | GCM21A5C2E390JX01# |       |                    |                    |
|        |               |         | 100pF  | ±1%  | GCM21A5C2J101FX01# |        |               |         | 47pF  | ±1%                | GCM21A5C2E470FX01# |       |                    |                    |
|        |               |         |        | ±2%  | GCM21A5C2J101GX01# |        |               |         |       | ±2%                | GCM21A5C2E470GX01# |       |                    |                    |
|        |               |         |        | ±5%  | GCM21A5C2J101JX01# |        |               |         |       | ±5%                | GCM21A5C2E470JX01# |       |                    |                    |
|        |               |         | 120pF  | ±1%  | GCM21A5C2J121FX01# |        |               |         | 56pF  | ±1%                | GCM21A5C2E560FX01# |       |                    |                    |
|        |               |         |        | ±2%  | GCM21A5C2J121GX01# |        |               |         |       | ±2%                | GCM21A5C2E560GX01# |       |                    |                    |
|        |               |         |        | ±5%  | GCM21A5C2J121JX01# |        |               |         |       | ±5%                | GCM21A5C2E560JX01# |       |                    |                    |
|        |               |         | 150pF  | ±1%  | GCM21A5C2J151FX01# |        |               |         | 68pF  | ±1%                | GCM21A5C2E680FX01# |       |                    |                    |
|        |               |         |        | ±2%  | GCM21A5C2J151GX01# |        |               |         |       | ±2%                | GCM21A5C2E680GX01# |       |                    |                    |
|        |               |         |        | ±5%  | GCM21A5C2J151JX01# |        |               |         |       | ±5%                | GCM21A5C2E680JX01# |       |                    |                    |
|        |               |         | 180pF  | ±1%  | GCM21A5C2J181FX01# |        |               |         | 82pF  | ±1%                | GCM21A5C2E820FX01# |       |                    |                    |
|        |               |         |        | ±2%  | GCM21A5C2J181GX01# |        |               |         |       | ±2%                | GCM21A5C2E820GX01# |       |                    |                    |
|        |               |         |        | ±5%  | GCM21A5C2J181JX01# |        |               |         |       | ±5%                | GCM21A5C2E820JX01# |       |                    |                    |
|        |               |         | 220pF  | ±1%  | GCM21A5C2J221FX01# |        |               |         | 100pF | ±1%                | GCM21A5C2E101FX01# |       |                    |                    |
|        |               |         |        | ±2%  | GCM21A5C2J221GX01# |        |               |         |       | ±2%                | GCM21A5C2E101GX01# |       |                    |                    |
|        |               |         |        | ±5%  | GCM21A5C2J221JX01# |        |               |         |       | ±5%                | GCM21A5C2E101JX01# |       |                    |                    |
|        |               |         | 270pF  | ±1%  | GCM21A5C2J271FX01# |        |               |         | 120pF | ±1%                | GCM21A5C2E121FX01# |       |                    |                    |
|        |               |         |        | ±2%  | GCM21A5C2J271GX01# |        |               |         |       | ±2%                | GCM21A5C2E121GX01# |       |                    |                    |
|        |               |         |        | ±5%  | GCM21A5C2J271JX01# |        |               |         |       | ±5%                | GCM21A5C2E121JX01# |       |                    |                    |
|        |               |         | 330pF  | ±1%  | GCM21A5C2J331FX01# |        |               |         | 150pF | ±1%                | GCM21A5C2E151FX01# |       |                    |                    |
|        |               |         |        | ±2%  | GCM21A5C2J331GX01# |        |               |         |       | ±2%                | GCM21A5C2E151GX01# |       |                    |                    |
|        |               |         |        | ±5%  | GCM21A5C2J331JX01# |        |               |         |       | ±5%                | GCM21A5C2E151JX01# |       |                    |                    |
|        |               |         | 390pF  | ±1%  | GCM21A5C2J391FX01# |        |               |         | 180pF | ±1%                | GCM21A5C2E181FX01# |       |                    |                    |
|        |               |         |        | ±2%  | GCM21A5C2J391GX01# |        |               |         |       | ±2%                | GCM21A5C2E181GX01# |       |                    |                    |
|        |               |         |        | ±5%  | GCM21A5C2J391JX01# |        |               |         |       | ±5%                | GCM21A5C2E181JX01# |       |                    |                    |
|        |               |         | 470pF  | ±1%  | GCM21A5C2J471FX01# |        |               |         | 220pF | ±1%                | GCM21A5C2E221FX01# |       |                    |                    |
|        |               |         |        | ±2%  | GCM21A5C2J471GX01# |        |               |         |       | ±2%                | GCM21A5C2E221GX01# |       |                    |                    |
|        |               |         |        | ±5%  | GCM21A5C2J471JX01# |        |               |         |       | ±5%                | GCM21A5C2E221JX01# |       |                    |                    |
|        |               |         | 560pF  | ±1%  | GCM21A5C2J561FX01# |        |               |         | 270pF | ±1%                | GCM21A5C2E271FX01# |       |                    |                    |
|        |               |         |        | ±2%  | GCM21A5C2J561GX01# |        |               |         |       | ±2%                | GCM21A5C2E271GX01# |       |                    |                    |
|        |               |         |        | ±5%  | GCM21A5C2J561JX01# |        |               |         |       | ±5%                | GCM21A5C2E271JX01# |       |                    |                    |
|        |               |         | 250Vdc | COG  | 10pF               |        |               |         | ±1%   | GCM21A5C2E100FX01# | 330pF              | ±1%   | GCM21A5C2E331FX01# |                    |
|        |               |         |        |      |                    |        |               |         | ±2%   | GCM21A5C2E100GX01# |                    | ±2%   | GCM21A5C2E331GX01# |                    |
|        |               |         |        |      |                    |        |               |         | ±5%   | GCM21A5C2E100JX01# |                    | ±5%   | GCM21A5C2E331JX01# |                    |
|        |               |         |        |      | 12pF               |        |               |         | ±1%   | GCM21A5C2E120FX01# |                    | 390pF | ±1%                | GCM21A5C2E391FX01# |
|        |               |         |        |      |                    |        |               |         | ±2%   | GCM21A5C2E120GX01# |                    |       | ±2%                | GCM21A5C2E391GX01# |
|        |               |         |        |      |                    |        |               |         | ±5%   | GCM21A5C2E120JX01# |                    |       | ±5%                | GCM21A5C2E391JX01# |

Part number # indicates the package specification code.

GRT Series  
 GCM Series  
 GC3 Series  
 GCJ Series  
 GCQ Series  
 GCD Series  
 GCE Series  
 NMF Series  
 KCM Series  
 KC3 Series  
 KCA Series  
 GCB Series  
 GCG Series  
 ⚠Caution /Notice

# GCM Series Temperature Compensating Type Part Number List

(→ 2.0×1.25mm)

| T max. | Rated Voltage | TC Code | Cap.   | Tol.               | Part Number        | T max. | Rated Voltage | TC Code | Cap.               | Tol.               | Part Number        |                    |                    |                    |     |                    |
|--------|---------------|---------|--------|--------------------|--------------------|--------|---------------|---------|--------------------|--------------------|--------------------|--------------------|--------------------|--------------------|-----|--------------------|
| 1.0mm  | 250Vdc        | COG     | 470pF  | ±1%                | GCM21A5C2E471FX01# | 1.4mm  | 50Vdc         | COG     | 18000pF            | ±2%                | GCM21B5C1H183GA16# |                    |                    |                    |     |                    |
|        |               |         |        | ±2%                | GCM21A5C2E471GX01# |        |               |         |                    | ±5%                | GCM21B5C1H183JA16# |                    |                    |                    |     |                    |
|        |               |         |        | ±5%                | GCM21A5C2E471JX01# |        |               |         |                    | 20000pF            | ±1%                | GCM21B5C1H203FA16# |                    |                    |     |                    |
|        |               |         | 560pF  | ±1%                | GCM21A5C2E561FX01# |        |               |         |                    |                    | ±2%                | GCM21B5C1H203GA16# |                    |                    |     |                    |
|        |               |         |        | ±2%                | GCM21A5C2E561GX01# |        |               |         |                    |                    | ±5%                | GCM21B5C1H203JA16# |                    |                    |     |                    |
|        |               |         |        | ±5%                | GCM21A5C2E561JX01# |        |               |         |                    | 22000pF            | ±1%                | GCM21B5C1H223FA16# |                    |                    |     |                    |
|        |               |         | 680pF  | ±1%                | GCM21A5C2E681FX01# |        |               |         |                    |                    | ±2%                | GCM21B5C1H223GA16# |                    |                    |     |                    |
|        |               |         |        | ±2%                | GCM21A5C2E681GX01# |        |               |         |                    |                    | ±5%                | GCM21B5C1H223JA16# |                    |                    |     |                    |
|        |               |         |        | ±5%                | GCM21A5C2E681JX01# |        |               |         |                    | X8G                | 6200pF             | ±1%                | GCM21B5G1H622FA16# |                    |     |                    |
|        |               |         | 820pF  | ±1%                | GCM21A5C2E821FX01# |        |               |         | ±2%                |                    |                    | GCM21B5G1H622GA16# |                    |                    |     |                    |
|        |               |         |        | ±2%                | GCM21A5C2E821GX01# |        |               |         | ±5%                |                    |                    | GCM21B5G1H622JA16# |                    |                    |     |                    |
|        |               |         |        | ±5%                | GCM21A5C2E821JX01# |        |               |         | 6800pF             | ±1%                | GCM21B5G1H682FA16# |                    |                    |                    |     |                    |
|        |               |         | 1000pF | ±1%                | GCM21A5C2E102FX01# |        |               |         |                    | ±2%                | GCM21B5G1H682GA16# |                    |                    |                    |     |                    |
|        |               |         |        | ±2%                | GCM21A5C2E102GX01# |        |               |         |                    | ±5%                | GCM21B5G1H682JA16# |                    |                    |                    |     |                    |
|        |               |         |        | ±5%                | GCM21A5C2E102JX01# |        |               |         | 7500pF             | ±1%                | GCM21B5G1H752FA16# |                    |                    |                    |     |                    |
|        |               |         | 1200pF | ±1%                | GCM21A5C2E122FX01# |        |               |         |                    | ±2%                | GCM21B5G1H752GA16# |                    |                    |                    |     |                    |
|        |               |         |        | ±2%                | GCM21A5C2E122GX01# |        |               |         |                    | ±5%                | GCM21B5G1H752JA16# |                    |                    |                    |     |                    |
|        |               |         |        | ±5%                | GCM21A5C2E122JX01# |        |               |         | 8200pF             | ±1%                | GCM21B5G1H822FA16# |                    |                    |                    |     |                    |
|        |               |         | 1500pF | ±1%                | GCM21A5C2E152FX01# |        |               |         |                    | ±2%                | GCM21B5G1H822GA16# |                    |                    |                    |     |                    |
|        |               |         |        | ±2%                | GCM21A5C2E152GX01# |        |               |         |                    | ±5%                | GCM21B5G1H822JA16# |                    |                    |                    |     |                    |
|        |               |         |        | ±5%                | GCM21A5C2E152JX01# |        |               |         | 9100pF             | ±1%                | GCM21B5G1H912FA16# |                    |                    |                    |     |                    |
|        |               |         | 1800pF | ±1%                | GCM21A5C2E182FX01# |        |               |         |                    | ±2%                | GCM21B5G1H912GA16# |                    |                    |                    |     |                    |
|        |               |         |        | ±2%                | GCM21A5C2E182GX01# |        |               |         |                    | ±5%                | GCM21B5G1H912JA16# |                    |                    |                    |     |                    |
|        |               |         |        | ±5%                | GCM21A5C2E182JX01# |        |               |         | 10000pF            | ±1%                | GCM21B5G1H103FA16# |                    |                    |                    |     |                    |
|        |               |         | 2200pF | ±1%                | GCM21A5C2E222FX01# |        |               |         |                    | ±2%                | GCM21B5G1H103GA16# |                    |                    |                    |     |                    |
|        |               |         |        | ±2%                | GCM21A5C2E222GX01# |        |               |         |                    | ±5%                | GCM21B5G1H103JA16# |                    |                    |                    |     |                    |
|        |               |         |        | ±5%                | GCM21A5C2E222JX01# |        |               |         | 50Vdc              | COG                | 18000pF            | ±2%                | GCM21B5C1K183GA16# |                    |     |                    |
|        |               |         | 2700pF | ±1%                | GCM21A5C2E272FX01# |        |               |         |                    |                    |                    | ±5%                | GCM21B5C1K183JA16# |                    |     |                    |
|        |               |         |        | ±2%                | GCM21A5C2E272GX01# |        |               |         |                    |                    |                    | 20000pF            | ±2%                | GCM21B5C1K203GA16# |     |                    |
|        |               |         |        | ±5%                | GCM21A5C2E272JX01# |        |               |         | ±5%                | GCM21B5C1K203JA16# |                    |                    |                    |                    |     |                    |
|        |               |         | U2J    | 100pF              | ±5%                |        |               |         | GCM21A7U2E101JX01# | 22000pF            | ±2%                |                    | GCM21B5C1K223GA16# |                    |     |                    |
|        |               |         |        |                    | ±5%                |        |               |         | GCM21A7U2E121JX01# |                    | ±5%                | GCM21B5C1K223JA16# |                    |                    |     |                    |
|        |               |         |        |                    | ±5%                |        |               |         | GCM21A7U2E151JX01# |                    | 4700pF             | ±1%                | GCM21B5C2E472FX01# |                    |     |                    |
|        |               |         | ±5%    | GCM21A7U2E181JX01# | 250Vdc             |        |               |         | COG                | 3300pF             |                    | ±1%                | GCM21B5C2E332FX01# |                    |     |                    |
|        |               |         | ±5%    | GCM21A7U2E221JX01# |                    |        |               |         |                    |                    |                    | ±2%                | GCM21B5C2E332GX01# |                    |     |                    |
|        |               |         | ±5%    | GCM21A7U2E271JX01# |                    |        |               |         |                    |                    | ±5%                | GCM21B5C2E332JX01# |                    |                    |     |                    |
|        |               |         | ±5%    | GCM21A7U2E331JX01# | 1000pF             |        |               |         | ±1%                | GCM21B5C2J102FX03# | 3900pF             | ±1%                | GCM21B5C2E392FX01# |                    |     |                    |
|        |               |         | ±5%    | GCM21A7U2E391JX01# |                    |        |               |         | ±2%                | GCM21B5C2J102GX03# |                    | ±2%                | GCM21B5C2E392GX01# |                    |     |                    |
|        |               |         | ±5%    | GCM21A7U2E471JX01# |                    |        |               |         | ±5%                | GCM21B5C2J102JX03# |                    | ±5%                | GCM21B5C2E392JX01# |                    |     |                    |
|        |               |         | ±5%    | GCM21A7U2E561JX01# | 1200pF             |        |               |         | ±1%                | GCM21B5C2J122FX03# | 4700pF             | ±1%                | GCM21B5C2E472FX01# |                    |     |                    |
|        |               |         | ±5%    | GCM21A7U2E681JX01# |                    |        |               |         | ±2%                | GCM21B5C2J122GX03# |                    | 250Vdc             | COG                | 3300pF             | ±2% | GCM21B5C2E332GX01# |
|        |               |         | ±5%    | GCM21A7U2E821JX01# |                    |        |               |         | ±5%                | GCM21B5C2J122JX03# |                    |                    |                    |                    | ±5% | GCM21B5C2E332JX01# |
|        |               |         | ±5%    | GCM21A7U2E821JX01# | 1500pF             |        |               |         | ±1%                | GCM21B5C2J152FX0A# | 3900pF             |                    |                    |                    | ±1% | GCM21B5C2E392FX01# |
|        |               |         | ±5%    | GCM21A7U2E102JX01# |                    |        |               |         | ±2%                | GCM21B5C2J152GX0A# |                    | ±2%                | GCM21B5C2E392GX01# |                    |     |                    |
|        |               |         | ±5%    | GCM21A7U2E122JX01# |                    |        |               |         | ±5%                | GCM21B5C2J152JX0A# |                    | ±5%                | GCM21B5C2E392JX01# |                    |     |                    |
|        |               |         | ±5%    | GCM21A7U2E152JX01# | 1800pF             |        |               |         | ±1%                | GCM21B5C2J182FX0A# | 4700pF             | ±1%                | GCM21B5C2E472FX01# |                    |     |                    |
|        |               |         | ±5%    | GCM21A7U2E182JX01# |                    |        |               |         | ±2%                | GCM21B5C2J182GX0A# |                    | 250Vdc             | COG                | 3300pF             | ±2% | GCM21B5C2E332GX01# |
|        |               |         | ±5%    | GCM21A7U2E222JX01# |                    |        |               |         | ±5%                | GCM21B5C2J182JX0A# |                    |                    |                    |                    | ±5% | GCM21B5C2E332JX01# |
|        |               |         | ±5%    | GCM21A7U2E222JX01# | 2200pF             |        |               |         | ±1%                | GCM21B5C2J222FX0A# | 4700pF             |                    |                    |                    | ±1% | GCM21B5C2E472FX01# |
|        |               |         | ±5%    | GCM21A7U2E222JX01# |                    |        |               |         | ±2%                | GCM21B5C2J222GX0A# |                    | 250Vdc             | COG                | 3300pF             | ±2% | GCM21B5C2E332GX01# |
|        |               |         | ±5%    | GCM21A7U2E222JX01# |                    |        |               |         | ±5%                | GCM21B5C2J222JX0A# |                    |                    |                    |                    | ±5% | GCM21B5C2E332JX01# |

Part number # indicates the package specification code.

GRT Series  
 GCM Series  
 GC3 Series  
 GCJ Series  
 GCQ Series  
 GCD Series  
 GCE Series  
 NMF Series  
 KCM Series  
 KC3 Series  
 KCA Series  
 GCB Series  
 GCG Series  
 ⚠Caution /Notice

# GCM Series Temperature Compensating Type Part Number List

(→ 2.0×1.25mm)

| T max. | Rated Voltage | TC Code | Cap.    | Tol.   | Part Number        |
|--------|---------------|---------|---------|--------|--------------------|
| 1.45mm | 250Vdc        | COG     | 4700pF  | ±2%    | GCM21B5C2E472GX01# |
|        |               |         |         | ±5%    | GCM21B5C2E472JX01# |
|        |               |         |         | ±1%    | GCM21B5C2E562FX0A# |
|        |               |         | 5600pF  | ±2%    | GCM21B5C2E562GX0A# |
|        |               |         |         | ±5%    | GCM21B5C2E562JX0A# |
|        |               |         | 6800pF  | ±1%    | GCM21B5C2E682FX0A# |
|        |               |         |         | ±2%    | GCM21B5C2E682GX0A# |
|        |               |         |         | ±5%    | GCM21B5C2E682JX0A# |
|        |               |         | 8200pF  | ±1%    | GCM21B5C2E822FX0A# |
|        |               |         |         | ±2%    | GCM21B5C2E822GX0A# |
|        |               |         |         | ±5%    | GCM21B5C2E822JX0A# |
|        |               |         | 10000pF | ±1%    | GCM21B5C2E103FX0A# |
|        |               |         |         | ±2%    | GCM21B5C2E103GX0A# |
|        |               |         |         | ±5%    | GCM21B5C2E103JX0A# |
|        |               |         | U2J     | 2700pF | ±5%                |
|        |               | 3300pF  |         | ±5%    | GCM21B7U2E332JX03# |
|        |               | 3900pF  |         | ±5%    | GCM21B7U2E392JX03# |
|        |               | 4700pF  |         | ±5%    | GCM21B7U2E472JX03# |
|        |               | 5600pF  |         | ±5%    | GCM21B7U2E562JX03# |

3.2×1.6mm

| T max. | Rated Voltage | TC Code | Cap.    | Tol.   | Part Number        |
|--------|---------------|---------|---------|--------|--------------------|
| 0.95mm | 100Vdc        | COG     | 3600pF  | ±1%    | GCM3195C2A362FA16# |
|        |               |         |         | ±2%    | GCM3195C2A362GA16# |
|        |               |         |         | ±5%    | GCM3195C2A362JA16# |
|        |               |         | 3900pF  | ±1%    | GCM3195C2A392FA16# |
|        |               |         |         | ±2%    | GCM3195C2A392GA16# |
|        |               |         |         | ±5%    | GCM3195C2A392JA16# |
|        |               |         | 4300pF  | ±1%    | GCM3195C2A432FA16# |
|        |               |         |         | ±2%    | GCM3195C2A432GA16# |
|        |               |         |         | ±5%    | GCM3195C2A432JA16# |
|        |               |         | 4700pF  | ±1%    | GCM3195C2A472FA16# |
|        |               |         |         | ±2%    | GCM3195C2A472GA16# |
|        |               |         |         | ±5%    | GCM3195C2A472JA16# |
|        |               |         | 5100pF  | ±1%    | GCM3195C2A512FA16# |
|        |               |         |         | ±2%    | GCM3195C2A512GA16# |
|        |               |         |         | ±5%    | GCM3195C2A512JA16# |
|        |               |         | 5600pF  | ±1%    | GCM3195C2A562FA16# |
|        |               |         |         | ±2%    | GCM3195C2A562GA16# |
|        |               |         |         | ±5%    | GCM3195C2A562JA16# |
|        |               |         | 6800pF  | ±2%    | GCM3195C2A682GA16# |
|        |               |         |         | ±5%    | GCM3195C2A682JA16# |
|        |               |         |         | 7500pF | ±2%                |
|        |               |         | ±5%     |        | GCM3195C2A752JA16# |
|        |               |         | 8200pF  |        | ±1%                |
|        |               |         |         | ±2%    | GCM3195C2A822GA16# |
|        |               |         |         | ±5%    | GCM3195C2A822JA16# |
|        |               |         | 9100pF  | ±1%    | GCM3195C2A912FA16# |
|        |               |         |         | ±2%    | GCM3195C2A912GA16# |
|        |               |         |         | ±5%    | GCM3195C2A912JA16# |
|        |               |         | 10000pF | ±1%    | GCM3195C2A103FA16# |
|        |               |         |         | ±2%    | GCM3195C2A103GA16# |

| T max.  | Rated Voltage      | TC Code            | Cap.    | Tol.               | Part Number        |                    |                    |                    |
|---------|--------------------|--------------------|---------|--------------------|--------------------|--------------------|--------------------|--------------------|
| 0.95mm  | 100Vdc             | COG                | 10000pF | ±5%                | GCM3195C2A103JA16# |                    |                    |                    |
|         |                    |                    |         | X8G                | 1600pF             | ±2%                | GCM3195G2A162GA16# |                    |
|         |                    |                    |         |                    |                    | ±5%                | GCM3195G2A162JA16# |                    |
|         |                    |                    | 1800pF  | ±2%                | GCM3195G2A182GA16# |                    |                    |                    |
|         |                    |                    |         | ±5%                | GCM3195G2A182JA16# |                    |                    |                    |
|         |                    |                    | 2000pF  | ±2%                | GCM3195G2A202GA16# |                    |                    |                    |
|         |                    |                    |         | ±5%                | GCM3195G2A202JA16# |                    |                    |                    |
|         |                    |                    | 2200pF  | ±2%                | GCM3195G2A222GA16# |                    |                    |                    |
|         |                    |                    |         | ±5%                | GCM3195G2A222JA16# |                    |                    |                    |
|         |                    |                    | 2400pF  | ±2%                | GCM3195G2A242GA16# |                    |                    |                    |
|         |                    |                    |         | ±5%                | GCM3195G2A242JA16# |                    |                    |                    |
|         |                    |                    |         |                    | 2700pF             | ±2%                | GCM3195G2A272GA16# |                    |
|         |                    |                    | ±5%     | GCM3195G2A272JA16# |                    |                    |                    |                    |
|         |                    |                    | 3000pF  | ±2%                | GCM3195G2A302GA16# |                    |                    |                    |
|         |                    |                    |         | ±5%                | GCM3195G2A302JA16# |                    |                    |                    |
|         |                    | 3300pF             | ±2%     | GCM3195G2A332GA16# |                    |                    |                    |                    |
|         |                    |                    | ±5%     | GCM3195G2A332JA16# |                    |                    |                    |                    |
|         |                    | 3600pF             | ±2%     | GCM3195G2A362GA16# |                    |                    |                    |                    |
|         |                    |                    | ±5%     | GCM3195G2A362JA16# |                    |                    |                    |                    |
|         |                    | 3900pF             | ±2%     | GCM3195G2A392GA16# |                    |                    |                    |                    |
|         |                    |                    | ±5%     | GCM3195G2A392JA16# |                    |                    |                    |                    |
|         |                    | 4300pF             | ±2%     | GCM3195G2A432GA16# |                    |                    |                    |                    |
|         |                    |                    | ±5%     | GCM3195G2A432JA16# |                    |                    |                    |                    |
|         |                    | 4700pF             | ±2%     | GCM3195G2A472GA16# |                    |                    |                    |                    |
|         |                    |                    | ±5%     | GCM3195G2A472JA16# |                    |                    |                    |                    |
|         |                    | 5100pF             | ±2%     | GCM3195G2A512GA16# |                    |                    |                    |                    |
|         |                    |                    | ±5%     | GCM3195G2A512JA16# |                    |                    |                    |                    |
|         |                    | 5600pF             | ±2%     | GCM3195G2A562GA16# |                    |                    |                    |                    |
|         |                    |                    | ±5%     | GCM3195G2A562JA16# |                    |                    |                    |                    |
|         |                    | 80Vdc              | COG     | 27000pF            | ±2%                | GCM3195C1K273GA16# |                    |                    |
|         |                    |                    |         |                    | ±5%                | GCM3195C1K273JA16# |                    |                    |
|         |                    |                    |         | 33000pF            | ±2%                | GCM3195C1K333GA16# |                    |                    |
|         |                    |                    |         |                    | ±5%                | GCM3195C1K333JA16# |                    |                    |
|         |                    |                    |         |                    | 50Vdc              | COG                | 27000pF            | ±1%                |
|         |                    |                    |         | ±2%                |                    |                    |                    | GCM3195C1H273GA16# |
|         |                    |                    |         | ±5%                |                    |                    |                    | GCM3195C1H273JA16# |
|         |                    |                    |         | 33000pF            | ±1%                | GCM3195C1H333FA16# |                    |                    |
|         |                    |                    |         |                    | ±2%                | GCM3195C1H333GA16# |                    |                    |
|         |                    |                    |         |                    | ±5%                | GCM3195C1H333JA16# |                    |                    |
|         |                    |                    |         | 39000pF            | ±1%                | GCM3195C1H393FA16# |                    |                    |
|         |                    |                    |         |                    | ±2%                | GCM3195C1H393GA16# |                    |                    |
|         |                    |                    |         |                    | ±5%                | GCM3195C1H393JA16# |                    |                    |
|         |                    |                    |         | X8G                | 11000pF            | ±2%                | GCM3195G1H113GA16# |                    |
|         |                    |                    |         |                    |                    |                    | ±5%                | GCM3195G1H113JA16# |
|         |                    | 12000pF            | ±2%     |                    |                    | GCM3195G1H123GA16# |                    |                    |
| ±5%     | GCM3195G1H123JA16# |                    |         |                    |                    |                    |                    |                    |
| 13000pF | ±2%                | GCM3195G1H133GA16# |         |                    |                    |                    |                    |                    |
|         | ±5%                | GCM3195G1H133JA16# |         |                    |                    |                    |                    |                    |
| 15000pF | ±2%                | GCM3195G1H153GA16# |         |                    |                    |                    |                    |                    |
|         | ±5%                | GCM3195G1H153JA16# |         |                    |                    |                    |                    |                    |
| 16000pF | ±2%                | GCM3195G1H163GA16# |         |                    |                    |                    |                    |                    |
|         | ±5%                | GCM3195G1H163JA16# |         |                    |                    |                    |                    |                    |
| 18000pF | ±2%                | GCM3195G1H183GA16# |         |                    |                    |                    |                    |                    |
|         | ±5%                | GCM3195G1H183JA16# |         |                    |                    |                    |                    |                    |

Part number # indicates the package specification code.

GRT Series  
 GCM Series  
 GC3 Series  
 GCJ Series  
 GCQ Series  
 GCD Series  
 GCE Series  
 NMF Series  
 KCM Series  
 KC3 Series  
 KCA Series  
 GCB Series  
 GCG Series  
 ⚠Caution /Notice

# GCM Series Temperature Compensating Type Part Number List

(→ 3.2×1.6mm)

| T max. | Rated Voltage      | TC Code            | Cap.               | Tol.               | Part Number        | T max. | Rated Voltage      | TC Code            | Cap.               | Tol.               | Part Number        |                    |                    |
|--------|--------------------|--------------------|--------------------|--------------------|--------------------|--------|--------------------|--------------------|--------------------|--------------------|--------------------|--------------------|--------------------|
| 0.95mm | 50Vdc              | X8G                | 2000pF             | ±2%                | GCM3195G1H203GA16# | 1.0mm  | 1000Vdc            | COG                | 220pF              | ±5%                | GCM3195G1H203JA16# |                    |                    |
|        |                    |                    |                    | ±2%                | GCM3195G1H223GA16# |        |                    |                    |                    | ±1%                | GCM31A5C3A221JX01# |                    |                    |
|        |                    |                    | ±5%                | GCM3195G1H223JA16# | ±1%                |        |                    |                    |                    |                    | GCM31A5C3A271FX01# |                    |                    |
|        |                    |                    | ±2%                | GCM3195G1H223GA16# | ±2%                |        |                    |                    |                    |                    | GCM31A5C3A271GX01# |                    |                    |
| ±5%    | GCM3195G1H223JA16# | ±5%                | GCM31A5C3A271JX01# |                    |                    |        |                    |                    |                    |                    |                    |                    |                    |
| 1.0mm  | 1000Vdc            | COG                | 10pF               | ±1%                | GCM31A5C3A100FX01# |        |                    |                    |                    | 330pF              | ±1%                | GCM31A5C3A331FX01# | ±2%                |
|        |                    |                    |                    | ±2%                | GCM31A5C3A100JX01# |        |                    |                    | ±2%                |                    |                    |                    | GCM31A5C3A331GX01# |
|        |                    |                    |                    | ±5%                | GCM31A5C3A100JX01# |        |                    |                    | ±5%                |                    |                    |                    | GCM31A5C3A331JX01# |
|        |                    |                    | 12pF               | ±1%                | GCM31A5C3A120FX01# |        |                    |                    | ±1%                |                    |                    |                    | GCM31A5C3A391FX01# |
| ±2%    | GCM31A5C3A120GX01# | ±2%                |                    | GCM31A5C3A391GX01# |                    |        |                    |                    |                    |                    |                    |                    |                    |
| ±5%    | GCM31A5C3A120JX01# | ±5%                |                    | GCM31A5C3A391JX01# |                    |        |                    |                    |                    |                    |                    |                    |                    |
| 15pF   | ±1%                | GCM31A5C3A150FX01# | ±1%                | GCM31A5C3A471FX01# | 470pF              |        |                    |                    | ±1%                | GCM31A5C3A471GX01# | ±2%                | GCM31A5C3A150GX01# |                    |
|        | ±2%                | GCM31A5C3A150GX01# |                    |                    |                    | ±2%    | GCM31A5C3A471GX01# |                    |                    |                    |                    |                    |                    |
|        | ±5%                | GCM31A5C3A150JX01# |                    |                    |                    | ±5%    | GCM31A5C3A471JX01# |                    |                    |                    |                    |                    |                    |
| 18pF   | ±1%                | GCM31A5C3A180FX01# | ±1%                | GCM31A7U3A100JX01# | U2J                | 10pF   | ±5%                | GCM31A7U3A100JX01# | ±2%                | GCM31A5C3A180GX01# |                    |                    |                    |
|        | ±2%                | GCM31A5C3A180GX01# |                    |                    |                    |        |                    |                    | ±5%                | GCM31A7U3A120JX01# |                    |                    |                    |
|        | ±5%                | GCM31A5C3A180JX01# |                    |                    |                    |        |                    |                    | ±5%                | GCM31A7U3A150JX01# |                    |                    |                    |
| 22pF   | ±1%                | GCM31A5C3A220FX01# | ±1%                | GCM31A7U3A180JX01# |                    | 18pF   | ±5%                | GCM31A7U3A180JX01# | ±5%                | GCM31A5C3A220GX01# |                    |                    |                    |
|        | ±2%                | GCM31A5C3A220GX01# |                    |                    |                    |        |                    |                    | ±5%                | GCM31A7U3A220JX01# |                    |                    |                    |
|        | ±5%                | GCM31A5C3A220JX01# |                    |                    |                    |        |                    |                    | ±5%                | GCM31A7U3A270JX01# |                    |                    |                    |
| 27pF   | ±1%                | GCM31A5C3A270FX01# | ±1%                | GCM31A7U3A270JX01# |                    | 27pF   | ±5%                | GCM31A7U3A270JX01# | ±5%                | GCM31A5C3A270GX01# |                    |                    |                    |
|        | ±2%                | GCM31A5C3A270GX01# |                    |                    |                    |        |                    |                    | ±5%                | GCM31A7U3A330JX01# |                    |                    |                    |
|        | ±5%                | GCM31A5C3A270JX01# |                    |                    |                    |        |                    |                    | ±5%                | GCM31A7U3A390JX01# |                    |                    |                    |
| 33pF   | ±1%                | GCM31A5C3A330FX01# | ±1%                | GCM31A7U3A470JX01# |                    | 33pF   | ±5%                | GCM31A7U3A330JX01# | ±5%                | GCM31A5C3A330GX01# |                    |                    |                    |
|        | ±2%                | GCM31A5C3A330GX01# |                    |                    |                    |        |                    |                    | ±5%                | GCM31A7U3A470JX01# |                    |                    |                    |
|        | ±5%                | GCM31A5C3A330JX01# |                    |                    |                    |        |                    |                    | ±5%                | GCM31A7U3A560JX01# |                    |                    |                    |
| 39pF   | ±1%                | GCM31A5C3A390FX01# | ±1%                | GCM31A7U3A680JX01# | 39pF               | ±5%    | GCM31A7U3A390JX01# | ±5%                | GCM31A5C3A390GX01# |                    |                    |                    |                    |
|        | ±2%                | GCM31A5C3A390GX01# |                    |                    |                    |        |                    | ±5%                | GCM31A7U3A820JX01# |                    |                    |                    |                    |
|        | ±5%                | GCM31A5C3A390JX01# |                    |                    |                    |        |                    | ±5%                | GCM31A7U3A101JX01# |                    |                    |                    |                    |
| 47pF   | ±1%                | GCM31A5C3A470FX01# | ±1%                | GCM31A7U3A151JX01# | 47pF               | ±5%    | GCM31A7U3A151JX01# | ±5%                | GCM31A5C3A470GX01# |                    |                    |                    |                    |
|        | ±2%                | GCM31A5C3A470GX01# |                    |                    |                    |        |                    | ±5%                | GCM31A7U3A181JX01# |                    |                    |                    |                    |
|        | ±5%                | GCM31A5C3A470JX01# |                    |                    |                    |        |                    | ±5%                | GCM31A7U3A221JX01# |                    |                    |                    |                    |
| 56pF   | ±1%                | GCM31A5C3A560FX01# | ±1%                | GCM31A7U3A271JX01# | 56pF               | ±5%    | GCM31A7U3A271JX01# | ±5%                | GCM31A5C3A560GX01# |                    |                    |                    |                    |
|        | ±2%                | GCM31A5C3A560GX01# |                    |                    |                    |        |                    | ±5%                | GCM31A7U3A331JX01# |                    |                    |                    |                    |
|        | ±5%                | GCM31A5C3A560JX01# |                    |                    |                    |        |                    | ±5%                | GCM31A5C2J100FX01# |                    |                    |                    |                    |
| 68pF   | ±1%                | GCM31A5C3A680FX01# | ±1%                | GCM31A5C2J100GX01# | 68pF               | ±5%    | GCM31A5C2J100GX01# | ±5%                | GCM31A5C3A680GX01# |                    |                    |                    |                    |
|        | ±2%                | GCM31A5C3A680GX01# |                    |                    |                    |        |                    | ±5%                | GCM31A5C2J120FX01# |                    |                    |                    |                    |
|        | ±5%                | GCM31A5C3A680JX01# |                    |                    |                    |        |                    | ±5%                | GCM31A5C2J120GX01# |                    |                    |                    |                    |
| 82pF   | ±1%                | GCM31A5C3A820FX01# | ±1%                | GCM31A5C2J120JX01# | 82pF               | ±5%    | GCM31A5C2J120JX01# | ±5%                | GCM31A5C3A820GX01# |                    |                    |                    |                    |
|        | ±2%                | GCM31A5C3A820GX01# |                    |                    |                    |        |                    | ±5%                | GCM31A5C2J150FX01# |                    |                    |                    |                    |
|        | ±5%                | GCM31A5C3A820JX01# |                    |                    |                    |        |                    | ±5%                | GCM31A5C2J150GX01# |                    |                    |                    |                    |
| 100pF  | ±1%                | GCM31A5C3A101FX01# | ±1%                | GCM31A5C2J150JX01# | 100pF              | ±5%    | GCM31A5C2J150JX01# | ±5%                | GCM31A5C3A101GX01# |                    |                    |                    |                    |
|        | ±2%                | GCM31A5C3A101GX01# |                    |                    |                    |        |                    | ±5%                | GCM31A5C2J180FX01# |                    |                    |                    |                    |
|        | ±5%                | GCM31A5C3A101JX01# |                    |                    |                    |        |                    | ±5%                | GCM31A5C2J180GX01# |                    |                    |                    |                    |
| 120pF  | ±1%                | GCM31A5C3A121FX01# | ±1%                | GCM31A5C2J180JX01# | 120pF              | ±5%    | GCM31A5C2J180JX01# | ±5%                | GCM31A5C3A121GX01# |                    |                    |                    |                    |
|        | ±2%                | GCM31A5C3A121GX01# |                    |                    |                    |        |                    | ±5%                | GCM31A5C2J220FX01# |                    |                    |                    |                    |
|        | ±5%                | GCM31A5C3A121JX01# |                    |                    |                    |        |                    | ±5%                | GCM31A5C2J220GX01# |                    |                    |                    |                    |
| 150pF  | ±1%                | GCM31A5C3A151FX01# | ±1%                | GCM31A5C2J220JX01# | 150pF              | ±5%    | GCM31A5C2J220JX01# | ±5%                | GCM31A5C3A151GX01# |                    |                    |                    |                    |
|        | ±2%                | GCM31A5C3A151GX01# |                    |                    |                    |        |                    | ±5%                | GCM31A5C2J270FX01# |                    |                    |                    |                    |
|        | ±5%                | GCM31A5C3A151JX01# |                    |                    |                    |        |                    | ±5%                | GCM31A5C2J270GX01# |                    |                    |                    |                    |
| 180pF  | ±1%                | GCM31A5C3A181FX01# | ±1%                | GCM31A5C2J270JX01# | 180pF              | ±5%    | GCM31A5C2J270JX01# | ±5%                | GCM31A5C3A181GX01# |                    |                    |                    |                    |
|        | ±2%                | GCM31A5C3A181GX01# |                    |                    |                    |        |                    | ±5%                | GCM31A5C2J330FX01# |                    |                    |                    |                    |
|        | ±5%                | GCM31A5C3A181JX01# |                    |                    |                    |        |                    | ±5%                | GCM31A5C2J330GX01# |                    |                    |                    |                    |
| 220pF  | ±1%                | GCM31A5C3A221FX01# | ±1%                | GCM31A5C2J330JX01# | 220pF              | ±5%    | GCM31A5C2J330JX01# | ±5%                | GCM31A5C3A221GX01# |                    |                    |                    |                    |
|        | ±2%                | GCM31A5C3A221GX01# |                    |                    |                    |        |                    | ±5%                | GCM31A5C2J390FX01# |                    |                    |                    |                    |
|        |                    |                    |                    |                    |                    | 630Vdc | COG                | 10pF               | ±1%                | GCM31A5C2J100FX01# |                    |                    |                    |
|        |                    |                    |                    |                    |                    |        |                    |                    | ±2%                | GCM31A5C2J100GX01# |                    |                    |                    |
|        |                    |                    |                    |                    |                    |        |                    |                    | ±5%                | GCM31A5C2J100JX01# |                    |                    |                    |
|        |                    |                    |                    |                    |                    |        |                    | 12pF               | ±1%                | GCM31A5C2J120FX01# |                    |                    |                    |
|        |                    |                    |                    |                    |                    |        |                    |                    | ±2%                | GCM31A5C2J120GX01# |                    |                    |                    |
|        |                    |                    |                    |                    |                    |        |                    |                    | ±5%                | GCM31A5C2J120JX01# |                    |                    |                    |
|        |                    |                    |                    |                    |                    |        |                    | 15pF               | ±1%                | GCM31A5C2J150FX01# |                    |                    |                    |
|        |                    |                    |                    |                    |                    |        |                    |                    | ±2%                | GCM31A5C2J150GX01# |                    |                    |                    |
|        |                    |                    |                    |                    |                    |        |                    |                    | ±5%                | GCM31A5C2J150JX01# |                    |                    |                    |
|        |                    |                    |                    |                    |                    |        |                    | 18pF               | ±1%                | GCM31A5C2J180FX01# |                    |                    |                    |
|        |                    |                    |                    |                    |                    |        |                    |                    | ±2%                | GCM31A5C2J180GX01# |                    |                    |                    |
|        |                    |                    |                    |                    |                    |        |                    |                    | ±5%                | GCM31A5C2J180JX01# |                    |                    |                    |
|        |                    |                    |                    |                    |                    |        |                    | 22pF               | ±1%                | GCM31A5C2J220FX01# |                    |                    |                    |
|        |                    |                    |                    |                    |                    |        |                    |                    | ±2%                | GCM31A5C2J220GX01# |                    |                    |                    |
|        |                    |                    |                    |                    |                    |        |                    |                    | ±5%                | GCM31A5C2J220JX01# |                    |                    |                    |
|        |                    |                    |                    |                    |                    |        |                    | 27pF               | ±1%                | GCM31A5C2J270FX01# |                    |                    |                    |
|        |                    |                    |                    |                    |                    |        |                    |                    | ±2%                | GCM31A5C2J270GX01# |                    |                    |                    |
|        |                    |                    |                    |                    |                    |        |                    |                    | ±5%                | GCM31A5C2J270JX01# |                    |                    |                    |
|        |                    |                    |                    |                    |                    |        |                    | 33pF               | ±1%                | GCM31A5C2J330FX01# |                    |                    |                    |
|        |                    |                    |                    |                    |                    |        |                    |                    | ±2%                | GCM31A5C2J330GX01# |                    |                    |                    |
|        |                    |                    |                    |                    |                    |        |                    |                    | ±5%                | GCM31A5C2J330JX01# |                    |                    |                    |
|        |                    |                    |                    |                    |                    |        |                    | 39pF               | ±1%                | GCM31A5C2J390FX01# |                    |                    |                    |

Part number # indicates the package specification code.

GRT Series  
 GCM Series  
 GC3 Series  
 GCJ Series  
 GCQ Series  
 GCD Series  
 GCE Series  
 NMF Series  
 KCM Series  
 KC3 Series  
 KCA Series  
 GCB Series  
 GCG Series  
 ⚠Caution / Notice

# GCM Series Temperature Compensating Type Part Number List

(→ 3.2×1.6mm)

| T max. | Rated Voltage | TC Code | Cap.   | Tol.  | Part Number        |
|--------|---------------|---------|--------|-------|--------------------|
| 1.0mm  | 630Vdc        | COG     | 39pF   | ±2%   | GCM31A5C2J390GX01# |
|        |               |         |        | ±5%   | GCM31A5C2J390JX01# |
|        |               |         | 47pF   | ±1%   | GCM31A5C2J470FX01# |
|        |               |         |        | ±2%   | GCM31A5C2J470GX01# |
|        |               |         |        | ±5%   | GCM31A5C2J470JX01# |
|        |               |         |        | ±1%   | GCM31A5C2J560FX01# |
|        |               |         | 56pF   | ±2%   | GCM31A5C2J560GX01# |
|        |               |         |        | ±5%   | GCM31A5C2J560JX01# |
|        |               |         |        | 68pF  | ±1%                |
|        |               |         | ±2%    |       | GCM31A5C2J680GX01# |
|        |               |         | ±5%    |       | GCM31A5C2J680JX01# |
|        |               |         | 82pF   | ±1%   | GCM31A5C2J820FX01# |
|        |               |         |        | ±2%   | GCM31A5C2J820GX01# |
|        |               |         |        | ±5%   | GCM31A5C2J820JX01# |
|        |               |         | 100pF  | ±1%   | GCM31A5C2J101FX01# |
|        |               |         |        | ±2%   | GCM31A5C2J101GX01# |
|        |               |         |        | ±5%   | GCM31A5C2J101JX01# |
|        |               |         | 120pF  | ±1%   | GCM31A5C2J121FX01# |
|        |               |         |        | ±2%   | GCM31A5C2J121GX01# |
|        |               |         |        | ±5%   | GCM31A5C2J121JX01# |
|        |               |         | 150pF  | ±1%   | GCM31A5C2J151FX01# |
|        |               |         |        | ±2%   | GCM31A5C2J151GX01# |
|        |               |         |        | ±5%   | GCM31A5C2J151JX01# |
|        |               |         | 180pF  | ±1%   | GCM31A5C2J181FX01# |
|        |               |         |        | ±2%   | GCM31A5C2J181GX01# |
|        |               |         |        | ±5%   | GCM31A5C2J181JX01# |
|        |               |         | 220pF  | ±1%   | GCM31A5C2J221FX01# |
|        |               |         |        | ±2%   | GCM31A5C2J221GX01# |
|        |               |         |        | ±5%   | GCM31A5C2J221JX01# |
|        |               |         | 270pF  | ±1%   | GCM31A5C2J271FX01# |
|        |               |         |        | ±2%   | GCM31A5C2J271GX01# |
|        |               |         |        | ±5%   | GCM31A5C2J271JX01# |
|        |               |         | 330pF  | ±1%   | GCM31A5C2J331FX01# |
|        |               |         |        | ±2%   | GCM31A5C2J331GX01# |
|        |               |         |        | ±5%   | GCM31A5C2J331JX01# |
|        |               |         | 390pF  | ±1%   | GCM31A5C2J391FX01# |
|        |               |         |        | ±2%   | GCM31A5C2J391GX01# |
|        |               |         |        | ±5%   | GCM31A5C2J391JX01# |
|        |               |         | 470pF  | ±1%   | GCM31A5C2J471FX01# |
|        |               |         |        | ±2%   | GCM31A5C2J471GX01# |
|        |               |         |        | ±5%   | GCM31A5C2J471JX01# |
|        |               |         |        | ±1%   | GCM31A5C2J561FX01# |
|        |               |         | 560pF  | ±2%   | GCM31A5C2J561GX01# |
|        |               |         |        | ±5%   | GCM31A5C2J561JX01# |
|        |               |         |        | 680pF | ±1%                |
|        |               |         | ±2%    |       | GCM31A5C2J681GX01# |
|        |               |         | ±5%    |       | GCM31A5C2J681JX01# |
|        |               |         | 820pF  |       | ±1%                |
|        |               |         |        | ±2%   | GCM31A5C2J821GX01# |
|        |               |         |        | ±5%   | GCM31A5C2J821JX01# |
|        |               |         | 1000pF | ±1%   | GCM31A5C2J102FX01# |
|        |               |         |        | ±2%   | GCM31A5C2J102GX01# |
|        |               |         |        | ±5%   | GCM31A5C2J102JX01# |
|        |               |         | 1200pF | ±1%   | GCM31A5C2J122FX01# |

| T max. | Rated Voltage | TC Code | Cap.   | Tol.   | Part Number        |                    |                    |                    |                    |
|--------|---------------|---------|--------|--------|--------------------|--------------------|--------------------|--------------------|--------------------|
| 1.0mm  | 630Vdc        | COG     | 1200pF | ±2%    | GCM31A5C2J122GX01# |                    |                    |                    |                    |
|        |               |         |        | ±5%    | GCM31A5C2J122JX01# |                    |                    |                    |                    |
|        |               |         | 1500pF | ±1%    | GCM31A5C2J152FX01# |                    |                    |                    |                    |
|        |               |         |        | ±2%    | GCM31A5C2J152GX01# |                    |                    |                    |                    |
|        |               |         |        | ±5%    | GCM31A5C2J152JX01# |                    |                    |                    |                    |
|        |               |         |        | 1800pF | ±1%                | GCM31A5C2J182FX01# |                    |                    |                    |
|        |               |         | ±2%    |        | GCM31A5C2J182GX01# |                    |                    |                    |                    |
|        |               |         | ±5%    |        | GCM31A5C2J182JX01# |                    |                    |                    |                    |
|        |               |         | U2J    | 10pF   | ±5%                | GCM31A7U2J100JX01# |                    |                    |                    |
|        |               |         |        |        | ±5%                | GCM31A7U2J120JX01# |                    |                    |                    |
|        |               |         |        |        | ±5%                | GCM31A7U2J150JX01# |                    |                    |                    |
|        |               |         |        |        | ±5%                | GCM31A7U2J180JX01# |                    |                    |                    |
|        |               |         |        |        | ±5%                | GCM31A7U2J220JX01# |                    |                    |                    |
|        |               |         |        |        | ±5%                | GCM31A7U2J270JX01# |                    |                    |                    |
|        |               |         |        |        | ±5%                | GCM31A7U2J330JX01# |                    |                    |                    |
|        |               |         |        |        | ±5%                | GCM31A7U2J390JX01# |                    |                    |                    |
|        |               |         |        |        | ±5%                | GCM31A7U2J470JX01# |                    |                    |                    |
|        |               |         |        |        | ±5%                | GCM31A7U2J560JX01# |                    |                    |                    |
|        |               |         |        |        | ±5%                | GCM31A7U2J680JX01# |                    |                    |                    |
|        |               |         |        |        | ±5%                | GCM31A7U2J820JX01# |                    |                    |                    |
|        |               |         |        |        | ±5%                | GCM31A7U2J101JX01# |                    |                    |                    |
|        |               |         |        |        | ±5%                | GCM31A7U2J121JX01# |                    |                    |                    |
|        |               |         |        |        | ±5%                | GCM31A7U2J151JX01# |                    |                    |                    |
|        |               |         |        |        | ±5%                | GCM31A7U2J181JX01# |                    |                    |                    |
|        |               |         |        |        | ±5%                | GCM31A7U2J221JX01# |                    |                    |                    |
|        |               |         |        |        | ±5%                | GCM31A7U2J271JX01# |                    |                    |                    |
|        |               |         |        |        | ±5%                | GCM31A7U2J331JX01# |                    |                    |                    |
|        |               |         |        |        | ±5%                | GCM31A7U2J391JX01# |                    |                    |                    |
|        |               |         |        |        | ±5%                | GCM31A7U2J471JX01# |                    |                    |                    |
|        |               |         |        |        | ±5%                | GCM31A7U2J561JX01# |                    |                    |                    |
|        |               |         | U2J    | 630Vdc | COG                | 2200pF             | ±1%                | GCM31B5C2J222FX01# |                    |
|        |               |         |        |        |                    |                    | ±2%                | GCM31B5C2J222GX01# |                    |
|        |               |         |        |        |                    | ±5%                | GCM31B5C2J222JX01# |                    |                    |
|        |               |         |        |        |                    | 2700pF             | ±1%                | GCM31B5C2J272FX01# |                    |
|        |               |         |        |        |                    |                    | ±2%                | GCM31B5C2J272GX01# |                    |
|        |               |         |        |        |                    |                    | ±5%                | GCM31B5C2J272JX01# |                    |
|        |               |         |        |        |                    | U2J                | 2700pF             | ±5%                | GCM31B7U2J272JX01# |

|        |         |        |       |                    |                    |                    |
|--------|---------|--------|-------|--------------------|--------------------|--------------------|
| 1.25mm | 1000Vdc | COG    | 560pF | ±1%                | GCM31B5C3A561FX01# |                    |
|        |         |        |       | ±2%                | GCM31B5C3A561GX01# |                    |
|        |         |        |       | ±5%                | GCM31B5C3A561JX01# |                    |
|        |         |        | 680pF | ±1%                | GCM31B5C3A681FX01# |                    |
|        |         |        |       | ±2%                | GCM31B5C3A681GX01# |                    |
|        |         |        |       | ±5%                | GCM31B5C3A681JX01# |                    |
|        |         |        | U2J   | 390pF              | ±5%                | GCM31B7U3A391JX01# |
|        |         |        |       | 470pF              | ±5%                | GCM31B7U3A471JX01# |
|        |         |        |       | 560pF              | ±5%                | GCM31B7U3A561JX01# |
|        |         |        |       | 680pF              | ±5%                | GCM31B7U3A681JX01# |
| 630Vdc | COG     | 2200pF | ±1%   | GCM31B5C2J222FX01# |                    |                    |
|        |         |        | ±2%   | GCM31B5C2J222GX01# |                    |                    |
|        |         |        | ±5%   | GCM31B5C2J222JX01# |                    |                    |
|        |         | 2700pF | ±1%   | GCM31B5C2J272FX01# |                    |                    |
|        |         |        | ±2%   | GCM31B5C2J272GX01# |                    |                    |
|        |         |        | ±5%   | GCM31B5C2J272JX01# |                    |                    |
|        |         |        | U2J   | 2700pF             | ±5%                | GCM31B7U2J272JX01# |

Part number # indicates the package specification code.

GRT Series  
 GCM Series  
 GC3 Series  
 GCJ Series  
 GCQ Series  
 GCD Series  
 GCE Series  
 NMF Series  
 KCM Series  
 KC3 Series  
 KCA Series  
 GCB Series  
 GCG Series  
 ⚠Caution /Notice



# GCM Series Temperature Compensating Type Part Number List

(→ 3.2×1.6mm)

| T max.  | Rated Voltage | TC Code | Cap.               | Tol.               | Part Number        |                    |                    |
|---------|---------------|---------|--------------------|--------------------|--------------------|--------------------|--------------------|
| 1.25mm  | 630Vdc        | U2J     | 3300pF             | ±5%                | GCM31B7U2J332JX01# |                    |                    |
|         |               |         |                    | COG                | 12000pF            | ±1%                | GCM31B5C2E123FX01# |
|         |               |         |                    |                    |                    | ±2%                | GCM31B5C2E123GX01# |
|         |               | ±5%     | GCM31B5C2E123JX01# |                    |                    |                    |                    |
|         |               | U2J     | 6800pF             | ±5%                | GCM31B7U2E682JX01# |                    |                    |
|         |               |         |                    | 8200pF             | ±5%                | GCM31B7U2E822JX01# |                    |
|         | 10000pF       |         |                    |                    | ±5%                | GCM31B7U2E103JX01# |                    |
|         | 50Vdc         | COG     | 43000pF            | ±1%                | GCM31M5C1H433FA16# |                    |                    |
|         |               |         |                    | ±2%                | GCM31M5C1H433GA16# |                    |                    |
|         |               |         |                    | ±5%                | GCM31M5C1H433JA16# |                    |                    |
|         |               |         | 47000pF            | ±1%                | GCM31M5C1H473FA16# |                    |                    |
|         |               |         |                    | ±2%                | GCM31M5C1H473GA16# |                    |                    |
|         |               |         |                    | ±5%                | GCM31M5C1H473JA16# |                    |                    |
|         |               | 51000pF | ±1%                | GCM31M5C1H513FA16# |                    |                    |                    |
|         |               |         | ±2%                | GCM31M5C1H513GA16# |                    |                    |                    |
|         |               |         | ±5%                | GCM31M5C1H513JA16# |                    |                    |                    |
|         |               | 56000pF | ±1%                | GCM31M5C1H563FA16# |                    |                    |                    |
|         |               |         |                    | ±2%                | GCM31M5C1H563GA16# |                    |                    |
|         |               |         |                    | ±5%                | GCM31M5C1H563JA16# |                    |                    |
|         | 18mm          |         | 1000Vdc            | COG                | 820pF              | ±1%                | GCM31C5C3A821FX03# |
|         |               |         |                    |                    |                    | ±2%                | GCM31C5C3A821GX03# |
|         |               |         |                    |                    |                    | ±5%                | GCM31C5C3A821JX03# |
|         |               | 1000pF  |                    |                    | ±1%                | GCM31C5C3A102FX03# |                    |
|         |               |         |                    |                    | ±2%                | GCM31C5C3A102GX03# |                    |
| ±5%     |               |         |                    |                    | GCM31C5C3A102JX03# |                    |                    |
| U2J     | 820pF         | ±5%     |                    | GCM31C7U3A821JX03# |                    |                    |                    |
|         | 1000pF        | ±5%     |                    | GCM31C7U3A102JX03# |                    |                    |                    |
| 630Vdc  | COG           | 3300pF  |                    | ±1%                | GCM31C5C2J332FX03# |                    |                    |
|         |               |         |                    | ±2%                | GCM31C5C2J332GX03# |                    |                    |
|         |               |         |                    | ±5%                | GCM31C5C2J332JX03# |                    |                    |
|         |               | 3900pF  |                    | ±1%                | GCM31C5C2J392FX03# |                    |                    |
|         |               |         | ±2%                | GCM31C5C2J392GX03# |                    |                    |                    |
|         |               |         | ±5%                | GCM31C5C2J392JX03# |                    |                    |                    |
|         |               | 4700pF  | ±1%                | GCM31C5C2J472FX03# |                    |                    |                    |
|         |               |         | ±2%                | GCM31C5C2J472GX03# |                    |                    |                    |
|         |               |         | ±5%                | GCM31C5C2J472JX03# |                    |                    |                    |
|         |               | 5600pF  | ±1%                | GCM31C5C2J562FX03# |                    |                    |                    |
|         |               |         | ±2%                | GCM31C5C2J562GX03# |                    |                    |                    |
|         |               |         | ±5%                | GCM31C5C2J562JX03# |                    |                    |                    |
|         | 6800pF        | ±1%     | GCM31C5C2J682FX03# |                    |                    |                    |                    |
|         |               | ±2%     | GCM31C5C2J682GX03# |                    |                    |                    |                    |
|         |               | ±5%     | GCM31C5C2J682JX03# |                    |                    |                    |                    |
|         | 8200pF        | ±1%     | GCM31C5C2J822FX03# |                    |                    |                    |                    |
|         |               | ±2%     | GCM31C5C2J822GX03# |                    |                    |                    |                    |
|         |               | ±5%     | GCM31C5C2J822JX03# |                    |                    |                    |                    |
|         | 10000pF       | ±1%     | GCM31C5C2J103FX03# |                    |                    |                    |                    |
|         |               | ±2%     | GCM31C5C2J103GX03# |                    |                    |                    |                    |
|         |               | ±5%     | GCM31C5C2J103JX03# |                    |                    |                    |                    |
|         | U2J           | 3900pF  | ±5%                | GCM31C7U2J392JX03# |                    |                    |                    |
|         |               | 4700pF  | ±5%                | GCM31C7U2J472JX03# |                    |                    |                    |
|         | 250Vdc        | COG     | 15000pF            | ±1%                | GCM31C5C2E153FX03# |                    |                    |
| ±2%     |               |         |                    | GCM31C5C2E153GX03# |                    |                    |                    |
| ±5%     |               |         |                    | GCM31C5C2E153JX03# |                    |                    |                    |
| 18000pF |               |         | ±1%                | GCM31C5C2E183FX03# |                    |                    |                    |

| T max. | Rated Voltage | TC Code            | Cap.               | Tol.               | Part Number        |                    |                    |
|--------|---------------|--------------------|--------------------|--------------------|--------------------|--------------------|--------------------|
| 1.8mm  | 250Vdc        | COG                | 18000pF            | ±2%                | GCM31C5C2E183GX03# |                    |                    |
|        |               |                    |                    | ±5%                | GCM31C5C2E183JX03# |                    |                    |
|        |               |                    |                    | 22000pF            | ±1%                | GCM31C5C2E223FX03# |                    |
|        |               |                    | ±2%                |                    | GCM31C5C2E223GX03# |                    |                    |
|        |               |                    | ±5%                |                    | GCM31C5C2E223JX03# |                    |                    |
|        |               |                    | 100Vdc             | COG                | 62000pF            | ±5%                | GCM31C5C2A623JE02# |
|        |               | 68000pF            |                    |                    |                    | ±5%                | GCM31C5C2A683JE02# |
|        |               | 75000pF            |                    |                    |                    | ±5%                | GCM31C5C2A753JE02# |
|        |               | 82000pF            |                    |                    | ±5%                | GCM31C5C2A823JE02# |                    |
|        |               |                    |                    |                    | 91000pF            | ±5%                | GCM31C5C2A913JE02# |
|        |               |                    |                    |                    | 0.10μF             | ±5%                | GCM31C5C2A104JE02# |
|        |               | 50Vdc              | COG                | 62000pF            | ±1%                | GCM31C5C1H623FA16# |                    |
|        | ±2%           |                    |                    |                    | GCM31C5C1H623GA16# |                    |                    |
|        | ±5%           |                    |                    |                    | GCM31C5C1H623JA16# |                    |                    |
|        | 68000pF       |                    |                    | ±1%                | GCM31C5C1H683FA16# |                    |                    |
|        |               |                    |                    | ±2%                | GCM31C5C1H683GA16# |                    |                    |
|        |               |                    |                    | ±5%                | GCM31C5C1H683JA16# |                    |                    |
|        | 75000pF       |                    | ±1%                | GCM31C5C1H753FA16# |                    |                    |                    |
|        |               |                    | ±2%                | GCM31C5C1H753GA16# |                    |                    |                    |
|        |               |                    | ±5%                | GCM31C5C1H753JA16# |                    |                    |                    |
|        | 82000pF       |                    | ±1%                | GCM31C5C1H823FA16# |                    |                    |                    |
|        |               |                    | ±2%                | GCM31C5C1H823GA16# |                    |                    |                    |
|        |               |                    | ±5%                | GCM31C5C1H823JA16# |                    |                    |                    |
|        |               | 91000pF            | ±1%                | GCM31C5C1H913FA16# |                    |                    |                    |
| ±2%    |               |                    | GCM31C5C1H913GA16# |                    |                    |                    |                    |
| ±5%    |               |                    | GCM31C5C1H913JA16# |                    |                    |                    |                    |
| 0.10μF | ±1%           | GCM31C5C1H104FA16# |                    |                    |                    |                    |                    |
|        | ±2%           | GCM31C5C1H104GA16# |                    |                    |                    |                    |                    |
|        | ±5%           | GCM31C5C1H104JA16# |                    |                    |                    |                    |                    |

## 3.2×2.5mm

| T max. | Rated Voltage | TC Code | Cap.    | Tol. | Part Number        |
|--------|---------------|---------|---------|------|--------------------|
| 1.0mm  | 630Vdc        | U2J     | 1200pF  | ±5%  | GCM32A7U2J122JX01# |
|        |               |         | 1500pF  | ±5%  | GCM32A7U2J152JX01# |
|        |               |         | 1800pF  | ±5%  | GCM32A7U2J182JX01# |
|        |               |         | 2200pF  | ±5%  | GCM32A7U2J222JX01# |
| 1.25mm | 1000Vdc       | U2J     | 1200pF  | ±5%  | GCM32B7U3A122JX01# |
|        | 630Vdc        | U2J     | 5600pF  | ±5%  | GCM32B7U2J562JX01# |
| 1.5mm  | 1000Vdc       | U2J     | 1500pF  | ±5%  | GCM32Q7U3A152JX01# |
|        | 630Vdc        | U2J     | 6800pF  | ±5%  | GCM32Q7U2J682JX01# |
| 2.0mm  | 1000Vdc       | U2J     | 1800pF  | ±5%  | GCM32D7U3A182JX01# |
|        |               |         | 2200pF  | ±5%  | GCM32D7U3A222JX01# |
|        | 630Vdc        | U2J     | 8200pF  | ±5%  | GCM32D7U2J822JX01# |
|        |               |         | 10000pF | ±5%  | GCM32D7U2J103JX01# |
| 2.85mm | 630Vdc        | COG     | 33000pF | ±1%  | GCM32E5C2J333FX0A# |
|        |               |         |         | ±2%  | GCM32E5C2J333GX0A# |
|        |               |         |         | ±5%  | GCM32E5C2J333JX0A# |

Part number # indicates the package specification code.

GRT Series  
 GCM Series  
 GC3 Series  
 GCJ Series  
 GCQ Series  
 GCD Series  
 GCE Series  
 NMF Series  
 KCM Series  
 KC3 Series  
 KCA Series  
 GCB Series  
 GCG Series  
 ⚠Caution / Notice

# GCM Series Temperature Compensating Type Part Number List

## 4.5×3.2mm

| T max. | Rated Voltage | TC Code | Cap.    | Tol. | Part Number               |
|--------|---------------|---------|---------|------|---------------------------|
| 1.5mm  | 1000Vdc       | U2J     | 2700pF  | ±5%  | <b>GCM43Q7U3A272JX01#</b> |
|        |               |         | 3300pF  | ±5%  | <b>GCM43Q7U3A332JX01#</b> |
|        | 630Vdc        | U2J     | 12000pF | ±5%  | <b>GCM43Q7U2J123JX01#</b> |
| 2.0mm  | 1000Vdc       | U2J     | 3900pF  | ±5%  | <b>GCM43D7U3A392JX01#</b> |
|        |               |         | 4700pF  | ±5%  | <b>GCM43D7U3A472JX01#</b> |
|        | 630Vdc        | U2J     | 15000pF | ±5%  | <b>GCM43D7U2J153JX01#</b> |
|        |               |         | 18000pF | ±5%  | <b>GCM43D7U2J183JX01#</b> |
|        |               |         | 22000pF | ±5%  | <b>GCM43D7U2J223JX01#</b> |

## 5.7×5.0mm

| T max. | Rated Voltage | TC Code | Cap.    | Tol. | Part Number               |
|--------|---------------|---------|---------|------|---------------------------|
| 1.5mm  | 1000Vdc       | U2J     | 5600pF  | ±5%  | <b>GCM55Q7U3A562JX01#</b> |
|        |               |         | 6800pF  | ±5%  | <b>GCM55Q7U3A682JX01#</b> |
|        | 630Vdc        | U2J     | 27000pF | ±5%  | <b>GCM55Q7U2J273JX01#</b> |
| 2.0mm  | 1000Vdc       | U2J     | 8200pF  | ±5%  | <b>GCM55D7U3A822JX01#</b> |
|        |               |         | 10000pF | ±5%  | <b>GCM55D7U3A103JX01#</b> |
|        | 630Vdc        | U2J     | 33000pF | ±5%  | <b>GCM55D7U2J333JX01#</b> |
|        |               |         | 39000pF | ±5%  | <b>GCM55D7U2J393JX01#</b> |
|        |               |         | 47000pF | ±5%  | <b>GCM55D7U2J473JX01#</b> |

GRT Series  
 GCM Series  
 GC3 Series  
 GCJ Series  
 GCQ Series  
 GCD Series  
 GCE Series  
 NMF Series  
 KCM Series  
 KC3 Series  
 KCA Series  
 GCB Series  
 GCG Series  
 ⚠Caution /Notice

# GCM Series High Dielectric Constant Type Part Number List

## 0.6×0.3mm

| T max. | Rated Voltage | TC Code            | Cap.               | Tol. | Part Number        |      |                    |
|--------|---------------|--------------------|--------------------|------|--------------------|------|--------------------|
| 0.33mm | 25Vdc         | X7R                | 100pF              | ±10% | GCM033R71E101KA03# |      |                    |
|        |               |                    |                    | ±20% | GCM033R71E101MA03# |      |                    |
|        |               |                    | 120pF              | ±10% | GCM033R71E121KA03# |      |                    |
|        |               |                    |                    | ±20% | GCM033R71E121MA03# |      |                    |
|        |               |                    | 150pF              | ±10% | GCM033R71E151KA03# |      |                    |
|        |               |                    |                    | ±20% | GCM033R71E151MA03# |      |                    |
|        |               |                    | 180pF              | ±10% | GCM033R71E181KA03# |      |                    |
|        |               |                    |                    | ±20% | GCM033R71E181MA03# |      |                    |
|        |               |                    | 220pF              | ±10% | GCM033R71E221KA03# |      |                    |
|        |               |                    |                    | ±20% | GCM033R71E221MA03# |      |                    |
|        |               |                    | 270pF              | ±10% | GCM033R71E271KA03# |      |                    |
|        |               |                    |                    | ±20% | GCM033R71E271MA03# |      |                    |
|        |               |                    | 330pF              | ±10% | GCM033R71E331KA03# |      |                    |
|        |               |                    |                    | ±20% | GCM033R71E331MA03# |      |                    |
|        |               |                    | 390pF              | ±10% | GCM033R71E391KA03# |      |                    |
|        |               |                    |                    | ±20% | GCM033R71E391MA03# |      |                    |
|        |               |                    | 470pF              | ±10% | GCM033R71E471KA03# |      |                    |
|        |               |                    |                    | ±20% | GCM033R71E471MA03# |      |                    |
|        |               |                    | 560pF              | ±10% | GCM033R71E561KA03# |      |                    |
|        |               |                    |                    | ±20% | GCM033R71E561MA03# |      |                    |
|        |               |                    | 680pF              | ±10% | GCM033R71E681KA03# |      |                    |
|        |               |                    |                    | ±20% | GCM033R71E681MA03# |      |                    |
|        |               |                    | 820pF              | ±10% | GCM033R71E821KA03# |      |                    |
|        |               |                    |                    | ±20% | GCM033R71E821MA03# |      |                    |
|        |               |                    | 1000pF             | ±10% | GCM033R71E102KA03# |      |                    |
|        |               |                    |                    | ±20% | GCM033R71E102MA03# |      |                    |
|        |               |                    | 1200pF             | ±10% | GCM033R71E122KA03# |      |                    |
|        |               |                    |                    | ±20% | GCM033R71E122MA03# |      |                    |
|        |               |                    | 1500pF             | ±10% | GCM033R71E152KA03# |      |                    |
|        |               |                    |                    | ±20% | GCM033R71E152MA03# |      |                    |
|        |               |                    | 1800pF             | ±10% | GCM033R71E182KE02# |      |                    |
|        |               |                    |                    | ±10% | GCM033R71E222KE02# |      |                    |
|        |               |                    | 2200pF             | ±10% | GCM033R71E222KE02# |      |                    |
|        |               |                    |                    | ±10% | GCM033R71E272KE02# |      |                    |
|        |               |                    | 2700pF             | ±10% | GCM033R71E272KE02# |      |                    |
|        |               |                    |                    | ±10% | GCM033R71E332KE02# |      |                    |
|        | 3300pF        | ±10%               | GCM033R71E332KE02# |      |                    |      |                    |
|        |               | ±10%               | GCM033R71C331KA03# |      |                    |      |                    |
|        | 16Vdc         | X7R                | 330pF              | ±10% | GCM033R71C331KA03# |      |                    |
|        |               |                    |                    | ±10% | GCM033R71C681KA03# |      |                    |
|        |               |                    | 1800pF             | ±10% | GCM033R71C182KA55# |      |                    |
|        |               |                    |                    | ±20% | GCM033R71C182MA55# |      |                    |
|        |               |                    | 2200pF             | ±10% | GCM033R71C222KA55# |      |                    |
|        |               |                    |                    | ±20% | GCM033R71C222MA55# |      |                    |
|        |               |                    | 2700pF             | ±10% | GCM033R71C272KA55# |      |                    |
|        |               |                    |                    | ±20% | GCM033R71C272MA55# |      |                    |
|        |               |                    | 3300pF             | ±10% | GCM033R71C332KA55# |      |                    |
|        |               |                    |                    | ±20% | GCM033R71C332MA55# |      |                    |
|        |               |                    | 10Vdc              | X7R  | 1200pF             | ±10% | GCM033R71A122KA03# |
|        |               |                    |                    |      |                    | ±20% | GCM033R71A122MA03# |
|        | 1500pF        | ±10%               |                    |      | GCM033R71A152KA03# |      |                    |
|        |               | ±20%               |                    |      | GCM033R71A152MA03# |      |                    |
|        | 1800pF        | ±10%               |                    |      | GCM033R71A182KA03# |      |                    |
|        |               | ±20%               |                    |      | GCM033R71A182MA03# |      |                    |
| 2200pF | ±10%          | GCM033R71A222KA03# |                    |      |                    |      |                    |
|        | ±20%          | GCM033R71A222MA03# |                    |      |                    |      |                    |

| T max. | Rated Voltage | TC Code | Cap.    | Tol. | Part Number        |
|--------|---------------|---------|---------|------|--------------------|
| 0.33mm | 10Vdc         | X7R     | 2700pF  | ±10% | GCM033R71A272KA03# |
|        |               |         |         | ±20% | GCM033R71A272MA03# |
|        |               |         | 3300pF  | ±10% | GCM033R71A332KA03# |
|        |               |         |         | ±20% | GCM033R71A332MA03# |
|        |               |         | 3900pF  | ±10% | GCM033R71A392KA03# |
|        |               |         |         | ±20% | GCM033R71A392MA03# |
|        |               |         | 4700pF  | ±10% | GCM033R71A472KA03# |
|        |               |         |         | ±20% | GCM033R71A472MA03# |
|        |               |         | 5600pF  | ±10% | GCM033R71A562KA03# |
|        |               |         |         | ±20% | GCM033R71A562MA03# |
|        |               |         | 6800pF  | ±10% | GCM033R71A682KA03# |
|        |               |         |         | ±20% | GCM033R71A682MA03# |
|        |               |         | 8200pF  | ±10% | GCM033R71A822KA03# |
|        |               |         |         | ±20% | GCM033R71A822MA03# |
|        |               |         | 10000pF | ±10% | GCM033R71A103KA03# |
|        |               |         |         | ±20% | GCM033R71A103MA03# |

## 1.0×0.5mm

| T max. | Rated Voltage | TC Code | Cap.   | Tol. | Part Number        |
|--------|---------------|---------|--------|------|--------------------|
| 0.55mm | 100Vdc        | X7R     | 220pF  | ±10% | GCM155R72A221KA37# |
|        |               |         |        | ±20% | GCM155R72A221MA37# |
|        |               |         | 270pF  | ±10% | GCM155R72A271KA37# |
|        |               |         |        | ±20% | GCM155R72A271MA37# |
|        |               |         | 330pF  | ±10% | GCM155R72A331KA37# |
|        |               |         |        | ±20% | GCM155R72A331MA37# |
|        |               |         | 390pF  | ±10% | GCM155R72A391KA37# |
|        |               |         |        | ±20% | GCM155R72A391MA37# |
|        |               |         | 470pF  | ±10% | GCM155R72A471KA37# |
|        |               |         |        | ±20% | GCM155R72A471MA37# |
|        |               |         | 560pF  | ±10% | GCM155R72A561KA37# |
|        |               |         |        | ±20% | GCM155R72A561MA37# |
|        |               |         | 680pF  | ±10% | GCM155R72A681KA37# |
|        |               |         |        | ±20% | GCM155R72A681MA37# |
|        |               |         | 820pF  | ±10% | GCM155R72A821KA37# |
|        |               |         |        | ±20% | GCM155R72A821MA37# |
|        |               |         | 1000pF | ±10% | GCM155R72A102KA37# |
|        |               |         |        | ±20% | GCM155R72A102MA37# |
|        |               |         | 1200pF | ±10% | GCM155R72A122KA37# |
|        |               |         |        | ±20% | GCM155R72A122MA37# |
|        |               |         | 1500pF | ±10% | GCM155R72A152KA37# |
|        |               |         |        | ±20% | GCM155R72A152MA37# |
|        |               |         | 1800pF | ±10% | GCM155R72A182KA37# |
|        |               |         |        | ±20% | GCM155R72A182MA37# |
|        |               |         | 2200pF | ±10% | GCM155R72A222KA37# |
|        |               |         |        | ±20% | GCM155R72A222MA37# |
|        |               |         | 2700pF | ±10% | GCM155R72A272KA37# |
|        |               |         |        | ±20% | GCM155R72A272MA37# |
|        |               |         | 3300pF | ±10% | GCM155R72A332KA37# |
|        |               |         |        | ±20% | GCM155R72A332MA37# |
|        |               |         | 3900pF | ±10% | GCM155R72A392KA37# |
|        |               |         |        | ±20% | GCM155R72A392MA37# |
|        |               |         | 4700pF | ±10% | GCM155R72A472KA37# |

Part number # indicates the package specification code.

# GCM Series High Dielectric Constant Type Part Number List

(→ 1.0×0.5mm)

| T max. | Rated Voltage | TC Code            | Cap.    | Tol.               | Part Number        | T max.  | Rated Voltage      | TC Code | Cap.   | Tol.   | Part Number        |                    |
|--------|---------------|--------------------|---------|--------------------|--------------------|---------|--------------------|---------|--------|--------|--------------------|--------------------|
| 0.55mm | 100Vdc        | X7R                | 4700pF  | ±20%               | GCM155R72A472MA37# | 0.55mm  | 50Vdc              | X7R     | 820pF  | ±20%   | GCM155R71H821MA37# |                    |
|        |               |                    |         | ±10%               | GCM155L81H221KA37# |         |                    |         | 1000pF | ±10%   | GCM155R71H102KA37# |                    |
|        | ±20%          | GCM155L81H221MA37# | ±20%    | GCM155R71H102MA37# | ±20%               |         | GCM155R71H102MA37# |         |        |        |                    |                    |
|        | ±10%          | GCM155L81H271KA37# | 1200pF  | ±10%               | GCM155R71H122KA37# |         |                    |         |        |        |                    |                    |
|        | ±20%          | GCM155L81H271MA37# | ±20%    | GCM155R71H122MA37# | ±20%               |         | GCM155R71H122MA37# |         |        |        |                    |                    |
|        | ±10%          | GCM155L81H331KA37# | 1500pF  | ±10%               | GCM155R71H152KA37# |         |                    |         |        |        |                    |                    |
|        | ±20%          | GCM155L81H331MA37# | ±20%    | GCM155R71H152MA37# | ±20%               |         | GCM155R71H152MA37# |         |        |        |                    |                    |
|        | ±10%          | GCM155L81H391KA37# | 1800pF  | ±10%               | GCM155R71H182KA37# |         |                    |         |        |        |                    |                    |
|        | ±20%          | GCM155L81H391MA37# | ±20%    | GCM155R71H182MA37# | ±20%               |         | GCM155R71H182MA37# |         |        |        |                    |                    |
|        | ±10%          | GCM155L81H471KA37# | 2200pF  | ±10%               | GCM155R71H222KA37# |         |                    |         |        |        |                    |                    |
|        | ±20%          | GCM155L81H471MA37# | ±20%    | GCM155R71H222MA37# | ±20%               |         | GCM155R71H222MA37# |         |        |        |                    |                    |
|        | ±10%          | GCM155L81H561KA37# | 2700pF  | ±10%               | GCM155R71H272KA37# |         |                    |         |        |        |                    |                    |
|        | ±20%          | GCM155L81H561MA37# | ±20%    | GCM155R71H272MA37# | ±20%               |         | GCM155R71H272MA37# |         |        |        |                    |                    |
|        | ±10%          | GCM155L81H681KA37# | 3300pF  | ±10%               | GCM155R71H332KA37# |         |                    |         |        |        |                    |                    |
|        | ±20%          | GCM155L81H681MA37# | ±20%    | GCM155R71H332MA37# | ±20%               |         | GCM155R71H332MA37# |         |        |        |                    |                    |
|        | ±10%          | GCM155L81H821KA37# | 3900pF  | ±10%               | GCM155R71H392KA37# |         |                    |         |        |        |                    |                    |
|        | ±20%          | GCM155L81H821MA37# | ±20%    | GCM155R71H392MA37# | ±20%               |         | GCM155R71H392MA37# |         |        |        |                    |                    |
|        | ±10%          | GCM155L81H102KA37# | 4700pF  | ±10%               | GCM155R71H472KA37# |         |                    |         |        |        |                    |                    |
|        | ±20%          | GCM155L81H102MA37# | ±20%    | GCM155R71H472MA37# | ±20%               |         | GCM155R71H472MA37# |         |        |        |                    |                    |
|        | ±10%          | GCM155L81H122KA37# | 5600pF  | ±10%               | GCM155R71H562KA55# |         |                    |         |        |        |                    |                    |
|        | ±20%          | GCM155L81H122MA37# | ±20%    | GCM155R71H562MA55# | ±20%               |         | GCM155R71H562MA55# |         |        |        |                    |                    |
|        | ±10%          | GCM155L81H152KA37# | 6800pF  | ±10%               | GCM155R71H682KA55# |         |                    |         |        |        |                    |                    |
|        | ±20%          | GCM155L81H152MA37# | ±20%    | GCM155R71H682MA55# | ±20%               |         | GCM155R71H682MA55# |         |        |        |                    |                    |
|        | ±10%          | GCM155L81H182KA37# | 8200pF  | ±10%               | GCM155R71H822KA55# |         |                    |         |        |        |                    |                    |
|        | ±20%          | GCM155L81H182MA37# | ±20%    | GCM155R71H822MA55# | ±20%               |         | GCM155R71H822MA55# |         |        |        |                    |                    |
|        | ±10%          | GCM155L81H222KA37# | 10000pF | ±10%               | GCM155R71H103KA55# |         |                    |         |        |        |                    |                    |
|        | ±20%          | GCM155L81H222MA37# | ±20%    | GCM155R71H103MA55# | ±20%               |         | GCM155R71H103MA55# |         |        |        |                    |                    |
|        | ±10%          | GCM155L81H272KA37# | 12000pF | ±10%               | GCM155R71H123KA55# |         |                    |         |        |        |                    |                    |
|        | ±20%          | GCM155L81H272MA37# | ±20%    | GCM155R71H123MA55# | ±20%               |         | GCM155R71H123MA55# |         |        |        |                    |                    |
|        | ±10%          | GCM155L81H332KA37# | 15000pF | ±10%               | GCM155R71H153KA55# |         |                    |         |        |        |                    |                    |
|        | ±20%          | GCM155L81H332MA37# | ±20%    | GCM155R71H153MA55# | ±20%               |         | GCM155R71H153MA55# |         |        |        |                    |                    |
|        | ±10%          | GCM155L81H392KA37# | 18000pF | ±10%               | GCM155R71H183KA55# |         |                    |         |        |        |                    |                    |
|        | ±20%          | GCM155L81H392MA37# | ±20%    | GCM155R71H183MA55# | ±20%               |         | GCM155R71H183MA55# |         |        |        |                    |                    |
|        | ±10%          | GCM155L81H472KA37# | 22000pF | ±10%               | GCM155R71H223KA55# |         |                    |         |        |        |                    |                    |
|        | ±20%          | GCM155L81H472MA37# | ±20%    | GCM155R71H223MA55# | ±20%               |         | GCM155R71H223MA55# |         |        |        |                    |                    |
|        | ±10%          | GCM155L8EH333KE07# | 33000pF | ±10%               | GCM155R71H333KE02# |         |                    |         |        |        |                    |                    |
|        |               |                    | ±20%    | GCM155R71H333ME02# | ±20%               |         | GCM155R71H333ME02# |         |        |        |                    |                    |
|        | ±10%          | GCM155L8EH473KE07# | 47000pF | ±10%               | GCM155R71H473KE02# |         |                    |         |        |        |                    |                    |
|        |               |                    | ±20%    | GCM155R71H473ME02# | ±20%               |         | GCM155R71H473ME02# |         |        |        |                    |                    |
|        | ±10%          | GCM155L8EH683KE07# | 68000pF | ±10%               | GCM155R71H473KE02# |         |                    |         |        |        |                    |                    |
|        |               |                    | ±20%    | GCM155R71H473ME02# | ±20%               |         | GCM155R71H473ME02# |         |        |        |                    |                    |
|        | ±10%          | GCM155L8EH104KE07# | 0.10μF  | ±10%               | GCM155R71H473KE02# |         |                    |         |        |        |                    |                    |
|        |               |                    | ±20%    | GCM155R71H473ME02# | ±20%               |         | GCM155R71H473ME02# |         |        |        |                    |                    |
|        | X7R           | 50Vdc              | X8L     | 220pF              | ±10%               |         | GCM155R71H221KA37# | 25Vdc   | X8L    | 5600pF | ±10%               | GCM155L81E562KA37# |
|        |               |                    |         |                    | ±20%               |         | GCM155R71H221MA37# |         |        |        | ±20%               | GCM155L81E562MA37# |
|        |               |                    |         |                    | ±10%               |         | GCM155R71H271KA37# |         |        |        | ±10%               | GCM155L81E682KA37# |
| ±20%   |               |                    |         |                    | GCM155R71H271MA37# | ±20%    | GCM155L81E682MA37# |         |        |        |                    |                    |
| ±10%   |               |                    |         |                    | GCM155R71H331KA37# | 8200pF  | ±10%               |         |        |        | GCM155L81E822KA37# |                    |
| ±20%   |               |                    |         |                    | GCM155R71H331MA37# | ±20%    | GCM155L81E822MA37# |         |        |        |                    |                    |
| ±10%   |               |                    |         |                    | GCM155R71H391KA37# | 10000pF | ±10%               |         |        |        | GCM155L81E103KA37# |                    |
| ±20%   |               |                    |         |                    | GCM155R71H391MA37# | ±20%    | GCM155L81E103MA37# |         |        |        |                    |                    |
| ±10%   |               |                    |         |                    | GCM155R71H471KA37# | 0.10μF  | ±10%               |         |        |        | GCM155L81E104KE02# |                    |
| ±20%   |               |                    |         |                    | GCM155R71H471MA37# | ±20%    | GCM155L81E104ME02# |         |        |        |                    |                    |
| ±10%   |               |                    |         |                    | GCM155R71H561KA37# | ±10%    | GCM155R71E472KA37# |         |        |        |                    |                    |
| ±20%   |               |                    |         |                    | GCM155R71H561MA37# | ±20%    | GCM155R71E472MA37# |         |        |        |                    |                    |
| ±10%   |               |                    |         |                    | GCM155R71H681KA37# | 5600pF  | ±10%               |         |        |        | GCM155R71E562KA37# |                    |
| ±20%   |               |                    |         |                    | GCM155R71H681MA37# | ±20%    | GCM155R71E562MA37# |         |        |        |                    |                    |

Part number # indicates the package specification code.

GRT Series  
 GCM Series  
 GC3 Series  
 GCJ Series  
 GCQ Series  
 GCD Series  
 GCE Series  
 NMF Series  
 KCM Series  
 KC3 Series  
 KCA Series  
 GCB Series  
 GCG Series  
 ⚠Caution /Notice

# GCM Series High Dielectric Constant Type Part Number List

(→ 1.0×0.5mm)

| T max.  | Rated Voltage | TC Code            | Cap.               | Tol.               | Part Number        |
|---------|---------------|--------------------|--------------------|--------------------|--------------------|
| 0.55mm  | 25Vdc         | X7R                | 5600pF             | ±20%               | GCM155R71E562MA37# |
|         |               |                    | 6800pF             | ±10%               | GCM155R71E682KA37# |
|         |               |                    |                    | ±20%               | GCM155R71E682MA37# |
|         |               |                    |                    | ±20%               | GCM155R71E682MA37# |
|         |               |                    | 8200pF             | ±10%               | GCM155R71E822KA37# |
|         |               |                    |                    | ±20%               | GCM155R71E822MA37# |
|         |               |                    | 10000pF            | ±10%               | GCM155R71E103KA37# |
|         |               |                    |                    | ±20%               | GCM155R71E103MA37# |
|         |               |                    | 12000pF            | ±10%               | GCM155R71E123KA55# |
|         |               |                    |                    | ±20%               | GCM155R71E123MA55# |
|         |               |                    | 15000pF            | ±10%               | GCM155R71E153KA55# |
|         |               |                    |                    | ±20%               | GCM155R71E153MA55# |
|         |               |                    | 18000pF            | ±10%               | GCM155R71E183KA55# |
|         |               |                    |                    | ±20%               | GCM155R71E183MA55# |
|         |               |                    | 22000pF            | ±10%               | GCM155R71E223KA55# |
|         |               |                    |                    | ±20%               | GCM155R71E223MA55# |
|         |               |                    | 27000pF            | ±10%               | GCM155R71E273KA55# |
|         |               |                    |                    | ±20%               | GCM155R71E273MA55# |
|         | 33000pF       | ±10%               | GCM155R71E333KA55# |                    |                    |
|         |               | ±20%               | GCM155R71E333MA55# |                    |                    |
|         | 39000pF       | ±10%               | GCM155R71E393KA55# |                    |                    |
|         |               | ±20%               | GCM155R71E393MA55# |                    |                    |
|         | 47000pF       | ±10%               | GCM155R71E473KA55# |                    |                    |
|         |               | ±20%               | GCM155R71E473MA55# |                    |                    |
|         | 0.10μF        | ±10%               | GCM155R71E104KE02# |                    |                    |
|         | 16Vdc         | X8L                | 15000pF            | ±10%               | GCM155L81C153KA37# |
|         |               |                    |                    | ±20%               | GCM155L81C153MA37# |
|         |               |                    | 18000pF            | ±10%               | GCM155L81C183KA37# |
|         |               |                    |                    | ±20%               | GCM155L81C183MA37# |
|         |               |                    | 22000pF            | ±10%               | GCM155L81C223KA37# |
|         |               |                    |                    | ±20%               | GCM155L81C223MA37# |
|         |               |                    | 27000pF            | ±10%               | GCM155L81C273KA37# |
|         |               |                    |                    | ±20%               | GCM155L81C273MA37# |
|         |               |                    | 33000pF            | ±10%               | GCM155L81C333KA37# |
|         |               | ±20%               |                    | GCM155L81C333MA37# |                    |
|         |               | 39000pF            | ±10%               | GCM155L81C393KA37# |                    |
| ±20%    |               |                    | GCM155L81C393MA37# |                    |                    |
| 47000pF |               | ±10%               | GCM155L81C473KA37# |                    |                    |
|         |               | ±20%               | GCM155L81C473MA37# |                    |                    |
| X7R     |               | 27000pF            | ±10%               | GCM155R71C273KA37# |                    |
|         |               |                    | ±20%               | GCM155R71C273MA37# |                    |
|         |               | 33000pF            | ±10%               | GCM155R71C333KA37# |                    |
|         |               |                    | ±20%               | GCM155R71C333MA37# |                    |
|         | 39000pF       | ±10%               | GCM155R71C393KA37# |                    |                    |
|         |               | ±20%               | GCM155R71C393MA37# |                    |                    |
|         | 47000pF       | ±10%               | GCM155R71C473KA37# |                    |                    |
|         |               | ±20%               | GCM155R71C473MA37# |                    |                    |
|         | 56000pF       | ±10%               | GCM155R71C563KA55# |                    |                    |
| ±20%    |               | GCM155R71C563MA55# |                    |                    |                    |
| 68000pF | ±10%          | GCM155R71C683KA55# |                    |                    |                    |
|         | ±20%          | GCM155R71C683MA55# |                    |                    |                    |
| 82000pF | ±10%          | GCM155R71C823KA55# |                    |                    |                    |
|         | ±20%          | GCM155R71C823MA55# |                    |                    |                    |
| 0.10μF  | ±10%          | GCM155R71C104KA55# |                    |                    |                    |
|         | ±20%          | GCM155R71C104MA55# |                    |                    |                    |

| T max. | Rated Voltage | TC Code | Cap.   | Tol.               | Part Number        |
|--------|---------------|---------|--------|--------------------|--------------------|
| 0.55mm | 16Vdc         | X7R     | 0.15μF | ±10%               | GCM155R71C154KE02# |
|        |               |         |        | ±20%               | GCM155R71C154ME02# |
|        |               |         |        | ±20%               | GCM155R71C154ME02# |
|        |               |         | 0.22μF | ±10%               | GCM155R71C224KE02# |
|        |               |         |        | ±20%               | GCM155R71C224ME02# |
|        |               |         |        | ±20%               | GCM155R71C224ME02# |
| 10Vdc  | X7R           | 0.10μF  | ±10%   | GCM155R71A104KA55# |                    |
|        |               |         | ±20%   | GCM155R71A104KA55# |                    |
| 0.6mm  | 10Vdc         | X7S     | 0.47μF | ±10%               | GCM155C71A474KE36# |
|        |               |         |        | ±20%               | GCM155C71A474ME36# |
| 0.7mm  | 10Vdc         | X7S     | 0.68μF | ±10%               | GCM155C71A684KE38# |
|        |               |         |        | ±20%               | GCM155C71A684ME38# |
|        |               |         | 1.0μF  | ±10%               | GCM155C71A105KE38# |
|        |               |         |        | ±20%               | GCM155C71A105ME38# |

## 1.6×0.8mm

| T max.  | Rated Voltage | TC Code | Cap.    | Tol.               | Part Number        |                    |
|---------|---------------|---------|---------|--------------------|--------------------|--------------------|
| 0.9mm   | 100Vdc        | X8R     | 1000pF  | ±10%               | GCM188R92A102KA37# |                    |
|         |               |         |         | ±20%               | GCM188R92A102MA37# |                    |
|         |               |         | 1500pF  | ±10%               | GCM188R92A152KA37# |                    |
|         |               |         |         | ±20%               | GCM188R92A152MA37# |                    |
|         |               |         | 2200pF  | ±10%               | GCM188R92A222KA37# |                    |
|         |               |         |         | ±20%               | GCM188R92A222MA37# |                    |
|         |               |         | 3300pF  | ±10%               | GCM188R92A332KA37# |                    |
|         |               |         |         | ±20%               | GCM188R92A332MA37# |                    |
|         |               |         | 4700pF  | ±10%               | GCM188R92A472KA37# |                    |
|         |               |         |         | ±20%               | GCM188R92A472MA37# |                    |
|         |               |         | 6800pF  | ±10%               | GCM188R92A682KA37# |                    |
|         |               |         |         | ±20%               | GCM188R92A682MA37# |                    |
|         |               |         | 10000pF | ±10%               | GCM188R92A103KA37# |                    |
|         |               |         |         | ±20%               | GCM188R92A103MA37# |                    |
|         |               |         | X7R     | 5600pF             | ±10%               | GCM188R72A562KA37# |
|         |               |         |         |                    | ±20%               | GCM188R72A562MA37# |
|         |               |         |         | 6800pF             | ±10%               | GCM188R72A682KA37# |
|         |               |         |         |                    | ±20%               | GCM188R72A682MA37# |
|         |               | 8200pF  |         | ±10%               | GCM188R72A822KA37# |                    |
|         |               |         |         | ±20%               | GCM188R72A822MA37# |                    |
|         |               | 10000pF |         | ±10%               | GCM188R72A103KA37# |                    |
|         |               |         |         | ±20%               | GCM188R72A103MA37# |                    |
|         |               | 12000pF |         | ±10%               | GCM188R72A123KA37# |                    |
|         |               |         | ±20%    | GCM188R72A123MA37# |                    |                    |
|         |               | 15000pF | ±10%    | GCM188R72A153KA37# |                    |                    |
|         |               |         | ±20%    | GCM188R72A153MA37# |                    |                    |
|         |               | 18000pF | ±10%    | GCM188R72A183KA37# |                    |                    |
|         |               |         | ±20%    | GCM188R72A183MA37# |                    |                    |
|         |               | 22000pF | ±10%    | GCM188R72A223KA37# |                    |                    |
|         |               |         | ±20%    | GCM188R72A223MA37# |                    |                    |
|         |               | 50Vdc   | X8L     | 5600pF             | ±10%               | GCM188L81H562KA03# |
|         |               |         |         |                    | ±20%               | GCM188L81H562MA03# |
|         |               |         |         | 6800pF             | ±10%               | GCM188L81H682KA03# |
|         |               |         |         |                    | ±20%               | GCM188L81H682MA03# |
|         |               |         |         | 8200pF             | ±10%               | GCM188L81H822KA03# |
|         |               |         |         |                    | ±20%               | GCM188L81H822MA03# |
| 10000pF | ±10%          |         |         | GCM188L81H103KA03# |                    |                    |
|         | ±20%          |         |         | GCM188L81H103MA03# |                    |                    |

Part number # indicates the package specification code.

# GCM Series High Dielectric Constant Type Part Number List

(→ 1.6×0.8mm)

| T max. | Rated Voltage | TC Code | Cap.               | Tol.               | Part Number        |
|--------|---------------|---------|--------------------|--------------------|--------------------|
| 0.9mm  | 50Vdc         | X8L     | 12000pF            | ±10%               | GCM188L81H123KA37# |
|        |               |         |                    | ±20%               | GCM188L81H123MA37# |
|        |               |         | 15000pF            | ±10%               | GCM188L81H153KA37# |
|        |               |         |                    | ±20%               | GCM188L81H153MA37# |
|        |               |         | 18000pF            | ±10%               | GCM188L81H183KA37# |
|        |               |         |                    | ±20%               | GCM188L81H183MA37# |
|        |               |         | 22000pF            | ±10%               | GCM188L81H223KA37# |
|        |               |         |                    | ±20%               | GCM188L81H223MA37# |
|        |               |         | 27000pF            | ±10%               | GCM188L81H273KA55# |
|        |               |         |                    | ±20%               | GCM188L81H273MA55# |
|        |               |         | 33000pF            | ±10%               | GCM188L81H333KA55# |
|        |               |         |                    | ±20%               | GCM188L81H333MA55# |
|        |               |         | 39000pF            | ±10%               | GCM188L81H393KA55# |
|        |               |         |                    | ±20%               | GCM188L81H393MA55# |
|        |               |         | 47000pF            | ±10%               | GCM188L81H473KA55# |
|        |               |         |                    | ±20%               | GCM188L81H473MA55# |
|        |               |         | 56000pF            | ±10%               | GCM188L81H563KA57# |
|        |               |         |                    | ±20%               | GCM188L81H563MA57# |
|        |               |         | 68000pF            | ±10%               | GCM188L81H683KA57# |
|        |               |         |                    | ±20%               | GCM188L81H683MA57# |
|        |               |         | 82000pF            | ±10%               | GCM188L81H823KA57# |
|        |               |         |                    | ±20%               | GCM188L81H823MA57# |
|        |               |         | 0.10μF             | ±10%               | GCM188L81H104KA57# |
|        |               |         |                    | ±20%               | GCM188L81H104MA57# |
|        |               | X8R     | 1000pF             | ±10%               | GCM188R91H102KA37# |
|        |               |         |                    | ±20%               | GCM188R91H102MA37# |
|        |               |         | 1500pF             | ±10%               | GCM188R91H152KA37# |
|        |               |         |                    | ±20%               | GCM188R91H152MA37# |
|        |               |         | 2200pF             | ±10%               | GCM188R91H222KA37# |
|        |               |         |                    | ±20%               | GCM188R91H222MA37# |
|        |               |         | 3300pF             | ±10%               | GCM188R91H332KA37# |
|        |               |         |                    | ±20%               | GCM188R91H332MA37# |
|        |               |         | 4700pF             | ±10%               | GCM188R91H472KA37# |
|        |               |         |                    | ±20%               | GCM188R91H472MA37# |
|        |               |         | 6800pF             | ±10%               | GCM188R91H682KA37# |
|        |               |         |                    | ±20%               | GCM188R91H682MA37# |
|        |               | 10000pF | ±10%               | GCM188R91H103KA37# |                    |
|        |               |         | ±20%               | GCM188R91H103MA37# |                    |
|        |               | 15000pF | ±10%               | GCM188R91H153KA37# |                    |
|        |               |         | ±20%               | GCM188R91H153MA37# |                    |
|        |               | 22000pF | ±10%               | GCM188R91H223KA37# |                    |
|        |               |         | ±20%               | GCM188R91H223MA37# |                    |
|        |               | 33000pF | ±10%               | GCM188R91H333KA37# |                    |
|        |               |         | ±20%               | GCM188R91H333MA37# |                    |
|        |               | 47000pF | ±10%               | GCM188R91H473KA37# |                    |
|        |               |         | ±20%               | GCM188R91H473MA37# |                    |
|        |               | X7R     | 0.15μF             | ±10%               | GCM188R71H154KA64# |
|        |               |         |                    | ±20%               | GCM188R71H154MA64# |
| 0.22μF | ±10%          |         | GCM188R71H224KA64# |                    |                    |
|        | ±20%          |         | GCM188R71H224MA64# |                    |                    |
| 25Vdc  | X8L           | 0.22μF  | ±10%               | GCM188L81E224KA64# |                    |
|        |               | X8R     | 68000pF            | ±10%               | GCM188R91E683KA37# |
|        | ±20%          |         | GCM188R91E683MA37# |                    |                    |
|        | 0.10μF        |         | ±10%               | GCM188R91E104KA37# |                    |

| T max. | Rated Voltage | TC Code | Cap.               | Tol.               | Part Number        |                    |
|--------|---------------|---------|--------------------|--------------------|--------------------|--------------------|
| 0.9mm  | 25Vdc         | X8R     | 0.10μF             | ±20%               | GCM188R91E104MA37# |                    |
|        |               |         | X7R                | 0.12μF             | ±10%               | GCM188R71E124KA37# |
|        |               | ±20%    |                    | GCM188R71E124MA37# |                    |                    |
|        |               | 0.15μF  | ±10%               | GCM188R71E154KA37# |                    |                    |
|        |               |         | ±20%               | GCM188R71E154MA37# |                    |                    |
|        |               | 0.18μF  | ±10%               | GCM188R71E184KA55# |                    |                    |
|        |               |         | ±20%               | GCM188R71E184MA55# |                    |                    |
|        |               | 0.22μF  | ±10%               | GCM188R71E224KA55# |                    |                    |
|        |               |         | ±20%               | GCM188R71E224MA55# |                    |                    |
|        |               | 0.47μF  | ±10%               | GCM188R71E474KA64# |                    |                    |
|        |               |         | ±20%               | GCM188R71E474MA64# |                    |                    |
|        |               | 1.0μF   | ±10%               | GCM188R71E105KA64# |                    |                    |
|        |               |         | ±20%               | GCM188R71E105MA64# |                    |                    |
|        |               | 16Vdc   | X8L                | 0.12μF             | ±10%               | GCM188L81C124KA37# |
|        |               |         |                    |                    | ±20%               | GCM188L81C124MA37# |
|        |               |         |                    | 0.15μF             | ±10%               | GCM188L81C154KA37# |
|        |               |         |                    |                    | ±20%               | GCM188L81C154MA37# |
|        |               |         |                    | 0.18μF             | ±10%               | GCM188L81C184KA37# |
|        | ±20%          |         |                    |                    | GCM188L81C184MA37# |                    |
|        | 0.22μF        |         | ±10%               | GCM188L81C224KA37# |                    |                    |
|        |               |         | ±20%               | GCM188L81C224MA37# |                    |                    |
|        | X7R           |         | 0.27μF             | ±10%               | GCM188R71C274KA37# |                    |
|        |               |         |                    | ±20%               | GCM188R71C274MA37# |                    |
|        |               |         | 0.33μF             | ±10%               | GCM188R71C334KA37# |                    |
|        |               |         |                    | ±20%               | GCM188R71C334MA37# |                    |
|        |               |         | 0.39μF             | ±10%               | GCM188R71C394KA55# |                    |
|        |               |         |                    | ±20%               | GCM188R71C394MA55# |                    |
|        | 0.47μF        |         | ±10%               | GCM188R71C474KA55# |                    |                    |
|        |               |         | ±20%               | GCM188R71C474MA55# |                    |                    |
|        | 1.0μF         |         | ±10%               | GCM188R71C105KA64# |                    |                    |
|        |               |         | ±20%               | GCM188R71C105MA64# |                    |                    |
|        | X7S           | 0.68μF  | ±10%               | GCM188C71C684KA64# |                    |                    |
|        |               | ±20%    | GCM188C71C684MA64# |                    |                    |                    |
|        | 6.3Vdc        | X7R     | 2.2μF              | ±10%               | GCM188R70J225KE22# |                    |
|        |               |         |                    | ±20%               | GCM188R70J225ME22# |                    |
|        | 1.0mm         | 6.3Vdc  | X7T                | 10μF               | ±20%               | GCM188D70J106ME36# |
| 4Vdc   |               | X7T     | 10μF               | ±20%               | GCM188D70G106ME36# |                    |

## 2.0×1.25mm

| T max. | Rated Voltage | TC Code | Cap.    | Tol. | Part Number        |
|--------|---------------|---------|---------|------|--------------------|
| 0.95mm | 100Vdc        | X8R     | 10000pF | ±10% | GCM219R92A103KA37# |
|        |               |         |         | ±20% | GCM219R92A103MA37# |
|        |               |         | 15000pF | ±10% | GCM219R92A153KA37# |
|        |               |         |         | ±20% | GCM219R92A153MA37# |
|        |               |         | 22000pF | ±10% | GCM219R92A223KA37# |
|        |               |         |         | ±20% | GCM219R92A223MA37# |
|        |               | X7R     | 27000pF | ±10% | GCM219R72A273KA37# |
|        |               |         |         | ±20% | GCM219R72A273MA37# |
|        |               |         | 33000pF | ±10% | GCM219R72A333KA37# |
|        |               |         |         | ±20% | GCM219R72A333MA37# |
|        |               |         | 39000pF | ±10% | GCM219R72A393KA37# |
|        |               |         |         | ±20% | GCM219R72A393MA37# |

Part number # indicates the package specification code.

# GCM Series High Dielectric Constant Type Part Number List

(→ 2.0×1.25mm)

| T max. | Rated Voltage | TC Code            | Cap.               | Tol.               | Part Number        | T max.             | Rated Voltage      | TC Code                      | Cap.               | Tol.               | Part Number                  |
|--------|---------------|--------------------|--------------------|--------------------|--------------------|--------------------|--------------------|------------------------------|--------------------|--------------------|------------------------------|
| 0.95mm | 50Vdc         | X8R                | 1000pF             | ±10%               | GCM219R91H103KA37# | 1.4mm              | 50Vdc              | X7R                          | 1.0μF              | ±10%               | GCM21BR71H105KA03#           |
|        |               |                    |                    | ±20%               | GCM219R91H103MA37# |                    |                    |                              |                    | ±20%               | GCM21BR71H105MA03#           |
|        |               |                    | 1500pF             | ±10%               | GCM219R91H153KA37# |                    |                    | X8L                          | 2.2μF              | ±10%               | GCM21BL8EG225KE07# <b>D4</b> |
|        |               |                    |                    | ±20%               | GCM219R91H153MA37# |                    |                    |                              |                    | X7R                | 0.68μF                       |
|        |               | 2200pF             | ±10%               | GCM219R91H223KA37# | ±20%               |                    |                    | GCM21BR7YA684MA55#           | 1.0μF              |                    |                              |
|        |               |                    | ±20%               | GCM219R91H223MA37# | ±20%               |                    |                    | GCM21BR7YA105MA55#           |                    | ±20%               | GCM21BR7YA105MA55#           |
|        | X7R           | 0.33μF             | ±10%               | GCM219R71H334KA55# | 1.5μF              |                    | ±10%               | GCM21BR7YA155KA54#           |                    |                    |                              |
|        |               |                    | ±20%               | GCM219R71H334MA55# |                    |                    | ±20%               | GCM21BR7YA155MA54#           |                    |                    |                              |
|        | 25Vdc         | X7R                | 0.47μF             | ±10%               | GCM219R71E474KA55# |                    | X7S                | 2.2μF                        | ±10%               | GCM21BC7YA225KE02# |                              |
|        |               |                    |                    | ±20%               | GCM219R71E474MA55# |                    |                    |                              | ±20%               | GCM21BC7YA225ME02# |                              |
|        | 16Vdc         | X7R                | 1.0μF              | ±10%               | GCM219R71C105KA37# |                    | 25Vdc              | X8L                          | 0.27μF             | ±10%               | GCM21BL81E274KA37#           |
|        |               |                    |                    | ±20%               | GCM219R71C105MA37# |                    |                    |                              |                    | ±20%               | GCM21BL81E274MA37#           |
| 1.4mm  | 100Vdc        | X8R                | 3300pF             | ±10%               | GCM21BR92A333KA37# | X8L                | 0.33μF             | ±10%                         | GCM21BL81E334KA37# |                    |                              |
|        |               |                    |                    | ±20%               | GCM21BR92A333MA37# |                    |                    | ±20%                         | GCM21BL81E334MA37# |                    |                              |
|        |               |                    | 4700pF             | ±10%               | GCM21BR92A473KA37# |                    | 0.39μF             | ±10%                         | GCM21BL81E394KA37# |                    |                              |
|        |               |                    |                    | ±20%               | GCM21BR92A473MA37# |                    |                    | ±20%                         | GCM21BL81E394MA37# |                    |                              |
|        |               | X7R                | 2700pF             | ±10%               | GCM21BR72A273KA37# |                    | 0.47μF             | ±10%                         | GCM21BL81E474KA37# |                    |                              |
|        |               |                    |                    | ±20%               | GCM21BR72A273MA37# |                    |                    | ±20%                         | GCM21BL81E474MA37# |                    |                              |
|        |               | 3300pF             | ±10%               | GCM21BR72A333KA37# | 1.5μF              |                    | ±10%               | GCM21BL8EF155KA07# <b>D4</b> |                    |                    |                              |
|        |               |                    |                    | ±20%               |                    |                    | GCM21BR72A333MA37# | X8R                          | 0.15μF             | ±10%               | GCM21BR91E154KA37#           |
|        |               | 3900pF             | ±10%               | GCM21BR72A393KA37# | ±20%               |                    | GCM21BR91E154MA37# |                              |                    |                    |                              |
|        |               |                    |                    | ±20%               | GCM21BR72A393MA37# |                    | 0.22μF             | ±10%                         | GCM21BR91E224KA37# |                    |                              |
|        |               | 4700pF             | ±10%               | GCM21BR72A473KA37# | ±20%               |                    |                    | GCM21BR91E224MA37#           |                    |                    |                              |
|        |               |                    |                    | ±20%               | GCM21BR72A473MA37# |                    | 0.33μF             | ±10%                         | GCM21BR91E334KA37# |                    |                              |
|        |               | 5600pF             | ±10%               | GCM21BR72A563KA37# | ±20%               |                    |                    | GCM21BR91E334MA37#           |                    |                    |                              |
|        |               |                    |                    | ±20%               | GCM21BR72A563MA37# |                    | X7R                | 0.27μF                       | ±10%               | GCM21BR71E274KA37# |                              |
|        |               | 6800pF             | ±10%               | GCM21BR72A683KA37# | ±20%               |                    |                    |                              | GCM21BR71E274MA37# |                    |                              |
|        |               |                    |                    | ±20%               | GCM21BR72A683MA37# |                    | 0.33μF             | ±10%                         | GCM21BR71E334KA37# |                    |                              |
|        |               | 8200pF             | ±10%               | GCM21BR72A823KA37# | ±20%               |                    |                    | GCM21BR71E334MA37#           |                    |                    |                              |
|        |               |                    |                    | ±20%               | GCM21BR72A823MA37# |                    | 0.39μF             | ±10%                         | GCM21BR71E394KA37# |                    |                              |
|        | 0.10μF        | ±10%               | GCM21BR72A104KA37# | ±20%               | GCM21BR71E394MA37# |                    |                    |                              |                    |                    |                              |
|        |               |                    | ±20%               | GCM21BR72A104MA37# | 0.47μF             | ±10%               | GCM21BR71E474KA37# |                              |                    |                    |                              |
|        | 50Vdc         | X8L                | 0.12μF             | ±10%               |                    | GCM21BL81H124KA37# | ±20%               | GCM21BR71E474MA37#           |                    |                    |                              |
|        |               |                    |                    | ±20%               | GCM21BL81H124MA37# | 0.56μF             | ±10%               | GCM21BR71E564KA55#           |                    |                    |                              |
|        |               |                    | 0.15μF             | ±10%               | GCM21BL81H154KA37# |                    | ±20%               | GCM21BR71E564MA55#           |                    |                    |                              |
|        |               |                    |                    | ±20%               | GCM21BL81H154MA37# | 0.68μF             | ±10%               | GCM21BR71E684KA55#           |                    |                    |                              |
|        |               |                    | 0.18μF             | ±10%               | GCM21BL81H184KA37# |                    | ±20%               | GCM21BR71E684MA55#           |                    |                    |                              |
|        |               |                    |                    | ±20%               | GCM21BL81H184MA37# | 0.82μF             | ±10%               | GCM21BR71E824KA55#           |                    |                    |                              |
|        |               |                    | 0.22μF             | ±10%               | GCM21BL81H224KA37# |                    | ±20%               | GCM21BR71E824MA55#           |                    |                    |                              |
|        |               |                    |                    | ±20%               | GCM21BL81H224MA37# | 1.0μF              | ±10%               | GCM21BR71E105KA56#           |                    |                    |                              |
|        |               |                    | 0.33μF             | ±10%               | GCM21BL81H334KA56# |                    | ±20%               | GCM21BR71E105MA56#           |                    |                    |                              |
|        |               |                    |                    | ±20%               | GCM21BL81H334MA56# | 1.5μF              | ±10%               | GCM21BR71E155KA54#           |                    |                    |                              |
|        |               |                    | X8R                | 3300pF             | ±10%               |                    | GCM21BR91H333KA37# | ±20%                         | GCM21BR71E155MA54# |                    |                              |
|        |               |                    |                    |                    | ±20%               | GCM21BR91H333MA37# | 2.2μF              | ±10%                         | GCM21BR71E225KA73# |                    |                              |
|        |               | 4700pF             | ±10%               | GCM21BR91H473KA37# | ±20%               | GCM21BR71E225MA73# |                    |                              |                    |                    |                              |
|        |               |                    |                    | ±20%               | GCM21BR91H473MA37# | 16Vdc              | X8L                | 0.27μF                       | ±10%               | GCM21BL81C274KA37# |                              |
|        |               | 6800pF             | ±10%               | GCM21BR91H683KA37# | ±20%               |                    |                    |                              | GCM21BL81C274MA37# |                    |                              |
|        |               |                    |                    | ±20%               | GCM21BR91H683MA37# | 0.33μF             | ±10%               | GCM21BL81C334KA37#           |                    |                    |                              |
| 0.10μF |               | ±10%               | GCM21BR91H104KA37# | ±20%               | GCM21BL81C334MA37# |                    |                    |                              |                    |                    |                              |
|        |               |                    | ±20%               | GCM21BR91H104MA37# | 0.39μF             | ±10%               | GCM21BL81C394KA37# |                              |                    |                    |                              |
| X7R    | 0.22μF        | ±10%               | GCM21BR71H224KA37# | ±20%               |                    | GCM21BL81C394MA37# |                    |                              |                    |                    |                              |
|        |               | ±20%               | GCM21BR71H224MA37# | 0.47μF             | ±10%               | GCM21BL81C474KA37# |                    |                              |                    |                    |                              |
| 0.47μF | ±10%          | GCM21BR71H474KA55# | ±20%               |                    | GCM21BL81C474MA37# |                    |                    |                              |                    |                    |                              |
|        |               | ±20%               | GCM21BR71H474MA55# |                    |                    |                    |                    |                              |                    |                    |                              |

GRT Series  
 GCM Series  
 GC3 Series  
 GCJ Series  
 GCQ Series  
 GCD Series  
 GCE Series  
 NMF Series  
 KCM Series  
 KC3 Series  
 KCA Series  
 GCB Series  
 GCG Series  
 ⚠Caution /Notice

Part number # indicates the package specification code.

# GCM Series High Dielectric Constant Type Part Number List

(→ 2.0×1.25mm)

| T max. | Rated Voltage | TC Code | Cap.   | Tol.               | Part Number                  |
|--------|---------------|---------|--------|--------------------|------------------------------|
| 1.4mm  | 16Vdc         | X8L     | 0.56μF | ±10%               | GCM21BL81C564KA37#           |
|        |               |         |        | ±20%               | GCM21BL81C564MA37#           |
|        |               |         | 0.68μF | ±10%               | GCM21BL81C684KA37#           |
|        |               |         |        | ±20%               | GCM21BL81C684MA37#           |
|        |               |         | 0.82μF | ±10%               | GCM21BL81C824KA37#           |
|        |               |         |        | ±20%               | GCM21BL81C824MA37#           |
|        |               | 1.0μF   | ±10%   | GCM21BL81C105KA58# |                              |
|        |               |         | ±20%   | GCM21BL81C105MA58# |                              |
|        |               | X7R     | 1.0μF  | ±10%               | GCM21BR71C105KA58#           |
|        |               |         |        | ±20%               | GCM21BR71C105MA58#           |
|        |               |         | 1.5μF  | ±10%               | GCM21BR71C155KA37#           |
|        |               |         |        | ±20%               | GCM21BR71C155MA37#           |
|        |               |         | 2.2μF  | ±10%               | GCM21BR71C225KA64#           |
|        |               |         |        | ±20%               | GCM21BR71C225MA64#           |
|        |               | 3.3μF   | ±10%   | GCM21BR71C335KA73# |                              |
|        |               |         | ±20%   | GCM21BR71C335MA73# |                              |
|        |               | 4.7μF   | ±10%   | GCM21BR71C475KA73# |                              |
|        |               |         | ±20%   | GCM21BR71C475MA73# |                              |
|        | 10Vdc         | X7R     | 2.2μF  | ±10%               | GCM21BR71A225KA37#           |
|        |               |         |        | ±20%               | GCM21BR71A225MA37#           |
|        |               | 10μF    | ±10%   | GCM21BR71A106KE22# |                              |
|        |               |         | ±20%   | GCM21BR71A106ME22# |                              |
|        |               | X7S     | 4.7μF  | ±10%               | GCM21BC71A475KA73#           |
|        |               |         |        | ±20%               | GCM21BC71A475MA73#           |
| 6.3Vdc | X7R           | 10μF    | ±10%   | GCM21BR70J106KE22# |                              |
|        |               |         | ±20%   | GCM21BR70J106ME22# |                              |
| 1.45mm | 100Vdc        | X7S     | 1.0μF  | ±10%               | GCM21BC72A105KE36#           |
|        |               |         |        | ±20%               | GCM21BC72A105ME36#           |
|        |               | X8L     | 4.7μF  | ±10%               | GCM21BL8EG475KE08# <b>D4</b> |
|        |               |         |        | ±20%               | GCM21BC7YA475KE36#           |
|        | X7S           | 4.7μF   | ±10%   | GCM21BC7YA475ME36# |                              |
|        |               |         | ±20%   | GCM21BC7YA475ME36# |                              |
|        | 25Vdc         | X8L     | 4.7μF  | ±10%               | GCM21BL8EF475KE08# <b>D4</b> |
|        |               |         |        | ±20%               | GCM21BC71E475KE36#           |
|        |               | X7S     | 4.7μF  | ±10%               | GCM21BC71E475ME36#           |
|        |               |         |        | ±20%               | GCM21BC71E475ME36#           |
|        | 16Vdc         | X8M     | 10μF   | ±10%               | GCM21BM8EE106KE08# <b>D4</b> |
|        |               |         |        | ±20%               | GCM21BC71C106KE36#           |
| X7S    |               | 10μF    | ±10%   | GCM21BC71C106KE36# |                              |
|        |               |         | ±20%   | GCM21BC71C106ME36# |                              |

| T max. | Rated Voltage | TC Code | Cap.               | Tol.               | Part Number                  |                    |
|--------|---------------|---------|--------------------|--------------------|------------------------------|--------------------|
| 1.8mm  | 100Vdc        | X8L     | 2.2μF              | ±10%               | GCM31CL8EL225KE07# <b>D4</b> |                    |
|        |               |         |                    | ±20%               | GCM31CC72A225KE02#           |                    |
|        |               | X7S     | 2.2μF              | ±10%               | GCM31CC72A225ME02#           |                    |
|        |               |         |                    | ±20%               | GCM31CC72A225ME02#           |                    |
|        |               | 50Vdc   | X8L                | 0.56μF             | ±10%                         | GCM31CL81H564KA37# |
|        |               |         |                    |                    | ±20%                         | GCM31CL81H564MA37# |
|        | 0.68μF        |         |                    | ±10%               | GCM31CL81H684KA37#           |                    |
|        |               |         |                    | ±20%               | GCM31CL81H684MA37#           |                    |
|        | 0.82μF        |         |                    | ±10%               | GCM31CL81H824KA55#           |                    |
|        |               |         |                    | ±20%               | GCM31CL81H824MA55#           |                    |
|        | 1.0μF         |         | ±10%               | GCM31CL81H105KA55# |                              |                    |
|        |               |         | ±20%               | GCM31CL81H105MA55# |                              |                    |
|        | X8R           |         | 0.47μF             | ±10%               | GCM31CR91H474KA37#           |                    |
|        |               |         |                    | ±20%               | GCM31CR91H474MA37#           |                    |
|        | X7R           |         | 1.5μF              | ±10%               | GCM31CR71H155KA55#           |                    |
|        |               |         |                    | ±20%               | GCM31CR71H155MA55#           |                    |
|        |               | 2.2μF   | ±10%               | GCM31CR71H225KA55# |                              |                    |
|        |               |         | ±20%               | GCM31CR71H225MA55# |                              |                    |
|        |               | X7S     | 4.7μF              | ±10%               | GCM31CC71H475KA03#           |                    |
|        |               |         |                    | ±20%               | GCM31CC71H475MA03#           |                    |
|        | 25Vdc         | X8R     | 0.68μF             | ±10%               | GCM31CR91E684KA37#           |                    |
|        |               |         |                    | ±20%               | GCM31CR91E684MA37#           |                    |
|        |               | 1.0μF   | ±10%               | GCM31CR91E105KA37# |                              |                    |
|        |               |         | ±20%               | GCM31CR91E105MA37# |                              |                    |
| X7R    |               | 4.7μF   | ±10%               | GCM31CR71E475KA55# |                              |                    |
|        |               |         | ±20%               | GCM31CR71E475MA55# |                              |                    |
| 16Vdc  | X7R           | 4.7μF   | ±10%               | GCM31CR71C475KA37# |                              |                    |
|        |               |         | ±20%               | GCM31CR71C475MA37# |                              |                    |
|        | 10μF          | ±10%    | GCM31CR71C106KA64# |                    |                              |                    |
|        |               | ±20%    | GCM31CR71C106MA64# |                    |                              |                    |
|        | 10Vdc         | X7R     | 22μF               | ±10%               | GCM31CR71A226KE02#           |                    |
|        |               |         |                    | ±20%               | GCM31CR71A226ME02#           |                    |
| 6.3Vdc | X7R           | 22μF    | ±10%               | GCM31CR70J226KE23# |                              |                    |
|        |               |         | ±20%               | GCM31CR70J226ME23# |                              |                    |
| 1.9mm  | 35Vdc         | X8M     | 10μF               | ±10%               | GCM31CM8EG106KE08# <b>D4</b> |                    |
|        |               |         | ±20%               | GCM31CD7YA106KE36# |                              |                    |
|        | 25Vdc         | X7S     | 10μF               | ±10%               | GCM31CC71E106KA03#           |                    |
|        |               |         |                    | ±20%               | GCM31CC71E106MA03#           |                    |

## 3.2×1.6mm

| T max. | Rated Voltage | TC Code | Cap.               | Tol.               | Part Number        |
|--------|---------------|---------|--------------------|--------------------|--------------------|
| 1.25mm | 100Vdc        | X7R     | 0.22μF             | ±10%               | GCM31MR72A224KA37# |
|        |               |         |                    | ±20%               | GCM31MR72A224MA37# |
|        |               | X8L     | 0.39μF             | ±10%               | GCM31ML81H394KA37# |
|        |               |         |                    | ±20%               | GCM31ML81H394MA37# |
|        | 50Vdc         | X8L     | 0.47μF             | ±10%               | GCM31ML81H474KA37# |
|        |               |         |                    | ±20%               | GCM31ML81H474MA37# |
|        |               | X8R     | 0.22μF             | ±10%               | GCM31MR91H224KA37# |
|        |               |         |                    | ±20%               | GCM31MR91H224MA37# |
|        | 0.33μF        | ±10%    | GCM31MR91H334KA37# |                    |                    |
|        |               | ±20%    | GCM31MR91H334MA37# |                    |                    |
|        | 25Vdc         | X8L     | 1.0μF              | ±10%               | GCM31ML81E105KA37# |
|        |               |         |                    | ±20%               | GCM31MR91E474KA37# |
| X8R    |               | 0.47μF  | ±10%               | GCM31MR91E474KA37# |                    |
|        |               |         | ±20%               | GCM31MR91E474MA37# |                    |

## 3.2×2.5mm

| T max. | Rated Voltage | TC Code | Cap.  | Tol.               | Part Number                  |
|--------|---------------|---------|-------|--------------------|------------------------------|
| 2.2mm  | 100Vdc        | X8L     | 4.7μF | ±10%               | GCM32DL8EL475KE07# <b>D4</b> |
|        |               |         |       | ±20%               | GCM32DC72A475KE02#           |
|        |               | X7S     | 4.7μF | ±10%               | GCM32DC72A475ME02#           |
|        |               |         |       | ±20%               | GCM32DC72A475ME02#           |
|        | 10Vdc         | X8L     | 10μF  | ±10%               | GCM32DL81A106KA37#           |
|        |               |         |       | ±20%               | GCM32DL81A106MA37#           |
| 2.7mm  | 50Vdc         | X8L     | 10μF  | ±10%               | GCM32EL8EH106KA07# <b>D4</b> |
|        |               |         |       | ±20%               | GCM32ER71H475KA55#           |
|        |               | X7R     | 4.7μF | ±10%               | GCM32ER71H475MA55#           |
|        |               |         |       | ±20%               | GCM32ER71H475MA55#           |
|        | X7S           | 10μF    | ±10%  | GCM32EC71H106KA03# |                              |
|        |               |         | ±20%  | GCM32EC71H106MA03# |                              |
|        | 35Vdc         | X7S     | 10μF  | ±10%               | GCM32EC7YA106KA03#           |
|        |               |         |       | ±20%               | GCM32EC7YA106MA03#           |
| 25Vdc  |               | X7R     | 10μF  | ±10%               | GCM32ER71E106KA57#           |
|        |               |         |       | ±20%               | GCM32ER71E106MA57#           |

Part number # indicates the package specification code.



# GCM Series High Dielectric Constant Type Part Number List

(→ 3.2×2.5mm)

| T max. | Rated Voltage | TC Code | Cap.  | Tol. | Part Number        |                    |  |
|--------|---------------|---------|-------|------|--------------------|--------------------|--|
| 2.7mm  | 16Vdc         | X7R     | 22μF  | ±10% | GCM32ER71C226KE19# |                    |  |
|        |               |         |       | ±20% | GCM32ER71C226ME19# |                    |  |
|        | 10Vdc         | X7R     | 22μF  | ±10% | GCM32ER71A226KE12# |                    |  |
|        |               |         |       | ±20% | GCM32ER71A226ME12# |                    |  |
|        | 6.3Vdc        | X7R     | X7S   | 47μF | ±10%               | GCM32EC71A476KE02# |  |
|        |               |         | X7R   | 47μF | ±10%               | GCM32ER70J476KE19# |  |
|        |               |         |       | ±20% | GCM32ER70J476ME19# |                    |  |
| 2.85mm | 25Vdc         | X8L     | 22μF  | ±10% | GCM32EL8EF226KE08# | <b>D4</b>          |  |
|        |               | X7S     | 22μF  | ±10% | GCM32EC71E226KE36# |                    |  |
|        | 2.5Vdc        | X7T     | 100μF | ±20% | GCM32ED70E107ME36# |                    |  |

GRT Series  
 GCM Series  
 GC3 Series  
 GCJ Series  
 GCQ Series  
 GCD Series  
 GCE Series  
 NMF Series  
 KCM Series  
 KC3 Series  
 KCA Series  
 GCB Series  
 GCG Series  
 ⚠Caution /Notice

High Effective Capacitance & High Ripple Current Chip Multilayer Ceramic Capacitors for Automotive

# GC3 Series



This is a high ripple resistance product for automotive excellent in DC bias characteristics.

## Features

- ① When a DC bias is applied, a capacitance higher than conventional products (X7R characteristics) can be acquired.

When DC600V is applied, about twice the capacitance can be secured.

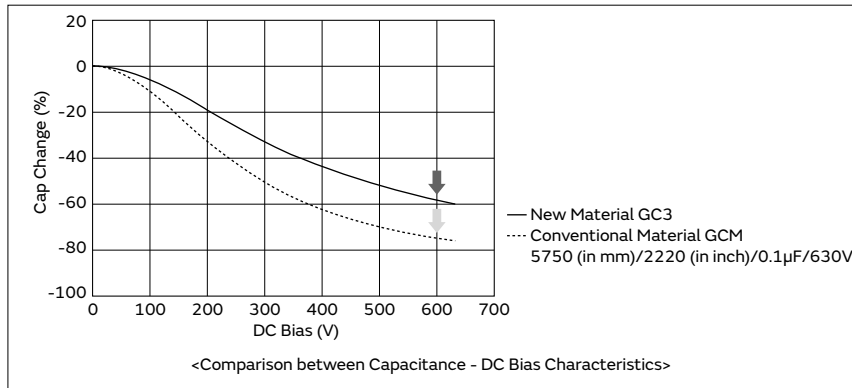

- ② Improved ripple resistance performance compared to conventional products (X7R characteristics).

In the case of a product with a capacitance of 0.1μF, when the exothermic temperature reaches 20°C at frequency f=300kHz, the amount of resistance of a product with conventional material is 1.8Arms; however, the new material is 2.3Arms.

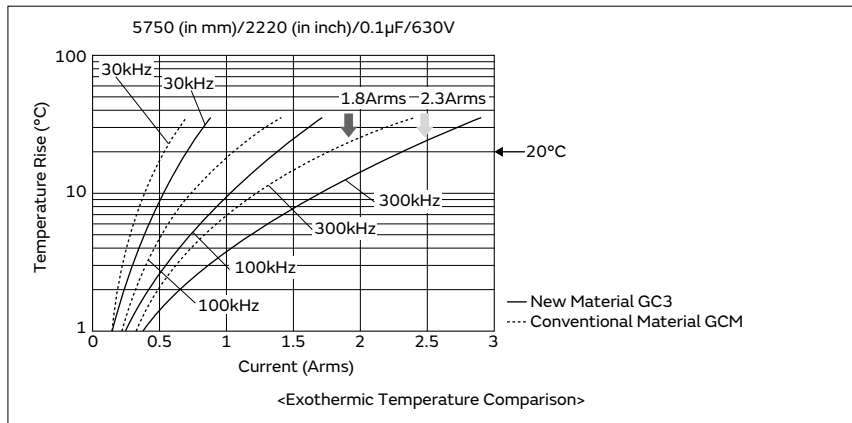

- ③ This product has a noise reduction effect.

Since dielectric materials that enable a reduction of noise are used, this product is more effective for reducing noise compared to the GCM series for automotive.

## Specifications

|                   |  |
|-------------------|--|
| Size              | 2.0×1.25mm to 5.7×5.0mm  |
| Rated Voltage     | 250Vdc to 630Vdc   |
| Capacitance       | 10000pF to 1.0μF   |
| Main Applications | For PFC (Power Factor Correction) Circuits of Power Supplies, EMI Suppression and Smoothing Circuits of automotive |

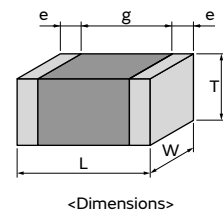

GRT Series  
 GCM Series  
 GC3 Series  
 GCJ Series  
 GCQ Series  
 GCD Series  
 GCE Series  
 NMF Series  
 KCM Series  
 KC3 Series  
 KCA Series  
 GCB Series  
 GCG Series  
 ⚠Caution /Notice

# GC3 Series High Dielectric Constant Type Part Number List

## 2.0×1.25mm

| T max. | Rated Voltage | TC Code | Cap.    | Tol. | Part Number        |
|--------|---------------|---------|---------|------|--------------------|
| 1.0mm  | 250Vdc        | X7T     | 10000pF | ±10% | GC321AD72E103KX01# |
|        |               |         | 15000pF | ±10% | GC321AD72E153KX01# |
| 1.45mm | 250Vdc        | X7T     | 22000pF | ±10% | GC321BD72E223KX03# |

| T max. | Rated Voltage | TC Code | Cap.  | Tol. | Part Number        |
|--------|---------------|---------|-------|------|--------------------|
| 2.7mm  | 250Vdc        | X7T     | 1.0μF | ±10% | GC355XD72E105KX05# |

## 3.2×1.6mm

| T max. | Rated Voltage | TC Code | Cap.    | Tol.               | Part Number        |
|--------|---------------|---------|---------|--------------------|--------------------|
| 1.0mm  | 450Vdc        | X7T     | 10000pF | ±10%               | GC331AD72W103KX01# |
|        |               |         | 15000pF | ±10%               | GC331AD72W153KX01# |
|        | 250Vdc        | X7T     | 33000pF | ±10%               | GC331AD72E333KX01# |
| 1.25mm | 630Vdc        | X7T     | 10000pF | ±10%               | GC331BD72J103KX01# |
|        | 450Vdc        | X7T     | 22000pF | ±10%               | GC331BD72W223KX01# |
|        |               |         | 33000pF | ±10%               | GC331BD72W333KX01# |
| 250Vdc | X7T           | 47000pF | ±10%    | GC331BD72E473KX01# |                    |
| 1.8mm  | 630Vdc        | X7T     | 15000pF | ±10%               | GC331CD72J153KX03# |
|        | 450Vdc        | X7T     | 47000pF | ±10%               | GC331CD72W473KX03# |
|        | 250Vdc        | X7T     | 68000pF | ±10%               | GC331CD72E683KX03# |

## 3.2×2.5mm

| T max. | Rated Voltage | TC Code | Cap.    | Tol.               | Part Number        |
|--------|---------------|---------|---------|--------------------|--------------------|
| 1.5mm  | 630Vdc        | X7T     | 22000pF | ±10%               | GC332QD72J223KX01# |
|        | 250Vdc        | X7T     | 0.10μF  | ±10%               | GC332QD72E104KX01# |
| 2.0mm  | 630Vdc        | X7T     | 33000pF | ±10%               | GC332DD72J333KX01# |
|        |               |         | 47000pF | ±10%               | GC332DD72J473KX01# |
|        | 450Vdc        | X7T     | 68000pF | ±10%               | GC332DD72W683KX01# |
|        |               |         | 0.10μF  | ±10%               | GC332DD72W104KX01# |
| 250Vdc | X7T           | 0.15μF  | ±10%    | GC332DD72E154KX01# |                    |

## 4.5×3.2mm

| T max. | Rated Voltage | TC Code | Cap.    | Tol. | Part Number        |
|--------|---------------|---------|---------|------|--------------------|
| 1.5mm  | 250Vdc        | X7T     | 0.22μF  | ±10% | GC343QD72E224KX01# |
| 2.0mm  | 630Vdc        | X7T     | 68000pF | ±10% | GC343DD72J683KX01# |
|        | 450Vdc        | X7T     | 0.15μF  | ±10% | GC343DD72W154KX01# |
|        | 250Vdc        | X7T     | 0.33μF  | ±10% | GC343DD72E334KX01# |

## 5.7×5.0mm

| T max. | Rated Voltage | TC Code | Cap.   | Tol.               | Part Number        |
|--------|---------------|---------|--------|--------------------|--------------------|
| 2.0mm  | 630Vdc        | X7T     | 0.10μF | ±10%               | GC355DD72J104KX01# |
|        |               |         | 0.15μF | ±10%               | GC355DD72J154KX01# |
|        | 450Vdc        | X7T     | 0.22μF | ±10%               | GC355DD72W224KX01# |
|        |               |         | 0.33μF | ±10%               | GC355DD72W334KX01# |
|        |               |         | 0.47μF | ±10%               | GC355DD72W474KX01# |
| 250Vdc | X7T           | 0.47μF  | ±10%   | GC355DD72E474KX01# |                    |
|        |               | 0.68μF  | ±10%   | GC355DD72E684KX01# |                    |
| 2.7mm  | 630Vdc        | X7T     | 0.22μF | ±10%               | GC355XD72J224KX05# |

Part number # indicates the package specification code.

Soft Termination Chip Multilayer Ceramic Capacitors for Automotive

**GCJ Series**



**Cracking caused by flexing stress after board mounting is minimized due to resin external electrodes!**

Features

① The resin external electrodes suppress cracks by board deflection.

Cracking of the ceramic element is suppressed by the resin of the external electrodes, which releases the stress.

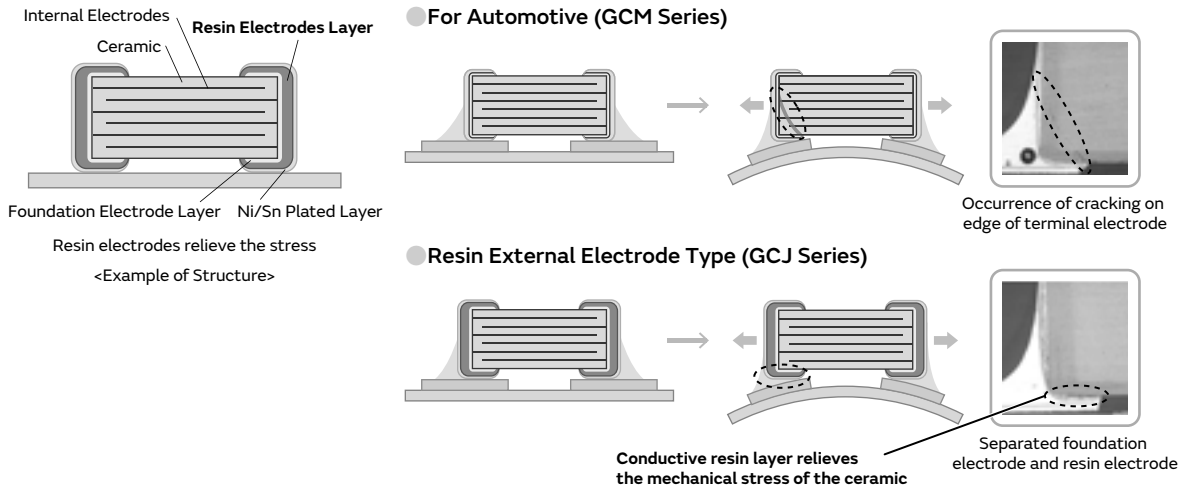

Note: Cracks may occur in the capacitor body if excessive stress beyond the "guaranteed range of board bending strength (\*)" provided in the specifications is applied. Capacitors with cracks in them may cause a drop in insulation resistance, which could lead to a short circuit.  
 (\*) For details on the guaranteed range of board bending strength, check the "Detailed Specification Sheet" on the Product Details Page.

② Suppresses the occurrence of cracking caused by deflection stress at the time of board mounting, etc.

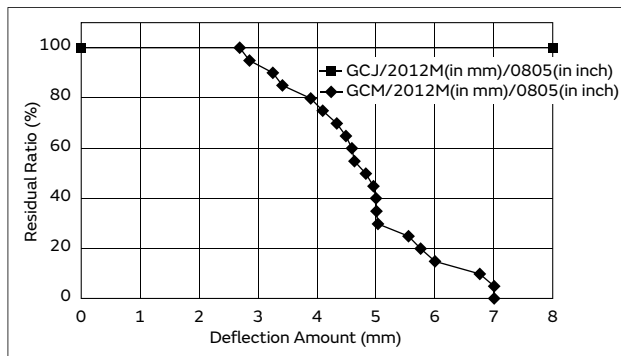

Due to the specification of the measuring instrument, measurements can be performed up 8 mm.

③ Ideal for automotive.

This AEC-Q200 conforming product is ideal for the ECU, control circuits of headlights, etc. of automotive.

Specifications

|                   |  |
|-------------------|--|
| Size              | 1.6×0.8mm to 5.7×5.0mm                       |
| Rated Voltage     | 6.3Vdc to 1000Vdc                            |
| Capacitance       | 1000pF to 47μF                               |
| Main Applications | Battery Lines and Powertrains for automotive |

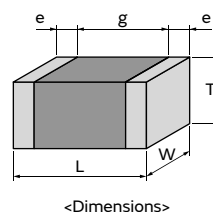

# GCJ Series High Dielectric Constant Type Part Number List

1.6×0.8mm

| T max. | Rated Voltage | TC Code | Cap.   | Tol.               | Part Number        |                    |  |
|--------|---------------|---------|--------|--------------------|--------------------|--------------------|--|
| 0.9mm  | 100Vdc        | X8L     | 0.10μF | ±10%               | GCJ188L8EL104KA07# | <b>D4</b>          |  |
|        |               |         |        |                    |                    |                    |  |
|        |               | X8R     | 1000pF | ±10%               | GCJ188R92A102KA01# |                    |  |
|        |               |         |        | ±20%               | GCJ188R92A102MA01# |                    |  |
|        |               |         | 1200pF | ±10%               | GCJ188R92A122KA01# |                    |  |
|        |               |         |        | ±20%               | GCJ188R92A122MA01# |                    |  |
|        |               |         | 1500pF | ±10%               | GCJ188R92A152KA01# |                    |  |
|        |               |         |        | ±20%               | GCJ188R92A152MA01# |                    |  |
|        |               |         | 1800pF | ±10%               | GCJ188R92A182KA01# |                    |  |
|        |               |         |        | ±20%               | GCJ188R92A182MA01# |                    |  |
|        |               |         | 2200pF | ±10%               | GCJ188R92A222KA01# |                    |  |
|        |               |         |        | ±20%               | GCJ188R92A222MA01# |                    |  |
|        |               |         | 2700pF | ±10%               | GCJ188R92A272KA01# |                    |  |
|        |               |         |        | ±20%               | GCJ188R92A272MA01# |                    |  |
|        |               |         | 3300pF | ±10%               | GCJ188R92A332KA01# |                    |  |
|        |               |         |        | ±20%               | GCJ188R92A332MA01# |                    |  |
|        |               |         | 3900pF | ±10%               | GCJ188R92A392KA01# |                    |  |
|        |               |         |        | ±20%               | GCJ188R92A392MA01# |                    |  |
|        |               |         | 4700pF | ±10%               | GCJ188R92A472KA01# |                    |  |
|        |               |         |        | ±20%               | GCJ188R92A472MA01# |                    |  |
|        |               |         | 5600pF | ±10%               | GCJ188R92A562KA01# |                    |  |
|        |               |         |        | ±20%               | GCJ188R92A562MA01# |                    |  |
|        |               | 6800pF  | ±10%   | GCJ188R92A682KA01# |                    |                    |  |
|        |               |         | ±20%   | GCJ188R92A682MA01# |                    |                    |  |
|        |               | 8200pF  | ±10%   | GCJ188R92A822KA01# |                    |                    |  |
|        |               |         | ±20%   | GCJ188R92A822MA01# |                    |                    |  |
|        |               | 10000pF | ±10%   | GCJ188R92A103KA01# |                    |                    |  |
|        |               |         | ±20%   | GCJ188R92A103MA01# |                    |                    |  |
|        |               | 12000pF | ±10%   | GCJ188R92A123KA01# |                    |                    |  |
|        |               |         | ±20%   | GCJ188R92A123MA01# |                    |                    |  |
|        |               | 15000pF | ±10%   | GCJ188R92A153KA01# |                    |                    |  |
|        |               |         | ±20%   | GCJ188R92A153MA01# |                    |                    |  |
|        |               | 18000pF | ±10%   | GCJ188R92A183KA01# |                    |                    |  |
|        |               |         | ±20%   | GCJ188R92A183MA01# |                    |                    |  |
|        |               | 22000pF | ±10%   | GCJ188R92A223KA01# |                    |                    |  |
|        |               |         | ±20%   | GCJ188R92A223MA01# |                    |                    |  |
|        |               | 27000pF | ±10%   | GCJ188R92A273KA01# |                    |                    |  |
|        |               |         | ±20%   | GCJ188R92A273MA01# |                    |                    |  |
|        |               | 33000pF | ±10%   | GCJ188R92A333KA01# |                    |                    |  |
|        |               |         | ±20%   | GCJ188R92A333MA01# |                    |                    |  |
|        |               | 39000pF | ±10%   | GCJ188R92A393KA01# |                    |                    |  |
|        |               |         | ±20%   | GCJ188R92A393MA01# |                    |                    |  |
|        |               | 47000pF | ±10%   | GCJ188R92A473KA01# |                    |                    |  |
|        |               |         | ±20%   | GCJ188R92A473MA01# |                    |                    |  |
|        |               | 56000pF | ±10%   | GCJ188R92A563KA01# |                    |                    |  |
|        |               |         | ±20%   | GCJ188R92A563MA01# |                    |                    |  |
|        |               | 68000pF | ±10%   | GCJ188R92A683KA01# |                    |                    |  |
|        |               |         | ±20%   | GCJ188R92A683MA01# |                    |                    |  |
|        |               | X7R     | 1000pF | ±10%               | GCJ188R72A102KA01# |                    |  |
|        |               |         |        | ±20%               | GCJ188R72A102MA01# |                    |  |
|        |               |         |        | 1200pF             | ±10%               | GCJ188R72A122KA01# |  |
|        |               |         |        |                    | ±20%               | GCJ188R72A122MA01# |  |
|        |               |         |        | 1500pF             | ±10%               | GCJ188R72A152KA01# |  |

| T max. | Rated Voltage | TC Code            | Cap.   | Tol.               | Part Number        |                    |           |
|--------|---------------|--------------------|--------|--------------------|--------------------|--------------------|-----------|
| 0.9mm  | 100Vdc        | X7R                | 1500pF | ±20%               | GCJ188R72A152MA01# |                    |           |
|        |               |                    |        |                    |                    |                    |           |
|        |               | 1800pF             | ±10%   | GCJ188R72A182KA01# |                    |                    |           |
|        |               |                    | ±20%   | GCJ188R72A182MA01# |                    |                    |           |
|        |               | 2200pF             | ±10%   | GCJ188R72A222KA01# |                    |                    |           |
|        |               |                    | ±20%   | GCJ188R72A222MA01# |                    |                    |           |
|        |               | 2700pF             | ±10%   | GCJ188R72A272KA01# |                    |                    |           |
|        |               |                    | ±20%   | GCJ188R72A272MA01# |                    |                    |           |
|        |               | 3300pF             | ±10%   | GCJ188R72A332KA01# |                    |                    |           |
|        |               |                    | ±20%   | GCJ188R72A332MA01# |                    |                    |           |
|        |               | 3900pF             | ±10%   | GCJ188R72A392KA01# |                    |                    |           |
|        |               |                    | ±20%   | GCJ188R72A392MA01# |                    |                    |           |
|        |               | 4700pF             | ±10%   | GCJ188R72A472KA01# |                    |                    |           |
|        |               |                    | ±20%   | GCJ188R72A472MA01# |                    |                    |           |
|        |               | 5600pF             | ±10%   | GCJ188R72A562KA01# |                    |                    |           |
|        |               |                    | ±20%   | GCJ188R72A562MA01# |                    |                    |           |
|        |               | 6800pF             | ±10%   | GCJ188R72A682KA01# |                    |                    |           |
|        |               |                    | ±20%   | GCJ188R72A682MA01# |                    |                    |           |
|        |               | 8200pF             | ±10%   | GCJ188R72A822KA01# |                    |                    |           |
|        |               |                    | ±20%   | GCJ188R72A822MA01# |                    |                    |           |
|        |               | 10000pF            | ±10%   | GCJ188R72A103KA01# |                    |                    |           |
|        |               |                    | ±20%   | GCJ188R72A103MA01# |                    |                    |           |
|        |               | 12000pF            | ±10%   | GCJ188R72A123KA01# |                    |                    |           |
|        |               |                    | ±20%   | GCJ188R72A123MA01# |                    |                    |           |
|        |               | 15000pF            | ±10%   | GCJ188R72A153KA01# |                    |                    |           |
|        |               |                    | ±20%   | GCJ188R72A153MA01# |                    |                    |           |
|        |               | 18000pF            | ±10%   | GCJ188R72A183KA01# |                    |                    |           |
|        |               |                    | ±20%   | GCJ188R72A183MA01# |                    |                    |           |
|        |               | 22000pF            | ±10%   | GCJ188R72A223KA01# |                    |                    |           |
|        |               |                    | ±20%   | GCJ188R72A223MA01# |                    |                    |           |
|        |               | 0.10μF             | ±10%   | GCJ188R72A104KA01# |                    |                    |           |
|        |               |                    | ±20%   | GCJ188R72A104MA01# |                    |                    |           |
|        |               | 50Vdc              | X8L    | 0.15μF             | ±10%               | GCJ188L8EH154KA07# | <b>D4</b> |
|        |               |                    |        |                    | ±20%               | GCJ188L8EH154MA07# |           |
|        |               |                    |        | 0.22μF             | ±10%               | GCJ188L8EH224KA07# | <b>D4</b> |
|        |               |                    |        |                    | ±20%               | GCJ188L8EH224MA07# |           |
|        |               |                    |        | 4700pF             | ±10%               | GCJ188R91H472KA01# |           |
|        |               |                    |        |                    | ±20%               | GCJ188R91H472MA01# |           |
|        |               |                    |        | 10000pF            | ±10%               | GCJ188R91H103KA01# |           |
|        |               |                    |        |                    | ±20%               | GCJ188R91H103MA01# |           |
|        |               |                    |        | 0.10μF             | ±10%               | GCJ188R91H104KA01# |           |
|        |               |                    |        |                    | ±20%               | GCJ188R91H104MA01# |           |
|        |               |                    | 0.12μF | ±10%               | GCJ188R91H124KA01# |                    |           |
|        |               |                    |        | ±20%               | GCJ188R91H124MA01# |                    |           |
|        |               |                    | 0.15μF | ±10%               | GCJ188R91H154KA01# |                    |           |
|        |               |                    |        | ±20%               | GCJ188R91H154MA01# |                    |           |
|        |               |                    | 0.18μF | ±10%               | GCJ188R91H184KA01# |                    |           |
|        |               |                    |        | ±20%               | GCJ188R91H184MA01# |                    |           |
|        |               |                    | 0.22μF | ±10%               | GCJ188R91H224KA01# |                    |           |
|        |               |                    |        | ±20%               | GCJ188R91H224MA01# |                    |           |
|        |               |                    | X7R    | 1000pF             | ±10%               | GCJ188R71H102KA01# |           |
|        |               |                    |        |                    | ±20%               | GCJ188R71H102MA01# |           |
|        |               | 1200pF             |        |                    | ±10%               | GCJ188R71H122KA01# |           |
|        |               |                    |        |                    | ±20%               | GCJ188R71H122MA01# |           |
| 1500pF | ±10%          | GCJ188R71H152KA01# |        |                    |                    |                    |           |
| 1800pF | ±10%          | GCJ188R71H182KA01# |        |                    |                    |                    |           |
|        | ±20%          | GCJ188R71H182MA01# |        |                    |                    |                    |           |

GRT Series  
 GCM Series  
 GC3 Series  
 GCJ Series  
 GCQ Series  
 GCD Series  
 GCE Series  
 NMF Series  
 KCM Series  
 KC3 Series  
 KCA Series  
 GCB Series  
 GCG Series  
 ⚠Caution /Notice

Part number # indicates the package specification code.

# GCJ Series High Dielectric Constant Type Part Number List

(→ 1.6×0.8mm)

| T max.  | Rated Voltage | TC Code            | Cap.    | Tol.               | Part Number        | T max. | Rated Voltage      | TC Code | Cap.   | Tol.   | Part Number        |                    |         |                    |                    |
|---------|---------------|--------------------|---------|--------------------|--------------------|--------|--------------------|---------|--------|--------|--------------------|--------------------|---------|--------------------|--------------------|
| 0.9mm   | 50Vdc         | X7R                | 2200pF  | ±10%               | GCJ188R71H222KA01# | 0.9mm  | 25Vdc              | X8L     | 3900pF | ±10%   | GCJ188L81E393KA01# |                    |         |                    |                    |
|         |               |                    |         | ±20%               | GCJ188R71H222MA01# |        |                    |         |        | ±10%   | GCJ188L81E393MA01# |                    |         |                    |                    |
|         |               |                    | 2700pF  | ±10%               | GCJ188R71H272KA01# |        |                    |         | 5600pF | ±10%   | GCJ188L81E563KA01# |                    |         |                    |                    |
|         |               |                    |         | ±20%               | GCJ188R71H272MA01# |        |                    |         |        | ±20%   | GCJ188L81E563MA01# |                    |         |                    |                    |
|         |               |                    | 3300pF  | ±10%               | GCJ188R71H332KA01# |        |                    |         | 6800pF | ±10%   | GCJ188L81E683KA01# |                    |         |                    |                    |
|         |               |                    |         | ±20%               | GCJ188R71H332MA01# |        |                    |         |        | ±20%   | GCJ188L81E683MA01# |                    |         |                    |                    |
|         |               |                    | 3900pF  | ±10%               | GCJ188R71H392KA01# |        |                    |         | 8200pF | ±10%   | GCJ188L81E823KA01# |                    |         |                    |                    |
|         |               |                    |         | ±20%               | GCJ188R71H392MA01# |        |                    |         |        | ±20%   | GCJ188L81E823MA01# |                    |         |                    |                    |
|         |               |                    | 4700pF  | ±10%               | GCJ188R71H472KA01# |        |                    |         | 0.15μF | ±10%   | GCJ188L81E154KA01# |                    |         |                    |                    |
|         |               |                    |         | ±20%               | GCJ188R71H472MA01# |        |                    |         |        | ±20%   | GCJ188L81E154MA01# |                    |         |                    |                    |
|         |               |                    | 5600pF  | ±10%               | GCJ188R71H562KA01# |        |                    |         | 0.18μF | ±10%   | GCJ188L81E184KA01# |                    |         |                    |                    |
|         |               |                    |         | ±20%               | GCJ188R71H562MA01# |        |                    |         |        | ±20%   | GCJ188L81E184MA01# |                    |         |                    |                    |
|         |               |                    | 6800pF  | ±10%               | GCJ188R71H682KA01# |        |                    |         | 0.22μF | ±10%   | GCJ188L81E224KA01# |                    |         |                    |                    |
|         |               |                    |         | ±20%               | GCJ188R71H682MA01# |        |                    |         |        | ±20%   | GCJ188L81E224MA01# |                    |         |                    |                    |
|         |               |                    | 8200pF  | ±10%               | GCJ188R71H822KA01# |        |                    |         | X8R    | 0.33μF | ±10%               | GCJ188R91E334KA01# |         |                    |                    |
|         |               |                    |         | ±20%               | GCJ188R71H822MA01# |        |                    |         |        |        | ±20%               | GCJ188R91E334MA01# |         |                    |                    |
|         |               |                    | 10000pF | ±10%               | GCJ188R71H103KA01# |        |                    |         | 0.39μF | ±10%   | GCJ188R91E394KA01# |                    |         |                    |                    |
|         |               |                    |         | ±20%               | GCJ188R71H103MA01# |        |                    |         |        | ±20%   | GCJ188R91E394MA01# |                    |         |                    |                    |
|         |               |                    | 12000pF | ±10%               | GCJ188R71H123KA01# |        |                    |         | 0.47μF | ±10%   | GCJ188R91E474KA01# |                    |         |                    |                    |
|         |               |                    |         | ±20%               | GCJ188R71H123MA01# |        |                    |         |        | ±20%   | GCJ188R91E474MA01# |                    |         |                    |                    |
|         |               |                    | 15000pF | ±10%               | GCJ188R71H153KA01# |        |                    |         | X7R    | 1000pF | ±10%               | GCJ188R71E102KA01# |         |                    |                    |
|         |               |                    |         | ±20%               | GCJ188R71H153MA01# |        |                    |         |        |        | ±20%               | GCJ188R71E102MA01# |         |                    |                    |
|         |               |                    | 18000pF | ±10%               | GCJ188R71H183KA01# |        |                    |         |        | 1200pF | ±10%               | GCJ188R71E122KA01# |         |                    |                    |
|         |               |                    |         | ±20%               | GCJ188R71H183MA01# |        |                    |         |        |        | ±20%               | GCJ188R71E122MA01# |         |                    |                    |
|         |               |                    | 22000pF | ±10%               | GCJ188R71H223KA01# |        |                    |         |        | 1500pF | ±10%               | GCJ188R71E152KA01# |         |                    |                    |
|         |               |                    |         | ±20%               | GCJ188R71H223MA01# |        |                    |         |        |        | ±20%               | GCJ188R71E152MA01# |         |                    |                    |
|         |               |                    | 33000pF | ±10%               | GCJ188R71H333KA12# |        |                    |         |        | 1800pF | ±10%               | GCJ188R71E182KA01# |         |                    |                    |
|         |               |                    |         | ±20%               | GCJ188R71H333MA12# |        |                    |         |        |        | ±20%               | GCJ188R71E182MA01# |         |                    |                    |
|         |               |                    | 39000pF | ±10%               | GCJ188R71H393KA12# |        |                    |         |        | 2200pF | ±10%               | GCJ188R71E222KA01# |         |                    |                    |
|         |               |                    |         | ±20%               | GCJ188R71H393MA12# |        |                    |         |        |        | ±20%               | GCJ188R71E222MA01# |         |                    |                    |
|         |               |                    | 47000pF | ±10%               | GCJ188R71H473KA12# |        |                    |         |        | 2700pF | ±10%               | GCJ188R71E272KA01# |         |                    |                    |
|         |               |                    |         | ±20%               | GCJ188R71H473MA12# |        |                    |         |        |        | ±20%               | GCJ188R71E272MA01# |         |                    |                    |
|         |               |                    | 56000pF | ±10%               | GCJ188R71H563KA12# |        |                    |         |        | 3300pF | ±10%               | GCJ188R71E332KA01# |         |                    |                    |
|         |               |                    |         | ±20%               | GCJ188R71H563MA12# |        |                    |         |        |        | ±20%               | GCJ188R71E332MA01# |         |                    |                    |
|         |               |                    | 68000pF | ±10%               | GCJ188R71H683KA12# |        |                    |         |        | 3900pF | ±10%               | GCJ188R71E392KA01# |         |                    |                    |
|         |               |                    |         | ±20%               | GCJ188R71H683MA12# |        |                    |         |        |        | ±20%               | GCJ188R71E392MA01# |         |                    |                    |
|         |               |                    | 82000pF | ±10%               | GCJ188R71H823KA12# |        |                    |         |        | 4700pF | ±10%               | GCJ188R71E472KA01# |         |                    |                    |
|         |               |                    |         | ±20%               | GCJ188R71H823MA12# |        |                    |         |        |        | ±20%               | GCJ188R71E472MA01# |         |                    |                    |
|         |               |                    | 0.10μF  | ±10%               | GCJ188R71H104KA12# |        |                    |         |        | 5600pF | ±10%               | GCJ188R71E562KA01# |         |                    |                    |
|         |               |                    |         | ±20%               | GCJ188R71H104MA12# |        |                    |         |        |        | ±20%               | GCJ188R71E562MA01# |         |                    |                    |
|         |               |                    | 0.15μF  | ±10%               | GCJ188R71H154KA01# |        |                    |         |        | 6800pF | ±10%               | GCJ188R71E682KA01# |         |                    |                    |
|         |               |                    |         | ±20%               | GCJ188R71H154MA01# |        |                    |         |        |        | ±20%               | GCJ188R71E682MA01# |         |                    |                    |
|         |               |                    | 0.22μF  | ±10%               | GCJ188R71H224KA01# |        |                    |         |        | 8200pF | ±10%               | GCJ188R71E822KA01# |         |                    |                    |
|         |               |                    |         | ±20%               | GCJ188R71H224MA01# |        |                    |         |        |        | ±20%               | GCJ188R71E822MA01# |         |                    |                    |
|         |               |                    | 35Vdc   | X8L                | 33000pF            |        |                    |         |        | ±10%   | GCJ188L8YA333KA01# | 10000pF            | ±10%    | GCJ188R71E103KA01# |                    |
|         |               |                    |         |                    |                    |        |                    |         |        | ±20%   | GCJ188L8YA333MA01# |                    | ±20%    | GCJ188R71E103MA01# |                    |
|         |               |                    |         |                    | 39000pF            |        |                    |         |        | ±10%   | GCJ188L8YA393KA01# |                    | 12000pF | ±10%               | GCJ188R71E123KA01# |
|         |               |                    |         |                    |                    |        |                    |         |        | ±20%   | GCJ188L8YA393MA01# |                    |         | ±20%               | GCJ188R71E123MA01# |
| 56000pF | ±10%          | GCJ188L8YA563KA01# | 15000pF | ±10%               | GCJ188R71E153KA01# |        |                    |         |        |        |                    |                    |         |                    |                    |
|         | ±20%          | GCJ188L8YA563MA01# |         | ±20%               | GCJ188R71E153MA01# |        |                    |         |        |        |                    |                    |         |                    |                    |
| 68000pF | ±10%          | GCJ188L8YA683KA01# | 18000pF | ±10%               | GCJ188R71E183KA01# |        |                    |         |        |        |                    |                    |         |                    |                    |
|         | ±20%          | GCJ188L8YA683MA01# |         | ±20%               | GCJ188R71E183MA01# |        |                    |         |        |        |                    |                    |         |                    |                    |
| 25Vdc   | X8L           | 33000pF            | ±10%    | GCJ188L81E333KA01# | 22000pF            | ±10%   | GCJ188R71E223KA01# |         |        |        |                    |                    |         |                    |                    |
|         |               |                    | ±20%    | GCJ188L81E333MA01# |                    | ±20%   | GCJ188R71E223MA01# |         |        |        |                    |                    |         |                    |                    |

GRT Series  
 GCM Series  
 GC3 Series  
 GCJ Series  
 GCQ Series  
 GCD Series  
 GCE Series  
 NMF Series  
 KCM Series  
 KC3 Series  
 KCA Series  
 GCB Series  
 GCG Series  
 ⚠Caution /Notice

Part number # indicates the package specification code.

# GCJ Series High Dielectric Constant Type Part Number List

(→ 1.6×0.8mm)

| T max.  | Rated Voltage | TC Code | Cap.               | Tol.               | Part Number        |                    |
|---------|---------------|---------|--------------------|--------------------|--------------------|--------------------|
| 0.9mm   | 25Vdc         | X7R     | 27000pF            | ±10%               | GCJ188R71E273KA01# |                    |
|         |               |         |                    | ±20%               | GCJ188R71E273MA01# |                    |
|         |               |         | 33000pF            | ±10%               | GCJ188R71E333KA01# |                    |
|         |               |         |                    | ±20%               | GCJ188R71E333MA01# |                    |
|         |               |         | 39000pF            | ±10%               | GCJ188R71E393KA01# |                    |
|         |               |         |                    | ±20%               | GCJ188R71E393MA01# |                    |
|         |               |         | 47000pF            | ±10%               | GCJ188R71E473KA01# |                    |
|         |               |         |                    | ±20%               | GCJ188R71E473MA01# |                    |
|         |               |         | 56000pF            | ±10%               | GCJ188R71E563KA12# |                    |
|         |               |         |                    | ±20%               | GCJ188R71E563MA12# |                    |
|         |               |         | 68000pF            | ±10%               | GCJ188R71E683KA12# |                    |
|         |               |         |                    | ±20%               | GCJ188R71E683MA12# |                    |
|         |               | 82000pF | ±10%               | GCJ188R71E823KA12# |                    |                    |
|         |               |         | ±20%               | GCJ188R71E823MA12# |                    |                    |
|         |               | 0.10μF  | ±10%               | GCJ188R71E104KA12# |                    |                    |
|         |               |         | ±20%               | GCJ188R71E104MA12# |                    |                    |
|         |               | 0.12μF  | ±10%               | GCJ188R71E124KA01# |                    |                    |
|         |               |         | ±20%               | GCJ188R71E124MA01# |                    |                    |
|         |               | 0.15μF  | ±10%               | GCJ188R71E154KA01# |                    |                    |
|         |               |         | ±20%               | GCJ188R71E154MA01# |                    |                    |
|         |               | 0.18μF  | ±10%               | GCJ188R71E184KA12# |                    |                    |
|         |               |         | ±20%               | GCJ188R71E184MA12# |                    |                    |
|         |               | 0.22μF  | ±10%               | GCJ188R71E224KA12# |                    |                    |
|         |               |         | ±20%               | GCJ188R71E224MA12# |                    |                    |
|         | 1.0μF         | ±10%    | GCJ188R71E105KA01# |                    |                    |                    |
|         |               | ±20%    | GCJ188R71E105MA01# |                    |                    |                    |
|         | 16Vdc         | X8L     | 0.22μF             | ±10%               | GCJ188L81C224KA01# |                    |
|         |               |         |                    | ±20%               | GCJ188L81C224MA01# |                    |
|         |               |         | X7R                | 27000pF            | ±10%               | GCJ188R71C273KA01# |
|         |               |         |                    |                    | ±20%               | GCJ188R71C273MA01# |
|         |               |         |                    | 33000pF            | ±10%               | GCJ188R71C333KA01# |
|         |               |         |                    |                    | ±20%               | GCJ188R71C333MA01# |
|         |               |         |                    | 39000pF            | ±10%               | GCJ188R71C393KA01# |
|         |               |         |                    |                    | ±20%               | GCJ188R71C393MA01# |
|         |               |         |                    | 47000pF            | ±10%               | GCJ188R71C473KA01# |
|         |               |         |                    |                    | ±20%               | GCJ188R71C473MA01# |
| 56000pF |               |         |                    | ±10%               | GCJ188R71C563KA01# |                    |
|         |               |         |                    | ±20%               | GCJ188R71C563MA01# |                    |
| 68000pF |               | ±10%    |                    | GCJ188R71C683KA01# |                    |                    |
|         |               | ±20%    |                    | GCJ188R71C683MA01# |                    |                    |
| 82000pF |               | ±10%    | GCJ188R71C823KA01# |                    |                    |                    |
|         |               | ±20%    | GCJ188R71C823MA01# |                    |                    |                    |
| 0.10μF  |               | ±10%    | GCJ188R71C104KA01# |                    |                    |                    |
|         |               | ±20%    | GCJ188R71C104MA01# |                    |                    |                    |
| 0.12μF  |               | ±10%    | GCJ188R71C124KA01# |                    |                    |                    |
|         |               | ±20%    | GCJ188R71C124MA01# |                    |                    |                    |
| 0.15μF  |               | ±10%    | GCJ188R71C154KA01# |                    |                    |                    |
|         |               | ±20%    | GCJ188R71C154MA01# |                    |                    |                    |
| 0.18μF  |               | ±10%    | GCJ188R71C184KA01# |                    |                    |                    |
|         |               | ±20%    | GCJ188R71C184MA01# |                    |                    |                    |
| 0.22μF  |               | ±10%    | GCJ188R71C224KA01# |                    |                    |                    |
|         |               | ±20%    | GCJ188R71C224MA01# |                    |                    |                    |
| 0.27μF  |               | ±10%    | GCJ188R71C274KA01# |                    |                    |                    |
|         |               | ±20%    | GCJ188R71C274MA01# |                    |                    |                    |

| T max. | Rated Voltage | TC Code | Cap.   | Tol.               | Part Number                  |                              |
|--------|---------------|---------|--------|--------------------|------------------------------|------------------------------|
| 0.9mm  | 16Vdc         | X7R     | 0.33μF | ±10%               | GCJ188R71C334KA01#           |                              |
|        |               |         |        | ±20%               | GCJ188R71C334MA01#           |                              |
|        |               |         | 0.39μF | ±10%               | GCJ188R71C394KA12#           |                              |
|        |               |         |        | ±20%               | GCJ188R71C394MA12#           |                              |
|        |               |         | 0.47μF | ±10%               | GCJ188R71C474KA12#           |                              |
|        |               |         |        | ±20%               | GCJ188R71C474MA12#           |                              |
|        | 10Vdc         | X7R     | 0.22μF | ±10%               | GCJ188R71A224KA01#           |                              |
|        |               |         |        | ±20%               | GCJ188R71A224MA01#           |                              |
|        | 6.3Vdc        | X7R     | 2.2μF  | ±10%               | GCJ188R70J225KE01#           |                              |
|        |               |         |        | ±20%               | GCJ188R70J225ME01#           |                              |
|        | 1.0mm         | 6.3Vdc  | X8L    | 3.3μF              | ±10%                         | GCJ188L8EC335KE08# <b>D4</b> |
|        |               |         |        |                    | ±20%                         | GCJ188M8EC475KE08# <b>D4</b> |
| X8M    |               |         | 4.7μF  | ±10%               | GCJ188M8EC475KE08# <b>D4</b> |                              |
|        |               |         |        | ±20%               | GCJ188C70J335KE02#           |                              |
| X7S    |               | 3.3μF   | ±10%   | GCJ188C70J335KE02# |                              |                              |
|        |               |         | ±20%   | GCJ188C70J335ME02# |                              |                              |
|        |               | 4.7μF   | ±10%   | GCJ188C70J475KE02# |                              |                              |
|        |               |         | ±20%   | GCJ188C70J475ME02# |                              |                              |

## 2.0×1.25mm

| T max.  | Rated Voltage | TC Code            | Cap.               | Tol.   | Part Number        |                    |                    |
|---------|---------------|--------------------|--------------------|--------|--------------------|--------------------|--------------------|
| 0.95mm  | 100Vdc        | X7R                | 27000pF            | ±10%   | GCJ219R72A273KA01# |                    |                    |
|         |               |                    |                    | ±20%   | GCJ219R72A273MA01# |                    |                    |
|         |               |                    | 33000pF            | ±10%   | GCJ219R72A333KA01# |                    |                    |
|         |               |                    |                    | ±20%   | GCJ219R72A333MA01# |                    |                    |
|         |               |                    | 39000pF            | ±10%   | GCJ219R72A393KA01# |                    |                    |
|         |               |                    |                    | ±20%   | GCJ219R72A393MA01# |                    |                    |
|         |               |                    | 50Vdc              | X7R    | 0.33μF             | ±10%               | GCJ219R71H334KA12# |
|         |               |                    |                    |        |                    | ±20%               | GCJ219R71H334MA12# |
|         |               |                    | 25Vdc              | X7R    | 0.33μF             | ±10%               | GCJ219R71E334KA01# |
|         |               |                    |                    |        |                    | ±20%               | GCJ219R71E334MA01# |
|         |               |                    |                    |        | 0.47μF             | ±10%               | GCJ219R71E474KA12# |
|         |               |                    |                    |        |                    | ±20%               | GCJ219R71E474MA12# |
|         | 16Vdc         | X7R                |                    |        | 0.68μF             | ±10%               | GCJ219R71C684KA01# |
|         |               |                    |                    |        |                    | ±20%               | GCJ219R71C684MA01# |
|         | 0.82μF        | ±10%               | GCJ219R71C824KA01# |        |                    |                    |                    |
|         |               | ±20%               | GCJ219R71C824MA01# |        |                    |                    |                    |
|         | 1.0μF         | ±10%               | GCJ219R71C105KA01# |        |                    |                    |                    |
|         |               | ±20%               | GCJ219R71C105MA01# |        |                    |                    |                    |
|         | 1.0mm         | 250Vdc             | X7R                | 1000pF | ±10%               | GCJ21AR72E102KXJ1# |                    |
|         |               |                    |                    |        | ±20%               | GCJ21AR72E152KXJ1# |                    |
|         |               |                    |                    | 1500pF | ±10%               | GCJ21AR72E152KXJ1# |                    |
|         |               |                    |                    |        | ±20%               | GCJ21AR72E222KXJ1# |                    |
|         |               |                    |                    | 2200pF | ±10%               | GCJ21AR72E222KXJ1# |                    |
|         |               |                    |                    |        | ±20%               | GCJ21AR72E332KXJ1# |                    |
| 3300pF  |               |                    |                    | ±10%   | GCJ21AR72E332KXJ1# |                    |                    |
|         |               |                    |                    | ±20%   | GCJ21AR72E472KXJ1# |                    |                    |
| 4700pF  | ±10%          | GCJ21AR72E472KXJ1# |                    |        |                    |                    |                    |
|         | ±20%          | GCJ21AR72E682KXJ1# |                    |        |                    |                    |                    |
| 1.45mm  | 250Vdc        | X7R                | 10000pF            | ±10%   | GCJ21BR72E103KXJ3# |                    |                    |
|         |               |                    |                    | ±20%   | GCJ21BR72E153KXJ3# |                    |                    |
|         |               |                    | 15000pF            | ±10%   | GCJ21BR72E153KXJ3# |                    |                    |
|         |               |                    |                    | ±20%   | GCJ21BR72E223KXJ3# |                    |                    |
|         | 100Vdc        | X7R                | 27000pF            | ±10%   | GCJ21BR72A273KA01# |                    |                    |
|         |               |                    |                    | ±20%   | GCJ21BR72A273MA01# |                    |                    |
|         |               |                    | 33000pF            | ±10%   | GCJ21BR72A333KA01# |                    |                    |
|         |               |                    |                    | ±20%   | GCJ21BR72A333MA01# |                    |                    |
| 39000pF | ±10%          | GCJ21BR72A393KA01# |                    |        |                    |                    |                    |
|         | ±20%          | GCJ21BR72A393MA01# |                    |        |                    |                    |                    |

Part number # indicates the package specification code.

GRT Series  
 GCM Series  
 GC3 Series  
 GCJ Series  
 GCQ Series  
 GCD Series  
 GCE Series  
 NMF Series  
 KCM Series  
 KC3 Series  
 KCA Series  
 GCB Series  
 GCG Series  
 ⚠Caution / Notice

# GCJ Series High Dielectric Constant Type Part Number List

(→ 2.0×1.25mm)

| T max. | Rated Voltage | TC Code            | Cap.               | Tol.               | Part Number        |                    | T max. | Rated Voltage      | TC Code            | Cap.               | Tol.               | Part Number        |                    |                    |                    |                    |                    |  |
|--------|---------------|--------------------|--------------------|--------------------|--------------------|--------------------|--------|--------------------|--------------------|--------------------|--------------------|--------------------|--------------------|--------------------|--------------------|--------------------|--------------------|--|
| 1.45mm | 100Vdc        | X7R                | 47000pF            | ±10%               | GCJ21BR72A473KA01# |                    | 1.45mm | 25Vdc              | X8L                | 0.82μF             | ±20%               | GCJ21BR72A473MA01# |                    |                    |                    |                    |                    |  |
|        |               |                    |                    | ±20%               | GCJ21BR72A473MA01# |                    |        |                    |                    |                    | 1.0μF              | ±10%               | GCJ21BL81E105KA01# |                    |                    |                    |                    |  |
|        |               |                    |                    | 56000pF            | ±10%               | GCJ21BR72A563KA01# |        |                    |                    |                    |                    |                    | ±20%               | GCJ21BL81E105MA01# |                    |                    |                    |  |
|        |               |                    |                    |                    | 68000pF            | ±10%               |        |                    |                    |                    |                    | GCJ21BR72A563MA01# |                    | X7R                | 0.27μF             | ±10%               | GCJ21BR71E274KA01# |  |
|        |               |                    | ±20%               |                    |                    | GCJ21BR72A683KA01# |        |                    |                    |                    |                    | ±20%               | GCJ21BR71E274MA01# |                    |                    |                    |                    |  |
|        |               |                    | 82000pF            |                    |                    | ±10%               |        |                    |                    | GCJ21BR72A683MA01# |                    | 0.33μF             | ±10%               |                    |                    | GCJ21BR71E334KA01# |                    |  |
|        |               |                    |                    | ±20%               |                    | GCJ21BR72A823KA01# |        |                    |                    |                    | ±20%               |                    | GCJ21BR71E334MA01# |                    |                    |                    |                    |  |
|        |               |                    |                    | 0.10μF             | ±10%               | GCJ21BR72A823MA01# |        |                    |                    |                    | 0.39μF             |                    | ±10%               |                    | GCJ21BR71E394KA01# |                    |                    |  |
|        |               |                    |                    |                    | ±20%               | GCJ21BR72A104KA01# |        |                    |                    |                    |                    |                    | ±20%               |                    | GCJ21BR71E394MA01# |                    |                    |  |
|        |               |                    | 50Vdc              |                    | X8L                | 82000pF            |        |                    |                    | ±10%               |                    | GCJ21BR72A104MA01# |                    |                    | 0.47μF             | ±10%               | GCJ21BR71E474KA01# |  |
|        |               |                    |                    |                    |                    |                    |        |                    |                    | ±20%               |                    | GCJ21BR72A104MA01# |                    |                    |                    | ±20%               | GCJ21BR71E474MA01# |  |
|        |               |                    |                    | 0.10μF             |                    |                    |        |                    |                    | ±10%               | GCJ21BL81H823KA01# |                    | 0.56μF             |                    |                    | ±10%               | GCJ21BR71E564KA12# |  |
|        |               |                    |                    |                    |                    |                    |        |                    |                    | ±20%               | GCJ21BL81H823MA01# |                    |                    |                    |                    | ±20%               | GCJ21BR71E564MA12# |  |
|        |               |                    | 0.10μF             |                    | ±10%               | GCJ21BL81H104KA01# |        |                    |                    |                    | 0.68μF             | ±10%               |                    |                    | GCJ21BR71E684KA12# |                    |                    |  |
|        |               |                    |                    |                    | ±20%               | GCJ21BL81H104MA01# |        |                    |                    |                    |                    | ±20%               |                    |                    | GCJ21BR71E684MA12# |                    |                    |  |
|        |               |                    |                    | 0.47μF             | ±10%               | GCJ21BL81H104MA01# |        |                    |                    |                    |                    | 0.82μF             | ±10%               |                    | GCJ21BR71E824KA12# |                    |                    |  |
|        |               |                    |                    |                    | ±20%               | GCJ21BL8EH474KA07# |        |                    |                    | <b>D4</b>          |                    |                    | ±20%               |                    | GCJ21BR71E824MA12# |                    |                    |  |
|        |               |                    | 35Vdc              |                    | X7R                | 0.22μF             |        |                    |                    | ±10%               | GCJ21BR71H224KA01# |                    |                    |                    | 1.0μF              | ±10%               | GCJ21BR71E105KA12# |  |
|        |               |                    |                    |                    |                    |                    |        |                    |                    | ±20%               | GCJ21BR71H224MA01# |                    |                    |                    |                    | ±20%               | GCJ21BR71E105MA12# |  |
|        |               |                    |                    | 0.33μF             |                    |                    |        |                    |                    | ±10%               | GCJ21BR71H334KA12# |                    | 1.5μF              |                    |                    | ±10%               | GCJ21BR71E155KA01# |  |
|        |               |                    |                    |                    |                    |                    |        |                    |                    | ±20%               | GCJ21BR71H334MA12# |                    |                    |                    |                    | ±20%               | GCJ21BR71E155MA01# |  |
|        |               |                    | 0.47μF             |                    | ±10%               | GCJ21BR71H474KA12# |        |                    |                    |                    | 2.2μF              | ±10%               |                    |                    | GCJ21BR71E225KA01# |                    |                    |  |
|        |               |                    |                    |                    | ±20%               | GCJ21BR71H474MA12# |        |                    |                    |                    |                    | ±20%               |                    |                    | GCJ21BR71E225MA01# |                    |                    |  |
|        |               |                    |                    | 1.0μF              | ±10%               | GCJ21BR71H105KA01# |        |                    |                    |                    |                    | 16Vdc              | X8L                |                    | 0.56μF             | ±10%               | GCJ21BR71H105MA01# |  |
|        | ±20%          | GCJ21BR71H105MA01# |                    |                    |                    | 0.68μF             |        | ±10%               | GCJ21BL81C564KA01# |                    |                    |                    |                    |                    |                    |                    |                    |  |
|        | 0.12μF        | ±10%               | GCJ21BL8YA124KA01# |                    |                    |                    |        | ±20%               | GCJ21BL81C564MA01# |                    |                    |                    |                    |                    |                    |                    |                    |  |
|        |               | ±20%               | GCJ21BL8YA124MA01# |                    |                    |                    |        | 0.82μF             | ±10%               | GCJ21BL81C684KA01# |                    |                    |                    |                    |                    |                    |                    |  |
|        |               | 0.15μF             | ±10%               | GCJ21BL8YA154KA01# |                    |                    |        |                    | ±20%               | GCJ21BL81C684MA01# |                    |                    |                    |                    |                    |                    |                    |  |
|        |               |                    | ±20%               | GCJ21BL8YA154MA01# |                    | 1.0μF              |        |                    | ±10%               | GCJ21BL81C824KA01# |                    |                    |                    |                    |                    |                    |                    |  |
|        | 0.18μF        |                    | ±10%               | GCJ21BL8YA184KA01# |                    |                    |        |                    | ±20%               | GCJ21BL81C824MA01# |                    |                    |                    |                    |                    |                    |                    |  |
|        |               |                    | ±20%               | GCJ21BL8YA184MA01# |                    |                    |        | 0.27μF             | ±10%               | GCJ21BL81C105KA01# |                    |                    |                    |                    |                    |                    |                    |  |
|        |               | 0.22μF             | ±10%               | GCJ21BL8YA224KA01# |                    |                    |        |                    | ±20%               | GCJ21BL81C105MA01# |                    |                    |                    |                    |                    |                    |                    |  |
|        |               |                    | ±20%               | GCJ21BL8YA224MA01# |                    | X7R                |        |                    | 0.27μF             | ±10%               | GCJ21BR71C274KA01# |                    |                    |                    |                    |                    |                    |  |
|        | 0.33μF        |                    | ±10%               | GCJ21BL8YA334KA01# |                    |                    |        |                    |                    | ±20%               | GCJ21BR71C274MA01# |                    |                    |                    |                    |                    |                    |  |
|        |               |                    | ±20%               | GCJ21BL8YA334MA01# |                    |                    |        | 0.33μF             |                    | ±10%               | GCJ21BR71C334KA01# |                    |                    |                    |                    |                    |                    |  |
|        |               | 0.47μF             | ±10%               | GCJ21BL8YA474KA01# |                    |                    |        |                    |                    | ±20%               | GCJ21BR71C334MA01# |                    |                    |                    |                    |                    |                    |  |
|        |               |                    | ±20%               | GCJ21BL8YA474MA01# |                    | 0.39μF             |        |                    | ±10%               | GCJ21BR71C394KA01# |                    |                    |                    |                    |                    |                    |                    |  |
|        | 25Vdc         |                    | X8L                | 0.12μF             | ±10%               |                    |        |                    | GCJ21BL81E124KA01# |                    | ±20%               |                    | GCJ21BR71C394MA01# |                    |                    |                    |                    |  |
|        |               |                    |                    |                    | ±20%               |                    |        | GCJ21BL81E124MA01# |                    | 0.47μF             | ±10%               |                    | GCJ21BR71C474KA01# |                    |                    |                    |                    |  |
|        |               | 0.15μF             |                    |                    | ±10%               |                    |        | GCJ21BL81E154KA01# |                    |                    | ±20%               |                    | GCJ21BR71C474MA01# |                    |                    |                    |                    |  |
|        |               |                    |                    |                    | ±20%               | GCJ21BL81E154MA01# |        |                    | 0.56μF             |                    | ±10%               |                    | GCJ21BR71C564KA01# |                    |                    |                    |                    |  |
|        |               |                    |                    | 0.18μF             | ±10%               | GCJ21BL81E184KA01# |        |                    |                    |                    | ±20%               |                    | GCJ21BR71C564MA01# |                    |                    |                    |                    |  |
|        |               |                    |                    |                    | ±20%               | GCJ21BL81E184MA01# |        |                    |                    | 0.68μF             | ±10%               |                    | GCJ21BR71C684KA01# |                    |                    |                    |                    |  |
|        |               | 0.22μF             |                    |                    | ±10%               | GCJ21BL81E224KA01# |        |                    |                    |                    | ±20%               |                    | GCJ21BR71C684MA01# |                    |                    |                    |                    |  |
|        |               |                    |                    |                    | ±20%               | GCJ21BL81E224MA01# |        |                    | 0.82μF             |                    | ±10%               |                    | GCJ21BR71C824KA01# |                    |                    |                    |                    |  |
|        |               |                    |                    | 0.27μF             | ±10%               | GCJ21BL81E274KA01# |        |                    |                    |                    | ±20%               |                    | GCJ21BR71C824MA01# |                    |                    |                    |                    |  |
|        |               |                    |                    |                    | ±20%               | GCJ21BL81E274MA01# |        |                    |                    | 1.0μF              | ±10%               |                    | GCJ21BR71C105KA01# |                    |                    |                    |                    |  |
|        |               | 0.33μF             |                    |                    | ±10%               | GCJ21BL81E334KA01# |        |                    |                    |                    | ±20%               | GCJ21BR71C105MA01# |                    |                    |                    |                    |                    |  |
| ±20%   |               |                    |                    |                    | GCJ21BL81E334MA01# |                    | 1.5μF  | ±10%               | GCJ21BR71C155KA01# |                    |                    |                    |                    |                    |                    |                    |                    |  |
| 0.39μF |               |                    |                    | ±10%               | GCJ21BL81E394KA01# |                    |        | ±20%               | GCJ21BR71C155MA01# |                    |                    |                    |                    |                    |                    |                    |                    |  |
|        |               |                    |                    | ±20%               | GCJ21BL81E394MA01# |                    |        | 2.2μF              | ±10%               | GCJ21BR71C225KA13# |                    |                    |                    |                    |                    |                    |                    |  |
|        |               | 0.47μF             |                    | ±10%               | GCJ21BL81E474KA01# |                    |        |                    | ±20%               | GCJ21BR71C225MA13# |                    |                    |                    |                    |                    |                    |                    |  |
|        |               |                    |                    | ±20%               | GCJ21BL81E474MA01# |                    | 4.7μF  |                    | ±10%               | GCJ21BR71C475KA01# |                    |                    |                    |                    |                    |                    |                    |  |
| 0.68μF |               |                    |                    | ±10%               | GCJ21BL81E684KA01# |                    |        |                    | ±20%               | GCJ21BR71C475MA01# |                    |                    |                    |                    |                    |                    |                    |  |
|        |               |                    |                    | ±20%               | GCJ21BL81E684MA01# |                    |        | 10Vdc              | X7R                | 2.2μF              | ±10%               | GCJ21BR71A225KA01# |                    |                    |                    |                    |                    |  |
|        |               | ±20%               |                    | GCJ21BL81E824KA01# |                    |                    |        |                    |                    |                    |                    |                    |                    |                    |                    |                    |                    |  |

Part number # indicates the package specification code.

GRT Series  
 GCM Series  
 GC3 Series  
 GCJ Series  
 GCQ Series  
 GCD Series  
 GCE Series  
 NMF Series  
 KCM Series  
 KC3 Series  
 KCA Series  
 GCB Series  
 GCG Series  
 ⚠Caution / Notice



# GCJ Series High Dielectric Constant Type Part Number List

(→ 2.0×1.25mm)

| T max. | Rated Voltage | TC Code | Cap.  | Tol. | Part Number        |
|--------|---------------|---------|-------|------|--------------------|
| 1.45mm | 10Vdc         | X7R     | 2.2μF | ±20% | GCJ21BR71A225MA01# |
|        |               |         | 10μF  | ±10% | GCJ21BR71A106KE01# |
|        |               |         |       | ±20% | GCJ21BR71A106ME01# |
| 1.5mm  | 100Vdc        | X7S     | 1.0μF | ±10% | GCJ21BC72A105KE02# |
|        |               |         |       | ±20% | GCJ21BC72A105ME02# |

## 3.2×1.6mm

| T max. | Rated Voltage      | TC Code            | Cap.               | Tol.               | Part Number        |        |                    |                    |
|--------|--------------------|--------------------|--------------------|--------------------|--------------------|--------|--------------------|--------------------|
| 1.25mm | 1000Vdc            | X7R                | 1000pF             | ±10%               | GCJ31BR73A102KXJ1# |        |                    |                    |
|        |                    |                    | 1500pF             | ±10%               | GCJ31BR73A152KXJ1# |        |                    |                    |
|        |                    |                    | 2200pF             | ±10%               | GCJ31BR73A222KXJ1# |        |                    |                    |
|        |                    |                    | 3300pF             | ±10%               | GCJ31BR73A332KXJ1# |        |                    |                    |
|        |                    |                    | 4700pF             | ±10%               | GCJ31BR73A472KXJ1# |        |                    |                    |
|        | 630Vdc             | X7R                | 1000pF             | ±10%               | GCJ31BR72J102KXJ1# |        |                    |                    |
|        |                    |                    | 1500pF             | ±10%               | GCJ31BR72J152KXJ1# |        |                    |                    |
|        |                    |                    | 2200pF             | ±10%               | GCJ31BR72J222KXJ1# |        |                    |                    |
|        |                    |                    | 3300pF             | ±10%               | GCJ31BR72J332KXJ1# |        |                    |                    |
|        |                    |                    | 4700pF             | ±10%               | GCJ31BR72J472KXJ1# |        |                    |                    |
|        | 250Vdc             | X7R                | 15000pF            | ±10%               | GCJ31BR72E153KXJ1# |        |                    |                    |
|        |                    |                    | 22000pF            | ±10%               | GCJ31BR72E223KXJ1# |        |                    |                    |
|        |                    |                    | 68000pF            | ±10%               | GCJ31BR72E683KXJ1# |        |                    |                    |
|        |                    |                    | 1.35mm             | 100Vdc             | X7R                | 0.15μF | ±10%               | GCJ31MR72A154KA01# |
|        |                    |                    |                    |                    |                    | ±20%   | GCJ31MR72A154MA01# |                    |
| 0.18μF | ±10%               | GCJ31MR72A184KA01# |                    |                    |                    |        |                    |                    |
|        | ±20%               | GCJ31MR72A184MA01# |                    |                    |                    |        |                    |                    |
| 0.22μF | ±10%               | GCJ31MR72A224KA01# |                    |                    |                    |        |                    |                    |
|        | ±20%               | GCJ31MR72A224MA01# |                    |                    |                    |        |                    |                    |
| 50Vdc  | X7R                | 0.47μF             |                    | ±10%               | GCJ31MR71H474KA01# |        |                    |                    |
|        |                    | ±20%               |                    | GCJ31MR71H474MA01# |                    |        |                    |                    |
|        |                    | 0.56μF             |                    | ±10%               | GCJ31MR71H564KA12# |        |                    |                    |
|        |                    |                    |                    | ±20%               | GCJ31MR71H564MA12# |        |                    |                    |
|        |                    | 0.68μF             | ±10%               | GCJ31MR71H684KA12# |                    |        |                    |                    |
| ±20%   | GCJ31MR71H684MA12# |                    |                    |                    |                    |        |                    |                    |
| 0.82μF | ±10%               | GCJ31MR71H824KA12# |                    |                    |                    |        |                    |                    |
|        | ±20%               | GCJ31MR71H824MA12# |                    |                    |                    |        |                    |                    |
| 1.0μF  | ±10%               | GCJ31MR71H105KA12# |                    |                    |                    |        |                    |                    |
|        | ±20%               | GCJ31MR71H105MA12# |                    |                    |                    |        |                    |                    |
| 35Vdc  | X8L                | 0.47μF             | ±10%               | GCJ31ML8YA474KA01# |                    |        |                    |                    |
|        |                    | ±20%               | GCJ31ML8YA474MA01# |                    |                    |        |                    |                    |
| 25Vdc  | X7R                | 2.2μF              | ±10%               | GCJ31MR71E225KA12# |                    |        |                    |                    |
|        |                    |                    | ±20%               | GCJ31MR71E225MA12# |                    |        |                    |                    |
|        |                    | 3.3μF              | ±10%               | GCJ31MR71E335KA12# |                    |        |                    |                    |
| ±20%   | GCJ31MR71E335MA12# |                    |                    |                    |                    |        |                    |                    |
| 16Vdc  | X8L                | 1.5μF              | ±10%               | GCJ31ML81C155KA01# |                    |        |                    |                    |
|        |                    |                    | ±20%               | GCJ31ML81C155MA01# |                    |        |                    |                    |
|        | 2.2μF              | ±10%               | GCJ31ML81C225KA01# |                    |                    |        |                    |                    |
|        |                    | ±20%               | GCJ31ML81C225MA01# |                    |                    |        |                    |                    |
| X7R    | 2.2μF              | ±10%               | GCJ31MR71C225KA01# |                    |                    |        |                    |                    |
|        |                    | ±20%               | GCJ31MR71C225MA01# |                    |                    |        |                    |                    |
| 1.8mm  | 1000Vdc            | X7R                | 6800pF             | ±10%               | GCJ31CR73A682KXJ3# |        |                    |                    |

| T max. | Rated Voltage | TC Code            | Cap.               | Tol.               | Part Number        |
|--------|---------------|--------------------|--------------------|--------------------|--------------------|
| 1.8mm  | 1000Vdc       | X7R                | 10000pF            | ±10%               | GCJ31CR73A103KXJ3# |
|        |               |                    | 15000pF            | ±10%               | GCJ31CR72J153KXJ3# |
|        | 630Vdc        | X7R                | 22000pF            | ±10%               | GCJ31CR72J223KXJ3# |
|        |               |                    | 33000pF            | ±10%               | GCJ31CR72E333KXJ3# |
|        | 250Vdc        | X7R                | 47000pF            | ±10%               | GCJ31CR72E473KXJ3# |
|        |               |                    | 0.10μF             | ±10%               | GCJ31CR72E104KXJ3# |
| 1.9mm  | 100Vdc        | X8L                | 1.0μF              | ±10%               | GCJ31CL8EL105KA07# |
|        |               |                    | <b>D4</b>          |                    |                    |
|        |               | X7R                | 1.0μF              | ±10%               | GCJ31CR72A105KA01# |
|        | ±20%          |                    | GCJ31CR72A105MA01# |                    |                    |
|        | X7S           | 2.2μF              | ±10%               | GCJ31CC72A225KE01# |                    |
|        |               |                    | ±20%               | GCJ31CC72A225ME01# |                    |
|        | 50Vdc         | X7R                | 0.56μF             | ±10%               | GCJ31CR71H564KA01# |
|        |               |                    | ±20%               | GCJ31CR71H564MA01# |                    |
|        |               |                    | 0.68μF             | ±10%               | GCJ31CR71H684KA01# |
|        |               |                    |                    | ±20%               | GCJ31CR71H684MA01# |
|        |               |                    | 0.82μF             | ±10%               | GCJ31CR71H824KA12# |
|        |               | ±20%               |                    | GCJ31CR71H824MA12# |                    |
|        |               | 1.0μF              | ±10%               | GCJ31CR71H105KA12# |                    |
|        |               |                    | ±20%               | GCJ31CR71H105MA12# |                    |
|        |               | 1.5μF              | ±10%               | GCJ31CR71H155KA12# |                    |
| ±20%   |               |                    | GCJ31CR71H155MA12# |                    |                    |
| 2.2μF  | ±10%          | GCJ31CR71H225KA12# |                    |                    |                    |
|        | ±20%          | GCJ31CR71H225MA12# |                    |                    |                    |
| X7S    | 4.7μF         | ±10%               | GCJ31CC71H475KA01# |                    |                    |
|        |               | ±20%               | GCJ31CC71H475MA01# |                    |                    |
| 35Vdc  | X8L           | 0.56μF             | ±10%               | GCJ31CL8YA564KA01# |                    |
|        |               | ±20%               | GCJ31CL8YA564MA01# |                    |                    |
|        |               | 0.68μF             | ±10%               | GCJ31CL8YA684KA01# |                    |
|        |               |                    | ±20%               | GCJ31CL8YA684MA01# |                    |
|        |               | 0.82μF             | ±10%               | GCJ31CL8YA824KA01# |                    |
|        | ±20%          |                    | GCJ31CL8YA824MA01# |                    |                    |
|        | 1.0μF         | ±10%               | GCJ31CL8YA105KA01# |                    |                    |
|        |               | ±20%               | GCJ31CL8YA105MA01# |                    |                    |
|        | 25Vdc         | X7R                | 4.7μF              | ±10%               | GCJ31CR71E475KA12# |
|        |               |                    | ±20%               | GCJ31CR71E475MA12# |                    |
| 16Vdc  | X8L           | 3.3μF              | ±10%               | GCJ31CL81C335KA01# |                    |
|        |               |                    | ±20%               | GCJ31CL81C335MA01# |                    |
|        |               | 4.7μF              | ±10%               | GCJ31CL81C475KA01# |                    |
|        |               |                    | ±20%               | GCJ31CL81C475MA01# |                    |
|        | X7R           | 3.3μF              | ±10%               | GCJ31CR71C335KA01# |                    |
|        |               |                    | ±20%               | GCJ31CR71C335MA01# |                    |
|        |               | 4.7μF              | ±10%               | GCJ31CR71C475KA01# |                    |
|        |               |                    | ±20%               | GCJ31CR71C475MA01# |                    |
| 10Vdc  | X8L           | 22μF               | ±10%               | GCJ31CL8ED226KE07# |                    |
|        |               |                    | <b>D4</b>          |                    |                    |
| X7R    | 6.8μF         | ±10%               | GCJ31CR71A685KA13# |                    |                    |
|        |               | ±20%               | GCJ31CR71A685MA13# |                    |                    |
|        | 10μF          | ±10%               | GCJ31CR71A106KA13# |                    |                    |
|        |               | ±20%               | GCJ31CR71A106MA13# |                    |                    |
| 22μF   | ±10%          | GCJ31CR71A226KE01# |                    |                    |                    |
|        | ±20%          | GCJ31CR71A226ME01# |                    |                    |                    |
| 6.3Vdc | X7R           | 22μF               | ±10%               | GCJ31CR70J226KE01# |                    |
|        |               |                    | ±20%               | GCJ31CR70J226ME01# |                    |
| 2.0mm  | 35Vdc         | X7T                | 10μF               | ±10%               | GCJ31CD7YA106KE02# |

Part number # indicates the package specification code.

# GCJ Series High Dielectric Constant Type Part Number List

(→ 3.2×1.6mm)

| T max. | Rated Voltage | TC Code | Cap. | Tol. | Part Number        |           |
|--------|---------------|---------|------|------|--------------------|-----------|
| 2.0mm  | 25Vdc         | X8L     | 10µF | ±10% | GCJ31CL8EF106KA08# | <b>D4</b> |
|        |               | X7S     | 10µF | ±10% | GCJ31CC71E106KA15# |           |
|        |               |         |      | ±20% | GCJ31CC71E106MA15# |           |

| T max. | Rated Voltage | TC Code | Cap.   | Tol. | Part Number        |  |
|--------|---------------|---------|--------|------|--------------------|--|
| 2.0mm  | 630Vdc        | X7R     | 0.10µF | ±10% | GCJ43DR72J104KXJ1# |  |
|        | 250Vdc        | X7R     | 0.22µF | ±10% | GCJ43DR72E224KXJ1# |  |
|        |               |         | 0.33µF | ±10% | GCJ43DR72E334KXJ1# |  |
|        |               |         | 0.47µF | ±10% | GCJ43DR72E474KXJ1# |  |

3.2×2.5mm

| T max. | Rated Voltage | TC Code | Cap.               | Tol.               | Part Number        |                    |           |
|--------|---------------|---------|--------------------|--------------------|--------------------|--------------------|-----------|
| 1.5mm  | 630Vdc        | X7R     | 6800pF             | ±10%               | GCJ32QR72J682KXJ1# |                    |           |
|        |               |         | 10000pF            | ±10%               | GCJ32QR72J103KXJ1# |                    |           |
|        | 250Vdc        | X7R     | 68000pF            | ±10%               | GCJ32QR72E683KXJ1# |                    |           |
|        |               |         | 0.15µF             | ±10%               | GCJ32QR72E154KXJ1# |                    |           |
| 2.0mm  | 1000Vdc       | X7R     | 15000pF            | ±10%               | GCJ32DR73A153KXJ1# |                    |           |
|        |               |         | 22000pF            | ±10%               | GCJ32DR73A223KXJ1# |                    |           |
|        | 630Vdc        | X7R     | 15000pF            | ±10%               | GCJ32DR72J153KXJ1# |                    |           |
|        |               |         | 22000pF            | ±10%               | GCJ32DR72J223KXJ1# |                    |           |
|        |               |         | 33000pF            | ±10%               | GCJ32DR72J333KXJ1# |                    |           |
|        |               |         | 47000pF            | ±10%               | GCJ32DR72J473KXJ1# |                    |           |
|        | 250Vdc        | X7R     | 0.10µF             | ±10%               | GCJ32DR72E104KXJ1# |                    |           |
|        |               |         | 0.22µF             | ±10%               | GCJ32DR72E224KXJ1# |                    |           |
|        | 2.3mm         | 100Vdc  | X8L                | 2.2µF              | ±10%               | GCJ32DL8EL225KA07# | <b>D4</b> |
|        |               |         |                    | X7R                | 2.2µF              | ±10%               |           |
|        |               |         | ±20%               |                    | GCJ32DR72A225MA01# |                    |           |
| X7S    |               |         | 4.7µF              | ±10%               | GCJ32DC72A475KE01# |                    |           |
|        |               |         |                    | ±20%               | GCJ32DC72A475ME01# |                    |           |
| 2.8mm  |               |         | 50Vdc              | X7R                | 4.7µF              | ±10%               |           |
|        |               | ±20%    |                    |                    | GCJ32ER71H475MA12# |                    |           |
|        | X7S           | 10µF    |                    |                    | ±10%               | GCJ32EC71H106KA01# |           |
|        |               |         |                    | ±20%               | GCJ32EC71H106MA01# |                    |           |
|        | 25Vdc         | X8L     |                    | 4.7µF              | ±10%               | GCJ32EL81E475KA01# |           |
|        |               |         |                    |                    | ±20%               | GCJ32EL81E475MA01# |           |
|        |               | X7R     | 10µF               | ±10%               | GCJ32ER71E106KA18# |                    |           |
|        |               |         |                    | ±20%               | GCJ32ER71E106MA18# |                    |           |
|        | 16Vdc         | X8R     | 6.8µF              | ±10%               | GCJ32ER91C685KE01# |                    |           |
|        |               |         |                    | ±20%               | GCJ32ER91C685ME01# |                    |           |
| 10µF   |               |         | ±10%               | GCJ32ER91C106KE01# |                    |                    |           |
|        |               | ±20%    | GCJ32ER91C106ME01# |                    |                    |                    |           |
| X7R    |               | 22µF    | ±10%               | GCJ32ER71C226KE01# |                    |                    |           |
|        |               |         | ±20%               | GCJ32ER71C226ME01# |                    |                    |           |
| 6.3Vdc | X7R           | 47µF    | ±10%               | GCJ32ER70J476KE01# |                    |                    |           |
|        |               |         | ±20%               | GCJ32ER70J476ME01# |                    |                    |           |
| 2.85mm | 25Vdc         | X8L     | 22µF               | ±10%               | GCJ32EL8EF226KE08# | <b>D4</b>          |           |
|        |               | X7S     | 22µF               | ±10%               | GCJ32EC71E226KE02# |                    |           |

5.7×5.0mm

| T max. | Rated Voltage | TC Code | Cap.    | Tol. | Part Number        |      |
|--------|---------------|---------|---------|------|--------------------|------|
| 2.0mm  | 1000Vdc       | X7R     | 68000pF | ±10% | GCJ55DR73A683KXJ1# |      |
|        |               |         | 0.10µF  | ±10% | GCJ55DR73A104KXJ1# |      |
|        |               |         | 0.10µF  | ±10% | GCJ55DR72J104KXJ1# |      |
|        |               |         | 0.15µF  | ±10% | GCJ55DR72J154KXJ1# |      |
|        | 630Vdc        | X7R     | 0.22µF  | ±10% | GCJ55DR72J224KXJ1# |      |
|        |               |         | 0.33µF  | ±10% | GCJ55DR72E334KXJ1# |      |
|        |               |         | 0.47µF  | ±10% | GCJ55DR72E474KXJ1# |      |
|        |               |         | 0.68µF  | ±10% | GCJ55DR72E684KXJ1# |      |
|        |               |         | 1.0µF   | ±10% | GCJ55DR72E105KXJ1# |      |
|        |               |         | 250Vdc  | X7R  | 0.33µF             | ±10% |

4.5×3.2mm

| T max. | Rated Voltage | TC Code | Cap.    | Tol. | Part Number        |  |
|--------|---------------|---------|---------|------|--------------------|--|
| 1.5mm  | 630Vdc        | X7R     | 68000pF | ±10% | GCJ43QR72J683KXJ1# |  |
|        | 250Vdc        | X7R     | 0.15µF  | ±10% | GCJ43QR72E154KXJ1# |  |
| 2.0mm  | 1000Vdc       | X7R     | 33000pF | ±10% | GCJ43DR73A333KXJ1# |  |
|        |               |         | 47000pF | ±10% | GCJ43DR73A473KXJ1# |  |
|        | 630Vdc        | X7R     | 33000pF | ±10% | GCJ43DR72J333KXJ1# |  |
|        |               |         | 47000pF | ±10% | GCJ43DR72J473KXJ1# |  |

Part number # indicates the package specification code.

High Q Chip Multilayer Ceramic Capacitors for Automotive

**GCQ Series**



This product improves the high frequency characteristics and contributes to a reduction of power consumption by the High Q and low ESR. Capacitor for automotive applications such as power train and safety equipment.

Features

① High Q and Low ESR were achieved at a "high frequency," which is ideal for matching applications.

High Q and Low ESR were achieved at a high frequency, by adopting a ceramic material with extremely low loss at a high frequency as the dielectric material, and copper for the internal electrodes. This product is ideal for matching applications.

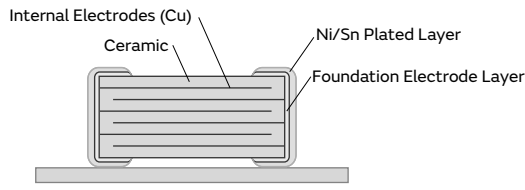

<Example of Structure>

② This is a High Q capacitor for V2X, ADAS, and automotive communication applications which conform to AEC-Q200.

The self-resonant frequency of 5.9 GHz (for 2.2 pF products) is ideal for the DC-CUT in DSRC IEEE821.11p.

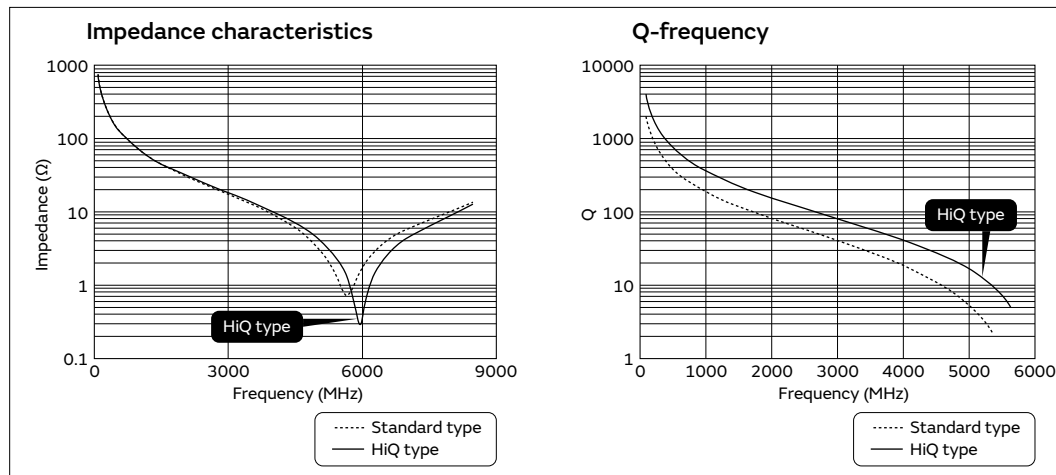

③ Can be used for tight tolerance.

In addition to standard tolerance, the allowable range of this product is also suitable for the following tight tolerance.

| Capacitance Range | Standard Capacitance Tolerance (Capacitance Tolerance Symbol) | Narrow Capacitance Tolerance (Capacitance Tolerance Symbol) |
|-------------------|---|---|
| to 0.9pF          | ±0.1pF (B)  | ±0.05pF (W)   |
| 1 to 5pF          | ±0.25pF (C)   | ±0.05pF (W), ±0.1pF (B)                                     |
| 5.1 to 9.9pF      | ±0.5pF (D)  | ±0.05pF (W), ±0.1pF (B), ±0.25pF (C)                        |
| 10pF~             | ±5% (J)   | ±2% (G)   |

GRT Series  
 GCM Series  
 GC3 Series  
 GCJ Series  
 GCQ Series  
 GCD Series  
 GCE Series  
 NMF Series  
 KCM Series  
 KC3 Series  
 KCA Series  
 GCB Series  
 GCG Series  
 △Caution /Notice

## Specifications

|                   |   |
|-------------------|---|
| Size              | 1.0×0.5mm   |
| Rated Voltage     | 50Vdc   |
| Capacitance       | 0.10pF to 47μF  |
| Main Applications | DC cut in the 5.9GHz of V2X applications, and RF matching<br>RF matching in the other automotive communication applications |

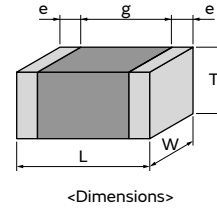

GRT Series

GCM Series

GC3 Series

GCJ Series

GCQ Series

GCD Series

GCE Series

NMF Series

KCM Series

KC3 Series

KCA Series

GCB Series

GCG Series

⚠Caution /Notice

# GCQ Series Temperature Compensating Type Part Number List

## 1.0x0.5mm

| T max.  | Rated Voltage      | TC Code            | Cap.   | Tol.    | Part Number        |
|---------|--------------------|--------------------|--------|---------|--------------------|
| 0.55mm  | 50Vdc              | COG                | 0.10pF | ±0.05pF | GCQ1555C1HR10WB01# |
|         |                    |                    |        | ±0.1pF  | GCQ1555C1HR10BB01# |
|         |                    |                    | 0.11pF | ±0.05pF | GCQ1555C1HR11WB01# |
|         |                    |                    |        | ±0.1pF  | GCQ1555C1HR11BB01# |
|         |                    |                    | 0.12pF | ±0.05pF | GCQ1555C1HR12WB01# |
|         |                    |                    |        | ±0.1pF  | GCQ1555C1HR12BB01# |
|         |                    |                    | 0.13pF | ±0.05pF | GCQ1555C1HR13WB01# |
|         |                    |                    |        | ±0.1pF  | GCQ1555C1HR13BB01# |
|         |                    |                    | 0.15pF | ±0.05pF | GCQ1555C1HR15WB01# |
|         |                    |                    |        | ±0.1pF  | GCQ1555C1HR15BB01# |
|         |                    |                    | 0.16pF | ±0.05pF | GCQ1555C1HR16WB01# |
|         |                    |                    |        | ±0.1pF  | GCQ1555C1HR16BB01# |
|         |                    |                    | 0.18pF | ±0.05pF | GCQ1555C1HR18WB01# |
|         |                    |                    |        | ±0.1pF  | GCQ1555C1HR18BB01# |
|         |                    |                    | 0.20pF | ±0.05pF | GCQ1555C1HR20WB01# |
|         |                    |                    |        | ±0.1pF  | GCQ1555C1HR20BB01# |
|         |                    |                    | 0.22pF | ±0.05pF | GCQ1555C1HR22WB01# |
|         |                    |                    |        | ±0.1pF  | GCQ1555C1HR22BB01# |
|         |                    |                    | 0.24pF | ±0.05pF | GCQ1555C1HR24WB01# |
|         |                    |                    |        | ±0.1pF  | GCQ1555C1HR24BB01# |
|         |                    |                    | 0.25pF | ±0.1pF  | GCQ1555C1HR25BB01# |
|         |                    |                    | 0.27pF | ±0.05pF | GCQ1555C1HR27WB01# |
|         |                    |                    |        | ±0.1pF  | GCQ1555C1HR27BB01# |
|         |                    |                    |        | ±0.25pF | GCQ1555C1HR27CB01# |
|         |                    |                    | 0.30pF | ±0.05pF | GCQ1555C1HR30WB01# |
|         |                    |                    |        | ±0.1pF  | GCQ1555C1HR30BB01# |
|         |                    |                    |        | ±0.25pF | GCQ1555C1HR30CB01# |
|         |                    |                    | 0.33pF | ±0.05pF | GCQ1555C1HR33WB01# |
|         |                    |                    |        | ±0.1pF  | GCQ1555C1HR33BB01# |
|         |                    |                    |        | ±0.25pF | GCQ1555C1HR33CB01# |
|         |                    |                    | 0.36pF | ±0.05pF | GCQ1555C1HR36WB01# |
|         |                    |                    |        | ±0.1pF  | GCQ1555C1HR36BB01# |
|         |                    |                    |        | ±0.25pF | GCQ1555C1HR36CB01# |
|         |                    |                    | 0.39pF | ±0.05pF | GCQ1555C1HR39WB01# |
|         |                    |                    |        | ±0.1pF  | GCQ1555C1HR39BB01# |
|         |                    |                    |        | ±0.25pF | GCQ1555C1HR39CB01# |
|         |                    |                    | 0.40pF | ±0.05pF | GCQ1555C1HR40WB01# |
|         |                    |                    |        | ±0.1pF  | GCQ1555C1HR40BB01# |
|         |                    |                    |        | ±0.25pF | GCQ1555C1HR40CB01# |
|         |                    |                    | 0.43pF | ±0.05pF | GCQ1555C1HR43WB01# |
|         |                    |                    |        | ±0.1pF  | GCQ1555C1HR43BB01# |
|         |                    |                    |        | ±0.25pF | GCQ1555C1HR43CB01# |
|         |                    |                    | 0.45pF | ±0.05pF | GCQ1555C1HR45WB01# |
|         |                    |                    | 0.47pF | ±0.05pF | GCQ1555C1HR47WB01# |
|         |                    |                    |        | ±0.1pF  | GCQ1555C1HR47BB01# |
|         |                    |                    |        | ±0.25pF | GCQ1555C1HR47CB01# |
|         |                    |                    | 0.50pF | ±0.05pF | GCQ1555C1HR50WB01# |
|         |                    |                    |        | ±0.1pF  | GCQ1555C1HR50BB01# |
| ±0.25pF | GCQ1555C1HR50CB01# |                    |        |         |                    |
| ±0.5pF  | GCQ1555C1HR50DB01# |                    |        |         |                    |
| 0.51pF  | ±0.05pF            | GCQ1555C1HR51WB01# |        |         |                    |
|         | ±0.1pF             | GCQ1555C1HR51BB01# |        |         |                    |

| T max. | Rated Voltage | TC Code            | Cap.   | Tol.    | Part Number        |
|--------|---------------|--------------------|--------|---------|--------------------|
| 0.55mm | 50Vdc         | COG                | 0.51pF | ±0.25pF | GCQ1555C1HR51CB01# |
|        |               |                    |        | ±0.5pF  | GCQ1555C1HR51DB01# |
|        |               |                    | 0.56pF | ±0.05pF | GCQ1555C1HR56WB01# |
|        |               |                    |        | ±0.1pF  | GCQ1555C1HR56BB01# |
|        |               |                    |        | ±0.25pF | GCQ1555C1HR56CB01# |
|        |               |                    |        | ±0.5pF  | GCQ1555C1HR56DB01# |
|        |               |                    | 0.60pF | ±0.05pF | GCQ1555C1HR60WB01# |
|        |               |                    |        | ±0.1pF  | GCQ1555C1HR60BB01# |
|        |               |                    |        | ±0.25pF | GCQ1555C1HR60CB01# |
|        |               |                    |        | ±0.5pF  | GCQ1555C1HR60DB01# |
|        |               |                    | 0.62pF | ±0.05pF | GCQ1555C1HR62WB01# |
|        |               |                    |        | ±0.1pF  | GCQ1555C1HR62BB01# |
|        |               |                    |        | ±0.25pF | GCQ1555C1HR62CB01# |
|        |               |                    |        | ±0.5pF  | GCQ1555C1HR62DB01# |
|        |               |                    | 0.68pF | ±0.05pF | GCQ1555C1HR68WB01# |
|        |               |                    |        | ±0.1pF  | GCQ1555C1HR68BB01# |
|        |               |                    |        | ±0.25pF | GCQ1555C1HR68CB01# |
|        |               |                    |        | ±0.5pF  | GCQ1555C1HR68DB01# |
|        |               |                    | 0.70pF | ±0.05pF | GCQ1555C1HR70WB01# |
|        |               |                    |        | ±0.1pF  | GCQ1555C1HR70BB01# |
|        |               |                    |        | ±0.25pF | GCQ1555C1HR70CB01# |
|        |               |                    |        | ±0.5pF  | GCQ1555C1HR70DB01# |
|        |               |                    | 0.75pF | ±0.05pF | GCQ1555C1HR75WB01# |
|        |               |                    |        | ±0.1pF  | GCQ1555C1HR75BB01# |
|        |               |                    |        | ±0.25pF | GCQ1555C1HR75CB01# |
|        |               |                    |        | ±0.5pF  | GCQ1555C1HR75DB01# |
|        |               |                    | 0.80pF | ±0.05pF | GCQ1555C1HR80WB01# |
|        |               |                    |        | ±0.1pF  | GCQ1555C1HR80BB01# |
|        |               |                    |        | ±0.25pF | GCQ1555C1HR80CB01# |
|        |               |                    |        | ±0.5pF  | GCQ1555C1HR80DB01# |
|        |               |                    | 0.82pF | ±0.05pF | GCQ1555C1HR82WB01# |
|        |               |                    |        | ±0.1pF  | GCQ1555C1HR82BB01# |
|        |               |                    |        | ±0.25pF | GCQ1555C1HR82CB01# |
|        |               |                    |        | ±0.5pF  | GCQ1555C1HR82DB01# |
|        |               |                    | 0.85pF | ±0.05pF | GCQ1555C1HR85WB01# |
|        |               |                    | 0.90pF | ±0.05pF | GCQ1555C1HR90WB01# |
|        |               |                    |        | ±0.1pF  | GCQ1555C1HR90BB01# |
|        |               |                    |        | ±0.25pF | GCQ1555C1HR90CB01# |
|        |               |                    |        | ±0.5pF  | GCQ1555C1HR90DB01# |
|        |               |                    | 0.91pF | ±0.05pF | GCQ1555C1HR91WB01# |
|        |               |                    |        | ±0.1pF  | GCQ1555C1HR91BB01# |
|        |               |                    |        | ±0.25pF | GCQ1555C1HR91CB01# |
|        |               |                    |        | ±0.5pF  | GCQ1555C1HR91DB01# |
|        |               |                    | 0.95pF | ±0.05pF | GCQ1555C1HR95WB01# |
|        |               |                    | 1.0pF  | ±0.05pF | GCQ1555C1H1R0WB01# |
|        |               |                    |        | ±0.1pF  | GCQ1555C1H1R0BB01# |
|        |               |                    |        | ±0.25pF | GCQ1555C1H1R0CB01# |
|        |               |                    |        | ±0.5pF  | GCQ1555C1H1R0DB01# |
| 1.1pF  | ±0.05pF       | GCQ1555C1H1R1WB01# |        |         |                    |
|        | ±0.1pF        | GCQ1555C1H1R1BB01# |        |         |                    |
|        | ±0.25pF       | GCQ1555C1H1R1CB01# |        |         |                    |
|        | ±0.5pF        | GCQ1555C1H1R1DB01# |        |         |                    |
| 1.2pF  | ±0.05pF       | GCQ1555C1H1R2WB01# |        |         |                    |
|        | ±0.1pF        | GCQ1555C1H1R2BB01# |        |         |                    |

Part number # indicates the package specification code.

GRT Series  
 GCM Series  
 GC3 Series  
 GCJ Series  
 GCQ Series  
 GCD Series  
 GCE Series  
 NMF Series  
 KCM Series  
 KC3 Series  
 KCA Series  
 GCB Series  
 GCG Series  
 ⚠Caution /Notice

# GCQ Series Temperature Compensating Type Part Number List

(→ 1.0×0.5mm)

| T max. | Rated Voltage | TC Code | Cap.   | Tol.               | Part Number        | T max.  | Rated Voltage | TC Code | Cap.               | Tol.               | Part Number        |
|--------|---------------|---------|--------|--------------------|--------------------|---------|---------------|---------|--------------------|--------------------|--------------------|
| 0.55mm | 50Vdc         | COG     | 1.2pF  | ±0.25pF            | GCQ1555C1H1R2CB01# | 0.55mm  | 50Vdc         | COG     | 2.6pF              | ±0.05pF            | GCQ1555C1H2R6WB01# |
|        |               |         |        | ±0.5pF             | GCQ1555C1H1R2DB01# |         |               |         |                    | ±0.1pF             | GCQ1555C1H2R6BB01# |
|        |               |         | 1.3pF  | ±0.05pF            | GCQ1555C1H1R3WB01# | ±0.25pF |               |         | GCQ1555C1H2R6CB01# |                    |                    |
|        |               |         |        | ±0.1pF             | GCQ1555C1H1R3BB01# | ±0.5pF  |               |         | GCQ1555C1H2R6DB01# |                    |                    |
|        |               |         |        | ±0.25pF            | GCQ1555C1H1R3CB01# | 2.7pF   |               |         | ±0.05pF            | GCQ1555C1H2R7WB01# |                    |
|        |               |         |        | ±0.5pF             | GCQ1555C1H1R3DB01# |         |               |         | ±0.1pF             | GCQ1555C1H2R7BB01# |                    |
|        |               |         | 1.4pF  | ±0.05pF            | GCQ1555C1H1R4WB01# |         |               |         | ±0.25pF            | GCQ1555C1H2R7CB01# |                    |
|        |               |         |        | ±0.1pF             | GCQ1555C1H1R4BB01# | ±0.5pF  |               |         | GCQ1555C1H2R7DB01# |                    |                    |
|        |               |         |        | ±0.25pF            | GCQ1555C1H1R4CB01# | 2.8pF   |               |         | ±0.05pF            | GCQ1555C1H2R8WB01# |                    |
|        |               |         | ±0.5pF | GCQ1555C1H1R4DB01# | ±0.1pF             |         |               |         | GCQ1555C1H2R8BB01# |                    |                    |
|        |               |         | 1.5pF  | ±0.05pF            | GCQ1555C1H1R5WB01# |         |               |         | ±0.25pF            | GCQ1555C1H2R8CB01# |                    |
|        |               |         |        | ±0.1pF             | GCQ1555C1H1R5BB01# | ±0.5pF  |               |         | GCQ1555C1H2R8DB01# |                    |                    |
|        |               |         |        | ±0.25pF            | GCQ1555C1H1R5CB01# | 2.9pF   |               |         | ±0.05pF            | GCQ1555C1H2R9WB01# |                    |
|        |               |         |        | ±0.5pF             | GCQ1555C1H1R5DB01# |         |               |         | ±0.1pF             | GCQ1555C1H2R9BB01# |                    |
|        |               |         | 1.6pF  | ±0.05pF            | GCQ1555C1H1R6WB01# |         |               |         | ±0.25pF            | GCQ1555C1H2R9CB01# |                    |
|        |               |         |        | ±0.1pF             | GCQ1555C1H1R6BB01# | ±0.5pF  |               |         | GCQ1555C1H2R9DB01# |                    |                    |
|        |               |         |        | ±0.25pF            | GCQ1555C1H1R6CB01# | 3.0pF   |               |         | ±0.05pF            | GCQ1555C1H3ROWB01# |                    |
|        |               |         |        | ±0.5pF             | GCQ1555C1H1R6DB01# |         |               |         | ±0.1pF             | GCQ1555C1H3ROBB01# |                    |
|        |               |         | 1.7pF  | ±0.05pF            | GCQ1555C1H1R7WB01# |         |               |         | ±0.25pF            | GCQ1555C1H3ROCB01# |                    |
|        |               |         |        | ±0.1pF             | GCQ1555C1H1R7BB01# |         |               |         | ±0.5pF             | GCQ1555C1H3RODB01# |                    |
|        |               |         |        | ±0.25pF            | GCQ1555C1H1R7CB01# | 3.1pF   |               |         | ±0.05pF            | GCQ1555C1H3R1WB01# |                    |
|        |               |         |        | ±0.5pF             | GCQ1555C1H1R7DB01# |         |               |         | ±0.1pF             | GCQ1555C1H3R1BB01# |                    |
|        |               |         | 1.8pF  | ±0.05pF            | GCQ1555C1H1R8WB01# |         |               |         | ±0.25pF            | GCQ1555C1H3R1CB01# |                    |
|        |               |         |        | ±0.1pF             | GCQ1555C1H1R8BB01# | ±0.5pF  |               |         | GCQ1555C1H3R1DB01# |                    |                    |
|        |               |         |        | ±0.25pF            | GCQ1555C1H1R8CB01# | 3.2pF   |               |         | ±0.05pF            | GCQ1555C1H3R2WB01# |                    |
|        |               |         |        | ±0.5pF             | GCQ1555C1H1R8DB01# |         |               |         | ±0.1pF             | GCQ1555C1H3R2BB01# |                    |
|        |               |         | 1.9pF  | ±0.05pF            | GCQ1555C1H1R9WB01# |         |               |         | ±0.25pF            | GCQ1555C1H3R2CB01# |                    |
|        |               |         |        | ±0.1pF             | GCQ1555C1H1R9BB01# |         |               |         | ±0.5pF             | GCQ1555C1H3R2DB01# |                    |
|        |               |         |        | ±0.25pF            | GCQ1555C1H1R9CB01# | 3.3pF   |               |         | ±0.05pF            | GCQ1555C1H3R3WB01# |                    |
|        |               |         |        | ±0.5pF             | GCQ1555C1H1R9DB01# |         |               |         | ±0.1pF             | GCQ1555C1H3R3BB01# |                    |
|        |               |         | 2.0pF  | ±0.05pF            | GCQ1555C1H2R0WB01# |         |               |         | ±0.25pF            | GCQ1555C1H3R3CB01# |                    |
|        |               |         |        | ±0.1pF             | GCQ1555C1H2R0BB01# | ±0.5pF  |               |         | GCQ1555C1H3R3DB01# |                    |                    |
|        |               |         |        | ±0.25pF            | GCQ1555C1H2R0CB01# | 3.4pF   |               |         | ±0.05pF            | GCQ1555C1H3R4WB01# |                    |
|        |               |         |        | ±0.5pF             | GCQ1555C1H2R0DB01# |         |               |         | ±0.1pF             | GCQ1555C1H3R4BB01# |                    |
|        |               |         | 2.1pF  | ±0.05pF            | GCQ1555C1H2R1WB01# |         |               |         | ±0.25pF            | GCQ1555C1H3R4CB01# |                    |
|        |               |         |        | ±0.1pF             | GCQ1555C1H2R1BB01# |         |               |         | ±0.5pF             | GCQ1555C1H3R4DB01# |                    |
|        |               |         |        | ±0.25pF            | GCQ1555C1H2R1CB01# | 3.5pF   |               |         | ±0.05pF            | GCQ1555C1H3R5WB01# |                    |
|        |               |         |        | ±0.5pF             | GCQ1555C1H2R1DB01# |         |               |         | ±0.1pF             | GCQ1555C1H3R5BB01# |                    |
|        |               |         | 2.2pF  | ±0.05pF            | GCQ1555C1H2R2WB01# |         |               |         | ±0.25pF            | GCQ1555C1H3R5CB01# |                    |
|        |               |         |        | ±0.1pF             | GCQ1555C1H2R2BB01# | ±0.5pF  |               |         | GCQ1555C1H3R5DB01# |                    |                    |
|        |               |         |        | ±0.25pF            | GCQ1555C1H2R2CB01# | 3.6pF   |               |         | ±0.05pF            | GCQ1555C1H3R6WB01# |                    |
|        |               |         |        | ±0.5pF             | GCQ1555C1H2R2DB01# |         |               |         | ±0.1pF             | GCQ1555C1H3R6BB01# |                    |
|        |               |         | 2.3pF  | ±0.05pF            | GCQ1555C1H2R3WB01# |         |               |         | ±0.25pF            | GCQ1555C1H3R6CB01# |                    |
|        |               |         |        | ±0.1pF             | GCQ1555C1H2R3BB01# |         |               |         | ±0.5pF             | GCQ1555C1H3R6DB01# |                    |
|        |               |         |        | ±0.25pF            | GCQ1555C1H2R3CB01# | 3.7pF   |               |         | ±0.05pF            | GCQ1555C1H3R7WB01# |                    |
|        |               |         |        | ±0.5pF             | GCQ1555C1H2R3DB01# |         |               |         | ±0.1pF             | GCQ1555C1H3R7BB01# |                    |
|        |               |         | 2.4pF  | ±0.05pF            | GCQ1555C1H2R4WB01# |         |               |         | ±0.25pF            | GCQ1555C1H3R7CB01# |                    |
|        |               |         |        | ±0.1pF             | GCQ1555C1H2R4BB01# | ±0.5pF  |               |         | GCQ1555C1H3R7DB01# |                    |                    |
|        |               |         |        | ±0.25pF            | GCQ1555C1H2R4CB01# | 3.8pF   |               |         | ±0.05pF            | GCQ1555C1H3R8WB01# |                    |
|        |               |         |        | ±0.5pF             | GCQ1555C1H2R4DB01# |         |               |         | ±0.1pF             | GCQ1555C1H3R8BB01# |                    |
|        |               |         | 2.5pF  | ±0.05pF            | GCQ1555C1H2R5WB01# |         |               |         | ±0.25pF            | GCQ1555C1H3R8CB01# |                    |
|        |               |         |        | ±0.1pF             | GCQ1555C1H2R5BB01# |         |               |         | ±0.5pF             | GCQ1555C1H3R8DB01# |                    |
|        |               |         |        | ±0.25pF            | GCQ1555C1H2R5CB01# | 3.9pF   |               |         | ±0.05pF            | GCQ1555C1H3R9WB01# |                    |
|        |               |         |        | ±0.5pF             | GCQ1555C1H2R5DB01# |         |               |         | ±0.1pF             | GCQ1555C1H3R9BB01# |                    |

Part number # indicates the package specification code.

GRT Series  
 GCM Series  
 GC3 Series  
 GCJ Series  
 GCQ Series  
 GCD Series  
 GCE Series  
 NMF Series  
 KCM Series  
 KC3 Series  
 KCA Series  
 GCB Series  
 GCG Series  
 ⚠Caution /Notice

# GCQ Series Temperature Compensating Type Part Number List

(→ 1.0×0.5mm)

| T max. | Rated Voltage | TC Code | Cap.   | Tol.               | Part Number        | T max.  | Rated Voltage | TC Code | Cap.               | Tol.               | Part Number        |
|--------|---------------|---------|--------|--------------------|--------------------|---------|---------------|---------|--------------------|--------------------|--------------------|
| 0.55mm | 50Vdc         | COG     | 3.9pF  | ±0.25pF            | GCQ1555C1H3R9CB01# | 0.55mm  | 50Vdc         | COG     | 5.3pF              | ±0.05pF            | GCQ1555C1H5R3WB01# |
|        |               |         |        | ±0.5pF             | GCQ1555C1H3R9DB01# |         |               |         |                    | ±0.1pF             | GCQ1555C1H5R3BB01# |
|        |               |         | 4.0pF  | ±0.05pF            | GCQ1555C1H4R0WB01# | ±0.25pF |               |         | GCQ1555C1H5R3CB01# |                    |                    |
|        |               |         |        | ±0.1pF             | GCQ1555C1H4R0BB01# | ±0.5pF  |               |         | GCQ1555C1H5R3DB01# |                    |                    |
|        |               |         |        | ±0.25pF            | GCQ1555C1H4R0CB01# | 5.4pF   |               |         | ±0.05pF            | GCQ1555C1H5R4WB01# |                    |
|        |               |         |        | ±0.5pF             | GCQ1555C1H4R0DB01# |         |               |         | ±0.1pF             | GCQ1555C1H5R4BB01# |                    |
|        |               |         | 4.1pF  | ±0.05pF            | GCQ1555C1H4R1WB01# |         |               |         | ±0.25pF            | GCQ1555C1H5R4CB01# |                    |
|        |               |         |        | ±0.1pF             | GCQ1555C1H4R1BB01# | ±0.5pF  |               |         | GCQ1555C1H5R4DB01# |                    |                    |
|        |               |         |        | ±0.25pF            | GCQ1555C1H4R1CB01# | 5.5pF   |               |         | ±0.05pF            | GCQ1555C1H5R5WB01# |                    |
|        |               |         | ±0.5pF | GCQ1555C1H4R1DB01# | ±0.1pF             |         |               |         | GCQ1555C1H5R5BB01# |                    |                    |
|        |               |         | 4.2pF  | ±0.05pF            | GCQ1555C1H4R2WB01# |         |               |         | ±0.25pF            | GCQ1555C1H5R5CB01# |                    |
|        |               |         |        | ±0.1pF             | GCQ1555C1H4R2BB01# | ±0.5pF  |               |         | GCQ1555C1H5R5DB01# |                    |                    |
|        |               |         |        | ±0.25pF            | GCQ1555C1H4R2CB01# | 5.6pF   |               |         | ±0.05pF            | GCQ1555C1H5R6WB01# |                    |
|        |               |         |        | ±0.5pF             | GCQ1555C1H4R2DB01# |         |               |         | ±0.1pF             | GCQ1555C1H5R6BB01# |                    |
|        |               |         | 4.3pF  | ±0.05pF            | GCQ1555C1H4R3WB01# |         |               |         | ±0.25pF            | GCQ1555C1H5R6CB01# |                    |
|        |               |         |        | ±0.1pF             | GCQ1555C1H4R3BB01# | ±0.5pF  |               |         | GCQ1555C1H5R6DB01# |                    |                    |
|        |               |         |        | ±0.25pF            | GCQ1555C1H4R3CB01# | 5.7pF   |               |         | ±0.05pF            | GCQ1555C1H5R7WB01# |                    |
|        |               |         |        | ±0.5pF             | GCQ1555C1H4R3DB01# |         |               |         | ±0.1pF             | GCQ1555C1H5R7BB01# |                    |
|        |               |         | 4.4pF  | ±0.05pF            | GCQ1555C1H4R4WB01# |         |               |         | ±0.25pF            | GCQ1555C1H5R7CB01# |                    |
|        |               |         |        | ±0.1pF             | GCQ1555C1H4R4BB01# | ±0.5pF  |               |         | GCQ1555C1H5R7DB01# |                    |                    |
|        |               |         |        | ±0.25pF            | GCQ1555C1H4R4CB01# | 5.8pF   |               |         | ±0.05pF            | GCQ1555C1H5R8WB01# |                    |
|        |               |         |        | ±0.5pF             | GCQ1555C1H4R4DB01# |         |               |         | ±0.1pF             | GCQ1555C1H5R8BB01# |                    |
|        |               |         | 4.5pF  | ±0.05pF            | GCQ1555C1H4R5WB01# |         |               |         | ±0.25pF            | GCQ1555C1H5R8CB01# |                    |
|        |               |         |        | ±0.1pF             | GCQ1555C1H4R5BB01# | ±0.5pF  |               |         | GCQ1555C1H5R8DB01# |                    |                    |
|        |               |         |        | ±0.25pF            | GCQ1555C1H4R5CB01# | 5.9pF   |               |         | ±0.05pF            | GCQ1555C1H5R9WB01# |                    |
|        |               |         |        | ±0.5pF             | GCQ1555C1H4R5DB01# |         |               |         | ±0.1pF             | GCQ1555C1H5R9BB01# |                    |
|        |               |         | 4.6pF  | ±0.05pF            | GCQ1555C1H4R6WB01# |         |               |         | ±0.25pF            | GCQ1555C1H5R9CB01# |                    |
|        |               |         |        | ±0.1pF             | GCQ1555C1H4R6BB01# | ±0.5pF  |               |         | GCQ1555C1H5R9DB01# |                    |                    |
|        |               |         |        | ±0.25pF            | GCQ1555C1H4R6CB01# | 6.0pF   |               |         | ±0.05pF            | GCQ1555C1H6R0WB01# |                    |
|        |               |         |        | ±0.5pF             | GCQ1555C1H4R6DB01# |         |               |         | ±0.1pF             | GCQ1555C1H6R0BB01# |                    |
|        |               |         | 4.7pF  | ±0.05pF            | GCQ1555C1H4R7WB01# |         |               |         | ±0.25pF            | GCQ1555C1H6R0CB01# |                    |
|        |               |         |        | ±0.1pF             | GCQ1555C1H4R7BB01# | ±0.5pF  |               |         | GCQ1555C1H6R0DB01# |                    |                    |
|        |               |         |        | ±0.25pF            | GCQ1555C1H4R7CB01# | 6.1pF   |               |         | ±0.05pF            | GCQ1555C1H6R1WB01# |                    |
|        |               |         |        | ±0.5pF             | GCQ1555C1H4R7DB01# |         |               |         | ±0.1pF             | GCQ1555C1H6R1BB01# |                    |
|        |               |         | 4.8pF  | ±0.05pF            | GCQ1555C1H4R8WB01# |         |               |         | ±0.25pF            | GCQ1555C1H6R1CB01# |                    |
|        |               |         |        | ±0.1pF             | GCQ1555C1H4R8BB01# | ±0.5pF  |               |         | GCQ1555C1H6R1DB01# |                    |                    |
|        |               |         |        | ±0.25pF            | GCQ1555C1H4R8CB01# | 6.2pF   |               |         | ±0.05pF            | GCQ1555C1H6R2WB01# |                    |
|        |               |         |        | ±0.5pF             | GCQ1555C1H4R8DB01# |         |               |         | ±0.1pF             | GCQ1555C1H6R2BB01# |                    |
|        |               |         | 4.9pF  | ±0.05pF            | GCQ1555C1H4R9WB01# |         |               |         | ±0.25pF            | GCQ1555C1H6R2CB01# |                    |
|        |               |         |        | ±0.1pF             | GCQ1555C1H4R9BB01# | ±0.5pF  |               |         | GCQ1555C1H6R2DB01# |                    |                    |
|        |               |         |        | ±0.25pF            | GCQ1555C1H4R9CB01# | 6.3pF   |               |         | ±0.05pF            | GCQ1555C1H6R3WB01# |                    |
|        |               |         |        | ±0.5pF             | GCQ1555C1H4R9DB01# |         |               |         | ±0.1pF             | GCQ1555C1H6R3BB01# |                    |
|        |               |         | 5.0pF  | ±0.05pF            | GCQ1555C1H5R0WB01# |         |               |         | ±0.25pF            | GCQ1555C1H6R3CB01# |                    |
|        |               |         |        | ±0.1pF             | GCQ1555C1H5R0BB01# | ±0.5pF  |               |         | GCQ1555C1H6R3DB01# |                    |                    |
|        |               |         |        | ±0.25pF            | GCQ1555C1H5R0CB01# | 6.4pF   |               |         | ±0.05pF            | GCQ1555C1H6R4WB01# |                    |
|        |               |         |        | ±0.5pF             | GCQ1555C1H5R0DB01# |         |               |         | ±0.1pF             | GCQ1555C1H6R4BB01# |                    |
|        |               |         | 5.1pF  | ±0.05pF            | GCQ1555C1H5R1WB01# |         |               |         | ±0.25pF            | GCQ1555C1H6R4CB01# |                    |
|        |               |         |        | ±0.1pF             | GCQ1555C1H5R1BB01# | ±0.5pF  |               |         | GCQ1555C1H6R4DB01# |                    |                    |
|        |               |         |        | ±0.25pF            | GCQ1555C1H5R1CB01# | 6.5pF   |               |         | ±0.05pF            | GCQ1555C1H6R5WB01# |                    |
|        |               |         |        | ±0.5pF             | GCQ1555C1H5R1DB01# |         |               |         | ±0.1pF             | GCQ1555C1H6R5BB01# |                    |
|        |               |         | 5.2pF  | ±0.05pF            | GCQ1555C1H5R2WB01# |         |               |         | ±0.25pF            | GCQ1555C1H6R5CB01# |                    |
|        |               |         |        | ±0.1pF             | GCQ1555C1H5R2BB01# | ±0.5pF  |               |         | GCQ1555C1H6R5DB01# |                    |                    |
|        |               |         |        | ±0.25pF            | GCQ1555C1H5R2CB01# | 6.6pF   |               |         | ±0.05pF            | GCQ1555C1H6R6WB01# |                    |
|        |               |         |        | ±0.5pF             | GCQ1555C1H5R2DB01# |         |               |         | ±0.1pF             | GCQ1555C1H6R6BB01# |                    |

Part number # indicates the package specification code.

GRT Series  
 GCM Series  
 GC3 Series  
 GCJ Series  
 GCQ Series  
 GCD Series  
 GCE Series  
 NMF Series  
 KCM Series  
 KC3 Series  
 KCA Series  
 GCB Series  
 GCG Series  
 ⚠Caution /Notice

# GCQ Series Temperature Compensating Type Part Number List

(→ 1.0×0.5mm)

| T max. | Rated Voltage | TC Code | Cap.  | Tol.    | Part Number        | T max.  | Rated Voltage | TC Code | Cap.               | Tol.               | Part Number        |
|--------|---------------|---------|-------|---------|--------------------|---------|---------------|---------|--------------------|--------------------|--------------------|
| 0.55mm | 50Vdc         | COG     | 6.6pF | ±0.25pF | GCQ1555C1H6R6CB01# | 0.55mm  | 50Vdc         | COG     | 8.0pF              | ±0.05pF            | GCQ1555C1H8ROWB01# |
|        |               |         |       | ±0.5pF  | GCQ1555C1H6R6DB01# |         |               |         |                    | ±0.1pF             | GCQ1555C1H8ROBB01# |
|        |               |         | 6.7pF | ±0.05pF | GCQ1555C1H6R7WB01# | ±0.25pF |               |         | GCQ1555C1H8ROCB01# |                    |                    |
|        |               |         |       | ±0.1pF  | GCQ1555C1H6R7BB01# | ±0.5pF  |               |         | GCQ1555C1H8RODB01# |                    |                    |
|        |               |         |       | ±0.25pF | GCQ1555C1H6R7CB01# | 8.1pF   |               |         | ±0.05pF            | GCQ1555C1H8R1WB01# |                    |
|        |               |         |       | ±0.5pF  | GCQ1555C1H6R7DB01# |         |               |         | ±0.1pF             | GCQ1555C1H8R1BB01# |                    |
|        |               |         | 6.8pF | ±0.05pF | GCQ1555C1H6R8WB01# | ±0.25pF |               |         | GCQ1555C1H8R1CB01# |                    |                    |
|        |               |         |       | ±0.1pF  | GCQ1555C1H6R8BB01# | ±0.5pF  |               |         | GCQ1555C1H8R1DB01# |                    |                    |
|        |               |         |       | ±0.25pF | GCQ1555C1H6R8CB01# | 8.2pF   |               |         | ±0.05pF            | GCQ1555C1H8R2WB01# |                    |
|        |               |         |       | ±0.5pF  | GCQ1555C1H6R8DB01# |         |               |         | ±0.1pF             | GCQ1555C1H8R2BB01# |                    |
|        |               |         | 6.9pF | ±0.05pF | GCQ1555C1H6R9WB01# | ±0.25pF |               |         | GCQ1555C1H8R2CB01# |                    |                    |
|        |               |         |       | ±0.1pF  | GCQ1555C1H6R9BB01# | ±0.5pF  |               |         | GCQ1555C1H8R2DB01# |                    |                    |
|        |               |         |       | ±0.25pF | GCQ1555C1H6R9CB01# | 8.3pF   |               |         | ±0.05pF            | GCQ1555C1H8R3WB01# |                    |
|        |               |         |       | ±0.5pF  | GCQ1555C1H6R9DB01# |         |               |         | ±0.1pF             | GCQ1555C1H8R3BB01# |                    |
|        |               |         | 7.0pF | ±0.05pF | GCQ1555C1H7R0WB01# | ±0.25pF |               |         | GCQ1555C1H8R3CB01# |                    |                    |
|        |               |         |       | ±0.1pF  | GCQ1555C1H7R0BB01# | ±0.5pF  |               |         | GCQ1555C1H8R3DB01# |                    |                    |
|        |               |         |       | ±0.25pF | GCQ1555C1H7R0CB01# | 8.4pF   |               |         | ±0.05pF            | GCQ1555C1H8R4WB01# |                    |
|        |               |         |       | ±0.5pF  | GCQ1555C1H7R0DB01# |         |               |         | ±0.1pF             | GCQ1555C1H8R4BB01# |                    |
|        |               |         | 7.1pF | ±0.05pF | GCQ1555C1H7R1WB01# | ±0.25pF |               |         | GCQ1555C1H8R4CB01# |                    |                    |
|        |               |         |       | ±0.1pF  | GCQ1555C1H7R1BB01# | ±0.5pF  |               |         | GCQ1555C1H8R4DB01# |                    |                    |
|        |               |         |       | ±0.25pF | GCQ1555C1H7R1CB01# | 8.5pF   |               |         | ±0.05pF            | GCQ1555C1H8R5WB01# |                    |
|        |               |         |       | ±0.5pF  | GCQ1555C1H7R1DB01# |         |               |         | ±0.1pF             | GCQ1555C1H8R5BB01# |                    |
|        |               |         | 7.2pF | ±0.05pF | GCQ1555C1H7R2WB01# | ±0.25pF |               |         | GCQ1555C1H8R5CB01# |                    |                    |
|        |               |         |       | ±0.1pF  | GCQ1555C1H7R2BB01# | ±0.5pF  |               |         | GCQ1555C1H8R5DB01# |                    |                    |
|        |               |         |       | ±0.25pF | GCQ1555C1H7R2CB01# | 8.6pF   |               |         | ±0.05pF            | GCQ1555C1H8R6WB01# |                    |
|        |               |         |       | ±0.5pF  | GCQ1555C1H7R2DB01# |         |               |         | ±0.1pF             | GCQ1555C1H8R6BB01# |                    |
|        |               |         | 7.3pF | ±0.05pF | GCQ1555C1H7R3WB01# | ±0.25pF |               |         | GCQ1555C1H8R6CB01# |                    |                    |
|        |               |         |       | ±0.1pF  | GCQ1555C1H7R3BB01# | ±0.5pF  |               |         | GCQ1555C1H8R6DB01# |                    |                    |
|        |               |         |       | ±0.25pF | GCQ1555C1H7R3CB01# | 8.7pF   |               |         | ±0.05pF            | GCQ1555C1H8R7WB01# |                    |
|        |               |         |       | ±0.5pF  | GCQ1555C1H7R3DB01# |         |               |         | ±0.1pF             | GCQ1555C1H8R7BB01# |                    |
|        |               |         | 7.4pF | ±0.05pF | GCQ1555C1H7R4WB01# | ±0.25pF |               |         | GCQ1555C1H8R7CB01# |                    |                    |
|        |               |         |       | ±0.1pF  | GCQ1555C1H7R4BB01# | ±0.5pF  |               |         | GCQ1555C1H8R7DB01# |                    |                    |
|        |               |         |       | ±0.25pF | GCQ1555C1H7R4CB01# | 8.8pF   |               |         | ±0.05pF            | GCQ1555C1H8R8WB01# |                    |
|        |               |         |       | ±0.5pF  | GCQ1555C1H7R4DB01# |         |               |         | ±0.1pF             | GCQ1555C1H8R8BB01# |                    |
|        |               |         | 7.5pF | ±0.05pF | GCQ1555C1H7R5WB01# | ±0.25pF |               |         | GCQ1555C1H8R8CB01# |                    |                    |
|        |               |         |       | ±0.1pF  | GCQ1555C1H7R5BB01# | ±0.5pF  |               |         | GCQ1555C1H8R8DB01# |                    |                    |
|        |               |         |       | ±0.25pF | GCQ1555C1H7R5CB01# | 8.9pF   |               |         | ±0.05pF            | GCQ1555C1H8R9WB01# |                    |
|        |               |         |       | ±0.5pF  | GCQ1555C1H7R5DB01# |         |               |         | ±0.1pF             | GCQ1555C1H8R9BB01# |                    |
|        |               |         | 7.6pF | ±0.05pF | GCQ1555C1H7R6WB01# | ±0.25pF |               |         | GCQ1555C1H8R9CB01# |                    |                    |
|        |               |         |       | ±0.1pF  | GCQ1555C1H7R6BB01# | ±0.5pF  |               |         | GCQ1555C1H8R9DB01# |                    |                    |
|        |               |         |       | ±0.25pF | GCQ1555C1H7R6CB01# | 9.0pF   |               |         | ±0.05pF            | GCQ1555C1H9ROWB01# |                    |
|        |               |         |       | ±0.5pF  | GCQ1555C1H7R6DB01# |         |               |         | ±0.1pF             | GCQ1555C1H9ROBB01# |                    |
|        |               |         | 7.7pF | ±0.05pF | GCQ1555C1H7R7WB01# | ±0.25pF |               |         | GCQ1555C1H9ROCB01# |                    |                    |
|        |               |         |       | ±0.1pF  | GCQ1555C1H7R7BB01# | ±0.5pF  |               |         | GCQ1555C1H9RODB01# |                    |                    |
|        |               |         |       | ±0.25pF | GCQ1555C1H7R7CB01# | 9.1pF   |               |         | ±0.05pF            | GCQ1555C1H9R1WB01# |                    |
|        |               |         |       | ±0.5pF  | GCQ1555C1H7R7DB01# |         |               |         | ±0.1pF             | GCQ1555C1H9R1BB01# |                    |
|        |               |         | 7.8pF | ±0.05pF | GCQ1555C1H7R8WB01# | ±0.25pF |               |         | GCQ1555C1H9R1CB01# |                    |                    |
|        |               |         |       | ±0.1pF  | GCQ1555C1H7R8BB01# | ±0.5pF  |               |         | GCQ1555C1H9R1DB01# |                    |                    |
|        |               |         |       | ±0.25pF | GCQ1555C1H7R8CB01# | 9.2pF   |               |         | ±0.05pF            | GCQ1555C1H9R2WB01# |                    |
|        |               |         |       | ±0.5pF  | GCQ1555C1H7R8DB01# |         |               |         | ±0.1pF             | GCQ1555C1H9R2BB01# |                    |
|        |               |         | 7.9pF | ±0.05pF | GCQ1555C1H7R9WB01# | ±0.25pF |               |         | GCQ1555C1H9R2CB01# |                    |                    |
|        |               |         |       | ±0.1pF  | GCQ1555C1H7R9BB01# | ±0.5pF  |               |         | GCQ1555C1H9R2DB01# |                    |                    |
|        |               |         |       | ±0.25pF | GCQ1555C1H7R9CB01# | 9.3pF   |               |         | ±0.05pF            | GCQ1555C1H9R3WB01# |                    |
|        |               |         |       | ±0.5pF  | GCQ1555C1H7R9DB01# |         |               |         | ±0.1pF             | GCQ1555C1H9R3BB01# |                    |

Part number # indicates the package specification code.

GRT Series  
 GCM Series  
 GC3 Series  
 GCJ Series  
 GCQ Series  
 GCD Series  
 GCE Series  
 NMF Series  
 KCM Series  
 KC3 Series  
 KCA Series  
 GCB Series  
 GCG Series  
 ⚠Caution /Notice



# GCQ Series Temperature Compensating Type Part Number List

(→ 1.0×0.5mm)

| T max. | Rated Voltage | TC Code | Cap.  | Tol.    | Part Number        |
|--------|---------------|---------|-------|---------|--------------------|
| 0.55mm | 50Vdc         | COG     | 9.3pF | ±0.25pF | GCQ1555C1H9R3CB01# |
|        |               |         |       | ±0.5pF  | GCQ1555C1H9R3DB01# |
|        |               |         | 9.4pF | ±0.05pF | GCQ1555C1H9R4WB01# |
|        |               |         |       | ±0.1pF  | GCQ1555C1H9R4BB01# |
|        |               |         |       | ±0.25pF | GCQ1555C1H9R4CB01# |
|        |               |         |       | ±0.5pF  | GCQ1555C1H9R4DB01# |
|        |               |         | 9.5pF | ±0.05pF | GCQ1555C1H9R5WB01# |
|        |               |         |       | ±0.1pF  | GCQ1555C1H9R5BB01# |
|        |               |         |       | ±0.25pF | GCQ1555C1H9R5CB01# |
|        |               |         |       | ±0.5pF  | GCQ1555C1H9R5DB01# |
|        |               |         | 9.6pF | ±0.05pF | GCQ1555C1H9R6WB01# |
|        |               |         |       | ±0.1pF  | GCQ1555C1H9R6BB01# |
|        |               |         |       | ±0.25pF | GCQ1555C1H9R6CB01# |
|        |               |         |       | ±0.5pF  | GCQ1555C1H9R6DB01# |
|        |               |         | 9.7pF | ±0.05pF | GCQ1555C1H9R7WB01# |
|        |               |         |       | ±0.1pF  | GCQ1555C1H9R7BB01# |
|        |               |         |       | ±0.25pF | GCQ1555C1H9R7CB01# |
|        |               |         |       | ±0.5pF  | GCQ1555C1H9R7DB01# |
|        |               |         | 9.8pF | ±0.05pF | GCQ1555C1H9R8WB01# |
|        |               |         |       | ±0.1pF  | GCQ1555C1H9R8BB01# |
|        |               |         |       | ±0.25pF | GCQ1555C1H9R8CB01# |
|        |               |         |       | ±0.5pF  | GCQ1555C1H9R8DB01# |
|        |               |         | 9.9pF | ±0.05pF | GCQ1555C1H9R9WB01# |
|        |               |         |       | ±0.1pF  | GCQ1555C1H9R9BB01# |
|        |               |         |       | ±0.25pF | GCQ1555C1H9R9CB01# |
|        |               |         |       | ±0.5pF  | GCQ1555C1H9R9DB01# |
|        |               |         | 10pF  | ±1%     | GCQ1555C1H100FB01# |
|        |               |         |       | ±2%     | GCQ1555C1H100GB01# |
|        |               |         |       | ±2.5%   | GCQ1555C1H100RB01# |
|        |               |         |       | ±5%     | GCQ1555C1H100JB01# |
|        |               |         | 11pF  | ±1%     | GCQ1555C1H110FB01# |
|        |               |         |       | ±2%     | GCQ1555C1H110GB01# |
|        |               |         |       | ±5%     | GCQ1555C1H110JB01# |
|        |               |         | 12pF  | ±1%     | GCQ1555C1H120FB01# |
|        |               |         |       | ±2%     | GCQ1555C1H120GB01# |
|        |               |         |       | ±5%     | GCQ1555C1H120JB01# |
|        |               |         | 13pF  | ±1%     | GCQ1555C1H130FB01# |
|        |               |         |       | ±2%     | GCQ1555C1H130GB01# |
|        |               |         |       | ±5%     | GCQ1555C1H130JB01# |
|        |               |         | 14pF  | ±1%     | GCQ1555C1H140FB01# |
|        |               |         |       | ±2%     | GCQ1555C1H140GB01# |
|        |               |         |       | ±5%     | GCQ1555C1H140JB01# |
|        |               |         | 15pF  | ±1%     | GCQ1555C1H150FB01# |
|        |               |         |       | ±2%     | GCQ1555C1H150GB01# |
|        |               |         |       | ±5%     | GCQ1555C1H150JB01# |
|        |               |         | 16pF  | ±1%     | GCQ1555C1H160FB01# |
|        |               |         |       | ±2%     | GCQ1555C1H160GB01# |
|        |               |         |       | ±5%     | GCQ1555C1H160JB01# |
|        |               |         | 17pF  | ±1%     | GCQ1555C1H170FB01# |
|        |               |         |       | ±2%     | GCQ1555C1H170GB01# |
|        |               |         |       | ±5%     | GCQ1555C1H170JB01# |
|        |               |         | 18pF  | ±1%     | GCQ1555C1H180FB01# |
|        |               |         |       | ±2%     | GCQ1555C1H180GB01# |
|        |               |         |       | ±5%     | GCQ1555C1H180JB01# |

| T max. | Rated Voltage | TC Code | Cap. | Tol. | Part Number        |
|--------|---------------|---------|------|------|--------------------|
| 0.55mm | 50Vdc         | COG     | 19pF | ±1%  | GCQ1555C1H190FB01# |
|        |               |         |      | ±2%  | GCQ1555C1H190GB01# |
|        |               |         |      | ±5%  | GCQ1555C1H190JB01# |
|        |               |         | 20pF | ±1%  | GCQ1555C1H200FB01# |
|        |               |         |      | ±2%  | GCQ1555C1H200GB01# |
|        |               |         |      | ±5%  | GCQ1555C1H200JB01# |
|        |               |         | 22pF | ±1%  | GCQ1555C1H220FB01# |
|        |               |         |      | ±2%  | GCQ1555C1H220GB01# |
|        |               |         |      | ±5%  | GCQ1555C1H220JB01# |
|        |               |         | 24pF | ±1%  | GCQ1555C1H240FB01# |
|        |               |         |      | ±2%  | GCQ1555C1H240GB01# |
|        |               |         |      | ±5%  | GCQ1555C1H240JB01# |
|        |               |         | 27pF | ±1%  | GCQ1555C1H270FB01# |
|        |               |         |      | ±2%  | GCQ1555C1H270GB01# |
|        |               |         |      | ±5%  | GCQ1555C1H270JB01# |
|        |               |         | 30pF | ±1%  | GCQ1555C1H300FB01# |
|        |               |         |      | ±2%  | GCQ1555C1H300GB01# |
|        |               |         |      | ±5%  | GCQ1555C1H300JB01# |
|        |               |         | 33pF | ±1%  | GCQ1555C1H330FB01# |
|        |               |         |      | ±2%  | GCQ1555C1H330GB01# |
|        |               |         |      | ±5%  | GCQ1555C1H330JB01# |
|        |               |         | 36pF | ±1%  | GCQ1555C1H360FB01# |
|        |               |         |      | ±2%  | GCQ1555C1H360GB01# |
|        |               |         |      | ±5%  | GCQ1555C1H360JB01# |
|        |               |         | 39pF | ±1%  | GCQ1555C1H390FB01# |
|        |               |         |      | ±2%  | GCQ1555C1H390GB01# |
|        |               |         |      | ±5%  | GCQ1555C1H390JB01# |
|        |               |         | 43pF | ±1%  | GCQ1555C1H430FB01# |
|        |               |         |      | ±2%  | GCQ1555C1H430GB01# |
|        |               |         |      | ±5%  | GCQ1555C1H430JB01# |
|        |               |         | 47pF | ±1%  | GCQ1555C1H470FB01# |
|        |               |         |      | ±2%  | GCQ1555C1H470GB01# |
|        |               |         |      | ±5%  | GCQ1555C1H470JB01# |

GRT Series  
 GCM Series  
 GC3 Series  
 GCJ Series  
 GCQ Series  
 GCD Series  
 GCE Series  
 NMF Series  
 KCM Series  
 KC3 Series  
 KCA Series  
 GCB Series  
 GCG Series  
 ⚠Caution /Notice

Part number # indicates the package specification code.

MLSC Design Chip Multilayer Ceramic Capacitors for Automotive

**GCD Series**



**Prevents momentary dielectric breakdown by a 2-element array structure!**

Features

① Prevents momentary dielectric breakdown by a 2-element array structure!

This product consists of 2 elements arranged in 1 capacitor. It is structured so that even when 1 element is shorted, the other capacitor element will not short.

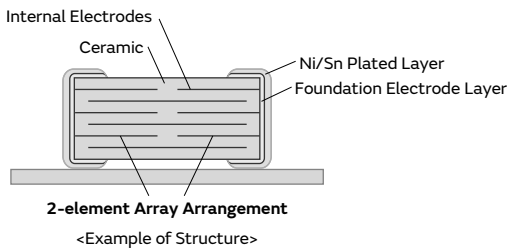

② This AEC-Q200 conforming product is ideal for the battery lines of automotive.

Space can be reduced in battery lines where 2 capacitors are arranged in an array.

Specifications

|                   |  |
|-------------------|--|
| Size              | 1.6×0.8mm to 2.0×1.25mm                      |
| Rated Voltage     | 16Vdc to 100Vdc                              |
| Capacitance       | 1000pF to 0.47μF                             |
| Main Applications | Battery Lines and Powertrains for automotive |

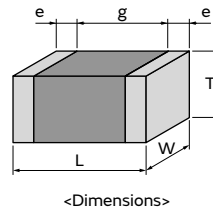

GRT Series  
 GCM Series  
 GC3 Series  
 GCJ Series  
 GCQ Series  
**GCD Series**  
 GCE Series  
 NMF Series  
 KCM Series  
 KC3 Series  
 KCA Series  
 GCB Series  
 GCG Series  
 ⚠Caution /Notice

# GCD Series High Dielectric Constant Type Part Number List

## 1.6×0.8mm

| T max. | Rated Voltage | TC Code | Cap.               | Tol.               | Part Number        |
|--------|---------------|---------|--------------------|--------------------|--------------------|
| 0.9mm  | 100Vdc        | X7R     | 1000pF             | ±10%               | GCD188R72A102KA01# |
|        |               |         |                    | ±20%               | GCD188R72A102MA01# |
|        |               |         | 1200pF             | ±10%               | GCD188R72A122KA01# |
|        |               |         |                    | ±20%               | GCD188R72A122MA01# |
|        |               |         | 1500pF             | ±10%               | GCD188R72A152KA01# |
|        |               |         |                    | ±20%               | GCD188R72A152MA01# |
|        |               |         | 1800pF             | ±10%               | GCD188R72A182KA01# |
|        |               |         |                    | ±20%               | GCD188R72A182MA01# |
|        |               |         | 2200pF             | ±10%               | GCD188R72A222KA01# |
|        |               |         |                    | ±20%               | GCD188R72A222MA01# |
|        |               |         | 2700pF             | ±10%               | GCD188R72A272KA01# |
|        |               |         |                    | ±20%               | GCD188R72A272MA01# |
|        |               |         | 3300pF             | ±10%               | GCD188R72A332KA01# |
|        |               |         |                    | ±20%               | GCD188R72A332MA01# |
|        |               |         | 3900pF             | ±10%               | GCD188R72A392KA01# |
|        |               |         |                    | ±20%               | GCD188R72A392MA01# |
|        |               |         | 4700pF             | ±10%               | GCD188R72A472KA01# |
|        |               |         |                    | ±20%               | GCD188R72A472MA01# |
|        |               |         | 5600pF             | ±10%               | GCD188R72A562KA01# |
|        |               |         |                    | ±20%               | GCD188R72A562MA01# |
|        |               |         | 6800pF             | ±10%               | GCD188R72A682KA01# |
|        |               |         |                    | ±20%               | GCD188R72A682MA01# |
|        |               |         | 8200pF             | ±10%               | GCD188R72A822KA01# |
|        |               |         |                    | ±20%               | GCD188R72A822MA01# |
|        | 10000pF       | ±10%    | GCD188R72A103KA01# |                    |                    |
|        |               | ±20%    | GCD188R72A103MA01# |                    |                    |
|        | 12000pF       | ±10%    | GCD188R72A123KA01# |                    |                    |
|        |               | ±20%    | GCD188R72A123MA01# |                    |                    |
|        | 15000pF       | ±10%    | GCD188R72A153KA01# |                    |                    |
|        |               | ±20%    | GCD188R72A153MA01# |                    |                    |
|        | 18000pF       | ±10%    | GCD188R72A183KA01# |                    |                    |
|        |               | ±20%    | GCD188R72A183MA01# |                    |                    |
|        | 22000pF       | ±10%    | GCD188R72A223KA01# |                    |                    |
|        |               | ±20%    | GCD188R72A223MA01# |                    |                    |
|        | 50Vdc         | X7R     | 1000pF             | ±10%               | GCD188R71H102KA01# |
|        |               |         |                    | ±20%               | GCD188R71H102MA01# |
|        |               |         | 1200pF             | ±10%               | GCD188R71H122KA01# |
|        |               |         |                    | ±20%               | GCD188R71H122MA01# |
|        |               |         | 1500pF             | ±10%               | GCD188R71H152KA01# |
|        |               |         |                    | ±20%               | GCD188R71H152MA01# |
|        |               |         | 1800pF             | ±10%               | GCD188R71H182KA01# |
|        |               |         |                    | ±20%               | GCD188R71H182MA01# |
|        |               |         | 2200pF             | ±10%               | GCD188R71H222KA01# |
|        |               |         |                    | ±20%               | GCD188R71H222MA01# |
|        |               |         | 2700pF             | ±10%               | GCD188R71H272KA01# |
|        |               |         |                    | ±20%               | GCD188R71H272MA01# |
|        |               |         | 3300pF             | ±10%               | GCD188R71H332KA01# |
|        |               |         |                    | ±20%               | GCD188R71H332MA01# |
| 3900pF |               |         | ±10%               | GCD188R71H392KA01# |                    |
|        |               |         | ±20%               | GCD188R71H392MA01# |                    |
| 4700pF |               |         | ±10%               | GCD188R71H472KA01# |                    |
|        |               |         | ±20%               | GCD188R71H472MA01# |                    |

| T max. | Rated Voltage | TC Code | Cap.               | Tol. | Part Number        |
|--------|---------------|---------|--------------------|------|--------------------|
| 0.9mm  | 50Vdc         | X7R     | 5600pF             | ±10% | GCD188R71H562KA01# |
|        |               |         |                    | ±20% | GCD188R71H562MA01# |
|        |               |         | 6800pF             | ±10% | GCD188R71H682KA01# |
|        |               |         |                    | ±20% | GCD188R71H682MA01# |
|        |               |         | 8200pF             | ±10% | GCD188R71H822KA01# |
|        |               |         |                    | ±20% | GCD188R71H822MA01# |
|        |               |         | 10000pF            | ±10% | GCD188R71H103KA01# |
|        |               |         |                    | ±20% | GCD188R71H103MA01# |
|        |               |         | 12000pF            | ±10% | GCD188R71H123KA01# |
|        |               |         |                    | ±20% | GCD188R71H123MA01# |
|        |               |         | 15000pF            | ±10% | GCD188R71H153KA01# |
|        |               |         |                    | ±20% | GCD188R71H153MA01# |
|        | 18000pF       | ±10%    | GCD188R71H183KA01# |      |                    |
|        |               | ±20%    | GCD188R71H183MA01# |      |                    |
|        | 22000pF       | ±10%    | GCD188R71H223KA01# |      |                    |
|        |               | ±20%    | GCD188R71H223MA01# |      |                    |
|        | 25Vdc         | X7R     | 27000pF            | ±10% | GCD188R71E273KA01# |
|        |               |         |                    | ±20% | GCD188R71E273MA01# |
|        |               |         | 33000pF            | ±10% | GCD188R71E333KA01# |
|        |               |         |                    | ±20% | GCD188R71E333MA01# |
|        |               |         | 39000pF            | ±10% | GCD188R71E393KA01# |
|        |               |         |                    | ±20% | GCD188R71E393MA01# |
|        |               |         | 47000pF            | ±10% | GCD188R71E473KA01# |
|        |               |         |                    | ±20% | GCD188R71E473MA01# |

## 2.0×1.25mm

| T max.  | Rated Voltage | TC Code | Cap.               | Tol.               | Part Number        |
|---------|---------------|---------|--------------------|--------------------|--------------------|
| 1.4mm   | 100Vdc        | X7R     | 27000pF            | ±10%               | GCD21BR72A273KA01# |
|         |               |         |                    | ±20%               | GCD21BR72A273MA01# |
|         |               |         | 33000pF            | ±10%               | GCD21BR72A333KA01# |
|         |               |         |                    | ±20%               | GCD21BR72A333MA01# |
|         |               |         | 39000pF            | ±10%               | GCD21BR72A393KA01# |
|         |               |         |                    | ±20%               | GCD21BR72A393MA01# |
|         |               |         | 47000pF            | ±10%               | GCD21BR72A473KA01# |
|         |               |         |                    | ±20%               | GCD21BR72A473MA01# |
|         |               |         | 56000pF            | ±10%               | GCD21BR72A563KA01# |
|         |               |         |                    | ±20%               | GCD21BR72A563MA01# |
|         |               |         | 68000pF            | ±10%               | GCD21BR72A683KA01# |
|         |               |         |                    | ±20%               | GCD21BR72A683MA01# |
|         | 82000pF       | ±10%    | GCD21BR72A823KA01# |                    |                    |
|         |               | ±20%    | GCD21BR72A823MA01# |                    |                    |
|         | 0.10μF        | ±10%    | GCD21BR72A104KA01# |                    |                    |
|         |               | ±20%    | GCD21BR72A104MA01# |                    |                    |
|         | 50Vdc         | X7R     | 27000pF            | ±10%               | GCD21BR71H273KA01# |
|         |               |         |                    | ±20%               | GCD21BR71H273MA01# |
|         |               |         | 33000pF            | ±10%               | GCD21BR71H333KA01# |
|         |               |         |                    | ±20%               | GCD21BR71H333MA01# |
|         |               |         | 39000pF            | ±10%               | GCD21BR71H393KA01# |
|         |               |         |                    | ±20%               | GCD21BR71H393MA01# |
|         |               |         | 47000pF            | ±10%               | GCD21BR71H473KA01# |
|         |               |         |                    | ±20%               | GCD21BR71H473MA01# |
| 56000pF |               |         | ±10%               | GCD21BR71H563KA01# |                    |

Part number # indicates the package specification code.

GRT Series  
 GCM Series  
 GC3 Series  
 GCJ Series  
 GCQ Series  
 GCD Series  
 GCE Series  
 NMF Series  
 KCM Series  
 KC3 Series  
 KCA Series  
 GCB Series  
 GCG Series  
 ⚠Caution /Notice

# GCD Series High Dielectric Constant Type Part Number List

(→ 2.0×1.25mm)

| T max. | Rated Voltage | TC Code | Cap.               | Tol.               | Part Number        |
|--------|---------------|---------|--------------------|--------------------|--------------------|
| 1.4mm  | 50Vdc         | X7R     | 56000pF            | ±20%               | GCD21BR71H563MA01# |
|        |               |         |                    | ±10%               | GCD21BR71H683KA01# |
|        |               |         | 68000pF            | ±20%               | GCD21BR71H683MA01# |
|        |               |         |                    | ±10%               | GCD21BR71H823KA01# |
|        |               |         | 82000pF            | ±20%               | GCD21BR71H823MA01# |
|        |               |         |                    | ±10%               | GCD21BR71H104KA01# |
|        | 0.10μF        | ±10%    | GCD21BR71H104MA01# |                    |                    |
|        |               | ±20%    | GCD21BR71H104MA01# |                    |                    |
| 16Vdc  | X7S           | 0.47μF  | ±10%               | GCD21BC71C474KE01# |                    |

- GRT Series
- GCM Series
- GC3 Series
- GCJ Series
- GCQ Series
- GCD Series**
- GCE Series
- NMF Series
- KCM Series
- KC3 Series
- KCA Series
- GCB Series
- GCG Series
- ⚠Caution /Notice

Part number # indicates the package specification code.

Soft Termination MLSC Design Chip Multilayer Ceramic Capacitors for Automotive

**GCE Series**



**Further improved safety performance with a combination of a 2-element array structure & resin external electrodes!**

Features

① **Avoid instantaneous dielectric breakdown with the 2-element array structure**

This product is configured with 2 elements arranged in one capacitor. Even if one element short circuits, the other element in the capacitor does not short.

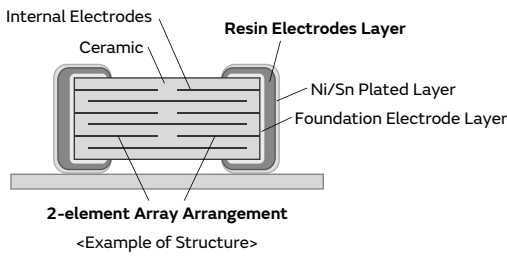

② **Provides additional safety performance in combination with resin electrodes**

Adopting resin electrodes as the external electrodes will suppress the occurrence of cracking in the capacitor by mechanical stress.

● For Automotive (GCM Series)

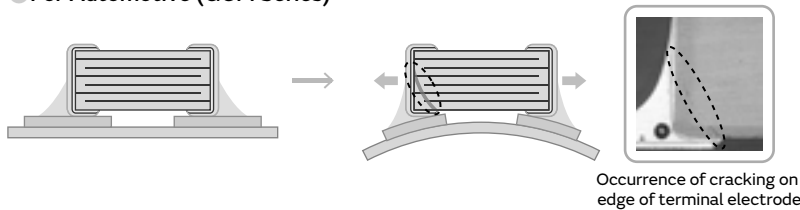

● Fail Safe Design (GCE Series)

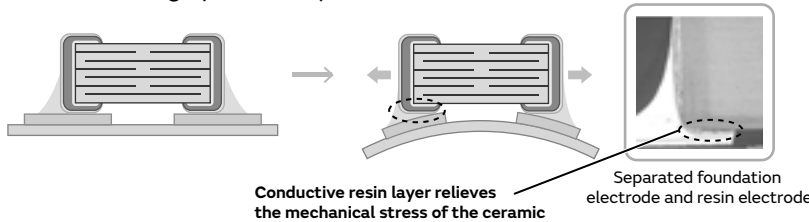

Note: Cracks may occur in the capacitor body if excessive stress beyond the "guaranteed range of board bending strength (\*)" provided in the specifications is applied. Capacitors with cracks in them may cause a drop in insulation resistance, which could lead to a short circuit.  
 (\*) For details on the guaranteed range of board bending strength, check the "Detailed Specification Sheet" on the Product Details Page.

③ **Ideal for battery lines of on-board applications**

Space can be reduced for battery lines, when 2 capacitors are configured in an array.

Specifications

|                   |   |
|-------------------|---|
| Size              | 1.6×0.8mm to 2.0×1.25mm                     |
| Rated Voltage     | 25Vdc to 100Vdc                             |
| Capacitance       | 1000pF to 0.10μF                            |
| Main Applications | For automotive, Battery lines, power trains |

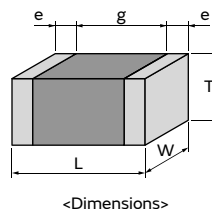

GRT Series  
 GCM Series  
 GC3 Series  
 GCJ Series  
 GCQ Series  
 GCD Series  
 GCE Series  
 NMF Series  
 KCM Series  
 KC3 Series  
 KCA Series  
 GCB Series  
 GCG Series  
 ⚠Caution /Notice

# GCE Series High Dielectric Constant Type Part Number List

## 1.6×0.8mm

| T max. | Rated Voltage | TC Code | Cap.               | Tol.               | Part Number        |
|--------|---------------|---------|--------------------|--------------------|--------------------|
| 0.9mm  | 100Vdc        | X7R     | 1000pF             | ±10%               | GCE188R72A102KA01# |
|        |               |         |                    | ±20%               | GCE188R72A102MA01# |
|        |               |         | 1200pF             | ±10%               | GCE188R72A122KA01# |
|        |               |         |                    | ±20%               | GCE188R72A122MA01# |
|        |               |         | 1500pF             | ±10%               | GCE188R72A152KA01# |
|        |               |         |                    | ±20%               | GCE188R72A152MA01# |
|        |               |         | 1800pF             | ±10%               | GCE188R72A182KA01# |
|        |               |         |                    | ±20%               | GCE188R72A182MA01# |
|        |               |         | 2200pF             | ±10%               | GCE188R72A222KA01# |
|        |               |         |                    | ±20%               | GCE188R72A222MA01# |
|        |               |         | 2700pF             | ±10%               | GCE188R72A272KA01# |
|        |               |         |                    | ±20%               | GCE188R72A272MA01# |
|        |               |         | 3300pF             | ±10%               | GCE188R72A332KA01# |
|        |               |         |                    | ±20%               | GCE188R72A332MA01# |
|        |               |         | 3900pF             | ±10%               | GCE188R72A392KA01# |
|        |               |         |                    | ±20%               | GCE188R72A392MA01# |
|        |               |         | 4700pF             | ±10%               | GCE188R72A472KA01# |
|        |               |         |                    | ±20%               | GCE188R72A472MA01# |
|        |               |         | 5600pF             | ±10%               | GCE188R72A562KA01# |
|        |               |         |                    | ±20%               | GCE188R72A562MA01# |
|        |               |         | 6800pF             | ±10%               | GCE188R72A682KA01# |
|        |               |         |                    | ±20%               | GCE188R72A682MA01# |
|        |               |         | 8200pF             | ±10%               | GCE188R72A822KA01# |
|        |               |         |                    | ±20%               | GCE188R72A822MA01# |
|        | 10000pF       | ±10%    | GCE188R72A103KA01# |                    |                    |
|        |               | ±20%    | GCE188R72A103MA01# |                    |                    |
|        | 12000pF       | ±10%    | GCE188R72A123KA01# |                    |                    |
|        |               | ±20%    | GCE188R72A123MA01# |                    |                    |
|        | 15000pF       | ±10%    | GCE188R72A153KA01# |                    |                    |
|        |               | ±20%    | GCE188R72A153MA01# |                    |                    |
|        | 18000pF       | ±10%    | GCE188R72A183KA01# |                    |                    |
|        |               | ±20%    | GCE188R72A183MA01# |                    |                    |
|        | 22000pF       | ±10%    | GCE188R72A223KA01# |                    |                    |
|        |               | ±20%    | GCE188R72A223MA01# |                    |                    |
|        | 50Vdc         | X7R     | 1000pF             | ±10%               | GCE188R71H102KA01# |
|        |               |         |                    | ±20%               | GCE188R71H102MA01# |
|        |               |         | 1200pF             | ±10%               | GCE188R71H122KA01# |
|        |               |         |                    | ±20%               | GCE188R71H122MA01# |
|        |               |         | 1500pF             | ±10%               | GCE188R71H152KA01# |
|        |               |         |                    | ±20%               | GCE188R71H152MA01# |
|        |               |         | 1800pF             | ±10%               | GCE188R71H182KA01# |
|        |               |         |                    | ±20%               | GCE188R71H182MA01# |
|        |               |         | 2200pF             | ±10%               | GCE188R71H222KA01# |
|        |               |         |                    | ±20%               | GCE188R71H222MA01# |
|        |               |         | 2700pF             | ±10%               | GCE188R71H272KA01# |
|        |               |         |                    | ±20%               | GCE188R71H272MA01# |
|        |               |         | 3300pF             | ±10%               | GCE188R71H332KA01# |
|        |               |         |                    | ±20%               | GCE188R71H332MA01# |
| 3900pF |               |         | ±10%               | GCE188R71H392KA01# |                    |
|        |               |         | ±20%               | GCE188R71H392MA01# |                    |
| 4700pF |               |         | ±10%               | GCE188R71H472KA01# |                    |
|        |               |         | ±20%               | GCE188R71H472MA01# |                    |

| T max. | Rated Voltage | TC Code | Cap.               | Tol. | Part Number        |
|--------|---------------|---------|--------------------|------|--------------------|
| 0.9mm  | 50Vdc         | X7R     | 5600pF             | ±10% | GCE188R71H562KA01# |
|        |               |         |                    | ±20% | GCE188R71H562MA01# |
|        |               |         | 6800pF             | ±10% | GCE188R71H682KA01# |
|        |               |         |                    | ±20% | GCE188R71H682MA01# |
|        |               |         | 8200pF             | ±10% | GCE188R71H822KA01# |
|        |               |         |                    | ±20% | GCE188R71H822MA01# |
|        |               |         | 10000pF            | ±10% | GCE188R71H103KA01# |
|        |               |         |                    | ±20% | GCE188R71H103MA01# |
|        |               |         | 12000pF            | ±10% | GCE188R71H123KA01# |
|        |               |         |                    | ±20% | GCE188R71H123MA01# |
|        |               |         | 15000pF            | ±10% | GCE188R71H153KA01# |
|        |               |         |                    | ±20% | GCE188R71H153MA01# |
|        | 18000pF       | ±10%    | GCE188R71H183KA01# |      |                    |
|        |               | ±20%    | GCE188R71H183MA01# |      |                    |
|        | 22000pF       | ±10%    | GCE188R71H223KA01# |      |                    |
|        |               | ±20%    | GCE188R71H223MA01# |      |                    |
|        | 25Vdc         | X7R     | 27000pF            | ±10% | GCE188R71E273KA01# |
|        |               |         |                    | ±20% | GCE188R71E273MA01# |
|        |               |         | 33000pF            | ±10% | GCE188R71E333KA01# |
|        |               |         |                    | ±20% | GCE188R71E333MA01# |
|        |               |         | 39000pF            | ±10% | GCE188R71E393KA01# |
|        |               |         |                    | ±20% | GCE188R71E393MA01# |
|        |               |         | 47000pF            | ±10% | GCE188R71E473KA01# |
|        |               |         |                    | ±20% | GCE188R71E473MA01# |

## 2.0×1.25mm

| T max.  | Rated Voltage | TC Code | Cap.               | Tol.               | Part Number        |
|---------|---------------|---------|--------------------|--------------------|--------------------|
| 1.45mm  | 100Vdc        | X7R     | 27000pF            | ±10%               | GCE21BR72A273KA01# |
|         |               |         |                    | ±20%               | GCE21BR72A273MA01# |
|         |               |         | 33000pF            | ±10%               | GCE21BR72A333KA01# |
|         |               |         |                    | ±20%               | GCE21BR72A333MA01# |
|         |               |         | 39000pF            | ±10%               | GCE21BR72A393KA01# |
|         |               |         |                    | ±20%               | GCE21BR72A393MA01# |
|         |               |         | 47000pF            | ±10%               | GCE21BR72A473KA01# |
|         |               |         |                    | ±20%               | GCE21BR72A473MA01# |
|         |               |         | 56000pF            | ±10%               | GCE21BR72A563KA01# |
|         |               |         |                    | ±20%               | GCE21BR72A563MA01# |
|         |               |         | 68000pF            | ±10%               | GCE21BR72A683KA01# |
|         |               |         |                    | ±20%               | GCE21BR72A683MA01# |
|         | 82000pF       | ±10%    | GCE21BR72A823KA01# |                    |                    |
|         |               | ±20%    | GCE21BR72A823MA01# |                    |                    |
|         | 0.10µF        | ±10%    | GCE21BR72A104KA01# |                    |                    |
|         |               | ±20%    | GCE21BR72A104MA01# |                    |                    |
|         | 50Vdc         | X7R     | 27000pF            | ±10%               | GCE21BR71H273KA01# |
|         |               |         |                    | ±20%               | GCE21BR71H273MA01# |
|         |               |         | 33000pF            | ±10%               | GCE21BR71H333KA01# |
|         |               |         |                    | ±20%               | GCE21BR71H333MA01# |
|         |               |         | 39000pF            | ±10%               | GCE21BR71H393KA01# |
|         |               |         |                    | ±20%               | GCE21BR71H393MA01# |
|         |               |         | 47000pF            | ±10%               | GCE21BR71H473KA01# |
|         |               |         |                    | ±20%               | GCE21BR71H473MA01# |
| 56000pF |               |         | ±10%               | GCE21BR71H563KA01# |                    |

Part number # indicates the package specification code.

GRT Series  
 GCM Series  
 GC3 Series  
 GCJ Series  
 GCQ Series  
 GCD Series  
 GCE Series  
 NMF Series  
 KCM Series  
 KC3 Series  
 KCA Series  
 GCB Series  
 GCG Series  
 ⚠Caution / Notice

# GCE Series High Dielectric Constant Type Part Number List

(→ 2.0×1.25mm)

| T max. | Rated Voltage | TC Code | Cap.    | Tol. | Part Number        |
|--------|---------------|---------|---------|------|--------------------|
| 1.45mm | 50Vdc         | X7R     | 56000pF | ±20% | GCE21BR71H563MA01# |
|        |               |         |         | ±10% | GCE21BR71H683KA01# |
|        |               |         | 68000pF | ±20% | GCE21BR71H683MA01# |
|        |               |         |         | ±10% | GCE21BR71H823KA01# |
|        |               |         | 82000pF | ±20% | GCE21BR71H823MA01# |
|        |               |         |         | ±10% | GCE21BR71H104KA01# |
|        |               |         | 0.10μF  | ±10% | GCE21BR71H104MA01# |
|        |               |         |         | ±20% | GCE21BR71H104MA01# |

- GRT Series
- GCM Series
- GC3 Series
- GCJ Series
- GCQ Series
- GCD Series
- GCE Series**
- NMF Series
- KCM Series
- KC3 Series
- KCA Series
- GCB Series
- GCG Series
- ⚠Caution /Notice

3 Terminals Low ESL Chip Multilayer Ceramic Capacitors for Automotive

**NFM Series**      

This is the most suitable Low ESL capacitors for noise measurement and power decoupling of power train and safety equipment.

Features

① Low ESL

Since the equivalent series inductance (ESL) is low and excellent in high frequency characteristics, this capacitor is suitable for power supply decoupling of high-speed operation electronic equipment.

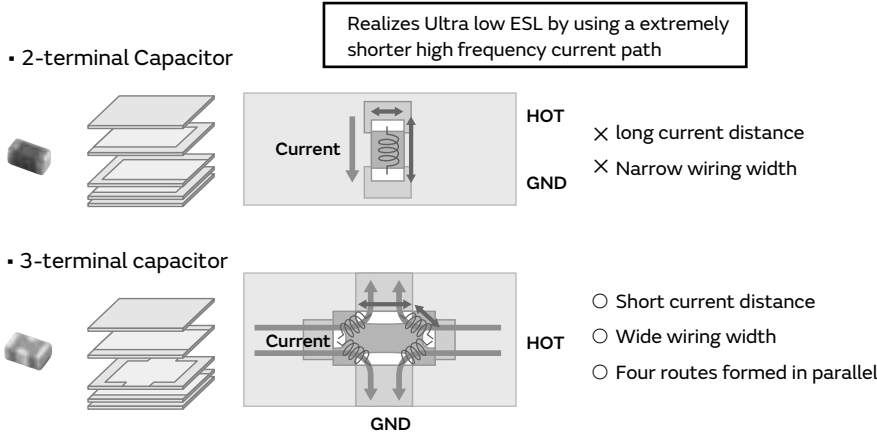

② Contributes to a reduction in the number of components.

The number of components can be reduced by using low ESL capacitors, while maintaining functions equivalent to 2-terminal capacitor.

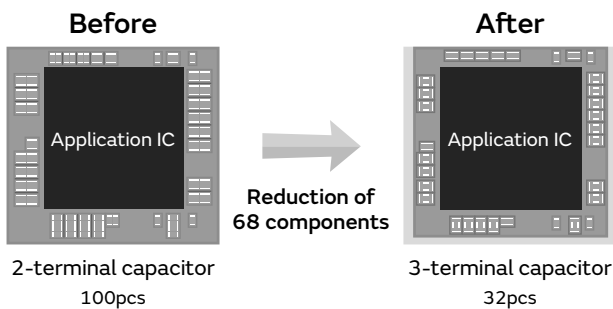

Reference: "How can the mounting area be reduced? — Methods of using low-ESL capacitors —" 

③ Contributes to noise suppression

Example of noise suppression effect 

Reference: "Basics of Noise CountermeasuresLesson 11 Notes on the Use of Chip 3-Terminal Capacitors" 

④ Compliance with AEC-Q200

Use of 3-terminal low-ESL chip multilayer ceramic capacitors to decouple processor power supplies has recently surged in the automotive market due to demand for high performance processors and smaller electronics. This has accompanied the increase in high-functioning multitasking onboard equipment such as advanced driver assistance systems (ADAS), preventative safety systems for automated vehicles, and in-vehicle infotainment (IVI) systems.

GRT Series  
 GCM Series  
 GC3 Series  
 GCJ Series  
 GCQ Series  
 GCD Series  
 GCE Series  
 NFM Series  
 KCM Series  
 KC3 Series  
 KCA Series  
 GCB Series  
 GCG Series  
 ⚠Caution /Notice



## Specifications

|                   |   |
|-------------------|---|
| Size              | 1.6×0.8mm to 3.2×1.6mm                      |
| Rated Voltage     | 6.3Vdc to 100Vdc                            |
| Capacitance       | 220pF to 1.0μF                              |
| Main Applications | ADAS processor, Camera sensor, Radar, Lidar |

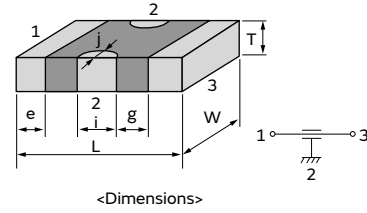

- GRT Series
- GCM Series
- GC3 Series
- GCJ Series
- GCQ Series
- GCD Series
- GCE Series
- NMF Series
- KCM Series
- KC3 Series
- KCA Series
- GCB Series
- GCG Series
- ⚠Caution /Notice

**NFM Series**     **Part Number List**

**1.6×0.8mm**

| T max. | Rated Voltage | Cap.  | Tol. | Part Number            |  |
|--------|---------------|-------|------|------------------------|--|
| 0.7mm  | 16Vdc         | 1.0μF | ±20% | <b>NFM18HC105C1C3#</b> |  |
|        | 6.3Vdc        | 1.0μF | ±20% | <b>NFM18HC105C0J3#</b> |  |

**2.0×1.25mm**

| T max. | Rated Voltage | Cap.    | Tol.   | Part Number            |                        |  |
|--------|---------------|---------|--------|------------------------|------------------------|--|
| 0.95mm | 50Vdc         | 220pF   | ±20%   | <b>NFM21HC221R1H3#</b> |                        |  |
|        |               | 470pF   | ±20%   | <b>NFM21HC471R1H3#</b> |                        |  |
|        |               | 1000pF  | ±20%   | <b>NFM21HC102R1H3#</b> |                        |  |
|        |               | 2200pF  | ±20%   | <b>NFM21HC222R1H3#</b> |                        |  |
|        |               | 22000pF | ±20%   | <b>NFM21HC223R1H3#</b> |                        |  |
|        | 16Vdc         | 1.0μF   | ±20%   | <b>NFM21HC105R1C3#</b> |                        |  |
|        |               | 10Vdc   | 0.10μF | ±20%                   | <b>NFM21HC104R1A3#</b> |  |
|        |               |         | 0.22μF | ±20%                   | <b>NFM21HC224R1A3#</b> |  |
|        |               |         | 0.47μF | ±20%                   | <b>NFM21HC474R1A3#</b> |  |

**3.2×1.6mm**

| T max. | Rated Voltage | Cap.    | Tol. | Part Number            |           |
|--------|---------------|---------|------|------------------------|-----------|
| 1.5mm  | 100Vdc        | 10000pF | ±20% | <b>NFM31HK103R2A3#</b> | <b>D3</b> |
|        | 50Vdc         | 10000pF | ±20% | <b>NFM31HK103R1H3#</b> | <b>D3</b> |
|        |               | 15000pF | ±20% | <b>NFM31HK153R1H3#</b> | <b>D3</b> |
|        |               | 22000pF | ±20% | <b>NFM31HK223R1H3#</b> | <b>D3</b> |
|        |               | 0.10μF  | ±20% | <b>NFM31HK104R1H3#</b> |           |

GRT Series  
 GCM Series  
 GC3 Series  
 GCJ Series  
 GCQ Series  
 GCD Series  
 GCE Series  
 NFM Series  
 KCM Series  
 KC3 Series  
 KCA Series  
 GCB Series  
 GCG Series  
 ⚠Caution /Notice

Metal Terminal Type Multilayer Ceramic Capacitors for Automotive

KCM Series



**Bonding the metal terminals to external electrodes solves design issues by mounting large size MLCC!**

Features

① **Bond metal terminals to the external electrodes of chips.**

The stress applied to the chip is relieved by the elastic action of the metal terminal.

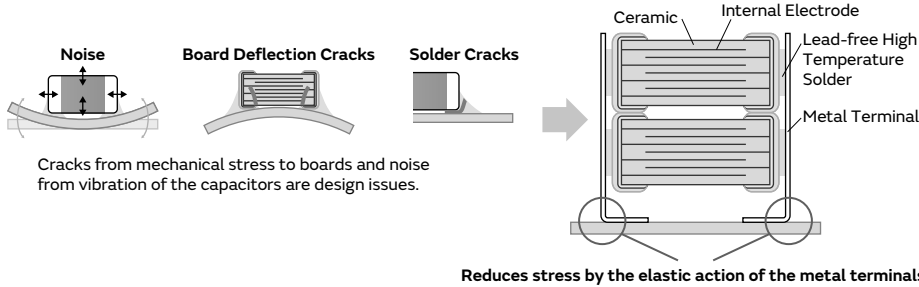

② **Substantially reduces noise, board deflection cracks and soldering cracks.**

This product is not damaged even with a board deflection of 6 mm.  
 Solder cracks do not occur even with 2,000 cycles of heat stress.

● **Comparison of Noise Reduction Effects**

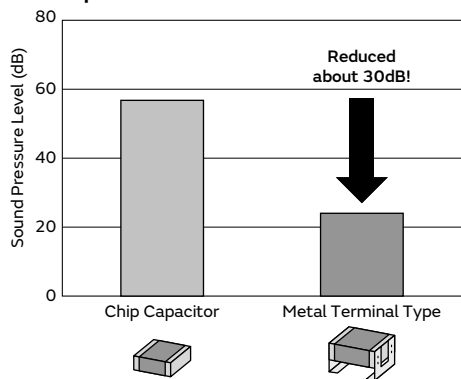

Evaluation Items: 5750 (in mm)/2220 (in inch) size/DC630V/220nF  
 Test Method: DC50V, AC10Vp-p/3kHz  
 Test Board: Glass Epoxy Board (T=1.6mm)  
 Test Quantity: 3pc  
 Distance Between Microphone and Board: 5mm

Note: Results Using Murata's Evaluation Board

● **Reduces Stress Caused by Board Deflection**

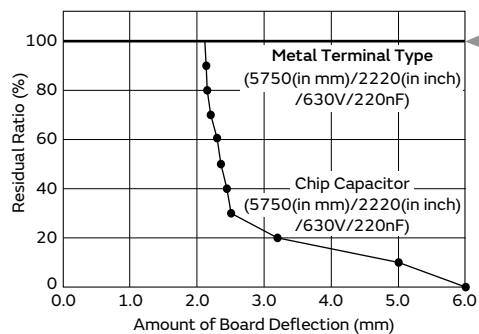

No damage, even with 6 mm board deflection!!

● **Suppresses Solder Cracks Caused by Heat Stress**

| Chip Size   | Chip Only<br>(5750 (in mm)/2220 (in inch) size) |  | Metal Terminal Type<br>(5750 (in mm)/2220 (in inch) size) |  |
|-------------|---|--|---|--|
| 1000 Cycles |   |  |   |  |
| 2000 Cycles |   |  |   |  |

Compared with chips only, this product is excellent in solder cracking resistance.

Test Condition: -55 to +125°C, 5min., (Liquid Phase)  
 Board Used: Glass Epoxy Board (FR-4)

③ **2 chips can be stacked.**

Realize large capacity by stacking 2 capacitors.

**Specifications**

|                   |  |
|-------------------|--|
| Size              | 6.1×5.1mm to 6.1×5.3mm   |
| Rated Voltage     | 25Vdc to 1000Vdc   |
| Capacitance       | 8200pF to 100μF  |
| Main Applications | For drive system control of engine ECU<br>For other drive system controls and safety devices |

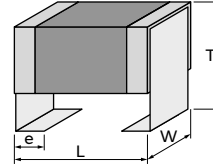

<Dimensions>

GRT Series

GCM Series

GC3 Series

GCJ Series

GCQ Series

GCD Series

GCE Series

NMF Series

KCM Series

KC3 Series

KCA Series

GCB Series

GCG Series

⚠Caution /Notice

# KCM Series Temperature Compensating Type **Power-train** **AEC-Q200** **Anti-noise** **Deflecting crack** **Soldering crack** Part Number List

## 6.1×5.1mm

| T max.  | Rated Voltage | TC Code            | Cap.    | Tol.    | Part Number        |
|---------|---------------|--------------------|---------|---------|--------------------|
| 3.1mm   | 1000Vdc       | U2J                | 8200pF  | ±5%     | KCM55L7U3A822JDL1# |
|         |               |                    | 10000pF | ±5%     | KCM55L7U3A103JDL1# |
|         | 630Vdc        | COG                | 0.015μF | ±5%     | KCM55L5C2J153JDL1# |
|         |               |                    | 0.018μF | ±5%     | KCM55L5C2J183JDL1# |
|         |               | U2J                | 33000pF | ±5%     | KCM55L7U2J333JDL1# |
|         |               |                    | 39000pF | ±5%     | KCM55L7U2J393JDL1# |
| 47000pF | ±5%           | KCM55L7U2J473JDL1# |         |         |                    |
|         | 3.9mm         | 630Vdc             | COG     | 0.022μF | ±5%                |
| 0.027μF |               |                    |         | ±5%     | KCM55R5C2J273JDL1# |
| 5.1mm   | 1000Vdc       | U2J                | 0.016μF | ±10%    | KCM55T7U3A163KDL1# |
|         |               |                    | 0.020μF | ±10%    | KCM55T7U3A203KDL1# |
|         | 630Vdc        | COG                | 0.030μF | ±5%     | KCM55T5C2J303JDL1# |
|         |               |                    | 0.036μF | ±5%     | KCM55T5C2J363JDL1# |
|         |               | U2J                | 66000pF | ±10%    | KCM55T7U2J663KDL1# |
|         |               |                    | 78000pF | ±10%    | KCM55T7U2J783KDL1# |
| 94000pF | ±10%          | KCM55T7U2J943KDL1# |         |         |                    |
| 6.6mm   | 630Vdc        | COG                | 0.044μF | ±5%     | KCM55V5C2J443JDL2# |
|         |               |                    | 0.054μF | ±5%     | KCM55V5C2J543JDL2# |

GRT Series  
 GCM Series  
 GC3 Series  
 GCJ Series  
 GCQ Series  
 GCD Series  
 GCE Series  
 NMF Series  
**KCM Series**  
 KC3 Series  
 KCA Series  
 GCB Series  
 GCG Series  
 ⚠Caution /Notice

# KCM Series High Dielectric Constant Type Power-train AEC-Q200 Anti-noise Deflecting crack Soldering crack Part Number List

## 6.1×5.3mm

| T max. | Rated Voltage | TC Code | Cap.  | Tol.               | Part Number        |
|--------|---------------|---------|-------|--------------------|--------------------|
| 3.0mm  | 100Vdc        | X7R     | 4.7μF | ±10%               | KCM55LR72A475KH01# |
|        | 63Vdc         | X7R     | 4.7μF | ±10%               | KCM55LR71J475KH01# |
|        | 50Vdc         | X7R     | 4.7μF | ±10%               | KCM55LR71H475KH01# |
|        |               |         | 10μF  | ±10%               | KCM55LR71H106KH01# |
|        | 35Vdc         | X7R     | 10μF  | ±10%               | KCM55LR7YA106KH01# |
|        |               |         | 15μF  | ±10%               | KCM55LR7YA156KH01# |
| 25Vdc  | X7R           | 15μF    | ±10%  | KCM55LR71E156KH01# |                    |
| 3.9mm  | 100Vdc        | X7R     | 6.8μF | ±10%               | KCM55QR72A685KH01# |
|        |               |         | 10μF  | ±10%               | KCM55QR72A106KH01# |
|        | 63Vdc         | X7R     | 10μF  | ±10%               | KCM55QR71J106KH01# |
|        |               |         | 10μF  | ±10%               | KCM55QR71H106KH01# |
|        | 50Vdc         | X7R     | 10μF  | ±10%               | KCM55QR71H106KH01# |
|        |               |         | 17μF  | ±10%               | KCM55QR71H176KH01# |
|        | 35Vdc         | X7R     | 17μF  | ±10%               | KCM55QR7YA176KH01# |
|        |               |         | 22μF  | ±10%               | KCM55QR7YA226KH01# |
|        | 25Vdc         | X7R     | 22μF  | ±10%               | KCM55QR71E226KH01# |
|        |               |         | 33μF  | ±10%               | KCM55QR71E336KH01# |
| X7S    |               | 47μF    | ±10%  | KCM55QC71E476KH13# |                    |
| 5.0mm  | 100Vdc        | X7R     | 10μF  | ±20%               | KCM55TR72A106MH01# |
|        | 50Vdc         | X7R     | 22μF  | ±20%               | KCM55TR71H226MH01# |
|        | 35Vdc         | X7R     | 22μF  | ±20%               | KCM55TR7YA226MH01# |
|        |               |         | 33μF  | ±20%               | KCM55TR7YA336MH01# |
|        | 25Vdc         | X7R     | 33μF  | ±20%               | KCM55TR71E336MH01# |
| 6.7mm  | 100Vdc        | X7R     | 15μF  | ±20%               | KCM55WR72A156MH01# |
|        |               |         | 22μF  | ±20%               | KCM55WR72A226MH01# |
|        | 63Vdc         | X7R     | 22μF  | ±20%               | KCM55WR71J226MH01# |
|        |               |         | 22μF  | ±20%               | KCM55WR71H226MH01# |
|        | 50Vdc         | X7R     | 22μF  | ±20%               | KCM55WR71H226MH01# |
|        |               |         | 33μF  | ±20%               | KCM55WR71H336MH01# |
|        | 35Vdc         | X7R     | 33μF  | ±20%               | KCM55WR7YA336MH01# |
|        |               |         | 47μF  | ±20%               | KCM55WR7YA476MH01# |
|        | 25Vdc         | X7R     | 47μF  | ±20%               | KCM55WR71E476MH01# |
| 68μF   |               |         | ±20%  | KCM55WR71E686MH01# |                    |
| X7S    |               | 100μF   | ±20%  | KCM55WC71E107MH13# |                    |

GRT Series  
 GCM Series  
 GC3 Series  
 GCJ Series  
 GCQ Series  
 GCD Series  
 GCE Series  
 NMF Series  
 KCM Series  
 KC3 Series  
 KCA Series  
 GCB Series  
 GCG Series  
 ⚠Caution /Notice

High Effective Capacitance & High Allowable Ripple Current Metal Terminal Type Multilayer Ceramic Capacitors for Automotive

# KC3 Series



**Bonding the metal terminals to external electrodes solves design issues by mounting large size MLCC!**

## Features

### 1 Bond Metal Terminals to External Electrodes of Chips

This product has high resistance to heat and mechanical impact and greatly reduces acoustic noise of boards by ceramics.

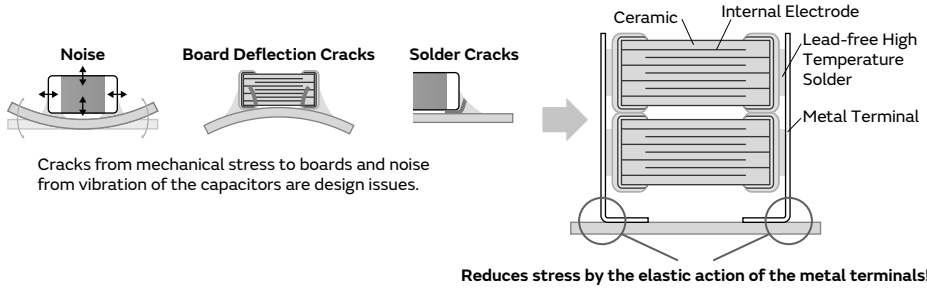

### 2 Stacking of Chips

Achieve high capacity by stacking 2 capacitors.

#### Comparison of Noise Reduction Effects

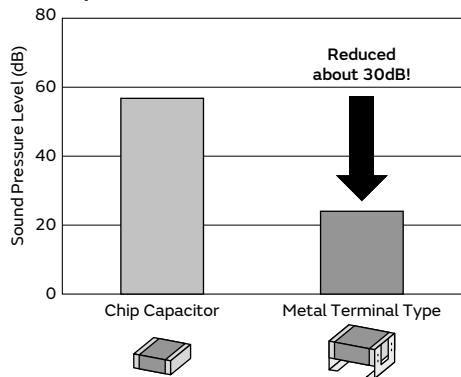

Evaluation Items: 5750 (in mm)/2220 (in inch) size/DC630V/220nF  
 Test Method: DC50V, AC10Vp-p/3kHz  
 Test Board: Glass Epoxy Board (T=1.6mm)  
 Test Quantity: 3pc  
 Distance Between Microphone and Board: 5mm

Note: Results Using Murata's Evaluation Board

#### Reduces Stress Caused by Board Deflection

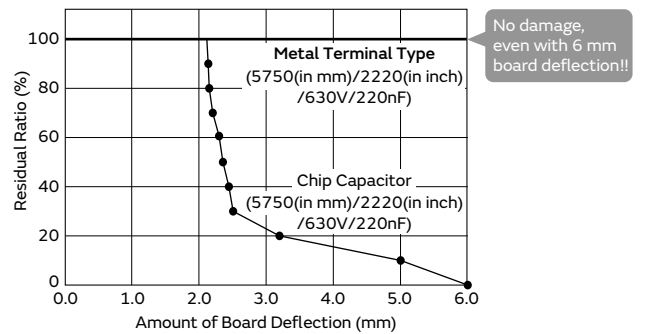

#### Suppresses Solder Cracks Caused by Heat Stress

| Chip Size   | Chip Only<br>(5750 (in mm)/2220 (in inch) size) |  | Metal Terminal Type<br>(5750 (in mm)/2220 (in inch) size) |  |
|-------------|---|--|---|--|
| 1000 Cycles |   |  |   |  |
| 2000 Cycles |   |  |   |  |

Compared with chips only, this product is excellent in solder cracking resistance.

Test Condition: -55 to +125°C, 5min., (Liquid Phase)  
 Board Used: Glass Epoxy Board (FR-4)

### 3 Adopted Low Dielectric Constant Materials

Improved effective capacity and ripple resistant performance, compared to conventional products (X7R characteristics).

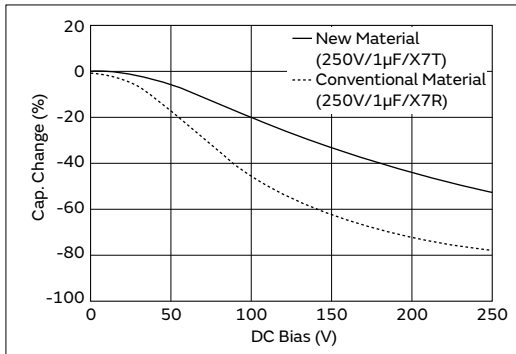

### 4 2 chips can be stacked

Realize large capacity by stacking 2 capacitors.

### Specifications

|                   |  |
|-------------------|--|
| Size              | 6.1×5.3mm  |
| Rated Voltage     | 250Vdc to 630Vdc   |
| Capacitance       | 0.10µF to 2.2µF  |
| Main Applications | For drive system control of engine ECU<br>For other drive system controls and safety devices |

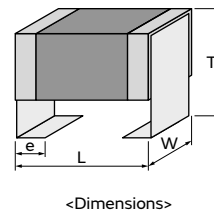

GRT Series  
 GCM Series  
 GC3 Series  
 GCJ Series  
 GCQ Series  
 GCD Series  
 GCE Series  
 NMF Series  
 KCM Series  
 KC3 Series  
 KCA Series  
 GCB Series  
 GCG Series  
 ⚠Caution /Notice



# KC3 Series High Dielectric Constant Type **Power-train** **AEC-Q200** **Anti-noise** **Deflecting crack** **Soldering crack** Part Number List

## 6.1×5.3mm

| T max. | Rated Voltage | TC Code | Cap.   | Tol. | Part Number        |           |
|--------|---------------|---------|--------|------|--------------------|-----------|
| 3.0mm  | 630Vdc        | X7T     | 0.10μF | ±10% | KC355LD72J104KH01# |           |
|        |               |         | 0.15μF | ±10% | KC355LD72J154KH01# |           |
|        |               |         | 0.33μF | ±10% | KC355LD7LQ334KV01# | <b>D2</b> |
|        |               |         | 0.47μF | ±10% | KC355LD7LQ474KV01# | <b>D2</b> |
|        | 450Vdc        | X7T     | 0.22μF | ±10% | KC355LD72W224KH01# |           |
|        |               |         | 0.33μF | ±10% | KC355LD72W334KH01# |           |
|        |               |         | 0.47μF | ±10% | KC355LD72W474KH01# |           |
|        |               |         | 0.68μF | ±10% | KC355LD7LP684KV01# | <b>D2</b> |
|        | 250Vdc        | X7T     | 0.47μF | ±10% | KC355LD72E474KH01# |           |
|        |               |         | 0.68μF | ±10% | KC355LD72E684KH01# |           |
| 3.9mm  | 630Vdc        | X7T     | 0.22μF | ±10% | KC355QD72J224KH01# |           |
|        |               |         | 0.27μF | ±10% | KC355QD72J274KH01# |           |
|        |               |         | 0.56μF | ±10% | KC355QD7LQ564KV01# | <b>D2</b> |
|        | 450Vdc        | X7T     | 0.56μF | ±10% | KC355QD72W564KH01# |           |
|        |               |         | 1.0μF  | ±10% | KC355QD7LP105KV01# | <b>D2</b> |
|        | 250Vdc        | X7T     | 1.0μF  | ±10% | KC355QD72E105KH01# |           |
|        |               |         |        |      |                    |           |
| 5.0mm  | 630Vdc        | X7T     | 0.68μF | ±20% | KC355TD7LQ684MV01# | <b>D2</b> |
|        |               |         | 1.0μF  | ±20% | KC355TD7LQ105MV01# | <b>D2</b> |
|        | 450Vdc        | X7T     | 0.68μF | ±20% | KC355TD72W684MH01# |           |
|        |               |         | 1.0μF  | ±20% | KC355TD72W105MH01# |           |
|        |               |         | 1.5μF  | ±20% | KC355TD7LP155MV01# | <b>D2</b> |
|        | 250Vdc        | X7T     | 1.5μF  | ±20% | KC355TD72E155MH01# |           |
|        |               |         |        |      |                    |           |
| 6.7mm  | 630Vdc        | X7T     | 0.47μF | ±20% | KC355WD72J474MH01# |           |
|        |               |         | 0.56μF | ±20% | KC355WD72J564MH01# |           |
|        |               |         | 1.2μF  | ±20% | KC355WD7LQ125MV01# | <b>D2</b> |
|        | 450Vdc        | X7T     | 1.2μF  | ±20% | KC355WD72W125MH01# |           |
|        |               |         | 2.2μF  | ±20% | KC355WD7LP225MV01# | <b>D2</b> |
|        | 250Vdc        | X7T     | 2.2μF  | ±20% | KC355WD72E225MH01# |           |

GRT Series  
 GCM Series  
 GC3 Series  
 GCJ Series  
 GCQ Series  
 GCD Series  
 GCE Series  
 NMF Series  
 KCM Series  
 KC3 Series  
 KCA Series  
 GCB Series  
 GCG Series  
 ⚠Caution /Notice

Safety Standard Certified Metal Terminal Type Multilayer Ceramic Capacitors for Automotive

**KCA Series**



**For Automotive IEC60384-14 X1/Y2 Class Certified Product (Basic insulation product)**

**Features**

**1 IEC60384-14 certified product: Rated voltage AC250V (r.m.s.).**

Please download Safety Standard Certification (Type MF: X1,Y2) from Web site.

**2 Best suitable for class Y2 capacitors.**

AC250V (r.m.s.)-rated voltage, withstand voltage of AC2000V (r.m.s.) guaranteed for 60 seconds.

**● OBC (On Board Charger)**

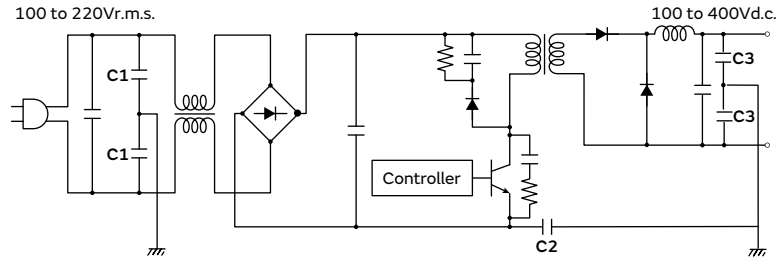

| No. | Application                |
|-----|----------------------------|
| C1  | Y Cap (Primary)            |
| C2  | Primary-Secondary Coupling |
| C3  | Y Cap (Secondary)          |

**3 Best suitable for DC input common mode noise filters.**

DC630V-rated voltage, withstand voltage of DC2700V guaranteed for 60 seconds.

**● Inverter**

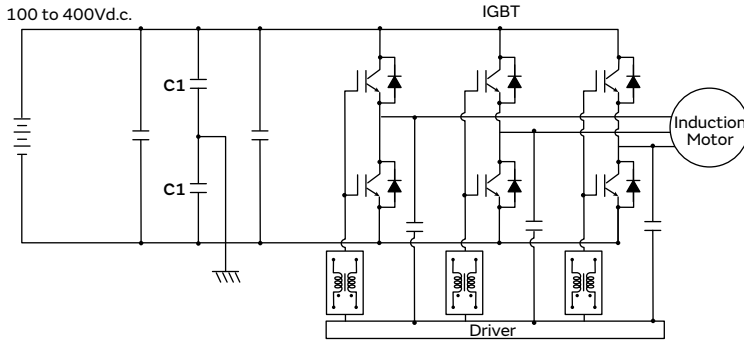

| No. | Application               |
|-----|---------------------------|
| C1  | Common mode noise filters |

**● DC-DC Converter**

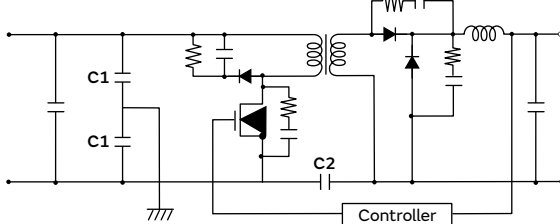

| No. | Application                |
|-----|----------------------------|
| C1  | Common mode noise filters  |
| C2  | Primary-Secondary Coupling |

GRT Series  
 GCM Series  
 GC3 Series  
 GCJ Series  
 GCQ Series  
 GCD Series  
 GCE Series  
 NMF Series  
 KCM Series  
 KCA Series  
 KCB Series  
 GCB Series  
 GCG Series  
 Caution / Notice

4 **Bond metal terminals to the external electrodes of chips.**

The stress applied to the chip is relieved by the elastic action of the metal terminal.

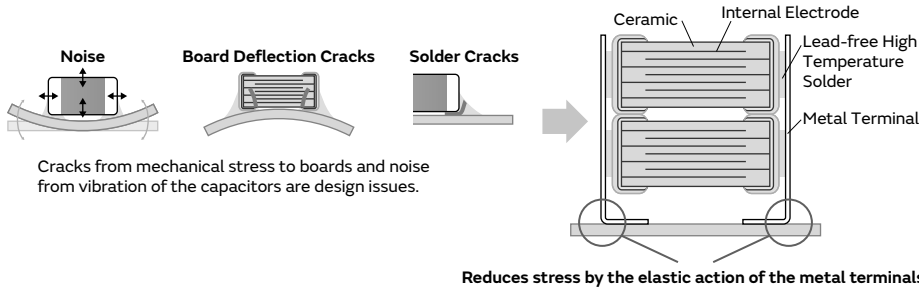

5 **Substantially reduces board deflection cracks and soldering cracks.**

This product is not damaged even with a board deflection of 6 mm. Solder cracks do not occur even with 2,000 cycles of heat stress.

● **Reduces Stress Caused by Board Deflection**

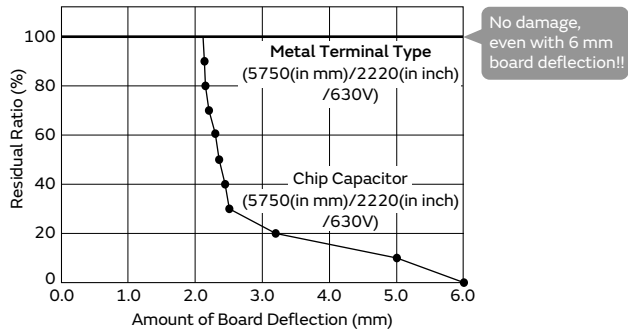

● **Suppresses Solder Cracks Caused by Heat Stress**

| Chip Size   | Chip Only<br>(5750 (in mm)/2220 (in inch) size) | Metal Terminal Type<br>(5750 (in mm)/2220 (in inch) size) |
|-------------|---|---|
| 1000 Cycles |   |   |
| 2000 Cycles |   |   |

Compared with chips only, this product is excellent in solder cracking resistance.

Test Condition: -55 to +125°C, 5min., (Liquid Phase)  
 Board Used: Glass Epoxy Board (FR-4)

6 **2 chips can be stacked.**

Realize large capacity by stacking 2 capacitors.

**Specifications**

|                   |  |
|-------------------|--|
| Size              | 6.1×5.1mm                                    |
| Rated Voltage     | 250Vac (r.m.s.)                              |
| Capacitance       | 100pF to 10000pF                             |
| Main Applications | Battery chargers, Inverter, DC-DC converters |

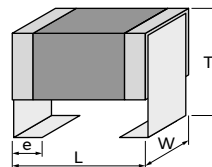

<Dimensions>

**KCA Series Temperature Compensating Type**       **Part Number List**

**6.1×5.1mm**

| T max. | Rated Voltage  | TC Code | Cap.    | Tol. | Part Number        |
|--------|----------------|---------|---------|------|--------------------|
| 3.0mm  | 250Vac(r.m.s.) | U2J     | 100pF   | ±10% | KCA55L7UMF101KL01# |
|        |                |         | 150pF   | ±10% | KCA55L7UMF151KL01# |
|        |                |         | 220pF   | ±10% | KCA55L7UMF221KL01# |
|        |                |         | 330pF   | ±10% | KCA55L7UMF331KL01# |
|        |                |         | 470pF   | ±10% | KCA55L7UMF471KL01# |
|        |                |         | 680pF   | ±10% | KCA55L7UMF681KL01# |
|        |                |         | 1000pF  | ±10% | KCA55L7UMF102KL01# |
|        |                |         | 1500pF  | ±10% | KCA55L7UMF152KL01# |
|        |                |         | 2200pF  | ±10% | KCA55L7UMF222KL01# |
|        |                |         | 3300pF  | ±10% | KCA55L7UMF332KL01# |
| 3.9mm  | 250Vac(r.m.s.) | U2J     | 4700pF  | ±10% | KCA55Q7UMF472KL01# |
| 5.0mm  | 250Vac(r.m.s.) | U2J     | 6800pF  | ±20% | KCA55T7UMF682ML01# |
| 6.7mm  | 250Vac(r.m.s.) | U2J     | 10000pF | ±20% | KCA55W7UMF103ML01# |

GRT Series  
 GCM Series  
 GC3 Series  
 GCJ Series  
 GCQ Series  
 GCD Series  
 GCE Series  
 NMF Series  
 KCM Series  
 KC3 Series  
 KCA Series  
 GCB Series  
 GCG Series  
 ⚠Caution /Notice

Part number # indicates the package specification code.

Ni Plating + Pd Plating Termination Conductive Glue Mounting Chip Multilayer Ceramic Capacitors for Automotive

# GCB Series



**Monolithic ceramic capacitor limited to conductive glue mounting and that can be used even in high-temperature environments at 200°C**

## Features

### 1 Limited to Conductive Glue Mounting

These monolithic ceramic capacitors support the electrically conductive adhesives\*, now being used in the powertrains and safety devices of automobiles, complying with the AEC-Q200 stress test qualification for passive components.

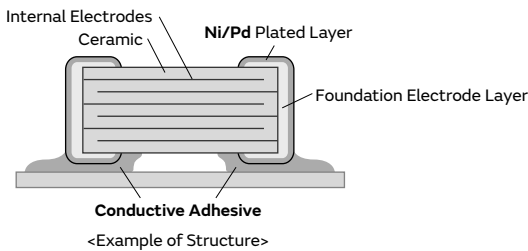

### 2 Palladium plating used for external electrodes

Palladium (Pd) is employed for the plating surfaces of the external electrodes of these capacitors, and a high bonding reliability with electrically conductive adhesives is achieved as a result even during use in high-temperature environments. Furthermore, the terminal electrodes of the capacitors have a superior corrosion resistance compared with our previously available product, the GCG series.

### 3 Ability to function at temperatures up to 200°C

Products that can be used at temperatures up to 200°C have now been made available, and they are ideally suited to the products and devices that are installed in automobiles and work in high-temperature conditions.

\* This product is for use exclusively with conductive glue mounting. It cannot be used with any mounting methods other than conductive glue mounting.

Using solder to mount the product can result in insufficient wetting, insufficient bonding strength, and/or leaching of the Ag/Pd External Electrodes (terminations), which can cause quality problems such as the chip coming loose.

## Specifications

|                   |  |
|-------------------|--|
| Size              | 1.0×0.5mm  |
| Rated Voltage     | 16Vdc to 100Vdc  |
| Capacitance       | 1000pF to 0.10μF   |
| Main Applications | Sensors and small-sized motors used in automobiles (appears there is content missing here) |

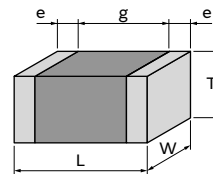

<Dimensions>

GRT Series  
 GCM Series  
 GC3 Series  
 GCJ Series  
 GCQ Series  
 GCD Series  
 GCE Series  
 NMF Series  
 KCM Series  
 KC3 Series  
 KCA Series  
 GCB Series  
 GCG Series  
 △Caution / Notice

# GCB Series High Dielectric Constant Type Part Number List

## 1.0×0.5mm

| T max. | Rated Voltage | TC Code | Cap.    | Tol. | Part Number        |
|--------|---------------|---------|---------|------|--------------------|
| 0.55mm | 100Vdc        | X8R     | 1000pF  | ±10% | GCB155R92A102KE03# |
|        |               |         | 1500pF  | ±10% | GCB155R92A152KE03# |
|        |               |         | 2200pF  | ±10% | GCB155R92A222KE03# |
|        |               |         | 3300pF  | ±10% | GCB155R92A332KE03# |
|        |               |         | 4700pF  | ±10% | GCB155R92A472KE03# |
|        |               |         | 6800pF  | ±10% | GCB155R92A682KE03# |
|        |               |         | 10000pF | ±10% | GCB155R92A103KE03# |
|        | 50Vdc         | X8R     | 1000pF  | ±10% | GCB155R91H102KE01# |
|        |               |         | 1500pF  | ±10% | GCB155R91H152KE01# |
|        |               |         | 2200pF  | ±10% | GCB155R91H222KE01# |
|        |               |         | 3300pF  | ±10% | GCB155R91H332KE01# |
|        |               |         | 4700pF  | ±10% | GCB155R91H472KE01# |
|        |               |         | 15000pF | ±10% | GCB155R91H153KE03# |
|        |               |         | 22000pF | ±10% | GCB155R91H223KE03# |
|        |               |         | 33000pF | ±10% | GCB155R91H333KE03# |
|        | 25Vdc         | X8R     | 6800pF  | ±10% | GCB155R91E682KE01# |
|        |               |         | 10000pF | ±10% | GCB155R91E103KE01# |
|        |               |         | 47000pF | ±10% | GCB155R91E473KE03# |
|        |               |         | 68000pF | ±10% | GCB155R91E683KE03# |
|        |               |         | 0.10μF  | ±10% | GCB155R91E104KE03# |
|        | 16Vdc         | X8R     | 15000pF | ±10% | GCB155R91C153KE01# |
|        |               |         | 22000pF | ±10% | GCB155R91C223KE01# |
|        |               |         | 33000pF | ±10% | GCB155R91C333KE01# |
|        |               |         | 47000pF | ±10% | GCB155R91C473KE01# |
|        |               |         | 68000pF | ±10% | GCB155R91C683KE01# |
|        |               |         | 0.10μF  | ±10% | GCB155R91C104KE01# |

GRT Series  
 GCM Series  
 GC3 Series  
 GCJ Series  
 GCQ Series  
 GCD Series  
 GCE Series  
 NMF Series  
 KCM Series  
 KC3 Series  
 KCA Series  
 GCB Series  
 GCG Series  
 ⚠Caution /Notice

AgPd Termination Conductive Glue Mounting Chip Multilayer Ceramic Capacitors for Automotive

**GCG Series**



**Improved mechanical and thermal strength by adopting AgPd external electrodes, which can be mounted with a conductive glue!**

Features

① **Limited to Conductive Glue Mounting**

This capacitor can be mounted with a conductive adhesive\* in powertrains and safety devices of automotive.

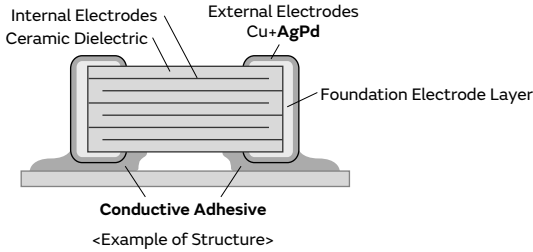

② **Adopted AgPd external electrodes**

Adopted AgPd, which is excellent in bonding strength with a conductive adhesive.

③ **Compatible up to 150°C**

This capacitor lineup with X8L and X8R characteristics can be used in high temperature environments, such as in ABS and transmission control.

\* This product is for use exclusively with conductive glue mounting. It cannot be used with any mounting methods other than conductive glue mounting.

Using solder to mount the product can result in insufficient wetting, insufficient bonding strength, and/or leaching of the Ag/Pd External Electrodes (terminations), which can cause quality problems such as the chip coming loose.

Specifications

|                   |                                       |
|-------------------|---------------------------------------|
| Size              | 1.0×0.5mm to 3.2×2.5mm                |
| Rated Voltage     | 6.3Vdc to 100Vdc                      |
| Capacitance       | 1.0pF to 47μF                         |
| Main Applications | For automotive, power trains, sensors |

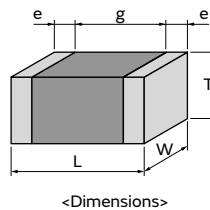

GRT Series  
 GCM Series  
 GC3 Series  
 GCJ Series  
 GCQ Series  
 GCD Series  
 GCE Series  
 NMF Series  
 KCM Series  
 KC3 Series  
 KCA Series  
 GCB Series  
 GCG Series  
 ⚠Caution /Notice

# GCG Series Temperature Compensating Type Part Number List

## 1.0×0.5mm

| T max. | Rated Voltage | TC Code | Cap.  | Tol.    | Part Number        |
|--------|---------------|---------|-------|---------|--------------------|
| 0.55mm | 50Vdc         | COG     | 1.0pF | ±0.1pF  | GCG1555C1H1R0BA01# |
|        |               |         |       | ±0.25pF | GCG1555C1H1R0CA01# |
|        |               |         |       | ±0.5pF  | GCG1555C1H1R0DA01# |
|        |               |         | 1.1pF | ±0.1pF  | GCG1555C1H1R1BA01# |
|        |               |         |       | ±0.25pF | GCG1555C1H1R1CA01# |
|        |               |         |       | ±0.5pF  | GCG1555C1H1R1DA01# |
|        |               |         | 1.2pF | ±0.1pF  | GCG1555C1H1R2BA01# |
|        |               |         |       | ±0.25pF | GCG1555C1H1R2CA01# |
|        |               |         |       | ±0.5pF  | GCG1555C1H1R2DA01# |
|        |               |         | 1.3pF | ±0.1pF  | GCG1555C1H1R3BA01# |
|        |               |         |       | ±0.25pF | GCG1555C1H1R3CA01# |
|        |               |         |       | ±0.5pF  | GCG1555C1H1R3DA01# |
|        |               |         | 1.4pF | ±0.1pF  | GCG1555C1H1R4BA01# |
|        |               |         |       | ±0.25pF | GCG1555C1H1R4CA01# |
|        |               |         |       | ±0.5pF  | GCG1555C1H1R4DA01# |
|        |               |         | 1.5pF | ±0.1pF  | GCG1555C1H1R5BA01# |
|        |               |         |       | ±0.25pF | GCG1555C1H1R5CA01# |
|        |               |         |       | ±0.5pF  | GCG1555C1H1R5DA01# |
|        |               |         | 1.6pF | ±0.1pF  | GCG1555C1H1R6BA01# |
|        |               |         |       | ±0.25pF | GCG1555C1H1R6CA01# |
|        |               |         |       | ±0.5pF  | GCG1555C1H1R6DA01# |
|        |               |         | 1.7pF | ±0.1pF  | GCG1555C1H1R7BA01# |
|        |               |         |       | ±0.25pF | GCG1555C1H1R7CA01# |
|        |               |         |       | ±0.5pF  | GCG1555C1H1R7DA01# |
|        |               |         | 1.8pF | ±0.1pF  | GCG1555C1H1R8BA01# |
|        |               |         |       | ±0.25pF | GCG1555C1H1R8CA01# |
|        |               |         |       | ±0.5pF  | GCG1555C1H1R8DA01# |
|        |               |         | 1.9pF | ±0.1pF  | GCG1555C1H1R9BA01# |
|        |               |         |       | ±0.25pF | GCG1555C1H1R9CA01# |
|        |               |         |       | ±0.5pF  | GCG1555C1H1R9DA01# |
|        |               |         | 2.0pF | ±0.1pF  | GCG1555C1H2R0BA01# |
|        |               |         |       | ±0.25pF | GCG1555C1H2R0CA01# |
|        |               |         |       | ±0.5pF  | GCG1555C1H2R0DA01# |
|        |               |         | 2.1pF | ±0.1pF  | GCG1555C1H2R1BA01# |
|        |               |         |       | ±0.25pF | GCG1555C1H2R1CA01# |
|        |               |         |       | ±0.5pF  | GCG1555C1H2R1DA01# |
|        |               |         | 2.2pF | ±0.1pF  | GCG1555C1H2R2BA01# |
|        |               |         |       | ±0.25pF | GCG1555C1H2R2CA01# |
|        |               |         |       | ±0.5pF  | GCG1555C1H2R2DA01# |
|        |               |         | 2.3pF | ±0.1pF  | GCG1555C1H2R3BA01# |
|        |               |         |       | ±0.25pF | GCG1555C1H2R3CA01# |
|        |               |         |       | ±0.5pF  | GCG1555C1H2R3DA01# |
|        |               |         | 2.4pF | ±0.1pF  | GCG1555C1H2R4BA01# |
|        |               |         |       | ±0.25pF | GCG1555C1H2R4CA01# |
|        |               |         |       | ±0.5pF  | GCG1555C1H2R4DA01# |
|        |               |         | 2.5pF | ±0.1pF  | GCG1555C1H2R5BA01# |
|        |               |         |       | ±0.25pF | GCG1555C1H2R5CA01# |
|        |               |         |       | ±0.5pF  | GCG1555C1H2R5DA01# |
|        |               |         | 2.6pF | ±0.1pF  | GCG1555C1H2R6BA01# |
|        |               |         |       | ±0.25pF | GCG1555C1H2R6CA01# |
|        |               |         |       | ±0.5pF  | GCG1555C1H2R6DA01# |
|        |               |         | 2.7pF | ±0.1pF  | GCG1555C1H2R7BA01# |

| T max. | Rated Voltage | TC Code | Cap.  | Tol.    | Part Number        |
|--------|---------------|---------|-------|---------|--------------------|
| 0.55mm | 50Vdc         | COG     | 2.7pF | ±0.25pF | GCG1555C1H2R7CA01# |
|        |               |         |       | ±0.5pF  | GCG1555C1H2R7DA01# |
|        |               |         |       | ±0.1pF  | GCG1555C1H2R8BA01# |
|        |               |         | 2.8pF | ±0.25pF | GCG1555C1H2R8CA01# |
|        |               |         |       | ±0.5pF  | GCG1555C1H2R8DA01# |
|        |               |         |       | ±0.1pF  | GCG1555C1H2R9BA01# |
|        |               |         | 2.9pF | ±0.25pF | GCG1555C1H2R9CA01# |
|        |               |         |       | ±0.5pF  | GCG1555C1H2R9DA01# |
|        |               |         |       | ±0.1pF  | GCG1555C1H3R0BA01# |
|        |               |         | 3.0pF | ±0.25pF | GCG1555C1H3R0CA01# |
|        |               |         |       | ±0.5pF  | GCG1555C1H3R0DA01# |
|        |               |         |       | ±0.1pF  | GCG1555C1H3R1BA01# |
|        |               |         | 3.1pF | ±0.25pF | GCG1555C1H3R1CA01# |
|        |               |         |       | ±0.5pF  | GCG1555C1H3R1DA01# |
|        |               |         |       | ±0.1pF  | GCG1555C1H3R2BA01# |
|        |               |         | 3.2pF | ±0.25pF | GCG1555C1H3R2CA01# |
|        |               |         |       | ±0.5pF  | GCG1555C1H3R2DA01# |
|        |               |         |       | ±0.1pF  | GCG1555C1H3R3BA01# |
|        |               |         | 3.3pF | ±0.25pF | GCG1555C1H3R3CA01# |
|        |               |         |       | ±0.5pF  | GCG1555C1H3R3DA01# |
|        |               |         |       | ±0.1pF  | GCG1555C1H3R4BA01# |
|        |               |         | 3.4pF | ±0.25pF | GCG1555C1H3R4CA01# |
|        |               |         |       | ±0.5pF  | GCG1555C1H3R4DA01# |
|        |               |         |       | ±0.1pF  | GCG1555C1H3R5BA01# |
|        |               |         | 3.5pF | ±0.25pF | GCG1555C1H3R5CA01# |
|        |               |         |       | ±0.5pF  | GCG1555C1H3R5DA01# |
|        |               |         |       | ±0.1pF  | GCG1555C1H3R6BA01# |
|        |               |         | 3.6pF | ±0.25pF | GCG1555C1H3R6CA01# |
|        |               |         |       | ±0.5pF  | GCG1555C1H3R6DA01# |
|        |               |         |       | ±0.1pF  | GCG1555C1H3R7BA01# |
|        |               |         | 3.7pF | ±0.25pF | GCG1555C1H3R7CA01# |
|        |               |         |       | ±0.5pF  | GCG1555C1H3R7DA01# |
|        |               |         |       | ±0.1pF  | GCG1555C1H3R8BA01# |
|        |               |         | 3.8pF | ±0.25pF | GCG1555C1H3R8CA01# |
|        |               |         |       | ±0.5pF  | GCG1555C1H3R8DA01# |
|        |               |         |       | ±0.1pF  | GCG1555C1H3R9BA01# |
|        |               |         | 3.9pF | ±0.25pF | GCG1555C1H3R9CA01# |
|        |               |         |       | ±0.5pF  | GCG1555C1H3R9DA01# |
|        |               |         |       | ±0.1pF  | GCG1555C1H4R0BA01# |
|        |               |         | 4.0pF | ±0.25pF | GCG1555C1H4R0CA01# |
|        |               |         |       | ±0.5pF  | GCG1555C1H4R0DA01# |
|        |               |         |       | ±0.1pF  | GCG1555C1H4R1BA01# |
|        |               |         | 4.1pF | ±0.25pF | GCG1555C1H4R1CA01# |
|        |               |         |       | ±0.5pF  | GCG1555C1H4R1DA01# |
|        |               |         |       | ±0.1pF  | GCG1555C1H4R2BA01# |
|        |               |         | 4.2pF | ±0.25pF | GCG1555C1H4R2CA01# |
|        |               |         |       | ±0.5pF  | GCG1555C1H4R2DA01# |
|        |               |         |       | ±0.1pF  | GCG1555C1H4R3BA01# |
|        |               |         | 4.3pF | ±0.25pF | GCG1555C1H4R3CA01# |
|        |               |         |       | ±0.5pF  | GCG1555C1H4R3DA01# |
|        |               |         |       | ±0.1pF  | GCG1555C1H4R4BA01# |
|        |               |         | 4.4pF | ±0.25pF | GCG1555C1H4R4CA01# |
|        |               |         |       | ±0.5pF  | GCG1555C1H4R4DA01# |
|        |               |         |       | ±0.1pF  | GCG1555C1H4R5BA01# |

Part number # indicates the package specification code.

GRT Series  
 GCM Series  
 GC3 Series  
 GCJ Series  
 GCQ Series  
 GCD Series  
 GCE Series  
 NMF Series  
 KCM Series  
 KC3 Series  
 KCA Series  
 GCB Series  
 GCG Series  
 ⚠Caution /Notice



# GCG Series Temperature Compensating Type Part Number List

(→ 1.0×0.5mm)

| T max. | Rated Voltage | TC Code            | Cap.  | Tol.    | Part Number        | T max. | Rated Voltage | TC Code | Cap.  | Tol.    | Part Number        |
|--------|---------------|--------------------|-------|---------|--------------------|--------|---------------|---------|-------|---------|--------------------|
| 0.55mm | 50Vdc         | COG                | 4.5pF | ±0.25pF | GCG1555C1H4R5CA01# | 0.55mm | 50Vdc         | COG     | 6.3pF | ±0.25pF | GCG1555C1H6R3CA01# |
|        |               |                    |       | ±0.5pF  | GCG1555C1H4R5DA01# |        |               |         |       | ±0.5pF  | GCG1555C1H6R3DA01# |
|        |               |                    | 4.6pF | ±0.1pF  | GCG1555C1H4R6BA01# |        |               |         | 6.4pF | ±0.1pF  | GCG1555C1H6R4BA01# |
|        |               |                    |       | ±0.25pF | GCG1555C1H4R6CA01# |        |               |         |       | ±0.25pF | GCG1555C1H6R4CA01# |
|        |               |                    | 4.7pF | ±0.5pF  | GCG1555C1H4R6DA01# |        |               |         | 6.5pF | ±0.1pF  | GCG1555C1H6R5BA01# |
|        |               |                    |       | ±0.25pF | GCG1555C1H4R7CA01# |        |               |         |       | ±0.25pF | GCG1555C1H6R5CA01# |
|        |               |                    | 4.8pF | ±0.5pF  | GCG1555C1H4R7DA01# |        |               |         | 6.6pF | ±0.5pF  | GCG1555C1H6R5DA01# |
|        |               |                    |       | ±0.1pF  | GCG1555C1H4R8BA01# |        |               |         |       | ±0.1pF  | GCG1555C1H6R6BA01# |
|        |               |                    | 4.9pF | ±0.25pF | GCG1555C1H4R8CA01# |        |               |         | 6.7pF | ±0.25pF | GCG1555C1H6R6CA01# |
|        |               |                    |       | ±0.5pF  | GCG1555C1H4R8DA01# |        |               |         |       | ±0.5pF  | GCG1555C1H6R6DA01# |
|        |               |                    | 5.0pF | ±0.1pF  | GCG1555C1H4R9BA01# |        |               |         | 6.8pF | ±0.1pF  | GCG1555C1H6R7BA01# |
|        |               |                    |       | ±0.25pF | GCG1555C1H4R9CA01# |        |               |         |       | ±0.25pF | GCG1555C1H6R7CA01# |
|        |               |                    | 5.1pF | ±0.5pF  | GCG1555C1H4R9DA01# |        |               |         | 6.9pF | ±0.5pF  | GCG1555C1H6R7DA01# |
|        |               |                    |       | ±0.1pF  | GCG1555C1H5R0BA01# |        |               |         |       | ±0.1pF  | GCG1555C1H6R8BA01# |
|        |               |                    | 5.2pF | ±0.25pF | GCG1555C1H5R0CA01# |        |               |         | 7.0pF | ±0.25pF | GCG1555C1H6R8CA01# |
|        |               |                    |       | ±0.5pF  | GCG1555C1H5R0DA01# |        |               |         |       | ±0.5pF  | GCG1555C1H6R8DA01# |
|        |               |                    | 5.3pF | ±0.1pF  | GCG1555C1H5R1BA01# |        |               |         | 7.1pF | ±0.1pF  | GCG1555C1H6R9BA01# |
|        |               |                    |       | ±0.25pF | GCG1555C1H5R1CA01# |        |               |         |       | ±0.25pF | GCG1555C1H6R9CA01# |
|        |               |                    | 5.4pF | ±0.5pF  | GCG1555C1H5R1DA01# |        |               |         | 7.2pF | ±0.5pF  | GCG1555C1H6R9DA01# |
|        |               |                    |       | ±0.1pF  | GCG1555C1H5R2BA01# |        |               |         |       | ±0.1pF  | GCG1555C1H7R0BA01# |
|        |               |                    | 5.5pF | ±0.25pF | GCG1555C1H5R2CA01# |        |               |         | 7.3pF | ±0.25pF | GCG1555C1H7R0CA01# |
|        |               |                    |       | ±0.5pF  | GCG1555C1H5R2DA01# |        |               |         |       | ±0.5pF  | GCG1555C1H7R0DA01# |
|        |               |                    | 5.6pF | ±0.1pF  | GCG1555C1H5R3BA01# |        |               |         | 7.4pF | ±0.1pF  | GCG1555C1H7R1BA01# |
|        |               |                    |       | ±0.25pF | GCG1555C1H5R3CA01# |        |               |         |       | ±0.25pF | GCG1555C1H7R1CA01# |
|        |               |                    | 5.7pF | ±0.5pF  | GCG1555C1H5R3DA01# |        |               |         | 7.5pF | ±0.5pF  | GCG1555C1H7R1DA01# |
|        |               |                    |       | ±0.1pF  | GCG1555C1H5R4BA01# |        |               |         |       | ±0.1pF  | GCG1555C1H7R2BA01# |
|        |               |                    | 5.8pF | ±0.25pF | GCG1555C1H5R4CA01# |        |               |         | 7.6pF | ±0.25pF | GCG1555C1H7R2CA01# |
|        |               |                    |       | ±0.5pF  | GCG1555C1H5R4DA01# |        |               |         |       | ±0.5pF  | GCG1555C1H7R2DA01# |
|        |               |                    | 5.9pF | ±0.1pF  | GCG1555C1H5R5BA01# |        |               |         | 7.7pF | ±0.1pF  | GCG1555C1H7R3BA01# |
|        |               |                    |       | ±0.25pF | GCG1555C1H5R5CA01# |        |               |         |       | ±0.25pF | GCG1555C1H7R3CA01# |
|        |               |                    | 6.0pF | ±0.5pF  | GCG1555C1H5R5DA01# |        |               |         | 7.8pF | ±0.5pF  | GCG1555C1H7R3DA01# |
|        |               |                    |       | ±0.1pF  | GCG1555C1H5R6BA01# |        |               |         |       | ±0.1pF  | GCG1555C1H7R4BA01# |
|        |               |                    | 6.1pF | ±0.25pF | GCG1555C1H5R6CA01# |        |               |         | 7.9pF | ±0.25pF | GCG1555C1H7R4CA01# |
|        |               |                    |       | ±0.5pF  | GCG1555C1H5R6DA01# |        |               |         |       | ±0.5pF  | GCG1555C1H7R4DA01# |
|        |               |                    | 6.2pF | ±0.1pF  | GCG1555C1H5R7BA01# |        |               |         | 8.0pF | ±0.1pF  | GCG1555C1H7R5BA01# |
|        |               |                    |       | ±0.25pF | GCG1555C1H5R7CA01# |        |               |         |       | ±0.25pF | GCG1555C1H7R5CA01# |
|        |               |                    | 6.3pF | ±0.5pF  | GCG1555C1H5R7DA01# |        |               |         | 8.1pF | ±0.5pF  | GCG1555C1H7R5DA01# |
|        |               |                    |       | ±0.1pF  | GCG1555C1H5R8BA01# |        |               |         |       | ±0.1pF  | GCG1555C1H7R6BA01# |
|        |               |                    |       | ±0.25pF | GCG1555C1H5R8CA01# |        |               |         |       | ±0.25pF | GCG1555C1H7R6CA01# |
|        |               |                    |       | ±0.5pF  | GCG1555C1H5R8DA01# |        |               |         |       | ±0.5pF  | GCG1555C1H7R6DA01# |
|        |               |                    |       | ±0.1pF  | GCG1555C1H5R9BA01# |        |               |         |       | ±0.1pF  | GCG1555C1H7R7BA01# |
|        |               |                    |       | ±0.25pF | GCG1555C1H5R9CA01# |        |               |         |       | ±0.25pF | GCG1555C1H7R7CA01# |
|        | ±0.5pF        | GCG1555C1H5R9DA01# |       | ±0.5pF  | GCG1555C1H7R7DA01# |        |               |         |       |         |                    |
|        | ±0.1pF        | GCG1555C1H6R0BA01# |       | ±0.1pF  | GCG1555C1H7R8BA01# |        |               |         |       |         |                    |
|        | ±0.25pF       | GCG1555C1H6R0CA01# |       | ±0.25pF | GCG1555C1H7R8CA01# |        |               |         |       |         |                    |
|        | ±0.5pF        | GCG1555C1H6R0DA01# |       | ±0.5pF  | GCG1555C1H7R8DA01# |        |               |         |       |         |                    |
|        | ±0.1pF        | GCG1555C1H6R1BA01# |       | ±0.1pF  | GCG1555C1H7R9BA01# |        |               |         |       |         |                    |
|        | ±0.25pF       | GCG1555C1H6R1CA01# |       | ±0.25pF | GCG1555C1H7R9CA01# |        |               |         |       |         |                    |
|        | ±0.5pF        | GCG1555C1H6R1DA01# |       | ±0.5pF  | GCG1555C1H7R9DA01# |        |               |         |       |         |                    |
|        | ±0.1pF        | GCG1555C1H6R2BA01# |       | ±0.1pF  | GCG1555C1H8R0BA01# |        |               |         |       |         |                    |
|        | ±0.25pF       | GCG1555C1H6R2CA01# |       | ±0.25pF | GCG1555C1H8R0CA01# |        |               |         |       |         |                    |
|        | ±0.5pF        | GCG1555C1H6R2DA01# |       | ±0.5pF  | GCG1555C1H8R0DA01# |        |               |         |       |         |                    |
|        | ±0.1pF        | GCG1555C1H6R3BA01# |       | ±0.1pF  | GCG1555C1H8R1BA01# |        |               |         |       |         |                    |

Part number # indicates the package specification code.

GRT Series  
 GCM Series  
 GC3 Series  
 GCJ Series  
 GCQ Series  
 GCD Series  
 GCE Series  
 NMF Series  
 KCM Series  
 KC3 Series  
 KCA Series  
 GCB Series  
 GCG Series  
 ⚠Caution /Notice

# GCG Series Temperature Compensating Type Part Number List

(→ 1.0×0.5mm)

| T max. | Rated Voltage | TC Code | Cap.    | Tol.               | Part Number        | T max.             | Rated Voltage | TC Code            | Cap.               | Tol.    | Part Number        |                    |  |  |
|--------|---------------|---------|---------|--------------------|--------------------|--------------------|---------------|--------------------|--------------------|---------|--------------------|--------------------|--|--|
| 0.55mm | 50Vdc         | COG     | 8.1pF   | ±0.25pF            | GCG1555C1H8R1CA01# | 0.55mm             | 50Vdc         | COG                | 9.9pF              | ±0.25pF | GCG1555C1H9R9CA01# |                    |  |  |
|        |               |         |         | ±0.5pF             | GCG1555C1H8R1DA01# |                    |               |                    |                    | ±0.5pF  | GCG1555C1H9R9DA01# |                    |  |  |
|        |               |         |         | ±0.1pF             | GCG1555C1H8R2BA01# |                    |               |                    |                    | 10pF    | ±1%                | GCG1555C1H100FA01# |  |  |
|        |               |         | ±0.25pF | GCG1555C1H8R2CA01# | ±2.5%              | GCG1555C1H100RA01# |               |                    |                    |         |                    |                    |  |  |
|        |               |         | ±0.5pF  | GCG1555C1H8R2DA01# | ±5%                | GCG1555C1H100JA01# |               |                    |                    |         |                    |                    |  |  |
|        |               |         | 8.2pF   | ±0.1pF             | GCG1555C1H8R3BA01# | CH                 | 1.0pF         | ±0.1pF             | GCG1552C1H1R0BA01# |         |                    |                    |  |  |
|        |               |         |         | ±0.25pF            | GCG1555C1H8R3CA01# |                    |               | ±0.25pF            | GCG1552C1H1R0CA01# |         |                    |                    |  |  |
|        |               |         |         | ±0.5pF             | GCG1555C1H8R3DA01# |                    |               | ±0.5pF             | GCG1552C1H1R0DA01# |         |                    |                    |  |  |
|        |               |         | 8.3pF   | ±0.1pF             | GCG1555C1H8R4BA01# | 1.1pF              | ±0.1pF        | GCG1552C1H1R1BA01# |                    |         |                    |                    |  |  |
|        |               |         |         | ±0.25pF            | GCG1555C1H8R4CA01# |                    | ±0.25pF       | GCG1552C1H1R1CA01# |                    |         |                    |                    |  |  |
|        |               |         |         | ±0.5pF             | GCG1555C1H8R4DA01# |                    | ±0.5pF        | GCG1552C1H1R1DA01# |                    |         |                    |                    |  |  |
|        |               |         | 8.4pF   | ±0.1pF             | GCG1555C1H8R5BA01# | 1.2pF              | ±0.1pF        | GCG1552C1H1R2BA01# |                    |         |                    |                    |  |  |
|        |               |         |         | ±0.25pF            | GCG1555C1H8R5CA01# |                    | ±0.25pF       | GCG1552C1H1R2CA01# |                    |         |                    |                    |  |  |
|        |               |         |         | ±0.5pF             | GCG1555C1H8R5DA01# |                    | ±0.5pF        | GCG1552C1H1R2DA01# |                    |         |                    |                    |  |  |
|        |               |         | 8.5pF   | ±0.1pF             | GCG1555C1H8R6BA01# | 1.3pF              | ±0.1pF        | GCG1552C1H1R3BA01# |                    |         |                    |                    |  |  |
|        |               |         |         | ±0.25pF            | GCG1555C1H8R6CA01# |                    | ±0.25pF       | GCG1552C1H1R3CA01# |                    |         |                    |                    |  |  |
|        |               |         |         | ±0.5pF             | GCG1555C1H8R6DA01# |                    | ±0.5pF        | GCG1552C1H1R3DA01# |                    |         |                    |                    |  |  |
|        |               |         | 8.6pF   | ±0.1pF             | GCG1555C1H8R7BA01# | 1.4pF              | ±0.1pF        | GCG1552C1H1R4BA01# |                    |         |                    |                    |  |  |
|        |               |         |         | ±0.25pF            | GCG1555C1H8R7CA01# |                    | ±0.25pF       | GCG1552C1H1R4CA01# |                    |         |                    |                    |  |  |
|        |               |         |         | ±0.5pF             | GCG1555C1H8R7DA01# |                    | ±0.5pF        | GCG1552C1H1R4DA01# |                    |         |                    |                    |  |  |
|        |               |         | 8.7pF   | ±0.1pF             | GCG1555C1H8R8BA01# | 1.5pF              | ±0.1pF        | GCG1552C1H1R5BA01# |                    |         |                    |                    |  |  |
|        |               |         |         | ±0.25pF            | GCG1555C1H8R8CA01# |                    | ±0.25pF       | GCG1552C1H1R5CA01# |                    |         |                    |                    |  |  |
|        |               |         |         | ±0.5pF             | GCG1555C1H8R8DA01# |                    | ±0.5pF        | GCG1552C1H1R5DA01# |                    |         |                    |                    |  |  |
|        |               |         | 8.8pF   | ±0.1pF             | GCG1555C1H8R9BA01# | 1.6pF              | ±0.1pF        | GCG1552C1H1R6BA01# |                    |         |                    |                    |  |  |
|        |               |         |         | ±0.25pF            | GCG1555C1H8R9CA01# |                    | ±0.25pF       | GCG1552C1H1R6CA01# |                    |         |                    |                    |  |  |
|        |               |         |         | ±0.5pF             | GCG1555C1H8R9DA01# |                    | ±0.5pF        | GCG1552C1H1R6DA01# |                    |         |                    |                    |  |  |
|        |               |         | 8.9pF   | ±0.1pF             | GCG1555C1H9R0BA01# | 1.7pF              | ±0.1pF        | GCG1552C1H1R7BA01# |                    |         |                    |                    |  |  |
|        |               |         |         | ±0.25pF            | GCG1555C1H9R0CA01# |                    | ±0.25pF       | GCG1552C1H1R7CA01# |                    |         |                    |                    |  |  |
|        |               |         |         | ±0.5pF             | GCG1555C1H9R0DA01# |                    | ±0.5pF        | GCG1552C1H1R7DA01# |                    |         |                    |                    |  |  |
|        |               |         | 9.0pF   | ±0.1pF             | GCG1555C1H9R1BA01# | 1.8pF              | ±0.1pF        | GCG1552C1H1R8BA01# |                    |         |                    |                    |  |  |
|        |               |         |         | ±0.25pF            | GCG1555C1H9R1CA01# |                    | ±0.25pF       | GCG1552C1H1R8CA01# |                    |         |                    |                    |  |  |
|        |               |         |         | ±0.5pF             | GCG1555C1H9R1DA01# |                    | ±0.5pF        | GCG1552C1H1R8DA01# |                    |         |                    |                    |  |  |
|        |               |         | 9.1pF   | ±0.1pF             | GCG1555C1H9R2BA01# | 1.9pF              | ±0.1pF        | GCG1552C1H1R9BA01# |                    |         |                    |                    |  |  |
|        |               |         |         | ±0.25pF            | GCG1555C1H9R2CA01# |                    | ±0.25pF       | GCG1552C1H1R9CA01# |                    |         |                    |                    |  |  |
|        |               |         |         | ±0.5pF             | GCG1555C1H9R2DA01# |                    | ±0.5pF        | GCG1552C1H1R9DA01# |                    |         |                    |                    |  |  |
|        |               |         | 9.2pF   | ±0.1pF             | GCG1555C1H9R3BA01# | 2.0pF              | ±0.1pF        | GCG1552C1H2R0BA01# |                    |         |                    |                    |  |  |
|        |               |         |         | ±0.25pF            | GCG1555C1H9R3CA01# |                    | ±0.25pF       | GCG1552C1H2R0CA01# |                    |         |                    |                    |  |  |
|        |               |         |         | ±0.5pF             | GCG1555C1H9R3DA01# |                    | ±0.5pF        | GCG1552C1H2R0DA01# |                    |         |                    |                    |  |  |
|        |               |         | 9.3pF   | ±0.1pF             | GCG1555C1H9R4BA01# | 2.1pF              | ±0.1pF        | GCG1552C1H2R1BA01# |                    |         |                    |                    |  |  |
|        |               |         |         | ±0.25pF            | GCG1555C1H9R4CA01# |                    | ±0.25pF       | GCG1552C1H2R1CA01# |                    |         |                    |                    |  |  |
|        |               |         |         | ±0.5pF             | GCG1555C1H9R4DA01# |                    | ±0.5pF        | GCG1552C1H2R1DA01# |                    |         |                    |                    |  |  |
|        |               |         | 9.4pF   | ±0.1pF             | GCG1555C1H9R5BA01# | 2.2pF              | ±0.1pF        | GCG1552C1H2R2BA01# |                    |         |                    |                    |  |  |
|        |               |         |         | ±0.25pF            | GCG1555C1H9R5CA01# |                    | ±0.25pF       | GCG1552C1H2R2CA01# |                    |         |                    |                    |  |  |
|        |               |         |         | ±0.5pF             | GCG1555C1H9R5DA01# |                    | ±0.5pF        | GCG1552C1H2R2DA01# |                    |         |                    |                    |  |  |
|        |               |         | 9.5pF   | ±0.1pF             | GCG1555C1H9R6BA01# | 2.3pF              | ±0.1pF        | GCG1552C1H2R3BA01# |                    |         |                    |                    |  |  |
|        |               |         |         | ±0.25pF            | GCG1555C1H9R6CA01# |                    | ±0.25pF       | GCG1552C1H2R3CA01# |                    |         |                    |                    |  |  |
|        |               |         |         | ±0.5pF             | GCG1555C1H9R6DA01# |                    | ±0.5pF        | GCG1552C1H2R3DA01# |                    |         |                    |                    |  |  |
|        |               |         | 9.6pF   | ±0.1pF             | GCG1555C1H9R7BA01# | 2.4pF              | ±0.1pF        | GCG1552C1H2R4BA01# |                    |         |                    |                    |  |  |
|        |               |         |         | ±0.25pF            | GCG1555C1H9R7CA01# |                    | ±0.25pF       | GCG1552C1H2R4CA01# |                    |         |                    |                    |  |  |
|        |               |         |         | ±0.5pF             | GCG1555C1H9R7DA01# |                    | ±0.5pF        | GCG1552C1H2R4DA01# |                    |         |                    |                    |  |  |
|        |               |         | 9.7pF   | ±0.1pF             | GCG1555C1H9R8BA01# | 2.5pF              | ±0.1pF        | GCG1552C1H2R5BA01# |                    |         |                    |                    |  |  |
|        |               |         |         | ±0.25pF            | GCG1555C1H9R8CA01# |                    | ±0.25pF       | GCG1552C1H2R5CA01# |                    |         |                    |                    |  |  |
|        |               |         |         | ±0.5pF             | GCG1555C1H9R8DA01# |                    | ±0.5pF        | GCG1552C1H2R5DA01# |                    |         |                    |                    |  |  |
|        |               |         | 9.8pF   | ±0.1pF             | GCG1555C1H9R9BA01# | 2.6pF              | ±0.1pF        | GCG1552C1H2R6BA01# |                    |         |                    |                    |  |  |
|        |               |         |         | ±0.25pF            | GCG1555C1H9R9CA01# |                    |               |                    |                    |         |                    |                    |  |  |
|        |               |         |         | ±0.5pF             | GCG1555C1H9R9DA01# |                    |               |                    |                    |         |                    |                    |  |  |
|        |               |         | 9.9pF   | ±0.1pF             | GCG1555C1H9R9BA01# |                    |               |                    |                    |         |                    |                    |  |  |

Part number # indicates the package specification code.

GRT Series  
 GCM Series  
 GC3 Series  
 GCJ Series  
 GCQ Series  
 GCD Series  
 GCE Series  
 NMF Series  
 KCM Series  
 KC3 Series  
 KCA Series  
 GCB Series  
 GCG Series  
 ⚠Caution /Notice

# GCG Series Temperature Compensating Type Part Number List

(→ 1.0×0.5mm)

| T max.  | Rated Voltage      | TC Code            | Cap.  | Tol.               | Part Number        | T max. | Rated Voltage | TC Code | Cap.  | Tol.    | Part Number        |
|---------|--------------------|--------------------|-------|--------------------|--------------------|--------|---------------|---------|-------|---------|--------------------|
| 0.55mm  | 50Vdc              | CH                 | 2.6pF | ±0.25pF            | GCG1552C1H2R6CA01# | 0.55mm | 50Vdc         | CH      | 4.4pF | ±0.25pF | GCG1552C1H4R4CA01# |
|         |                    |                    |       | ±0.5pF             | GCG1552C1H2R6DA01# |        |               |         |       | ±0.5pF  | GCG1552C1H4R4DA01# |
|         |                    |                    | 2.7pF | ±0.1pF             | GCG1552C1H2R7BA01# |        |               |         | 4.5pF | ±0.1pF  | GCG1552C1H4R5BA01# |
|         |                    |                    |       | ±0.25pF            | GCG1552C1H2R7CA01# |        |               |         |       | ±0.25pF | GCG1552C1H4R5CA01# |
|         |                    |                    |       | ±0.5pF             | GCG1552C1H2R7DA01# |        |               |         |       | ±0.5pF  | GCG1552C1H4R5DA01# |
|         |                    |                    | 2.8pF | ±0.1pF             | GCG1552C1H2R8BA01# |        |               |         | 4.6pF | ±0.1pF  | GCG1552C1H4R6BA01# |
|         |                    |                    |       | ±0.25pF            | GCG1552C1H2R8CA01# |        |               |         |       | ±0.25pF | GCG1552C1H4R6CA01# |
|         |                    |                    |       | ±0.5pF             | GCG1552C1H2R8DA01# |        |               |         |       | ±0.5pF  | GCG1552C1H4R6DA01# |
|         |                    |                    | 2.9pF | ±0.1pF             | GCG1552C1H2R9BA01# |        |               |         | 4.7pF | ±0.1pF  | GCG1552C1H4R7BA01# |
|         |                    |                    |       | ±0.25pF            | GCG1552C1H2R9CA01# |        |               |         |       | ±0.25pF | GCG1552C1H4R7CA01# |
|         |                    |                    |       | ±0.5pF             | GCG1552C1H2R9DA01# |        |               |         |       | ±0.5pF  | GCG1552C1H4R7DA01# |
|         |                    |                    | 3.0pF | ±0.1pF             | GCG1552C1H3R0BA01# |        |               |         | 4.8pF | ±0.1pF  | GCG1552C1H4R8BA01# |
|         |                    |                    |       | ±0.25pF            | GCG1552C1H3R0CA01# |        |               |         |       | ±0.25pF | GCG1552C1H4R8CA01# |
|         |                    |                    |       | ±0.5pF             | GCG1552C1H3R0DA01# |        |               |         |       | ±0.5pF  | GCG1552C1H4R8DA01# |
|         |                    |                    | 3.1pF | ±0.1pF             | GCG1552C1H3R1BA01# |        |               |         | 4.9pF | ±0.1pF  | GCG1552C1H4R9BA01# |
|         |                    |                    |       | ±0.25pF            | GCG1552C1H3R1CA01# |        |               |         |       | ±0.25pF | GCG1552C1H4R9CA01# |
|         |                    |                    |       | ±0.5pF             | GCG1552C1H3R1DA01# |        |               |         |       | ±0.5pF  | GCG1552C1H4R9DA01# |
|         |                    |                    | 3.2pF | ±0.1pF             | GCG1552C1H3R2BA01# |        |               |         | 5.0pF | ±0.1pF  | GCG1552C1H5R0BA01# |
|         |                    |                    |       | ±0.25pF            | GCG1552C1H3R2CA01# |        |               |         |       | ±0.25pF | GCG1552C1H5R0CA01# |
|         |                    |                    |       | ±0.5pF             | GCG1552C1H3R2DA01# |        |               |         |       | ±0.5pF  | GCG1552C1H5R0DA01# |
|         |                    |                    | 3.3pF | ±0.1pF             | GCG1552C1H3R3BA01# |        |               |         | 5.1pF | ±0.1pF  | GCG1552C1H5R1BA01# |
|         |                    |                    |       | ±0.25pF            | GCG1552C1H3R3CA01# |        |               |         |       | ±0.25pF | GCG1552C1H5R1CA01# |
|         |                    |                    |       | ±0.5pF             | GCG1552C1H3R3DA01# |        |               |         |       | ±0.5pF  | GCG1552C1H5R1DA01# |
|         |                    |                    | 3.4pF | ±0.1pF             | GCG1552C1H3R4BA01# |        |               |         | 5.2pF | ±0.1pF  | GCG1552C1H5R2BA01# |
|         |                    |                    |       | ±0.25pF            | GCG1552C1H3R4CA01# |        |               |         |       | ±0.25pF | GCG1552C1H5R2CA01# |
|         |                    |                    |       | ±0.5pF             | GCG1552C1H3R4DA01# |        |               |         |       | ±0.5pF  | GCG1552C1H5R2DA01# |
|         |                    |                    | 3.5pF | ±0.1pF             | GCG1552C1H3R5BA01# |        |               |         | 5.3pF | ±0.1pF  | GCG1552C1H5R3BA01# |
|         |                    |                    |       | ±0.25pF            | GCG1552C1H3R5CA01# |        |               |         |       | ±0.25pF | GCG1552C1H5R3CA01# |
|         |                    |                    |       | ±0.5pF             | GCG1552C1H3R5DA01# |        |               |         |       | ±0.5pF  | GCG1552C1H5R3DA01# |
|         |                    |                    | 3.6pF | ±0.1pF             | GCG1552C1H3R6BA01# |        |               |         | 5.4pF | ±0.1pF  | GCG1552C1H5R4BA01# |
|         |                    |                    |       | ±0.25pF            | GCG1552C1H3R6CA01# |        |               |         |       | ±0.25pF | GCG1552C1H5R4CA01# |
|         |                    |                    |       | ±0.5pF             | GCG1552C1H3R6DA01# |        |               |         |       | ±0.5pF  | GCG1552C1H5R4DA01# |
|         |                    |                    | 3.7pF | ±0.1pF             | GCG1552C1H3R7BA01# |        |               |         | 5.5pF | ±0.1pF  | GCG1552C1H5R5BA01# |
|         |                    |                    |       | ±0.25pF            | GCG1552C1H3R7CA01# |        |               |         |       | ±0.25pF | GCG1552C1H5R5CA01# |
|         |                    |                    |       | ±0.5pF             | GCG1552C1H3R7DA01# |        |               |         |       | ±0.5pF  | GCG1552C1H5R5DA01# |
|         |                    |                    | 3.8pF | ±0.1pF             | GCG1552C1H3R8BA01# |        |               |         | 5.6pF | ±0.1pF  | GCG1552C1H5R6BA01# |
|         |                    |                    |       | ±0.25pF            | GCG1552C1H3R8CA01# |        |               |         |       | ±0.25pF | GCG1552C1H5R6CA01# |
|         |                    |                    |       | ±0.5pF             | GCG1552C1H3R8DA01# |        |               |         |       | ±0.5pF  | GCG1552C1H5R6DA01# |
|         |                    |                    | 3.9pF | ±0.1pF             | GCG1552C1H3R9BA01# |        |               |         | 5.7pF | ±0.1pF  | GCG1552C1H5R7BA01# |
|         |                    |                    |       | ±0.25pF            | GCG1552C1H3R9CA01# |        |               |         |       | ±0.25pF | GCG1552C1H5R7CA01# |
|         |                    |                    |       | ±0.5pF             | GCG1552C1H3R9DA01# |        |               |         |       | ±0.5pF  | GCG1552C1H5R7DA01# |
|         |                    |                    | 4.0pF | ±0.1pF             | GCG1552C1H4R0BA01# |        |               |         | 5.8pF | ±0.1pF  | GCG1552C1H5R8BA01# |
|         |                    |                    |       | ±0.25pF            | GCG1552C1H4R0CA01# |        |               |         |       | ±0.25pF | GCG1552C1H5R8CA01# |
|         |                    |                    |       | ±0.5pF             | GCG1552C1H4R0DA01# |        |               |         |       | ±0.5pF  | GCG1552C1H5R8DA01# |
|         |                    |                    | 4.1pF | ±0.1pF             | GCG1552C1H4R1BA01# |        |               |         | 5.9pF | ±0.1pF  | GCG1552C1H5R9BA01# |
|         |                    |                    |       | ±0.25pF            | GCG1552C1H4R1CA01# |        |               |         |       | ±0.25pF | GCG1552C1H5R9CA01# |
|         |                    |                    |       | ±0.5pF             | GCG1552C1H4R1DA01# |        |               |         |       | ±0.5pF  | GCG1552C1H5R9DA01# |
|         |                    |                    | 4.2pF | ±0.1pF             | GCG1552C1H4R2BA01# |        |               |         | 6.0pF | ±0.1pF  | GCG1552C1H6R0BA01# |
| ±0.25pF | GCG1552C1H4R2CA01# | ±0.25pF            |       | GCG1552C1H6R0CA01# |                    |        |               |         |       |         |                    |
| ±0.5pF  | GCG1552C1H4R2DA01# | ±0.5pF             |       | GCG1552C1H6R0DA01# |                    |        |               |         |       |         |                    |
| 4.3pF   | ±0.1pF             | GCG1552C1H4R3BA01# | 6.1pF | ±0.1pF             | GCG1552C1H6R1BA01# |        |               |         |       |         |                    |
|         | ±0.25pF            | GCG1552C1H4R3CA01# |       | ±0.25pF            | GCG1552C1H6R1CA01# |        |               |         |       |         |                    |
|         | ±0.5pF             | GCG1552C1H4R3DA01# |       | ±0.5pF             | GCG1552C1H6R1DA01# |        |               |         |       |         |                    |
| 4.4pF   | ±0.1pF             | GCG1552C1H4R4BA01# | 6.2pF | ±0.1pF             | GCG1552C1H6R2BA01# |        |               |         |       |         |                    |

Part number # indicates the package specification code.

GRT Series  
 GCM Series  
 GC3 Series  
 GCJ Series  
 GCQ Series  
 GCD Series  
 GCE Series  
 NMF Series  
 KCM Series  
 KC3 Series  
 KCA Series  
 GCB Series  
 GCG Series  
 ⚠Caution /Notice

# GCG Series Temperature Compensating Type Part Number List

(→ 1.0×0.5mm)

| T max.  | Rated Voltage      | TC Code            | Cap.  | Tol.               | Part Number        | T max. | Rated Voltage | TC Code | Cap.    | Tol.               | Part Number        |
|---------|--------------------|--------------------|-------|--------------------|--------------------|--------|---------------|---------|---------|--------------------|--------------------|
| 0.55mm  | 50Vdc              | CH                 | 6.2pF | ±0.25pF            | GCG1552C1H6R2CA01# | 0.55mm | 50Vdc         | CH      | 8.0pF   | ±0.25pF            | GCG1552C1H8ROCA01# |
|         |                    |                    |       | ±0.5pF             | GCG1552C1H6R2DA01# |        |               |         |         | ±0.5pF             | GCG1552C1H8RODA01# |
|         |                    |                    | 6.3pF | ±0.1pF             | GCG1552C1H6R3BA01# | 8.1pF  |               |         | ±0.1pF  | GCG1552C1H8R1BA01# |                    |
|         |                    |                    |       | ±0.25pF            | GCG1552C1H6R3CA01# |        |               |         | ±0.25pF | GCG1552C1H8R1CA01# |                    |
|         |                    |                    |       | ±0.5pF             | GCG1552C1H6R3DA01# |        |               |         | ±0.5pF  | GCG1552C1H8R1DA01# |                    |
|         |                    |                    | 6.4pF | ±0.1pF             | GCG1552C1H6R4BA01# | 8.2pF  |               |         | ±0.1pF  | GCG1552C1H8R2BA01# |                    |
|         |                    |                    |       | ±0.25pF            | GCG1552C1H6R4CA01# |        |               |         | ±0.25pF | GCG1552C1H8R2CA01# |                    |
|         |                    |                    |       | ±0.5pF             | GCG1552C1H6R4DA01# |        |               |         | ±0.5pF  | GCG1552C1H8R2DA01# |                    |
|         |                    |                    | 6.5pF | ±0.1pF             | GCG1552C1H6R5BA01# | 8.3pF  |               |         | ±0.1pF  | GCG1552C1H8R3BA01# |                    |
|         |                    |                    |       | ±0.25pF            | GCG1552C1H6R5CA01# |        |               |         | ±0.25pF | GCG1552C1H8R3CA01# |                    |
|         |                    |                    |       | ±0.5pF             | GCG1552C1H6R5DA01# |        |               |         | ±0.5pF  | GCG1552C1H8R3DA01# |                    |
|         |                    |                    | 6.6pF | ±0.1pF             | GCG1552C1H6R6BA01# | 8.4pF  |               |         | ±0.1pF  | GCG1552C1H8R4BA01# |                    |
|         |                    |                    |       | ±0.25pF            | GCG1552C1H6R6CA01# |        |               |         | ±0.25pF | GCG1552C1H8R4CA01# |                    |
|         |                    |                    |       | ±0.5pF             | GCG1552C1H6R6DA01# |        |               |         | ±0.5pF  | GCG1552C1H8R4DA01# |                    |
|         |                    |                    | 6.7pF | ±0.1pF             | GCG1552C1H6R7BA01# | 8.5pF  |               |         | ±0.1pF  | GCG1552C1H8R5BA01# |                    |
|         |                    |                    |       | ±0.25pF            | GCG1552C1H6R7CA01# |        |               |         | ±0.25pF | GCG1552C1H8R5CA01# |                    |
|         |                    |                    |       | ±0.5pF             | GCG1552C1H6R7DA01# |        |               |         | ±0.5pF  | GCG1552C1H8R5DA01# |                    |
|         |                    |                    | 6.8pF | ±0.1pF             | GCG1552C1H6R8BA01# | 8.6pF  |               |         | ±0.1pF  | GCG1552C1H8R6BA01# |                    |
|         |                    |                    |       | ±0.25pF            | GCG1552C1H6R8CA01# |        |               |         | ±0.25pF | GCG1552C1H8R6CA01# |                    |
|         |                    |                    |       | ±0.5pF             | GCG1552C1H6R8DA01# |        |               |         | ±0.5pF  | GCG1552C1H8R6DA01# |                    |
|         |                    |                    | 6.9pF | ±0.1pF             | GCG1552C1H6R9BA01# | 8.7pF  |               |         | ±0.1pF  | GCG1552C1H8R7BA01# |                    |
|         |                    |                    |       | ±0.25pF            | GCG1552C1H6R9CA01# |        |               |         | ±0.25pF | GCG1552C1H8R7CA01# |                    |
|         |                    |                    |       | ±0.5pF             | GCG1552C1H6R9DA01# |        |               |         | ±0.5pF  | GCG1552C1H8R7DA01# |                    |
|         |                    |                    | 7.0pF | ±0.1pF             | GCG1552C1H7R0BA01# | 8.8pF  |               |         | ±0.1pF  | GCG1552C1H8R8BA01# |                    |
|         |                    |                    |       | ±0.25pF            | GCG1552C1H7R0CA01# |        |               |         | ±0.25pF | GCG1552C1H8R8CA01# |                    |
|         |                    |                    |       | ±0.5pF             | GCG1552C1H7R0DA01# |        |               |         | ±0.5pF  | GCG1552C1H8R8DA01# |                    |
|         |                    |                    | 7.1pF | ±0.1pF             | GCG1552C1H7R1BA01# | 8.9pF  |               |         | ±0.1pF  | GCG1552C1H8R9BA01# |                    |
|         |                    |                    |       | ±0.25pF            | GCG1552C1H7R1CA01# |        |               |         | ±0.25pF | GCG1552C1H8R9CA01# |                    |
|         |                    |                    |       | ±0.5pF             | GCG1552C1H7R1DA01# |        |               |         | ±0.5pF  | GCG1552C1H8R9DA01# |                    |
|         |                    |                    | 7.2pF | ±0.1pF             | GCG1552C1H7R2BA01# | 9.0pF  |               |         | ±0.1pF  | GCG1552C1H9R0BA01# |                    |
|         |                    |                    |       | ±0.25pF            | GCG1552C1H7R2CA01# |        |               |         | ±0.25pF | GCG1552C1H9R0CA01# |                    |
|         |                    |                    |       | ±0.5pF             | GCG1552C1H7R2DA01# |        |               |         | ±0.5pF  | GCG1552C1H9R0DA01# |                    |
|         |                    |                    | 7.3pF | ±0.1pF             | GCG1552C1H7R3BA01# | 9.1pF  |               |         | ±0.1pF  | GCG1552C1H9R1BA01# |                    |
|         |                    |                    |       | ±0.25pF            | GCG1552C1H7R3CA01# |        |               |         | ±0.25pF | GCG1552C1H9R1CA01# |                    |
|         |                    |                    |       | ±0.5pF             | GCG1552C1H7R3DA01# |        |               |         | ±0.5pF  | GCG1552C1H9R1DA01# |                    |
|         |                    |                    | 7.4pF | ±0.1pF             | GCG1552C1H7R4BA01# | 9.2pF  |               |         | ±0.1pF  | GCG1552C1H9R2BA01# |                    |
|         |                    |                    |       | ±0.25pF            | GCG1552C1H7R4CA01# |        |               |         | ±0.25pF | GCG1552C1H9R2CA01# |                    |
|         |                    |                    |       | ±0.5pF             | GCG1552C1H7R4DA01# |        |               |         | ±0.5pF  | GCG1552C1H9R2DA01# |                    |
|         |                    |                    | 7.5pF | ±0.1pF             | GCG1552C1H7R5BA01# | 9.3pF  |               |         | ±0.1pF  | GCG1552C1H9R3BA01# |                    |
|         |                    |                    |       | ±0.25pF            | GCG1552C1H7R5CA01# |        |               |         | ±0.25pF | GCG1552C1H9R3CA01# |                    |
|         |                    |                    |       | ±0.5pF             | GCG1552C1H7R5DA01# |        |               |         | ±0.5pF  | GCG1552C1H9R3DA01# |                    |
|         |                    |                    | 7.6pF | ±0.1pF             | GCG1552C1H7R6BA01# | 9.4pF  |               |         | ±0.1pF  | GCG1552C1H9R4BA01# |                    |
|         |                    |                    |       | ±0.25pF            | GCG1552C1H7R6CA01# |        |               |         | ±0.25pF | GCG1552C1H9R4CA01# |                    |
|         |                    |                    |       | ±0.5pF             | GCG1552C1H7R6DA01# |        |               |         | ±0.5pF  | GCG1552C1H9R4DA01# |                    |
|         |                    |                    | 7.7pF | ±0.1pF             | GCG1552C1H7R7BA01# | 9.5pF  |               |         | ±0.1pF  | GCG1552C1H9R5BA01# |                    |
|         |                    |                    |       | ±0.25pF            | GCG1552C1H7R7CA01# |        |               |         | ±0.25pF | GCG1552C1H9R5CA01# |                    |
|         |                    |                    |       | ±0.5pF             | GCG1552C1H7R7DA01# |        |               |         | ±0.5pF  | GCG1552C1H9R5DA01# |                    |
|         |                    |                    | 7.8pF | ±0.1pF             | GCG1552C1H7R8BA01# | 9.6pF  |               |         | ±0.1pF  | GCG1552C1H9R6BA01# |                    |
| ±0.25pF | GCG1552C1H7R8CA01# | ±0.25pF            |       | GCG1552C1H9R6CA01# |                    |        |               |         |         |                    |                    |
| ±0.5pF  | GCG1552C1H7R8DA01# | ±0.5pF             |       | GCG1552C1H9R6DA01# |                    |        |               |         |         |                    |                    |
| 7.9pF   | ±0.1pF             | GCG1552C1H7R9BA01# | 9.7pF | ±0.1pF             | GCG1552C1H9R7BA01# |        |               |         |         |                    |                    |
|         | ±0.25pF            | GCG1552C1H7R9CA01# |       | ±0.25pF            | GCG1552C1H9R7CA01# |        |               |         |         |                    |                    |
|         | ±0.5pF             | GCG1552C1H7R9DA01# |       | ±0.5pF             | GCG1552C1H9R7DA01# |        |               |         |         |                    |                    |
| 8.0pF   | ±0.1pF             | GCG1552C1H8R0BA01# | 9.8pF | ±0.1pF             | GCG1552C1H9R8BA01# |        |               |         |         |                    |                    |

Part number # indicates the package specification code.

GRT Series  
 GCM Series  
 GC3 Series  
 GCJ Series  
 GCQ Series  
 GCD Series  
 GCE Series  
 NMF Series  
 KCM Series  
 KC3 Series  
 KCA Series  
 GCB Series  
 GCG Series  
 ⚠Caution /Notice

# GCG Series Temperature Compensating Type Power-train AEC-Q200 Deflecting crack Soldering crack Limited to conductive glue mounting Part Number List

(→ 1.0×0.5mm)

| T max. | Rated Voltage | TC Code | Cap.    | Tol.               | Part Number        | T max.             | Rated Voltage      | TC Code            | Cap.    | Tol.               | Part Number        |        |
|--------|---------------|---------|---------|--------------------|--------------------|--------------------|--------------------|--------------------|---------|--------------------|--------------------|--------|
| 0.55mm | 50Vdc         | CH      | 9.8pF   | ±0.25pF            | GCG1552C1H9R8CA01# | 0.55mm             | 50Vdc              | CJ                 | 3.6pF   | ±0.25pF            | GCG1553C1H3R6CA01# |        |
|        |               |         |         | ±0.5pF             | GCG1552C1H9R8DA01# |                    |                    |                    |         | ±0.5pF             | GCG1553C1H3R6DA01# |        |
|        |               |         | 9.9pF   | ±0.1pF             | GCG1552C1H9R9BA01# |                    |                    |                    | 3.7pF   | ±0.1pF             | GCG1553C1H3R7BA01# |        |
|        |               |         |         | ±0.25pF            | GCG1552C1H9R9CA01# |                    |                    |                    |         | ±0.25pF            | GCG1553C1H3R7CA01# |        |
|        |               |         |         | ±0.5pF             | GCG1552C1H9R9DA01# |                    |                    |                    |         | ±0.5pF             | GCG1553C1H3R7DA01# |        |
|        |               |         |         | 10pF               | ±1%                |                    |                    |                    |         | GCG1552C1H100FA01# | 3.8pF              | ±0.1pF |
|        |               |         | ±2.5%   |                    | GCG1552C1H100RA01# |                    |                    |                    | ±0.25pF | GCG1553C1H3R8CA01# |                    |        |
|        |               |         | ±5%     |                    | GCG1552C1H100JA01# |                    |                    |                    | ±0.5pF  | GCG1553C1H3R8DA01# |                    |        |
|        |               |         | 2.1pF   | ±0.1pF             | GCG1553C1H2R1BA01# |                    |                    |                    | 3.9pF   | ±0.1pF             | GCG1553C1H3R9BA01# |        |
|        |               |         |         | ±0.25pF            | GCG1553C1H2R1CA01# |                    |                    |                    |         | ±0.25pF            | GCG1553C1H3R9CA01# |        |
|        |               |         |         | ±0.5pF             | GCG1553C1H2R1DA01# |                    |                    |                    |         | ±0.5pF             | GCG1553C1H3R9DA01# |        |
|        |               |         | 2.2pF   | ±0.1pF             | GCG1553C1H2R2BA01# |                    |                    |                    | 1.0pF   | ±0.1pF             | GCG1554C1H1R0BA01# |        |
|        |               |         |         | ±0.25pF            | GCG1553C1H2R2CA01# |                    |                    |                    |         | ±0.25pF            | GCG1554C1H1R0CA01# |        |
|        |               |         |         | ±0.5pF             | GCG1553C1H2R2DA01# |                    |                    |                    |         | ±0.5pF             | GCG1554C1H1R0DA01# |        |
|        |               |         | 2.3pF   | ±0.1pF             | GCG1553C1H2R3BA01# |                    |                    |                    | 1.1pF   | ±0.1pF             | GCG1554C1H1R1BA01# |        |
|        |               |         |         | ±0.25pF            | GCG1553C1H2R3CA01# |                    |                    |                    |         | ±0.25pF            | GCG1554C1H1R1CA01# |        |
|        |               |         |         | ±0.5pF             | GCG1553C1H2R3DA01# |                    |                    |                    |         | ±0.5pF             | GCG1554C1H1R1DA01# |        |
|        |               |         | 2.4pF   | ±0.1pF             | GCG1553C1H2R4BA01# |                    |                    |                    | 1.2pF   | ±0.1pF             | GCG1554C1H1R2BA01# |        |
|        |               |         |         | ±0.25pF            | GCG1553C1H2R4CA01# |                    |                    |                    |         | ±0.25pF            | GCG1554C1H1R2CA01# |        |
|        |               |         |         | ±0.5pF             | GCG1553C1H2R4DA01# |                    |                    |                    |         | ±0.5pF             | GCG1554C1H1R2DA01# |        |
|        |               |         | 2.5pF   | ±0.1pF             | GCG1553C1H2R5BA01# |                    |                    |                    | 1.3pF   | ±0.1pF             | GCG1554C1H1R3BA01# |        |
|        |               |         |         | ±0.25pF            | GCG1553C1H2R5CA01# |                    |                    |                    |         | ±0.25pF            | GCG1554C1H1R3CA01# |        |
|        |               |         |         | ±0.5pF             | GCG1553C1H2R5DA01# |                    |                    |                    |         | ±0.5pF             | GCG1554C1H1R3DA01# |        |
|        |               |         | 2.6pF   | ±0.1pF             | GCG1553C1H2R6BA01# |                    |                    |                    | 1.4pF   | ±0.1pF             | GCG1554C1H1R4BA01# |        |
|        |               |         |         | ±0.25pF            | GCG1553C1H2R6CA01# |                    |                    |                    |         | ±0.25pF            | GCG1554C1H1R4CA01# |        |
|        |               |         |         | ±0.5pF             | GCG1553C1H2R6DA01# |                    |                    |                    |         | ±0.5pF             | GCG1554C1H1R4DA01# |        |
|        |               |         | 2.7pF   | ±0.1pF             | GCG1553C1H2R7BA01# |                    |                    |                    | 1.5pF   | ±0.1pF             | GCG1554C1H1R5BA01# |        |
|        |               |         |         | ±0.25pF            | GCG1553C1H2R7CA01# |                    |                    |                    |         | ±0.25pF            | GCG1554C1H1R5CA01# |        |
|        |               |         |         | ±0.5pF             | GCG1553C1H2R7DA01# |                    |                    |                    |         | ±0.5pF             | GCG1554C1H1R5DA01# |        |
|        |               |         | 2.8pF   | ±0.1pF             | GCG1553C1H2R8BA01# |                    |                    |                    | 1.6pF   | ±0.1pF             | GCG1554C1H1R6BA01# |        |
|        |               | ±0.25pF |         | GCG1553C1H2R8CA01# | ±0.25pF            | GCG1554C1H1R6CA01# |                    |                    |         |                    |                    |        |
|        |               | ±0.5pF  |         | GCG1553C1H2R8DA01# | ±0.5pF             | GCG1554C1H1R6DA01# |                    |                    |         |                    |                    |        |
|        |               | 2.9pF   | ±0.1pF  | GCG1553C1H2R9BA01# | 1.7pF              | ±0.1pF             | GCG1554C1H1R7BA01# |                    |         |                    |                    |        |
|        |               |         | ±0.25pF | GCG1553C1H2R9CA01# |                    | ±0.25pF            | GCG1554C1H1R7CA01# |                    |         |                    |                    |        |
|        |               |         | ±0.5pF  | GCG1553C1H2R9DA01# |                    | ±0.5pF             | GCG1554C1H1R7DA01# |                    |         |                    |                    |        |
|        |               | 3.0pF   | ±0.1pF  | GCG1553C1H3R0BA01# | 1.8pF              | ±0.1pF             | GCG1554C1H1R8BA01# |                    |         |                    |                    |        |
|        |               |         | ±0.25pF | GCG1553C1H3R0CA01# |                    | ±0.25pF            | GCG1554C1H1R8CA01# |                    |         |                    |                    |        |
|        |               |         | ±0.5pF  | GCG1553C1H3R0DA01# |                    | ±0.5pF             | GCG1554C1H1R8DA01# |                    |         |                    |                    |        |
|        |               | 3.1pF   | ±0.1pF  | GCG1553C1H3R1BA01# | 1.9pF              | ±0.1pF             | GCG1554C1H1R9BA01# |                    |         |                    |                    |        |
|        |               |         | ±0.25pF | GCG1553C1H3R1CA01# |                    | ±0.25pF            | GCG1554C1H1R9CA01# |                    |         |                    |                    |        |
|        |               |         | ±0.5pF  | GCG1553C1H3R1DA01# |                    | ±0.5pF             | GCG1554C1H1R9DA01# |                    |         |                    |                    |        |
|        |               | 3.2pF   | ±0.1pF  | GCG1553C1H3R2BA01# | 2.0pF              | ±0.1pF             | GCG1554C1H2R0BA01# |                    |         |                    |                    |        |
|        |               |         | ±0.25pF | GCG1553C1H3R2CA01# |                    | ±0.25pF            | GCG1554C1H2R0CA01# |                    |         |                    |                    |        |
|        |               |         | ±0.5pF  | GCG1553C1H3R2DA01# |                    | ±0.5pF             | GCG1554C1H2R0DA01# |                    |         |                    |                    |        |
|        |               | 3.3pF   | ±0.1pF  | GCG1553C1H3R3BA01# | 1.0pF              | ±0.1pF             | GCG1550C1H1R0BA01# |                    |         |                    |                    |        |
|        |               |         | ±0.25pF | GCG1553C1H3R3CA01# |                    | ±0.25pF            | GCG1550C1H1R0CA01# |                    |         |                    |                    |        |
|        |               |         | ±0.5pF  | GCG1553C1H3R3DA01# |                    | ±0.5pF             | GCG1550C1H1R0DA01# |                    |         |                    |                    |        |
|        |               | 3.4pF   | ±0.1pF  | GCG1553C1H3R4BA01# | 1.1pF              | ±0.1pF             | GCG1550C1H1R1BA01# |                    |         |                    |                    |        |
|        |               |         | ±0.25pF | GCG1553C1H3R4CA01# |                    | ±0.25pF            | GCG1550C1H1R1CA01# |                    |         |                    |                    |        |
|        |               |         | ±0.5pF  | GCG1553C1H3R4DA01# |                    | ±0.5pF             | GCG1550C1H1R1DA01# |                    |         |                    |                    |        |
|        |               | 3.5pF   | ±0.1pF  | GCG1553C1H3R5BA01# | 1.2pF              | ±0.1pF             | GCG1550C1H1R2BA01# |                    |         |                    |                    |        |
|        |               |         | ±0.25pF | GCG1553C1H3R5CA01# |                    | ±0.25pF            | GCG1550C1H1R2CA01# |                    |         |                    |                    |        |
|        |               |         | ±0.5pF  | GCG1553C1H3R5DA01# |                    | ±0.5pF             | GCG1550C1H1R2DA01# |                    |         |                    |                    |        |
|        |               | 3.6pF   | ±0.1pF  | GCG1553C1H3R6BA01# | 1.3pF              | ±0.1pF             | GCG1550C1H1R3BA01# |                    |         |                    |                    |        |
|        |               |         |         |                    |                    |                    | ±0.25pF            | GCG1550C1H1R3CA01# |         |                    |                    |        |
|        |               |         |         |                    |                    |                    | ±0.5pF             | GCG1550C1H1R3DA01# |         |                    |                    |        |
|        |               |         |         |                    |                    |                    | CHA                |                    |         |                    |                    |        |

Part number # indicates the package specification code.

GRT Series  
 GCM Series  
 GC3 Series  
 GCJ Series  
 GCQ Series  
 GCD Series  
 GCE Series  
 NMF Series  
 KCM Series  
 KC3 Series  
 KCA Series  
 GCB Series  
 GCG Series  
 ⚠Caution /Notice

# GCG Series Temperature Compensating Type Part Number List

(→ 1.0×0.5mm)

| T max.  | Rated Voltage      | TC Code | Cap.               | Tol.               | Part Number        | T max. | Rated Voltage | TC Code | Cap.               | Tol.    | Part Number        |
|---------|--------------------|---------|--------------------|--------------------|--------------------|--------|---------------|---------|--------------------|---------|--------------------|
| 0.55mm  | 50Vdc              | CHA     | 1.3pF              | ±0.25pF            | GCG1550C1H1R3CA01# | 0.55mm | 50Vdc         | CHA     | 3.1pF              | ±0.25pF | GCG1550C1H3R1CA01# |
|         |                    |         |                    | ±0.5pF             | GCG1550C1H1R3DA01# |        |               |         |                    | ±0.5pF  | GCG1550C1H3R1DA01# |
|         |                    |         |                    | ±0.1pF             | GCG1550C1H1R4BA01# |        |               |         |                    | ±0.1pF  | GCG1550C1H3R2BA01# |
|         |                    |         | ±0.25pF            |                    | GCG1550C1H1R4CA01# |        |               |         | ±0.25pF            |         | GCG1550C1H3R2CA01# |
|         |                    |         | ±0.5pF             | GCG1550C1H1R4DA01# | ±0.5pF             |        |               |         | GCG1550C1H3R2DA01# |         |                    |
|         |                    |         |                    | ±0.1pF             |                    |        |               |         | GCG1550C1H1R5BA01# | ±0.1pF  | GCG1550C1H3R3BA01# |
|         |                    |         |                    |                    |                    |        |               |         | ±0.25pF            |         | GCG1550C1H1R5CA01# |
|         |                    |         | ±0.5pF             |                    | GCG1550C1H1R5DA01# |        |               |         | ±0.5pF             |         | GCG1550C1H3R3DA01# |
|         |                    |         | ±0.1pF             | GCG1550C1H1R6BA01# | ±0.1pF             |        |               |         | GCG1550C1H3R4BA01# |         |                    |
|         |                    |         |                    | ±0.25pF            |                    |        |               |         | GCG1550C1H1R6CA01# | ±0.25pF | GCG1550C1H3R4CA01# |
|         |                    |         |                    | ±0.5pF             |                    |        |               |         | GCG1550C1H1R6DA01# | ±0.5pF  | GCG1550C1H3R4DA01# |
|         |                    |         | ±0.1pF             | GCG1550C1H1R7BA01# | ±0.1pF             |        |               |         | GCG1550C1H3R5BA01# |         |                    |
|         |                    |         |                    | ±0.25pF            |                    |        |               |         | GCG1550C1H1R7CA01# | ±0.25pF | GCG1550C1H3R5CA01# |
|         |                    |         |                    | ±0.5pF             |                    |        |               |         | GCG1550C1H1R7DA01# | ±0.5pF  | GCG1550C1H3R5DA01# |
|         |                    |         | ±0.1pF             | GCG1550C1H1R8BA01# | ±0.1pF             |        |               |         | GCG1550C1H3R6BA01# |         |                    |
|         |                    |         |                    | ±0.25pF            |                    |        |               |         | GCG1550C1H1R8CA01# | ±0.25pF | GCG1550C1H3R6CA01# |
|         |                    |         |                    | ±0.5pF             |                    |        |               |         | GCG1550C1H1R8DA01# | ±0.5pF  | GCG1550C1H3R6DA01# |
|         |                    |         | ±0.1pF             | GCG1550C1H1R9BA01# | ±0.1pF             |        |               |         | GCG1550C1H3R7BA01# |         |                    |
|         |                    |         |                    | ±0.25pF            |                    |        |               |         | GCG1550C1H1R9CA01# | ±0.25pF | GCG1550C1H3R7CA01# |
|         |                    |         |                    | ±0.5pF             |                    |        |               |         | GCG1550C1H1R9DA01# | ±0.5pF  | GCG1550C1H3R7DA01# |
|         |                    |         | ±0.1pF             | GCG1550C1H2R0BA01# | ±0.1pF             |        |               |         | GCG1550C1H3R8BA01# |         |                    |
|         |                    |         |                    | ±0.25pF            |                    |        |               |         | GCG1550C1H2R0CA01# | ±0.25pF | GCG1550C1H3R8CA01# |
|         |                    |         |                    | ±0.5pF             |                    |        |               |         | GCG1550C1H2R0DA01# | ±0.5pF  | GCG1550C1H3R8DA01# |
|         |                    |         | ±0.1pF             | GCG1550C1H2R1BA01# | ±0.1pF             |        |               |         | GCG1550C1H3R9BA01# |         |                    |
|         |                    |         |                    | ±0.25pF            |                    |        |               |         | GCG1550C1H2R1CA01# | ±0.25pF | GCG1550C1H3R9CA01# |
|         |                    |         |                    | ±0.5pF             |                    |        |               |         | GCG1550C1H2R1DA01# | ±0.5pF  | GCG1550C1H3R9DA01# |
|         |                    |         | ±0.1pF             | GCG1550C1H2R2BA01# | ±0.1pF             |        |               |         | GCG1550C1H4R0BA01# |         |                    |
|         |                    |         |                    | ±0.25pF            |                    |        |               |         | GCG1550C1H2R2CA01# | ±0.25pF | GCG1550C1H4R0CA01# |
|         |                    |         |                    | ±0.5pF             |                    |        |               |         | GCG1550C1H2R2DA01# | ±0.5pF  | GCG1550C1H4R0DA01# |
|         |                    |         | ±0.1pF             | GCG1550C1H2R3BA01# | ±0.1pF             |        |               |         | GCG1550C1H4R1BA01# |         |                    |
|         |                    |         |                    | ±0.25pF            |                    |        |               |         | GCG1550C1H2R3CA01# | ±0.25pF | GCG1550C1H4R1CA01# |
|         |                    |         |                    | ±0.5pF             |                    |        |               |         | GCG1550C1H2R3DA01# | ±0.5pF  | GCG1550C1H4R1DA01# |
|         |                    |         | ±0.1pF             | GCG1550C1H2R4BA01# | ±0.1pF             |        |               |         | GCG1550C1H4R2BA01# |         |                    |
|         |                    |         |                    | ±0.25pF            |                    |        |               |         | GCG1550C1H2R4CA01# | ±0.25pF | GCG1550C1H4R2CA01# |
|         |                    |         |                    | ±0.5pF             |                    |        |               |         | GCG1550C1H2R4DA01# | ±0.5pF  | GCG1550C1H4R2DA01# |
|         |                    |         | ±0.1pF             | GCG1550C1H2R5BA01# | ±0.1pF             |        |               |         | GCG1550C1H4R3BA01# |         |                    |
|         |                    |         |                    | ±0.25pF            |                    |        |               |         | GCG1550C1H2R5CA01# | ±0.25pF | GCG1550C1H4R3CA01# |
|         |                    |         |                    | ±0.5pF             |                    |        |               |         | GCG1550C1H2R5DA01# | ±0.5pF  | GCG1550C1H4R3DA01# |
|         |                    |         | ±0.1pF             | GCG1550C1H2R6BA01# | ±0.1pF             |        |               |         | GCG1550C1H4R4BA01# |         |                    |
|         |                    |         |                    | ±0.25pF            |                    |        |               |         | GCG1550C1H2R6CA01# | ±0.25pF | GCG1550C1H4R4CA01# |
|         |                    |         |                    | ±0.5pF             |                    |        |               |         | GCG1550C1H2R6DA01# | ±0.5pF  | GCG1550C1H4R4DA01# |
|         |                    |         | ±0.1pF             | GCG1550C1H2R7BA01# | ±0.1pF             |        |               |         | GCG1550C1H4R5BA01# |         |                    |
| ±0.25pF | GCG1550C1H2R7CA01# | ±0.25pF |                    | GCG1550C1H4R5CA01# |                    |        |               |         |                    |         |                    |
| ±0.5pF  | GCG1550C1H2R7DA01# | ±0.5pF  |                    | GCG1550C1H4R5DA01# |                    |        |               |         |                    |         |                    |
| ±0.1pF  | GCG1550C1H2R8BA01# | ±0.1pF  | GCG1550C1H4R6BA01# |                    |                    |        |               |         |                    |         |                    |
|         | ±0.25pF            |         | GCG1550C1H2R8CA01# | ±0.25pF            | GCG1550C1H4R6CA01# |        |               |         |                    |         |                    |
|         | ±0.5pF             |         | GCG1550C1H2R8DA01# | ±0.5pF             | GCG1550C1H4R6DA01# |        |               |         |                    |         |                    |
| ±0.1pF  | GCG1550C1H2R9BA01# | ±0.1pF  | GCG1550C1H4R7BA01# |                    |                    |        |               |         |                    |         |                    |
|         | ±0.25pF            |         | GCG1550C1H2R9CA01# | ±0.25pF            | GCG1550C1H4R7CA01# |        |               |         |                    |         |                    |
|         | ±0.5pF             |         | GCG1550C1H2R9DA01# | ±0.5pF             | GCG1550C1H4R7DA01# |        |               |         |                    |         |                    |
| ±0.1pF  | GCG1550C1H3R0BA01# | ±0.1pF  | GCG1550C1H4R8BA01# |                    |                    |        |               |         |                    |         |                    |
|         | ±0.25pF            |         | GCG1550C1H3R0CA01# | ±0.25pF            | GCG1550C1H4R8CA01# |        |               |         |                    |         |                    |
|         | ±0.5pF             |         | GCG1550C1H3R0DA01# | ±0.5pF             | GCG1550C1H4R8DA01# |        |               |         |                    |         |                    |
| ±0.1pF  | GCG1550C1H3R1BA01# | ±0.1pF  | GCG1550C1H4R9BA01# |                    |                    |        |               |         |                    |         |                    |

Part number # indicates the package specification code.

GRT Series  
 GCM Series  
 GC3 Series  
 GCJ Series  
 GCQ Series  
 GCD Series  
 GCE Series  
 NMF Series  
 KCM Series  
 KC3 Series  
 KCA Series  
 GCB Series  
 GCG Series  
 ⚠Caution /Notice

# GCG Series Temperature Compensating Type Part Number List

(→ 1.0×0.5mm)

| T max. | Rated Voltage | TC Code | Cap.    | Tol.    | Part Number        | T max. | Rated Voltage | TC Code | Cap.    | Tol.               | Part Number        |
|--------|---------------|---------|---------|---------|--------------------|--------|---------------|---------|---------|--------------------|--------------------|
| 0.55mm | 50Vdc         | CHA     | 4.9pF   | ±0.25pF | GCG1550C1H4R9CA01# | 0.55mm | 50Vdc         | CHA     | 6.7pF   | ±0.25pF            | GCG1550C1H6R7CA01# |
|        |               |         |         | ±0.5pF  | GCG1550C1H4R9DA01# |        |               |         |         | ±0.5pF             | GCG1550C1H6R7DA01# |
|        |               |         |         | 5.0pF   | ±0.1pF             |        |               |         |         | GCG1550C1H5R0BA01# | 6.8pF              |
|        |               |         | ±0.25pF |         | GCG1550C1H5R0CA01# |        |               |         | ±0.25pF | GCG1550C1H6R8CA01# |                    |
|        |               |         | ±0.5pF  |         | GCG1550C1H5R0DA01# |        |               |         | ±0.5pF  | GCG1550C1H6R8DA01# |                    |
|        |               |         | 5.1pF   | ±0.1pF  | GCG1550C1H5R1BA01# |        |               |         | 6.9pF   | ±0.1pF             | GCG1550C1H6R9BA01# |
|        |               |         |         | ±0.25pF | GCG1550C1H5R1CA01# |        |               |         |         | ±0.25pF            | GCG1550C1H6R9CA01# |
|        |               |         |         | ±0.5pF  | GCG1550C1H5R1DA01# |        |               |         |         | ±0.5pF             | GCG1550C1H6R9DA01# |
|        |               |         | 5.2pF   | ±0.1pF  | GCG1550C1H5R2BA01# |        |               |         | 7.0pF   | ±0.1pF             | GCG1550C1H7R0BA01# |
|        |               |         |         | ±0.25pF | GCG1550C1H5R2CA01# |        |               |         |         | ±0.25pF            | GCG1550C1H7R0CA01# |
|        |               |         |         | ±0.5pF  | GCG1550C1H5R2DA01# |        |               |         |         | ±0.5pF             | GCG1550C1H7R0DA01# |
|        |               |         | 5.3pF   | ±0.1pF  | GCG1550C1H5R3BA01# |        |               |         | 7.1pF   | ±0.1pF             | GCG1550C1H7R1BA01# |
|        |               |         |         | ±0.25pF | GCG1550C1H5R3CA01# |        |               |         |         | ±0.25pF            | GCG1550C1H7R1CA01# |
|        |               |         |         | ±0.5pF  | GCG1550C1H5R3DA01# |        |               |         |         | ±0.5pF             | GCG1550C1H7R1DA01# |
|        |               |         | 5.4pF   | ±0.1pF  | GCG1550C1H5R4BA01# |        |               |         | 7.2pF   | ±0.1pF             | GCG1550C1H7R2BA01# |
|        |               |         |         | ±0.25pF | GCG1550C1H5R4CA01# |        |               |         |         | ±0.25pF            | GCG1550C1H7R2CA01# |
|        |               |         |         | ±0.5pF  | GCG1550C1H5R4DA01# |        |               |         |         | ±0.5pF             | GCG1550C1H7R2DA01# |
|        |               |         | 5.5pF   | ±0.1pF  | GCG1550C1H5R5BA01# |        |               |         | 7.3pF   | ±0.1pF             | GCG1550C1H7R3BA01# |
|        |               |         |         | ±0.25pF | GCG1550C1H5R5CA01# |        |               |         |         | ±0.25pF            | GCG1550C1H7R3CA01# |
|        |               |         |         | ±0.5pF  | GCG1550C1H5R5DA01# |        |               |         |         | ±0.5pF             | GCG1550C1H7R3DA01# |
|        |               |         | 5.6pF   | ±0.1pF  | GCG1550C1H5R6BA01# |        |               |         | 7.4pF   | ±0.1pF             | GCG1550C1H7R4BA01# |
|        |               |         |         | ±0.25pF | GCG1550C1H5R6CA01# |        |               |         |         | ±0.25pF            | GCG1550C1H7R4CA01# |
|        |               |         |         | ±0.5pF  | GCG1550C1H5R6DA01# |        |               |         |         | ±0.5pF             | GCG1550C1H7R4DA01# |
|        |               |         | 5.7pF   | ±0.1pF  | GCG1550C1H5R7BA01# |        |               |         | 7.5pF   | ±0.1pF             | GCG1550C1H7R5BA01# |
|        |               |         |         | ±0.25pF | GCG1550C1H5R7CA01# |        |               |         |         | ±0.25pF            | GCG1550C1H7R5CA01# |
|        |               |         |         | ±0.5pF  | GCG1550C1H5R7DA01# |        |               |         |         | ±0.5pF             | GCG1550C1H7R5DA01# |
|        |               |         | 5.8pF   | ±0.1pF  | GCG1550C1H5R8BA01# |        |               |         | 7.6pF   | ±0.1pF             | GCG1550C1H7R6BA01# |
|        |               |         |         | ±0.25pF | GCG1550C1H5R8CA01# |        |               |         |         | ±0.25pF            | GCG1550C1H7R6CA01# |
|        |               |         |         | ±0.5pF  | GCG1550C1H5R8DA01# |        |               |         |         | ±0.5pF             | GCG1550C1H7R6DA01# |
|        |               |         | 5.9pF   | ±0.1pF  | GCG1550C1H5R9BA01# |        |               |         | 7.7pF   | ±0.1pF             | GCG1550C1H7R7BA01# |
|        |               |         |         | ±0.25pF | GCG1550C1H5R9CA01# |        |               |         |         | ±0.25pF            | GCG1550C1H7R7CA01# |
|        |               |         |         | ±0.5pF  | GCG1550C1H5R9DA01# |        |               |         |         | ±0.5pF             | GCG1550C1H7R7DA01# |
|        |               |         | 6.0pF   | ±0.1pF  | GCG1550C1H6R0BA01# |        |               |         | 7.8pF   | ±0.1pF             | GCG1550C1H7R8BA01# |
|        |               |         |         | ±0.25pF | GCG1550C1H6R0CA01# |        |               |         |         | ±0.25pF            | GCG1550C1H7R8CA01# |
|        |               |         |         | ±0.5pF  | GCG1550C1H6R0DA01# |        |               |         |         | ±0.5pF             | GCG1550C1H7R8DA01# |
|        |               |         | 6.1pF   | ±0.1pF  | GCG1550C1H6R1BA01# |        |               |         | 7.9pF   | ±0.1pF             | GCG1550C1H7R9BA01# |
|        |               |         |         | ±0.25pF | GCG1550C1H6R1CA01# |        |               |         |         | ±0.25pF            | GCG1550C1H7R9CA01# |
|        |               |         |         | ±0.5pF  | GCG1550C1H6R1DA01# |        |               |         |         | ±0.5pF             | GCG1550C1H7R9DA01# |
|        |               |         | 6.2pF   | ±0.1pF  | GCG1550C1H6R2BA01# |        |               |         | 8.0pF   | ±0.1pF             | GCG1550C1H8R0BA01# |
|        |               |         |         | ±0.25pF | GCG1550C1H6R2CA01# |        |               |         |         | ±0.25pF            | GCG1550C1H8R0CA01# |
|        |               |         |         | ±0.5pF  | GCG1550C1H6R2DA01# |        |               |         |         | ±0.5pF             | GCG1550C1H8R0DA01# |
|        |               |         | 6.3pF   | ±0.1pF  | GCG1550C1H6R3BA01# |        |               |         | 8.1pF   | ±0.1pF             | GCG1550C1H8R1BA01# |
|        |               |         |         | ±0.25pF | GCG1550C1H6R3CA01# |        |               |         |         | ±0.25pF            | GCG1550C1H8R1CA01# |
|        |               |         |         | ±0.5pF  | GCG1550C1H6R3DA01# |        |               |         |         | ±0.5pF             | GCG1550C1H8R1DA01# |
|        |               |         | 6.4pF   | ±0.1pF  | GCG1550C1H6R4BA01# |        |               |         | 8.2pF   | ±0.1pF             | GCG1550C1H8R2BA01# |
|        |               |         |         | ±0.25pF | GCG1550C1H6R4CA01# |        |               |         |         | ±0.25pF            | GCG1550C1H8R2CA01# |
|        |               |         |         | ±0.5pF  | GCG1550C1H6R4DA01# |        |               |         |         | ±0.5pF             | GCG1550C1H8R2DA01# |
|        |               |         | 6.5pF   | ±0.1pF  | GCG1550C1H6R5BA01# |        |               |         | 8.3pF   | ±0.1pF             | GCG1550C1H8R3BA01# |
|        |               |         |         | ±0.25pF | GCG1550C1H6R5CA01# |        |               |         |         | ±0.25pF            | GCG1550C1H8R3CA01# |
|        |               |         |         | ±0.5pF  | GCG1550C1H6R5DA01# |        |               |         |         | ±0.5pF             | GCG1550C1H8R3DA01# |
|        |               |         | 6.6pF   | ±0.1pF  | GCG1550C1H6R6BA01# |        |               |         | 8.4pF   | ±0.1pF             | GCG1550C1H8R4BA01# |
|        |               |         |         | ±0.25pF | GCG1550C1H6R6CA01# |        |               |         |         | ±0.25pF            | GCG1550C1H8R4CA01# |
|        |               |         |         | ±0.5pF  | GCG1550C1H6R6DA01# |        |               |         |         | ±0.5pF             | GCG1550C1H8R4DA01# |
|        |               |         | 6.7pF   | ±0.1pF  | GCG1550C1H6R7BA01# |        |               |         | 8.5pF   | ±0.1pF             | GCG1550C1H8R5BA01# |

Part number # indicates the package specification code.

GRT Series  
 GCM Series  
 GC3 Series  
 GCJ Series  
 GCQ Series  
 GCD Series  
 GCE Series  
 NMF Series  
 KCM Series  
 KC3 Series  
 KCA Series  
 GCB Series  
 GCG Series  
 ⚠Caution /Notice

# GCG Series Temperature Compensating Type Part Number List

(→ 1.0×0.5mm)

| T max. | Rated Voltage | TC Code | Cap.  | Tol.    | Part Number        | T max. | Rated Voltage | TC Code | Cap.  | Tol.  | Part Number        |                    |                    |
|--------|---------------|---------|-------|---------|--------------------|--------|---------------|---------|-------|-------|--------------------|--------------------|--------------------|
| 0.55mm | 50Vdc         | CHA     | 8.5pF | ±0.25pF | GCG1550C1H8R5CA01# | 0.55mm | 50Vdc         | CHA     | 15pF  | ±5%   | GCG1550C1H150JA01# |                    |                    |
|        |               |         |       | ±0.5pF  | GCG1550C1H8R5DA01# |        |               |         |       | 16pF  | ±2%                | GCG1550C1H160GA01# |                    |
|        |               |         | 8.6pF | ±0.1pF  | GCG1550C1H8R6BA01# |        |               |         | ±5%   |       | GCG1550C1H160JA01# | 18pF               | ±2%                |
|        |               |         |       | ±0.25pF | GCG1550C1H8R6CA01# |        |               |         |       | ±5%   | GCG1550C1H180JA01# |                    |                    |
|        |               |         |       | ±0.5pF  | GCG1550C1H8R6DA01# |        |               |         | 20pF  |       | ±2%                | GCG1550C1H200GA01# |                    |
|        |               |         |       | ±0.25pF | GCG1550C1H8R7CA01# |        |               |         |       | ±5%   | GCG1550C1H200JA01# |                    |                    |
|        |               |         | 8.7pF | ±0.1pF  | GCG1550C1H8R7BA01# |        |               |         | ±2%   |       | GCG1550C1H220GA01# | 22pF               | ±2%                |
|        |               |         |       | ±0.25pF | GCG1550C1H8R7CA01# |        |               |         |       | ±5%   | GCG1550C1H220JA01# |                    |                    |
|        |               |         |       | ±0.5pF  | GCG1550C1H8R7DA01# |        |               |         | 24pF  |       | ±2%                | GCG1550C1H240GA01# |                    |
|        |               |         | 8.8pF | ±0.1pF  | GCG1550C1H8R8BA01# |        |               |         |       | ±5%   | GCG1550C1H240JA01# | 27pF               | ±2%                |
|        |               |         |       | ±0.25pF | GCG1550C1H8R8CA01# |        |               |         | ±5%   |       | GCG1550C1H270JA01# |                    |                    |
|        |               |         |       | ±0.5pF  | GCG1550C1H8R8DA01# |        |               |         |       | 30pF  | ±2%                | GCG1550C1H300GA01# |                    |
|        |               |         | 8.9pF | ±0.1pF  | GCG1550C1H8R9BA01# |        |               |         | ±5%   |       | GCG1550C1H300JA01# | 33pF               | ±2%                |
|        |               |         |       | ±0.25pF | GCG1550C1H8R9CA01# |        |               |         |       | ±5%   | GCG1550C1H330JA01# |                    |                    |
|        |               |         |       | ±0.5pF  | GCG1550C1H8R9DA01# |        |               |         | 36pF  |       | ±2%                | GCG1550C1H360GA01# |                    |
|        |               |         | 9.0pF | ±0.1pF  | GCG1550C1H9R0BA01# |        |               |         |       | ±5%   | GCG1550C1H360JA01# | 39pF               | ±2%                |
|        |               |         |       | ±0.25pF | GCG1550C1H9R0CA01# |        |               |         | ±5%   |       | GCG1550C1H390JA01# |                    |                    |
|        |               |         |       | ±0.5pF  | GCG1550C1H9R0DA01# |        |               |         |       | 43pF  | ±2%                | GCG1550C1H430GA01# |                    |
|        |               |         | 9.1pF | ±0.1pF  | GCG1550C1H9R1BA01# |        |               |         | ±5%   |       | GCG1550C1H430JA01# | 47pF               | ±2%                |
|        |               |         |       | ±0.25pF | GCG1550C1H9R1CA01# |        |               |         |       | ±5%   | GCG1550C1H470JA01# |                    |                    |
|        |               |         |       | ±0.5pF  | GCG1550C1H9R1DA01# |        |               |         | 51pF  |       | ±2%                | GCG1550C1H510GA01# |                    |
|        |               |         | 9.2pF | ±0.1pF  | GCG1550C1H9R2BA01# |        |               |         |       | ±5%   | GCG1550C1H510JA01# | 56pF               | ±2%                |
|        |               |         |       | ±0.25pF | GCG1550C1H9R2CA01# |        |               |         | ±5%   |       | GCG1550C1H560JA01# |                    |                    |
|        |               |         |       | ±0.5pF  | GCG1550C1H9R2DA01# |        |               |         |       | 62pF  | ±2%                | GCG1550C1H620GA01# |                    |
|        |               |         | 9.3pF | ±0.1pF  | GCG1550C1H9R3BA01# |        |               |         | ±5%   |       | GCG1550C1H620JA01# | 68pF               | ±2%                |
|        |               |         |       | ±0.25pF | GCG1550C1H9R3CA01# |        |               |         |       | ±5%   | GCG1550C1H680JA01# |                    |                    |
|        |               |         |       | ±0.5pF  | GCG1550C1H9R3DA01# |        |               |         | 75pF  |       | ±2%                | GCG1550C1H750GA01# |                    |
|        |               |         | 9.4pF | ±0.1pF  | GCG1550C1H9R4BA01# |        |               |         |       | ±5%   | GCG1550C1H750JA01# | 82pF               | ±2%                |
|        |               |         |       | ±0.25pF | GCG1550C1H9R4CA01# |        |               |         | ±5%   |       | GCG1550C1H820JA01# |                    |                    |
|        |               |         |       | ±0.5pF  | GCG1550C1H9R4DA01# |        |               |         |       | 91pF  | ±2%                | GCG1550C1H910GA01# |                    |
|        |               |         | 9.5pF | ±0.1pF  | GCG1550C1H9R5BA01# |        |               |         | ±5%   |       | GCG1550C1H910JA01# | 100pF              | ±2%                |
|        |               |         |       | ±0.25pF | GCG1550C1H9R5CA01# |        |               |         |       | ±5%   | GCG1550C1H101JA01# |                    |                    |
|        |               |         |       | ±0.5pF  | GCG1550C1H9R5DA01# |        |               |         | X8G   |       | 1.0pF              | ±0.1pF             | GCG1555G1H1R0BA01# |
|        |               |         | 9.6pF | ±0.1pF  | GCG1550C1H9R6BA01# |        |               |         |       | ±5%   |                    | GCG1555G1H1R0CA01# | ±0.25pF            |
|        |               |         |       | ±0.25pF | GCG1550C1H9R6CA01# |        |               |         | ±5%   |       |                    | GCG1555G1H1R1BA01# |                    |
|        |               |         |       | ±0.5pF  | GCG1550C1H9R6DA01# |        |               |         |       | 75pF  | ±2%                | GCG1555G1H1R1DA01# |                    |
|        |               |         | 9.7pF | ±0.1pF  | GCG1550C1H9R7BA01# |        |               |         | ±5%   |       | GCG1555G1H1R2BA01# | ±0.25pF            | GCG1555G1H1R2CA01# |
|        |               |         |       | ±0.25pF | GCG1550C1H9R7CA01# |        |               |         |       | ±5%   | GCG1555G1H1R2DA01# |                    |                    |
|        |               |         |       | ±0.5pF  | GCG1550C1H9R7DA01# |        |               |         | 82pF  |       | ±2%                | GCG1555G1H1R3BA01# |                    |
|        |               |         | 9.8pF | ±0.1pF  | GCG1550C1H9R8BA01# |        |               |         |       | ±5%   | GCG1555G1H1R3CA01# | ±0.25pF            | GCG1555G1H1R3DA01# |
|        |               |         |       | ±0.25pF | GCG1550C1H9R8CA01# |        |               |         | ±5%   |       | GCG1555G1H1R4BA01# |                    |                    |
|        |               |         |       | ±0.5pF  | GCG1550C1H9R8DA01# |        |               |         |       | 91pF  | ±2%                | GCG1555G1H1R4CA01# |                    |
|        |               |         | 9.9pF | ±0.1pF  | GCG1550C1H9R9BA01# |        |               |         | ±5%   |       | GCG1555G1H1R4DA01# | 1.1pF              | ±0.1pF             |
|        |               |         |       | ±0.25pF | GCG1550C1H9R9CA01# |        |               |         |       | ±5%   | GCG1555G1H1R1CA01# |                    | ±0.25pF            |
|        |               |         |       | ±0.5pF  | GCG1550C1H9R9DA01# |        |               |         | 100pF |       | ±2%                | GCG1555G1H1R2BA01# |                    |
|        |               |         | 10pF  | ±1%     | GCG1550C1H100FA01# |        |               |         |       | ±5%   | GCG1555G1H1R2CA01# | ±0.5pF             | GCG1555G1H1R2DA01# |
|        |               |         |       | ±2.5%   | GCG1550C1H100RA01# |        |               |         | ±5%   |       | GCG1555G1H1R3BA01# |                    |                    |
|        |               |         |       | ±5%     | GCG1550C1H100JA01# |        |               |         |       | 1.2pF | ±0.1pF             | GCG1555G1H1R3CA01# |                    |
|        |               |         | 11pF  | ±2%     | GCG1550C1H110GA01# |        |               |         | ±5%   |       | GCG1555G1H1R3DA01# | 1.3pF              | ±0.1pF             |
|        |               |         |       | ±5%     | GCG1550C1H110JA01# |        |               |         |       | ±5%   | GCG1555G1H1R3CA01# |                    | ±0.25pF            |
|        |               |         | 12pF  | ±2%     | GCG1550C1H120GA01# |        |               |         | ±5%   |       | GCG1555G1H1R3DA01# | 1.4pF              |                    |
|        |               |         |       | ±5%     | GCG1550C1H120JA01# |        |               |         |       | ±5%   | GCG1555G1H1R4CA01# |                    |                    |
|        |               |         | 13pF  | ±2%     | GCG1550C1H130GA01# |        |               |         | ±5%   |       | GCG1555G1H1R4DA01# | 1.4pF              | ±0.1pF             |
|        |               |         |       | ±5%     | GCG1550C1H130JA01# |        |               |         |       | ±5%   | GCG1555G1H1R4CA01# |                    |                    |
|        |               |         | 15pF  | ±2%     | GCG1550C1H150GA01# |        |               |         | ±5%   |       | GCG1555G1H1R4DA01# | 1.4pF              | ±0.1pF             |
|        |               |         |       | ±5%     | GCG1550C1H150JA01# |        |               |         |       | ±5%   | GCG1555G1H1R4CA01# |                    |                    |

Part number # indicates the package specification code.

GRT Series  
 GCM Series  
 GC3 Series  
 GCJ Series  
 GCQ Series  
 GCD Series  
 GCE Series  
 NMF Series  
 KCM Series  
 KC3 Series  
 KCA Series  
 GCB Series  
 GCG Series  
 ⚠Caution /Notice



# GCG Series Temperature Compensating Type Part Number List

(→ 1.0×0.5mm)

| T max.  | Rated Voltage      | TC Code            | Cap.    | Tol.               | Part Number        | T max. | Rated Voltage | TC Code | Cap.    | Tol.               | Part Number        |
|---------|--------------------|--------------------|---------|--------------------|--------------------|--------|---------------|---------|---------|--------------------|--------------------|
| 0.55mm  | 50Vdc              | X8G                | 1.4pF   | ±0.25pF            | GCG1555G1H1R4CA01# | 0.55mm | 50Vdc         | X8G     | 3.2pF   | ±0.25pF            | GCG1555G1H3R2CA01# |
|         |                    |                    |         | ±0.5pF             | GCG1555G1H1R4DA01# |        |               |         |         | ±0.5pF             | GCG1555G1H3R2DA01# |
|         |                    |                    | 1.5pF   | ±0.1pF             | GCG1555G1H1R5BA01# |        |               |         | 3.3pF   | ±0.1pF             | GCG1555G1H3R3BA01# |
|         |                    |                    |         | ±0.25pF            | GCG1555G1H1R5CA01# |        |               |         |         | ±0.25pF            | GCG1555G1H3R3CA01# |
|         |                    |                    | ±0.5pF  | GCG1555G1H1R5DA01# | 3.4pF              |        |               |         | ±0.1pF  | GCG1555G1H3R4BA01# |                    |
|         |                    |                    |         | GCG1555G1H1R6BA01# |                    |        |               |         | ±0.25pF | GCG1555G1H3R4CA01# |                    |
|         |                    |                    | ±0.25pF | GCG1555G1H1R6CA01# | 3.5pF              |        |               |         | ±0.1pF  | GCG1555G1H3R5BA01# |                    |
|         |                    |                    |         | GCG1555G1H1R6DA01# |                    |        |               |         | ±0.25pF | GCG1555G1H3R5CA01# |                    |
|         |                    |                    | 1.7pF   | ±0.1pF             | GCG1555G1H1R7BA01# |        |               |         | 3.6pF   | ±0.1pF             | GCG1555G1H3R6BA01# |
|         |                    |                    |         | ±0.25pF            | GCG1555G1H1R7CA01# |        |               |         |         | ±0.25pF            | GCG1555G1H3R6CA01# |
|         |                    |                    | ±0.5pF  | GCG1555G1H1R7DA01# | 3.7pF              |        |               |         | ±0.1pF  | GCG1555G1H3R7BA01# |                    |
|         |                    |                    |         | GCG1555G1H1R8BA01# |                    |        |               |         | ±0.25pF | GCG1555G1H3R7CA01# |                    |
|         |                    |                    | ±0.25pF | GCG1555G1H1R8CA01# | 3.8pF              |        |               |         | ±0.1pF  | GCG1555G1H3R8BA01# |                    |
|         |                    |                    |         | GCG1555G1H1R8DA01# |                    |        |               |         | ±0.25pF | GCG1555G1H3R8CA01# |                    |
|         |                    |                    | 1.9pF   | ±0.1pF             | GCG1555G1H1R9BA01# |        |               |         | 3.9pF   | ±0.1pF             | GCG1555G1H3R9BA01# |
|         |                    |                    |         | ±0.25pF            | GCG1555G1H1R9CA01# |        |               |         |         | ±0.25pF            | GCG1555G1H3R9CA01# |
|         |                    |                    | ±0.5pF  | GCG1555G1H1R9DA01# | 4.0pF              |        |               |         | ±0.1pF  | GCG1555G1H4R0BA01# |                    |
|         |                    |                    |         | GCG1555G1H2R0BA01# |                    |        |               |         | ±0.25pF | GCG1555G1H4R0CA01# |                    |
|         |                    |                    | ±0.25pF | GCG1555G1H2R0CA01# | 4.1pF              |        |               |         | ±0.1pF  | GCG1555G1H4R1BA01# |                    |
|         |                    |                    |         | GCG1555G1H2R0DA01# |                    |        |               |         | ±0.25pF | GCG1555G1H4R1CA01# |                    |
|         |                    |                    | 2.0pF   | ±0.1pF             | GCG1555G1H2R1BA01# |        |               |         | 4.2pF   | ±0.1pF             | GCG1555G1H4R2BA01# |
|         |                    |                    |         | ±0.25pF            | GCG1555G1H2R1CA01# |        |               |         |         | ±0.25pF            | GCG1555G1H4R2CA01# |
|         |                    |                    | ±0.5pF  | GCG1555G1H2R1DA01# | 4.3pF              |        |               |         | ±0.1pF  | GCG1555G1H4R3BA01# |                    |
|         |                    |                    |         | GCG1555G1H2R2BA01# |                    |        |               |         | ±0.25pF | GCG1555G1H4R3CA01# |                    |
|         |                    |                    | ±0.25pF | GCG1555G1H2R2CA01# | 4.4pF              |        |               |         | ±0.1pF  | GCG1555G1H4R4BA01# |                    |
|         |                    |                    |         | GCG1555G1H2R2DA01# |                    |        |               |         | ±0.25pF | GCG1555G1H4R4CA01# |                    |
|         |                    |                    | 2.2pF   | ±0.1pF             | GCG1555G1H2R3BA01# |        |               |         | 4.5pF   | ±0.1pF             | GCG1555G1H4R5BA01# |
|         |                    |                    |         | ±0.25pF            | GCG1555G1H2R3CA01# |        |               |         |         | ±0.25pF            | GCG1555G1H4R5CA01# |
|         |                    |                    | ±0.5pF  | GCG1555G1H2R3DA01# | 4.6pF              |        |               |         | ±0.1pF  | GCG1555G1H4R6BA01# |                    |
|         |                    |                    |         | GCG1555G1H2R4BA01# |                    |        |               |         | ±0.25pF | GCG1555G1H4R6CA01# |                    |
|         |                    |                    | ±0.25pF | GCG1555G1H2R4CA01# | 4.7pF              |        |               |         | ±0.1pF  | GCG1555G1H4R7BA01# |                    |
|         |                    |                    |         | GCG1555G1H2R4DA01# |                    |        |               |         | ±0.25pF | GCG1555G1H4R7CA01# |                    |
|         |                    |                    | 2.5pF   | ±0.1pF             | GCG1555G1H2R5BA01# |        |               |         | 4.8pF   | ±0.1pF             | GCG1555G1H4R8BA01# |
|         |                    |                    |         | ±0.25pF            | GCG1555G1H2R5CA01# |        |               |         |         | ±0.25pF            | GCG1555G1H4R8CA01# |
|         |                    |                    | ±0.5pF  | GCG1555G1H2R5DA01# | 4.9pF              |        |               |         | ±0.1pF  | GCG1555G1H4R9BA01# |                    |
|         |                    |                    |         | GCG1555G1H2R6BA01# |                    |        |               |         | ±0.25pF | GCG1555G1H4R9CA01# |                    |
|         |                    |                    | ±0.25pF | GCG1555G1H2R6CA01# | 5.0pF              |        |               |         | ±0.1pF  | GCG1555G1H5R0BA01# |                    |
|         |                    |                    |         | GCG1555G1H2R6DA01# |                    |        |               |         | ±0.25pF | GCG1555G1H5R0CA01# |                    |
|         |                    |                    | 2.6pF   | ±0.1pF             | GCG1555G1H2R7BA01# |        |               |         | 5.0pF   | ±0.1pF             | GCG1555G1H5R0BA01# |
|         |                    |                    |         | ±0.25pF            | GCG1555G1H2R7CA01# |        |               |         |         | ±0.25pF            | GCG1555G1H5R0CA01# |
|         |                    |                    | ±0.5pF  | GCG1555G1H2R7DA01# | 5.0pF              |        |               |         | ±0.1pF  | GCG1555G1H5R0BA01# |                    |
|         |                    |                    |         | GCG1555G1H2R8BA01# |                    |        |               |         | ±0.25pF | GCG1555G1H5R0CA01# |                    |
| ±0.25pF | GCG1555G1H2R8CA01# | 5.0pF              | ±0.1pF  | GCG1555G1H5R0BA01# |                    |        |               |         |         |                    |                    |
|         | GCG1555G1H2R8DA01# |                    | ±0.25pF | GCG1555G1H5R0CA01# |                    |        |               |         |         |                    |                    |
| 2.8pF   | ±0.1pF             | GCG1555G1H2R9BA01# | 5.0pF   | ±0.1pF             | GCG1555G1H5R0BA01# |        |               |         |         |                    |                    |
|         | ±0.25pF            | GCG1555G1H2R9CA01# |         | ±0.25pF            | GCG1555G1H5R0CA01# |        |               |         |         |                    |                    |
| ±0.5pF  | GCG1555G1H2R9DA01# | 5.0pF              | ±0.1pF  | GCG1555G1H5R0BA01# |                    |        |               |         |         |                    |                    |
|         | GCG1555G1H3R0BA01# |                    | ±0.25pF | GCG1555G1H5R0CA01# |                    |        |               |         |         |                    |                    |
| ±0.25pF | GCG1555G1H3R0CA01# | 5.0pF              | ±0.1pF  | GCG1555G1H5R0BA01# |                    |        |               |         |         |                    |                    |
|         | GCG1555G1H3R0DA01# |                    | ±0.25pF | GCG1555G1H5R0CA01# |                    |        |               |         |         |                    |                    |
| 3.0pF   | ±0.1pF             | GCG1555G1H3R1BA01# | 5.0pF   | ±0.1pF             | GCG1555G1H5R0BA01# |        |               |         |         |                    |                    |
|         | ±0.25pF            | GCG1555G1H3R1CA01# |         | ±0.25pF            | GCG1555G1H5R0CA01# |        |               |         |         |                    |                    |
| ±0.5pF  | GCG1555G1H3R1DA01# | 5.0pF              | ±0.1pF  | GCG1555G1H5R0BA01# |                    |        |               |         |         |                    |                    |
|         | GCG1555G1H3R2BA01# |                    | ±0.25pF | GCG1555G1H5R0CA01# |                    |        |               |         |         |                    |                    |

Part number # indicates the package specification code.

GRT Series  
 GCM Series  
 GC3 Series  
 GCJ Series  
 GCQ Series  
 GCD Series  
 GCE Series  
 NMF Series  
 KCM Series  
 KC3 Series  
 KCA Series  
 GCB Series  
 GCG Series  
 ⚠Caution /Notice

# GCG Series Temperature Compensating Type Power-train AEC-Q200 Deflecting crack Soldering crack Limited to conductive glue mounting Part Number List

(→ 1.0×0.5mm)

| T max. | Rated Voltage | TC Code            | Cap.  | Tol.    | Part Number        | T max. | Rated Voltage | TC Code | Cap.  | Tol.    | Part Number        |
|--------|---------------|--------------------|-------|---------|--------------------|--------|---------------|---------|-------|---------|--------------------|
| 0.55mm | 50Vdc         | X8G                | 5.0pF | ±0.25pF | GCG1555G1H5R0CA01# | 0.55mm | 50Vdc         | X8G     | 6.8pF | ±0.25pF | GCG1555G1H6R8CA01# |
|        |               |                    |       | ±0.5pF  | GCG1555G1H5R0DA01# |        |               |         |       | ±0.5pF  | GCG1555G1H6R8DA01# |
|        |               |                    | 5.1pF | ±0.1pF  | GCG1555G1H5R1BA01# |        |               |         | 6.9pF | ±0.1pF  | GCG1555G1H6R9BA01# |
|        |               |                    |       | ±0.25pF | GCG1555G1H5R1CA01# |        |               |         |       | ±0.25pF | GCG1555G1H6R9CA01# |
|        |               |                    | 5.2pF | ±0.5pF  | GCG1555G1H5R1DA01# |        |               |         | 7.0pF | ±0.5pF  | GCG1555G1H6R9DA01# |
|        |               |                    |       | ±0.1pF  | GCG1555G1H5R2BA01# |        |               |         |       | ±0.1pF  | GCG1555G1H7R0BA01# |
|        |               |                    | 5.3pF | ±0.25pF | GCG1555G1H5R2CA01# |        |               |         | 7.1pF | ±0.25pF | GCG1555G1H7R0CA01# |
|        |               |                    |       | ±0.5pF  | GCG1555G1H5R2DA01# |        |               |         |       | ±0.5pF  | GCG1555G1H7R0DA01# |
|        |               |                    | 5.4pF | ±0.1pF  | GCG1555G1H5R3BA01# |        |               |         | 7.2pF | ±0.1pF  | GCG1555G1H7R1BA01# |
|        |               |                    |       | ±0.25pF | GCG1555G1H5R3CA01# |        |               |         |       | ±0.25pF | GCG1555G1H7R1CA01# |
|        |               |                    | 5.5pF | ±0.5pF  | GCG1555G1H5R3DA01# |        |               |         | 7.3pF | ±0.5pF  | GCG1555G1H7R1DA01# |
|        |               |                    |       | ±0.1pF  | GCG1555G1H5R4BA01# |        |               |         |       | ±0.1pF  | GCG1555G1H7R2BA01# |
|        |               |                    | 5.6pF | ±0.25pF | GCG1555G1H5R4CA01# |        |               |         | 7.4pF | ±0.25pF | GCG1555G1H7R2CA01# |
|        |               |                    |       | ±0.5pF  | GCG1555G1H5R4DA01# |        |               |         |       | ±0.5pF  | GCG1555G1H7R2DA01# |
|        |               |                    | 5.7pF | ±0.1pF  | GCG1555G1H5R5BA01# |        |               |         | 7.5pF | ±0.1pF  | GCG1555G1H7R3BA01# |
|        |               |                    |       | ±0.25pF | GCG1555G1H5R5CA01# |        |               |         |       | ±0.25pF | GCG1555G1H7R3CA01# |
|        |               |                    | 5.8pF | ±0.5pF  | GCG1555G1H5R5DA01# |        |               |         | 7.6pF | ±0.5pF  | GCG1555G1H7R3DA01# |
|        |               |                    |       | ±0.1pF  | GCG1555G1H5R6BA01# |        |               |         |       | ±0.1pF  | GCG1555G1H7R4BA01# |
|        |               |                    | 5.9pF | ±0.25pF | GCG1555G1H5R6CA01# |        |               |         | 7.7pF | ±0.25pF | GCG1555G1H7R4CA01# |
|        |               |                    |       | ±0.5pF  | GCG1555G1H5R6DA01# |        |               |         |       | ±0.5pF  | GCG1555G1H7R4DA01# |
|        |               |                    | 6.0pF | ±0.1pF  | GCG1555G1H5R7BA01# |        |               |         | 7.8pF | ±0.1pF  | GCG1555G1H7R5BA01# |
|        |               |                    |       | ±0.25pF | GCG1555G1H5R7CA01# |        |               |         |       | ±0.25pF | GCG1555G1H7R5CA01# |
|        |               |                    | 6.1pF | ±0.5pF  | GCG1555G1H5R7DA01# |        |               |         | 7.9pF | ±0.5pF  | GCG1555G1H7R5DA01# |
|        |               |                    |       | ±0.1pF  | GCG1555G1H5R8BA01# |        |               |         |       | ±0.1pF  | GCG1555G1H7R6BA01# |
|        |               |                    | 6.2pF | ±0.25pF | GCG1555G1H5R8CA01# |        |               |         | 8.0pF | ±0.25pF | GCG1555G1H7R6CA01# |
|        |               |                    |       | ±0.5pF  | GCG1555G1H5R8DA01# |        |               |         |       | ±0.5pF  | GCG1555G1H7R6DA01# |
|        |               |                    | 6.3pF | ±0.1pF  | GCG1555G1H5R9BA01# |        |               |         | 8.1pF | ±0.1pF  | GCG1555G1H7R7BA01# |
|        |               |                    |       | ±0.25pF | GCG1555G1H5R9CA01# |        |               |         |       | ±0.25pF | GCG1555G1H7R7CA01# |
|        |               |                    | 6.4pF | ±0.5pF  | GCG1555G1H5R9DA01# |        |               |         | 8.2pF | ±0.5pF  | GCG1555G1H7R7DA01# |
|        |               |                    |       | ±0.1pF  | GCG1555G1H6R0BA01# |        |               |         |       | ±0.1pF  | GCG1555G1H7R8BA01# |
|        |               |                    | 6.5pF | ±0.25pF | GCG1555G1H6R0CA01# |        |               |         | 8.3pF | ±0.25pF | GCG1555G1H7R8CA01# |
|        |               |                    |       | ±0.5pF  | GCG1555G1H6R0DA01# |        |               |         |       | ±0.5pF  | GCG1555G1H7R8DA01# |
|        |               |                    | 6.6pF | ±0.1pF  | GCG1555G1H6R1BA01# |        |               |         | 8.4pF | ±0.1pF  | GCG1555G1H7R9BA01# |
|        |               |                    |       | ±0.25pF | GCG1555G1H6R1CA01# |        |               |         |       | ±0.25pF | GCG1555G1H7R9CA01# |
|        |               |                    | 6.7pF | ±0.5pF  | GCG1555G1H6R1DA01# |        |               |         | 8.5pF | ±0.5pF  | GCG1555G1H7R9DA01# |
|        |               |                    |       | ±0.1pF  | GCG1555G1H6R2BA01# |        |               |         |       | ±0.1pF  | GCG1555G1H8R0BA01# |
|        |               |                    | 6.8pF | ±0.25pF | GCG1555G1H6R2CA01# |        |               |         | 8.6pF | ±0.25pF | GCG1555G1H8R0CA01# |
|        |               |                    |       | ±0.5pF  | GCG1555G1H6R2DA01# |        |               |         |       | ±0.5pF  | GCG1555G1H8R0DA01# |
|        |               |                    |       | ±0.1pF  | GCG1555G1H6R3BA01# |        |               |         |       | ±0.1pF  | GCG1555G1H8R1BA01# |
|        |               |                    |       | ±0.25pF | GCG1555G1H6R3CA01# |        |               |         |       | ±0.25pF | GCG1555G1H8R1CA01# |
|        |               |                    |       | ±0.5pF  | GCG1555G1H6R3DA01# |        |               |         |       | ±0.5pF  | GCG1555G1H8R1DA01# |
|        |               |                    |       | ±0.1pF  | GCG1555G1H6R4BA01# |        |               |         |       | ±0.1pF  | GCG1555G1H8R2BA01# |
|        |               |                    |       | ±0.25pF | GCG1555G1H6R4CA01# |        |               |         |       | ±0.25pF | GCG1555G1H8R2CA01# |
|        |               |                    |       | ±0.5pF  | GCG1555G1H6R4DA01# |        |               |         |       | ±0.5pF  | GCG1555G1H8R2DA01# |
|        |               |                    |       | ±0.1pF  | GCG1555G1H6R5BA01# |        |               |         |       | ±0.1pF  | GCG1555G1H8R3BA01# |
|        |               |                    |       | ±0.25pF | GCG1555G1H6R5CA01# |        |               |         |       | ±0.25pF | GCG1555G1H8R3CA01# |
|        |               |                    |       | ±0.5pF  | GCG1555G1H6R5DA01# |        |               |         |       | ±0.5pF  | GCG1555G1H8R3DA01# |
|        |               |                    |       | ±0.1pF  | GCG1555G1H6R6BA01# |        |               |         |       | ±0.1pF  | GCG1555G1H8R4BA01# |
|        | ±0.25pF       | GCG1555G1H6R6CA01# |       | ±0.25pF | GCG1555G1H8R4CA01# |        |               |         |       |         |                    |
|        | ±0.5pF        | GCG1555G1H6R6DA01# |       | ±0.5pF  | GCG1555G1H8R4DA01# |        |               |         |       |         |                    |
|        | ±0.1pF        | GCG1555G1H6R7BA01# |       | ±0.1pF  | GCG1555G1H8R5BA01# |        |               |         |       |         |                    |
|        | ±0.25pF       | GCG1555G1H6R7CA01# |       | ±0.25pF | GCG1555G1H8R5CA01# |        |               |         |       |         |                    |
|        | ±0.5pF        | GCG1555G1H6R7DA01# |       | ±0.5pF  | GCG1555G1H8R5DA01# |        |               |         |       |         |                    |
|        | ±0.1pF        | GCG1555G1H6R8BA01# |       | ±0.1pF  | GCG1555G1H8R6BA01# |        |               |         |       |         |                    |

Part number # indicates the package specification code.

GRT Series  
 GCM Series  
 GC3 Series  
 GCJ Series  
 GCQ Series  
 GCD Series  
 GCE Series  
 NMF Series  
 KCM Series  
 KC3 Series  
 KCA Series  
 GCB Series  
 GCG Series  
 ⚠Caution /Notice

# GCG Series Temperature Compensating Type Part Number List

(→ 1.0×0.5mm)

| T max. | Rated Voltage | TC Code | Cap.    | Tol.               | Part Number        | T max.             | Rated Voltage | TC Code | Cap.  | Tol.               | Part Number        |
|--------|---------------|---------|---------|--------------------|--------------------|--------------------|---------------|---------|-------|--------------------|--------------------|
| 0.55mm | 50Vdc         | X8G     | 8.6pF   | ±0.25pF            | GCG1555G1H8R6CA01# | 0.55mm             | 50Vdc         | X8G     | 18pF  | ±2%                | GCG1555G1H180GA01# |
|        |               |         |         | ±0.5pF             | GCG1555G1H8R6DA01# |                    |               |         |       | ±5%                | GCG1555G1H180JA01# |
|        |               |         | 8.7pF   | ±0.1pF             | GCG1555G1H8R7BA01# | 20pF               |               |         | ±2%   | GCG1555G1H200GA01# |                    |
|        |               |         |         | ±0.25pF            | GCG1555G1H8R7CA01# |                    |               |         | ±5%   | GCG1555G1H200JA01# |                    |
|        |               |         |         | ±0.5pF             | GCG1555G1H8R7DA01# |                    |               |         | 22pF  | ±2%                | GCG1555G1H220GA01# |
|        |               |         |         | ±0.1pF             | GCG1555G1H8R8BA01# |                    |               |         |       | ±5%                | GCG1555G1H220JA01# |
|        |               |         | 8.8pF   | ±0.25pF            | GCG1555G1H8R8CA01# | 24pF               |               |         | ±2%   | GCG1555G1H240GA01# |                    |
|        |               |         |         | ±0.5pF             | GCG1555G1H8R8DA01# |                    |               |         | ±5%   | GCG1555G1H240JA01# |                    |
|        |               |         |         | ±0.1pF             | GCG1555G1H8R9BA01# |                    |               |         | 27pF  | ±2%                | GCG1555G1H270GA01# |
|        |               |         | ±0.25pF | GCG1555G1H8R9CA01# | ±5%                | GCG1555G1H270JA01# |               |         |       |                    |                    |
|        |               |         | 8.9pF   | ±0.5pF             | GCG1555G1H8R9DA01# | 30pF               |               |         | ±2%   | GCG1555G1H300GA01# |                    |
|        |               |         |         | ±0.1pF             | GCG1555G1H9R0BA01# |                    |               |         | ±5%   | GCG1555G1H300JA01# |                    |
|        |               |         |         | ±0.25pF            | GCG1555G1H9R0CA01# |                    |               |         | 33pF  | ±2%                | GCG1555G1H330GA01# |
|        |               |         | ±0.5pF  | GCG1555G1H9R0DA01# | ±5%                | GCG1555G1H330JA01# |               |         |       |                    |                    |
|        |               |         | 9.1pF   | ±0.1pF             | GCG1555G1H9R1BA01# | 36pF               |               |         | ±2%   | GCG1555G1H360GA01# |                    |
|        |               |         |         | ±0.25pF            | GCG1555G1H9R1CA01# |                    |               |         | ±5%   | GCG1555G1H360JA01# |                    |
|        |               |         |         | ±0.5pF             | GCG1555G1H9R1DA01# |                    |               |         | 39pF  | ±2%                | GCG1555G1H390GA01# |
|        |               |         | ±0.1pF  | GCG1555G1H9R2BA01# | ±5%                | GCG1555G1H390JA01# |               |         |       |                    |                    |
|        |               |         | 9.2pF   | ±0.25pF            | GCG1555G1H9R2CA01# | 43pF               |               |         | ±2%   | GCG1555G1H430GA01# |                    |
|        |               |         |         | ±0.5pF             | GCG1555G1H9R2DA01# |                    |               |         | ±5%   | GCG1555G1H430JA01# |                    |
|        |               |         |         | ±0.1pF             | GCG1555G1H9R3BA01# |                    |               |         | 47pF  | ±2%                | GCG1555G1H470GA01# |
|        |               |         | ±0.25pF | GCG1555G1H9R3CA01# | ±5%                | GCG1555G1H470JA01# |               |         |       |                    |                    |
|        |               |         | 9.3pF   | ±0.5pF             | GCG1555G1H9R3DA01# | 51pF               |               |         | ±2%   | GCG1555G1H510GA01# |                    |
|        |               |         |         | ±0.1pF             | GCG1555G1H9R4BA01# |                    |               |         | ±5%   | GCG1555G1H510JA01# |                    |
|        |               |         |         | ±0.25pF            | GCG1555G1H9R4CA01# |                    |               |         | 56pF  | ±2%                | GCG1555G1H560GA01# |
|        |               |         | ±0.5pF  | GCG1555G1H9R4DA01# | ±5%                | GCG1555G1H560JA01# |               |         |       |                    |                    |
|        |               |         | 9.4pF   | ±0.1pF             | GCG1555G1H9R5BA01# | 62pF               |               |         | ±2%   | GCG1555G1H620GA01# |                    |
|        |               |         |         | ±0.25pF            | GCG1555G1H9R5CA01# |                    |               |         | ±5%   | GCG1555G1H620JA01# |                    |
|        |               |         |         | ±0.5pF             | GCG1555G1H9R5DA01# |                    |               |         | 68pF  | ±2%                | GCG1555G1H680GA01# |
|        |               |         | ±0.1pF  | GCG1555G1H9R6BA01# | ±5%                | GCG1555G1H680JA01# |               |         |       |                    |                    |
|        |               |         | 9.5pF   | ±0.25pF            | GCG1555G1H9R6CA01# | 75pF               |               |         | ±2%   | GCG1555G1H750GA01# |                    |
|        |               |         |         | ±0.5pF             | GCG1555G1H9R6DA01# |                    |               |         | ±5%   | GCG1555G1H750JA01# |                    |
|        |               |         |         | ±0.1pF             | GCG1555G1H9R7BA01# |                    |               |         | 82pF  | ±2%                | GCG1555G1H820GA01# |
|        |               |         | ±0.25pF | GCG1555G1H9R7CA01# | ±5%                | GCG1555G1H820JA01# |               |         |       |                    |                    |
|        |               |         | 9.6pF   | ±0.5pF             | GCG1555G1H9R7DA01# | 91pF               |               |         | ±2%   | GCG1555G1H910GA01# |                    |
|        |               |         |         | ±0.1pF             | GCG1555G1H9R8BA01# |                    |               |         | ±5%   | GCG1555G1H910JA01# |                    |
|        |               |         |         | ±0.25pF            | GCG1555G1H9R8CA01# |                    |               |         | 100pF | ±2%                | GCG1555G1H101GA01# |
|        |               |         | ±0.5pF  | GCG1555G1H9R8DA01# | ±5%                | GCG1555G1H101JA01# |               |         |       |                    |                    |
|        |               |         | 9.7pF   | ±0.1pF             | GCG1555G1H9R9BA01# | 110pF              |               |         | ±2%   | GCG1555G1H111GA01# |                    |
|        |               |         |         | ±0.25pF            | GCG1555G1H9R9CA01# |                    |               |         | ±5%   | GCG1555G1H111JA01# |                    |
|        |               |         |         | ±0.5pF             | GCG1555G1H9R9DA01# |                    |               |         | 120pF | ±2%                | GCG1555G1H121GA01# |
|        |               |         | ±1%     | GCG1555G1H100FA01# | ±5%                | GCG1555G1H121JA01# |               |         |       |                    |                    |
|        |               |         | 9.8pF   | ±2.5%              | GCG1555G1H100RA01# | 130pF              |               |         | ±2%   | GCG1555G1H131GA01# |                    |
|        |               |         |         | ±5%                | GCG1555G1H100JA01# |                    |               |         | ±5%   | GCG1555G1H131JA01# |                    |
|        |               |         |         | ±2%                | GCG1555G1H110GA01# |                    |               |         | 150pF | ±2%                | GCG1555G1H151GA01# |
|        |               |         | ±5%     | GCG1555G1H110JA01# | ±5%                | GCG1555G1H151JA01# |               |         |       |                    |                    |
|        |               |         | 9.9pF   | ±2%                | GCG1555G1H120GA01# | 160pF              |               |         | ±2%   | GCG1555G1H161GA01# |                    |
|        |               |         |         | ±5%                | GCG1555G1H120JA01# |                    |               |         | ±5%   | GCG1555G1H161JA01# |                    |
|        |               |         | 10pF    | ±2%                | GCG1555G1H130GA01# | 180pF              |               |         | ±2%   | GCG1555G1H181GA01# |                    |
|        |               |         |         | ±5%                | GCG1555G1H130JA01# |                    |               |         | ±5%   | GCG1555G1H181JA01# |                    |
|        |               |         | 11pF    | ±2%                | GCG1555G1H130JA01# | 200pF              |               |         | ±2%   | GCG1555G1H201GA01# |                    |
|        |               |         |         | ±5%                | GCG1555G1H130JA01# |                    |               |         | ±5%   | GCG1555G1H201JA01# |                    |
|        |               |         | 12pF    | ±2%                | GCG1555G1H150GA01# | 220pF              |               |         | ±2%   | GCG1555G1H221GA01# |                    |
|        |               |         |         | ±5%                | GCG1555G1H150JA01# |                    |               |         | ±5%   | GCG1555G1H221JA01# |                    |
|        |               |         | 13pF    | ±2%                | GCG1555G1H150JA01# |                    |               |         |       |                    |                    |
|        |               |         |         | ±5%                | GCG1555G1H150JA01# |                    |               |         |       |                    |                    |
|        |               |         | 15pF    | ±2%                | GCG1555G1H160GA01# |                    |               |         |       |                    |                    |
|        |               |         |         | ±5%                | GCG1555G1H160JA01# |                    |               |         |       |                    |                    |
|        |               |         | 16pF    | ±2%                | GCG1555G1H160JA01# |                    |               |         |       |                    |                    |
|        |               |         |         | ±5%                | GCG1555G1H160JA01# |                    |               |         |       |                    |                    |

Part number # indicates the package specification code.

GRT Series  
 GCM Series  
 GC3 Series  
 GCJ Series  
 GCQ Series  
 GCD Series  
 GCE Series  
 NMF Series  
 KCM Series  
 KC3 Series  
 KCA Series  
 GCB Series  
 GCG Series  
 ⚠Caution /Notice

# GCG Series Temperature Compensating Type Power-train AEC-Q200 Deflecting crack Soldering crack Limited to conductive glue mounting Part Number List

(→ 1.0×0.5mm)

| T max. | Rated Voltage | TC Code | Cap.  | Tol. | Part Number        |
|--------|---------------|---------|-------|------|--------------------|
| 0.55mm | 50Vdc         | X8G     | 240pF | ±2%  | GCG1555G1H241GA01# |
|        |               |         |       | ±5%  | GCG1555G1H241JA01# |
|        |               |         | 270pF | ±2%  | GCG1555G1H271GA01# |
|        |               |         |       | ±5%  | GCG1555G1H271JA01# |
|        |               |         | 300pF | ±2%  | GCG1555G1H301GA01# |
|        |               |         |       | ±5%  | GCG1555G1H301JA01# |
|        |               |         | 330pF | ±2%  | GCG1555G1H331GA01# |
|        |               |         |       | ±5%  | GCG1555G1H331JA01# |
|        |               |         | 360pF | ±2%  | GCG1555G1H361GA01# |
|        |               |         |       | ±5%  | GCG1555G1H361JA01# |
|        |               |         | 390pF | ±2%  | GCG1555G1H391GA01# |
|        |               |         |       | ±5%  | GCG1555G1H391JA01# |
|        |               |         | 430pF | ±2%  | GCG1555G1H431GA01# |
|        |               |         |       | ±5%  | GCG1555G1H431JA01# |
|        |               |         | 470pF | ±2%  | GCG1555G1H471GA01# |
|        |               |         |       | ±5%  | GCG1555G1H471JA01# |

| T max. | Rated Voltage      | TC Code            | Cap. | Tol. | Part Number        |                    |
|--------|--------------------|--------------------|------|------|--------------------|--------------------|
| 0.9mm  | 100Vdc             | X8G                | 12pF | ±5%  | GCG1885G2A120JA01# |                    |
|        |                    |                    |      | 13pF | ±1%                | GCG1885G2A130FA01# |
|        |                    |                    |      |      | ±2%                | GCG1885G2A130GA01# |
|        |                    |                    | ±5%  |      | GCG1885G2A130JA01# |                    |
|        |                    |                    | 15pF | ±1%  | GCG1885G2A150FA01# |                    |
|        |                    |                    |      | ±2%  | GCG1885G2A150GA01# |                    |
|        |                    |                    |      | ±5%  | GCG1885G2A150JA01# |                    |
|        |                    |                    | 16pF | ±1%  | GCG1885G2A160FA01# |                    |
|        |                    |                    |      | ±2%  | GCG1885G2A160GA01# |                    |
|        |                    |                    |      | ±5%  | GCG1885G2A160JA01# |                    |
|        |                    |                    | 18pF | ±1%  | GCG1885G2A180FA01# |                    |
|        |                    |                    |      | ±2%  | GCG1885G2A180GA01# |                    |
|        |                    |                    |      | ±5%  | GCG1885G2A180JA01# |                    |
|        |                    |                    | 20pF | ±1%  | GCG1885G2A200FA01# |                    |
|        |                    |                    |      | ±2%  | GCG1885G2A200GA01# |                    |
|        |                    |                    |      | ±5%  | GCG1885G2A200JA01# |                    |
|        |                    |                    | 22pF | ±1%  | GCG1885G2A220FA01# |                    |
|        |                    |                    |      | ±2%  | GCG1885G2A220GA01# |                    |
|        |                    |                    |      | ±5%  | GCG1885G2A220JA01# |                    |
|        |                    |                    | 24pF | ±1%  | GCG1885G2A240FA01# |                    |
|        |                    |                    |      | ±2%  | GCG1885G2A240GA01# |                    |
|        |                    |                    |      | ±5%  | GCG1885G2A240JA01# |                    |
|        |                    |                    | 27pF | ±1%  | GCG1885G2A270FA01# |                    |
|        |                    |                    |      | ±2%  | GCG1885G2A270GA01# |                    |
|        |                    |                    |      | ±5%  | GCG1885G2A270JA01# |                    |
|        |                    |                    | 30pF | ±1%  | GCG1885G2A300FA01# |                    |
|        |                    |                    |      | ±2%  | GCG1885G2A300GA01# |                    |
|        |                    |                    |      | ±5%  | GCG1885G2A300JA01# |                    |
|        |                    |                    | 33pF | ±1%  | GCG1885G2A330FA01# |                    |
|        |                    |                    |      | ±2%  | GCG1885G2A330GA01# |                    |
|        |                    |                    |      | ±5%  | GCG1885G2A330JA01# |                    |
|        |                    |                    | 36pF | ±1%  | GCG1885G2A360FA01# |                    |
|        |                    |                    |      | ±2%  | GCG1885G2A360GA01# |                    |
|        |                    |                    |      | ±5%  | GCG1885G2A360JA01# |                    |
|        |                    |                    | 39pF | ±1%  | GCG1885G2A390FA01# |                    |
|        |                    |                    |      | ±2%  | GCG1885G2A390GA01# |                    |
|        |                    |                    |      | ±5%  | GCG1885G2A390JA01# |                    |
|        |                    |                    | 43pF | ±1%  | GCG1885G2A430FA01# |                    |
|        |                    |                    |      | ±2%  | GCG1885G2A430GA01# |                    |
|        |                    |                    |      | ±5%  | GCG1885G2A430JA01# |                    |
|        |                    |                    | 47pF | ±1%  | GCG1885G2A470FA01# |                    |
|        |                    |                    |      | ±2%  | GCG1885G2A470GA01# |                    |
|        |                    |                    |      | ±5%  | GCG1885G2A470JA01# |                    |
|        |                    |                    | 51pF | ±1%  | GCG1885G2A510FA01# |                    |
|        |                    |                    |      | ±2%  | GCG1885G2A510GA01# |                    |
|        |                    |                    |      | ±5%  | GCG1885G2A510JA01# |                    |
|        |                    |                    | 56pF | ±1%  | GCG1885G2A560FA01# |                    |
|        |                    |                    |      | ±2%  | GCG1885G2A560GA01# |                    |
| ±5%    | GCG1885G2A560JA01# |                    |      |      |                    |                    |
| 62pF   | ±1%                | GCG1885G2A620FA01# |      |      |                    |                    |
|        | ±2%                | GCG1885G2A620GA01# |      |      |                    |                    |
|        | ±5%                | GCG1885G2A620JA01# |      |      |                    |                    |
| 68pF   | ±1%                | GCG1885G2A680FA01# |      |      |                    |                    |
|        | ±2%                | GCG1885G2A680GA01# |      |      |                    |                    |

1.6×0.8mm

| T max. | Rated Voltage | TC Code | Cap.    | Tol. | Part Number        |                    |
|--------|---------------|---------|---------|------|--------------------|--------------------|
| 0.9mm  | 100Vdc        | U2J     | 1000pF  | ±5%  | GCG1887U2A102JA01# |                    |
|        |               |         | 1100pF  | ±5%  | GCG1887U2A112JA01# |                    |
|        |               |         | 1200pF  | ±5%  | GCG1887U2A122JA01# |                    |
|        |               |         | 1300pF  | ±5%  | GCG1887U2A132JA01# |                    |
|        |               |         | 1500pF  | ±5%  | GCG1887U2A152JA01# |                    |
|        |               |         | 1600pF  | ±5%  | GCG1887U2A162JA01# |                    |
|        |               |         | 1800pF  | ±5%  | GCG1887U2A182JA01# |                    |
|        |               |         | 2000pF  | ±5%  | GCG1887U2A202JA01# |                    |
|        |               |         | 2200pF  | ±5%  | GCG1887U2A222JA01# |                    |
|        |               |         | 2400pF  | ±5%  | GCG1887U2A242JA01# |                    |
|        |               |         | 2700pF  | ±5%  | GCG1887U2A272JA01# |                    |
|        |               |         | 3000pF  | ±5%  | GCG1887U2A302JA01# |                    |
|        |               |         | 3300pF  | ±5%  | GCG1887U2A332JA01# |                    |
|        |               |         | 3600pF  | ±5%  | GCG1887U2A362JA01# |                    |
|        |               |         | 3900pF  | ±5%  | GCG1887U2A392JA01# |                    |
|        |               |         | 4300pF  | ±5%  | GCG1887U2A432JA01# |                    |
|        |               |         | 4700pF  | ±5%  | GCG1887U2A472JA01# |                    |
|        |               |         | 5100pF  | ±5%  | GCG1887U2A512JA01# |                    |
|        |               |         | 5600pF  | ±5%  | GCG1887U2A562JA01# |                    |
|        |               |         | 6200pF  | ±5%  | GCG1887U2A622JA01# |                    |
|        |               |         | 6800pF  | ±5%  | GCG1887U2A682JA01# |                    |
|        |               |         | 7500pF  | ±5%  | GCG1887U2A752JA01# |                    |
|        |               |         | 8200pF  | ±5%  | GCG1887U2A822JA01# |                    |
|        |               |         | 9100pF  | ±5%  | GCG1887U2A912JA01# |                    |
|        |               |         | 10000pF | ±5%  | GCG1887U2A103JA01# |                    |
|        |               |         | X8G     | 10pF | ±1%                | GCG1885G2A100FA01# |
|        |               |         |         |      | ±2%                | GCG1885G2A100GA01# |
|        |               | ±5%     |         |      | GCG1885G2A100JA01# |                    |
|        |               | 11pF    |         | ±1%  | GCG1885G2A110FA01# |                    |
|        |               |         |         | ±2%  | GCG1885G2A110GA01# |                    |
|        |               |         |         | ±5%  | GCG1885G2A110JA01# |                    |
|        |               | 12pF    |         | ±1%  | GCG1885G2A120FA01# |                    |
|        |               |         |         | ±2%  | GCG1885G2A120GA01# |                    |

GRT Series  
 GCM Series  
 GC3 Series  
 GCJ Series  
 GCQ Series  
 GCD Series  
 GCE Series  
 NMF Series  
 KCM Series  
 KC3 Series  
 KCA Series  
 GCB Series  
 GCG Series  
 ⚠Caution /Notice

Part number # indicates the package specification code.

# GCG Series Temperature Compensating Type Part Number List

(→ 1.6×0.8mm)

| T max. | Rated Voltage | TC Code | Cap.  | Tol. | Part Number        | T max. | Rated Voltage | TC Code | Cap.   | Tol.  | Part Number        |                    |                    |
|--------|---------------|---------|-------|------|--------------------|--------|---------------|---------|--------|-------|--------------------|--------------------|--------------------|
| 0.9mm  | 100Vdc        | X8G     | 68pF  | ±5%  | GCG1885G2A680JA01# | 0.9mm  | 100Vdc        | X8G     | 390pF  | ±5%   | GCG1885G2A391JA01# |                    |                    |
|        |               |         |       | ±1%  | GCG1885G2A750FA01# |        |               |         |        | 430pF | ±1%                | GCG1885G2A431FA01# |                    |
|        |               |         |       |      | ±2%                |        |               |         |        |       | GCG1885G2A750GA01# | ±2%                | GCG1885G2A431GA01# |
|        |               |         | ±5%   |      | GCG1885G2A750JA01# |        |               |         | ±5%    |       | GCG1885G2A431JA01# |                    |                    |
|        |               |         | 82pF  | ±1%  | GCG1885G2A820FA01# |        |               |         | 470pF  | ±1%   | GCG1885G2A471FA01# |                    |                    |
|        |               |         |       | ±2%  | GCG1885G2A820GA01# |        |               |         |        | ±2%   | GCG1885G2A471GA01# |                    |                    |
|        |               |         |       | ±5%  | GCG1885G2A820JA01# |        |               |         |        | ±5%   | GCG1885G2A471JA01# |                    |                    |
|        |               |         | 91pF  | ±1%  | GCG1885G2A910FA01# |        |               |         | 510pF  | ±1%   | GCG1885G2A511FA01# |                    |                    |
|        |               |         |       | ±2%  | GCG1885G2A910GA01# |        |               |         |        | ±2%   | GCG1885G2A511GA01# |                    |                    |
|        |               |         |       | ±5%  | GCG1885G2A910JA01# |        |               |         |        | ±5%   | GCG1885G2A511JA01# |                    |                    |
|        |               |         | 100pF | ±1%  | GCG1885G2A101FA01# |        |               |         | 560pF  | ±1%   | GCG1885G2A561FA01# |                    |                    |
|        |               |         |       | ±2%  | GCG1885G2A101GA01# |        |               |         |        | ±2%   | GCG1885G2A561GA01# |                    |                    |
|        |               |         |       | ±5%  | GCG1885G2A101JA01# |        |               |         |        | ±5%   | GCG1885G2A561JA01# |                    |                    |
|        |               |         | 110pF | ±1%  | GCG1885G2A111FA01# |        |               |         | 620pF  | ±1%   | GCG1885G2A621FA01# |                    |                    |
|        |               |         |       | ±2%  | GCG1885G2A111GA01# |        |               |         |        | ±2%   | GCG1885G2A621GA01# |                    |                    |
|        |               |         |       | ±5%  | GCG1885G2A111JA01# |        |               |         |        | ±5%   | GCG1885G2A621JA01# |                    |                    |
|        |               |         | 120pF | ±1%  | GCG1885G2A121FA01# |        |               |         | 680pF  | ±1%   | GCG1885G2A681FA01# |                    |                    |
|        |               |         |       | ±2%  | GCG1885G2A121GA01# |        |               |         |        | ±2%   | GCG1885G2A681GA01# |                    |                    |
|        |               |         |       | ±5%  | GCG1885G2A121JA01# |        |               |         |        | ±5%   | GCG1885G2A681JA01# |                    |                    |
|        |               |         | 130pF | ±1%  | GCG1885G2A131FA01# |        |               |         | 750pF  | ±1%   | GCG1885G2A751FA01# |                    |                    |
|        |               |         |       | ±2%  | GCG1885G2A131GA01# |        |               |         |        | ±2%   | GCG1885G2A751GA01# |                    |                    |
|        |               |         |       | ±5%  | GCG1885G2A131JA01# |        |               |         |        | ±5%   | GCG1885G2A751JA01# |                    |                    |
|        |               |         | 150pF | ±1%  | GCG1885G2A151FA01# |        |               |         | 820pF  | ±1%   | GCG1885G2A821FA01# |                    |                    |
|        |               |         |       | ±2%  | GCG1885G2A151GA01# |        |               |         |        | ±2%   | GCG1885G2A821GA01# |                    |                    |
|        |               |         |       | ±5%  | GCG1885G2A151JA01# |        |               |         |        | ±5%   | GCG1885G2A821JA01# |                    |                    |
|        |               |         | 160pF | ±1%  | GCG1885G2A161FA01# |        |               |         | 910pF  | ±1%   | GCG1885G2A911FA01# |                    |                    |
|        |               |         |       | ±2%  | GCG1885G2A161GA01# |        |               |         |        | ±2%   | GCG1885G2A911GA01# |                    |                    |
|        |               |         |       | ±5%  | GCG1885G2A161JA01# |        |               |         |        | ±5%   | GCG1885G2A911JA01# |                    |                    |
|        |               |         | 180pF | ±1%  | GCG1885G2A181FA01# |        |               |         | 1000pF | ±1%   | GCG1885G2A102FA01# |                    |                    |
|        |               |         |       | ±2%  | GCG1885G2A181GA01# |        |               |         |        | ±2%   | GCG1885G2A102GA01# |                    |                    |
|        |               |         |       | ±5%  | GCG1885G2A181JA01# |        |               |         |        | ±5%   | GCG1885G2A102JA01# |                    |                    |
|        |               |         | 200pF | ±1%  | GCG1885G2A201FA01# |        |               |         | 50Vdc  | X8G   | 10pF               | ±1%                | GCG1885G1H100FA01# |
|        |               |         |       | ±2%  | GCG1885G2A201GA01# |        |               |         |        |       |                    | ±2%                | GCG1885G1H100GA01# |
|        |               |         |       | ±5%  | GCG1885G2A201JA01# |        |               |         |        |       |                    | ±5%                | GCG1885G1H100JA01# |
|        |               |         | 220pF | ±1%  | GCG1885G2A221FA01# |        |               |         | 12pF   | ±2%   | GCG1885G1H120GA01# |                    |                    |
|        |               |         |       | ±2%  | GCG1885G2A221GA01# |        |               |         |        | ±5%   | GCG1885G1H120JA01# |                    |                    |
|        |               |         |       | ±5%  | GCG1885G2A221JA01# |        |               |         |        | 15pF  | ±2%                | GCG1885G1H150GA01# |                    |
|        |               |         | 240pF | ±1%  | GCG1885G2A241FA01# |        |               |         | ±5%    |       | GCG1885G1H150JA01# |                    |                    |
|        |               |         |       | ±2%  | GCG1885G2A241GA01# |        |               |         | 18pF   |       | ±2%                | GCG1885G1H180GA01# |                    |
|        |               |         |       | ±5%  | GCG1885G2A241JA01# |        |               |         |        | ±5%   | GCG1885G1H180JA01# |                    |                    |
|        |               |         | 270pF | ±1%  | GCG1885G2A271FA01# |        |               |         |        | 22pF  | ±2%                | GCG1885G1H220GA01# |                    |
|        |               |         |       | ±2%  | GCG1885G2A271GA01# |        |               |         | ±5%    |       | GCG1885G1H220JA01# |                    |                    |
|        |               |         |       | ±5%  | GCG1885G2A271JA01# |        |               |         | 27pF   |       | ±2%                | GCG1885G1H270GA01# |                    |
|        |               |         | 300pF | ±1%  | GCG1885G2A301FA01# |        |               |         |        | ±5%   | GCG1885G1H270JA01# |                    |                    |
|        |               |         |       | ±2%  | GCG1885G2A301GA01# |        |               |         |        | 33pF  | ±2%                | GCG1885G1H330GA01# |                    |
|        |               |         |       | ±5%  | GCG1885G2A301JA01# |        |               |         | ±5%    |       | GCG1885G1H330JA01# |                    |                    |
|        |               |         | 330pF | ±1%  | GCG1885G2A331FA01# |        |               |         | 39pF   |       | ±2%                | GCG1885G1H390GA01# |                    |
|        |               |         |       | ±2%  | GCG1885G2A331GA01# |        |               |         |        | ±5%   | GCG1885G1H390JA01# |                    |                    |
|        |               |         |       | ±5%  | GCG1885G2A331JA01# |        |               |         |        | 47pF  | ±2%                | GCG1885G1H470GA01# |                    |
|        |               |         | 360pF | ±1%  | GCG1885G2A361FA01# |        |               |         | ±5%    |       | GCG1885G1H470JA01# |                    |                    |
|        |               |         |       | ±2%  | GCG1885G2A361GA01# |        |               |         | 56pF   |       | ±2%                | GCG1885G1H560GA01# |                    |
|        |               |         |       | ±5%  | GCG1885G2A361JA01# |        |               |         |        | ±5%   | GCG1885G1H560JA01# |                    |                    |
|        |               |         | 390pF | ±1%  | GCG1885G2A391FA01# |        |               |         |        | 68pF  | ±2%                | GCG1885G1H680GA01# |                    |
|        |               |         |       | ±2%  | GCG1885G2A391GA01# |        |               |         | ±5%    |       | GCG1885G1H680JA01# |                    |                    |

GRT Series  
 GCM Series  
 GC3 Series  
 GCJ Series  
 GCQ Series  
 GCD Series  
 GCE Series  
 NMF Series  
 KCM Series  
 KC3 Series  
 KCA Series  
 GCB Series  
 GCG Series  
 ⚠Caution /Notice

Part number # indicates the package specification code.

# GCG Series Temperature Compensating Type Power-train AEC-Q200 Deflecting crack Soldering crack Limited to conductive glue mounting Part Number List

(→ 1.6×0.8mm)

| T max. | Rated Voltage | TC Code | Cap.   | Tol. | Part Number        |
|--------|---------------|---------|--------|------|--------------------|
| 0.9mm  | 50Vdc         | X8G     | 82pF   | ±2%  | GCG1885G1H820GA01# |
|        |               |         |        | ±5%  | GCG1885G1H820JA01# |
|        |               |         | 100pF  | ±2%  | GCG1885G1H101GA01# |
|        |               |         |        | ±5%  | GCG1885G1H101JA01# |
|        |               |         | 120pF  | ±2%  | GCG1885G1H121GA01# |
|        |               |         |        | ±5%  | GCG1885G1H121JA01# |
|        |               |         | 150pF  | ±2%  | GCG1885G1H151GA01# |
|        |               |         |        | ±5%  | GCG1885G1H151JA01# |
|        |               |         | 180pF  | ±2%  | GCG1885G1H181GA01# |
|        |               |         |        | ±5%  | GCG1885G1H181JA01# |
|        |               |         | 220pF  | ±2%  | GCG1885G1H221GA01# |
|        |               |         |        | ±5%  | GCG1885G1H221JA01# |
|        |               |         | 270pF  | ±2%  | GCG1885G1H271GA01# |
|        |               |         |        | ±5%  | GCG1885G1H271JA01# |
|        |               |         | 330pF  | ±2%  | GCG1885G1H331GA01# |
|        |               |         |        | ±5%  | GCG1885G1H331JA01# |
|        |               |         | 390pF  | ±2%  | GCG1885G1H391GA01# |
|        |               |         |        | ±5%  | GCG1885G1H391JA01# |
|        |               |         | 470pF  | ±2%  | GCG1885G1H471GA01# |
|        |               |         |        | ±5%  | GCG1885G1H471JA01# |
|        |               |         | 560pF  | ±2%  | GCG1885G1H561GA01# |
|        |               |         |        | ±5%  | GCG1885G1H561JA01# |
|        |               |         | 680pF  | ±2%  | GCG1885G1H681GA01# |
|        |               |         |        | ±5%  | GCG1885G1H681JA01# |
|        |               |         | 820pF  | ±2%  | GCG1885G1H821GA01# |
|        |               |         |        | ±5%  | GCG1885G1H821JA01# |
|        |               |         | 1000pF | ±2%  | GCG1885G1H102GA01# |
|        |               |         |        | ±5%  | GCG1885G1H102JA01# |
|        |               |         | 1200pF | ±2%  | GCG1885G1H122GA01# |
|        |               |         |        | ±5%  | GCG1885G1H122JA01# |
|        |               |         | 1500pF | ±2%  | GCG1885G1H152GA01# |
|        |               |         |        | ±5%  | GCG1885G1H152JA01# |
|        |               |         | 1800pF | ±2%  | GCG1885G1H182GA01# |
|        |               |         |        | ±5%  | GCG1885G1H182JA01# |
|        |               |         | 2200pF | ±2%  | GCG1885G1H222GA01# |
|        |               |         |        | ±5%  | GCG1885G1H222JA01# |

| T max. | Rated Voltage | TC Code | Cap.    | Tol. | Part Number        |
|--------|---------------|---------|---------|------|--------------------|
| 0.7mm  | 50Vdc         | X8G     | 3300pF  | ±5%  | GCG2165G1H332JA01# |
|        |               |         |         | ±2%  | GCG2165G1H392GA01# |
|        |               |         | 3900pF  | ±2%  | GCG2165G1H392JA01# |
|        |               |         |         | ±5%  | GCG2165G1H392JA01# |
|        |               |         | 4700pF  | ±2%  | GCG2165G1H472GA01# |
|        |               |         |         | ±5%  | GCG2165G1H472JA01# |
| 0.95mm | 50Vdc         | X8G     | 5600pF  | ±2%  | GCG2195G1H562GA01# |
|        |               |         |         | ±5%  | GCG2195G1H562JA01# |
|        |               |         | 6800pF  | ±2%  | GCG2195G1H682GA01# |
|        |               |         |         | ±5%  | GCG2195G1H682JA01# |
|        |               |         | 8200pF  | ±2%  | GCG2195G1H822GA01# |
|        |               |         |         | ±5%  | GCG2195G1H822JA01# |
|        |               |         | 10000pF | ±2%  | GCG2195G1H103GA01# |
|        |               |         |         | ±5%  | GCG2195G1H103JA01# |

2.0×1.25mm

| T max. | Rated Voltage | TC Code | Cap.   | Tol. | Part Number        |
|--------|---------------|---------|--------|------|--------------------|
| 0.7mm  | 50Vdc         | X8G     | 1000pF | ±2%  | GCG2165G1H102GA01# |
|        |               |         |        | ±5%  | GCG2165G1H102JA01# |
|        |               |         | 1200pF | ±2%  | GCG2165G1H122GA01# |
|        |               |         |        | ±5%  | GCG2165G1H122JA01# |
|        |               |         | 1500pF | ±2%  | GCG2165G1H152GA01# |
|        |               |         |        | ±5%  | GCG2165G1H152JA01# |
|        |               |         | 1800pF | ±2%  | GCG2165G1H182GA01# |
|        |               |         |        | ±5%  | GCG2165G1H182JA01# |
|        |               |         | 2200pF | ±2%  | GCG2165G1H222GA01# |
|        |               |         |        | ±5%  | GCG2165G1H222JA01# |
|        |               |         | 2700pF | ±2%  | GCG2165G1H272GA01# |
|        |               |         |        | ±5%  | GCG2165G1H272JA01# |
|        |               |         | 3300pF | ±2%  | GCG2165G1H332GA01# |

Part number # indicates the package specification code.

GRT Series  
 GCM Series  
 GC3 Series  
 GCJ Series  
 GCQ Series  
 GCD Series  
 GCE Series  
 NMF Series  
 KCM Series  
 KC3 Series  
 KCA Series  
 GCB Series  
 GCG Series  
 ⚠Caution /Notice

# GCG Series High Dielectric Constant Type Power-train AEC-Q200 Deflecting crack Soldering crack Limited to conductive paste mounting Part Number List

## 1.0×0.5mm

| T max. | Rated Voltage | TC Code            | Cap.   | Tol.               | Part Number        |                    |                    |
|--------|---------------|--------------------|--------|--------------------|--------------------|--------------------|--------------------|
| 0.55mm | 50Vdc         | X8L                | 220pF  | ±10%               | GCG155L81H221KA02# |                    |                    |
|        |               |                    | 270pF  | ±10%               | GCG155L81H271KA02# |                    |                    |
|        |               |                    | 330pF  | ±10%               | GCG155L81H331KA02# |                    |                    |
|        |               |                    | 390pF  | ±10%               | GCG155L81H391KA02# |                    |                    |
|        |               |                    | 470pF  | ±10%               | GCG155L81H471KA02# |                    |                    |
|        |               |                    | 560pF  | ±10%               | GCG155L81H561KA02# |                    |                    |
|        |               |                    | 680pF  | ±10%               | GCG155L81H681KA02# |                    |                    |
|        |               |                    | 820pF  | ±10%               | GCG155L81H821KA02# |                    |                    |
|        |               |                    | 1000pF | ±10%               | GCG155L81H102KA02# |                    |                    |
|        |               |                    | 1200pF | ±10%               | GCG155L81H122KA02# |                    |                    |
|        |               |                    | 1500pF | ±10%               | GCG155L81H152KA02# |                    |                    |
|        |               |                    | 1800pF | ±10%               | GCG155L81H182KA02# |                    |                    |
|        |               |                    | 2200pF | ±10%               | GCG155L81H222KA02# |                    |                    |
|        |               |                    | 2700pF | ±10%               | GCG155L81H272KA02# |                    |                    |
|        |               |                    | 3300pF | ±10%               | GCG155L81H332KA02# |                    |                    |
|        |               |                    | 3900pF | ±10%               | GCG155L81H392KA02# |                    |                    |
|        |               |                    | 4700pF | ±10%               | GCG155L81H472KA02# |                    |                    |
|        |               |                    | X7R    | 50Vdc              | 220pF              | ±10%               | GCG155R71H221KA01# |
|        |               |                    |        |                    |                    | ±20%               | GCG155R71H221MA01# |
|        |               |                    |        |                    | 270pF              | ±10%               | GCG155R71H271KA01# |
|        |               |                    |        |                    |                    | ±20%               | GCG155R71H271MA01# |
|        |               | 330pF              |        |                    | ±10%               | GCG155R71H331KA01# |                    |
|        |               |                    |        |                    | ±20%               | GCG155R71H331MA01# |                    |
|        |               | 390pF              |        |                    | ±10%               | GCG155R71H391KA01# |                    |
|        |               |                    |        |                    | ±20%               | GCG155R71H391MA01# |                    |
|        |               | 470pF              |        |                    | ±10%               | GCG155R71H471KA01# |                    |
|        |               |                    |        |                    | ±20%               | GCG155R71H471MA01# |                    |
|        |               | 560pF              |        |                    | ±10%               | GCG155R71H561KA01# |                    |
|        |               |                    |        |                    | ±20%               | GCG155R71H561MA01# |                    |
|        |               | 680pF              |        |                    | ±10%               | GCG155R71H681KA01# |                    |
|        |               |                    |        |                    | ±20%               | GCG155R71H681MA01# |                    |
|        |               | 820pF              |        |                    | ±10%               | GCG155R71H821KA01# |                    |
|        |               |                    |        |                    | ±20%               | GCG155R71H821MA01# |                    |
|        |               | 1000pF             |        |                    | ±10%               | GCG155R71H102KA01# |                    |
|        |               |                    |        |                    | ±20%               | GCG155R71H102MA01# |                    |
|        |               | 1200pF             |        |                    | ±10%               | GCG155R71H122KA01# |                    |
|        |               |                    |        |                    | ±20%               | GCG155R71H122MA01# |                    |
|        |               | 1500pF             |        |                    | ±10%               | GCG155R71H152KA01# |                    |
|        |               |                    |        |                    | ±20%               | GCG155R71H152MA01# |                    |
|        |               | 1800pF             |        |                    | ±10%               | GCG155R71H182KA01# |                    |
|        |               |                    |        |                    | ±20%               | GCG155R71H182MA01# |                    |
|        |               | 2200pF             |        |                    | ±10%               | GCG155R71H222KA01# |                    |
|        |               |                    |        |                    | ±20%               | GCG155R71H222MA01# |                    |
|        |               | 2700pF             | ±10%   | GCG155R71H272KA01# |                    |                    |                    |
|        |               |                    | ±20%   | GCG155R71H272MA01# |                    |                    |                    |
|        |               | 3300pF             | ±10%   | GCG155R71H332KA01# |                    |                    |                    |
|        |               |                    | ±20%   | GCG155R71H332MA01# |                    |                    |                    |
| 3900pF | ±10%          | GCG155R71H392KA01# |        |                    |                    |                    |                    |
|        | ±20%          | GCG155R71H392MA01# |        |                    |                    |                    |                    |
| 4700pF | ±10%          | GCG155R71H472KA01# |        |                    |                    |                    |                    |
|        | ±20%          | GCG155R71H472MA01# |        |                    |                    |                    |                    |
| 25Vdc  | X8L           | 5600pF             | ±10%   | GCG155L81E562KA01# |                    |                    |                    |

| T max. | Rated Voltage | TC Code | Cap.               | Tol.               | Part Number        |                    |                    |
|--------|---------------|---------|--------------------|--------------------|--------------------|--------------------|--------------------|
| 0.55mm | 25Vdc         | X8L     | 5600pF             | ±20%               | GCG155L81E562MA01# |                    |                    |
|        |               |         | 6800pF             | ±10%               | GCG155L81E682KA01# |                    |                    |
|        |               |         |                    | ±20%               | GCG155L81E682MA01# |                    |                    |
|        |               |         | 8200pF             | ±10%               | GCG155L81E822KA01# |                    |                    |
|        |               |         |                    | ±20%               | GCG155L81E822MA01# |                    |                    |
|        |               |         | 10000pF            | ±10%               | GCG155L81E103KA01# |                    |                    |
|        |               |         |                    | ±20%               | GCG155L81E103MA01# |                    |                    |
|        |               |         | X7R                | 25Vdc              | 5600pF             | ±10%               | GCG155R71E562KA01# |
|        |               |         |                    |                    |                    | ±20%               | GCG155R71E562MA01# |
|        |               |         |                    |                    | 6800pF             | ±10%               | GCG155R71E682KA01# |
|        |               |         |                    |                    |                    | ±20%               | GCG155R71E682MA01# |
|        |               |         |                    |                    | 8200pF             | ±10%               | GCG155R71E822KA01# |
|        |               |         |                    |                    |                    | ±20%               | GCG155R71E822MA01# |
|        |               |         |                    |                    | 10000pF            | ±10%               | GCG155R71E103KA01# |
|        |               | ±20%    | GCG155R71E103MA01# |                    |                    |                    |                    |
|        |               | 16Vdc   | X8L                | 15000pF            | ±10%               | GCG155L81C153KA01# |                    |
|        |               |         |                    |                    | ±20%               | GCG155L81C153MA01# |                    |
|        |               |         |                    | 18000pF            | ±10%               | GCG155L81C183KA01# |                    |
|        |               |         |                    |                    | ±20%               | GCG155L81C183MA01# |                    |
|        |               |         |                    | 22000pF            | ±10%               | GCG155L81C223KA01# |                    |
|        |               |         |                    |                    | ±20%               | GCG155L81C223MA01# |                    |
|        | 27000pF       |         |                    | ±10%               | GCG155L81C273KA01# |                    |                    |
|        |               |         | ±20%               | GCG155L81C273MA01# |                    |                    |                    |
|        | 33000pF       |         | ±10%               | GCG155L81C333KA01# |                    |                    |                    |
|        |               |         | ±20%               | GCG155L81C333MA01# |                    |                    |                    |
|        | X7R           |         | 16Vdc              | 15000pF            | ±10%               | GCG155R71C153KA01# |                    |
|        |               |         |                    |                    | ±20%               | GCG155R71C153MA01# |                    |
|        |               |         |                    | 18000pF            | ±10%               | GCG155R71C183KA01# |                    |
|        |               |         |                    |                    | ±20%               | GCG155R71C183MA01# |                    |
|        |               | 22000pF |                    | ±10%               | GCG155R71C223KA01# |                    |                    |
|        |               |         |                    | ±20%               | GCG155R71C223MA01# |                    |                    |
|        |               | 27000pF |                    | ±10%               | GCG155R71C273KA01# |                    |                    |
|        | ±20%          |         | GCG155R71C273MA01# |                    |                    |                    |                    |
|        | 33000pF       | ±10%    | GCG155R71C333KA01# |                    |                    |                    |                    |
|        |               | ±20%    | GCG155R71C333MA01# |                    |                    |                    |                    |
|        | 0.10μF        | 25Vdc   | 56000pF            | ±10%               | GCG155R71C563KA01# |                    |                    |
|        |               |         |                    | ±20%               | GCG155R71C563MA01# |                    |                    |
|        |               |         | 68000pF            | ±10%               | GCG155R71C683KA01# |                    |                    |
|        |               |         |                    | ±20%               | GCG155R71C683MA01# |                    |                    |
|        |               |         | 82000pF            | ±10%               | GCG155R71C823KA01# |                    |                    |
|        |               |         |                    | ±20%               | GCG155R71C823MA01# |                    |                    |
|        |               |         | 0.10μF             | ±10%               | GCG155R71C104KA01# |                    |                    |
|        |               | ±20%    |                    | GCG155R71C104MA01# |                    |                    |                    |

GRT Series  
 GCM Series  
 GC3 Series  
 GCJ Series  
 GCQ Series  
 GCD Series  
 GCE Series  
 NMF Series  
 KCM Series  
 KC3 Series  
 KCA Series  
 GCB Series  
 GCG Series  
 ⚠Caution /Notice

Part number # indicates the package specification code.

# GCG Series High Dielectric Constant Type Power-train AEC-Q200 Defecting crack Soldering crack Limited to conductive glue mounting Part Number List

1.6×0.8mm

| T max.  | Rated Voltage | TC Code            | Cap.    | Tol.                         | Part Number        |
|---------|---------------|--------------------|---------|------------------------------|--------------------|
| 0.9mm   | 100Vdc        | X8R                | 1000pF  | ±10%                         | GCG188R92A102KA01# |
|         |               |                    |         | ±20%                         | GCG188R92A102MA01# |
|         |               |                    | 1200pF  | ±10%                         | GCG188R92A122KA01# |
|         |               |                    |         | ±20%                         | GCG188R92A122MA01# |
|         |               |                    | 1500pF  | ±10%                         | GCG188R92A152KA01# |
|         |               |                    |         | ±20%                         | GCG188R92A152MA01# |
|         |               |                    | 1800pF  | ±10%                         | GCG188R92A182KA01# |
|         |               |                    |         | ±20%                         | GCG188R92A182MA01# |
|         |               |                    | 2200pF  | ±10%                         | GCG188R92A222KA01# |
|         |               |                    |         | ±20%                         | GCG188R92A222MA01# |
|         |               |                    | 2700pF  | ±10%                         | GCG188R92A272KA01# |
|         |               |                    |         | ±20%                         | GCG188R92A272MA01# |
|         |               |                    | 3300pF  | ±10%                         | GCG188R92A332KA01# |
|         |               |                    |         | ±20%                         | GCG188R92A332MA01# |
|         |               |                    | 3900pF  | ±10%                         | GCG188R92A392KA01# |
|         |               |                    |         | ±20%                         | GCG188R92A392MA01# |
|         |               |                    | 4700pF  | ±10%                         | GCG188R92A472KA01# |
|         |               |                    |         | ±20%                         | GCG188R92A472MA01# |
|         |               |                    | 5600pF  | ±10%                         | GCG188R92A562KA01# |
|         |               |                    |         | ±20%                         | GCG188R92A562MA01# |
|         |               |                    | 6800pF  | ±10%                         | GCG188R92A682KA01# |
|         |               |                    |         | ±20%                         | GCG188R92A682MA01# |
|         |               |                    | 8200pF  | ±10%                         | GCG188R92A822KA01# |
|         |               |                    |         | ±20%                         | GCG188R92A822MA01# |
|         |               |                    | 10000pF | ±10%                         | GCG188R92A103KA01# |
|         |               |                    |         | ±20%                         | GCG188R92A103MA01# |
|         |               |                    | 12000pF | ±10%                         | GCG188R92A123KA01# |
|         |               |                    |         | ±20%                         | GCG188R92A123MA01# |
|         |               |                    | 15000pF | ±10%                         | GCG188R92A153KA01# |
|         |               |                    |         | ±20%                         | GCG188R92A153MA01# |
|         |               |                    | 18000pF | ±10%                         | GCG188R92A183KA01# |
|         |               |                    |         | ±20%                         | GCG188R92A183MA01# |
|         |               |                    | 22000pF | ±10%                         | GCG188R92A223KA01# |
|         |               |                    |         | ±20%                         | GCG188R92A223MA01# |
|         |               |                    | 27000pF | ±10%                         | GCG188R92A273KA01# |
|         |               |                    |         | ±20%                         | GCG188R92A273MA01# |
|         |               |                    | 33000pF | ±10%                         | GCG188R92A333KA01# |
|         |               |                    |         | ±20%                         | GCG188R92A333MA01# |
|         |               |                    | 39000pF | ±10%                         | GCG188R92A393KA01# |
|         |               |                    |         | ±20%                         | GCG188R92A393MA01# |
|         |               |                    | 47000pF | ±10%                         | GCG188R92A473KA01# |
|         |               |                    |         | ±20%                         | GCG188R92A473MA01# |
| 56000pF | ±10%          | GCG188R92A563KA01# |         |                              |                    |
|         | ±20%          | GCG188R92A563MA01# |         |                              |                    |
| 68000pF | ±10%          | GCG188R92A683KA01# |         |                              |                    |
|         | ±20%          | GCG188R92A683MA01# |         |                              |                    |
| 0.10μF  | ±10%          | GCG188R92A104KA03# |         |                              |                    |
|         | ±20%          | GCG188R92A104MA03# |         |                              |                    |
| 50Vdc   | X8L           | 0.15μF             | ±10%    | GCG188L8EH154KA07# <b>D4</b> |                    |
|         |               |                    | ±20%    | GCG188L8EH154MA07# <b>D4</b> |                    |
| 50Vdc   | X8L           | 0.22μF             | ±10%    | GCG188L8EH224KA07# <b>D4</b> |                    |
|         |               |                    | ±20%    | GCG188L8EH224MA07# <b>D4</b> |                    |
|         | X8R           | 1000pF             | ±10%    | GCG188R91H102KA03#           |                    |
|         |               |                    | ±20%    | GCG188R91H102MA03#           |                    |

| T max. | Rated Voltage | TC Code | Cap.    | Tol.               | Part Number        |      |                    |
|--------|---------------|---------|---------|--------------------|--------------------|------|--------------------|
| 0.9mm  | 50Vdc         | X8R     | 1200pF  | ±10%               | GCG188R91H122KA03# |      |                    |
|        |               |         |         | ±20%               | GCG188R91H122MA03# |      |                    |
|        |               |         | 1500pF  | ±10%               | GCG188R91H152KA03# |      |                    |
|        |               |         |         | ±20%               | GCG188R91H152MA03# |      |                    |
|        |               |         | 1800pF  | ±10%               | GCG188R91H182KA03# |      |                    |
|        |               |         |         | ±20%               | GCG188R91H182MA03# |      |                    |
|        |               |         | 2200pF  | ±10%               | GCG188R91H222KA03# |      |                    |
|        |               |         |         | ±20%               | GCG188R91H222MA03# |      |                    |
|        |               |         | 2700pF  | ±10%               | GCG188R91H272KA03# |      |                    |
|        |               |         |         | ±20%               | GCG188R91H272MA03# |      |                    |
|        |               |         | 3300pF  | ±10%               | GCG188R91H332KA03# |      |                    |
|        |               |         |         | ±20%               | GCG188R91H332MA03# |      |                    |
|        |               |         | 3900pF  | ±10%               | GCG188R91H392KA03# |      |                    |
|        |               |         |         | ±20%               | GCG188R91H392MA03# |      |                    |
|        |               |         | 4700pF  | ±10%               | GCG188R91H472KA03# |      |                    |
|        |               |         |         | ±20%               | GCG188R91H472MA03# |      |                    |
|        |               |         | 5600pF  | ±10%               | GCG188R91H562KA03# |      |                    |
|        |               |         |         | ±20%               | GCG188R91H562MA03# |      |                    |
|        |               |         | 6800pF  | ±10%               | GCG188R91H682KA03# |      |                    |
|        |               |         |         | ±20%               | GCG188R91H682MA03# |      |                    |
|        |               |         | 8200pF  | ±10%               | GCG188R91H822KA03# |      |                    |
|        |               |         |         | ±20%               | GCG188R91H822MA03# |      |                    |
|        |               |         | 10000pF | ±10%               | GCG188R91H103KA03# |      |                    |
|        |               |         |         | ±20%               | GCG188R91H103MA03# |      |                    |
|        |               |         | 15000pF | ±10%               | GCG188R91H153KA03# |      |                    |
|        |               |         |         | ±20%               | GCG188R91H153MA03# |      |                    |
|        |               |         | 22000pF | ±10%               | GCG188R91H223KA03# |      |                    |
|        |               |         |         | ±20%               | GCG188R91H223MA03# |      |                    |
|        |               |         | 33000pF | ±10%               | GCG188R91H333KA03# |      |                    |
|        |               |         |         | ±20%               | GCG188R91H333MA03# |      |                    |
|        |               |         | 47000pF | ±10%               | GCG188R91H473KA03# |      |                    |
|        |               |         |         | ±20%               | GCG188R91H473MA03# |      |                    |
|        |               |         | 0.10μF  | X7R                | 0.15μF             | ±10% | GCG188R71H154KA01# |
|        |               |         |         |                    |                    | ±20% | GCG188R71H154MA01# |
|        |               |         | 0.12μF  | X7R                | 0.22μF             | ±10% | GCG188R71H224KA01# |
|        |               |         |         |                    |                    | ±20% | GCG188R71H224MA01# |
|        |               |         | 0.15μF  | X7R                | 0.22μF             | ±10% | GCG188R71H224KA01# |
|        |               |         |         |                    |                    | ±20% | GCG188R71H224MA01# |
|        |               |         | 0.18μF  | X7R                | 0.22μF             | ±10% | GCG188R71H224KA01# |
|        |               |         |         |                    |                    | ±20% | GCG188R71H224MA01# |
|        |               |         | 0.22μF  | X7R                | 0.22μF             | ±10% | GCG188R71H224KA01# |
|        |               |         |         |                    |                    | ±20% | GCG188R71H224MA01# |
| 0.33μF | X8R           | 0.33μF  | ±10%    | GCG188R91E334KA01# |                    |      |                    |
|        |               |         | ±20%    | GCG188R91E334MA01# |                    |      |                    |
| 0.39μF | X8R           | 0.39μF  | ±10%    | GCG188R91E394KA01# |                    |      |                    |
|        |               |         | ±20%    | GCG188R91E394MA01# |                    |      |                    |
| 0.47μF | X8R           | 0.47μF  | ±10%    | GCG188R91E474KA01# |                    |      |                    |
|        |               |         | ±20%    | GCG188R91E474MA01# |                    |      |                    |
| 0.12μF | X7R           | 0.12μF  | ±5%     | GCG188R71E124JA12# |                    |      |                    |
|        |               |         | ±10%    | GCG188R71E124KA12# |                    |      |                    |

Part number # indicates the package specification code.

GRT Series  
 GCM Series  
 GC3 Series  
 GCJ Series  
 GCQ Series  
 GCD Series  
 GCE Series  
 NMF Series  
 KCM Series  
 KC3 Series  
 KCA Series  
 GCB Series  
 GCG Series  
 ⚠Caution /Notice



# GCG Series High Dielectric Constant Type Power-train AEC-Q200 Defecting crack Soldering crack Limited to conductive glue mounting Part Number List

(→ 1.6×0.8mm)

| T max. | Rated Voltage | TC Code | Cap.   | Tol.               | Part Number        |                    |                    |  |
|--------|---------------|---------|--------|--------------------|--------------------|--------------------|--------------------|--|
| 0.9mm  | 25Vdc         | X7R     | 0.12μF | ±20%               | GCG188R71E124MA12# |                    |                    |  |
|        |               |         |        | ±5%                | GCG188R71E154JA12# |                    |                    |  |
|        |               |         |        |                    | ±10%               | GCG188R71E154KA12# |                    |  |
|        |               |         | ±20%   | GCG188R71E154MA12# |                    |                    |                    |  |
|        |               |         |        | 0.18μF             | ±5%                | GCG188R71E184JA12# |                    |  |
|        |               |         |        |                    | ±10%               | GCG188R71E184KA12# |                    |  |
|        |               |         | ±20%   |                    | GCG188R71E184MA12# |                    |                    |  |
|        |               |         | 0.22μF | ±5%                | GCG188R71E224JA12# |                    |                    |  |
|        |               |         |        | ±10%               | GCG188R71E224KA12# |                    |                    |  |
|        |               |         |        | ±20%               | GCG188R71E224MA12# |                    |                    |  |
|        |               |         | 16Vdc  | X8L                | 0.15μF             | ±10%               | GCG188L81C154KA01# |  |
|        |               |         |        |                    |                    | ±20%               | GCG188L81C154MA01# |  |
|        | 0.22μF        | ±10%    |        |                    | GCG188L81C224KA01# |                    |                    |  |
|        |               | ±20%    |        | GCG188L81C224MA01# |                    |                    |                    |  |
|        | X7R           | 1.0μF   |        | ±10%               | GCG188R71C105KA01# |                    |                    |  |
|        |               |         |        | ±20%               | GCG188R71C105MA01# | <b>D4</b>          |                    |  |
|        |               | 2.2μF   | ±10%   | GCG188C71A225KE01# |                    |                    |                    |  |
|        | 10Vdc         | X7S     | 2.2μF  | ±10%               | GCG188C71A225ME01# |                    |                    |  |
|        |               |         |        | ±20%               | GCG188C71A225ME01# |                    |                    |  |
|        | 6.3Vdc        | X7R     | 2.2μF  | ±10%               | GCG188R70J225KE01# |                    |                    |  |
| ±20%   |               |         |        | GCG188R70J225ME01# |                    |                    |                    |  |

2.0×1.25mm

| T max. | Rated Voltage | TC Code | Cap.               | Tol.               | Part Number        |                    |                    |           |
|--------|---------------|---------|--------------------|--------------------|--------------------|--------------------|--------------------|-----------|
| 1.45mm | 50Vdc         | X8L     | 1.0μF              | ±10%               | GCG21BL8EH105KA07# | <b>D4</b>          |                    |           |
|        |               |         |                    | X7R                | 0.15μF             | ±5%                | GCG21BR71H154JA01# |           |
|        |               |         |                    |                    |                    | ±10%               | GCG21BR71H154KA01# |           |
|        |               | ±20%    | GCG21BR71H154MA01# |                    |                    |                    |                    |           |
|        |               | 0.18μF  | ±5%                | GCG21BR71H184JA01# |                    |                    |                    |           |
|        |               |         | ±10%               | GCG21BR71H184KA01# |                    |                    |                    |           |
|        |               |         | ±20%               | GCG21BR71H184MA01# |                    |                    |                    |           |
|        |               | 0.22μF  | ±5%                | GCG21BR71H224JA01# |                    |                    |                    |           |
|        |               |         | ±10%               | GCG21BR71H224KA01# |                    |                    |                    |           |
|        |               |         | ±20%               | GCG21BR71H224MA01# |                    |                    |                    |           |
|        |               | 0.33μF  | ±10%               | GCG21BR71H334KA01# |                    |                    |                    |           |
|        |               |         | ±20%               | GCG21BR71H334MA01# |                    |                    |                    |           |
|        |               |         | 0.47μF             | ±10%               | GCG21BR71H474KA01# |                    |                    |           |
|        |               | ±20%    |                    | GCG21BR71H474MA01# |                    |                    |                    |           |
|        |               | 1.0μF   |                    | ±10%               | GCG21BR71H105KA01# |                    |                    |           |
|        |               |         | ±20%               | GCG21BR71H105MA01# |                    |                    |                    |           |
|        |               |         | 35Vdc              | X8L                | 0.68μF             | ±10%               | GCG21BL8EG684KA07# | <b>D4</b> |
|        |               | ±10%    |                    |                    |                    | GCG21BL8EG105KA07# | <b>D4</b>          |           |
|        | X7R           | 0.68μF  |                    | ±10%               | GCG21BR7YA684KA01# |                    |                    |           |
|        |               |         |                    | ±20%               | GCG21BR7YA684MA01# |                    |                    |           |
|        |               | 1.0μF   |                    | ±10%               | GCG21BR7YA105KA01# |                    |                    |           |
|        |               |         |                    | ±20%               | GCG21BR7YA105MA01# |                    |                    |           |
|        | 25Vdc         | X8L     | 0.33μF             | ±10%               | GCG21BL81E334KA01# |                    |                    |           |
|        |               |         |                    | ±20%               | GCG21BL81E334MA01# |                    |                    |           |
|        |               |         |                    | X8R                | 0.68μF             | ±10%               | GCG21BR91E684KE01# |           |
|        |               | ±20%    | GCG21BR91E684ME01# |                    |                    |                    |                    |           |
|        |               | 0.82μF  | ±10%               |                    | GCG21BR91E824KE01# |                    |                    |           |
|        |               | ±20%    | GCG21BR91E824ME01# |                    |                    |                    |                    |           |

| T max. | Rated Voltage | TC Code | Cap.               | Tol.               | Part Number        |                    |  |
|--------|---------------|---------|--------------------|--------------------|--------------------|--------------------|--|
| 1.45mm | 25Vdc         | X8R     | 1.0μF              | ±10%               | GCG21BR91E105KE01# |                    |  |
|        |               |         |                    | ±20%               | GCG21BR91E105ME01# |                    |  |
|        |               |         | X7R                | 0.27μF             | ±5%                | GCG21BR71E274JA01# |  |
|        |               |         |                    |                    | ±10%               | GCG21BR71E274KA01# |  |
|        |               |         |                    |                    | ±20%               | GCG21BR71E274MA01# |  |
|        |               |         |                    | 0.33μF             | ±5%                | GCG21BR71E334JA01# |  |
|        |               |         |                    |                    | ±10%               | GCG21BR71E334KA01# |  |
|        |               |         |                    |                    | ±20%               | GCG21BR71E334MA01# |  |
|        |               |         | 0.39μF             | ±5%                | GCG21BR71E394JA01# |                    |  |
|        |               |         |                    | ±10%               | GCG21BR71E394KA01# |                    |  |
|        |               |         |                    | ±20%               | GCG21BR71E394MA01# |                    |  |
|        |               |         | 0.47μF             | ±5%                | GCG21BR71E474JA01# |                    |  |
|        |               | ±10%    |                    | GCG21BR71E474KA01# |                    |                    |  |
|        |               | ±20%    |                    | GCG21BR71E474MA01# |                    |                    |  |
|        |               | 0.56μF  |                    | ±5%                | GCG21BR71E564JA01# |                    |  |
|        |               |         |                    | ±10%               | GCG21BR71E564KA01# |                    |  |
|        |               |         |                    | ±20%               | GCG21BR71E564MA01# |                    |  |
|        |               | 0.68μF  | ±5%                | GCG21BR71E684JA01# |                    |                    |  |
|        |               |         | ±10%               | GCG21BR71E684KA01# |                    |                    |  |
|        |               |         | ±20%               | GCG21BR71E684MA01# |                    |                    |  |
|        |               |         | 0.82μF             | ±5%                | GCG21BR71E824JA01# |                    |  |
|        |               |         |                    | ±10%               | GCG21BR71E824KA01# |                    |  |
|        |               |         |                    | ±20%               | GCG21BR71E824MA01# |                    |  |
|        |               | 1.0μF   | ±5%                | GCG21BR71E105JA12# |                    |                    |  |
|        | ±10%          |         | GCG21BR71E105KA12# |                    |                    |                    |  |
|        | ±20%          |         | GCG21BR71E105MA12# |                    |                    |                    |  |
|        | 16Vdc         |         | X8L                | 0.33μF             | ±10%               | GCG21BL81C334KA01# |  |
|        |               |         |                    |                    | ±20%               | GCG21BL81C334MA01# |  |
|        |               |         |                    | 0.39μF             | ±10%               | GCG21BL81C394KA01# |  |
|        |               | ±20%    |                    |                    | GCG21BL81C394MA01# |                    |  |
|        |               | 0.47μF  |                    | ±10%               | GCG21BL81C474KA01# |                    |  |
|        |               |         |                    | ±20%               | GCG21BL81C474MA01# |                    |  |
|        |               | 0.56μF  | ±10%               | GCG21BL81C564KA01# |                    |                    |  |
|        |               |         | ±20%               | GCG21BL81C564MA01# |                    |                    |  |
|        |               |         | 0.68μF             | ±10%               | GCG21BL81C684KA01# |                    |  |
|        |               | ±20%    |                    | GCG21BL81C684MA01# |                    |                    |  |
|        |               | 0.82μF  |                    | ±10%               | GCG21BL81C824KA01# |                    |  |
|        |               |         | ±20%               | GCG21BL81C824MA01# |                    |                    |  |
|        | X7R           |         | 4.7μF              | ±10%               | GCG21BR71C475KA12# |                    |  |
|        |               | ±20%    |                    | GCG21BR71C475MA12# |                    |                    |  |
|        | 10Vdc         | X7R     | 10μF               | ±10%               | GCG21BR71A106KE01# |                    |  |
|        |               |         |                    | ±20%               | GCG21BR71A106ME01# |                    |  |
|        | 6.3Vdc        | X8L     | 10μF               | ±10%               | GCG21BL8EC106KE07# | <b>D4</b>          |  |
|        |               |         |                    | ±20%               | GCG21BL8EC106ME07# |                    |  |
|        | X7R           | 10μF    | ±10%               | GCG21BR70J106KE01# |                    |                    |  |
|        |               |         | ±20%               | GCG21BR70J106ME01# |                    |                    |  |

3.2×1.6mm

| T max. | Rated Voltage | TC Code            | Cap.   | Tol. | Part Number        |  |
|--------|---------------|--------------------|--------|------|--------------------|--|
| 1.35mm | 50Vdc         | X8R                | 0.22μF | ±10% | GCG31MR91H224KA03# |  |
|        |               |                    |        | ±20% | GCG31MR91H224MA03# |  |
|        |               |                    | 0.33μF | ±10% | GCG31MR91H334KA03# |  |
|        | ±20%          | GCG31MR91H334MA03# |        |      |                    |  |
|        | 25Vdc         | X7R                | 1.2μF  | ±5%  | GCG31MR71E125JA01# |  |

Part number # indicates the package specification code.

# GCG Series High Dielectric Constant Type Part Number List

(→ 3.2×1.6mm)

| T max. | Rated Voltage      | TC Code            | Cap.               | Tol.               | Part Number        |                    |                    |      |
|--------|--------------------|--------------------|--------------------|--------------------|--------------------|--------------------|--------------------|------|
| 1.35mm | 25Vdc              | X7R                | 1.2μF              | ±10%               | GCG31MR71E125KA01# |                    |                    |      |
|        |                    |                    |                    | ±20%               | GCG31MR71E125MA01# |                    |                    |      |
|        |                    |                    | 1.5μF              | ±5%                | GCG31MR71E155JA01# |                    |                    |      |
|        |                    |                    |                    | ±10%               | GCG31MR71E155KA01# |                    |                    |      |
|        |                    |                    |                    | ±20%               | GCG31MR71E155MA01# |                    |                    |      |
|        |                    |                    |                    | 2.2μF              | ±5%                | GCG31MR71E225JA12# |                    |      |
|        |                    | ±10%               | GCG31MR71E225KA12# |                    |                    |                    |                    |      |
|        |                    | 16Vdc              | X8L                | 1.0μF              | ±10%               | GCG31ML81C105KA01# |                    |      |
|        |                    |                    |                    |                    | ±20%               | GCG31ML81C105MA01# |                    |      |
|        |                    |                    | 1.5μF              | ±10%               | GCG31ML81C155KA01# |                    |                    |      |
|        |                    |                    |                    | ±20%               | GCG31ML81C155MA01# |                    |                    |      |
|        |                    |                    |                    | 1.9mm              | 25Vdc              | X8R                | 1.0μF              | ±10% |
| ±20%   | GCG31CR91E105MA03# |                    |                    |                    |                    |                    |                    |      |
| X7R    | 3.3μF              | ±5%                | GCG31CR71E335JA01# |                    |                    |                    |                    |      |
|        |                    | ±10%               | GCG31CR71E335KA01# |                    |                    |                    |                    |      |
|        |                    | ±20%               | GCG31CR71E335MA01# |                    |                    |                    |                    |      |
|        | 3.9μF              | ±5%                | GCG31CR71E395JA01# |                    |                    |                    |                    |      |
|        |                    | ±10%               | GCG31CR71E395KA01# |                    |                    |                    |                    |      |
|        |                    | ±20%               | GCG31CR71E395MA01# |                    |                    |                    |                    |      |
| 4.7μF  | ±5%                | GCG31CR71E475JA01# |                    |                    |                    |                    |                    |      |
|        | ±10%               | GCG31CR71E475KA01# |                    |                    |                    |                    |                    |      |
|        | ±20%               | GCG31CR71E475MA01# |                    |                    |                    |                    |                    |      |
|        | 16Vdc              | X8L                | 3.3μF              |                    |                    | ±10%               | GCG31CL81C335KA01# |      |
| ±20%   |                    |                    |                    | GCG31CL81C335MA01# |                    |                    |                    |      |
| 4.7μF  |                    | ±10%               | GCG31CL81C475KA01# |                    |                    |                    |                    |      |
|        |                    | ±20%               | GCG31CL81C475MA01# |                    |                    |                    |                    |      |
|        |                    | X8R                | 0.68μF             | ±10%               | GCG31CR91C684KA01# |                    |                    |      |
|        |                    |                    |                    | ±20%               | GCG31CR91C684MA01# |                    |                    |      |
| 1.0μF  | ±10%               |                    | GCG31CR91C105KA01# |                    |                    |                    |                    |      |
|        | ±20%               |                    | GCG31CR91C105MA01# |                    |                    |                    |                    |      |
| 6.3Vdc | X7R                | 22μF               | ±10%               | GCG31CR70J226KE01# |                    |                    |                    |      |
|        |                    |                    | ±20%               | GCG31CR70J226ME01# |                    |                    |                    |      |

## 3.2×2.5mm

| T max. | Rated Voltage | TC Code | Cap.  | Tol.               | Part Number        |                    |                    |           |
|--------|---------------|---------|-------|--------------------|--------------------|--------------------|--------------------|-----------|
| 2.8mm  | 50Vdc         | X8L     | 10μF  | ±10%               | GCG32EL8EH106KA07# | <b>D4</b>          |                    |           |
|        |               |         |       | ±20%               | GCG32EC71H106MA01# |                    |                    |           |
|        |               | X7S     | 10μF  | ±10%               | GCG32EC71H106KA01# |                    |                    |           |
|        |               |         |       | ±20%               | GCG32EC71H106MA01# |                    |                    |           |
|        |               |         | 35Vdc | X8L                | 10μF               | ±10%               | GCG32EL8EG106KA07# | <b>D4</b> |
|        |               |         |       |                    |                    | ±20%               | GCG32EC7YA106MA01# |           |
|        | 25Vdc         | X7S     | 10μF  | ±10%               | GCG32EC7YA106KA01# |                    |                    |           |
|        |               |         |       | ±20%               | GCG32EC7YA106MA01# |                    |                    |           |
|        |               | X8L     | 22μF  | ±10%               | GCG32EL8EF226KE07# | <b>D4</b>          |                    |           |
|        |               |         |       | ±20%               | GCG32ER71E106KA12# |                    |                    |           |
|        |               |         | X7R   | 10μF               | ±10%               | GCG32ER71E106KA12# |                    |           |
|        |               |         |       |                    | ±20%               | GCG32ER71E106MA12# |                    |           |
|        | 16Vdc         | X7S     | 22μF  | ±10%               | GCG32EC71E226KE01# |                    |                    |           |
|        |               |         |       | ±20%               | GCG32ER91C685KE01# |                    |                    |           |
|        |               | X8R     | 6.8μF | ±10%               | GCG32ER91C685KE01# |                    |                    |           |
|        |               |         |       | ±20%               | GCG32ER91C685ME01# |                    |                    |           |
|        |               |         | 10μF  | ±10%               | GCG32ER91C106KE01# |                    |                    |           |
|        |               |         |       | ±20%               | GCG32ER91C106ME01# |                    |                    |           |
| 6.3Vdc | X7R           | 47μF    | ±10%  | GCG32ER70J476KE01# |                    |                    |                    |           |
|        |               |         | ±20%  | GCG32ER70J476ME01# |                    |                    |                    |           |

Part number # indicates the package specification code.

## ⚠Caution/Notice



**Target series: GRT, GCM, GC3, GCJ, GCQ, GCD, GCE, NFM, KCM, KC3, KCA, GCB, GCG**

### ⚠Caution

|   |     |
|---|-----|
| Storage and Operation Conditions .....  | 148 |
| Rating .....  | 148 |
| 1. Temperature Dependent Characteristics .....                                    | 148 |
| 2. Measurement of Capacitance .....   | 148 |
| 3. Applied Voltage and Applied Current .....                                      | 149 |
| 4. Type of Applied Voltage and Self-heating Temperature .....                     | 149 |
| 5. DC Voltage and AC Voltage Characteristics .....                                | 151 |
| 6. Capacitance Aging .....  | 151 |
| 7. Vibration and Shock .....  | 152 |
| Soldering and Mounting .....  | 152 |
| 1. Mounting Position .....  | 152 |
| 2. Information before Mounting .....  | 153 |
| 3. Maintenance of the Mounting (pick and place) Machine .....                     | 153 |
| 4-1. Reflow Soldering .....   | 154 |
| 4-2. Flow Soldering .....   | 155 |
| 4-3. Correction of Soldered Portion .....   | 156 |
| 5. Washing .....  | 157 |
| 6. Electrical Test on Printed Circuit Board .....                                 | 157 |
| 7. Printed Circuit Board Cropping .....   | 157 |
| 8. Assembly .....   | 160 |
| 9. Selection of Conductive Adhesive, Mounting Process, and Bonding Strength ..... | 161 |
| 10. Moisture Proof Process .....  | 161 |
| 11. Application .....   | 161 |
| Other .....   | 161 |
| 1. Under Operation of Equipment .....   | 161 |
| 2. Other .....  | 161 |

### Notice

|  |     |
|--|-----|
| Rating .....   | 162 |
| 1. Operating Temperature .....                           | 162 |
| 2. Atmosphere Surroundings (gaseous and liquid) .....    | 162 |
| 3. Piezo-electric Phenomenon .....                       | 162 |
| Soldering and Mounting .....                             | 162 |
| 1. PCB Design .....                                      | 162 |
| 1. Notice for Pattern Forms .....                        | 162 |
| 2. Land Dimensions .....                                 | 163 |
| 3. Board Design .....                                    | 165 |
| 2. Item to be confirmed for Flow soldering .....         | 165 |
| 3. Reflow Soldering .....                                | 166 |
| 4. Washing .....   | 167 |
| 5. Coating .....   | 167 |
| Other .....  | 167 |
| 1. Transportation .....                                  | 167 |
| 2. Characteristics Evaluation in the Actual System ..... | 167 |

GRT Series  
 GCM Series  
 GC3 Series  
 GCJ Series  
 GCQ Series  
 GCD Series  
 GCE Series  
 NFM Series  
 KCM Series  
 KC3 Series  
 KCA Series  
 GCB Series  
 GCG Series  
 ⚠Caution / Notice

**⚠Caution**

**Storage and Operation Conditions**

1. The performance of chip multilayer ceramic capacitors (henceforth just "capacitors") may be affected by the storage conditions.

Please use them promptly after delivery.

1-1. Maintain appropriate storage for the capacitors using the following conditions:

Room Temperature of +5°C to +40°C and a Relative Humidity of 20% to 70%.

High temperature and humidity conditions and/or prolonged storage may cause deterioration of the packaging materials. If more than six months have elapsed since delivery, check packaging, mounting, etc. before use.

In addition, this may cause oxidation of the electrodes.

If more than one year has elapsed since delivery, also check the solderability before use.

1-2. Corrosive gas can react with the termination (external) electrodes or lead wires of capacitors, and result in poor solderability. Do not store the capacitors in an atmosphere consisting of corrosive gas (e.g., hydrogen sulfide, sulfur dioxide, chlorine, ammonia gas etc.).

1-3. Due to moisture condensation caused by rapid humidity changes, or the photochemical change caused by direct sunlight on the terminal electrodes and/or the resin/epoxy coatings, the solderability and electrical performance may deteriorate. Do not store capacitors under direct sunlight or in high humidity conditions

**<Applicable to GCG Series>**

1-4. After unpacking, immediately reseal, or store in a desiccator containing a desiccant.

**Rating**

**1. Temperature Dependent Characteristics**

1. The electrical characteristics of a capacitor can change with temperature.

1-1. For capacitors having larger temperature dependency, the capacitance may change with temperature changes.

The following actions are recommended in order to ensure suitable capacitance values.

(1) Select a suitable capacitance for the operating temperature range.

(2) The capacitance may change within the rated temperature.

When you use a high dielectric constant type capacitor in a circuit that needs a tight (narrow) capacitance tolerance (e.g., a time-constant circuit), please carefully consider the temperature characteristics, and carefully confirm the various characteristics in actual use conditions and the actual system.

[Example of Temperature Characteristics X7R(R7)]

Sample: 0.1μF, Rated Voltage 50VDC

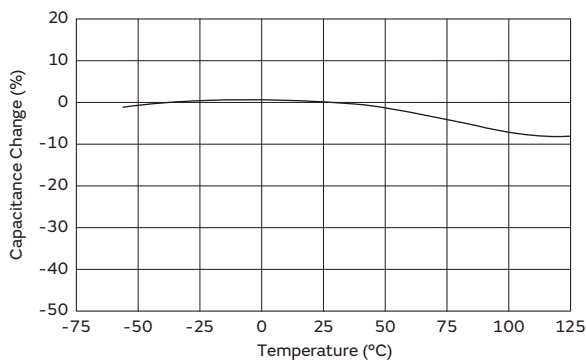

[Example of Temperature Characteristics X5R (R6)]

Sample: 22μF, Rated Voltage 4VDC

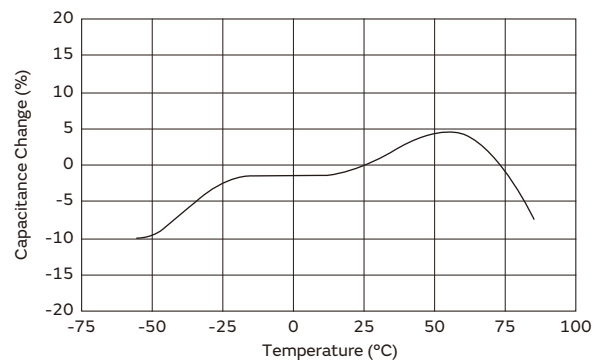

**2. Measurement of Capacitance**

1. Measure capacitance with the voltage and frequency specified in the product specifications.

1-1. The output voltage of the measuring equipment may decrease occasionally when capacitance is high. Please confirm whether a prescribed measured voltage is impressed to the capacitor.

1-2. The capacitance values of high dielectric constant type capacitors change depending on the AC voltage applied. Please consider the AC voltage characteristics when selecting a capacitor to be used in an AC circuit.

Continued on the following page. ↗

**△Caution**

Continued from the preceding page. ↘

**3. Applied Voltage and Applied Current**

1. Do not apply a voltage to the capacitor that exceeds the rated voltage as called out in the specifications.
  - 1-1. Applied voltage between the terminals of a capacitor shall be less than or equal to the rated voltage.
    - (1) When AC voltage is superimposed on DC voltage, the zero-to-peak voltage shall not exceed the rated DC voltage.  
 When AC voltage or pulse voltage is applied, the peak-to-peak voltage shall not exceed the rated DC voltage.
    - (2) Abnormal voltages (surge voltage, static electricity, pulse voltage, etc.) shall not exceed the rated DC voltage.

**Typical Voltage Applied to the DC Capacitor**

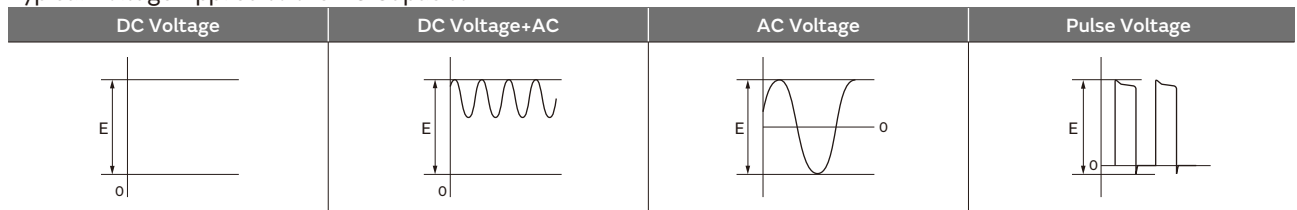

(E: Maximum possible applied voltage.)

- 1-2. Influence of over voltage  
 Over voltage that is applied to the capacitor may result in an electrical short circuit caused by the breakdown of the internal dielectric layers. The time duration until breakdown depends on the applied voltage and the ambient temperature.
2. Use a safety standard certified capacitor in a power supply input circuit (AC filter), as it is also necessary to consider the withstand voltage and impulse withstand voltage defined for each device.

**4. Type of Applied Voltage and Self-heating Temperature**

1. Confirm the operating conditions to make sure that no large current is flowing into the capacitor due to the continuous application of an AC voltage or pulse voltage.  
 When a DC rated voltage product is used in an AC voltage circuit or a pulse voltage circuit, the AC current or pulse current will flow into the capacitor; therefore check the self-heating condition.  
 Please confirm the surface temperature of the capacitor so that the temperature remains within the upper limits of the operating temperature, including the rise in temperature due to self-heating. When the capacitor is used with a high-frequency voltage or pulse voltage, heat may be generated by dielectric loss.  
**<Applicable to Rated Voltage of less than 100VDC>**
  - 1-1. The load should be contained so that the self-heating of the capacitor body remains below 20°C, when measuring at an ambient temperature of 25°C.

**<Applicable to NFM Series>**

3. The capacitors also have rated currents.  
 The current flowing between the terminals of a capacitor shall be less than or equal to the rated current. Using the capacitor beyond this range could lead to excessive heat.

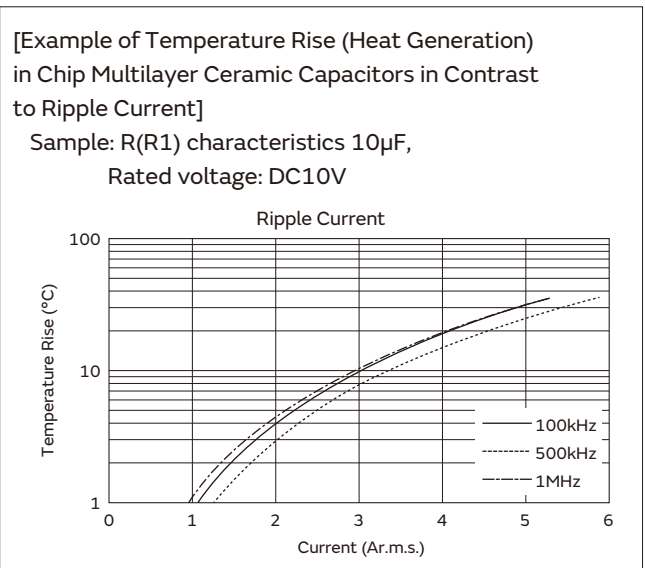

Continued on the following page. ↗

**⚠Caution**

Continued from the preceding page. ↘

**<Applicable to Temperature Characteristics X7R(R7), X7T(D7) beyond Rated Voltage of 250VDC>**

1-2. The load should be contained so that the self-heating of the capacitor body remains below 20°C, when measuring at an ambient temperature of 25°C. In addition, use a K thermocouple of  $\varnothing 0.1\text{mm}$  with less heat capacity when measuring, and measure in a condition where there is no effect from the radiant heat of other components or air flow caused by convection. Excessive generation of heat may cause deterioration of the characteristics and reliability of the capacitor. (Absolutely do not perform measurements while the cooling fan is operating, as an accurate measurement may not be performed.)

**<Applicable to Temperature Characteristics U2J(7U), COG(5C) beyond Rated Voltage of 250VDC>**

1-3. Since the self-heating is low in the low loss series, the allowable power becomes extremely high compared to the common X7R(R7) characteristics. However, when a load with self-heating of 20°C is applied at the rated voltage, the allowable power may be exceeded. When the capacitor is used in a high-frequency voltage circuit of 1kHz or more, the frequency of the applied voltage should be less than 500kHz sine wave (less than 100kHz for a product with rated voltage of DC3.15kV), to limit the voltage load so that the load remains within the derating shown in the following figure. In the case of non-sine wave, high-frequency components exceeding the fundamental frequency may be included. In such a case, please contact Murata. The excessive generation of heat may cause deterioration of the characteristics and reliability of the capacitor. (Absolutely do not perform measurements while the cooling fan is operating, as an accurate measurement may not be performed.)

[Sine-wave frequency VS allowable voltage]

The surface temperature of the capacitor: 125°C or less (including self-heating)

COG (5C) char., Rated Voltage: DC250V  
 Chip (L×W): 3.2×1.6mm

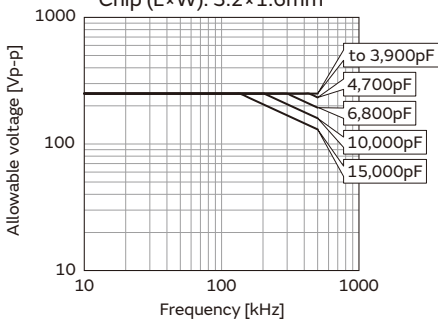

COG char., Rated Voltage: DC630V  
 Chip (L×W): 3.2×1.6mm

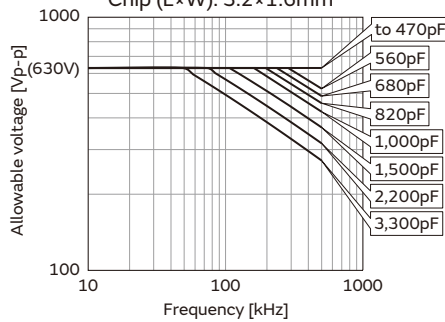

COG char., Rated Voltage: DC1kV  
 Chip (L×W): 3.2×1.6mm

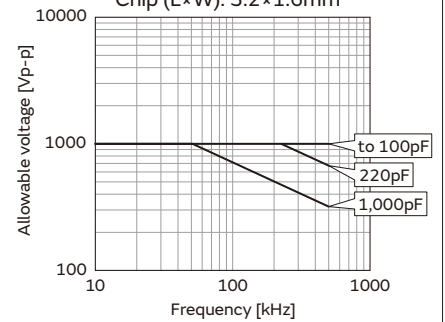

U2J(7U) char., Rated Voltage: DC250V  
 Chip (L×W): 2.0×1.25mm, 3.2×1.6mm

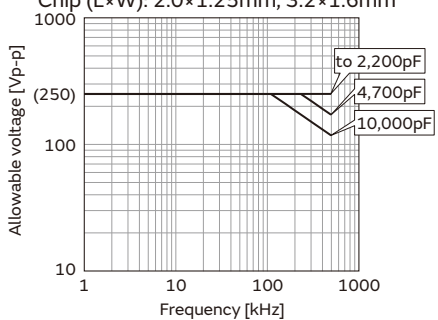

U2J(7U) char., Rated Voltage: DC630V  
 Chip (L×W): 3.2×1.6mm, 3.2×2.5mm

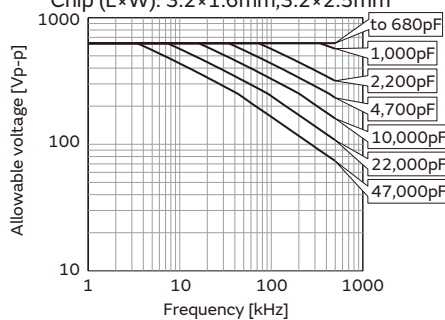

U2J(7U) char., Rated Voltage: DC1kV  
 Chip (L×W): 3.2×1.6mm, 3.2×2.5mm

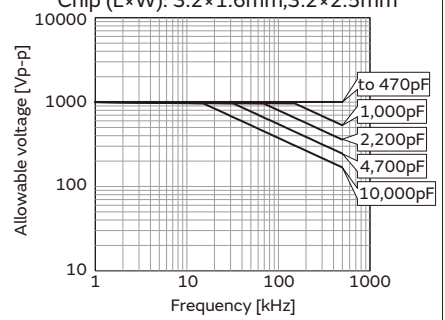

Continued on the following page. ↗

GRT Series  
 GCM Series  
 GC3 Series  
 GCJ Series  
 GCQ Series  
 GCD Series  
 GCE Series  
 NMF Series  
 KCM Series  
 KC3 Series  
 KCA Series  
 GCB Series  
 GCG Series

⚠Caution

## ⚠Caution

Continued from the preceding page. ↘

### 5. DC Voltage and AC Voltage Characteristics

1. The capacitance value of a high dielectric constant type capacitor changes depending on the DC voltage applied. Please consider the DC voltage characteristics when a capacitor is selected for use in a DC circuit.

1-1. The capacitance of ceramic capacitors may change sharply depending on the applied voltage (see figure). Please confirm the following in order to secure the capacitance.

- (1) Determine whether the capacitance change caused by the applied voltage is within the allowed range.
- (2) In the DC voltage characteristics, the rate of capacitance change becomes larger as voltage increases, even if the applied voltage is below the rated voltage. When a high dielectric constant type capacitor is used in a circuit that requires a tight (narrow) capacitance tolerance (e.g., a time constant circuit), please carefully consider the voltage characteristics, and confirm the various characteristics in the actual operating conditions of the system.

2. The capacitance values of high dielectric constant type capacitors changes depending on the AC voltage applied. Please consider the AC voltage characteristics when selecting a capacitor to be used in an AC circuit.

[Example of DC Voltage Characteristics]

Sample: R(R1) Characteristics 0.1 $\mu$ F,  
 Rated Voltage 50VDC

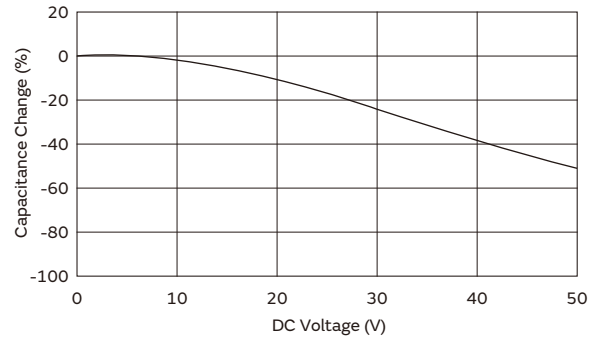

[Example of AC Voltage Characteristics]

Sample: X7R(R7) Characteristics 10 $\mu$ F,  
 Rated Voltage 6.3VDC

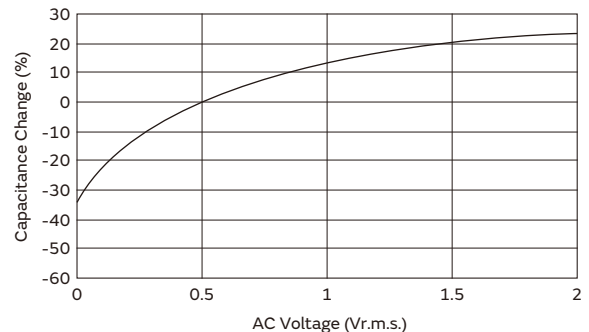

### 6. Capacitance Aging

1. The high dielectric constant type capacitors have the Characteristics in which the capacitance value decreases with the passage of time.

When you use high dielectric constant type capacitors in a circuit that needs a tight (narrow) capacitance tolerance (e.g., a time-constant circuit), please carefully consider the characteristics of these capacitors, such as their aging, voltage, and temperature characteristics. In addition, check capacitors using your actual appliances at the intended environment and operating conditions.

[Example of Change Over Time (Aging Characteristics)]

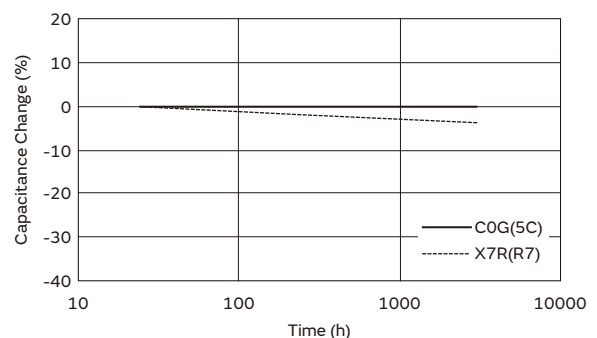

Continued on the following page. ↗

GRT Series  
 GCM Series  
 GC3 Series  
 GCJ Series  
 GCQ Series  
 GCD Series  
 GCE Series  
 NMF Series  
 KCM Series  
 KC3 Series  
 KCA Series  
 GCB Series  
 GCG Series  
 ⚠Caution



**⚠Caution**

Continued from the preceding page. ↘

**7. Vibration and Shock**

1. Please confirm the kind of vibration and/or shock, its condition, and any generation of resonance.  
 Please mount the capacitor so as not to generate resonance, and do not allow any impact on the terminals.
2. Mechanical shock due to being dropped may cause damage or a crack in the dielectric material of the capacitor.  
 Do not use a dropped capacitor because the quality and reliability may be deteriorated.
3. When printed circuit boards are piled up or handled, the corner of another printed circuit board should not be allowed to hit the capacitor, in order to avoid a crack or other damage to the capacitor.

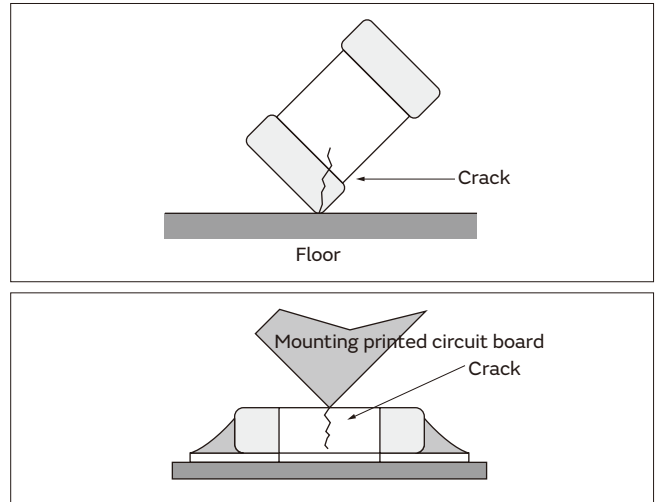

**Soldering and Mounting**

**1. Mounting Position**

1. Confirm the best mounting position and direction that minimizes the stress imposed on the capacitor during flexing or bending the printed circuit board.
  - 1-1. Choose a mounting position that minimizes the stress imposed on the chip during flexing or bending of the board.

**<Applicable to NFM Series>**

2. If you mount the capacitor near components that generate heat, take note of the heat from the other components and carefully check the self-heating of the capacitor before using.  
 If there is significant heat radiation from other components, it could lower the insulation resistance of the capacitor or produce excessive heat.

**[Component Direction]**

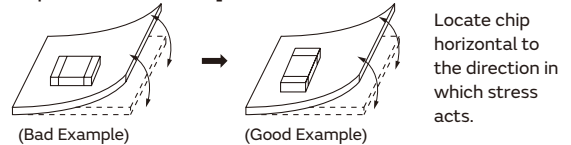

**[Chip Mounting Close to Board Separation Point]**

It is effective to implement the following measures, to reduce stress in separating the board.  
 It is best to implement all of the following three measures; however, implement as many measures as possible to reduce stress.

| Contents of Measures   | Stress Level |
|--|--------------|
| (1) Turn the mounting direction of the component parallel to the board separation surface. | A > D *1     |
| (2) Add slits in the board separation part.  | A > B        |
| (3) Keep the mounting position of the component away from the board separation surface.    | A > C        |

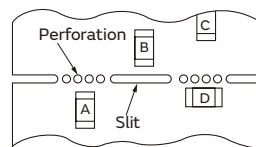

\*1 A > D is valid when stress is added vertically to the perforation as with Hand Separation.  
 If a Cutting Disc is used, stress will be diagonal to the PCB, therefore A > D is invalid.

**[Mounting Capacitors Near Screw Holes]**

When a capacitor is mounted near a screw hole, it may be affected by the board deflection that occurs during the tightening of the screw. Mount the capacitor in a position as far away from the screw holes as possible.

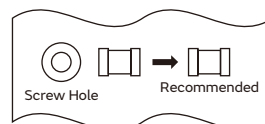

Continued on the following page. ↗

GRT Series  
 GCM Series  
 GC3 Series  
 GCJ Series  
 GCQ Series  
 GCD Series  
 GCE Series  
 NFM Series  
 KCM Series  
 KC3 Series  
 KCA Series  
 GCB Series  
 GCG Series  
 ⚠Caution



## △Caution

Continued from the preceding page. ↘

### 2. Information before Mounting

1. Do not re-use capacitors that were removed from the equipment.
2. Confirm capacitance characteristics under actual applied voltage.
3. Confirm the mechanical stress under actual process and equipment use.
4. Confirm the rated capacitance, rated voltage and other electrical characteristics before assembly.
5. Prior to use, confirm the solderability of capacitors that were in long-term storage.
6. Prior to measuring capacitance, carry out a heat treatment for capacitors that were in long-term storage.
7. The use of Sn-Zn based solder will deteriorate the reliability of the MLCC.  
Please contact our sales representative or product engineers on the use of Sn-Zn based solder in advance.

8. We have also produced a DVD which shows a summary of our recommendations, regarding the precautions for mounting. Please contact our sales representative to request the DVD.

### 3. Maintenance of the Mounting (pick and place) Machine

1. Make sure that the following excessive forces are not applied to the capacitors. Check the mounting in the actual device under actual use conditions ahead of time.
  - 1-1. In mounting the capacitors on the printed circuit board, any bending force against them shall be kept to a minimum to prevent them from any damage or cracking. Please take into account the following precautions and recommendations for use in your process.
    - (1) Adjust the lowest position of the pickup nozzle so as not to bend the printed circuit board.
2. Dirt particles and dust accumulated in the suction nozzle and suction mechanism prevent the nozzle from moving smoothly. This creates excessive force on the capacitor during mounting, causing cracked chips. Also, the locating claw, when worn out, imposes uneven forces on the chip when positioning, causing cracked chips. The suction nozzle and the locating claw must be maintained, checked, and replaced periodically.

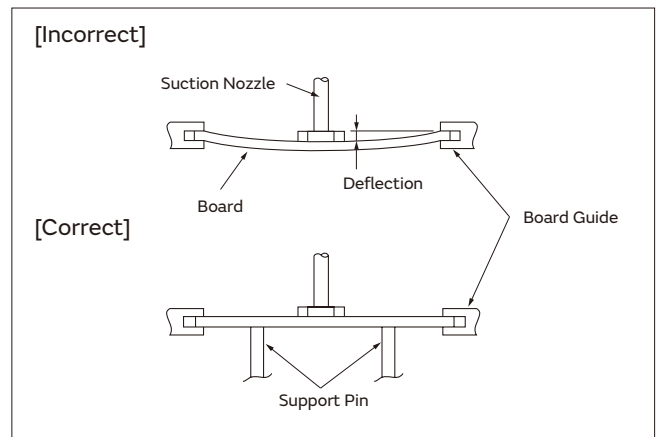

Continued on the following page. ↗

**⚠️Caution**

Continued from the preceding page. ↘

**4-1. Reflow Soldering**

- When sudden heat is applied to the components, the mechanical strength of the components will decrease because a sudden temperature change causes deformation inside the components. In order to prevent mechanical damage to the components, preheating is required for both the components and the PCB. Preheating conditions are shown in table 1. It is required to keep the temperature differential between the solder and the components surface ( $\Delta T$ ) as small as possible.
- When components are immersed in solvent after mounting, be sure to maintain the temperature difference ( $\Delta T$ ) between the component and the solvent within the range shown in table 1.

**Table 1**

| Series                      | Chip Dimension Code (L/W) | Temperature Differential          |
|-----------------------------|---------------------------|-----------------------------------|
| GRT/GCM/GC3/GCD/GCE/GCJ/NFM | 03/15/18/21/31            | $\Delta T \leq 190^\circ\text{C}$ |
| GRT/GCM/GCJ                 | 32/43/55                  | $\Delta T \leq 130^\circ\text{C}$ |
| KCM/KC3/KCA                 | 55                        |                                   |

**Recommended Conditions**

|                  | Pb-Sn Solder | Lead Free Solder      |
|------------------|--------------|-----------------------|
| Peak Temperature | 230 to 250°C | 240 to 260°C          |
| Atmosphere       | Air          | Air or N <sub>2</sub> |

Pb-Sn Solder: Sn-37Pb  
 Lead Free Solder: Sn-3.0Ag-0.5Cu

- When a capacitor is mounted at a temperature lower than the peak reflow temperature recommended by the solder manufacturer, the following quality problems can occur. Consider factors such as the placement of peripheral components and the reflow temperature setting to prevent the capacitor's reflow temperature from dropping below the peak temperature specified. Be sure to evaluate the mounting situation beforehand and verify that none of the following problems occur.

- Drop in solder wettability
- Solder voids
- Possible occurrence of whiskering
- Drop in bonding strength
- Drop in self-alignment properties
- Possible occurrence of tombstones and/or shifting on the land patterns of the circuit board

**4. Optimum Solder Amount for Reflow Soldering**

- Overly thick application of solder paste results in an excessive solder fillet height. This makes the chip more susceptible to mechanical and thermal stress on the board and may cause the chips to crack.

**Inverting the PCB**

Make sure not to impose any abnormal mechanical shocks to the PCB.

**[Example of Temperature Conditions for Reflow Soldering]**

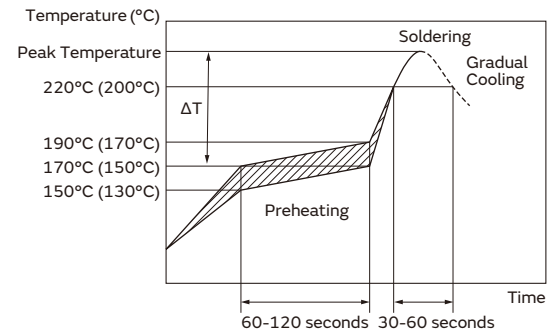

Temperature  
 Incase of Lead Free Solder  
 ( ): In case of Pb-Sn Solder

**[Allowable Reflow Soldering Temperature and Time]**

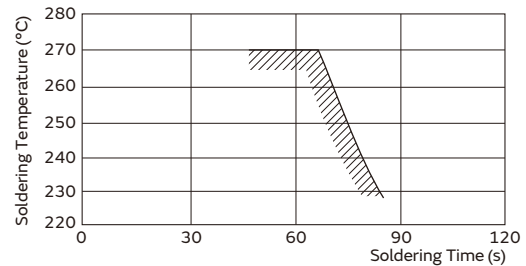

In the case of repeated soldering, the accumulated soldering time must be within the range shown above.

- Too little solder paste results in a lack of adhesive strength on the termination, which may result in chips breaking loose from the PCB.
- Please confirm that solder has been applied smoothly to the termination.

**<Applicable to NFM Series>**

**[Guideline of solder paste thickness]**

100-150μm: NFM21HC/31HK

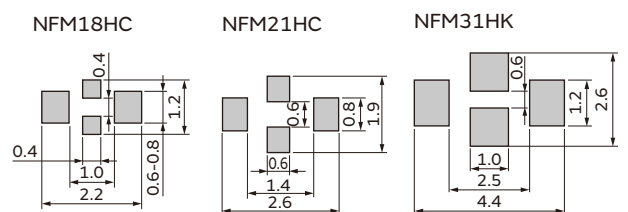

Continued on the following page. ↗

GRT Series  
 GCM Series  
 GC3 Series  
 GCJ Series  
 GCQ Series  
 GCD Series  
 GCE Series  
 NFM Series  
 KCM Series  
 KC3 Series  
 KCA Series  
 GCB Series  
 GCG Series  
 ⚠️Caution

**⚠️Caution**

Continued from the preceding page. ↘

**4-2. Flow Soldering**

1. Do not apply flow soldering to chips not listed in table 2.

**Table 2**

| Series  | Chip Dimension Code (L/W) | Temperature Differential          |
|---|---------------------------|-----------------------------------|
| <b>GRT/GCM/GC3/GCD</b> (Except for characteristics of X8L(L8), X8G(5G), CHA(0C), X8R(R9)) | <b>18/21/31</b>           | $\Delta T \leq 150^\circ\text{C}$ |
| <b>GCJ</b><br>(Rated Voltage 250VDC or more)  |                           |                                   |
| <b>NFM</b>  |                           |                                   |

- When sudden heat is applied to the components, the mechanical strength of the components will decrease because a sudden temperature change causes deformation inside the components. In order to prevent mechanical damage to the components, preheating is required for both of the components and the PCB. Preheating conditions are shown in table 2. It is required to keep the temperature differential between the solder and the components surface ( $\Delta T$ ) as low as possible.
- Excessively long soldering time or high soldering temperature can result in leaching of the terminations, causing poor adhesion or a reduction in capacitance value due to loss of contact between the inner electrodes and terminations.
- When components are immersed in solvent after mounting, be sure to maintain the temperature differential ( $\Delta T$ ) between the component and solvent within the range shown in the table 2.

**Recommended Conditions**

|                                    | Pb-Sn Solder | Lead Free Solder                   |
|------------------------------------|--------------|------------------------------------|
| <b>Preheating Peak Temperature</b> | 90 to 110°C  | 100 to 120°C<br>140 to 160°C (NFM) |
| <b>Soldering Peak Temperature</b>  | 240 to 250°C | 250 to 260°C                       |
| <b>Atmosphere</b>                  | Air          | Air or N <sub>2</sub>              |

Pb-Sn Solder: Sn-37Pb

Lead Free Solder: Sn-3.0Ag-0.5Cu

**5. Optimum Solder Amount for Flow Soldering**

5-1. The top of the solder fillet should be lower than the thickness of the components. If the solder amount is excessive, the risk of cracking is higher during board bending or any other stressful condition.

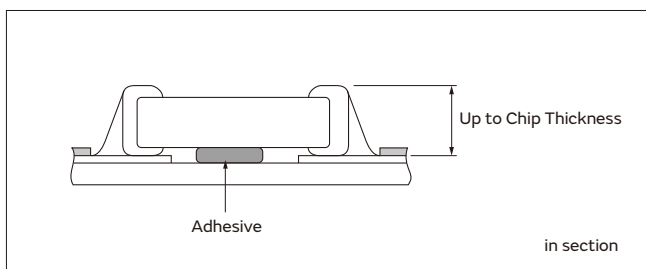

**[Example of Temperature Conditions for Flow Soldering]**

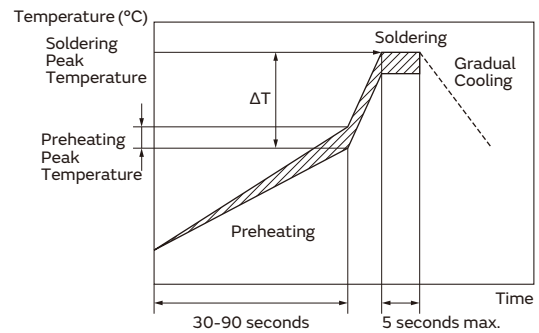

**[Allowable Flow Soldering Temperature and Time]**

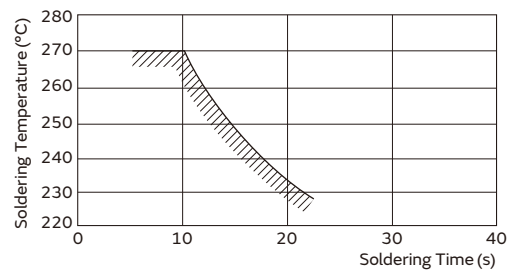

In the case of repeated soldering, the accumulated soldering time must be within the range shown above.

Continued on the following page. ↗

GRT Series  
 GCM Series  
 GC3 Series  
 GCJ Series  
 GCQ Series  
 GCD Series  
 GCE Series  
 NMF Series  
 KCM Series  
 KC3 Series  
 KCA Series  
 GCB Series  
 GCG Series  
 ⚠️Caution

**⚠Caution**

Continued from the preceding page. ↘

**4-3. Correction of Soldered Portion**

When sudden heat is applied to the capacitor, distortion caused by the large temperature difference occurs internally, and can be the cause of cracks. Capacitors also tend to be affected by mechanical and thermal stress depending on the board preheating temperature or the soldering fillet shape, and can be the cause of cracks. Please refer to "1. PCB Design" or "3. Optimum solder amount" for the solder amount and the fillet shapes.

**1. Correction with a Soldering Iron**

- 1-1. In order to reduce damage to the capacitor, be sure to preheat the capacitor and the mounting board. Preheat to the temperature range shown in Table 3. A hot plate, hot air type preheater, etc. can be used for preheating.

- 1-2. After soldering, do not allow the component/PCB to cool down rapidly.
- 1-3. Perform the corrections with a soldering iron as quickly as possible. If the soldering iron is applied too long, there is a possibility of causing solder leaching on the terminal electrodes, which will cause deterioration of the adhesive strength and other problems.

**Table 3**

| Series                  | Chip Dimension Code (L/W) | Temperature of Soldering Iron Tip | Preheating Temperature | Temperature Differential ( $\Delta T$ ) | Atmosphere |
|-------------------------|---------------------------|-----------------------------------|------------------------|---|------------|
| GRT/GCM/GC3/GCD/GCE/GCJ | 03/15/18/21/31            | 350°C max.                        | 150°C min.             | $\Delta T \leq 190^\circ\text{C}$       | Air        |
| GRT/GCM/GCJ             | 32/43/55                  | 280°C max.                        | 150°C min.             | $\Delta T \leq 130^\circ\text{C}$       | Air        |
| NFM                     | 21/31                     | 350°C max.                        | 150°C min.             | $\Delta T \leq 190^\circ\text{C}$       | Air        |

\*Applicable for both Pb-Sn and Lead Free Solder.  
 Pb-Sn Solder: Sn-37Pb  
 Lead Free Solder: Sn-3.0Ag-0.5Cu  
 \*Please manage  $\Delta T$  in the temperature of soldering iron and the preheating temperature.

**2. Correction with Spot Heater**

Compared to local heating with a soldering iron, hot air heating by a spot heater heats the overall component and board, therefore, it tends to lessen the thermal shock. In the case of a high density mounted board, a spot heater can also prevent concerns of the soldering iron making direct contact with the component.

- 2-1. If the distance from the hot air outlet of the spot heater to the component is too close, cracks may occur due to thermal shock. To prevent this problem, follow the conditions shown in Table 4.

**Table 4**

|                                   |   |
|-----------------------------------|---|
| Distance                          | 5mm or more   |
| Hot Air Application Angle         | 45° *Figure 1                                       |
| Hot Air Temperature Nozzle Outlet | 400°C max.  |
| Application Time                  | Less than 10 seconds (1206 (3216M) size or smaller) |
|                                   | Less than 30 seconds (1210 (3225M) size or larger)  |

- 2-2. In order to create an appropriate solder fillet shape, it is recommended that hot air be applied at the angle shown in Figure 1.

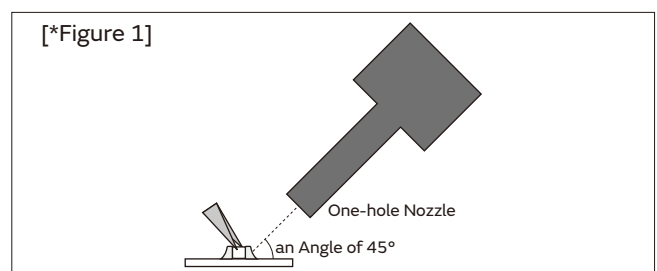

**3. Optimum solder amount when re-working with a soldering iron**

- 3-1. If the solder amount is excessive, the risk of cracking is higher during board bending or any other stressful condition. Too little solder amount results in a lack of adhesive strength on the outer electrode termination, which may result in chips breaking loose from the PCB. Please confirm that solder has been applied smoothly is and rising to the end surface of the chip.

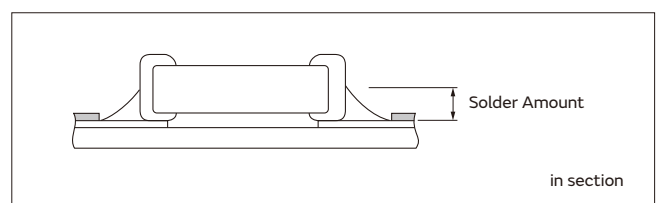

Continued on the following page. ↗

## ⚠Caution

Continued from the preceding page. ↘

- 3-2. A soldering iron with a tip of  $\varnothing 3\text{mm}$  or smaller should be used. It is also necessary to keep the soldering iron from touching the components during the re-work.
- 3-3. Solder wire with  $\varnothing 0.5\text{mm}$  or smaller is required for soldering.

### <Applicable to KCM/KC3/KCA Series>

4. For the shape of the soldering iron tip, refer to the figure on the right.

Regarding the type of solder, use a wire diameter of  $\varnothing 0.5\text{mm}$  or less (rosin core wire solder).

#### 4-1. How to Apply the Soldering Iron

Apply the tip of the soldering iron against the lower end of the metal terminal.

- 1) In order to prevent cracking caused by sudden heating of the ceramic device, do not touch the ceramic base directly.
- 2) In order to prevent deviations and dislocating of the chip, do not touch the junction of the chip and the metal terminal, and the metal portion on the outside directly.

#### 4-2. Appropriate Amount of Solder

The amount of solder for corrections by soldering iron, should be lower than the height of the lower side of the chip.

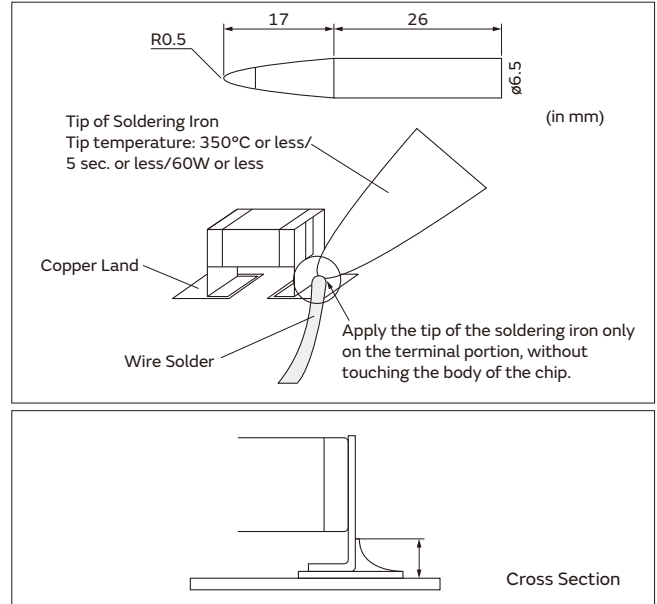

## 5. Washing

Excessive ultrasonic oscillation during cleaning can cause the PCBs to resonate, resulting in cracked chips or broken solder joints. Before starting your production process, test your cleaning equipment/process to insure it does not degrade the capacitors.

## 6. Electrical Test on Printed Circuit Board

1. Confirm position of the support pin or specific jig, when inspecting the electrical performance of a capacitor after mounting on the printed circuit board.

1-1. Avoid bending the printed circuit board by the pressure of a test-probe, etc.

The thrusting force of the test probe can flex the PCB, resulting in cracked chips or open solder joints. Provide support pins on the back side of the PCB to prevent warping or flexing. Install support pins as close to the test-probe as possible.

1-2. Avoid vibration of the board by shock when a test-probe contacts a printed circuit board.

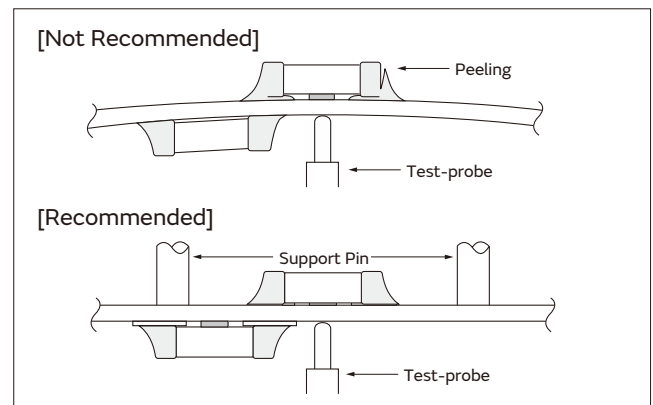

## 7. Printed Circuit Board Cropping

1. After mounting a capacitor on a printed circuit board, do not apply any stress to the capacitor that causes bending or twisting the board.

- 1-1. In cropping the board, the stress as shown at right may cause the capacitor to crack. Avoid this type of stress to a capacitor.

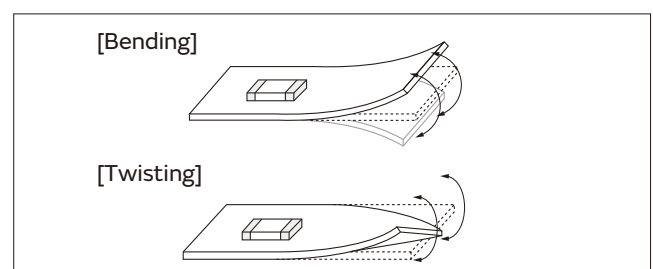

Continued on the following page. ↗

**△Caution**

Continued from the preceding page. ↘

2. Check the cropping method for the printed circuit board in advance.

2-1. Printed circuit board cropping shall be carried out by using a jig or an apparatus (Disc separator, router type separator, etc.) to prevent the mechanical stress that can occur to the board.

| Board Separation Method  | Hand Separation<br>Nipper Separation   | (1) Board Separation Jig  | Board Separation Apparatus   |                           |
|--------------------------|--|---|--|---------------------------|
|                          |  |   | (2) Disc Separator   | (3) Router Type Separator |
| Level of stress on board | High   | Medium  | Medium   | Low                       |
| Recommended              | ×  | △*  | △*   | ○                         |
| Notes                    | Hand and nipper separation apply a high level of stress. Use another method. | <ul style="list-style-type: none"> <li>Board handling</li> <li>Board bending direction</li> <li>Layout of capacitors</li> </ul> | <ul style="list-style-type: none"> <li>Board handling</li> <li>Layout of slits</li> <li>Design of V groove</li> <li>Arrangement of blades</li> <li>Controlling blade life</li> </ul> | Board handling            |

\* When a board separation jig or disc separator is used, if the following precautions are not observed, a large board deflection stress will occur and the capacitors may crack. Use router type separator if at all possible.

(1) Example of a suitable jig

[In the case of Single-side Mounting]

An outline of the board separation jig is shown as follows. Recommended example: Stress on the component mounting position can be minimized by holding the portion close to the jig, and bend in the direction towards the side where the capacitors are mounted. Not recommended example: The risk of cracks occurring in the capacitors increases due to large stress being applied to the component mounting position, if the portion away from the jig is held and bent in the direction opposite the side where the capacitors are mounted.

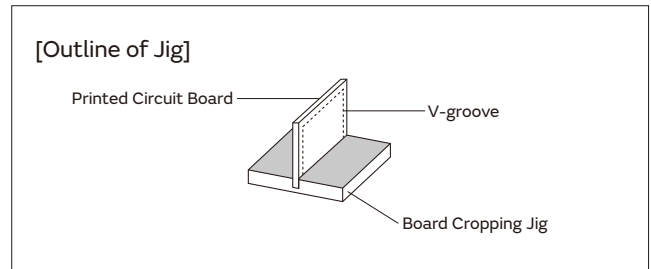

**Hand Separation**

| Recommended | Not Recommended |
|-------------|-----------------|
|             |                 |

[In the case of Double-sided Mounting]

Since components are mounted on both sides of the board, the risk of cracks occurring can not be avoided with the above method. Therefore, implement the following measures to prevent stress from being applied to the components.

(Measures)

- (1) Consider introducing a router type separator. If it is difficult to introduce a router type separator, implement the following measures. (Refer to item 1. Mounting Position)
- (2) Mount the components parallel to the board separation surface.
- (3) When mounting components near the board separation point, add slits in the separation position near the component.
- (4) Keep the mounting position of the components away from the board separation point.

Continued on the following page. ↗

**⚠Caution**

Continued from the preceding page. ↘

(2) Example of a Disc Separator

An outline of a disc separator is shown as follows. As shown in the Principle of Operation, the top blade and bottom blade are aligned with the V-grooves on the printed circuit board to separate the board.

In the following case, board deflection stress will be applied and cause cracks in the capacitors.

- (1) When the adjustment of the top and bottom blades are misaligned, such as deviating in the top-bottom, left-right or front-rear directions
- (2) The angle of the V groove is too low, depth of the V groove is too shallow, or the V groove is misaligned top-bottom

IF V groove is too deep, it is possible to brake when you handle and carry it. Carefully design depth of the V groove with consideration about strength of material of the printed circuit board.

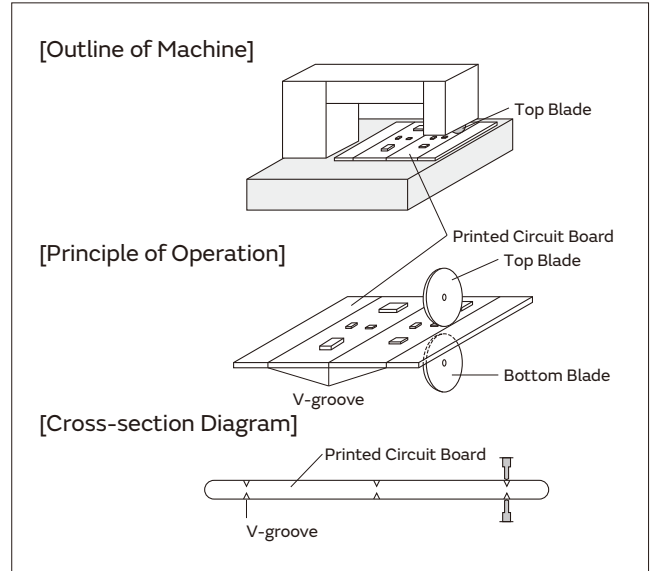

**Disc Separator**

| Recommended                          | Not Recommended                      |                                      |                                      |
|--------------------------------------|--------------------------------------|--------------------------------------|--------------------------------------|
|                                      | Top-bottom Misalignment              | Left-right Misalignment              | Front-rear Misalignment              |
| <p>Top Blade</p> <p>Bottom Blade</p> | <p>Top Blade</p> <p>Bottom Blade</p> | <p>Top Blade</p> <p>Bottom Blade</p> | <p>Top Blade</p> <p>Bottom Blade</p> |

**V-groove Design**

| Example of Recommended V-groove Design | Not Recommended         |           |                   |                |
|--|-------------------------|-----------|-------------------|----------------|
|  | Left-right Misalignment | Low-Angle | Depth too Shallow | Depth too Deep |
|  |                         |           |                   |                |

(3) Example of Router Type Separator

The router type separator performs cutting by a router rotating at a high speed. Since the board does not bend in the cutting process, stress on the board can be suppressed during board separation.

When attaching or removing boards to/from the router type separator, carefully handle the boards to prevent bending.

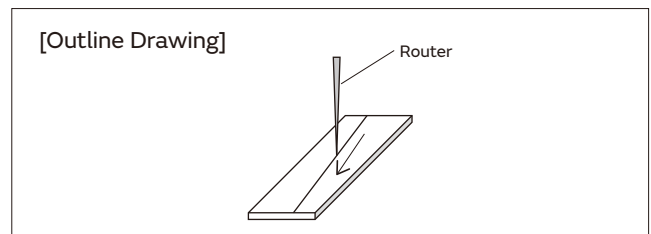

Continued on the following page. ↗

GRT Series  
 GCM Series  
 GC3 Series  
 GCJ Series  
 GCQ Series  
 GCD Series  
 GCE Series  
 NMF Series  
 KCM Series  
 KC3 Series  
 KCA Series  
 GCB Series  
 GCG Series  
 ⚠Caution



## ⚠Caution

Continued from the preceding page. ↘

### 8. Assembly

#### 1. Handling

If a board mounted with capacitors is held with one hand, the board may bend. Firmly hold the edges of the board with both hands when handling.

If a board mounted with capacitors is dropped, cracks may occur in the capacitors.

Do not use dropped boards, as there is a possibility that the quality of the capacitors may be impaired.

#### 2. Attachment of Other Components

##### 2-1. Mounting of Other Components

Pay attention to the following items, when mounting other components on the back side of the board after capacitors have been mounted on the opposite side. When the bottom dead point of the suction nozzle is set too low, board deflection stress may be applied to the capacitors on the back side (bottom side), and cracks may occur in the capacitors.

- After the board is straightened, set the bottom dead point of the nozzle on the upper surface of the board.

- Periodically check and adjust the bottom dead point.

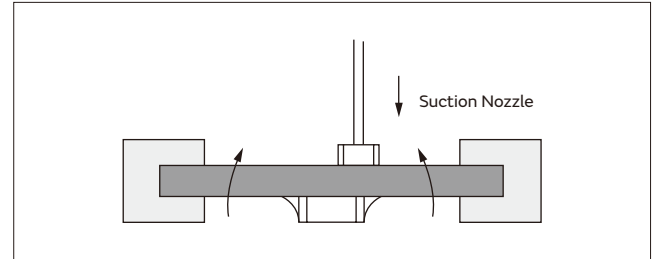

##### 2-2. Inserting Components with Leads into Boards

When inserting components (transformers, IC, etc.) into boards, bending the board may cause cracks in the capacitors or cracks in the solder.

Pay attention to the following.

- Increase the size of the holes to insert the leads, to reduce the stress on the board during insertion.

- Fix the board with support pins or a dedicated jig before insertion.

- Support below the board so that the board does not bend. When using support pins on the board, periodically confirm that there is no difference in the height of each support pin.

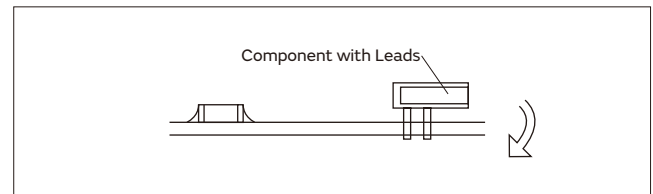

##### 2-3. Attaching/Removing Sockets and/or Connectors

Insertion and removal of sockets and connectors, etc., might cause the board to bend. Please insure that the board does not warp during insertion and removal of sockets and connectors, etc., or the bending may damage mounted components on the board.

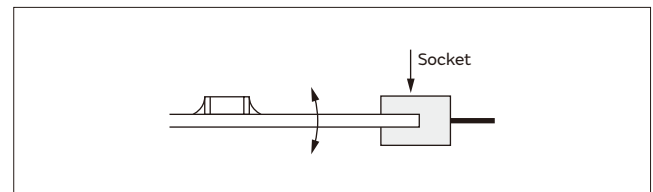

##### 2-4. Tightening Screws

The board may be bent, when tightening screws, etc. during the attachment of the board to a shield or chassis.

Pay attention to the following items before performing the work.

- Plan the work to prevent the board from bending.

- Use a torque screwdriver, to prevent over-tightening of the screws.

- The board may bend after mounting by reflow soldering, etc. Please note, as stress may be applied to the chips by forcibly flattening the board when tightening the screws.

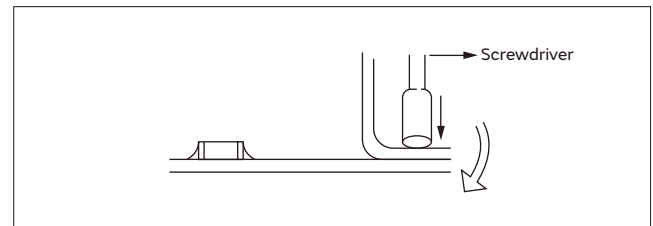

Continued on the following page. ↗

GRT Series

GCM Series

GC3 Series

GCJ Series

GCQ Series

GCD Series

GCE Series

NMF Series

KCM Series

KC3 Series

KCA Series

GCB Series

GCG Series

⚠Caution



**⚠Caution**

Continued from the preceding page. ↘

<Applicable to GCG Series>

**9. Selection of Conductive Adhesive, Mounting Process, and Bonding Strength**

The acquired bonding strength may change greatly depending on the conductive adhesive to be used. Be sure to confirm if the desired performance can be acquired in the assumed mounting process with the conductive adhesive to be used.

**Other**

**1. Under Operation of Equipment**

- 1-1. Do not touch a capacitor directly with bare hands during operation in order to avoid the danger of an electric shock.
- 1-2. Do not allow the terminals of a capacitor to come in contact with any conductive objects (short-circuit). Do not expose a capacitor to a conductive liquid, including any acid or alkali solutions.
- 1-3. Confirm the environment in which the equipment will operate is under the specified conditions. Do not use the equipment under the following environments.
  - (1) Being splattered with water or oil.
  - (2) Being exposed to direct sunlight.
  - (3) Being exposed to ozone, ultraviolet rays, or radiation.
  - (4) Being exposed to toxic gas (e.g., hydrogen sulfide, sulfur dioxide, chlorine, ammonia gas, etc.)
  - (5) Any vibrations or mechanical shocks exceeding the specified limits.
  - (6) Moisture condensing environments.
- 1-4. Use damp proof countermeasures if using under any conditions that can cause condensation.

**2. Other**

- 2-1. In an Emergency
  - (1) If the equipment should generate smoke, fire, or smell, immediately turn off or unplug the equipment. If the equipment is not turned off or unplugged, the hazards may be worsened by supplying continuous power.
  - (2) In this type of situation, do not allow face and hands to come in contact with the capacitor or burns may be caused by the capacitor's high temperature.
- 2-2. Disposal of Waste
 

When capacitors are disposed of, they must be burned or buried by an industrial waste vendor with the appropriate licenses.
- 2-3. Circuit Design
  - (1) Addition of Fail Safe Function
 

Capacitors that are cracked by dropping or bending of the board may cause deterioration of the insulation resistance, and result in a short.

**10. Moisture Proof Process**

In order to prevent the occurrence of migration, perform a moisture proof process, such as applying a resin coating or enclosing with a dry inert gas.

**11. Application**

This product is limited to conductive glue mounting. When performing solder mounting, contact Murata in advance.

If the circuit being used may cause an electrical shock, smoke or fire when a capacitor is shorted, be sure to install fail-safe functions, such as a fuse, to prevent secondary accidents.

- (2) Capacitors used to prevent electromagnetic interference in the primary AC side circuit, or as a connection/insulation, must be a safety standard certified product, or satisfy the contents stipulated in the Electrical Appliance and Material Safety Law. Install a fuse for each line in case of a short.
- (3) The GC3, GCD, GCE, GCG, GCJ, GCM, KC3, KCM, and NFM series are not safety standard certified products.

**2-4. Test Condition for AC Withstanding Voltage**

- (1) Test Equipment
 

Test equipment for AC withstanding voltage should be made with equipment capable of creating a wave similar to a 50/60Hz sine wave.
- (2) Voltage Applied Method
 

The capacitor's lead or terminal should be firmly connected to the output of the withstanding voltage test equipment, and then the voltage should be raised from near zero to the test voltage.

If the test voltage is applied directly to the capacitor without raising it from near zero, it should be applied with the zero cross. \*At the end of the test time, the test voltage should be reduced to near zero, and then capacitor's lead or terminals should be taken off the output of the withstanding voltage test equipment. If the test voltage applied directly to the capacitor without raising it from near zero, surge voltage may occur and cause a defect.

\*ZERO CROSS is the point where voltage sine wave passes 0V. - See the figure at right -

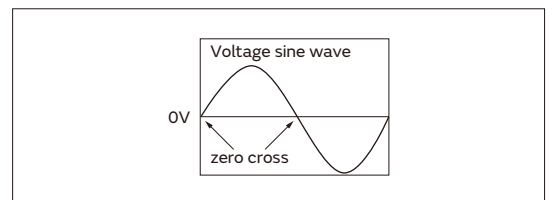

Continued on the following page. ↗

## Notice

Continued from the preceding page. ↘

### 2-5. Remarks

Failure to follow the cautions may result, worst case, in a short circuit and smoking when the product is used.

The above notices are for standard applications and conditions. Contact us when the products are used in special mounting conditions.

Select optimum conditions for operation as they determine the reliability of the product after assembly.

The data herein are given in typical values, not guaranteed ratings.

## Rating

### 1. Operating Temperature

1. The operating temperature limit depends on the capacitor.

1-1. Do not apply temperatures exceeding the upper operating temperature.

It is necessary to select a capacitor with a suitable rated temperature that will cover the operating temperature range.

It is also necessary to consider the temperature distribution in equipment and the seasonal temperature variable factor.

1-2. Consider the self-heating factor of the capacitor.

The surface temperature of the capacitor shall not exceed the maximum operating temperature including self-heating.

### 2. Atmosphere Surroundings (gaseous and liquid)

1. Restriction on the operating environment of capacitors.

1-1. Capacitors, when used in the above, unsuitable, operating environments may deteriorate due to the corrosion of the terminations and the penetration of moisture into the capacitor.

1-2. The same phenomenon as the above may occur when the electrodes or terminals of the capacitor are subject to moisture condensation.

1-3. The deterioration of characteristics and insulation resistance due to the oxidization or corrosion of terminal electrodes may result in breakdown when the capacitor is exposed to corrosive or volatile gases or solvents for long periods of time.

### 3. Piezo-electric Phenomenon

1. When using high dielectric constant type capacitors in AC or pulse circuits, the capacitor itself vibrates at specific frequencies and noise may be generated.

Moreover, when the mechanical vibration or shock is added to the capacitor, noise may occur.

## Soldering and Mounting

### 1. PCB Design

1. Notice for Pattern Forms

1-1. Unlike leaded components, chip components are susceptible to flexing stresses since they are mounted directly on the substrate.

They are also more sensitive to mechanical and thermal stresses than leaded components.

Excess solder fillet height can multiply these stresses and cause chip cracking. When designing substrates, take land patterns and dimensions into consideration to eliminate the possibility of excess solder fillet height.

1-2. There is a possibility of chip cracking caused by PCB expansion/contraction with heat, because stress on a chip is different depending on PCB material and structure. When the thermal expansion coefficient greatly differs between the board used for mounting and the chip, it will cause cracking of the chip due to the thermal expansion and contraction. When capacitors are mounted on a fluorine resin printed circuit board or on a single-layered glass epoxy board, it may also cause cracking of the chip for the same reason.

1-3. If you are replacing by smaller capacitors, you should not only consider the Land size change but also consider changing the Wiring Width, Wiring direction, and copper foil thickness because the risk of chip cracking is increased with just a Land size change.

#### <Applicable to NFM Series>

1-4. Because noise is suppressed by shunting unwanted high-frequency components to the ground, when designing a land for the NFM series, design the ground pattern to be as large as possible in order to better bring out this characteristic.



As shown in the figure below, noise countermeasures can be made more effective by using a via to connect the ground pattern on the chip mounting surface to a larger ground pattern on the inner layer.

Continued on the following page. ↗

## Notice

Continued from the preceding page. ↘

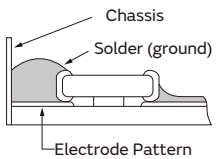
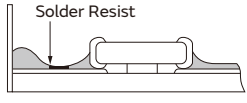
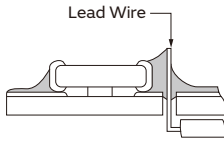
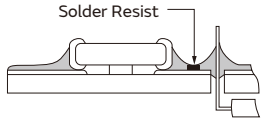
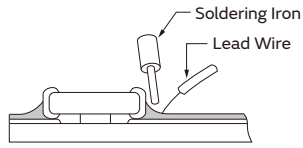
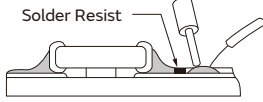
### Pattern Forms

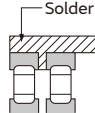
|   | Prohibited   | Correct  |
|---|--|--|
| Placing Close to Chassis                          |  <p>Chassis<br/>Solder (ground)<br/>Electrode Pattern</p> <p>in section</p> |  <p>Solder Resist</p> <p>in section</p> |
| Placing of Chip Components and Leaded Components  |  <p>Lead Wire</p> <p>in section</p>   |  <p>Solder Resist</p> <p>in section</p> |
| Placing of Leaded Components after Chip Component |  <p>Soldering Iron<br/>Lead Wire</p> <p>in section</p>                      |  <p>Solder Resist</p> <p>in section</p> |
| Lateral Mounting                                  |   |  <p>Solder Resist</p>                   |

## 2. Land Dimensions

- 2-1. Please refer to the land dimensions in table 1 for flow soldering, table 2 for reflow soldering.  
 Please confirm the suitable land dimension by evaluating of the actual SET / PCB.

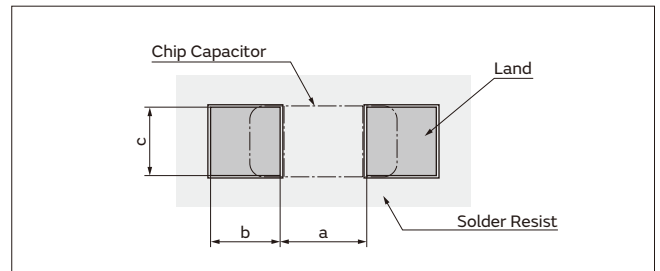

**Table 1 Flow Soldering Method**

| Series  | Chip Dimension Code (L/W) | Chip (L×W) | a          | b          | c          |
|---|---------------------------|------------|------------|------------|------------|
| GRT/GCM/GC3/GCD/GCJ<br>(Rated Voltage: above<br>250VDC (for GCJ alone)) | 18                        | 1.6×0.8    | 0.6 to 1.0 | 0.8 to 0.9 | 0.6 to 0.8 |
|   | 21                        | 2.0×1.25   | 1.0 to 1.2 | 0.9 to 1.0 | 0.8 to 1.1 |
|   | 31                        | 3.2×1.6    | 2.2 to 2.6 | 1.0 to 1.1 | 1.0 to 1.4 |

Flow soldering can only be used for products with a chip size from 1.6×0.8mm to 3.2×1.6mm.

(in mm)

**Table 2 Reflow Soldering Method**

| Series                      | Chip Dimension Code (L/W) | Chip (L×W)              | a          | b            | c          |
|-----------------------------|---------------------------|-------------------------|------------|--------------|------------|
| GRT/GCM/GC3/<br>GCD/GCE/GCJ | 03                        | 0.6×0.3                 | 0.2 to 0.3 | 0.2 to 0.35  | 0.2 to 0.4 |
|                             | 15                        | 1.0×0.5 (within ±0.10)  | 0.3 to 0.5 | 0.35 to 0.45 | 0.4 to 0.6 |
|                             |                           | 1.0×0.5 (±0.15/±0.20)   | 0.4 to 0.6 | 0.4 to 0.5   | 0.5 to 0.7 |
|                             | 18                        | 1.6×0.8 (within ±0.10)  | 0.6 to 0.8 | 0.6 to 0.7   | 0.6 to 0.8 |
|                             |                           | 1.6×0.8 (±0.15/±0.20)   | 0.7 to 0.9 | 0.7 to 0.8   | 0.8 to 1.0 |
|                             | 21                        | 2.0×1.25 (within ±0.10) | 1.2        | 0.6          | 1.25       |
|                             |                           | 2.0×1.25 (±0.15)        | 1.2        | 0.6 to 0.8   | 1.2 to 1.4 |
|                             |                           | 2.0×1.25 (±0.20)        | 1.0 to 1.4 | 0.6 to 0.8   | 1.2 to 1.4 |
|                             | 31                        | 3.2×1.6 (within ±0.20)  | 1.8 to 2.0 | 0.9 to 1.2   | 1.5 to 1.7 |
|                             |                           | 3.2×1.6 (±0.30)         | 1.9 to 2.1 | 1.0 to 1.3   | 1.7 to 1.9 |
|                             | 32                        | 3.2×2.5                 | 2.0 to 2.4 | 1.0 to 1.2   | 1.8 to 2.3 |
|                             | 43                        | 4.5×3.2                 | 3.0 to 3.5 | 1.2 to 1.4   | 2.3 to 3.0 |
|                             | 55                        | 5.7×5.0                 | 4.0 to 4.6 | 1.4 to 1.6   | 3.5 to 4.8 |

(in mm)

Continued on the following page. ↗

## Notice

Continued from the preceding page. ↘

### <Applicable to Part Number KCM/KC3/KCA>

| Series              | Chip Dimension Code (L×W) | Body Size (L×W) | a          | b          | c          |
|---------------------|---------------------------|-----------------|------------|------------|------------|
| KCM/KC3 (Except 5C) | 55                        | 6.1×5.3         | 2.6 to 3.2 | 2.4 to 2.7 | 5.5 to 5.6 |
| KCM (5C only)       | 55                        | 6.1×5.1         | 3.2 to 4.0 | 2.0 to 2.4 | 5.5 to 5.7 |
| KCA                 | 55                        | 6.1×5.1         | 3.2 to 4.0 | 2.0 to 2.4 | 5.5 to 5.7 |

(in mm)

### <Applicable to beyond Rated Voltage of 200VDC>

#### 2-2. Dimensions of Slit (Example)

Preparing the slit helps flux cleaning and resin coating on the back of the capacitor.

However, the length of the slit design should be as short as possible to prevent mechanical damage in the capacitor.

A longer slit design might receive more severe mechanical stress from the PCB.

Recommended slit design is shown in the Table.

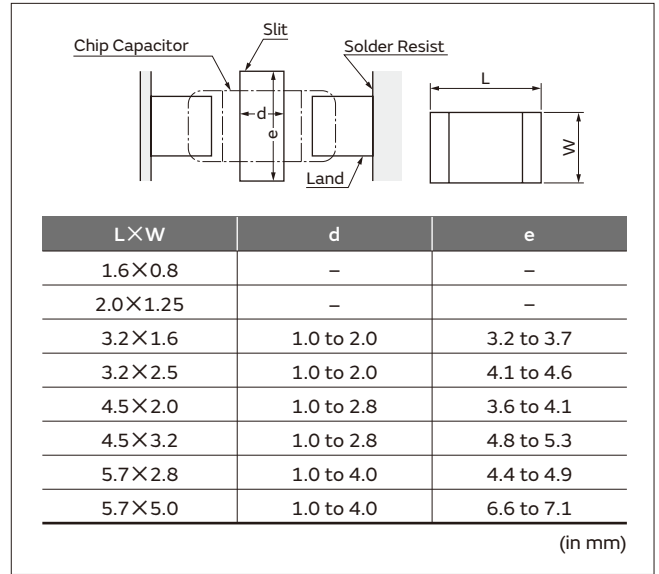

### <Applicable to NFM Series>

Legend: Land Pattern + Solder Resist, Land Pattern, Solder Resist (in mm)

| Series  | Land Dimensions  |  |
|---------|--|--|
| NFM21HC | <p>● Reflow Soldering</p> <p>NFM18HC<br/>Small diameter thru hole <math>\phi 0.2\text{-}\phi 0.3</math></p>  | <p>NFM21HC<br/>Small diameter thru hole <math>\phi 0.4</math></p>  |
|         | <p>● Reflow Soldering Chip mounting side</p> <p>NFM31HK*1<br/>Small diameter thru hole <math>\phi 0.4</math></p> <p>10mm or more (in case of 10A)</p> <p>*1 For large current design, width of signal land pattern should be wider not less than 1mm per 1A (1mm/A). For example, in case of 10A, signal land pattern width should be 10mm or more. (1mm/A*10A=10mm)</p> | <p>● Flow Soldering Chip mounting side</p> <p>NFM31HK*1<br/>Small diameter thru hole <math>\phi 0.4</math></p> <p>10mm or more (in case of 10A)</p> <p>*1 For large current design, width of signal land pattern should be wider not less than 1mm per 1A (1mm/A). For example, in case of 10A, signal land pattern width should be 10mm or more. (1mm/A*10A=10mm)</p> |

Continued on the following page. ↗

## Notice

Continued from the preceding page. ↘

### 3. Board Design

When designing the board, keep in mind that the amount of strain which occurs will increase depending on the size and material of the board.

[Relationship with amount of strain to the board thickness, length, width, etc.]

$$\epsilon = \frac{3PL}{2Ewh^2} \quad \text{Relationship between load and strain}$$

$\epsilon$ : Strain on center of board ( $\mu\text{st}$ )  
 $L$ : Distance between supporting points (mm)  
 $w$ : Board width (mm)  
 $h$ : Board thickness (mm)  
 $E$ : Elastic modulus of board ( $\text{N}/\text{m}^2=\text{Pa}$ )  
 $Y$ : Deflection (mm)  
 $P$ : Load (N)

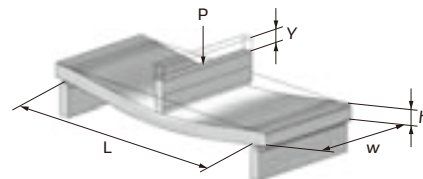

When the load is constant, the following relationship can be established.

- As the distance between the supporting points ( $L$ ) increases, the amount of strain also increases.  
→Reduce the distance between the supporting points.
  - As the elastic modulus ( $E$ ) decreases, the amount of strain increases.  
→Increase the elastic modulus.
  - As the board width ( $w$ ) decreases, the amount of strain increases.  
→Increase the width of the board.
  - As the board thickness ( $h$ ) decreases, the amount of strain increases.  
→Increase the thickness of the board.
- Since the board thickness is squared, the effect on the amount of strain becomes even greater.

## 2. Item to be confirmed for Flow soldering

If you want to temporarily attach the capacitor to the board using an adhesive agent before soldering the capacitor, first be sure that the conditions are appropriate for affixing the capacitor. If the dimensions of the land, the type of adhesive, the amount of coating, the contact surface area, the curing temperature, or other conditions are inappropriate, the characteristics of the capacitor may deteriorate.

### 1. Selection of Adhesive

1-1. Depending on the type of adhesive, there may be a decrease in insulation resistance. In addition, there is a chance that the capacitor might crack from contractile stress due to the difference in the contraction rate of the capacitor and the adhesive.

1-2. If there is not enough adhesive, the contact surface area is too small, or the curing temperature or curing time are inadequate, the adhesive strength will be insufficient and the capacitor may loosen or become disconnected during transportation or soldering. If there is too much adhesive, for example if it overflows onto the land, the result could be soldering defects, loss of electrical connection, insufficient curing, or slippage after the capacitor is mounted.

Furthermore, if the curing temperature is too high or the curing time is too long, not only will the adhesive

strength be reduced, but solderability may also suffer due to the effects of oxidation on the terminations (outer electrodes) of the capacitor and the land surface on the board.

#### (1) Selection of Adhesive

Epoxy resins are a typical class of adhesive.

To select the proper adhesive, consider the following points.

- 1) There must be enough adhesive strength to prevent the component from loosening or slipping during the mounting process.
- 2) The adhesive strength must not decrease when exposed to moisture during soldering.
- 3) The adhesive must have good coatability and shape retention properties.
- 4) The adhesive must have a long pot life.
- 5) The curing time must be short.
- 6) The adhesive must not be corrosive to the exterior of the capacitor or the board.
- 7) The adhesive must have good insulation properties.
- 8) The adhesive must not emit toxic gases or otherwise be harmful to health.
- 9) The adhesive must be free of halogenated compounds.

Continued on the following page. ↗

## Notice

Continued from the preceding page. ↘

(2) Use the following illustration as a guide to the amount of adhesive to apply.

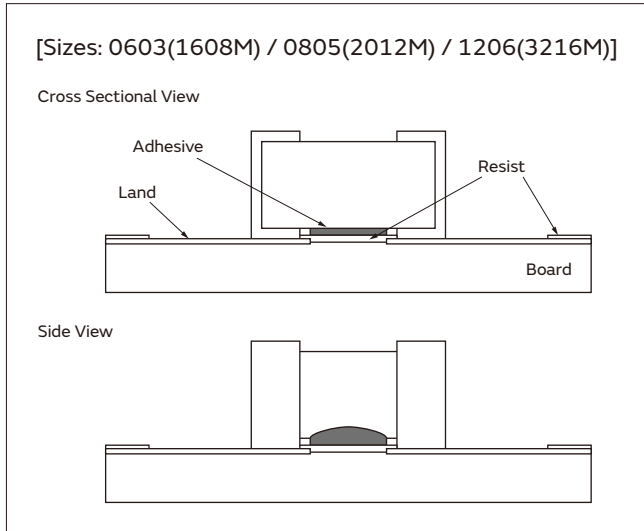

<Applicable to NFM Series>

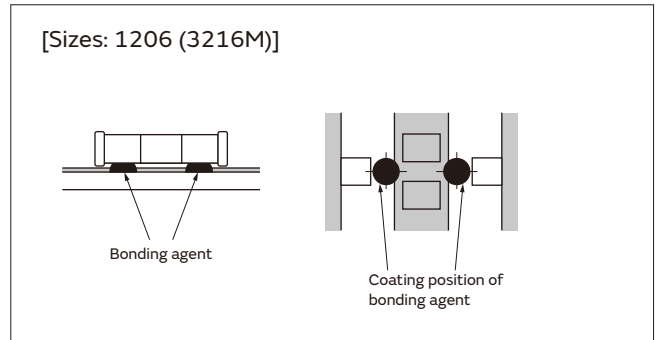

### 2. Flux

- 2-1. An excessive amount of flux generates a large quantity of flux gas, which can cause a deterioration of solderability, so apply flux thinly and evenly throughout. (A foaming system is generally used for flow soldering.)
- 2-2. Flux containing too high a percentage of halide may cause corrosion of the terminations unless there is sufficient cleaning. Use flux with a halide content of 0.1% max.
- 2-3. Strong acidic flux can corrode the capacitor and degrade its performance.

Please check the quality of capacitor after mounting.

### 3. Leaching of the terminations

- Set temperature and time to ensure that leaching of the termination does not exceed 25% of the chip end area as a single chip (full length of the edge A-B-C-D shown at right) and 25% of the length A-B shown as mounted on substrate.

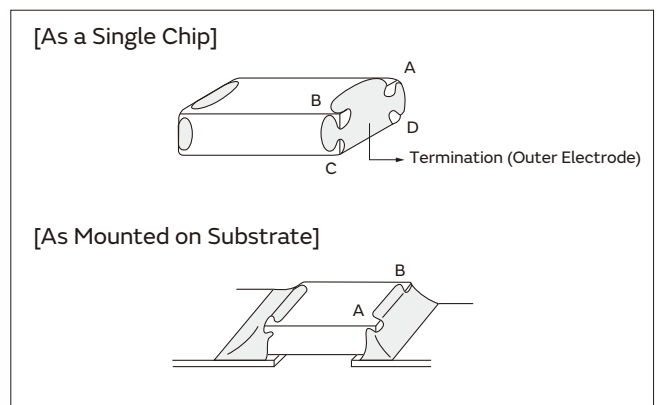

### 3. Reflow Soldering

The flux in the solder paste contains halogen-based substances and organic acids as activators. Strong acidic flux can corrode the capacitor and degrade its performance. Please check the quality of capacitor after mounting.

Continued on the following page. ↗

GRT Series  
 GCM Series  
 GC3 Series  
 GCJ Series  
 GCQ Series  
 GCD Series  
 GCE Series  
 NFM Series  
 KCM Series  
 KC3 Series  
 KCA Series  
 GCB Series  
 GCG Series  
 Notice

## Notice

Continued from the preceding page. ↘

### 4. Washing

1. Please evaluate the capacitor using actual cleaning equipment and conditions to confirm the quality, and select the solvent for cleaning.

### 5. Coating

1. A crack may be caused in the capacitor due to the stress of the thermal contraction of the resin during curing process.  
The stress is affected by the amount of resin and curing contraction.  
Select a resin with low curing contraction.  
The difference in the thermal expansion coefficient between a coating resin or a molding resin and the capacitor may cause the destruction and deterioration of the capacitor such as a crack or peeling, and lead to the deterioration of insulation resistance or dielectric breakdown.  
Select a resin for which the thermal expansion coefficient is as close to that of the capacitor as possible.  
A silicone resin can be used as an under-coating to buffer against the stress.

2. Unsuitable cleaning may leave residual flux or other foreign substances, causing deterioration of electrical characteristics and the reliability of the capacitors.

2. Select a resin that is less hygroscopic.  
Using hygroscopic resins under high humidity conditions may cause the deterioration of the insulation resistance of a capacitor.  
An epoxy resin can be used as a less hygroscopic resin.
3. The halogen system substance and organic acid are included in coating material, and a chip corrodes by the kind of Coating material.  
Do not use strong acid type.

## Other

### 1. Transportation

1. The performance of a capacitor may be affected by the conditions during transportation.
  - 1-1. The capacitors shall be protected against excessive temperature, humidity, and mechanical force during transportation.
    - Mechanical condition  
Transportation shall be done in such a way that the boxes are not deformed and forces are not directly passed on to the inner packaging.
  - 1-2. Do not apply excessive vibration, shock, or pressure to the capacitor.
    - (1) When excessive mechanical shock or pressure is applied to a capacitor, chipping or cracking may occur in the ceramic body of the capacitor.
    - (2) When the sharp edge of an air driver, a soldering iron, tweezers, a chassis, etc. impacts strongly on the surface of the capacitor, the capacitor may crack and short-circuit.
  - 1-3. Do not use a capacitor to which excessive shock was applied by dropping, etc.  
A capacitor dropped accidentally during processing may be damaged.

### 2. Characteristics Evaluation in the Actual System

1. Evaluate the capacitor in the actual system, to confirm that there is no problem with the performance and specification values in a finished product before using.
2. Since a voltage dependency and temperature dependency exists in the capacitance of high dielectric type ceramic capacitors, the capacitance may change depending on the operating conditions in the actual system. Therefore, be sure to evaluate the various characteristics, such as the leakage current and noise absorptivity, which will affect the capacitance value of the capacitor.
3. In addition, voltages exceeding the predetermined surge may be applied to the capacitor by the inductance in the actual system. Evaluate the surge resistance in the actual system as required.

#### <Applicable to NFM Series>

4. The effects of noise suppression can vary depending on the usage conditions, including differences in the circuit or IC to be used, the type of noise, the shape of the pattern to be mounted, and the mounting location. Be sure to verify the effect on the actual device in advance.

GRT Series

GCM Series

GC3 Series

GCJ Series

GCQ Series

GCD Series

GCE Series

NFM Series

KCM Series

KC3 Series

KCA Series

GCB Series

GCG Series

Notice



# Design Support Tool "SimSurfing"

<https://ds.murata.co.jp/simsurfing/index.html>

This is the latest tool to get the electrical characteristics for Capacitors, Inductors, and EMI Suppression Filters, and to simulate Thermistors' behavior !

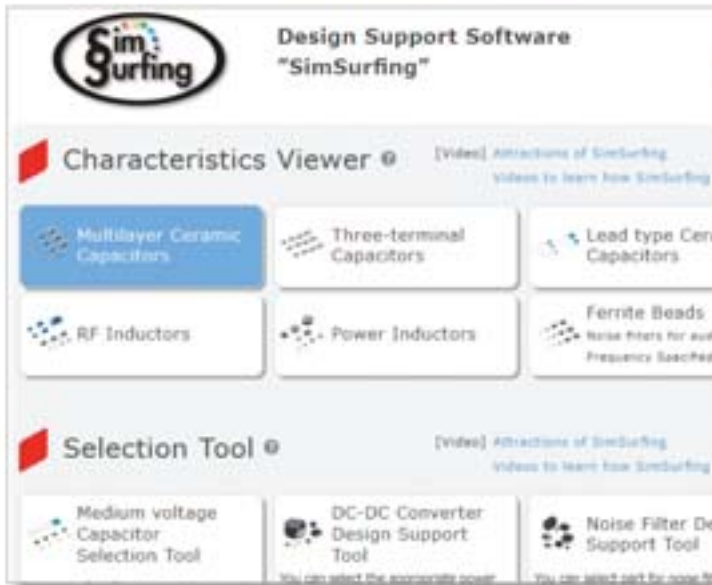

### ■ Characteristics viewer

You can easily search and download the following data for Multilayer Ceramic Capacitors, Polymer Capacitors, EMI Suppression Filters (Three-terminal Capacitors, Ferrite Beads) and Power/RF Inductors.

### ■ Components performance simulator

You can search by the simulation on simple circuits for Thermistors.

### ■ Selection tool

You can select Medium voltage Capacitors and Power Inductors according to conditions of use.

\* Medium voltage: Rated Voltage 250V and over

### ■ Search tool

You can search the Murata timing device (CERALOCK® and crystal units) that is most suitable for your IC and access information about the recommended circuit constant setting.

## ■ Usage example of "Multilayer Ceramic Capacitors"

### 1 Select the products

- (1) By performance/type
- (2) By part number

### 2 Show graph

Click each button on each tab of [Basic], [S-parameter] and [Detailed].

### 3 Data download

- Click each purple button in this area.
- Click "CSV output" button.

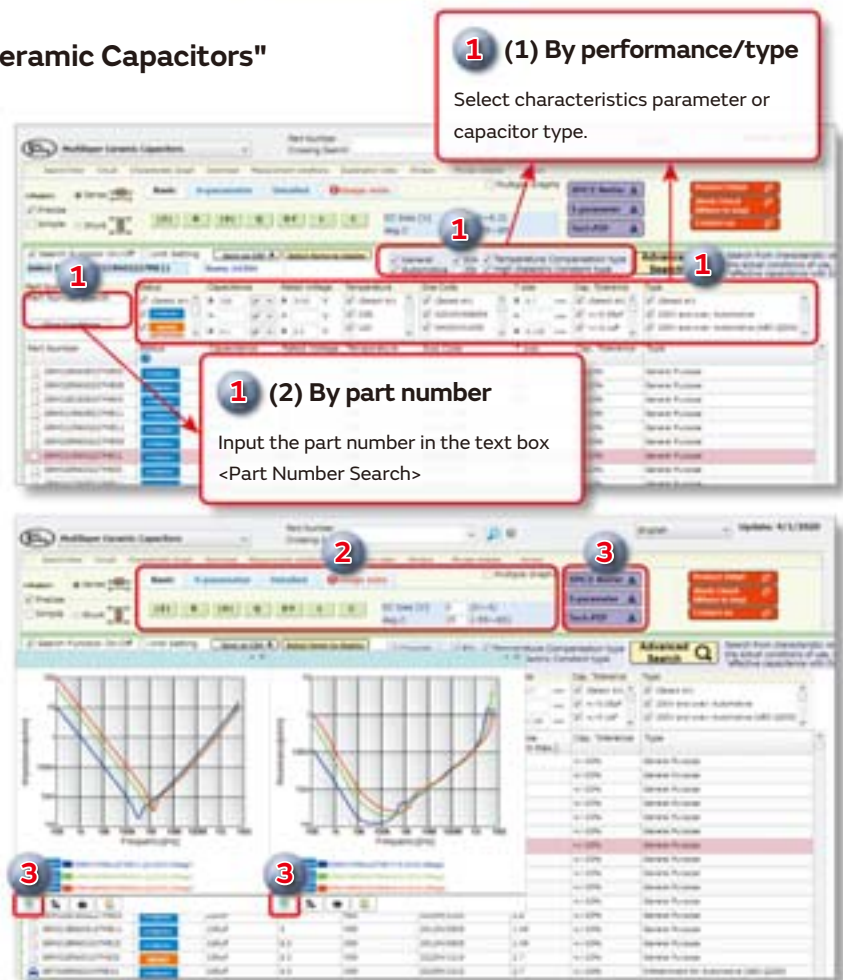

\* Images are as of May 2020. Be assured that this software will be updated frequently.

<https://ds.murata.co.jp/simsurfing/index.html>



# Web page Introduction



## Search by Part Number

<https://www.murata.com/search/productsearch?cate=cgsubCeramicCapacitors>



You can search for capacitors by specifying the alphanumeric characters in the part number. The packing codes shown contain the substitute character "#". If you enter the official packing code, part numbers that contain that packing code will be matched.



## Search by Specifications

<https://www.murata.com/search/productsearch?cate=luCeramicCapacitorsSMD#spec>



You can search for SMD, lead type, or screw termination type capacitors by indicating specifications such as application, capacitance, rated voltage, or temperature characteristics.

You can narrow your search by entering values of ranges, and by specifying product characteristics.

The items for narrowing searches are linked, so specifying one condition causes selectable options for the other items to allow input only of conditions that match the relevant part numbers.



## Search in the Lineups

<https://www.murata.com/products/capacitor/mlcc/lineup>

You can search for capacitors by specifying the series lineup.

You can also confirm items such as characteristics and applications on each series page.



Capacitance chart in Series page.



## [Search result]

Compares the characteristics of the checked  part numbers.

Displays the number of hits for the current search conditions in real time.

Click the ▲ mark for each item to switch between ascending and descending display.

Click a product name to display a details page listing more in-depth information (→ P44).

You can download detailed spec sheets.

For some products it is possible to request a free sample.

Icons enable you to check the status and characteristics of products at a glance.

You narrow the search results to match the selected condition in real time.

You can confirm the current conditions for narrowing the search results.

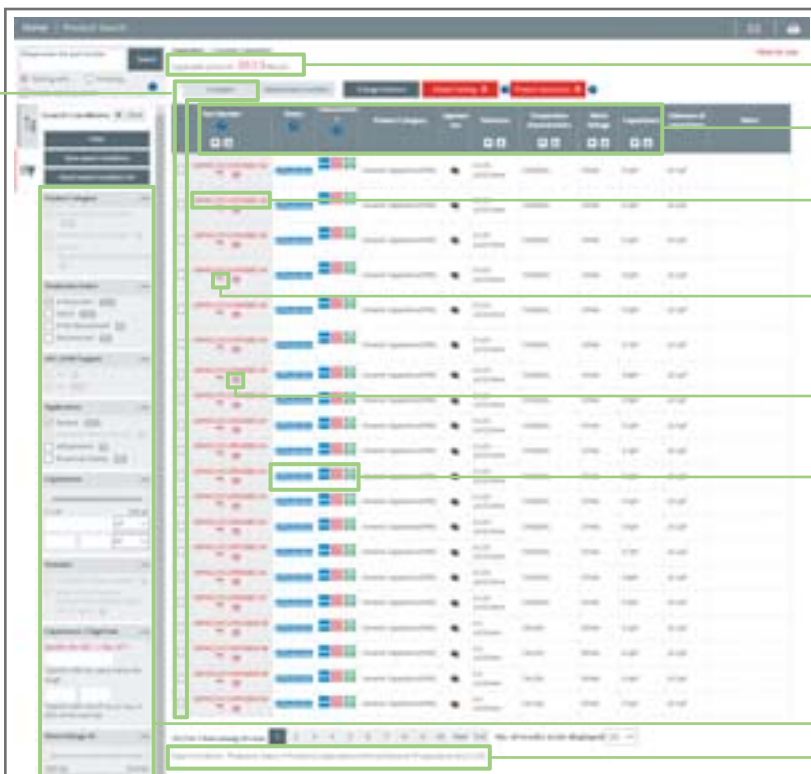

# Global Locations

For details please visit [www.murata.com](http://www.murata.com)



## ⚠ Note

### 1 Export Control

*For customers outside Japan:*

No Murata products should be used or sold, through any channels, for use in the design, development, production, utilization, maintenance or operation of, or otherwise contribution to (1) any weapons (Weapons of Mass Destruction [nuclear, chemical or biological weapons or missiles] or conventional weapons) or (2) goods or systems specially designed or intended for military end-use or utilization by military end-users.

*For customers in Japan:*

For products which are controlled items subject to the "Foreign Exchange and Foreign Trade Law" of Japan, the export license specified by the law is required for export.

2 Please contact our sales representatives or product engineers before using the products in this catalog for the applications listed below, which require especially high reliability for the prevention of defects which might directly damage a third party's life, body or property, or when one of our products is intended for use in applications other than those specified in this catalog.

- ① Aircraft equipment
- ② Aerospace equipment
- ③ Undersea equipment
- ④ Power plant equipment
- ⑤ Medical equipment
- ⑥ Transportation equipment (vehicles, trains, ships, etc.)
- ⑦ Traffic signal equipment
- ⑧ Disaster prevention / crime prevention equipment
- ⑨ Data-processing equipment
- ⑩ Application of similar complexity and/or reliability requirements to the applications listed above

3 Product specifications in this catalog are as of May 2020. They are subject to change or our products in it may be discontinued without advance notice. Please check with our sales representatives or product engineers before ordering. If there are any questions, please contact our sales representatives or product engineers.

4 Please read rating and ⚠CAUTION (for storage, operating, rating, soldering, mounting and handling) in this catalog to prevent smoking and/or burning, etc.

5 This catalog has only typical specifications. Therefore, please approve our product specifications or transact the approval sheet for product specifications before ordering.

6 Please note that unless otherwise specified, we shall assume no responsibility whatsoever for any conflict or dispute that may occur in connection with the effect of our and/or a third party's intellectual property rights and other related rights in consideration of your use of our products and/or information described or contained in our catalogs. In this connection, no representation shall be made to the effect that any third parties are authorized to use the rights mentioned above under licenses without our consent.

7 No ozone depleting substances (ODS) under the Montreal Protocol are used in our manufacturing process.

Murata Manufacturing Co., Ltd.

[www.murata.com](http://www.murata.com)

**muRata**  
INNOVATOR IN ELECTRONICS

## X-ON Electronics

Largest Supplier of Electrical and Electronic Components

*Click to view similar products for [Multilayer Ceramic Capacitors MLCC - SMD/SMT](#) category:*

*Click to view products by [Murata](#) manufacturer:*

Other Similar products are found below :

[M39014/02-1218V](#) [M39014/02-1225V](#) [M39014/22-0631](#) [D55342E07B523DR-T/R](#) [NIN-FB391JTRF](#) [NIN-FC2R7JTRF](#)  
[NMC0402NPO220J50TRPF](#) [NMC0402X5R105K6.3TRPF](#) [NMC0402X5R224K6.3TRPF](#) [NMC0402X7R103J25TRPF](#)  
[NMC0402X7R392K50TRPF](#) [NMC0603NPO201J50TRPF](#) [NMC0603NPO330G50TRPF](#) [NMC0603NPO331F50TRPF](#)  
[NMC0603X5R475M6.3TRPF](#) [NMC0603X7R333K16TRPF](#) [NMC0805NPO220J100TRPF](#) [NMC0805NPO820J50TRPF](#)  
[NMC1206X7R102K50TRPF](#) [NMC1206X7R106K10TRPLPF](#) [NMC-H0805X7R472K250TRPF](#) [C1608C0G2A221J](#) [C1608X7R1E334K](#)  
[C2012C0G2A472J](#) [2220J2K00562KXT](#) [CCR06CG153FSV](#) [CDR33BX104AKUR](#) [CDR33BX683AKUS](#) [CGA3E1X7R1C684K](#)  
[CL10C0R8BB8ANNC](#) [M55342H06B20G0R-T/R](#) [C1005X5R0G225M](#) [C2012X7R2E223K](#) [C3216C0G2J272J](#) [D55342E07B35E7R-T/R](#)  
[CDR34BX563BKUS](#) [CDR34BX563BKWS](#) [NMC0402NPO220F50TRPF](#) [NMC0402X7R562J25TRPF](#) [NMC0603NPO102J25TRPF](#)  
[NMC1206X7R332K50TRPF](#) [NMC-P1206X7R104K250TRPLPF](#) [726632-1](#) [CGA6M3X7R1H225K](#) [CGA5L2X7R2A105K](#)  
[CGA3E2X8R1H223K](#) [CDR33BX823AKUR\M500](#) [CDR33BP132BJUR](#) [CDR35BX474AKUR\M500](#) [CDR35BX104BKUR\M500](#)