

# Type 1XL Wi-Fi® + Bluetooth® Module

NXP 88W9098 Chipset for 802.11 a/b/g/n/ac/ax 2x2 MIMO +  
Bluetooth 5.3 Datasheet - Rev. N

- Design Name: Type 1XL
- P/N: LBEE5ZZ1XL-774



## Table of Contents

1 Scope .....	8
2 Key Features .....	8
3 Ordering Information .....	8
4 Block Diagram .....	9
5 Certification Information .....	10
5.1 Radio Certification.....	10
5.2 Bluetooth Qualification .....	10
6 Dimensions, Markings and Terminal Configurations .....	11
7 Module Pin Descriptions .....	12
7.1 Pin Assignments .....	12
7.2 Pin Descriptions .....	14
7.3 Configuration Pins.....	18
7.4 Pin States .....	18
7.5 SDIO Pin Descriptions .....	20
8 Absolute Maximum Ratings .....	21
9 Operating Condition .....	22
9.1 Operating Condition .....	22
9.2 Digital I/O Requirements .....	22
10 Power Sequence .....	23
10.1 Power-On Sequence.....	23
10.1.1 Power-On Sequence for 3.3V.....	23
10.1.2 Power-On Sequence for 1.8V.....	24
10.2 Power-Off Sequence.....	25
11 Host Interface Specification .....	25
11.1 SDIO Specifications .....	25
11.1.1 Default Speed, High Speed Modes.....	26
11.1.2 SDR12, SDR25, SDR50 Modes up to 100 MHz (1.8V).....	27
11.1.3 SDR104 Mode at 208 MHz (1.8V) .....	28
11.1.4 DDR50 Mode at 50 MHz (1.8V) .....	29
11.2 PCI Express Specifications .....	31
11.2.1 Differential Tx Output Electricals.....	31
11.2.2 Differential Rx Input Electricals.....	34
12 DC/RF Characteristics .....	36
12.1 DC/RF Characteristics for IEEE 802.11b - 2.4 GHz.....	36
12.1.1 High-Rate Condition for IEEE 802.11b - 2.4 GHz .....	37

12.1.2 Low-Rate Condition for IEEE 802.11b - 2.4 GHz .....	38
12.2 DC/RF Characteristics for IEEE 802.11g - 2.4 GHz.....	39
12.2.1 High-Rate Condition for IEEE 802.11g - 2.4 GHz .....	39
12.2.2 Low-Rate Condition for IEEE 802.11g - 2.4 GHz .....	40
12.3 DC/RF Characteristics for IEEE 802.11n - 2.4 GHz.....	41
12.3.1 High-Rate Condition for IEEE 802.11n - 2.4 GHz .....	41
12.3.2 Low-Rate Condition for IEEE 802.11n - 2.4 GHz .....	42
12.4 DC/RF Characteristics for IEEE 802.11ax - 2.4 GHz.....	43
12.4.1 High-Rate Condition for IEEE 802.11ax - 2.4 GHz .....	43
12.4.2 Low-Rate Condition for IEEE 802.11ax - 2.4 GHz .....	44
12.5 DC/RF Characteristics for IEEE 802.11a - 5 GHz.....	45
12.5.1 High-Rate Condition for IEEE 802.11a - 5 GHz .....	45
12.5.2 Low-Rate Condition for IEEE 802.11a - 5 GHz .....	46
12.6 DC/RF Characteristics for IEEE 802.11n (HT20) - 5 GHz.....	47
12.6.1 High-Rate Condition for IEEE 802.11n (HT20) - 5 GHz .....	47
12.6.2 Low-Rate Condition for IEEE 802.11n (HT20) - 5 GHz.....	48
12.7 DC/RF Characteristics for IEEE 802.11ac (VHT20) - 5 GHz .....	49
12.7.1 High-Rate Condition for IEEE 802.11ac (VHT20) - 5 GHz .....	49
12.7.2 Low-Rate Condition for IEEE 802.11ac (VHT20) - 5 GHz.....	50
12.8 DC/RF Characteristics for IEEE 802.11n (HT40) - 5 GHz.....	52
12.8.1 High-Rate Condition for IEEE 802.11n (HT40) - 5 GHz .....	52
12.8.2 Low-Rate Condition for IEEE 802.11n (HT40) - 5 GHz.....	53
12.9 DC/RF Characteristics for IEEE 802.11ac (VHT40) - 5 GHz .....	54
12.9.1 High-Rate Condition for IEEE 802.11ac (VHT40) - 5 GHz .....	54
12.9.2 Low-Rate Condition for IEEE 802.11ac (VHT40) - 5 GHz.....	55
12.10 DC/RF Characteristics for IEEE 802.11ac (VHT80) - 5 GHz.....	56
12.10.1 High-Rate Condition for IEEE 802.11ac (VHT80) - 5 GHz .....	56
12.10.2 Low-Rate Condition for IEEE 802.11ac (VHT80) - 5 GHz.....	57
12.11 DC/RF Characteristics for IEEE 802.11ax (HE20) - 5 GHz.....	58
12.11.1 High-Rate Condition for IEEE 802.11ax (HE20) - 5 GHz .....	59
12.11.2 Low-Rate Condition for IEEE 802.11ax (HE20) - 5 GHz .....	60
12.12 DC/RF Characteristics for IEEE 802.11ax (HE40) - 5 GHz.....	61
12.12.1 High-Rate Condition for IEEE 802.11ax (HE40) - 5 GHz .....	61
12.12.2 Low-Rate Condition for IEEE 802.11ax (HE40) - 5 GHz.....	62
12.13 DC/RF Characteristics for IEEE 802.11ax (HE80) - 5 GHz.....	63
12.13.1 High-Rate Condition for IEEE 802.11ax (HE80) - 5 GHz .....	63
12.13.2 Low-Rate Condition for IEEE 802.11ax (HE80) - 5 GHz .....	64

12.14 DC/RF Characteristics for Bluetooth.....	65
12.14.1 Basic Data Rate Condition.....	65
12.14.2 Enhanced Data Rate Condition .....	66
12.15 DC/RF Characteristics for Bluetooth Low Energy .....	67
12.15.1 1 Mbps PHY Condition .....	67
12.15.2 2 Mbps PHY Condition .....	68
13 Land Patterns .....	70
14 Radio Regulatory Certification by Country for 1XL/2XS .....	71
14.1 Japan.....	73
14.2 FCC .....	78
14.3 ISED .....	99
14.4 EU.....	117
15 Tape and Reel Packing.....	121
15.1 Dimensions of Tape (Plastic Tape).....	121
15.2 Dimensions of Reel .....	122
15.3 Taping Diagrams.....	123
15.4 Leader and Tail Tape .....	124
15.5 Packaging (Humidity Proof Packing) .....	125
16 Notice .....	126
16.1 Storage Conditions.....	126
16.2 Handling Conditions .....	126
16.3 Standard PCB Design (Land Pattern and Dimensions) .....	126
16.4 Notice for Chip Placer .....	127
16.5 Soldering Conditions .....	127
16.6 Cleaning.....	127
16.7 Operational Environment Conditions .....	127
17 Precondition to Use Our Products.....	129
Revision History.....	131

## Figures

Figure 1: Block Diagram .....	9
Figure 2: Dimensions, Marking and Terminal Configurations .....	11
Figure 3: Structure .....	12
Figure 4: Pin Assignments Top View .....	13
Figure 5: SDIO Modes .....	20
Figure 6: Power-On Sequence Graph for VIO 3.3V .....	23

Figure 7: Power-On Sequence Graph for VIO 1.8V .....	24
Figure 8: Power-Off Sequence Graph.....	25
Figure 9: SDIO Protocol Timing Diagram - Default Speed Mode (3.3V) .....	26
Figure 10: SDIO Protocol Timing Diagram - High Speed Mode (3.3V) .....	26
Figure 11: SDIO Protocol Timing Diagram - SDR12, SDR25, SDR50 Modes .....	27
Figure 12: SDIO Protocol Timing Diagram - SDR104 Mode.....	28
Figure 13: SDIO CMD Timing Diagram - DDR50 Mode .....	29
Figure 14: SDIO DAT[3:0] Timing Diagram - DDR50 Mode .....	29
Figure 15: Burst Current Definition.....	36
Figure 16: Land Patterns (Unit: mm) .....	70
Figure 17: Dimensions of Tape (Plastic Tape) .....	121
Figure 18: Dimensions of Reel (Unit: mm) .....	122
Figure 19: Taping Diagrams.....	123
Figure 20: Leader and Tail Tape.....	124
Figure 21: Peeling Force.....	125
Figure 22: Humidity Proof Packing.....	125
Figure 23: Reflow Soldering Standard Conditions (Example).....	127

## Tables

Table 1: Document Conventions .....	7
Table 2: Ordering Information .....	8
Table 3: Radio Certification.....	10
Table 4: Markings .....	11
Table 5: Dimensions .....	11
Table 6: Terminal Configurations .....	13
Table 7: Pin Descriptions .....	14
Table 8: Configuration Pins.....	18
Table 9: I/O State Table.....	19
Table 10: SDIO Pin Descriptions .....	20
Table 11: Absolute Maximum Ratings.....	21
Table 12: Operating Conditions .....	22
Table 13: Digital I/O Requirements Parameters .....	22
Table 14: SDIO Timing Data - Default Speed, High Speed Modes (3.3V) .....	26
Table 15: SDIO Timing Data - SDR12, SDR25, SDR50 Modes .....	27
Table 16: SDIO Timing Data - SDR104 Mode.....	28
Table 17: SDIO Timing Data - DDR50 Mode .....	30
Table 18: PCI Express Tx Output Specifications Data - 2.5 GT/s.....	31
Table 19: PCI Express Tx Output Specifications Data - 5 GT/s.....	32
Table 20: PCI Express Rx Input Specifications Data - 2.5 GT/s .....	34

Table 21: PCI Express Rx Input Specifications Data - 5 GT/s.....	35
Table 22: DC/RF Characteristic Files.....	36
Table 23: DC/RF Characteristics for IEEE 802.11b - 2.4 GHz.....	36
Table 24: High-Rate Condition for IEEE 802.11b - 2.4 GHz.....	37
Table 25: Low-Rate Condition for IEEE 802.11b - 2.4 GHz.....	38
Table 26: DC/RF Characteristics for IEEE 802.11g - 2.4 GHz.....	39
Table 27: High-Rate Condition for IEEE 802.11g - 2.4 GHz.....	39
Table 28: Low-Rate Condition for IEEE 802.11g - 2.4 GHz.....	40
Table 29: DC/RF Characteristics for IEEE 802.11n - 2.4 GHz.....	41
Table 30: High-Rate Condition for IEEE 802.11n - 2.4 GHz.....	41
Table 31: Low-Rate Condition for IEEE 802.11n - 2.4 GHz.....	42
Table 32: DC/RF Characteristics for IEEE 802.11ax - 2.4 GHz.....	43
Table 33: High-Rate Condition for IEEE 802.11ax - 2.4 GHz.....	43
Table 34: Low-Rate Condition for IEEE 802.11ax - 2.4 GHz.....	44
Table 35: DC/RF Characteristics for IEEE 802.11a - 5 GHz.....	45
Table 36: High-Rate Condition for IEEE 802.11a - 5 GHz.....	45
Table 37: Low-Rate Condition for IEEE 802.11a - 5 GHz.....	46
Table 38: DC/RF Characteristics for IEEE 802.11n(HT20) - 5 GHz.....	47
Table 39: High-Rate Condition for IEEE 802.11n (HT20) - 5 GHz.....	47
Table 40: Low-Rate Condition for IEEE 802.11n (HT20) - 5 GHz.....	48
Table 41: DC/RF Characteristics for IEEE 802.11ac (VHT20) - 5 GHz.....	49
Table 42: High-Rate Condition for IEEE 802.11ac (VHT20) - 5 GHz.....	49
Table 43: Low-Rate Condition for IEEE 802.11ac (VHT20) - 5 GHz.....	50
Table 44: DC/RF Characteristics for IEEE 802.11n (HT40) - 5 GHz.....	52
Table 45: High-Rate Condition for IEEE 802.11n (HT40) - 5 GHz.....	52
Table 46: Low-Rate Condition for IEEE 802.11n (HT40) - 5 GHz.....	53
Table 47: DC/RF Characteristics for IEEE 802.11ac (VHT40) - 5 GHz.....	54
Table 48: High-Rate Condition for IEEE 802.11ac (VHT40) - 5 GHz.....	54
Table 49: Low-Rate Condition for IEEE 802.11ac (VHT40) - 5 GHz.....	55
Table 50: DC/RF Characteristics for IEEE 802.11ac (VHT80) - 5 GHz.....	56
Table 51: High-Rate Condition for IEEE 802.11ac (VHT80) - 5 GHz.....	56
Table 52: Low-Rate Condition for IEEE 802.11ac (VHT80) - 5 GHz.....	57
Table 53: DC/RF Characteristics for IEEE 802.11ax (HE20) - 5 GHz.....	58
Table 54: High-Rate Condition for IEEE 802.11ax (HE20) - 5 GHz.....	59
Table 55: Low-Rate Condition for IEEE 802.11ax (HE20) - 5 GHz.....	60
Table 56: DC/RF Characteristics for IEEE 802.11ax (HE40) - 5 GHz.....	61
Table 57: High-Rate Condition for IEEE 802.11ax (HE40) - 5 GHz.....	61
Table 58: Low-Rate Condition for IEEE 802.11ax (HE 40) - 5 GHz.....	62
Table 59: DC/RF Characteristics for IEEE 802.11ax (HE80) - 5 GHz.....	63
Table 60: High-Rate Condition for IEEE 802.11ax (HE80) - 5 GHz.....	63

Table 61: Low-Rate Condition for IEEE 802.11ax (HE80) - 5 GHz.....	64
Table 62: Basic Data Rate Condition .....	65
Table 63: Enhanced Data Rate Condition.....	66
Table 64: 1 Mbps PHY Condition .....	67
Table 65: 2 Mbps PHY Condition .....	68
Table 66: Taping Specifications .....	123

## About This Document

Murata's Type 1XL is a small and high-performance module based on NXP 88W9098 combo chipset, supporting IEEE 802.11a/b/g/n/ac/ax 2x2 MIMO + Bluetooth 5.3 BR/EDR/LE. This datasheet describes Type 1XL module in detail.



Please be aware that an important notice concerning availability, standard warranty and use in critical applications of Murata products and disclaimers thereto appears at the end of this specification sheet.









## Audience & Purpose

Intended audience includes any customer looking to integrate this module into their product. In particular RF, hardware, software, and systems engineers.

## Document Conventions

**Table 1** describes the document conventions.

**Table 1: Document Conventions**

Conventions	Description
	<b>Warning Note</b> Indicates very important note. Users are strongly recommended to review.
	<b>Info Note</b> Intended for informational purposes. Users should review.
	<b>Menu Reference</b> Indicates menu navigation instructions. <b>Example:</b> Insert → Tables → Quick Tables → Save Selection to Gallery 
	<b>External Hyperlink</b> This symbol indicates a hyperlink to an external document or website. <b>Example:</b> <a href="#">Embedded Artists AB</a>  Click on the text to open the external link.
	<b>Internal Hyperlink</b> This symbol indicates a hyperlink within the document. <b>Example:</b> <a href="#">Scope</a>  Click on the text to open the link.
<code>Console input/output or code snippet</code>	<b>Console I/O or Code Snippet</b> This text <b>Style</b> denotes console input/output or a code snippet.
<code># Console I/O comment // Code snippet comment</code>	<b>Console I/O or Code Snippet Comment</b> This text <b>Style</b> denotes a console input/output or code snippet comment. <ul style="list-style-type: none"> <li>• Console I/O comment (preceded by "#") is for informational purposes only and does not denote actual console input/output.</li> <li>• Code Snippet comment (preceded by "//") may exist in the original code.</li> </ul>



## 1 Scope

This specification characterizes the IEEE 802.11 a/b/g/n/ac/ax 2x2 MIMO + Bluetooth 5.3 combo BR/EDR/LE module.

## 2 Key Features

- ◆ NXP 88W9098 inside
- ◆ Supports IEEE 802.11a/b/g/n/ac/ax specification: Dual band 2.4 GHz and 5 GHz
- ◆ MIMO with 20 MHz, 40 MHz, and 80 MHz channels
- ◆ Up to MCS11 data rates (1200 Mbps)
- ◆ Supports Bluetooth specification version 5.3
- ◆ For supported Bluetooth functions, refer to [Bluetooth SIG site](#) 
- ◆ WLAN interface: PCIe 2.0 and SDIO 3.0
- ◆ Bluetooth interface: HCI UART and PCM
- ◆ Dimensions: 19.1 x 16.5 x 2.1 mm
- ◆ Weight: 1355 mg
- ◆ MSL: 3
- ◆ Surface-mount type
- ◆ RoHS compliant
- ◆ B10 life: 13 years, B1 life: 10 years  
(Wear-out failure with 20°C daily ambient room temperature change)
- ◆ Fit: 140.36 (Accidental failure)

## 3 Ordering Information

**Table 2** describes the ordering information.

**Table 2: Ordering Information**

Ordering Part Number	Description
LBEE5ZZ1XL-774	Module order
LBEE5ZZ1XL-SMP	Sample module order (If module samples are not available through distribution, contact Murata referencing this part number)
EAR00387	Embedded Artists Type 1XL M.2 EVB (default EVB available through distribution)

## 4 Block Diagram

The Type 1XL block diagram is presented in **Figure 1**.

**Figure 1: Block Diagram**

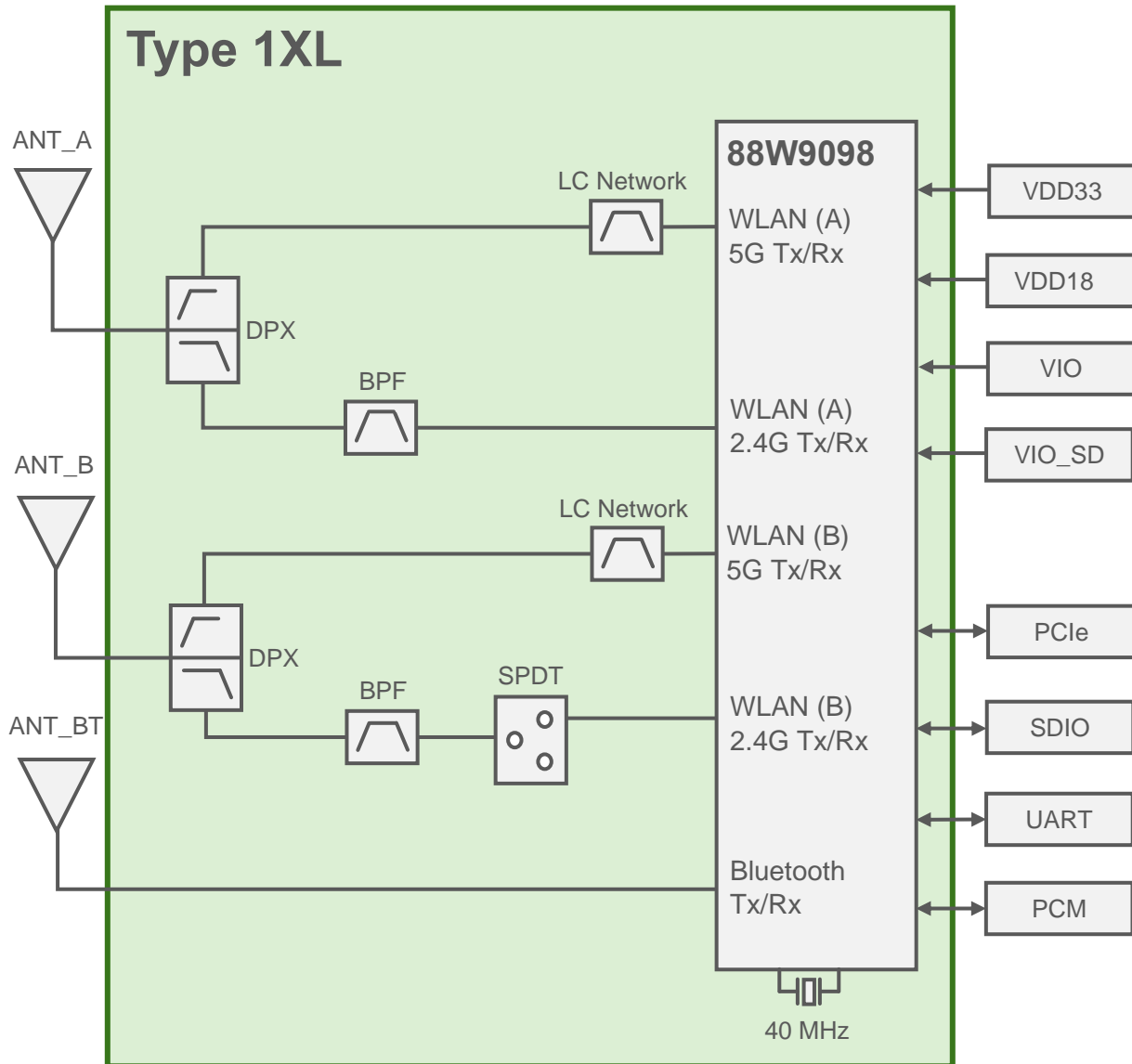

## 5 Certification Information

This section has information about radio and Bluetooth certification.

### 5.1 Radio Certification

Table 3 shows the radio certification information.



**Table 3: Radio Certification**

Country	ID	Country Code
USA (FCC)	VPYLBEE5ZZ1XL	US
Canada (IC)	772C-LBEE5ZZ1XL	CA
Europe	EN300328/301893, EN300440 conducted test report is prepared.	DE
Japan	Japanese type certification is prepared.  001-P01770	JP



Each country code is defined by Murata's DB.txt file. Please ask your contact person from Murata.

### 5.2 Bluetooth Qualification

- QDID: 184816
- Set Bluetooth Tx Power to Class 1 by using [bt\\_power\\_config\\_1.sh](#) .
- For supported Bluetooth functions, refer to [Bluetooth SIG site](#) .

## 6 Dimensions, Markings and Terminal Configurations

This section provides information about dimensions, markings, and terminal configuration for Type 1XL and the related parameters. **Figure 2** shows the dimensions, markings, and terminal configurations.

**Figure 2: Dimensions, Marking and Terminal Configurations**

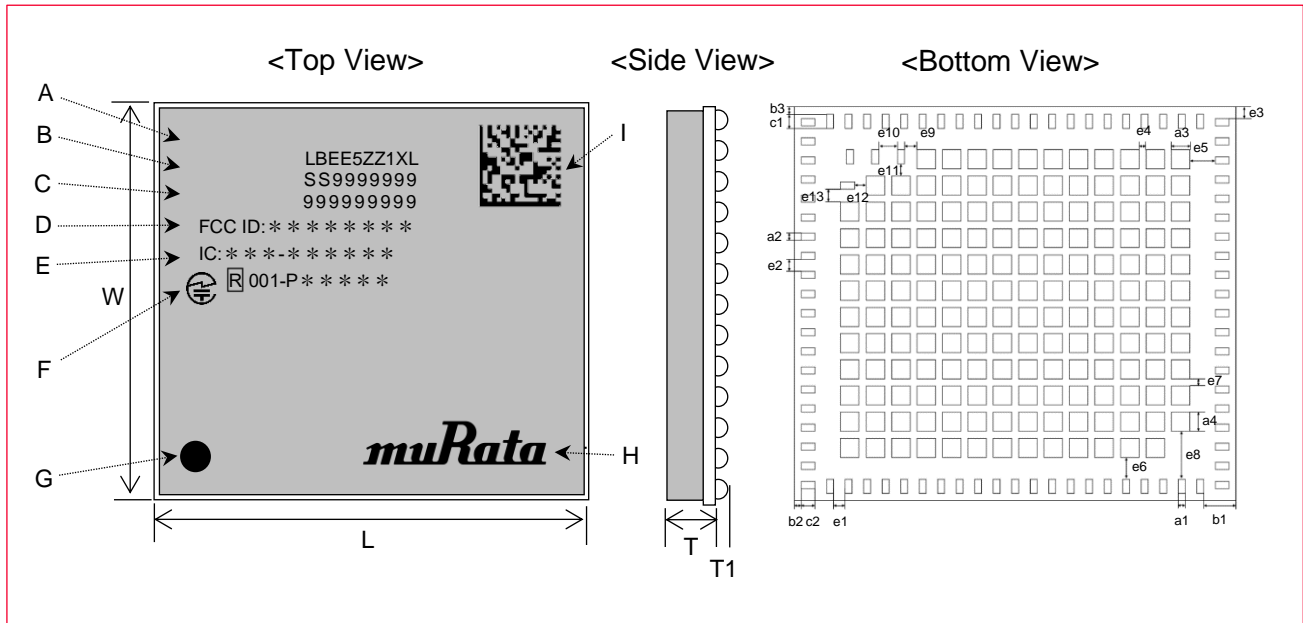

**Table 4** describes the Type 1XL markings.

**Table 4: Markings**

Marking	Meaning
A	Module Type
B	Production Process Number
C	Serial Number
D	FCC ID
E	ISED ID
F	Japan certification mark & ID
G	Pin-1 Marking
H	Murata Logo
I	2D code

**Table 5** describes the Type 1XL dimensions.

**Table 5: Dimensions**

Mark	Dimensions (mm)	Mark	Dimensions (mm)	Mark	Dimensions (mm)
L	19.1 +/- 0.2	W	16.5 +/- 0.2	T	2.1 max
T1	0.45 typ.	a1	0.3 +/- 0.1	a2	0.3 +/- 0.1

Mark	Dimensions (mm)	Mark	Dimensions (mm)	Mark	Dimensions (mm)
a3	0.8 +/- 0.1	a4	0.8 +/- 0.1	b1	1.4 +/- 0.2
b2	0.3 +/- 0.2	b3	0.3 +/- 0.2	c1	0.6 +/- 0.1
c2	0.6 +/- 0.1	e1	0.5 +/- 0.1	e2	0.5 +/- 0.1
e3	0.5 +/- 0.2	e4	0.3 +/- 0.1	e5	1.1 +/- 0.1
e6	0.9 +/- 0.1	e7	0.3 +/- 0.1	e8	2.0 +/- 0.1
e9	0.55 +/- 0.1	e10	0.8 +/- 0.1	e11	0.5 +/- 0.1
e12	0.5 +/- 0.1	e13	0.55 +/- 0.1		

Figure 3 shows Type 1XL Structure.

Figure 3: Structure

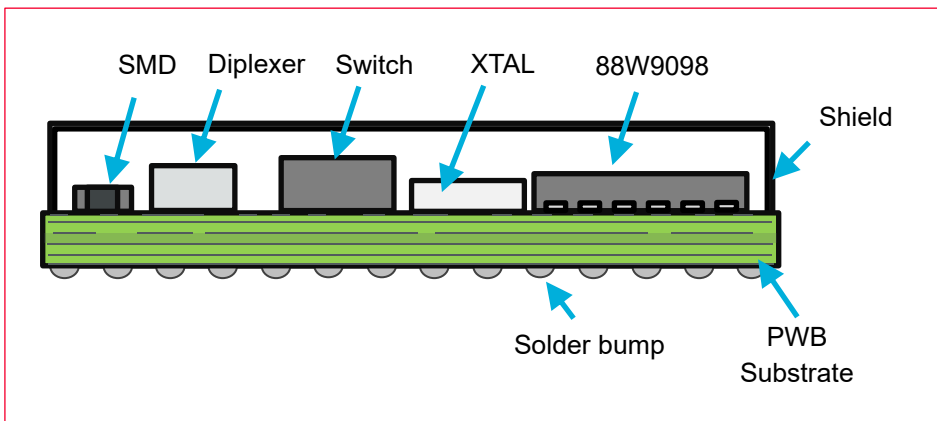

## 7 Module Pin Descriptions

This section has the pin descriptions of Type 1XL and pin assignments layout descriptions.

### 7.1 Pin Assignments

This section describes the pin assignments to terminals. Type 1XL pin-assignment top view is presented in **Figure 4**.

Figure 4: Pin Assignments Top View

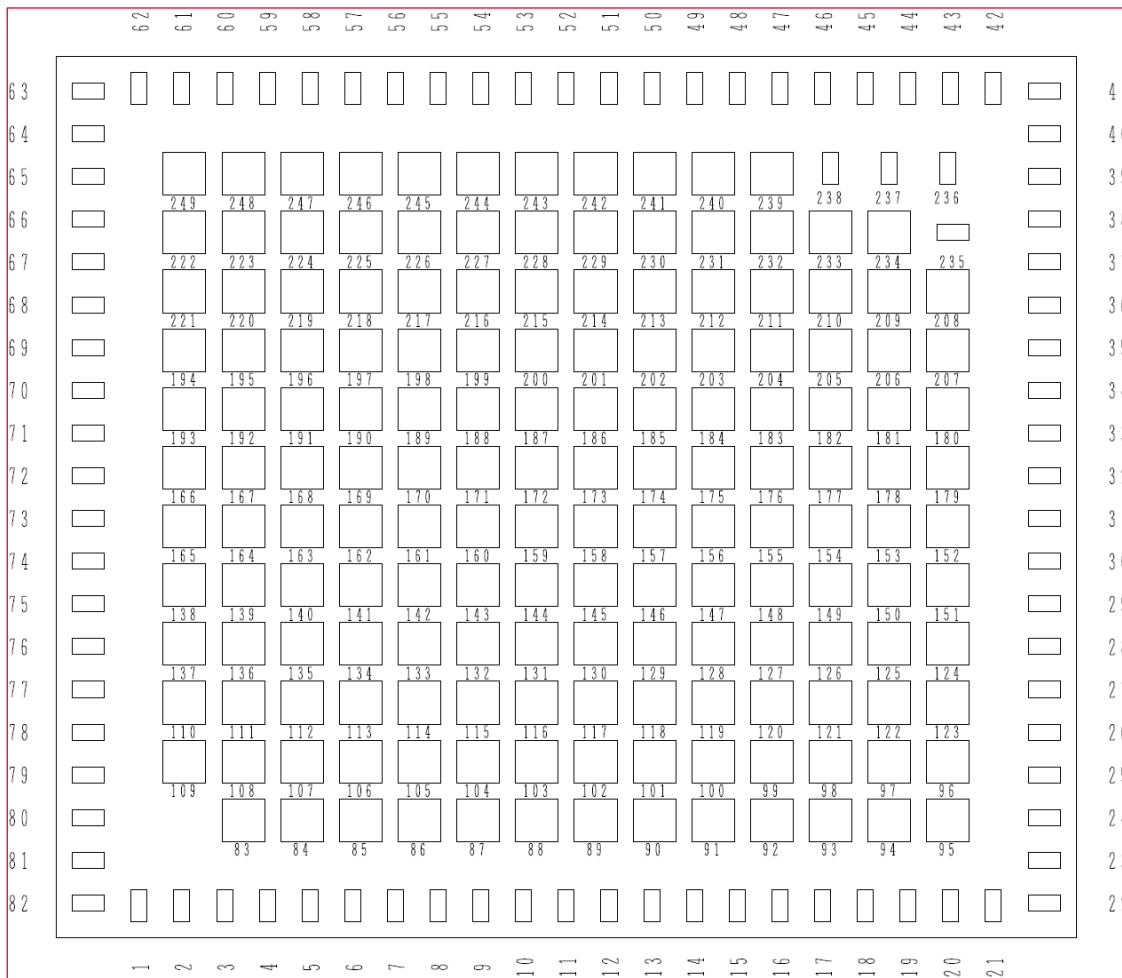

Table 6 lists the Type 1XL terminal configurations.

Table 6: Terminal Configurations



No.	Terminal Name	No.	Terminal Name	No.	Terminal Name
1	GND	31	GND	61	GPIO[26]
2	GND	32	NC	62	GPIO[27]
3	CONFIG_HOST[0]	33	NC	63	GND
4	CONFIG_HOST[1]	34	GND	64	GND
5	CONFIG_HOST[2]	35	VIO_SD	65	BT_RF_OUT
6	GPIO[1]	36	SD_CLK	66	GND
7	GPIO[0]	37	SD_CMD	67	GND
8	GPIO[14]	38	SD_D[0]	68	NC
9	GPIO[4]	39	SD_D[1]	69	GND
10	GPIO[6]	40	SD_D[2]	70	GPIO[22]
11	GPIO[5]	41	GND	71	GPIO[23]
12	GPIO[7]	42	SD_D[3]	72	GPIO[19]

No.	Terminal Name	No.	Terminal Name	No.	Terminal Name
13	GPIO[16]	43	PCIE_PERSTn	73	GPIO[18]
14	GPIO[15]	44	PCIE_CLKREQn	74	GPIO[17]
15	PDn	45	PCIE_WAKEn	75	GND
16	GND	46	W_DISABLE1n	76	WL_B_ANT/ WL_B_BT_ANT
17	VDD33	47	GPIO[31]	77	GND
18	VDD33	48	GPIO[29]	78	GND
19	VIO	49	GPIO[30]	79	GND
20	VDD18	50	GPIO[28]	80	WL_A_ANT
21	VDD18	51	GPIO[3]	81	GND
22	GND	52	GPIO[2]	82	GND
23	PCIE_CLK_N	53	GPIO[11]	83-234	GND
24	PCIE_CLK_P	54	GPIO[10]	235	RF_CNTL0_N
25	GND	55	GPIO[9]	236	RF_CNTL3_P
26	PCIE_TX_P	56	GPIO[8]	237	RF_CNTL2_N
27	PCIE_TX_N	57	GPIO[12]	238	RF_CNTL1_P
28	GND	58	GPIO[13]	239- 248	GND
29	PCIE_RX_N	59	GPIO[24]	249	NC
30	PCIE_RX_P	60	GPIO[25]		

## 7.2 Pin Descriptions

**Table 7** has the pin descriptions.

**Table 7: Pin Descriptions**

No.	Terminal Name	Type	Power Supply	Description
1	GND	GND		Ground
2	GND	GND		Ground
3	CONFIG_HOST[0]	I	VDD18	Host configuration options. Selects the host interface used for Wi-Fi and Bluetooth. See <a href="#">Section 7.3</a>  . Internal pull-up
4	CONFIG_HOST[1]	I	VDD18	Host configuration options. Selects the host interface used for Wi-Fi and Bluetooth. See <a href="#">Section 7.3</a>  . Internal pull-up
5	CONFIG_HOST[2]	I	VDD18	Host configuration options. Selects the host interface used for Wi-Fi and Bluetooth. See <a href="#">Section 7.3</a>  . Internal pull-up
6	GPIO[1]	I/O	VIO	GPIO[1]
7	GPIO[0]	I/O	VIO	GPIO[0]

No.	Terminal Name	Type	Power Supply	Description
8	GPIO[14]	I/O	VIO	CONFIG_AUTO_REF_DET GPIO[14]
9	GPIO[4]	I/O	VIO	PCM Mode: Receive PCM input. I2S Mode: Receive I2S input. GPIO[4]
10	GPIO[6]	I/O	VIO	PCM Mode: PCM clock I2S Mode: I2S bit clock <ul style="list-style-type: none"> <li>• Output if master</li> <li>• Input if slave</li> </ul> GPIO[6]
11	GPIO[5]	I/O	VIO	PCM Mode: Transmit PCM output. I2S Mode: Transmit I2S output. GPIO[5]
12	GPIO[7]	I/O	VIO	PCM Mode: PCM frame sync. I2S Mode: I2S left-right clock. <ul style="list-style-type: none"> <li>• Output if master</li> <li>• Input if slave</li> </ul> GPIO[7]
13	GPIO[16]	I/O	VIO	GPIO[16]
14	GPIO[15]	I/O	VIO	GPIO[15]
15	PDn	I	VDD18	Full power-down (input) (active low) <ul style="list-style-type: none"> <li>• <b>0</b> = full power-down mode</li> <li>• <b>1</b> = normal operation mode</li> <li>• PDn can accept an input of 1.8V to 4.5V</li> <li>• PDn may be driven by the host</li> <li>• PDn must be high for normal operation</li> </ul> No internal pull-up on this pin. Connect to power down pin (GPIO) of host or tie to power rail. External host required to drive this pin high for normal operation mode.
16	GND	GND		Ground
17	VDD33	P		3.3V Voltage Input
18	VDD33	P		3.3V Voltage Input
19	VIO	P		1.8V/3.3V Digital I/O Power Supply
20	VDD18	P		1.8V Voltage Input
21	VDD18	P		1.8V Voltage Input
22	GND	GND		Ground
23	PCIE_CLK_N	I	VDD18	PCI Express Differential Clock Input—Negative
24	PCIE_CLK_P	I	VDD18	PCI Express Differential Clock Input—Positive
25	GND	GND	-	Ground
26	PCIE_TX_P	O	VDD18	PCI Express Transmit Data—Positive
27	PCIE_TX_N	O	VDD18	PCI Express Transmit Data—Negative
28	GND	GND		Ground
29	PCIE_RX_N	I	VDD18	PCI Express Receive Data—Negative
30	PCIE_RX_P	I	VDD18	PCI Express Receive Data—Positive
31	GND	GND		Ground



No.	Terminal Name	Type	Power Supply	Description
32	NC			No Connection
33	NC			No Connection
34	GND	GND		Ground
35	VIO_SD	P		1.8V/3.3V Digital I/O SDIO power supply. <ul style="list-style-type: none"> <li>For SDIO ultra high speed mode (25 to 208 MHz), VIO_SD must be 1.8V.</li> <li>For SDIO default mode (up to 25 MHz) and high speed mode (up to 50 MHz), VIO_SD must be 1.8V or 3.3V.</li> </ul> Need to be applied even in PCIE mode.
36	SD_CLK	I	VIO_SD	SDIO 4-bit Mode: Clock inputInternal pull-up
37	SD_CMD	I/O	VIO_SD	SDIO 4-bit Mode: Command/response (input/output)Internal pull-up
38	SD_D[0]	I/O	VIO_SD	SDIO 4-bit Mode: Data line Bit[0]Internal pull-up
39	SD_D[1]	I/O	VIO_SD	SDIO 4-bit Mode: Data line Bit[1]Internal pull-up
40	SD_D[2]	I/O	VIO_SD	SDIO 4-bit Mode: Data line Bit[2] or read wait (optional)Internal pull-up
41	GND	GND	-	Ground
42	SD_D[3]	I/O	VIO_SD	SDIO 4-bit Mode: Data line Bit[3]Internal pull-up
43	PCIE_PERSTn	I	VIO	PCIE host indication to reset the device (input)(active low) <b>Note:</b> Muxed with GPIO[20].(input/output) Internal pull-up.
44	PCIE_CLKREQn	O	Open drain	PCIE clock request (input/output) (active low) <b>Note:</b> An external pull-up (on host side) is required. If this pin used as input signal, Power supply is VIO.
45	PCIE_WAKEn	O	Open drain	PCIE wake signal (input/output) (active low) <b>Note:</b> An external pull-up (on host side) is required. If this pin used as input signal, Power supply is VIO.
46	W_DISABLE1n	I	VIO	GPIO Mode: GPIO[21] (input/output) Default Mode: W_DISABLE1n (input) (active low) Host indication to disable the Wi-Fi function of the device. See GPIO[12] for W_DISABLE2n (input) (active low).
47	GPIO[31]	I/O	VIO	GPIO Mode: GPIO[31] (input/output) JTAG Mode: JTAG_TDO, JTAG test data (output) Coexistence Mode: UART_LTE_SOUT (LTE coexistence data output signal)
48	GPIO[29]	I/O	VIO	GPIO Mode: GPIO[29] (input/output) JTAG Mode: JTAG_TMS, JTAG controller select (input)
49	GPIO[30]	I/O	VIO	GPIO Mode: GPIO[30] (input/output) JTAG Mode: JTAG_TDI, JTAG test data (input) Coexistence Mode: UART_LTE_SIN (LTE coexistence data input signal)
50	GPIO[28]	I/O	VIO	GPIO Mode: GPIO[28] (input/output) JTAG Mode: JTAG_TCK, JTAG test clock (input)
51	GPIO[3]	I/O	VIO	GPIO Mode: GPIO[3] (input/output) LED Mode: LED_OUT_BT (output) I2S Mode: I2S_CCLK (output, optional) PCM Mode: PCM_MCLK (output, optional)
52	GPIO[2]	I/O	VIO	GPIO Mode: GPIO[2] (input/output) LED Mode: LED_OUT_WLAN (output)
53	GPIO[11]	I/O	VIO	GPIO Mode: GPIO[11] (input/output) UART Mode: UART_RTSn (output) (active low)

No.	Terminal Name	Type	Power Supply	Description
54	GPIO[10]	I/O	VIO	GPIO Mode: GPIO[10] (input/output) UART Mode: UART_CTSn (input) (active low)
55	GPIO[9]	I/O	VIO	GPIO Mode: GPIO[9] (input/output) UART Mode: UART_SIN (input)
56	GPIO[8]	I/O	VIO	GPIO Mode: <b>GPIO[8] (input/output)</b> UART Mode: <b>UART_SOUT (output)</b>
57	GPIO[12]	I/O	VIO	GPIO Mode: GPIO[12] (input/output) Default Mode: W_DISABLE2n (input) (active low) Host indication to disable the Wi-Fi function of the device. See GPIO[21] for W_DISABLE1n (input) (active low).
58	GPIO[13]	I/O	VIO	GPIO Mode: GPIO[13] (input/output)
59	GPIO[24]	I/O	VIO	GPIO Mode: GPIO[24] (input/output)
60	GPIO[25]	I/O	VIO	GPIO Mode: GPIO[25] (input/output)
61	GPIO[26]	I/O	VIO	GPIO Mode: GPIO[26] (input/output)
62	GPIO[27]	I/O	VIO	GPIO Mode: GPIO[27] (input/output)
63	GND	GND		Ground
64	GND	GND		Ground
65	BT_RF_OUT	RF		Bluetooth Transmit/Receive
66	GND	GND		Ground
67	GND	GND		Ground
68	NC	NC		NC
69	GND	GND		Ground
70	GPIO[22]	I/O	VDD33	GPIO[22]
71	GPIO[23]	I/O	VDD33	GPIO[23]
72	GPIO[19]	I/O	VIO	GPIO[19]
73	GPIO[18]	I/O	VIO	GPIO[18]
74	GPIO[17]	I/O	VIO	GPIO[17]
75	GND	GND		Ground
76	WL_B_ANT	RF		WLAN Transmit/Receive – Path B
77	GND	GND		Ground
78	GND	GND		Ground
79	GND	GND		Ground
80	WL_A_ANT	RF		WLAN Transmit/Receive – Path A
81	GND	GND		Ground
82	GND	GND		Ground
83-234	GND	GND		Ground
235	RF_CNTL0_N	O	VDD33	RF Control 0-RF Control Output Low (output)
236	RF_CNTL3_P	O	VDD33	RF Control 3-RF Control Output High (output)
237	RF_CNTL2_N	O	VDD33	RF Control 2-RF Control Output Low (output)
238	RF_CNTL1_P	O	VDD33	RF Control 1-RF Control Output High (output)

No.	Terminal Name	Type	Power Supply	Description
239-248	GND	GND		Ground
249	NC	GND		No Connection

## 7.3 Configuration Pins

**Table 8** describes the configuration pins.

**Table 8: Configuration Pins**

Pin Name	Configuration Function
GPIO[6]	Reserved.
GPIO[5]	Reserved.
GPIO[4]	Reserved.
GPIO[17]	Reserved.
GPIO[16]	0
GPIO[15]	0
GPIO[14]	Reserved.
CONFIG_HOST[2:0]	[2:0] 000 = WLAN SDIO, Bluetooth UART [2:0] 011 = WLAN PCIe, Bluetooth UART



Keep logic level until finished power-up sequence.

To set a configuration bit to 0, attach a 51 kΩ resistor from the pin to ground. No external circuitry is required to set a configuration bit to 1. GPIO[4][5][6][14][15][16][17] can be open because these signals have weak or nominal PD on the module or reserve pins. See [Section 7.4](#).

## 7.4 Pin States

Pin states information for the tables below include:

- After firmware is downloaded, the pads (GPIO, Serial interface, RF control) are programmed in functional mode per the functionality of the pins.
- For SDIO, once the command is received from the host, the pads are configured accordingly.
- Pull-up and pull-down are only effective when the pad is in input mode.
- The power-down state shown is the default configuration. Many pads have programmable power-down values, which can be set by firmware.
- Do not need any termination to the open pins in input mode that have an Internal pull-up/pull-down resistor (PU/PD). Do not need any termination to the open pins in output mode. Do not need any termination to PCIE signals in SDIO mode.

Table 9: I/O State Table

Pin Name	Supply	No Pad Power State <sup>1</sup>	Reset State	HW State	PD State	PD Prog	Internal PU/PD	Int'l Pull Value [Ω]
GPIO[0]	VIO	tristate	output	output	drive low	yes	nominal PU	100K
GPIO[1]	VIO	tristate	input	input	tristate	yes	weak PU	800K
GPIO[2]	VIO	tristate	input	input	tristate	yes	nominal PU	100K
GPIO[3]	VIO	tristate	input	input	tristate	yes	nominal PU	100K
GPIO[4]	VIO	tristate	input	input	tristate	yes	weak PU	800K
GPIO[5]	VIO	tristate	input	input	tristate	yes	weak PU	800K
GPIO[6]	VIO	tristate	input	input	tristate	yes	weak PU	800K
GPIO[7]	VIO	tristate	input	input	tristate	yes	nominal PU	100K
GPIO[8]	VIO	tristate	input	input	drive low	yes	nominal PU	100K
GPIO[9]	VIO	tristate	input	input	tristate	yes	nominal PU	100K
GPIO[10]	VIO	tristate	input	input	tristate	yes	nominal PU	100K
GPIO[11]	VIO	tristate	input	input	drive high	yes	nominal PU	100K
GPIO[12]	VIO	tristate	input	input	tristate	yes	nominal PD	100K
GPIO[13]	VIO	tristate	input	input	drive high	yes	nominal PU	100K
GPIO[14]	VIO	tristate	input	input	tristate	yes	nominal PD on the module	51K
GPIO[15]	VIO	tristate	input	input	tristate	yes	weak PD	800K
GPIO[16]	VIO	tristate	input	input	tristate	yes	weak PD	800K
GPIO[17]	VIO	tristate	input	input	tristate	yes	weak PD	800K
GPIO[18]	VIO	tristate	input	input	tristate	yes	weak PD	800K
GPIO[19]	VIO	tristate	input	input	tristate	yes	weak PU	800K
GPIO[20]	VIO	tristate	input	input	drive high	yes	nominal PU	100K
GPIO[21]	VIO	tristate	input	input	tristate	yes	nominal PU	100K
GPIO[22]	VDD33	tristate	input	input	drive high	yes	weak PU	800K
GPIO[23]	VDD33	tristate	input	input	drive low	yes	weak PU	800K
GPIO[24]	VIO	tristate	input	input	tristate	yes	nominal PU	100K
GPIO[25]	VIO	tristate	input	input	drive high	yes	nominal PU	100K
GPIO[26]	VIO	tristate	input	input	tristate	yes	nominal PU	100K
GPIO[27]	VIO	tristate	input	input	tristate	yes	nominal PU	100K
GPIO[28]	VIO	tristate	input	input	tristate	yes	nominal PU	100K
GPIO[29]	VIO	tristate	input	input	tristate	yes	nominal PD	100K
GPIO[30]	VIO	tristate	input	input	tristate	yes	nominal PU	100K
GPIO[31]	VIO	tristate	input	input	tristate	yes	nominal PU	100K
SD_CLK	VIO	tristate	input	input	tristate	no	nominal PU	100K
SD_CMD	VIO	tristate	input	input	tristate	no	nominal PU	100K
SD_D[0]	VIO	tristate	input	input	tristate	no	nominal PU	100K
SD_D[1]	VIO	tristate	input	input	tristate	no	nominal PU	100K
SD_D[2]	VIO	tristate	input	input	tristate	no	nominal PU	100K
SD_D[3]	VIO	tristate	input	input	tristate	no	nominal PU	100K
PCIE_CLKP	AVDD18							
PCIE_CLKN	AVDD18	—	—	—	—	—	—	—
PCIE_TXP	AVDD18	—	—	—	—	—	—	—

<sup>1</sup> Maximum input voltage is 0.4V when VIO has no power (or in uncertain situations)

Pin Name	Supply	No Pad Power State <sup>1</sup>	Reset State	HW State	PD State	PD Prog	Internal PU/PD	Int'l Pull Value [Ω]
PCIE_TXN	AVDD18	—	—	—	—	—	—	—
PCIE_RXP	AVDD18	—	—	—	—	—	—	—
PCIE_RXN	AVDD18	—	—	—	—	—	—	—
PCIE_WAKE_N	VIO	tristate	input	output	n/a	n/a	n/a	—
PCIE_CLKREQ_N	VIO	tristate	input	output	n/a	n/a	n/a	—
PCIE_PERST_N	VIO	tristate	input	input	drive high	yes	nominal PU	100K
CONFIG_HOST[0]	AVDD18	tristate	input	input	tristate	no	weak PU	800K
CONFIG_HOST[1]	AVDD18	tristate	input	input	tristate	no	weak PU	800K
CONFIG_HOST[2]	AVDD18	tristate	input	input	tristate	no	weak PU	800K
RF_CNTL0_N	VDD33	tristate	input	output	drive low	yes	nominal PU	100K
RF_CNTL1_P	VDD33	tristate	input	output	drive low	yes	weak PU	800K
RF_CNTL2_N	VDD33	tristate	input	output	drive low	yes	weak PU	800K
RF_CNTL3_P	VDD33	tristate	input	output	drive low	yes	weak PU	800K
PDn	AVDD18	—	—	—	—	—	—	—

## 7.5 SDIO Pin Descriptions

**Table 10** shows the SDIO pin descriptions. **Figure** shows the SDIO modes.

**Table 10: SDIO Pin Descriptions**

No.	Pin Name	(i) SD 4-bit Mode	
55	SD_CLK	CLK	Clock
59	SD_D[0]	DATA0	Data line 0
61	SD_D[1]	DATA1	Data line 1 /Interrupt
63	SD_D[2]	DATA2	Data line 2
65	SD_D[3]	DATA3	Data line 3
57	SD_CMD	CMD	Command line

**Figure 5: SDIO Modes**

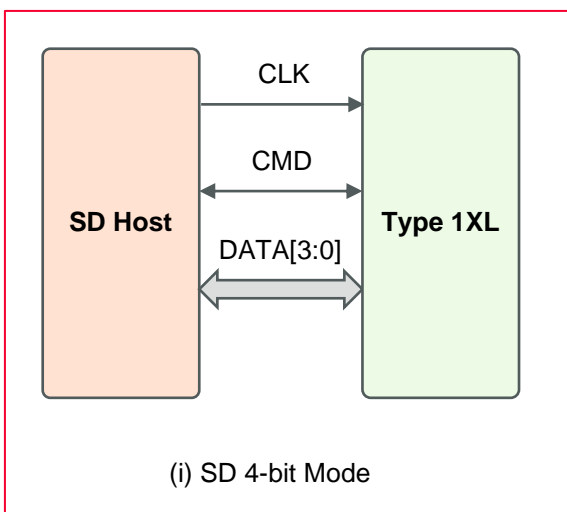

## 8 Absolute Maximum Ratings

Table 11 describes the absolute maximum ratings.

Table 11: Absolute Maximum Ratings

Parameter	Minimum	Maximum	Unit
Storage Temperature	-40	+85	°C
Supply Voltage	VDD33	3.63	V
	VDD18	2.16	V
	VIO (1.8V)	1.98	V
	VIO (3.3V)	3.63	V
	VIO_SD (1.8V)	1.98	V
	VIO_SD (3.3V)	3.63	V



Stresses in excess of the absolute ratings may cause permanent damage. Functional operation is not implied under these conditions. Exposure to absolute ratings for extended periods of time may adversely affect reliability. No damage assuming only one parameter is set at limit at a time with all other parameters are set within operating condition.

## 9 Operating Condition

### 9.1 Operating Condition

Type 1XL operating conditions are described in **Table 12**.

**Table 12: Operating Conditions**

Parameter		Minimum	Typical	Maximum	Unit	
Operating Temperature Range <sup>2</sup>	Ta	-40	+25	+60	°C	
	Tc	-40	+25	+85	°C	
Supply Voltage	VDD33	3.14	3.3	3.46	V	
	VDD18	1.71	1.8	1.89	V	
	VIO		1.71	1.8	1.89	V
			3.14	3.3	3.46	V
	VIO_SD		1.71	1.8	1.89	V
			3.14	3.3	3.46	V
IO Current	VIO & VIO_SD		0.1	0.5	mA	
Peak current	VDD33		1150	1200	mA	
	VDD18		1873	2000	mA	



Operation beyond the recommended operating conditions is neither recommended nor guaranteed. Peak current of VDD33 and VDD18 happen during DPD calibration when the firmware is downloaded.

### 9.2 Digital I/O Requirements

The digital I/O requirements are listed in **Table 13**.

**Table 13: Digital I/O Requirements Parameters**

Symbol	Parameter	Condition	Minimum	Typical	Maximum	Unit
V <sub>IH</sub>	Input high voltage		0.7 * VIO		VIO + 0.4	V
V <sub>IL</sub>	Input low voltage		-0.4		0.3 * VIO	V
V <sub>HYS</sub>	Input hysteresis		100			mV
V <sub>OH</sub>	Output high voltage		VIO - 0.4			V
V <sub>OL</sub>	Output low voltage				0.4	V

<sup>2</sup> Functionality is guaranteed but specifications require derating at extreme temperatures

## 10 Power Sequence

This section describes the power-on and power-off sequences.

### 10.1 Power-On Sequence

#### 10.1.1 Power-On Sequence for 3.3V

- Ramp-up time of VIO/VIO\_SD must be < 100 ms.
- Ramp-up time of VDD33 must be < 100 ms.
- Ramp-up time of VDD18 must be < 100 ms.

**Figure 6** shows the power-on sequence for VIO 3.3V.

**Figure 6: Power-On Sequence Graph for VIO 3.3V**

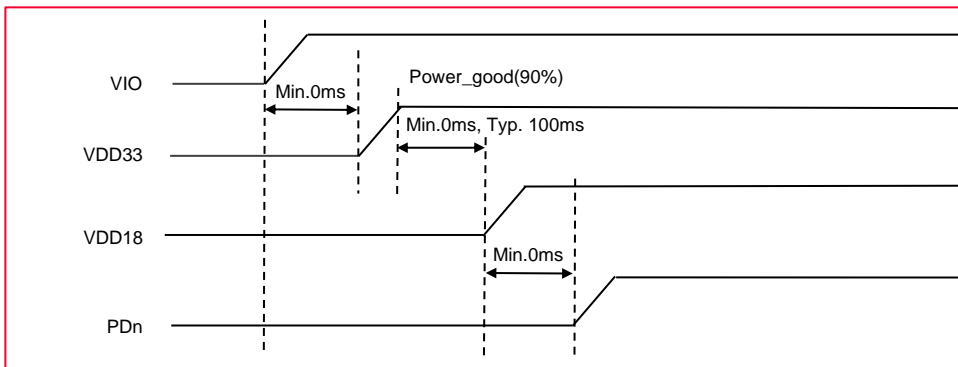

VIO\_SD should be ramp-up before PDn assertion.



## 10.1.2 Power-On Sequence for 1.8V

- Ramp-up time of VIO/VIO\_SD must be < 100 ms.
- Ramp-up time of VDD33 must be < 100 ms.
- Ramp-up time of VDD18 must be < 100 ms.

**Figure 7** shows the power-on sequence for VIO 1.8V.

**Figure 7: Power-On Sequence Graph for VIO 1.8V**

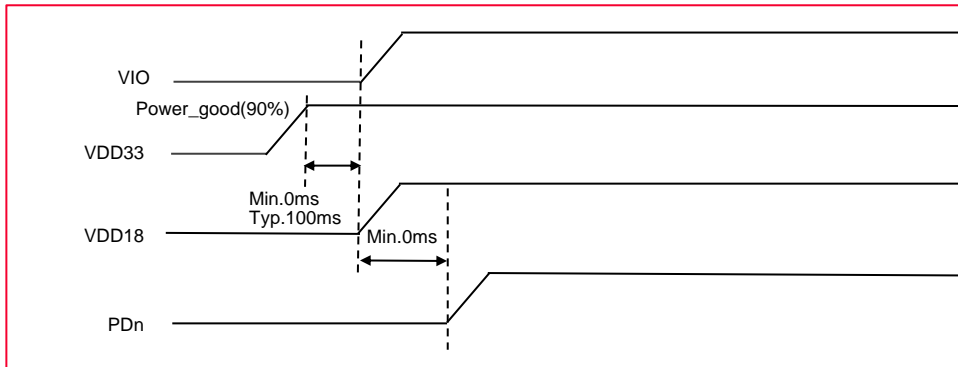

VIO\_SD should be ramp-up before PDn assertion.

VIO should be the same as VDD18 or earlier. The VIO can ramp up after power\_good state of VDD33. At that time the VDD18 can be the same or later than VIO.

## 10.2 Power-Off Sequence

Figure 8 shows the power-off sequence graph.

Figure 8: Power-Off Sequence Graph

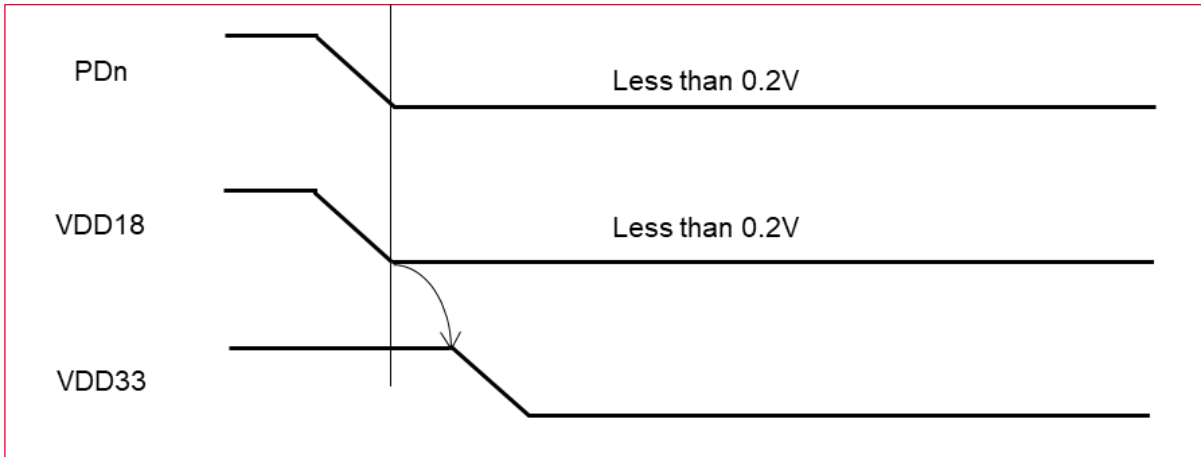

To reduce leakage, ramp down VDD18 before VDD33 when powering down the SoC.  
 Specific timing for VIO is not required for its power-down.  
 PDn must be discharged to less than 0.2 V before Power-On Reset (PDn) is triggered again.

## 11 Host Interface Specification

This section describes various SDIO specifications along with the SDIO timing data.

### 11.1 SDIO Specifications

- The SDIO host interface pins are powered from the VIO\_SD voltage supply.
- The SDIO electrical specifications are identical for 4-bit SDIO transfer modes.

### 11.1.1 Default Speed, High Speed Modes

Figure 9 shows the default speed mode.

Figure 9: SDIO Protocol Timing Diagram - Default Speed Mode (3.3V)

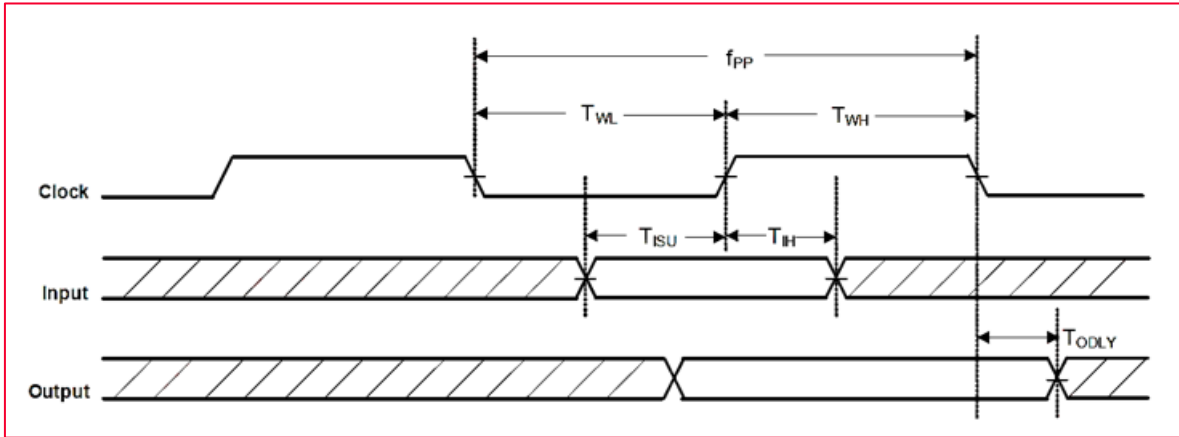

Figure 10 shows the high speed modes.

Figure 10: SDIO Protocol Timing Diagram - High Speed Mode (3.3V)

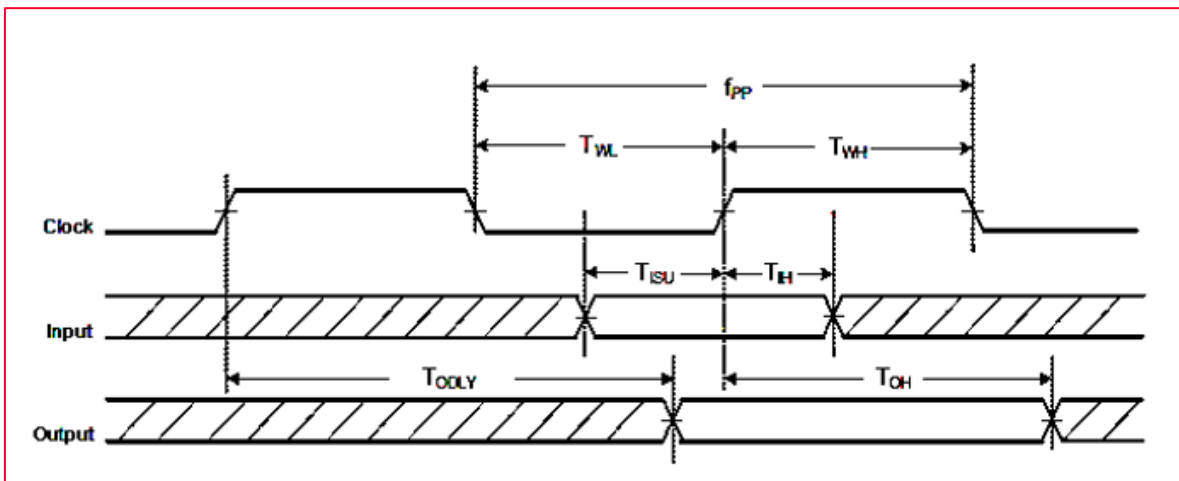

Table 14 shows the SDIO timing data at default and high speed modes.

Table 14: SDIO Timing Data - Default Speed, High Speed Modes (3.3V)

Symbol	Parameter	Condition	Minimum	Typical	Maximum	Unit
f <sub>PP</sub>	Clock frequency	Normal	0		25	MHz
		High speed	0		50	MHz
T <sub>WL</sub>	Clock low time	Normal	10			ns
		High speed	7			ns
T <sub>WH</sub>	Clock high time	Normal	10			ns
		High speed	7			ns
T <sub>ISU</sub>	Input setup time	Normal	5			ns
		High speed	6			ns

Symbol	Parameter	Condition	Minimum	Typical	Maximum	Unit
T <sub>IH</sub>	Input hold time	Normal	5			ns
		High speed	2			ns
T <sub>ODLY</sub>	Output delay time	Normal			14	ns
	CL ≤ 40 pF (1 card)	High speed			14	ns
T <sub>OH</sub>	Output hold time	High speed	2.5			ns



Over full range of values specified in the Recommended Operating Conditions unless otherwise specified.

### 11.1.2 SDR12, SDR25, SDR50 Modes up to 100 MHz (1.8V)

This section describes SDR12, SDR25, SDR50 modes up to 100 MHz (1.8V) along with the timing data. **Figure 11** shows the SDIO protocol timing diagram for SDR12, SDR25, SDR50 modes up to 100 MHz for 1.8V.

**Figure 11: SDIO Protocol Timing Diagram - SDR12, SDR25, SDR50 Modes**

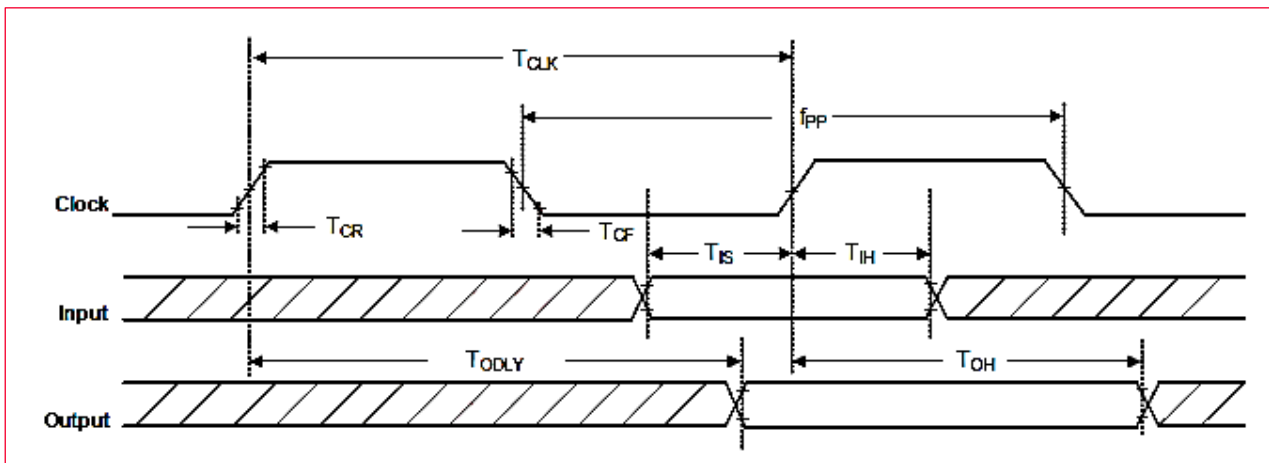

**Table 15** shows the SDIO timing data for SDR12, SDR25, SDR50 modes up to 100 MHz for 1.8V.

**Table 15: SDIO Timing Data - SDR12, SDR25, SDR50 Modes**

Symbol	Parameter	Condition	Minimum	Typical	Maximum	Unit
f <sub>PP</sub>	Clock frequency	SDR12/25/50	25		100	MHz
T <sub>IS</sub>	Input setup time	SDR12/25/50	3			ns
T <sub>IH</sub>	Input hold time	SDR12/25/50	0.8			ns
T <sub>CLK</sub>	Clock time	SDR12/25/50	10		40	ns
T <sub>CR</sub> , T <sub>CF</sub>	Rise time, fall time TCR, TCF < 2 ns (maximum) at 100 MHz CCARD = 10 pF	SDR12/25/50			0.2 * T <sub>CLK</sub>	ns
T <sub>ODLY</sub>	Output delay time CL ≤ 30 pF	SDR12/25/50			7.5	ns

T <sub>OH</sub>	Output hold time CL = 15 pF	SDR12/25/50	1.5			ns
-----------------	--------------------------------	-------------	-----	--	--	----



Over full range of values specified in the Recommended Operating Conditions unless otherwise specified.

### 11.1.3 SDR104 Mode at 208 MHz (1.8V)

Figure 12 shows the SDIO protocol timing diagram for SDR104 mode (208 MHz).

Figure 12: SDIO Protocol Timing Diagram - SDR104 Mode

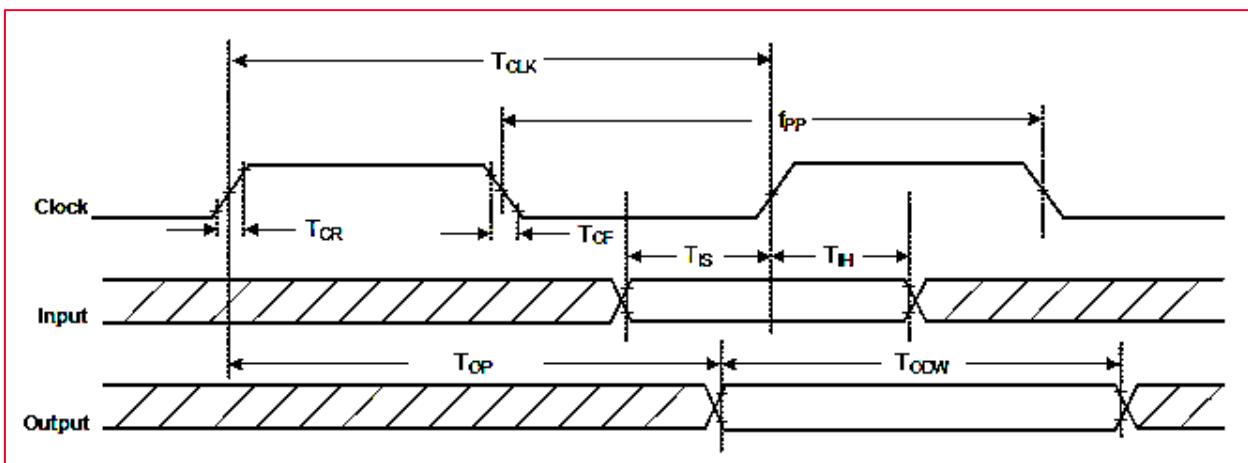

Table 16 shows the SDIO protocol timing data for SDR104 mode (208 MHz).

Table 16: SDIO Timing Data - SDR104 Mode

Symbol	Parameter	Condition	Minimum	Typical	Maximum	Unit
f <sub>PP</sub>	Clock frequency	SDR104	0		208	MHz
T <sub>IS</sub>	Input setup time	SDR104	1.4			ns
T <sub>IH</sub>	Input hold time	SDR104	0.8			ns
T <sub>CLK</sub>	Clock time	SDR104	4.8			ns
T <sub>CR</sub> , T <sub>CF</sub>	Rise time, fall time TCR, TCF < 0.96 ns (maximum) at 208 MHz CCARD = 10 pF	SDR104			0.2 * T <sub>CLK</sub>	ns
T <sub>OP</sub>	Card output phase	SDR104	0		10	ns
T <sub>ODW</sub>	Output timing of variable data window	SDR104	2.88			ns



Over full range of values specified in the Recommended Operating Conditions unless otherwise specified.

### 11.1.4 DDR50 Mode at 50 MHz

Figure 13 shows SDIO CMD timing diagram for DDR50 mode at 50 MHz.

Figure 13: SDIO CMD Timing Diagram - DDR50 Mode

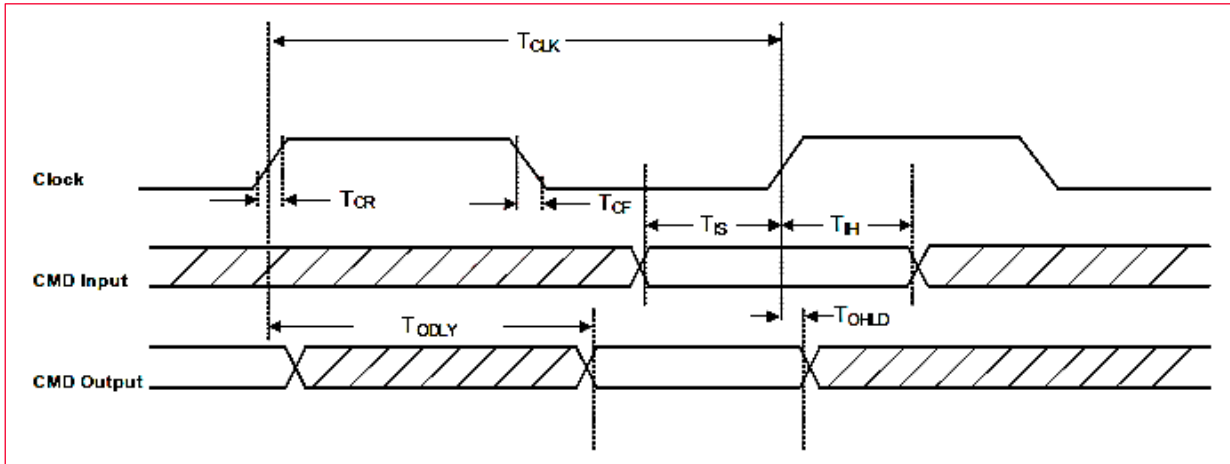
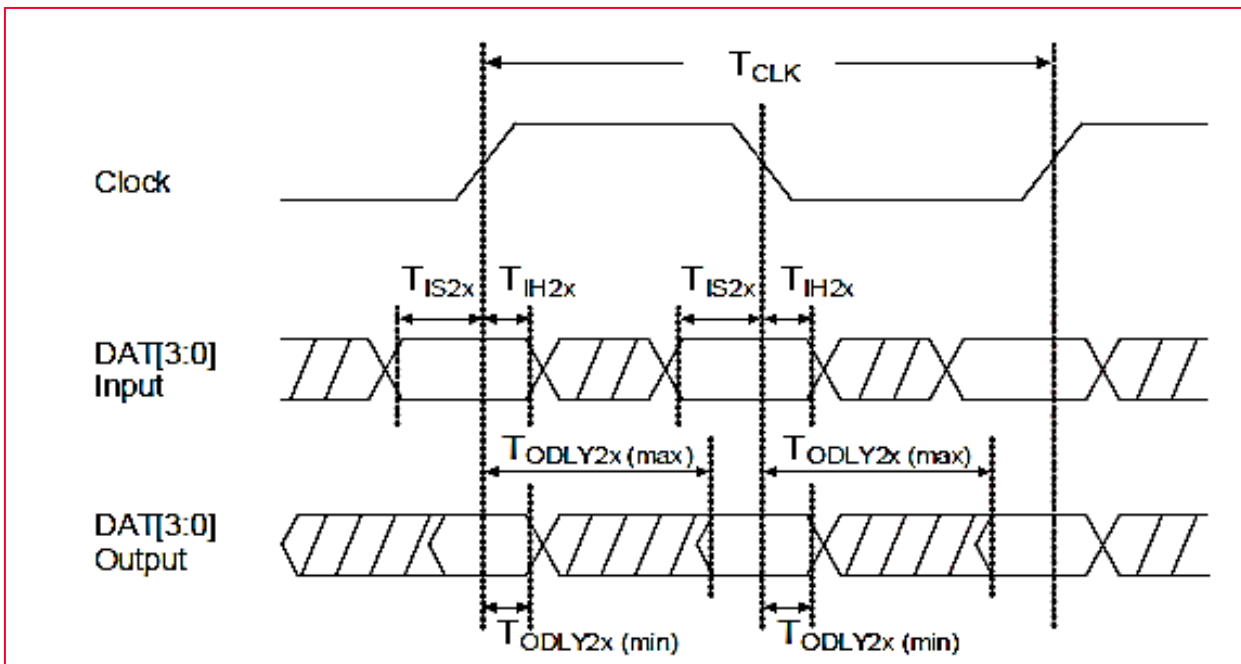

Figure 14 SDIO DAT[3:0] timing diagram for DDR50 mode at 50 MHz.

Figure 14: SDIO DAT[3:0] Timing Diagram - DDR50 Mode



Over full range of values specified in the Recommended Operating Conditions unless otherwise specified.

Table 17 describes the SDIO timing data.

Table 17: SDIO Timing Data - DDR50 Mode

Symbol	Parameter	Condition	Minimum	Typical	Maximum	Unit
<b>Clock</b>						
T <sub>CLK</sub>	Clock time 50 MHz (maximum) between rising edges	DDR50	20			ns
T <sub>CR</sub> , T <sub>CF</sub>	Rise time, fall time T <sub>CR</sub> , T <sub>CF</sub> < 4.00 ns (maximum) at 50 MHz C <sub>CARD</sub> = 10 pF	DDR50			0.2 * T <sub>CLK</sub>	ns
Clock Duty		DDR50	45		55	%
<b>CMD Input (referenced to clock rising edge)</b>						
T <sub>IS</sub>	Input setup time C <sub>CARD</sub> ≤ 10 pF (1 card)	DDR50	6			ns
T <sub>IH</sub>	Input hold time C <sub>CARD</sub> ≤ 10 pF (1 card)	DDR50	0.8			ns
<b>CMD Output (referenced to clock rising edge)</b>						
T <sub>ODLY</sub>	Output delay time during data transfer mode C <sub>L</sub> ≤ 30 pF (1 card)	DDR50			13.7	ns
T <sub>OHLd</sub>	Output hold time C <sub>L</sub> ≥ 15 pF (1 card)	DDR50	1.5			ns
<b>DAT[3:0] Input (referenced to clock rising and falling edges)</b>						
T <sub>IS2x</sub>	Input setup time C <sub>CARD</sub> ≤ 10 pF (1 card)	DDR50	3			ns
T <sub>IH2x</sub>	Input hold time C <sub>CARD</sub> ≤ 10 pF (1 card)	DDR50	0.8			ns
<b>DAT[3:0] Output (referenced to clock rising and falling edges)</b>						
T <sub>ODLY2x (max)</sub>	Output delay time during data transfer mode C <sub>L</sub> ≤ 25 pF (1 card)	DDR50			7.0	ns
T <sub>ODLY2x (min)</sub>	Output hold time C <sub>L</sub> ≥ 15 pF (1 card)	DDR50	1.5			ns



Over full range of values specified in the Recommended Operating Conditions unless otherwise specified.

## 11.2 PCI Express Specifications

The PCI express host interface pins are powered from the AVDD18 voltage supply.

### 11.2.1 Differential Tx Output Electricals

This section describes the PCI express Tx output specifications data for 2.5 GT/s and 5 GT/s.



In accordance with PCI Express Base Specification, Revision 2.1 March 4, 2009.

**Table 18:** PCI Express Tx Output Specifications Data - 2.5 GT/s describes PCI express Tx output specifications data for 2.5 GT/s.

**Table 18: PCI Express Tx Output Specifications Data - 2.5 GT/s**

Symbol	Parameter	Minimum	Typical	Maximum	Unit
UI	Unit Interval (UI) The specified UI is equivalent to a tolerance of $\pm 300$ ppm for each Refclk source. Period does not account for SSC induced variations.	399.88		400.12	ps
V <sub>TX-DIFF-PP</sub>	Differential peak-to-peak Tx voltage swing $V_{TX-DIFFPP} = 2 *  V_{TXD+} - V_{TXD-} $	0.8		1.2	V
V <sub>TX-DIFF-PP-LOW</sub>	Low power differential peak-to-peak Tx voltage swing $V_{TX-DIFFPP} = 2 *  V_{TXD+} - V_{TXD-} $	0.4		1.2	V
V <sub>TX-DE-RATIO-3.5dB</sub>	Tx de-emphasis level ratio (3.5 dB)	3.0		4.0	dB
T <sub>TX-EYE</sub>	Tx eye including all jitter sources	0.75			UI
T <sub>TX-EYE-MEDIAN-to-MAX-JITTER</sub>	Maximum time between jitter median and maximum deviation from median.	-		0.125	UI
T <sub>TX-RISE-FALL</sub>	Tx rise/fall time Measured differentially from 20% to 80% of swing.	0.125			UI
R <sub>LTX-DIFF</sub>	Tx package plus Si differential return loss	10			dB
R <sub>LTX-CM</sub>	Tx package plus Si common mode return loss	6			dB
V <sub>TX-CM-AC-P</sub>	Tx AC common mode voltage		20		mV
I <sub>TX-SHORT</sub>	Tx short circuit current limit			90	mA
V <sub>TX-DC-CM</sub>	Tx DC common mode voltage	0		3.6	V
V <sub>TX-CM-DC-ACTIVE-IDLE-DELTA</sub>	Absolute delta of DC common mode voltage during L0 and electrical idle	0		100	mV
V <sub>TX-IDLE-DIFF-AC-P</sub>	Electrical idle differential peak output voltage	0		20	mV
V <sub>TX-RCV-DETECT</sub>	Voltage change allowed during receiver detection			600	mV
T <sub>TX-IDLE-MIN</sub>	Minimum time spent in electrical idle	20			ns
T <sub>TX-IDLE-SET-TO-IDLE</sub>	Maximum time to transition to a valid electrical idle after sending an electrical idle ordered set			8	ns
T <sub>TX-IDLE-TO-DIFF-DATA</sub>	Maximum time to transition to valid diff signaling after leaving electrical idle			8	ns



Symbol	Parameter	Minimum	Typical	Maximum	Unit
T <sub>CROSSLINK</sub>	Crosslink random timeout			1.0	ms
C <sub>TX</sub>	AC coupling capacitor	75		200	nF

**Table 19:** PCI Express Tx Output Specifications Data - 5 GT/s describes PCI express Tx output specifications data for 5 GT/s.



In accordance with PCI Express Base Specification, Revision 2.1 March 4, 2009.

**Table 19: PCI Express Tx Output Specifications Data - 5 GT/s**

Symbol	Parameter	Minimum	Typical	Maximum	Unit
UI	Unit Interval (UI) The specified UI is equivalent to a tolerance of $\pm 300$ ppm for each Refclk source. Period does not account for SSC induced variations.	199.94		200.06	ps
V <sub>TX-DIFFpp</sub>	Differential peak-to-peak Tx voltage swing $V_{TX-DIFFpp} = 2 *  V_{TXD+} - V_{TXD-} $	0.8		1.2	V
V <sub>TX-DIFFpp-LOW</sub>	Low power differential peak-to-peak Tx voltage swing $V_{TX-DIFFpp} = 2 *  V_{TXD+} - V_{TXD-} $	0.4		1.2	V
V <sub>TX-DE-RATIO-3.5dB</sub>	Tx de-emphasis level ratio (3.5 dB)	3.0		4.0	dB
V <sub>TX-DE-RATIO-6dB</sub>	Tx de-emphasis level ratio (6 dB)	5.5		6.5	dB
T <sub>MIN-PULSE</sub>	Instantaneous lone pulse width Measured relative to rising/falling pulse.	0.9			UI
T <sub>TX-EYE</sub>	Tx eye including all jitter sources	0.75			UI
T <sub>TX-HF-DJ-DD</sub>	Tx deterministic jitter > 1.5 MHz Deterministic jitter only.			0.15	UI
T <sub>TX-LF-RMS</sub>	Tx RMS jitter < 1.5 MHz Total energy measured over a 10 kHz - 1.5 MHz range.		3.0		Ps RMS
T <sub>TX-RISE-FALL</sub>	Tx rise/fall time Measured differentially from 20% to 80% of swing.	0.15			UI
RL <sub>TX-DIFF</sub>	Tx package plus Si differential return loss (1.25-2.5 GHz)	10			dB
	Tx package plus Si differential return loss (0.05-1.25 GHz)	8			
RL <sub>TX-CM</sub>	Tx package plus Si common mode return loss	6			dB

Symbol	Parameter	Minimum	Typical	Maximum	Unit
V <sub>TX-CM-AC-PP</sub>	Tx AC common mode voltage			100	mVPP
I <sub>TX-SHORT</sub>	Tx short circuit current limit			90	mA
V <sub>TX-DC-CM</sub>	Tx DC common mode voltage	0		3.6	V
V <sub>TX-CM-DC-ACTIVE-IDLE-DELTA</sub>	Absolute delta of DC common mode voltage during L0 and electrical idle	0		100	mV
V <sub>TX-IDLE-DIFF-AC-p</sub>	Electrical idle differential peak output voltage $V_{TX-IDLE-DIFF-DC} =  V_{TX-Idle-D+} - V_{TX-Idle-D-}  \leq 20 \text{ mV}$	0		20	mV
V <sub>TX-IDLE-DIFF-DC</sub>	DC Electrical idle differential peak output voltage $V_{TX-IDLE-DIFF-DC} =  V_{TX-Idle-D+} - V_{TX-Idle-D-}  \leq 5 \text{ mV}$	0		5	mV
V <sub>TX-RCV-DETECT</sub>	Voltage change allowed during receiver detection			600	mV
T <sub>TX-IDLE-MIN</sub>	Minimum time spent in electrical idle	20			ns
T <sub>TX-IDLE-SET-TO-IDLE</sub>	Maximum time to transition to a valid electrical idle after sending an electrical idle ordered set.			8	ns
T <sub>TX-IDLE-TO-DIFF-DATA</sub>	Maximum time to transition to valid differential signaling after leaving electrical idle.			8	ns
T <sub>CROSSLINK</sub>	Crosslink random timeout			1.0	ms
C <sub>TX</sub>	AC coupling capacitor	75		200	nF

## 11.2.2 Differential Rx Input Electricals

This section describes the PCI express Rx input specifications data for 2.5 GT/s and 5 GT/s.



This is in accordance with PCI Express Base Specification, Revision 2.1 March 4, 2009.

**Table 20** describes the PCI express Rx input specifications data for 2.5 GT/s.

**Table 20: PCI Express Rx Input Specifications Data - 2.5 GT/s**

Symbol	Parameter	Minimum	Typical	Maximum	Unit
UI	Unit Interval (UI) UI does not account for SSC induced variations.	399.88		400.12	ps
V <sub>RX-DIFF-PP-CC</sub>	Differential Rx peak-to-peak voltage for common Refclk Rx architecture	0.175		1.2	V
V <sub>RX-DIFF-PP-DC</sub>	Differential Rx peak-to-peak voltage for data clocked Rx architecture	0.175		1.2	V
T <sub>RX-EYE</sub>	Rx eye time opening. Minimum eye time at Rx pins to yield a 10 <sup>-12</sup> BER	0.40			UI
T <sub>RX-EYE-MEDIAN-to-MAX-JITTER</sub>	Maximum time delta between median and deviation from median			0.3	UI
V <sub>RX-CM-ACp</sub>	AC peak common mode input voltage			150	mV
RL <sub>RX-DIFF</sub>	Differential return loss	15			dB
RL <sub>RX-CM</sub>	Common mode return loss	0		3.6	dB
Z <sub>RX-DIFF-DC</sub>	DC differential input impedance	80	100	120	W
Z <sub>RX-DC</sub>	DC input impedance	40	50	60	W
Z <sub>RX-HIGH-IMP-DC</sub>	Powered down DC input impedance	200			kΩ
V <sub>RX-IDLE-DET-DIFF-p-p</sub>	Electrical idle detect threshold	65		175	mV
T <sub>RX-IDLE-DET-DIFF-ENTERTIME</sub>	Unexpected electrical idle enter detect threshold integration time			10	ms
L <sub>RX-SKEW</sub>	Total skew			20	ns

**Table 21:** PCI Express Rx Input Specifications Data - 5 GT/s describes the PCI express Rx input specifications data for 5 GT/s.



In accordance with PCI Express Base Specification, Revision 2.1 March 4, 2009.

**Table 21: PCI Express Rx Input Specifications Data - 5 GT/s**

Symbol	Parameter	Minimum	Typical	Maximum	Unit
UI	Unit Interval (UI) UI does not account for SSC induced variations.	199.94		200.06	ps
V <sub>RX-DIFF-PP-CC</sub>	Differential Rx peak-to-peak voltage for common Refclk Rx architecture	0.120		1.2	V
V <sub>RX-DIFF-PP-DC</sub>	Differential Rx peak-to-peak voltage for data clocked Rx architecture	0.100		1.2	V
T <sub>RX-TJ-CC</sub>	Maximum Rx inherent total timing error for common Refclk Rx architecture			0.40	UI
T <sub>RX-TJ-DC</sub>	Maximum Rx inherent total timing error for data clocked Rx architecture			0.34	UI
T <sub>RX-DJ-DD-CC</sub>	Maximum Rx inherent deterministic timing error for common Refclk Rx architecture			0.30	UI
T <sub>RX-DJ-DD-DC</sub>	Maximum Rx inherent deterministic timing error for data clocked Rx architecture			0.24	UI
T <sub>RX-MIN-PLISE</sub>	Minimum width pulse at Rx Measured to account for worst T <sub>j</sub> at 10 <sup>-12</sup> BER.	0.6			UI
V <sub>RX-CM-ACp</sub>	AC peak common mode input voltage			150	mV
R <sub>L</sub> <sub>RX-DIFF</sub>	Differential return loss	15			dB
R <sub>L</sub> <sub>RX-CM</sub>	Common mode return loss	0		3.6	dB
Z <sub>RX-DIFF-DC</sub>	DC differential input impedance	80	100	120	W
Z <sub>RX-DC</sub>	DC input impedance	40	50	60	W
Z <sub>RX-HIGH-IMP-DC</sub>	Powered down DC input impedance	200			kΩ
V <sub>RX-IDLE-DET-DIFF-p-p</sub>	Electrical idle detect threshold	65		175	mV
T <sub>RX-IDLE-DET-DIFF-ENTERTIME</sub>	Unexpected electrical idle enter detect threshold integration time			10	ms
L <sub>RX-SKEW</sub>	Total skew			20	ns

## 12 DC/RF Characteristics

ALL DC/RF characteristics are defined by the files listed in **Table 22**.

**Table 22: DC/RF Characteristic Files**

Characteristics	Filenames
WLAN Tx Power	txpower_US.bin, txpower_CA.bin, txpower_EU.bin, txpower_JP.bin
WLAN Regulatory Limit	db.txt
Energy Detect	ed_mac.bin
Bluetooth Power	bt_power_config_1.sh (Class 1)

**Figure 15** shows the burst current definition.

**Figure 15: Burst Current Definition**

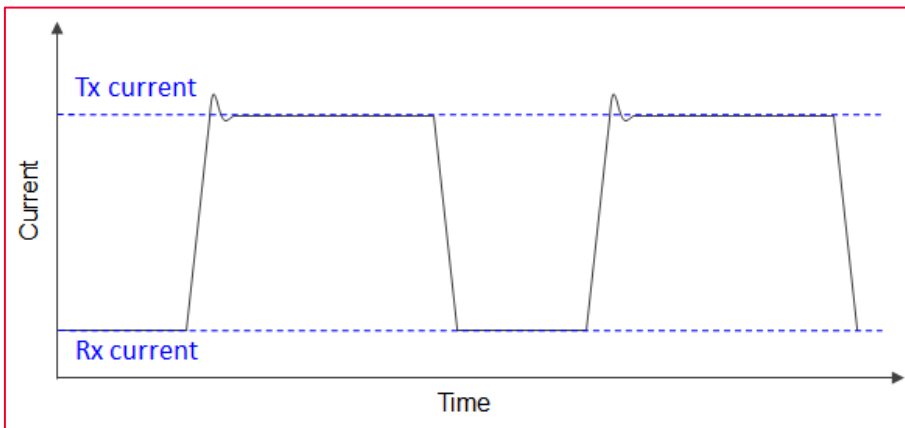

### 12.1 DC/RF Characteristics for IEEE 802.11b - 2.4 GHz

**Table 23: DC/RF Characteristics for IEEE 802.11b - 2.4 GHz**

Items	Contents
Specification	IEEE 802.11b
Mode	DSSS / CCK
Channel Frequency	2412 - 2472 MHz
Data rate	1, 2, 5.5, 11 Mbps

## 12.1.1 High-Rate Condition for IEEE 802.11b - 2.4 GHz

**Conditions:** 25 °C, VDD33 = 3.3V, VDD18 = 1.8V, VIO = 1.8V, Output power setting = 18 dBm, 11 Mbps mode

**Table 24: High-Rate Condition for IEEE 802.11b - 2.4 GHz**

Items		Contents			
DC Characteristics		Minimum	Typical	Maximum	Unit
DC current					
• Tx mode	VDD18		280		mA
	VDD33		220		mA
	VDD18 (MIMO)		370		mA
	VDD33 (MIMO)		450		mA
• Rx mode	VDD18		280		mA
	VDD33		0.2		mA
	VDD18 (MIMO)		300		mA
	VDD33 (MIMO)		0.2		mA
Tx Characteristics		Minimum	Typical	Maximum	Unit
Output Power		16	18	20	dBm
Spectrum Mask Margin					
• 1st side lobes		0			dB
• 2nd side lobes		0			dB
Power-on/off ramp				2.0	μs
RF Carrier Suppression		15		-	dB
Modulation Accuracy				35	%
Frequency Tolerance		-20		20	ppm
Spurious Emissions					
• 30 - 47 MHz (BW = 100 kHz)				-36	dBm
• 47 - 74 MHz (BW = 100 kHz)				-54	dBm
• 74 - 87.5 MHz (BW = 100 kHz)				-36	dBm
• 87.5 - 118 MHz (BW = 100 kHz)				-54	dBm
• 118 - 174 MHz (BW = 100 kHz)				-36	dBm
• 174 - 230 MHz (BW = 100 kHz)				-54	dBm
• 230 - 470 MHz (BW = 100 kHz)				-36	dBm
• 470 - 862 MHz (BW = 100 kHz)				-54	dBm
• 862 - 1000 MHz (BW = 100 kHz)				-36	dBm
• 1000 - 12750 MHz (BW = 1 MHz)				-30	dBm
Rx Characteristics		Minimum	Typical	Maximum	Unit
Minimum Input Level (FER ≤ 8%)				-76	dBm
Maximum Input Level (FER ≤ 8%)		-10			dBm
Adjacent Channel Rejection (FER < 8%)		35			dB

## 12.1.2 Low-Rate Condition for IEEE 802.11b - 2.4 GHz

**Conditions:** 25 °C, VDD33 = 3.3V, VDD18 = 1.8V VIO = 1.8V, Output power setting = 18 dBm, 1 Mbps mode

**Table 25: Low-Rate Condition for IEEE 802.11b - 2.4 GHz**

Items		Contents			
DC Characteristics		Minimum	Typical	Maximum	Unit
DC current					
• Tx mode	VDD18		280		mA
	VDD33		210		mA
	VDD18 (MIMO)		370		mA
	VDD33 (MIMO)		450		mA
• Rx mode	VDD18		280		mA
	VDD33		0.2		mA
	VDD18 (MIMO)		300		mA
	VDD33 (MIMO)		0.2		mA
Tx Characteristics		Minimum	Typical	Maximum	Unit
Output Power		16	18	20	dBm
Spectrum Mask Margin					
• 1st side lobes		0			dB
• 2nd side lobes		0			dB
Power-on/off ramp				2.0	μs
RF Carrier Suppression		15			dB
Modulation Accuracy				35	%
Frequency Tolerance		-20		20	ppm
Spurious Emissions					
• 30 - 47 MHz (BW = 100 kHz)				-36	dBm
• 47 - 74 MHz (BW = 100 kHz)				-54	dBm
• 74 - 87.5 MHz (BW = 100 kHz)				-36	dBm
• 87.5 - 118 MHz (BW = 100 kHz)				-54	dBm
• 118 - 174 MHz (BW = 100 kHz)				-36	dBm
• 174 - 230 MHz (BW = 100 kHz)				-54	dBm
• 230 - 470 MHz (BW = 100 kHz)				-36	dBm
• 470 - 862 MHz (BW = 100 kHz)				-54	dBm
• 862 - 1000 MHz (BW = 100 kHz)				-36	dBm
• 1000 - 12750 MHz (BW = 1 MHz)				-30	dBm
Rx Characteristics		Minimum	Typical	Maximum	Unit
Minimum Input Level (FER ≤ 8%)				-80	dBm
Maximum Input Level (FER ≤ 8%)		-10			dBm
Adjacent Channel Rejection (FER < 8%)		35			dB

## 12.2 DC/RF Characteristics for IEEE 802.11g - 2.4 GHz

**Table 26: DC/RF Characteristics for IEEE 802.11g - 2.4 GHz**

Items	Contents
Specification	IEEE 802.11g
Mode	OFDM
Channel Frequency	2412 - 2472 MHz
Data rate	6, 9, 12, 18, 24, 36, 48, 54 Mbps

### 12.2.1 High-Rate Condition for IEEE 802.11g - 2.4 GHz

**Conditions:** 25 °C, VDD33 = 3.3V, VDD18 = 1.8V VIO = 1.8V, Output power setting = 16 dBm, 54 Mbps mode

**Table 27: High-Rate Condition for IEEE 802.11g - 2.4 GHz**

Items		Contents			
DC Characteristics		Minimum	Typical	Maximum	Unit
DC current					
• Tx mode	VDD18		300		mA
	VDD33		180		mA
	VDD18 (MIMO)		410		mA
	VDD33 (MIMO)		370		mA
• Rx mode	VDD18		280		mA
	VDD33		0.2		mA
	VDD18 (MIMO)		300		mA
	VDD33 (MIMO)		0.2		mA
Tx Characteristics		Minimum	Typical	Maximum	Unit
Output Power		14	16	18	dBm
Spectrum Mask Margin					
• 9 MHz to 11 MHz (0 ~ -20 dBr)		0			dB
• 11 MHz to 20 MHz (-20 ~ -28 dBr)		0			dB
• 20 MHz to 30 MHz (-28 ~ -40 dBr)		0			dB
• 30 MHz to 33 MHz (-40 dBr)		0			dB
Constellation Error (EVM)				-25	dB
Frequency Tolerance		-20		20	ppm
Spurious Emissions					
• 30 - 47 MHz (BW = 100 kHz)				-36	dBm
• 47 - 74 MHz (BW = 100 kHz)				-54	dBm
• 74 - 87.5 MHz (BW = 100 kHz)				-36	dBm
• 87.5 - 118 MHz (BW = 100 kHz)				-54	dBm
• 118 - 174 MHz (BW = 100 kHz)				-36	dBm
• 174 - 230 MHz (BW = 100 kHz)				-54	dBm
• 230 - 470 MHz (BW = 100 kHz)				-36	dBm
• 470 - 862 MHz (BW = 100 kHz)				-54	dBm
• 862 - 1000 MHz (BW = 100 kHz)				-36	dBm
• 1000 - 12750 MHz (BW = 1 MHz)				-30	dBm
Rx Characteristics		Minimum	Typical	Maximum	Unit



Items	Contents			
Minimum Input Level (PER < 10%)			-65	dBm
Maximum Input Level (PER < 10%)	-20			dBm
Adjacent Channel Rejection (PER < 10%)	-1			dB

## 12.2.2 Low-Rate Condition for IEEE 802.11g - 2.4 GHz

**Conditions:** 25 °C, VDD33 = 3.3V, VDD18 = 1.8V VIO = 1.8V, Output power setting = 17 dBm, 6 Mbps mode

**Table 28: Low-Rate Condition for IEEE 802.11g - 2.4 GHz**

Items		Contents			
DC Characteristics		Minimum	Typical	Maximum	Unit
DC current					
• Tx mode	VDD18		300		mA
	VDD33		200		mA
	VDD18 (MIMO)		410		mA
	VDD33 (MIMO)		420		mA
• Rx mode	VDD18		280		mA
	VDD33		0.2		mA
	VDD18 (MIMO)		300		mA
	VDD33 (MIMO)		0.2		mA
Tx Characteristics		Minimum	Typical	Maximum	Unit
Output Power		15	17	19	dBm
Spectrum Mask Margin					
•	9 MHz to 11 MHz (0 ~ -20 dBr)	0			dB
•	11 MHz to 20 MHz (-20 ~ -28 dBr)	0			dB
•	20 MHz to 30 MHz (-28 ~ -40 dBr)	0			dB
•	30 MHz to 33 MHz (-40 dBr)	0			dB
Constellation Error (EVM)				-25	dB
Frequency Tolerance		-20		20	ppm
Spurious Emissions					
•	30 - 47 MHz (BW = 100 kHz)			-36	dBm
•	47 - 74 MHz (BW = 100 kHz)			-54	dBm
•	74 - 87.5 MHz (BW = 100 kHz)			-36	dBm
•	87.5 - 118 MHz (BW = 100 kHz)			-54	dBm
•	118 - 174 MHz (BW = 100 kHz)			-36	dBm
•	174 - 230 MHz (BW = 100 kHz)			-54	dBm
•	230 - 470 MHz (BW = 100 kHz)			-36	dBm
•	470 - 862 MHz (BW = 100 kHz)			-54	dBm
•	862 - 1000 MHz (BW = 100 kHz)			-36	dBm
•	1000 - 12750 MHz (BW = 1 MHz)			-30	dBm
Rx Characteristics		Minimum	Typical	Maximum	Unit
Minimum Input Level (PER < 10%)				-82	dBm
Maximum Input Level (PER < 10%)		-20			dBm
Adjacent Channel Rejection (PER < 10%)		-1			dB

## 12.3 DC/RF Characteristics for IEEE 802.11n - 2.4 GHz

**Table 29: DC/RF Characteristics for IEEE 802.11n - 2.4 GHz**

Items	Contents
Specification	IEEE 802.11n
Mode	OFDM
Channel Frequency	2412 - 2472 MHz
Data rate	MCS0 - MCS7

### 12.3.1 High-Rate Condition for IEEE 802.11n - 2.4 GHz

**Conditions:** 25 °C, VDD33 = 3.3V, VDD18 = 1.8V VIO = 1.8V, Output power setting = 15 dBm, MCS7 mode

**Table 30: High-Rate Condition for IEEE 802.11n - 2.4 GHz**

Items		Contents			
DC Characteristics		Minimum	Typical	Maximum	Unit
DC current					
• Tx mode	VDD18		300		mA
	VDD33		170		mA
	VDD18 (MIMO)		410		mA
	VDD33 (MIMO)		330		mA
• Rx mode	VDD18		280		mA
	VDD33		0.2		mA
	VDD18 (MIMO)		300		mA
	VDD33 (MIMO)		0.2		mA
Tx Characteristics		Minimum	Typical	Maximum	Unit
Output Power		13	15	17	dBm
Spectrum Mask Margin					
•	9 MHz to 11 MHz (0 ~ -20 dBr)	0			dB
•	11 MHz to 20 MHz (-20 ~ -28 dBr)	0			dB
•	20 MHz to 30 MHz (-28 ~ -45 dBr)	0			dB
•	30 MHz to 33 MHz (-45 dBr)	0			dB
Constellation Error (EVM) (Measured at enhanced mode)				-27	dB
Frequency Tolerance		-20		20	ppm
Spurious Emissions					
•	30 - 47 MHz (BW = 100 kHz)			-36	dBm
•	47 - 74 MHz (BW = 100 kHz)			-54	dBm
•	74 - 87.5 MHz (BW = 100 kHz)			-36	dBm
•	87.5 - 118 MHz (BW = 100 kHz)			-54	dBm
•	118 - 174 MHz (BW = 100 kHz)			-36	dBm
•	174 - 230 MHz (BW = 100 kHz)			-54	dBm
•	230 - 470 MHz (BW = 100 kHz)			-36	dBm
•	470 - 862 MHz (BW = 100 kHz)			-54	dBm
•	862 - 1000 MHz (BW = 100 kHz)			-36	dBm
•	1000 - 12750 MHz (BW = 1 MHz)			-30	dBm
Rx Characteristics		Minimum	Typical	Maximum	Unit

Items	Contents			
Minimum Input Level (PER ≤ 10%)			-64	dBm
Maximum Input Level (PER < 10%)	-20			dBm
Adjacent Channel Rejection (PER ≤ 10%)	-2			dB

### 12.3.2 Low-Rate Condition for IEEE 802.11n - 2.4 GHz

**Conditions:** 25 °C, VDD33 = 3.3V, VDD18 = 1.8V VIO = 1.8V, Output power setting = 16 dBm, MCS0 mode

**Table 31: Low-Rate Condition for IEEE 802.11n - 2.4 GHz**

Items		Contents			
DC Characteristics		Minimum	Typical	Maximum	Unit
DC current					
• Tx mode	VDD18		300		mA
	VDD33		190		mA
	VDD18 (MIMO)		410		mA
	VDD33 (MIMO)		380		mA
• Rx mode	VDD18		280		mA
	VDD33		0.2		mA
	VDD18 (MIMO)		300		mA
	VDD33 (MIMO)		0.2		mA
Tx Characteristics		Minimum	Typical	Maximum	Unit
Output Power		14	16	18	dBm
Spectrum Mask Margin					
• 9 MHz to 11 MHz (0 ~ -20 dBr)		0			dB
• 11 MHz to 20 MHz (-20 ~ -28 dBr)		0			dB
• 20 MHz to 30 MHz (-28 ~ -45 dBr)		0			dB
• 30 MHz to 33 MHz (-45 dBr)		0			dB
Constellation Error (EVM) (Measured at enhanced mode)				-27	dB
Frequency Tolerance		-20		20	ppm
Spurious Emissions					
• 30 - 47 MHz (BW = 100 kHz)				-36	dBm
• 47 - 74 MHz (BW = 100 kHz)				-54	dBm
• 74 - 87.5 MHz (BW = 100 kHz)				-36	dBm
• 87.5 - 118 MHz (BW = 100 kHz)				-54	dBm
• 118 - 174 MHz (BW = 100 kHz)				-36	dBm
• 174 - 230 MHz (BW = 100 kHz)				-54	dBm
• 230 - 470 MHz (BW = 100 kHz)				-36	dBm
• 470 - 862 MHz (BW = 100 kHz)				-54	dBm
• 862 - 1000 MHz (BW = 100 kHz)				-36	dBm
• 1000 - 12750 MHz (BW = 1 MHz)				-30	dBm
Rx Characteristics		Minimum	Typical	Maximum	Unit
Minimum Input Level (PER ≤ 10%)				-82	dBm
Maximum Input Level (PER < 10%)		-20			dBm
Adjacent Channel Rejection (PER ≤ 10%)		-2			dB

## 12.4 DC/RF Characteristics for IEEE 802.11ax - 2.4 GHz

**Table 32: DC/RF Characteristics for IEEE 802.11ax - 2.4 GHz**

Items	Contents
Specification	IEEE 802.11ax
Mode	OFDM
Channel Frequency	2412 - 2472 MHz
Data rate	MCS0 - MCS11

### 12.4.1 High-Rate Condition for IEEE 802.11ax - 2.4 GHz

**Conditions:** 25 °C, VDD33 = 3.3V, VDD18 = 1.8V VIO = 1.8V, Output power setting = 13 dBm, MCS11 mode

**Table 33: High-Rate Condition for IEEE 802.11ax - 2.4 GHz**

Items		Contents			
DC Characteristics		Minimum	Typical	Maximum	Unit
DC current					
• Tx mode	VDD18		300		mA
	VDD33		150		mA
	VDD18 (MIMO)		410		mA
	VDD33 (MIMO)		300		mA
• Rx mode	VDD18		280		mA
	VDD33		0.2		mA
	VDD18 (MIMO)		300		mA
	VDD33 (MIMO)		0.2		mA
Tx Characteristics		Minimum	Typical	Maximum	Unit
Output Power		11	13	15	dBm
Spectrum Mask Margin					
• 9 MHz to 11 MHz (0 ~ -20 dBr)		0			dB
• 11 MHz to 20 MHz (-20 ~ -28 dBr)		0			dB
• 20 MHz to 30 MHz (-28 ~ -45 dBr)		0			dB
• 30 MHz to 33 MHz (-45 dBr)		0			dB
Constellation Error (EVM) (Measured at enhanced mode)				-35	dB
Frequency Tolerance		-20		20	ppm
Spurious Emissions					
• 30 - 47 MHz (BW = 100 kHz)				-36	dBm
• 47 - 74 MHz (BW = 100 kHz)				-54	dBm
• 74 - 87.5 MHz (BW = 100 kHz)				-36	dBm
• 87.5 - 118 MHz (BW = 100 kHz)				-54	dBm
• 118 - 174 MHz (BW = 100 kHz)				-36	dBm
• 174 - 230 MHz (BW = 100 kHz)				-54	dBm
• 230 - 470 MHz (BW = 100 kHz)				-36	dBm
• 470 - 862 MHz (BW = 100 kHz)				-54	dBm
• 862 - 1000 MHz (BW = 100 kHz)				-36	dBm
• 1000 - 12750 MHz (BW = 1 MHz)				-30	dBm
Rx Characteristics		Minimum	Typical	Maximum	Unit

Items	Contents			
Minimum Input Level (PER ≤ 10%)			-69	dBm
Maximum Input Level (PER < 10%)	-20			dBm
Adjacent Channel Rejection (PER ≤ 10%)	-2			dB

## 12.4.2 Low-Rate Condition for IEEE 802.11ax - 2.4 GHz

**Conditions:** 25 °C, VDD33 = 3.3V, VDD18 = 1.8V VIO = 1.8V, Output power setting = 16 dBm, MCS0 mode

**Table 34: Low-Rate Condition for IEEE 802.11ax - 2.4 GHz**

Items		Contents			
DC Characteristics		Minimum	Typical	Maximum	Unit
DC current					
• Tx mode	VDD18		300		mA
	VDD33		190		mA
	VDD18 (MIMO)		420		mA
	VDD33 (MIMO)		390		mA
• Rx mode	VDD18		280		mA
	VDD33		0.2		mA
	VDD18 (MIMO)		300		mA
	VDD33 (MIMO)		0.2		mA
Tx Characteristics		Minimum	Typical	Maximum	Unit
Output Power		14	16	18	dBm
Spectrum Mask Margin					
•	9 MHz to 11 MHz (0 ~ -20 dBr)	0			dB
•	11 MHz to 20 MHz (-20 ~ -28 dBr)	0			dB
•	20 MHz to 30 MHz (-28 ~ -45 dBr)	0			dB
•	30 MHz to 33 MHz (-45 dBr)	0			dB
Constellation Error (EVM) (Measured at enhanced mode)				-19	dB
Frequency Tolerance		-20		20	ppm
Spurious Emissions					
•	30 - 47 MHz (BW = 100 kHz)			-36	dBm
•	47 - 74 MHz (BW = 100 kHz)			-54	dBm
•	74 - 87.5 MHz (BW = 100 kHz)			-36	dBm
•	87.5 - 118 MHz (BW = 100 kHz)			-54	dBm
•	118 - 174 MHz (BW = 100 kHz)			-36	dBm
•	174 - 230 MHz (BW = 100 kHz)			-54	dBm
•	230 - 470 MHz (BW = 100 kHz)			-36	dBm
•	470 - 862 MHz (BW = 100 kHz)			-54	dBm
•	862 - 1000 MHz (BW = 100 kHz)			-36	dBm
•	1000 - 12750 MHz (BW = 1 MHz)			-30	dBm
Rx Characteristics		Minimum	Typical	Maximum	Unit
Minimum Input Level (PER ≤ 10%)				-69	dBm
Maximum Input Level (PER < 10%)		-20			dBm
Adjacent Channel Rejection (PER ≤ 10%)		-2			dB

## 12.5 DC/RF Characteristics for IEEE 802.11a - 5 GHz

**Table 35: DC/RF Characteristics for IEEE 802.11a - 5 GHz**

Items	Contents
Specification	IEEE 802.11a
Mode	OFDM
Channel Frequency	5180 to 5240 MHz 5260 to 5320 MHz, 5500 to 5720 MHz 5745 to 5825 MHz
Data rate	6, 9, 12, 18, 24, 36, 48, 54 Mbps

### 12.5.1 High-Rate Condition for IEEE 802.11a - 5 GHz

**Conditions:** 25 °C, VDD33 = 3.3V, VDD18 = 1.8V VIO = 1.8V, Output power setting = 16 dBm, 54 Mbps mode

**Table 36: High-Rate Condition for IEEE 802.11a - 5 GHz**

Items		Contents			
DC Characteristics		Minimum	Typical	Maximum	Unit
DC current					
• Tx mode	VDD18		400		mA
	VDD33		230		mA
	VDD18 (MIMO)		620		mA
	VDD33 (MIMO)		460		mA
• Rx mode	VDD18		320		mA
	VDD33		0.2		mA
	VDD18 (MIMO)		320		mA
	VDD33 (MIMO)		0.2		mA
Tx Characteristics		Minimum	Typical	Maximum	Unit
Output Power		14	16	18	dBm
Spectrum Mask Margin					
• 9 MHz to 11 MHz (0 ~ -20 dBr)		0			dB
• 11 MHz to 20 MHz (-20 ~ -28 dBr)		0			dB
• 20 MHz to 30 MHz (-28 ~ -45 dBr)		0			dB
• 30 MHz to 33 MHz (-45 dBr)		0			dB
Constellation Error (EVM) (Measured at enhanced mode)				-25	dB
Frequency Tolerance		-20		20	ppm
Spurious Emissions					
• 30 - 47 MHz (BW = 100 kHz)				-36	dBm
• 47 - 74 MHz (BW = 100 kHz)				-54	dBm
• 74 - 87.5 MHz (BW = 100 kHz)				-36	dBm
• 87.5 - 118 MHz (BW = 100 kHz)				-54	dBm
• 118 - 174 MHz (BW = 100 kHz)				-36	dBm
• 174 - 230 MHz (BW = 100 kHz)				-54	dBm
• 230 - 470 MHz (BW = 100 kHz)				-36	dBm
• 470 - 862 MHz (BW = 100 kHz)				-54	dBm
• 862 - 1000 MHz (BW = 100 kHz)				-36	dBm

Items	Contents			
• 1000 - 5150 MHz (BW = 1 MHz)			-30	dBm
• 5350 - 5470 MHz (BW = 1 MHz)			-30	dBm
• 5725 - 26000 MHz (BW = 1 MHz)			-30	dBm
Rx Characteristics	Minimum	Typical	Maximum	Unit
Minimum Input Level (PER ≤ 10%)			-65	dBm
Maximum Input Level (PER < 10%)	-30			dBm
Adjacent Channel Rejection (PER ≤ 10%)	-1			dB

## 12.5.2 Low-Rate Condition for IEEE 802.11a - 5 GHz

**Conditions:** 25 °C, VDD33 = 3.3V, VDD18 = 1.8V VIO = 1.8V, Output power setting = 17 dBm, 6 Mbps mode

**Table 37: Low-Rate Condition for IEEE 802.11a - 5 GHz**

Items	Contents			
DC Characteristics	Minimum	Typical	Maximum	Unit
DC current				
• Tx mode	VDD18	430		mA
	VDD33	260		mA
	VDD18 (MIMO)	610		mA
	VDD33 (MIMO)	510		mA
• Rx mode	VDD18	320		mA
	VDD33	0.2		mA
	VDD18 (MIMO)	320		mA
	VDD33 (MIMO)	0.2		mA
Tx Characteristics	Minimum	Typical	Maximum	Unit
Output Power	15	17	19	dBm
Spectrum Mask Margin				
• 9 MHz to 11 MHz (0 ~ -20 dBr)	0			dB
• 11 MHz to 20 MHz (-20 ~ -28 dBr)	0			dB
• 20 MHz to 30 MHz (-28 ~ -45 dBr)	0			dB
• 30 MHz to 33 MHz (-45 dBr)	0			dB
Constellation Error (EVM) (Measured at enhanced mode)			-25	dB
Frequency Tolerance	-20		20	ppm
Spurious Emissions				
• 30 - 47 MHz (BW = 100 kHz)			-36	dBm
• 47 - 74 MHz (BW = 100 kHz)			-54	dBm
• 74 - 87.5 MHz (BW = 100 kHz)			-36	dBm
• 87.5 - 118 MHz (BW = 100 kHz)			-54	dBm
• 118 - 174 MHz (BW = 100 kHz)			-36	dBm
• 174 - 230 MHz (BW = 100 kHz)			-54	dBm
• 230 - 470 MHz (BW = 100 kHz)			-36	dBm
• 470 - 862 MHz (BW = 100 kHz)			-54	dBm
• 862 - 1000 MHz (BW = 100 kHz)			-36	dBm
• 1000 - 5150 MHz (BW = 1 MHz)			-30	dBm
• 5350 - 5470 MHz (BW = 1 MHz)			-30	dBm
• 5725 - 26000 MHz (BW = 1 MHz)			-30	dBm
- Rx Characteristics -	Minimum	Typical	Maximum	Unit

Items	Contents			
Minimum Input Level (PER ≤ 10%)			-82	dBm
Maximum Input Level (PER < 10%)	-30			dBm
Adjacent Channel Rejection (PER ≤ 10%)	-1			dB

## 12.6 DC/RF Characteristics for IEEE 802.11n (HT20) - 5 GHz

Table 38: DC/RF Characteristics for IEEE 802.11n(HT20) - 5 GHz

Items	Contents
Specification	IEEE 802.11n
Mode	OFDM
Channel Frequency	5180 to 5240 MHz 5260 to 5320 MHz 5500 to 5720 MHz 5745 to 5825 MHz
Data rate	MCS0 - MCS7

### 12.6.1 High-Rate Condition for IEEE 802.11n (HT20) - 5 GHz

**Conditions:** 25 °C, VDD33 = 3.3V, VDD18 = 1.8V VIO = 1.8V, Output power setting = 16 dBm, MCS7 mode

Table 39: High-Rate Condition for IEEE 802.11n (HT20) - 5 GHz

Items		Contents			
DC Characteristics		Minimum	Typical	Maximum	Unit
DC current					
• Tx mode	VDD18		400		mA
	VDD33		240		mA
	VDD18 (MIMO)		620		mA
	VDD33 (MIMO)		450		mA
• Rx mode	VDD18		320		mA
	VDD33		0.2		mA
	VDD18 (MIMO)		320		mA
	VDD33 (MIMO)		0.2		mA
Tx Characteristics		Minimum	Typical	Maximum	Unit
Output Power		14	16	18	dBm
Spectrum Mask Margin					
• 9 MHz to 11 MHz (0 ~ -20 dBr)		0			dB
• 11 MHz to 20 MHz (-20 ~ -28 dBr)		0			dB
• 20 MHz to 30 MHz (-28 ~ -45 dBr)		0			dB
• 30 MHz to 33 MHz (-45 dBr)		0			dB
Constellation Error (EVM) (Measured at enhanced mode)				-27	dB
Frequency Tolerance		-20		20	ppm
Spurious Emissions					
• 30 - 47 MHz (BW = 100 kHz)				-36	dBm



Items	Contents			
• 47 - 74 MHz (BW = 100 kHz)			-54	dBm
• 74 - 87.5 MHz (BW = 100 kHz)			-36	dBm
• 87.5 - 118 MHz (BW = 100 kHz)			-54	dBm
• 118 - 174 MHz (BW = 100 kHz)			-36	dBm
• 174 - 230 MHz (BW = 100 kHz)			-54	dBm
• 230 - 470 MHz (BW = 100 kHz)			-36	dBm
• 470 - 862 MHz (BW = 100 kHz)			-54	dBm
• 862 - 1000 MHz (BW = 100 kHz)			-36	dBm
• 1000 - 5150 MHz (BW = 1 MHz)			-30	dBm
• 5350 - 5470 MHz (BW = 1 MHz)			-30	dBm
• 5725 - 26000 MHz (BW = 1 MHz)			-30	dBm
Rx Characteristics	Minimum	Typical	Maximum	Unit
Minimum Input Level (PER ≤ 10%)			-64	dBm
Maximum Input Level (PER < 10%)	-30			dBm
Adjacent Channel Rejection (PER ≤ 10%)	-2			dB

## 12.6.2 Low-Rate Condition for IEEE 802.11n (HT20) - 5 GHz

**Conditions:** 25 °C, VDD33 = 3.3V, VDD18 = 1.8V VIO = 1.8V, Output power setting = 16 dBm, MCS0 mode

**Table 40: Low-Rate Condition for IEEE 802.11n (HT20) - 5 GHz**

Items	Contents			
DC Characteristics	Minimum	Typical	Maximum	Unit
DC current				
• Tx mode	VDD18	400		mA
	VDD33	250		mA
	VDD18 (MIMO)	630		mA
	VDD33 (MIMO)	470		mA
• Rx mode	VDD18	320		mA
	VDD33	0.2		mA
	VDD18 (MIMO)	320		mA
	VDD33 (MIMO)	0.2		mA
Tx Characteristics	Minimum	Typical	Maximum	Unit
Output Power	14	16	18	dBm
Spectrum Mask Margin				
• 9 MHz to 11 MHz (0 ~ -20 dBr)	0			dB
• 11 MHz to 20 MHz (-20 ~ -28 dBr)	0			dB
• 20 MHz to 30 MHz (-28 ~ -45 dBr)	0			dB
• 30 MHz to 33 MHz (-45 dBr)	0			dB
Constellation Error (EVM) (Measured at enhanced mode)			-27	dB
Frequency Tolerance	-20		20	ppm
Spurious Emissions				
• 30 - 47 MHz (BW = 100 kHz)			-36	dBm
• 47 - 74 MHz (BW = 100 kHz)			-54	dBm
• 74 - 87.5 MHz (BW = 100 kHz)			-36	dBm
• 87.5 - 118 MHz (BW = 100 kHz)			-54	dBm
• 118 - 174 MHz (BW = 100 kHz)			-36	dBm

Items	Contents			
• 174 - 230 MHz (BW = 100 kHz)			-54	dBm
• 230 - 470 MHz (BW = 100 kHz)			-36	dBm
• 470 - 862 MHz (BW = 100 kHz)			-54	dBm
• 862 - 1000 MHz (BW = 100 kHz)			-36	dBm
• 1000 - 5150 MHz (BW = 1 MHz)			-30	dBm
• 5350 - 5470 MHz (BW = 1 MHz)			-30	dBm
• 5725 - 26000 MHz (BW = 1 MHz)			-30	dBm
Rx Characteristics	Minimum	Typical	Maximum	Unit
Minimum Input Level (PER ≤ 10%)			-82	dBm
Maximum Input Level (PER < 10%)	-30			dBm
Adjacent Channel Rejection (PER ≤ 10%)	-2			dB

## 12.7 DC/RF Characteristics for IEEE 802.11ac (VHT20) - 5 GHz

Table 41: DC/RF Characteristics for IEEE 802.11ac (VHT20) - 5 GHz

Items	Contents
Specification	IEEE 802.11ac
Mode	OFDM
Channel Frequency	5180 to 5240 MHz 5260 to 5320 MHz 5500 to 5720 MHz 5745 to 5825 MHz
Data rate	MCS0 - MCS8

### 12.7.1 High-Rate Condition for IEEE 802.11ac (VHT20) - 5 GHz

**Conditions:** 25 °C, VDD33 = 3.3V, VDD18 = 1.8V VIO = 1.8V, Output power setting = 15 dBm, MCS8 mode

Table 42: High-Rate Condition for IEEE 802.11ac (VHT20) - 5 GHz

Items	Contents			
DC Characteristics	Minimum	Typical	Maximum	Unit
DC current				
• Tx mode	VDD18	370		mA
	VDD33	220		mA
	VDD18 (MIMO)	560		mA
	VDD33 (MIMO)	420		mA
• Rx mode	VDD18	320		mA
	VDD33	0.2		mA
	VDD18 (MIMO)	320		mA
	VDD33 (MIMO)	0.2		mA
Tx Characteristics	Minimum	Typical	Maximum	Unit
Output Power	13	15	17	dBm
Spectrum Mask Margin				
• 9 MHz to 11 MHz (0 ~ -20 dB)	0			dB

Items	Contents			
• 11 MHz to 20 MHz (-20 ~ -28 dBr)	0			dB
• 20 MHz to 30 MHz (-28 ~ -45 dBr)	0			dB
• 30 MHz to 33 MHz (-45 dBr)	0			dB
Constellation Error (EVM) (Measured at enhanced mode)			-30	dB
Frequency Tolerance	-20		20	ppm
Spurious Emissions				
• 30 - 47 MHz (BW = 100 kHz)			-36	dBm
• 47 - 74 MHz (BW = 100 kHz)			-54	dBm
• 74 - 87.5 MHz (BW = 100 kHz)			-36	dBm
• 87.5 - 118 MHz (BW = 100 kHz)			-54	dBm
• 118 - 174 MHz (BW = 100 kHz)			-36	dBm
• 174 - 230 MHz (BW = 100 kHz)			-54	dBm
• 230 - 470 MHz (BW = 100 kHz)			-36	dBm
• 470 - 862 MHz (BW = 100 kHz)			-54	dBm
• 862 - 1000 MHz (BW = 100 kHz)			-36	dBm
• 1000 - 5150 MHz (BW = 1 MHz)			-30	dBm
• 5350 - 5470 MHz (BW = 1 MHz)			-30	dBm
• 5725 - 26000 MHz (BW = 1 MHz)			-30	dBm
Rx Characteristics	Minimum	Typical	Maximum	Unit
Minimum Input Level (PER ≤ 10%)			-59	dBm
Maximum Input Level (PER < 10%)	-30			dBm
Adjacent Channel Rejection (PER ≤ 10%)	-7			dB

## 12.7.2 Low-Rate Condition for IEEE 802.11ac (VHT20) - 5 GHz

**Conditions:** 25 °C, VDD33 = 3.3V, VDD18 = 1.8V VIO = 1.8V, Output power setting = 16 dBm, MCS0 mode

**Table 43: Low-Rate Condition for IEEE 802.11ac (VHT20) - 5 GHz**

Items	Contents			
DC Characteristics	Minimum	Typical	Maximum	Unit
DC current				
• Tx mode	VDD18	400		mA
	VDD33	250		mA
	VDD18 (MIMO)	640		mA
	VDD33 (MIMO)	470		mA
• Rx mode	VDD18	320		mA
	VDD33	0.2		mA
	VDD18 (MIMO)	320		mA
	VDD33 (MIMO)	0.2		mA
Tx Characteristics -	Minimum	Typical	Maximum	Unit
Output Power	14	16	18	dBm
Spectrum Mask Margin				
• 9 MHz to 11 MHz (0 ~ -20 dBr)	0			dB
• 11 MHz to 20 MHz (-20 ~ -28 dBr)	0			dB
• 20 MHz to 30 MHz (-28 ~ -45 dBr)	0			dB
• 30 MHz to 33 MHz (-45 dBr)	0			dB
Constellation Error (EVM)			-30	dB

Items	Contents			
(Measured at enhanced mode)				
Frequency Tolerance	-20		20	ppm
Spurious Emissions				
• 30 - 47 MHz (BW = 100 kHz)			-36	dBm
• 47 - 74 MHz (BW = 100 kHz)			-54	dBm
• 74 - 87.5 MHz (BW = 100 kHz)			-36	dBm
• 87.5 - 118 MHz (BW = 100 kHz)			-54	dBm
• 118 - 174 MHz (BW = 100 kHz)			-36	dBm
• 174 - 230 MHz (BW = 100 kHz)			-54	dBm
• 230 - 470 MHz (BW = 100 kHz)			-36	dBm
• 470 - 862 MHz (BW = 100 kHz)			-54	dBm
• 862 - 1000 MHz (BW = 100 kHz)			-36	dBm
• 1000 - 5150 MHz (BW = 1 MHz)			-30	dBm
• 5350 - 5470 MHz (BW = 1 MHz)			-30	dBm
• 5725 - 26000 MHz (BW = 1 MHz)			-30	dBm
<b>Rx Characteristics</b>	<b>Minimum</b>	<b>Typical</b>	<b>Maximum</b>	<b>Unit</b>
Minimum Input Level (PER ≤ 10%)			-82	dBm
Maximum Input Level (PER < 10%)	-30			dBm
Adjacent Channel Rejection (PER ≤ 10%)	-7			dB

## 12.8 DC/RF Characteristics for IEEE 802.11n (HT40) - 5 GHz

**Table 44: DC/RF Characteristics for IEEE 802.11n (HT40) - 5 GHz**

Items	Contents
Specification	IEEE 802.11n
Mode	OFDM
Channel Frequency	5190 - 5795 MHz
Data rate	MCS0 - MCS7

### 12.8.1 High-Rate Condition for IEEE 802.11n (HT40) - 5 GHz

**Conditions:** 25 °C, VDD33 = 3.3V, VDD18 = 1.8V VIO = 1.8V, Output power setting = 16 dBm, MCS7 mode

**Table 45: High-Rate Condition for IEEE 802.11n (HT40) - 5 GHz**

Items		Contents			
DC Characteristics		Minimum	Typical	Maximum	Unit
DC current					
• Tx mode	VDD18		410		mA
	VDD33		240		mA
	VDD18 (MIMO)		630		mA
	VDD33 (MIMO)		440		mA
• Rx mode	VDD18		320		mA
	VDD33		0.2		mA
	VDD18 (MIMO)		350		mA
	VDD33 (MIMO)		0.2		mA
Tx Characteristics		Minimum	Typical	Maximum	Unit
Output Power		14	16	18	dBm
Spectrum Mask Margin					
•	19 MHz to 21 MHz (0 ~ -20 dBr)	0			dB
•	21 MHz to 40 MHz (-20 ~ -28 dBr)	0			dB
•	40 MHz to 60 MHz (-28 ~ -45 dBr)	0			dB
•	60 MHz to 80 MHz (-45 dBr)	0			dB
Constellation Error (EVM) (Measured at enhanced mode)				-27	dB
Frequency Tolerance		-20		20	ppm
Spurious Emissions					
•	30 - 47 MHz (BW = 100 kHz)			-36	dBm
•	47 - 74 MHz (BW = 100 kHz)			-54	dBm
•	74 - 87.5 MHz (BW = 100 kHz)			-36	dBm
•	87.5 - 118 MHz (BW = 100 kHz)			-54	dBm
•	118 - 174 MHz (BW = 100 kHz)			-36	dBm
•	174 - 230 MHz (BW = 100 kHz)			-54	dBm
•	230 - 470 MHz (BW = 100 kHz)			-36	dBm
•	470 - 862 MHz (BW = 100 kHz)			-54	dBm
•	862 - 1000 MHz (BW = 100 kHz)			-36	dBm

Items	Contents			
• 1000 - 5150 MHz (BW = 1 MHz)			-30	dBm
• 5350 - 5470 MHz (BW = 1 MHz)			-30	dBm
• 5725 - 26000 MHz (BW = 1 MHz)			-30	dBm
Rx Characteristics	Minimum	Typical	Maximum	Unit
Minimum Input Level (PER ≤ 10%)			-61	dBm
Maximum Input Level (PER ≤ 10%)	-30			dBm
Adjacent Channel Rejection (PER ≤ 10%)	-2			dB

## 12.8.2 Low-Rate Condition for IEEE 802.11n (HT40) - 5 GHz

**Conditions:** 25 °C, VDD33 = 3.3V, VDD18 = 1.8V VIO = 1.8V, Output power setting = 16 dBm, MCS0 mode

**Table 46: Low-Rate Condition for IEEE 802.11n (HT40) - 5 GHz**

Items	Contents			
- DC Characteristics -	Minimum	Typical	Maximum	Unit
DC current				
• Tx mode	VDD18	410		mA
	VDD33	250		mA
	VDD18 (MIMO)	650		mA
	VDD33 (MIMO)	470		mA
• Rx mode	VDD18	320		mA
	VDD33	0.2		mA
	VDD18 (MIMO)	350		mA
	VDD33 (MIMO)	0.2		mA
Tx Characteristics	Minimum	Typical	Maximum	Unit
Output Power	14	16	18	dBm
Spectrum Mask Margin				
• 19 MHz to 21 MHz (0 ~ -20 dBr)	0			dB
• 21 MHz to 40 MHz (-20 ~ -28 dBr)	0			dB
• 40 MHz to 60 MHz (-28 ~ -45 dBr)	0			dB
• 60 MHz to 80 MHz (-45 dBr)	0			dB
Constellation Error (EVM) (Measured at enhanced mode)			-27	dB
Frequency Tolerance	-20		20	ppm
Spurious Emissions				
• 30 - 47 MHz (BW = 100 kHz)			-36	dBm
• 47 - 74 MHz (BW = 100 kHz)			-54	dBm
• 74 - 87.5 MHz (BW = 100 kHz)			-36	dBm
• 87.5 - 118 MHz (BW = 100 kHz)			-54	dBm
• 118 - 174 MHz (BW = 100 kHz)			-36	dBm
• 174 - 230 MHz (BW = 100 kHz)			-54	dBm
• 230 - 470 MHz (BW = 100 kHz)			-36	dBm
• 470 - 862 MHz (BW = 100 kHz)			-54	dBm
• 862 - 1000 MHz (BW = 100 kHz)			-36	dBm
• 1000 - 5150 MHz (BW = 1 MHz)			-30	dBm
• 5350 - 5470 MHz (BW = 1 MHz)			-30	dBm
• 5725 - 26000 MHz (BW = 1 MHz)			-30	dBm
Rx Characteristics	Minimum	Typical	Maximum	Unit

Items	Contents			
Minimum Input Level (PER ≤ 10%)			-79	dBm
Maximum Input Level (PER ≤ 10%)	-30			dBm
Adjacent Channel Rejection (PER ≤ 10%)	-2			dB

## 12.9 DC/RF Characteristics for IEEE 802.11ac (VHT40) - 5 GHz

Table 47: DC/RF Characteristics for IEEE 802.11ac (VHT40) - 5 GHz

Items	Contents
Specification	IEEE 802.11ac
Mode	OFDM
Channel Frequency	5190 to 5795 MHz
Data rate	MCS0 - MCS9

### 12.9.1 High-Rate Condition for IEEE 802.11ac (VHT40) - 5 GHz

**Conditions:** 25 °C, VDD33 = 3.3V, VDD18 = 1.8V VIO = 1.8V, Output power setting = 15 dBm, MCS9 mode

Table 48: High-Rate Condition for IEEE 802.11ac (VHT40) - 5 GHz

Items		Contents			
DC Characteristics		Minimum	Typical	Maximum	Unit
DC current					
• Tx mode	VDD18		380		mA
	VDD33		210		mA
	VDD18 (MIMO)		570		mA
	VDD33 (MIMO)		410		mA
• Rx mode	VDD18		320		mA
	VDD33		0.2		mA
	VDD18 (MIMO)		350		mA
	VDD33 (MIMO)		0.2		mA
Tx Characteristics		Minimum	Typical	Maximum	Unit
Output Power		13	15	17	dBm
Spectrum Mask Margin					
• 19 MHz to 21 MHz (0 ~ -20 dBr)		0			dB
• 21 MHz to 40 MHz (-20 ~ -28 dBr)		0			dB
• 40 MHz to 60 MHz (-28 ~ -45 dBr)		0			dB
• 60 MHz to 80 MHz (-45 dBr)		0			dB
Constellation Error (EVM) (Measured at enhanced mode)				-32	dB
Frequency Tolerance		-20		20	ppm
Spurious Emissions					
• 30 - 47 MHz (BW = 100 kHz)				-36	dBm
• 47 - 74 MHz (BW = 100 kHz)				-54	dBm
• 74 - 87.5 MHz (BW = 100 kHz)				-36	dBm

Items	Contents			
• 87.5 - 118 MHz (BW = 100 kHz)			-54	dBm
• 118 - 174 MHz (BW = 100 kHz)			-36	dBm
• 174 - 230 MHz (BW = 100 kHz)			-54	dBm
• 230 - 470 MHz (BW = 100 kHz)			-36	dBm
• 470 - 862 MHz (BW = 100 kHz)			-54	dBm
• 862 - 1000 MHz (BW = 100 kHz)			-36	dBm
• 1000 - 5150 MHz (BW = 1 MHz)			-30	dBm
• 5350 - 5470 MHz (BW = 1 MHz)			-30	dBm
• 5725 - 26000 MHz (BW = 1 MHz)			-30	dBm
Rx Characteristics	Minimum	Typical	Maximum	Unit
Minimum Input Level (PER ≤ 10%)			-54	dBm
Maximum Input Level (PER ≤ 10%)	-30			dBm
Adjacent Channel Rejection (PER ≤ 10%)	-9			dB

## 12.9.2 Low-Rate Condition for IEEE 802.11ac (VHT40) - 5 GHz

**Conditions:** 25 °C, VDD33 = 3.3V, VDD18 = 1.8V VIO = 1.8V, Output power setting = 16 dBm, MCS0 mode

**Table 49: Low-Rate Condition for IEEE 802.11ac (VHT40) - 5 GHz**

Items		Contents			
DC Characteristics		Minimum	Typical	Maximum	Unit
DC Current					
• Tx mode	VDD18		410		mA
	VDD33		250		mA
	VDD18 (MIMO)		650		mA
	VDD33 (MIMO)		470		mA
• Rx mode	VDD18		320		mA
	VDD33		0.2		mA
	VDD18 (MIMO)		350		mA
	VDD33 (MIMO)		0.2		mA
Tx Characteristics		Minimum	Typical	Maximum	Unit
Output Power		14	16	18	dBm
Spectrum Mask Margin					
•	19 MHz to 21 MHz (0 ~ -20 dBr)	0			dB
•	21 MHz to 40 MHz (-20 ~ -28 dBr)	0			dB
•	40 MHz to 60 MHz (-28 ~ -45 dBr)	0			dB
•	60 MHz to 80 MHz (-45 dBr)	0			dB
Constellation Error (EVM) (Measured at enhanced mode)				-32	dB
Frequency Tolerance		-20		20	ppm
Spurious Emissions					
•	30 - 47 MHz (BW = 100 kHz)			-36	dBm
•	47 - 74 MHz (BW = 100 kHz)			-54	dBm
•	74 - 87.5 MHz (BW = 100 kHz)			-36	dBm
•	87.5 - 118 MHz (BW = 100 kHz)			-54	dBm
•	118 - 174 MHz (BW = 100 kHz)			-36	dBm
•	174 - 230 MHz (BW = 100 kHz)			-54	dBm
•	230 - 470 MHz (BW = 100 kHz)			-36	dBm



Items	Contents			
• 470 - 862 MHz (BW = 100 kHz)			-54	dBm
• 862 - 1000 MHz (BW = 100 kHz)			-36	dBm
• 1000 - 5150 MHz (BW = 1 MHz)			-30	dBm
• 5350 - 5470 MHz (BW = 1 MHz)			-30	dBm
• 5725 - 26000 MHz (BW = 1 MHz)			-30	dBm
Rx Characteristics	Minimum	Typical	Maximum	Unit
Minimum Input Level (PER ≤ 10%)			-79	dBm
Maximum Input Level (PER ≤ 10%)	-30			dBm
Adjacent Channel Rejection (PER ≤ 10%)	-9			dB

## 12.10 DC/RF Characteristics for IEEE 802.11ac (VHT80) - 5 GHz

Table 50: DC/RF Characteristics for IEEE 802.11ac (VHT80) - 5 GHz

Items	Contents
Specification	IEEE 802.11ac
Mode	OFDM
Channel Frequency	5210 - 5775 MHz
Data rate	MCS0 - MCS9

### 12.10.1 High-Rate Condition for IEEE 802.11ac (VHT80) - 5 GHz

**Conditions:** 25 °C, VDD33 = 3.3V, VDD18 = 1.8V VIO = 1.8V, Output power setting = 14 dBm, MCS9 mode

Table 51: High-Rate Condition for IEEE 802.11ac (VHT80) - 5 GHz

Items	Contents			
DC Characteristics	Minimum	Typical	Maximum	Unit
DC current				
• Tx mode	VDD18	400		mA
	VDD33	200		mA
	VDD18 (MIMO)	600		mA
	VDD33 (MIMO)	380		mA
• Rx mode	VDD18	350		mA
	VDD33	0.2		mA
	VDD18 (MIMO)	420		mA
	VDD33 (MIMO)	0.2		mA
Tx Characteristics	Minimum	Typical	Maximum	Unit
Output Power	12	14	16	dBm
Spectrum Mask Margin				
• 39 MHz to 41 MHz (0 ~ -20 dBr)	0			dB
• 41 MHz to 80 MHz (-20 ~ -28 dBr)	0			dB
• 80 MHz to 120 MHz (-28 ~ -40 dBr)	0			dB
• 120 MHz to 140 MHz (-40 dBr)	0			dB

Items	Contents			
Constellation Error (EVM) (Measured at enhanced mode)			-32	dB
Frequency Tolerance	-20		20	ppm
Spurious Emissions				
• 30 - 47 MHz (BW = 100 kHz)			-36	dBm
• 47 - 74 MHz (BW = 100 kHz)			-54	dBm
• 74 - 87.5 MHz (BW = 100 kHz)			-36	dBm
• 87.5 - 118 MHz (BW = 100 kHz)			-54	dBm
• 118 - 174 MHz (BW = 100 kHz)			-36	dBm
• 174 - 230 MHz (BW = 100 kHz)			-54	dBm
• 230 - 470 MHz (BW = 100 kHz)			-36	dBm
• 470 - 862 MHz (BW = 100 kHz)			-54	dBm
• 862 - 1000 MHz (BW = 100 kHz)			-36	dBm
• 1000 - 5150 MHz (BW = 1 MHz)			-30	dBm
• 5350 - 5470 MHz (BW = 1 MHz)			-30	dBm
• 5725 - 26000 MHz (BW = 1 MHz)			-30	dBm
<b>Rx Characteristics</b>	<b>Minimum</b>	<b>Typical</b>	<b>Maximum</b>	<b>Unit</b>
Minimum Input Level (PER ≤ 10%)			-51	dBm
Maximum Input Level (PER ≤ 10%)	-30			dBm
Adjacent Channel Rejection (PER ≤ 10%)	-9			dB

## 12.10.2 Low-Rate Condition for IEEE 802.11ac (VHT80) - 5 GHz

**Conditions:** 25 °C, VDD33 = 3.3V, VDD18 = 1.8V VIO = 1.8V, Output power setting = 15 dBm, MCS0 mode

**Table 52: Low-Rate Condition for IEEE 802.11ac (VHT80) - 5 GHz**

Items	Contents			
DC Characteristics	Minimum	Typical	Maximum	Unit
DC current				
• Tx mode	VDD18	400		mA
	VDD33	230		mA
	VDD18 (MIMO)	630		mA
	VDD33 (MIMO)	440		mA
• Rx mode	VDD18	350		mA
	VDD33	0.2		mA
	VDD18 (MIMO)	420		mA
	VDD33 (MIMO)	0.2		mA
<b>Tx Characteristics</b>	<b>Minimum</b>	<b>Typical</b>	<b>Maximum</b>	<b>Unit</b>
Output Power	13	15	17	dBm
Spectrum Mask Margin				
• 39 MHz to 41 MHz (0 ~ -20 dBr)	0			dB
• 41 MHz to 80 MHz (-20 ~ -28 dBr)	0			dB
• 80 MHz to 120 MHz (-28 ~ -40 dBr)	0			dB
• 120 MHz to 140 MHz (-40 dBr)	0			dB
Constellation Error (EVM) (Measured at enhanced mode)			-19	dB
Frequency Tolerance	-20		20	ppm

Items	Contents			
Spurious Emissions				
• 30 - 47 MHz (BW = 100 kHz)			-36	dBm
• 47 - 74 MHz (BW = 100 kHz)			-54	dBm
• 74 - 87.5 MHz (BW = 100 kHz)			-36	dBm
• 87.5 - 118 MHz (BW = 100 kHz)			-54	dBm
• 118 - 174 MHz (BW = 100 kHz)			-36	dBm
• 174 - 230 MHz (BW = 100 kHz)			-54	dBm
• 230 - 470 MHz (BW = 100 kHz)			-36	dBm
• 470 - 862 MHz (BW = 100 kHz)			-54	dBm
• 862 - 1000 MHz (BW = 100 kHz)			-36	dBm
• 1000 - 5150 MHz (BW = 1 MHz)			-30	dBm
• 5350 - 5470 MHz (BW = 1 MHz)			-30	dBm
• 5725 - 26000 MHz (BW = 1 MHz)			-30	dBm
Rx Characteristics	Minimum	Typical	Maximum	Unit
Minimum Input Level (PER ≤ 10%)			-76	dBm
Maximum Input Level (PER ≤ 10%)	-30			dBm
Adjacent Channel Rejection (PER ≤ 10%)	-9			dB

## 12.11 DC/RF Characteristics for IEEE 802.11ax (HE20) - 5 GHz

Table 53: DC/RF Characteristics for IEEE 802.11ax (HE20) - 5 GHz

Items	Contents
Specification	IEEE 802.11ax
Mode	OFDM
Channel Frequency	5180 to 5240 MHz 5260 to 5320 MHz 5500 to 5720 MHz 5745 to 5825 MHz
Data rate	MCS0 - MCS11

## 12.11.1 High-Rate Condition for IEEE 802.11ax (HE20) - 5 GHz

**Conditions:** 25 °C, VDD33 = 3.3V, VDD18 = 1.8V VIO = 1.8V, Output power setting = 14 dBm, MCS11 mode

**Table 54: High-Rate Condition for IEEE 802.11ax (HE20) - 5 GHz**

Items		Contents			
DC Characteristics		Minimum	Typical	Maximum	Unit
DC current					
• Tx mode	VDD18		380		mA
	VDD33		210		mA
	VDD18 (MIMO)		560		mA
	VDD33 (MIMO)		400		mA
• Rx mode	VDD18		320		mA
	VDD33		0.2		mA
	VDD18 (MIMO)		320		mA
	VDD33 (MIMO)		0.2		mA
Tx Characteristics		Minimum	Typical	Maximum	Unit
Output Power		12	14	16	dBm
Spectrum Mask Margin					
• 39 MHz to 41 MHz (0 ~ -20 dBr)		0			dB
• 41 MHz to 80 MHz (-20 ~ -28 dBr)		0			dB
• 80 MHz to 120 MHz (-28 ~ -40 dBr)		0			dB
• 120 MHz to 140 MHz (-40 dBr)		0			dB
Constellation Error (EVM) (Measured at enhanced mode)				-32	dB
Frequency Tolerance		-20		20	ppm
Spurious Emissions					
• 30 - 47 MHz (BW = 100 kHz)				-36	dBm
• 47 - 74 MHz (BW = 100 kHz)				-54	dBm
• 74 - 87.5 MHz (BW = 100 kHz)				-36	dBm
• 87.5 - 118 MHz (BW = 100 kHz)				-54	dBm
• 118 - 174 MHz (BW = 100 kHz)				-36	dBm
• 174 - 230 MHz (BW = 100 kHz)				-54	dBm
• 230 - 470 MHz (BW = 100 kHz)				-36	dBm
• 470 - 862 MHz (BW = 100 kHz)				-54	dBm
• 862 - 1000 MHz (BW = 100 kHz)				-36	dBm
• 1000 - 5150 MHz (BW = 1 MHz)				-30	dBm
• 5350 - 5470 MHz (BW = 1 MHz)				-30	dBm
• 5725 - 26000 MHz (BW = 1 MHz)				-30	dBm
Rx Characteristics		Minimum	Typical	Maximum	Unit
Minimum Input Level (PER ≤ 10%)				-51	dBm
Maximum Input Level (PER ≤ 10%)		-30			dBm
Adjacent Channel Rejection (PER ≤ 10%)		-9			dB

## 12.11.2 Low-Rate Condition for IEEE 802.11ax (HE20) - 5 GHz

**Conditions:** 25 °C, VDD33 = 3.3V, VDD18 = 1.8V VIO = 1.8V, Output power setting = 16 dBm, MCS0 mode

**Table 55: Low-Rate Condition for IEEE 802.11ax (HE20) - 5 GHz**

Items		Contents			
DC Characteristics		Minimum	Typical	Maximum	Unit
DC current					
• Tx mode	VDD18		400		mA
	VDD33		250		mA
	VDD18 (MIMO)		640		mA
	VDD33 (MIMO)		480		mA
• Rx mode	VDD18		320		mA
	VDD33		0.2		mA
	VDD18 (MIMO)		320		mA
	VDD33 (MIMO)		0.2		mA
Tx Characteristics		Minimum	Typical	Maximum	Unit
Output Power		14	16	18	dBm
Spectrum Mask Margin					
•	39 MHz to 41 MHz (0 ~ -20 dBr)	0			dB
•	41 MHz to 80 MHz (-20 ~ -28 dBr)	0			dB
•	80 MHz to 120 MHz (-28 ~ -40 dBr)	0			dB
•	120 MHz to 140 MHz (-40 dBr)	0			dB
Constellation Error (EVM) (Measured at enhanced mode)				-19	dB
Frequency Tolerance		-20		20	ppm
Spurious Emissions					
•	30 - 47 MHz (BW = 100 kHz)			-36	dBm
•	47 - 74 MHz (BW = 100 kHz)			-54	dBm
•	74 - 87.5 MHz (BW = 100 kHz)			-36	dBm
•	87.5 - 118 MHz (BW = 100 kHz)			-54	dBm
•	118 - 174 MHz (BW = 100 kHz)			-36	dBm
•	174 - 230 MHz (BW = 100 kHz)			-54	dBm
•	230 - 470 MHz (BW = 100 kHz)			-36	dBm
•	470 - 862 MHz (BW = 100 kHz)			-54	dBm
•	862 - 1000 MHz (BW = 100 kHz)			-36	dBm
•	1000 - 5150 MHz (BW = 1 MHz)			-30	dBm
•	5350 - 5470 MHz (BW = 1 MHz)			-30	dBm
•	5725 - 26000 MHz (BW = 1 MHz)			-30	dBm
Rx Characteristics		Minimum	Typical	Maximum	Unit
Minimum Input Level (PER ≤ 10%)				-76	dBm
Maximum Input Level (PER ≤ 10%)		-30			dBm
Adjacent Channel Rejection (PER ≤ 10%)		-9			dB

## 12.12 DC/RF Characteristics for IEEE 802.11ax (HE40) - 5 GHz

**Table 56: DC/RF Characteristics for IEEE 802.11ax (HE40) - 5 GHz**

Items	Contents
Specification	IEEE 802.11ax
Mode	OFDM
Channel Frequency	5210 - 5775 MHz
Data rate	MCS0 - MCS11

### 12.12.1 High-Rate Condition for IEEE 802.11ax (HE40) - 5 GHz

**Conditions:** 25 °C, VDD33 = 3.3V, VDD18 = 1.8V VIO = 1.8V, Output power setting = 14 dBm, MCS11 mode

**Table 57: High-Rate Condition for IEEE 802.11ax (HE40) - 5 GHz**

Items		Contents			
DC Characteristics		Minimum	Typical	Maximum	Unit
DC current					
• Tx mode	VDD18		390		mA
	VDD33		210		mA
	VDD18 (MIMO)		560		mA
	VDD33 (MIMO)		400		mA
• Rx mode	VDD18		320		mA
	VDD33		0.2		mA
	VDD18 (MIMO)		350		mA
	VDD33 (MIMO)		0.2		mA
Tx Characteristics		Minimum	Typical	Maximum	Unit
Output Power		12	14	16	dBm
Spectrum Mask Margin					
•	39 MHz to 41 MHz (0 ~ -20 dBr)	0			dB
•	41 MHz to 80 MHz (-20 ~ -28 dBr)	0			dB
•	80 MHz to 120 MHz (-28 ~ -40 dBr)	0			dB
•	120 MHz to 140 MHz (-40 dBr)	0			dB
Constellation Error (EVM) (Measured at enhanced mode)				-32	dB
Frequency Tolerance		-20		20	ppm
Spurious Emissions					
•	30 - 47 MHz (BW = 100 kHz)			-36	dBm
•	47 - 74 MHz (BW = 100 kHz)			-54	dBm
•	74 - 87.5 MHz (BW = 100 kHz)			-36	dBm
•	87.5 - 118 MHz (BW = 100 kHz)			-54	dBm
•	118 - 174 MHz (BW = 100 kHz)			-36	dBm
•	174 - 230 MHz (BW = 100 kHz)			-54	dBm
•	230 - 470 MHz (BW = 100 kHz)			-36	dBm
•	470 - 862 MHz (BW = 100 kHz)			-54	dBm

Items	Contents			
• 862 - 1000 MHz (BW = 100 kHz)			-36	dBm
• 1000 - 5150 MHz (BW = 1 MHz)			-30	dBm
• 5350 - 5470 MHz (BW = 1 MHz)			-30	dBm
• 5725 - 26000 MHz (BW = 1 MHz)			-30	dBm
Rx Characteristics	Minimum	Typical	Maximum	Unit
Minimum Input Level (PER ≤ 10%)			-51	dBm
Maximum Input Level (PER ≤ 10%)	-30			dBm
Adjacent Channel Rejection (PER ≤ 10%)	-9			dB

## 12.12.2 Low-Rate Condition for IEEE 802.11ax (HE40) - 5 GHz

**Conditions:** 25 °C, VDD33 = 3.3V, VDD18 = 1.8V VIO = 1.8V, Output power setting = 16 dBm, MCS0 mode

**Table 58: Low-Rate Condition for IEEE 802.11ax (HE 40) - 5 GHz**

Items	Contents			
DC Characteristics	Minimum	Typical	Maximum	Unit
DC current				
• Tx mode	VDD18	420		mA
	VDD33	250		mA
	VDD18 (MIMO)	660		mA
	VDD33 (MIMO)	480		mA
• Rx mode	VDD18	320		mA
	VDD33	0.2		mA
	VDD18 (MIMO)	350		mA
	VDD33 (MIMO)	0.2		mA
Tx Characteristics	Minimum	Typical	Maximum	Unit
Output Power	14	16	18	dBm
Spectrum Mask Margin				
• 39 MHz to 41 MHz (0 ~ -20 dBr)	0			dB
• 41 MHz to 80 MHz (-20 ~ -28 dBr)	0			dB
• 80 MHz to 120 MHz (-28 ~ -40 dBr)	0			dB
• 120 MHz to 140 MHz (-40 dBr)	0			dB
Constellation Error (EVM) (Measured at enhanced mode)			-32	dB
Frequency Tolerance	-20		20	ppm
Spurious Emissions				
• 30 - 47 MHz (BW = 100 kHz)			-36	dBm
• 47 - 74 MHz (BW = 100 kHz)			-54	dBm
• 74 - 87.5 MHz (BW = 100 kHz)			-36	dBm
• 87.5 - 118 MHz (BW = 100 kHz)			-54	dBm
• 118 - 174 MHz (BW = 100 kHz)			-36	dBm
• 174 - 230 MHz (BW = 100 kHz)			-54	dBm
• 230 - 470 MHz (BW = 100 kHz)			-36	dBm
• 470 - 862 MHz (BW = 100 kHz)			-54	dBm
• 862 - 1000 MHz (BW = 100 kHz)			-36	dBm
• 1000 - 5150 MHz (BW = 1 MHz)			-30	dBm

Items	Contents			
• 5350 - 5470 MHz (BW = 1 MHz)			-30	dBm
• 5725 - 26000 MHz (BW = 1 MHz)			-30	dBm
Rx Characteristics	Minimum	Typical	Maximum	Unit
Minimum Input Level (PER ≤ 10%)			-76	dBm
Maximum Input Level (PER ≤ 10%)	-30			dBm
Adjacent Channel Rejection (PER ≤ 10%)	-9			dB

## 12.13 DC/RF Characteristics for IEEE 802.11ax (HE80) - 5 GHz

Table 59: DC/RF Characteristics for IEEE 802.11ax (HE80) - 5 GHz

Items	Contents
Specification	IEEE 802.11ax
Mode	OFDM
Channel Frequency	5210 - 5775 MHz
Data rate	MCS0 - MCS11

### 12.13.1 High-Rate Condition for IEEE 802.11ax (HE80) - 5 GHz

**Conditions:** 25 °C, VDD33 = 3.3V, VDD18 = 1.8V VIO = 1.8V, Output power setting = 14 dBm, MCS11 mode

Table 60: High-Rate Condition for IEEE 802.11ax (HE80) - 5 GHz

Items		Contents			
DC Characteristics		Minimum	Typical	Maximum	Unit
DC current					
• Tx mode	VDD18		400		mA
	VDD33		200		mA
	VDD18 (MIMO)		600		mA
	VDD33 (MIMO)		400		mA
• Rx mode	VDD18		350		mA
	VDD33		0.2		mA
	VDD18 (MIMO)		420		mA
	VDD33 (MIMO)		0.2		mA
Tx Characteristics		Minimum	Typical	Maximum	Unit
Output Power		12	14	16	dBm
Spectrum Mask Margin					
• 39 MHz to 41 MHz (0 ~ -20 dBr)		0			dB
• 41 MHz to 80 MHz (-20 ~ -28 dBr)		0			dB
• 80 MHz to 120 MHz (-28 ~ -40 dBr)		0			dB
• 120 MHz to 140 MHz (-40 dBr)		0			dB
Constellation Error (EVM) (Measured at enhanced mode)				-32	dB



Items	Contents			
Frequency Tolerance	-20		20	ppm
Spurious Emissions				
• 30 - 47 MHz (BW = 100 kHz)			-36	dBm
• 47 - 74 MHz (BW = 100 kHz)			-54	dBm
• 74 - 87.5 MHz (BW = 100 kHz)			-36	dBm
• 87.5 - 118 MHz (BW = 100 kHz)			-54	dBm
• 118 - 174 MHz (BW = 100 kHz)			-36	dBm
• 174 - 230 MHz (BW = 100 kHz)			-54	dBm
• 230 - 470 MHz (BW = 100 kHz)			-36	dBm
• 470 - 862 MHz (BW = 100 kHz)			-54	dBm
• 862 - 1000 MHz (BW = 100 kHz)			-36	dBm
• 1000 - 5150 MHz (BW = 1 MHz)			-30	dBm
• 5350 - 5470 MHz (BW = 1 MHz)			-30	dBm
• 5725 - 26000 MHz (BW = 1 MHz)			-30	dBm
Rx Characteristics	Minimum	Typical	Maximum	Unit
Minimum Input Level (PER ≤ 10%)			-51	dBm
Maximum Input Level (PER ≤ 10%)	-30			dBm
Adjacent Channel Rejection (PER ≤ 10%)	-9			dB

### 12.13.2 Low-Rate Condition for IEEE 802.11ax (HE80) - 5 GHz

**Conditions:** 25 °C, VDD33 = 3.3V, VDD18 = 1.8V VIO = 1.8V, Output power setting = 15 dBm, MCS0 mode

**Table 61: Low-Rate Condition for IEEE 802.11ax (HE80) - 5 GHz**

Items	Contents			
DC Characteristics	Minimum	Typical	Maximum	Unit
DC current				
• Tx mode	VDD18	400		mA
	VDD33	230		mA
	VDD18 (MIMO)	640		mA
	VDD33 (MIMO)	440		mA
• Rx mode	VDD18	350		mA
	VDD33	0.2		mA
	VDD18 (MIMO)	420		mA
	VDD33 (MIMO)	0.2		mA
Tx Characteristics	Minimum	Typical	Maximum	Unit
Output Power	13	15	17	dBm
Spectrum Mask Margin				
• 39 MHz to 41 MHz (0 ~ -20 dBr)	0			dB
• 41 MHz to 80 MHz (-20 ~ -28 dBr)	0			dB
• 80 MHz to 120 MHz (-28 ~ -40 dBr)	0			dB
• 120 MHz to 140 MHz (-40 dBr)	0			dB
Constellation Error (EVM) (Measured at enhanced mode)			-32	dB
Frequency Tolerance	-20		20	ppm
Spurious Emissions				
• 30 - 47 MHz (BW = 100 kHz)			-36	dBm

• 47 - 74 MHz (BW = 100 kHz)			-54	dBm
• 74 - 87.5 MHz (BW = 100 kHz)			-36	dBm
• 87.5 - 118 MHz (BW = 100 kHz)			-54	dBm
• 118 - 174 MHz (BW = 100 kHz)			-36	dBm
• 174 - 230 MHz (BW = 100 kHz)			-54	dBm
• 230 - 470 MHz (BW = 100 kHz)			-36	dBm
• 470 - 862 MHz (BW = 100 kHz)			-54	dBm
• 862 - 1000 MHz (BW = 100 kHz)			-36	dBm
• 1000 - 5150 MHz (BW = 1 MHz)			-30	dBm
• 5350 - 5470 MHz (BW = 1 MHz)			-30	dBm
• 5725 - 26000 MHz (BW = 1 MHz)			-30	dBm
Rx Characteristics	Minimum	Typical	Maximum	Unit
Minimum Input Level (PER ≤ 10%)			-76	dBm
Maximum Input Level (PER ≤ 10%)	-30			dBm
Adjacent Channel Rejection (PER ≤ 10%)	-9			dB

## 12.14 DC/RF Characteristics for Bluetooth

### 12.14.1 Basic Data Rate Condition

**Conditions:** 25 °C, VDD33 = 3.3V, VDD18 = 1.8V VIO = 1.8V

**Table 62: Basic Data Rate Condition**

Items	Contents			
Bluetooth specification (power class)	Version 5.3			
Channel frequency (spacing)	2402 to 2480 MHz (1 MHz)			
Current Consumption	Minimum	Typical	Maximum	Unit
• Tx mode DH5	VDD18	45		mA
	VDD33	0.2		
• Rx mode DH5	VDD18	20		mA
	VDD33	0.2		
Tx Characteristics	Minimum	Typical	Maximum	Unit
Output Power@DH5	0	3	6	dBm
Frequency range	2400		2483.5	MHz
20 dB bandwidth			1	MHz
Adjacent Channel Power <sup>3</sup>				
• [M-N] = 2			-20	dBm
• [M-N] ≥ 3			-40	dBm
Modulation characteristics				
• Modulation $\Delta f_{1\text{avg}}$	140	151	175	kHz
• Modulation $\Delta f_{2\text{max}}$	115			kHz
• Modulation $\Delta f_{2\text{avg}} / \Delta f_{1\text{avg}}$	0.8	1		
Carrier Frequency Drift				
• 1 slot	-25		25	kHz
• 3 slot / 5 slot	-40		40	kHz

<sup>3</sup> Up to three spurious responses within Bluetooth limits are allowed.

Items	Contents			
<ul style="list-style-type: none"> <li>Maximum Drift Rate</li> </ul>			20	kHz/50 $\mu$ s
Rx Characteristics	Minimum	Typical	Maximum	Unit
BDR Sensitivity (BER $\leq$ 0.1%)		-91	-86	dBm
C/I Performance (BER $\leq$ 0.1%) <sup>4</sup>				
<ul style="list-style-type: none"> <li>co-channel</li> </ul>			11	dB
<ul style="list-style-type: none"> <li>1 MHz</li> </ul>			0	dB
<ul style="list-style-type: none"> <li>2 MHz</li> </ul>			-30	dB
<ul style="list-style-type: none"> <li>3 MHz</li> </ul>			-40	dB
<ul style="list-style-type: none"> <li>image (+4 MHz)</li> </ul>			-9	dB
<ul style="list-style-type: none"> <li>image +/- 1 MHz</li> </ul>			-20	dB
Maximum Input Level (BER $\leq$ 0.1%)	-20			dBm

## 12.14.2 Enhanced Data Rate Condition

**Conditions:** 25 °C, VDD33 = 3.3V, VDD18 = 1.8V VIO = 1.8V

**Table 63: Enhanced Data Rate Condition**

Items	Contents			
Bluetooth Specification (power class)	Version 5.3			
Channel Frequency (spacing)	2402 to 2480 MHz (1 MHz)			
Current Consumption	Minimum	Typical	Maximum	Unit
<ul style="list-style-type: none"> <li>Tx mode 2DH5</li> </ul>	VDD18	45		mA
	VDD33	0.2		
<ul style="list-style-type: none"> <li>Rx mode 2DH5</li> </ul>	VDD18	20		mA
	VDD33	0.2		
<ul style="list-style-type: none"> <li>Tx mode 3DH5</li> </ul>	VDD18	45		mA
	VDD33	0.2		
<ul style="list-style-type: none"> <li>Rx mode 3DH5</li> </ul>	VDD18	20		mA
	VDD33	0.2		
Tx Characteristics	Minimum	Typical	Maximum	Unit
Output Power@2DH5/3DH5	-3	0	3	dBm
Frequency Range	2400		2483.5	MHz
20 dB bandwidth			1	MHz
Adjacent Channel Power <sup>5</sup>				
<ul style="list-style-type: none"> <li>[M-N] = 2</li> </ul>			-20	dBm
<ul style="list-style-type: none"> <li>[M-N] <math>\geq</math> 3</li> </ul>			-40	dBm
EDR Relative Power	-4		1	dB
EDR Carrier Frequency Stability and Modulation Accuracy				
<ul style="list-style-type: none"> <li><math>\omega_i</math></li> </ul>	-75		75	kHz
<ul style="list-style-type: none"> <li><math>\omega_i + \omega_o</math></li> </ul>	-75		75	kHz
<ul style="list-style-type: none"> <li><math>\omega_o</math></li> </ul>	-10		10	kHz
<ul style="list-style-type: none"> <li>RMS DEVM (DQPSK)</li> </ul>			20	%

<sup>4</sup> Up to five spurious responses within Bluetooth limits are allowed.

<sup>5</sup> Up to three spurious responses within Bluetooth limits are allowed.

Items	Contents			
• Peak DEVM (DQPSK)			35	%
• 99% DEVM (DQPSK)			30	%
• RMS DEVM (8DPSK)			13	%
• Peak DEVM (8DPSK)			25	%
• 99% DEVM (8DPSK)			20	%
<b>Spurious Emissions</b>				
• 30 - 47 MHz (BW = 100 kHz)			-36	dBm
• 47 - 74 MHz (BW = 100 kHz)			-54	dBm
• 74 - 87.5 MHz (BW = 100 kHz)			-36	dBm
• 87.5 - 118 MHz (BW = 100 kHz)			-54	dBm
• 118 - 174 MHz (BW = 100 kHz)			-36	dBm
• 174 - 230 MHz (BW = 100 kHz)			-54	dBm
• 230 - 470 MHz (BW = 100 kHz)			-36	dBm
• 470 - 862 MHz (BW = 100 kHz)			-54	dBm
• 862 - 1000 MHz (BW = 100 kHz)			-36	dBm
• 1000 - 12750 MHz (BW = 1 MHz)			-30	dBm
<b>Rx Characteristics</b>	<b>Minimum</b>	<b>Typical</b>	<b>Maximum</b>	<b>Unit</b>
EDR Sensitivity (BER ≤ 0.007%)@8DPSK		-88	-82	dBm
<b>C/I Performance (BER ≤ 0.1%)<sup>6</sup></b>				
• co-channel			11	dB
• 1 MHz			0	dB
• 2 MHz			-30	dB
• 3 MHz			-40	dB
• image (+4 MHz)			-9	dB
• image +/- 1 MHz			-20	dB
Maximum Input Level (BER ≤ 0.1%)	-20			dBm

## 12.15 DC/RF Characteristics for Bluetooth Low Energy

### 12.15.1 1 Mbps PHY Condition

**Conditions:** 25 °C, VDD33 = 3.3V, VDD18 = 1.8V VIO = 1.8V

**Table 64: 1 Mbps PHY Condition**

Items	Contents			
Bluetooth Specification (power class)	Version 5.3			
Channel Frequency (spacing)	2402 to 2480 MHz (2 MHz)			
Number of RF Channel	40			
<b>Current Consumption</b>	<b>Minimum</b>	<b>Typical</b>	<b>Maximum</b>	<b>Unit</b>
• Tx mode	VDD18	60		mA
	VDD33	0.2		

<sup>6</sup> Up to five spurious responses within Bluetooth limits are allowed.

Items		Contents			
• Rx mode	VDD18		20		mA
	VDD33		0.2		
<b>Tx Characteristics</b>		<b>Minimum</b>	<b>Typical</b>	<b>Maximum</b>	<b>Unit</b>
Center Frequency		2402		2480	MHz
Channel Spacing			2		MHz
Number of RF channel			40		
Output Power		0	3	6	dBm
Modulation Characteristics					
• $\Delta f_{1\text{avg}}$		225		275	kHz
• $\Delta f_{2\text{max}}$ (at 99.9%)		185			kHz
• $\Delta f_{2\text{avg}} / \Delta f_{1\text{avg}}$		0.8			
Carrier Frequency Offset and Drift					
• Frequency offset				150	kHz
• Frequency drift				50	kHz
• Drift rate				20	kHz
Spurious Emissions					
• 30 - 47 MHz (BW = 100 kHz)				-36	dBm
• 47 - 74 MHz (BW = 100 kHz)				-54	dBm
• 74 - 87.5 MHz (BW = 100 kHz)				-36	dBm
• 87.5 - 118 MHz (BW = 100 kHz)				-54	dBm
• 118 - 174 MHz (BW = 100 kHz)				-36	dBm
• 174 - 230 MHz (BW = 100 kHz)				-54	dBm
• 230 - 470 MHz (BW = 100 kHz)				-36	dBm
• 470 - 862 MHz (BW = 100 kHz)				-54	dBm
• 862 - 1000 MHz (BW = 100 kHz)				-36	dBm
• 1000 - 12750 MHz (BW = 1 MHz)				-30	dBm
<b>Rx Characteristics</b>		<b>Minimum</b>	<b>Typical</b>	<b>Maximum</b>	<b>Unit</b>
Receiver Sensitivity (PER < 30.8%)			-95	-90	dBm
Maximum Input Signal Level (PER < 30.8%)		-10			dBm
PER Report Integrity (-30 dBm input)		50		65.4	%

## 12.15.2 2 Mbps PHY Condition

**Conditions:** 25 °C, VDD33 = 3.3V, VDD18 = 1.8V, VIO = 1.8V

**Table 65: 2 Mbps PHY Condition**

Items		Contents			
Bluetooth Specification (power class)		Version 5.3			
Channel Frequency (spacing)		2402 to 2480 MHz (2 MHz)			
Number of RF Channel		40			
<b>Current Consumption</b>		<b>Minimum</b>	<b>Typical</b>	<b>Maximum</b>	<b>Unit</b>
• Tx mode	VDD18		60		mA
	VDD33		0.2		

Items		Contents			
• Rx mode	VDD18		20		mA
	VDD33		0.2		
<b>Tx Characteristics</b>		<b>Minimum</b>	<b>Typical</b>	<b>Maximum</b>	<b>Unit</b>
Center Frequency		2402		2480	MHz
Channel Spacing			2		MHz
Number of RF channel			40		
Output Power		0	3	6	dBm
Modulation Characteristics					
• $\Delta f_{1\text{avg}}$		225		275	kHz
• $\Delta f_{2\text{max}}$ (at 99.9%)		185			kHz
• $\Delta f_{2\text{avg}} / \Delta f_{1\text{avg}}$		0.8			
Carrier Frequency Offset and Drift					
• Frequency Offset				150	kHz
• Frequency Drift				50	kHz
• Drift Rate				20	kHz
Spurious Emissions					
• 30 - 47 MHz (BW = 100 kHz)				-36	dBm
• 47 - 74 MHz (BW = 100 kHz)				-54	dBm
• 74 - 87.5 MHz (BW = 100 kHz)				-36	dBm
• 87.5 - 118 MHz (BW = 100 kHz)				-54	dBm
• 118 - 174 MHz (BW = 100 kHz)				-36	dBm
• 174 - 230 MHz (BW = 100 kHz)				-54	dBm
• 230 - 470 MHz (BW = 100 kHz)				-36	dBm
• 470 - 862 MHz (BW = 100 kHz)				-54	dBm
• 862 - 1000 MHz (BW = 100 kHz)				-36	dBm
• 1000 - 12750 MHz (BW = 1 MHz)				-30	dBm
<b>Rx Characteristics</b>		<b>Minimum</b>	<b>Typical</b>	<b>Maximum</b>	<b>Unit</b>
Receiver sensitivity (PER < 30.8%)			-95	-90	dBm
Maximum input signal level (PER < 30.8%)		-10			dBm
PER Report Integrity (-30 dBm input)		50		65.4	%

# 13 Land Patterns

The recommended land pattern is shown in **Figure 16**.

**Figure 16: Land Patterns (Unit: mm)**

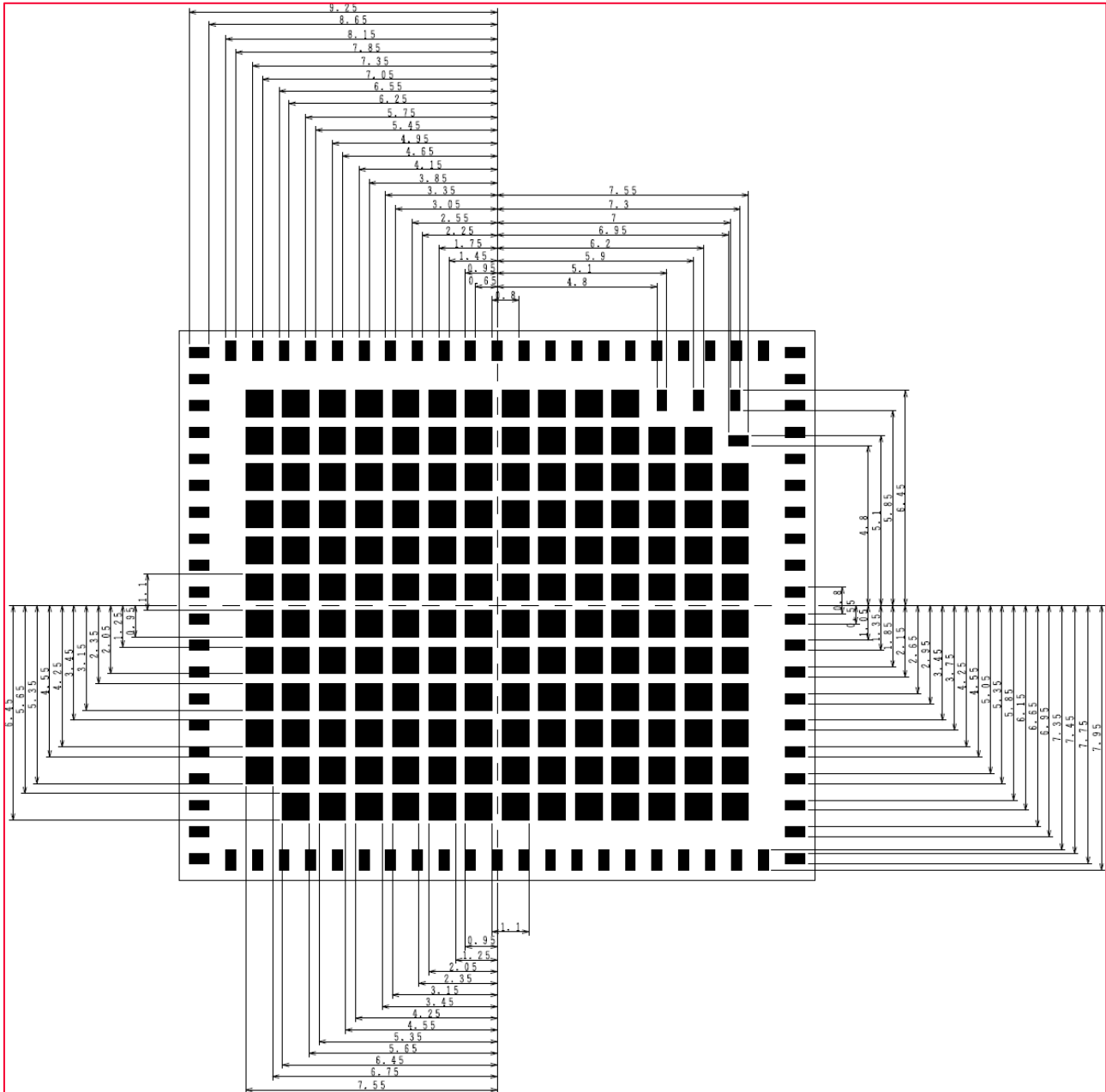

# 14 Radio Regulatory Certification by Country for 1XL/2XS

## General for Radio Regulatory Certification for LBEE5ZZ1XL and LBEE5ZZ2XS

### Application model part number

Basically, we apply for “LBEE5ZZ1XL and LBEE5ZZ2XS” in each country.

### Label

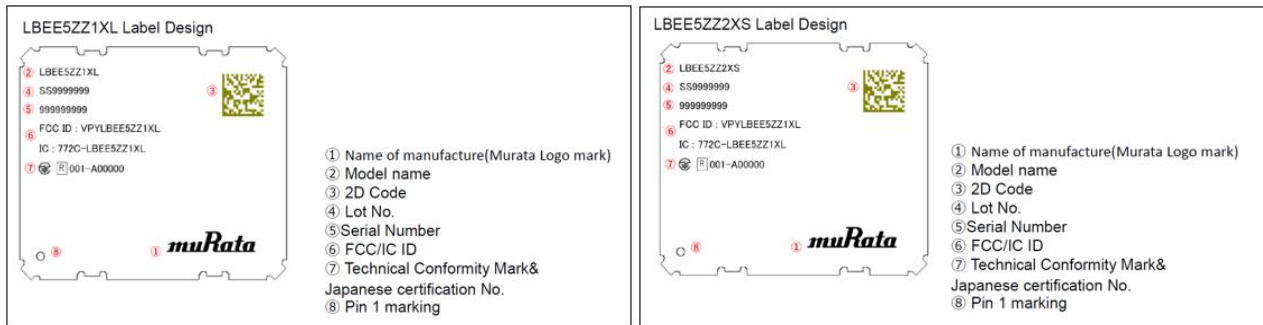

### Package Label

Label requirements for FCC/ISED are written on the module itself, so there is no need to write label requirements on packaging materials or documentation. However, since Japan does not describe all of the labeling requirements on the module itself, the following description is required in the packaging material manual.

#### PACKAGE (Humidity proof Packing)

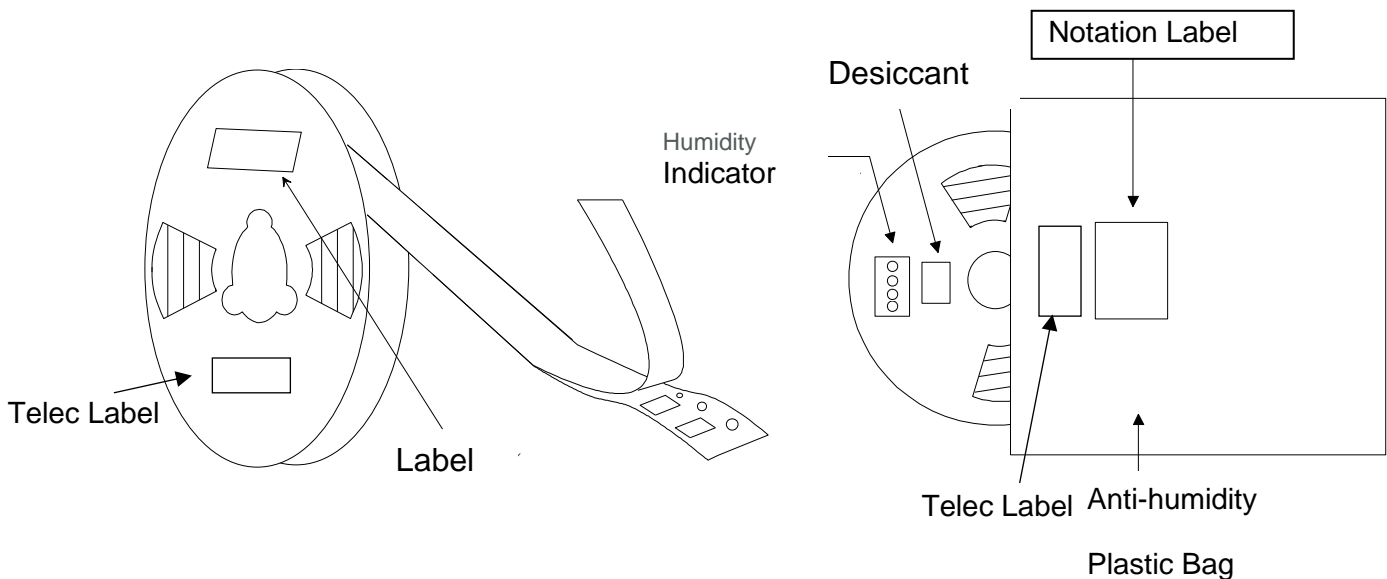



The package label may be attached on one side only.

Package label display example



※ 技術マークの直径は3mm以上

### Country of Origin

China

SHENZHEN MURATA TECHNOLOGY CO., LTD.

Some countries have applied for two countries, China and Japan, in preparation for future factory changes, but the production site in the delivery specifications is the above-mentioned factory in China.

If you want to change the country of manufacture, you need to agree with Murata Manufacturing in advance.

**This section includes regulatory certification information all the following countries:**

- Japan
- FCC
- ISED
- Europe



Precautions when using report number:

E2-2022-10030 ~ E2-2022-10035 (RF Conducted test result only) for final product DoC.

## 14.1 Japan

Manufacturer: Murata Manufacturing Co., Ltd.

Model or Product Name: LBEE5ZZ1XL and LBEE5ZZ2XS

This module has received "Certification of Construction Type" under the Japanese Radio Law.

### 電波法の要求に基づく警告

(警告)5GHz の周波数帯においては、5.2GHz/5.3GHz/5.6GHz 帯(W52/W53/W56)の 3 種類の帯域を使用することができます。5.2GHz/5.3GHz 帯無線 LAN(W52/W53)の屋外使用は 5.2GHz 帯高出力データ通信システムの基地局又は陸上移動中継局と通信する場合を除き電波法で禁止されています。

(English Translation)

Warning based on the requirements of Japanese Radio Act

(Warning) In the 5GHz frequency band, you can use 3 bands:  
5.2GHz/5.3GHz/5.6GHz(W52/W53/W56).

Outdoor use of 5.2GHz/5.3GHz band wireless LANs(W52/W53) is prohibited by the Radio Act except when communicating with 5.2GHz band high-power data communication system base stations or land mobile relay stations.



2.4GHz と 5GHz(W52,W53,W56)で使用するモジュールです。  
W53/W56 は子局としてのみ動作させてください。

(English Translation)

This is a module for use at 2.4GHz and 5GHz(W52, W53, W56).  
Operate the W53/W56 only as a client mode.

## Power Table

### Power Level 2.4GHz WLAN

SISO, MIMO, Simultaneous transmission per Antenna port

mode	Band	Channel	Rate	MAXIMUM TUNE UP TOLERANCE [dBm]
IEEE 802.11b	2.4GHz	1~13	All Rate	11.0 ± 2.0
IEEE 802.11g	2.4GHz	1~13	All Rate	13.0 ± 2.0
IEEE 802.11n(HT20)	2.4GHz	1~13	All Rate	13.0 ± 2.0
IEEE 802.11n(HT40)	2.4GHz	3~11	All Rate	13.0 ± 2.0
IEEE 802.11ac(VHT20)	2.4GHz	1~13	All Rate	13.0 ± 2.0
IEEE 802.11ac(VHT40) equivalent	2.4GHz	3~11	All Rate	13.0 ± 2.0
IEEE 802.11ax(HE20)	2.4GHz	1~13	All Rate	13.0 ± 2.0
IEEE 802.11ax(HE40)	2.4GHz	3~11	All Rate	13.0 ± 2.0

### Power Level 2.4GHz BT/BLE

Mode	MAXIMUM TUNE UP TOLERANCE [dBm]
BR	3.0 ± 3.0
EDR	0.0 ± 3.0
LE	3.0 ± 3.0
LE 2Mbps	3.0 ± 3.0

### Power Level 5GHz WLAN

SISO, MIMO, Simultaneous transmission per Antenna port

mode	Band	Channel	Rate	MAXIMUM TUNE UP TOLERANCE [dBm]
IEEE 802.11a	W52	36~48	All Rate	10.0 ± 2.0
	W53	52~64	All Rate	10.0 ± 2.0
	W56	100~144	6Mbps~36Mbps	17.0 ± 2.0
			48Mbps, 54Mbps	16.0 ± 2.0

mode	Band	Channel	Rate	MAXIMUM TUNE UP TOLERANCE [dBm]
IEEE 802.11n(HT20)	W52	36~48	All Rate	10.0 ± 2.0
	W53	52~64	All Rate	10.0 ± 2.0
	W56	100~144	All Rate	16.0 ± 2.0

mode	Band	Channel	Rate	MAXIMUM TUNE UP TOLERANCE [dBm]
IEEE 802.11n(HT40)	W52	42	All Rate	10.0 ± 2.0
	W53	58	All Rate	10.0 ± 2.0
	W56	102~142	All Rate	16.0 ± 2.0

mode	Band	Channel	Rate	MAXIMUM TUNE UP TOLERANCE [dBm]
IEEE 802.11ac(VHT20)	W52	36~48	All Rate	10.0 ± 2.0
	W53	52~64	All Rate	10.0 ± 2.0
	W56	100~144	VHT_SS1_MCS0~VHT_SS1_MCS7	16.0 ± 2.0
			VHT_SS1_MCS8	15.0 ± 2.0

mode	Band	Channel	Rate	MAXIMUM TUNE UP TOLERANCE [dBm]
IEEE 802.11ac(VHT40)	W52	38, 46	All Rate	10.0 ± 2.0
	W53	54, 62	All Rate	10.0 ± 2.0
	W56	102~142	VHT_SS1_MCS0~VHT_SS1_MCS7	16.0 ± 2.0
			VHT_SS1_MCS8, VHT_SS1_MCS9	15.0 ± 2.0

mode	Band	Channel	Rate	MAXIMUM TUNE UP TOLERANCE [dBm]
IEEE 802.11ac(VHT80)	W52	42	All Rate	10.0 ± 2.0
	W53	58	All rate	10.0 ± 2.0
	W56	106~138	VHT_SS1_MCS0~VHT_SS1_MCS7	15.0 ± 2.0
			VHT_SS1_MCS8, VHT_SS1_MCS9	14.0 ± 2.0

mode	Band	Channel	Rate	MAXIMUM TUNE UP TOLERANCE [dBm]
IEEE 802.11ax(HE20)	W52	36~48	All Rate	10.0 ± 2.0
	W53	52~64	All Rate	10.0 ± 2.0
	W56	100~144	HE_MCS0~HE_MCS7	16.0 ± 2.0
			HE_MCS8, HE_MCS9	15.0 ± 2.0
HE_MCS10, HE_MCS11			14.0 ± 2.0	

Mode	Band	Channel	Rate	MAXIMUM TUNE UP TOLERANCE [dBm]
IEEE 802.11ax(HE40)	W52	38, 46	All Rate	10.0 ± 2.0
	W53	54, 62	All Rate	10.0 ± 2.0
	W56	102~142	HE_MCS0~HE_MCS7	16.0 ± 2.0
			HE_MCS8, HE_MCS9	15.0 ± 2.0
HE_MCS10, HE_MCS11			14.0 ± 2.0	

Mode	Band	Channel	Rate	MAXIMUM TUNE UP TOLERANCE [dBm]
IEEE 802.11ax(HE80)	W52	42	All Rate	10.0 ± 2.0
	W53	58	All rate	10.0 ± 2.0
	W56	106~138	HE_MCS0~HE_MCS7	15.0 ± 2.0
			HE_MCS8~HE_MCS11	14.0 ± 2.0

## Theory of Operation

Frequency of operation			Scan	Ad-hoc mode
2.4GHz	11b/g/n/ac/ax(BW20)	2412-2472MHz	Active	Yes
	11n/ac/ax(BW40)	2422-2462MHz	Active	Yes
	BT	2402-2480MHz	N/A	N/A
	BLE	2402-2480MHz	N/A	N/A
W52	11a/n/ac/ax(BW20)	5180-5240MHz	Active	Yes
	11n/ac/ax(BW40)	5190-5230MHz	Active	Yes
	11ac/ax(BW80)	5210MHz	Active	Yes
W53	11a/n/ac/ax(BW20)	5260-5320MHz	Passive	No
	11n/ac/ax(BW40)	5270-5310MHz	Passive	No
	11ac/ax(BW80)	5290MHz	Passive	No
W56	11a/n/ac/ax(BW20)	5500-5720MHz	Passive	No
	11n/ac/ax(BW40)	5510-5710MHz	Passive	No
	11ac/ax(BW80)	5530-5690MHz	Passive	No

\*DFS MASTER function not available.

\*DFS client function available.

\*There is a TPC function.

Antenna

With simultaneous transmission of SISOx2 and MIMO.

The Typ values in the above table are all "setting values". Same value for SISOx1, SISOx2, and MIMO. Therefore, in the case of SISOx2 or MIMO, the output power (theoretical value) is 3dBm higher than that of SISOx1.

Setting value is Typ, WLAN deviation is  $\pm 2$ dB, BTBLE deviation is  $\pm 3$ dB.

Antenna registered under the Japan Radio Act

P/N	Vendor	Form factor	Type	2.4 GHz Gain	5 GHz Gain
146153	Molex	U.FL/PCB	Di-pole	3.2 dBi	4.25 dBi
WT32D1-KX	Unictron	U.FL/PCB	Di-pole	3 dBi	4 dBi
206994	Molex	U.FL/PCB	monopole	3.6 dBi	3.6 dBi

### Notification

It is recommended that the indication of (1) or (2) below is described on the product incorporating this module in Japanese. If there is any problem with the indication of (1) or (2) on the product, we recommend to indicate (1) or (2) in the user manual or on the package of the product incorporating this module, or electronic display on the product. In the case of the electronic display, it is necessary to describe "using the electronic display" + "how to reach to below indication" in the user manual of the product.

(1)

本製品は、電波法に基づく工事設計認証(認証番号:001-P01770)を受けた特定無線設備を内蔵しています。

(2)

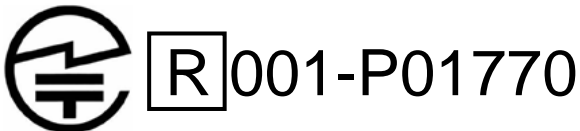

5.2GHz/5.3GHz 帯無線 LAN(W52/W53)の屋外使用は 5.2GHz 帯高出力データ通信システムの基地局又は陸上移動中継局と通信する場合を除き電波法で禁止されています。

(English Translation)

(1)

This product incorporates specified radio equipment that has received CERTIFICATION for TYPE CERTIFICATION (certification number: 001-P01770) based on the Japan Radio Act.

(2)

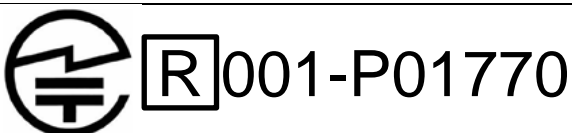

Outdoor use of 5.2GHz/5.3GHz band wireless LANs (W52/W53) is prohibited by the Radio Act except when communicating with 5.2GHz band high-power data communication system base stations or land mobile relay stations.

## 14.2 FCC

Model Name: LBEE5ZZ1XL

FCC ID: VPYLBEE5ZZ1XL

Since this module is not sold to general end users directly, there is no user manual of module. For the details about this module, please refer to the specification sheet of module. This module should be installed in the host device according to the interface specification (installation procedure)

The OEM integrator has to be aware not to provide information to the end user regarding how to install or remove this RF module in the end user's manual of the end product which integrates this module. The end user manual shall include all required regulatory information/warning as shown in User manual.

This device complies with part 15 of the FCC Rules. Operation is subject to the following two conditions: (1) This device may not cause harmful interference, and (2) this device must accept any interference received, including interference that may cause undesired operation.

FCC CAUTION Changes or modifications not expressly approved by the party responsible for compliance could void the user's authority to operate the equipment.

This transmitter must not be co-located or operated in conjunction with any other antenna or transmitter.

This device complies with below part 15 of the FCC Rules.  
Part 15 Subpart C  
Part 15 Subpart E

The modular transmitter is only FCC authorized for the specific rule parts (i.e., FCC transmitter rules) listed on the grant, and the host product manufacturer is responsible for compliance to any other FCC rules that apply to the host not covered by the modular transmitter grant of certification. The final host product still requires Part 15 Subpart B compliance testing with the modular transmitter installed.

This module designed for mounting inside of the end product by us professionally. Therefore, it complies with the antenna and transmission system requirements of §15.203.

Pin Layout

<TOP VIEW>

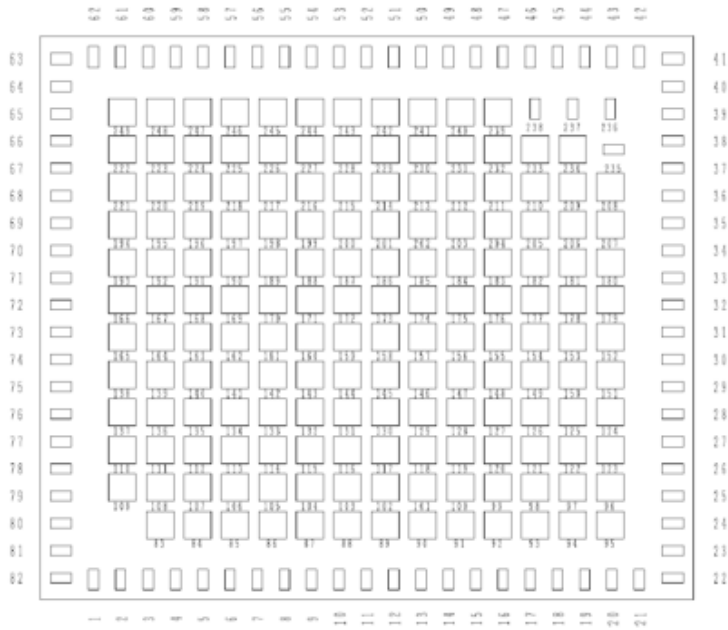

No.	Terminal Name	No.	Terminal Name	No.	Terminal Name
1	GND	31	GND	61	GPIO[26]
2	GND	32	NC	62	GPIO[27]
3	CONFIG_HOST[0]	33	NC	63	GND
4	CONFIG_HOST[1]	34	GND	64	GND
5	CONFIG_HOST[2]	35	VIO_SD	65	BT_RF_OUT
6	GPIO[1]	36	SD_CLK	66	GND
7	GPIO[0]	37	SD_CMD	67	GND
8	GPIO[14]	38	SD_D[0]	68	NC
9	GPIO[4]	39	SD_D[1]	69	GND
10	GPIO[6]	40	SD_D[2]	70	GPIO[22]
11	GPIO[5]	41	GND	71	GPIO[23]
12	GPIO[7]	42	SD_D[3]	72	GPIO[19]
13	GPIO[16]	43	PCIE_PERST_N	73	GPIO[18]
14	GPIO[15]	44	PCIE_CLKREQ_N	74	GPIO[17]
15	PDn	45	PCIE_WAKE_N	75	GND
16	GND	46	W_DISABLE1N	76	WL_B_ANT/ WL_B_BT_ANT
17	VDD33	47	GPIO[31]	77	GND
18	VDD33	48	GPIO[29]	78	GND
19	VIO	49	GPIO[30]	79	GND
20	VDD18	50	GPIO[28]	80	WL_A_ANT
21	VDD18	51	GPIO[3]	81	GND
22	GND	52	GPIO[2]	82	GND
23	PCIE_CLK_N	53	GPIO[11]	83-234	GND
24	PCIE_CLK_P	54	GPIO[10]	235	RF_CNTL0_N
25	GND	55	GPIO[9]	236	RF_CNTL3_P
26	PCIE_TX_P	56	GPIO[8]	237	RF_CNTL2_N
27	PCIE_TX_N	57	GPIO[12]	238	RF_CNTL1_P
28	GND	58	GPIO[13]	239-248	GND
29	PCIE_RX_N	59	GPIO[24]	249	NC
30	PCIE_RX_P	60	GPIO[25]	-	-

About PIN No.65 LBEE5ZZ1XL: “BT\_RF\_OUT” LBEE5ZZ2XS: “NC”



### Supply Voltage

DUT PIN Name	Min.	Typ.	Max.	unit
VDD33	3.14	3.3	3.46	V
VDD18	1.71	1.8	1.89	V
VIO	1.71	1.8	1.89	V
	3.14	3.3	3.46	
VIO_SD	1.71	1.8	1.89	V
	3.14	3.3	3.46	

VIO,VIO\_SD have two systems, 1.8V system and 3.3V system.

However, these do not affect the RF characteristics.

### Operating Temperature

	Min.	Typ.	Max.	Unit
Temperature	-40	25	85	deg. C

### Power Table

#### Setting RF Power

#### 2.4GHz WLAN

Mode	Rate / MCS index	Channel	MAXIMUM TUNE UP TOLERANCE [dBm]
IEEE 802.11b	All Rate	1,11	14.0 ± 2.0
		2~10	18.0 ± 2.0
IEEE 802.11g	All Rate	1,11	10.0 ± 2.0
	6Mbps,9Mbps,12Mbps,18Mbps,24Mbps,36Mbps	2~10	17.0 ± 2.0
	48Mbps,54Mbps	2~10	16.0 ± 2.0
IEEE 802.11n(HT20)	All MCS index	1	8.0 ± 2.0
	All MCS index	11	10.0 ± 2.0
	MCS0,MCS1,MCS2	2~10	16.0 ± 2.0
	MCS3,MCS4,MCS5,MCS6,MCS7	2~10	15.0 ± 2.0
IEEE 802.11n(HT40)	All MCS index	3	9.0 ± 2.0
		9	8.0 ± 2.0
		4~8	14.0 ± 2.0

Mode	MCS index	Channel	MAXIMUM TUNE UP TOLERANCE [dBm]
IEEE 802.11ac(VHT20) equivalent	All MCS index	1	8.0 ± 2.0
		10	10.0 ± 2.0
	MCS0,MCS1,MCS2	2~10	16.0 ± 2.0
	MCS3,MCS4,MCS5,MCS6,MCS7	2~10	15.0 ± 2.0
	MCS8	2~10	14.0 ± 2.0
IEEE 802.11ac(VHT40) equivalent	All MCS index	3	9.0 ± 2.0
		9	8.0 ± 2.0
		4~8	14.0 ± 2.0

Mode	MCS index	Channel	RU	MAXIMUM TUNE UP TOLERANCE [dBm]
IEEE 802.11ax(HE20)	All MCS index	1	All tone	8.0 ± 2.0
	MCS0,MCS1,MCS2	2~10	All tone	16.0 ± 2.0
	MCS3,MCS4,MCS5,MCS6,MCS7	2~10	All tone	15.0 ± 2.0
	MCS8,MCS9	2~10	All tone	14.0 ± 2.0
	MCS10,MCS11	2~10	All tone	13.0 ± 2.0
		11	All tone	10.0 ± 2.0
IEEE 802.11ax(HE40)	All MCS index	3	484 tone (Full tone)	9.0 ± 2.0
			26 tone	8.0 ± 2.0
			52 tone	8.0 ± 2.0
			106tone	8.0 ± 2.0
			242 tone	9.0 ± 2.0
	MCS0,MCS1,MCS2,MCS3,MCS4, MCS5,MCS6,MCS7,MCS8,MCS9	4~8	All tone	14.0 ± 2.0
		MCS10,MCS11	4~8	All tone
	All MCS index	9	484 tone (Full tone)	8.0 ± 2.0
			26 tone	8.0 ± 2.0
			52 tone	8.0 ± 2.0
			106 tone	8.0 ± 2.0
242 tone			6.0 ± 2.0	

## 2.4GHz BLUETOOTH

Mode	MAXIMUM TUNE UP TOLERANCE [dBm]
BR	3.0 ± 3.0
EDR	0.0 ± 3.0
LE	3.0 ± 3.0
LE 2Mbps	3.0 ± 3.0

## 5GHz WLAN

Mode	Rate	Band	Channel	MAXIMUM TUNE UP TOLERANCE [dBm]
IEEE 802.11a	All Rate	W52/W53	36,64	13.0 ± 2.0
	All Rate	W52/W53	40~48	15.0 ± 2.0
	All Rate	W52/W53	52,56	16.0 ± 2.0
	6Mbps,9Mbps,12Mbps,18Mbps,24Mbps,36Mbps	W52/W53	60	17.0 ± 2.0
	48Mbps,54Mbps	W52/W53	60	16.0 ± 2.0
	All Rate	W56	100~136	14.0 ± 2.0
	All Rate	W56	140	13.0 ± 2.0
	All Rate	W56	144	16.0 ± 2.0
	6Mbps,9Mbps,12Mbps,18Mbps,24Mbps,36Mbps	W58	149~161	17.0 ± 2.0
	48Mbps,54Mbps	W58	149~161	16.0 ± 2.0
	All Rate	W58	165	12.0 ± 2.0

Mode	MCS index	Band	Channel	MAXIMUM TUNE UP TOLERANCE [dBm]
IEEE 802.11n (HT20)	All MCS index	W52/W53	36	12.0 ± 2.0
	All MCS index	W52/W53	40	15.0 ± 2.0
	All MCS index	W52/W53	44~60	16.0 ± 2.0
	All MCS index	W56	100~136	14.0 ± 2.0
	All MCS index	W56	140	12.0 ± 2.0
	All MCS index	W58	149~161	16.0 ± 2.0
	All MCS index	W58	165	12.0 ± 2.0

Mode	MCS index	Band	Channel	MAXIMUM TUNE UP TOLERANCE [dBm]
IEEE 802.11n (HT40)	All MCS index	W52/W53	38,62	11.0 ± 2.0
	All MCS index	W52/W53	46	16.0 ± 2.0
	All MCS index	W52/W53	54	14.0 ± 2.0
	All MCS index	W56	102	12.0 ± 2.0
	All MCS index	W56	110	13.0 ± 2.0
	All MCS index	W56	118~134	14.0 ± 2.0
	All MCS index	W56	142	16.0 ± 2.0
	All MCS index	W58	151	16.0 ± 2.0
	All MCS index	W58	159	12.0 ± 2.0

Mode	MCS index	Band	Channel	MAXIMUM TUNE UP TOLERANCE [dBm]
IEEE 802.11ac (VHT20)	All MCS index	W52/W53	36	12.0 ± 2.0
	All MCS index	W52/W53	40	15.0 ± 2.0
	MCS0,MCS1,MCS2,MCS3, MCS4,MCS5,MCS6,MCS7	W52/W53	44~60	16.0 ± 2.0
	MCS8	W52/W53	44~60	15.0 ± 2.0
	All MCS index	W52/W53	64	13.0 ± 2.0
	All MCS index	W56	100~136	14.0 ± 2.0
	All MCS index	W56	140	12.0 ± 2.0
	MCS0,MCS1,MCS2,MCS3, MCS4,MCS5,MCS6,MCS7	W56	144	16.0 ± 2.0
	MCS8	W56	144	15.0 ± 2.0
	MCS0,MCS1,MCS2,MCS3, MCS4,MCS5,MCS6,MCS7	W58	149~161	16.0 ± 2.0
	MCS8	W58	149~161	15.0 ± 2.0
	All MCS index	W58	165	12.0 ± 2.0

Mode	MCS index	Band	Channel	MAXIMUM TUNE UP TOLERANCE [dBm]
IEEE 802 11ac (VHT40)	All MCS index	W52/W53	38,62	11.0 ± 2.0
	MCS0,MCS1,MCS2,MCS3, MCS4,MCS5,MCS6,MCS7	W52/W53	46	16.0 ± 2.0
	MCS8,MCS9	W52/W53	46	15.0 ± 2.0
	All MCS index	W52/W53	54	14.0 ± 2.0
	All MCS index	W56	102	12.0 ± 2.0
	All MCS index	W56	110	13.0 ± 2.0
	All MCS index	W56	118~134	14.0 ± 2.0
	MCS0,MCS1,MCS2,MCS3, MCS4,MCS5,MCS6,MCS7	W56	142	16.0 ± 2.0
	MCS8,MCS9	W56	142	15.0 ± 2.0
	MCS0,MCS1,MCS2,MCS3, MCS4,MCS5,MCS6,MCS7	W58	151	16.0 ± 2.0
	MCS8,MCS9	W58	151	15.0 ± 2.0
	All MCS index	W58	159	12.0 ± 2.0

Mode	MCS index	Band	Channel	MAXIMUM TUNE UP TOLERANCE [dBm]
IEEE 802 11ac (VHT80)	All MCS index	W52/W53	42,58	9.0 ± 2.0
	All MCS index	W56	106	9.0 ± 2.0
	MCS0,MCS1,MCS2,MCS3, MCS4,MCS5,MCS6,MCS7	W56	122,138	15.0 ± 2.0
	MCS8,MCS9	W56	122,138	14.0 ± 2.0
	MCS0,MCS1,MCS2,MCS3, MCS4,MCS5,MCS6,MCS7	W58	155	15.0 ± 2.0
	MCS8,MCS9	W58	155	14.0 ± 2.0

Mode	MCS index	Band	Channel	RU	MAXIMUM TUNE UP TOLERANCE [dBm]
IEEE 802.11ax (HE20)	All MCS index	W52/W53	36	242 tone (Full tone)	12.0 ± 2.0
				26 tone	9.0 ± 2.0
				52 tone	10.0 ± 2.0
				106 tone	12.0 ± 2.0
	MCS0,MCS1,MCS2,MCS3, MCS4,MCS5,MCS6,MCS7, MCS8,MCS9	W52/W53	40	242 tone (Full tone)	15.0 ± 2.0
				26 tone	9.0 ± 2.0
				52 tone	10.0 ± 2.0
				106 tone	13.0 ± 2.0
	MCS10,MCS11	W52/W53	40	242 tone (Full tone)	14.0 ± 2.0
				26 tone	9.0 ± 2.0
				52 tone	10.0 ± 2.0
				106 tone	13.0 ± 2.0
	MCS0,MCS1,MCS2,MCS3, MCS4,MCS5,MCS6,MCS7	W52/W53	44~60	242 tone (Full tone)	16.0 ± 2.0
				26 tone	9.0 ± 2.0
				52 tone	10.0 ± 2.0
				106 tone	13.0 ± 2.0
	MCS8,MCS9	W52/W53	44~60	242 tone (Full tone)	15.0 ± 2.0
				26 tone	9.0 ± 2.0
				52 tone	10.0 ± 2.0
				106 tone	13.0 ± 2.0
	MCS10,MCS11	W52/W53	44~60	242 tone (Full tone)	14.0 ± 2.0
				26 tone	9.0 ± 2.0
				52 tone	10.0 ± 2.0
				106 tone	13.0 ± 2.0
All MCS index	W52/W53	64	242 tone (Full tone)	13.0 ± 2.0	
			26 tone	8.0 ± 2.0	
			52 tone	10.0 ± 2.0	
			106 tone	13.0 ± 2.0	

Mode	MCS index	Band	Channel	RU	MAXIMUM TUNE UP TOLERANCE [dBm]
IEEE 802.11ax (HE20)	All MCS index	W56	100~136	242 tone(Full tone)	14.0 ± 2.0
				26 tone	8.0 ± 2.0
				52 tone	11.0 ± 2.0
				106 tone	12.0 ± 2.0
	All MCS index	W56	140	242 tone(Full tone)	12.0 ± 2.0
				26 tone	5.0 ± 2.0
				52 tone	9.0 ± 2.0
				106 tone	10.0 ± 2.0
	MCS0,MCS1,MCS2,MCS3, MCS4,MCS5,MCS6,MCS7	W56	144	242 tone(Full tone)	16.0 ± 2.0
				26 tone	8.0 ± 2.0
				52 tone	11.0 ± 2.0
				106 tone	12.0 ± 2.0
	MCS8,MCS9	W56	144	242 tone(Full tone)	15.0 ± 2.0
				26 tone	8.0 ± 2.0
				52 tone	11.0 ± 2.0
				106 tone	12.0 ± 2.0
	MCS10,MCS11	W56	144	242 tone(Full tone)	14.0 ± 2.0
				26 tone	8.0 ± 2.0
				52 tone	11.0 ± 2.0
				106 tone	12.0 ± 2.0
	MCS0,MCS1,MCS2,MCS3, MCS4,MCS5,MCS6,MCS7	W58	149~161	All tone	16.0 ± 2.0
	MCS8,MCS9	W58	149~161	All tone	15.0 ± 2.0
	MCS10,MCS11	W58	149~161	All tone	14.0 ± 2.0
	All MCS index	W58	165	All tone	12.0 ± 2.0

Mode	MCS index	Band	Channel	RU	MAXIMUM TUNE UP TOLERANCE [dBm]
IEEE 802.11ax (HE40)	All MCS index	W52/W53	38	484 tone (Full tone)	11.0 ± 2.0
				26 tone	9.0 ± 2.0
				52 tone	10.0 ± 2.0
				106 tone	11.0 ± 2.0
				242 tone	10.0 ± 2.0
	MCS0,MCS1,MCS2,MCS3, MCS4,MCS5,MCS6,MCS7	W52/W53	46	484 tone (Full tone)	16.0 ± 2.0
				26 tone	9.0 ± 2.0
				52 tone	10.0 ± 2.0
				106 tone	13.0 ± 2.0
				242 tone	14.0 ± 2.0
	MCS8,MCS9	W52/W53	46	484 tone (Full tone)	15.0 ± 2.0
				26 tone	9.0 ± 2.0
				52 tone	10.0 ± 2.0
				106 tone	13.0 ± 2.0
				242 tone	14.0 ± 2.0
	MCS10,MCS11	W52/W53	46	484 tone (Full tone)	14.0 ± 2.0
				26 tone	9.0 ± 2.0
				52 tone	10.0 ± 2.0
				106 tone	13.0 ± 2.0
				242 tone	14.0 ± 2.0



Mode	MCS index	Band	Channel	RU	MAXIMUM TUNE UP TOLERANCE [dBm]
IEEE 802.11ax (HE40)	All MCS index	W52/W53	54	484 tone (Full tone)	14.0 ± 2.0
				26 tone	9.0 ± 2.0
				52 tone	10.0 ± 2.0
				106 tone	13.0 ± 2.0
				242 tone	14.0 ± 2.0
	All MCS index	W52/W53	62	484 tone (Full tone)	11.0 ± 2.0
				26 tone	8.0 ± 2.0
				52 tone	10.0 ± 2.0
				106 tone	11.0 ± 2.0
				242 tone	10.0 ± 2.0
	All MCS index	W56	102	484 tone (Full tone)	12.0 ± 2.0
				26 tone	8.0 ± 2.0
				52 tone	11.0 ± 2.0
				106 tone	12.0 ± 2.0
				242 tone	6.0 ± 2.0
	All MCS index	W56	110	484 tone (Full tone)	13.0 ± 2.0
				26 tone	8.0 ± 2.0
				52 tone	11.0 ± 2.0
				106 tone	12.0 ± 2.0
				242 tone	13.0 ± 2.0
All MCS index	W56	118~126	484 tone (Full tone)	14.0 ± 2.0	
			26 tone	8.0 ± 2.0	
			52 tone	11.0 ± 2.0	
			106 tone	12.0 ± 2.0	
			242 tone	14.0 ± 2.0	

Mode	MCS index	Band	Channel	RU	MAXIMUM TUNE UP TOLERANCE [dBm]
IEEE 802 11ax (HE40)	All MCS index	W56	134	484 tone (Full tone)	14.0 ± 2.0
				26 tone	8.0 ± 2.0
				52 tone	11.0 ± 2.0
				106 tone	12.0 ± 2.0
				242 tone	9.0 ± 2.0
	MCS0,MCS1,MCS2,MCS3, MCS4,MCS5,MCS6,MCS7	W56	142	484 tone (Full tone)	16.0 ± 2.0
				26 tone	8.0 ± 2.0
				52 tone	11.0 ± 2.0
				106 tone	12.0 ± 2.0
				242 tone	14.0 ± 2.0
	MCS8,MCS9	W56	142	484 tone (Full tone)	15.0 ± 2.0
				26 tone	8.0 ± 2.0
				52 tone	11.0 ± 2.0
				106 tone	12.0 ± 2.0
				242 tone	14.0 ± 2.0
	MCS10,MCS11	W56	142	484 tone (Full tone)	14.0 ± 2.0
				26 tone	8.0 ± 2.0
				52 tone	11.0 ± 2.0
				106 tone	12.0 ± 2.0
				242 tone	14.0 ± 2.0
MCS0,MCS1,MCS2,MCS3, MCS4,MCS5,MCS6,MCS7	W58	151	All tone	16.0 ± 2.0	
MCS8,MCS9	W58	151	All tone	15.0 ± 2.0	
MCS10,MCS11	W58	151	All tone	14.0 ± 2.0	
All MCS index	W58	159	All tone	12.0 ± 2.0	

Mode	MCS index	Band	Channel	RU	MAXIMUM TUNE UP TOLERANCE [dBm]
IEEE 802 11ax (HE80)	All MCS index	W52/W53	42	996 tone (Full tone)	9.0 ± 2.0
				26 tone	9.0 ± 2.0
				52 tone	9.0 ± 2.0
				106 tone	9.0 ± 2.0
				242 tone	9.0 ± 2.0
				484 tone	8.0 ± 2.0
	All MCS index	W52/W53	58	996 tone (Full tone)	9.0 ± 2.0
				26 tone	8.0 ± 2.0
				52 tone	9.0 ± 2.0
				106 tone	9.0 ± 2.0
				242 tone	9.0 ± 2.0
				484 tone	8.0 ± 2.0
	All MCS index	W56	106	996 tone (Full tone)	9.0 ± 2.0
				26 tone	8.0 ± 2.0
				52 tone	9.0 ± 2.0
				106 tone	9.0 ± 2.0
				242 tone	6.0 ± 2.0
				484 tone	9.0 ± 2.0
	MCS0,MCS1,MCS2, MCS3,MCS4,MCS5, MCS6,MCS7	W56	122	996 tone (Full tone)	15.0 ± 2.0
				26 tone	8.0 ± 2.0
				52 tone	11.0 ± 2.0
				106 tone	12.0 ± 2.0
				242 tone	14.0 ± 2.0
				484 tone	15.0 ± 2.0
MCS8,MCS9, MCS10,MCS11	W56	122	996 tone (Full tone)	14.0 ± 2.0	
			26 tone	8.0 ± 2.0	
			52 tone	11.0 ± 2.0	
			106 tone	12.0 ± 2.0	
			242 tone	14.0 ± 2.0	
			484 tone	14.0 ± 2.0	

Mode	MCS index	Band	Channel	RU	MAXIMUM TUNE UP TOLERANCE [dBm]
IEEE 802 11ax (HE80)	MCS0,MCS1,MCS2,MCS3, MCS4,MCS5,MCS6,MCS7	W56	138	996 tone (Full tone)	15.0 ± 2.0
				26 tone	8.0 ± 2.0
				52 tone	11.0 ± 2.0
				106 tone	12.0 ± 2.0
				242 tone	14.0 ± 2.0
				484 tone	15.0 ± 2.0
	MCS8,MCS9,MCS10,MCS11	W56	138	996 tone (Full tone)	14.0 ± 2.0
				26 tone	8.0 ± 2.0
				52 tone	11.0 ± 2.0
				106 tone	12.0 ± 2.0
				242 tone	14.0 ± 2.0
				484 tone	14.0 ± 2.0
	MCS0,MCS1,MCS2,MCS3, MCS4,MCS5,MCS6,MCS7	W58	155	996 tone (Full tone)	15.0 ± 2.0
				26 tone	15.0 ± 2.0
				52 tone	15.0 ± 2.0
				106 tone	15.0 ± 2.0
				242 tone	12.0 ± 2.0
				484 tone	14.0 ± 2.0
	MCS8,MCS9,MCS10,MCS11	W58	155	996 tone (Full tone)	14.0 ± 2.0
				26 tone	14.0 ± 2.0
				52 tone	14.0 ± 2.0
				106 tone	14.0 ± 2.0
				242 tone	12.0 ± 2.0
				484 tone	14.0 ± 2.0

## Theory of Operation

Frequency of operation			Scan	Ad-hoc mode
2.4GHz	11b/g/n/ac/ax(BW20)	2412-2462MHz	Active	Yes
	11n/ac/ax(BW40)	2422-2452MHz	Active	Yes
	BT	2402-2480MHz	N/A	N/A
	BLE	2402-2480MHz	N/A	N/A
W52	11a/n/ac/ax(BW20)	5180-5240MHz	Active	Yes
	11n/ac/ax(BW40)	5190-5230MHz	Active	Yes
	11ac/ax(BW80)	5210MHz	Active	Yes
W53	11a/n/ac/ax(BW20)	5260-5320MHz	Passive	No
	11n/ac/ax(BW40)	5270-5310MHz	Passive	No
	11ac/ax(BW80)	5290MHz	Passive	No
W56	11a/n/ac/ax(BW20)	5500-5720MHz	Passive	No
	11n/ac/ax(BW40)	5510-5710MHz	Passive	No
	11ac/ax(BW80)	5530-5690MHz	Passive	No
W58	11a/n/ac/ax(BW20)	5745-5825MHz	Active	Yes
	11n/ac/ax(BW40)	5755-5795MHz	Active	Yes
	11ac/ax(BW80)	5775MHz	Active	Yes

\*DFS MASTER function not available.

\*DFS client function available.

\*There is a TPC function.

This manual is based on KDB 996369, which is designed to ensure that module manufacturer correctly communication the necessary information to host manufacturers that incorporate their modules.

## **INTEGRATION INSTRUCTIONS**

### **1. General: Applicable**

Sections 2 through 10 describe the items that must be provided in the integration instructions for host product manufacturers (e.g., OEM instruction manual) to use when integrating a module in a host product. This Modular transmitter applicant(muRata) should include information in their instructions for all these items indicating clearly when they are not applicable.

### **2. List of applicable FCC rules: Applicable**

This device complies with below part 15 of FCC Rules.  
 Part 15.247  
 Part 15.407

### **3. Summarize the specific operational use conditions : Applicable**

This module designed for mounting inside of the end product by us professionally.  
 Therefore, it complies with the antenna and transmission system requirements of §15.203.

### **4. Limited module procedures : Applicable**

This module does not supply a regulated voltage, it can only be used in a host that supplies regulated voltage. See page 12 About Power Supply(limited condition).

### **6. RF exposure considerations : Applicable**

This equipment complies with FCC radiation exposure limits set forth for an uncontrolled environment and meets the FCC radio frequency (RF) Exposure Guidelines. This equipment should be installed and operated keeping the radiator at least 20cm or more away from person's body.

It is necessary to take a SAR test with your set mounting this module (except to use only Bluetooth).

Class II permissive change application is necessary using the SAR report. Please contact Murata. And an application for a Class II permissive change from a Mobile equipment to a Portable equipment is also required.

Note)

Portable equipment : Equipment for which the spaces between human body and antenna are used within 20cm.

Mobile equipment : Equipment used at position in which the spaces between human body and antenna exceeded 20cm.

**7. Antennas : Applicable**

Part number	Vendor	Peak Gain(dBi)		Type	Connector
		2.4GHz	5GHz		
146153	Molex	3.2	4.25	Dipole	U.FL

**8. Label and compliance information : Applicable**

The following statements must be described on the user manual of the host device of this module;

Contains Transmitter Module FCC ID: VPYLBEE5ZZ1XL

or

Contains FCC ID: VPYLBEE5ZZ1XL

This device complies with part 15 of the FCC Rules. Operation is subject to the following two conditions: (1) This device may not cause harmful interference, and (2) this device must accept any interference received, including interference that may cause undesired operation.

\*If it is difficult to describe this statement on the host device due to the size, please describe in the user's manual and also either describe on the device packaging or on a removable label attached to the device

**FCC CAUTION**  
Changes or modifications not expressly approved by the party responsible for compliance could void the user's authority to operate the equipment.

Compliance with FCC requirement 15.407(c)  
Data transmission is always initiated by software, which is the passed down through the MAC, through the digital and analog baseband, and finally to the RF chip. Several special packets are initiated by the MAC. These are the only ways the digital baseband portion will turn on the RF transmitter, which it then turns off at the end of the packet. Therefore, the transmitter will be on only while one of the aforementioned packets is being transmitted. In other words, this device automatically discontinue transmission in case of either absence of information to transmit or operational failure.

Frequency Tolerance: ±20 ppm

This transmitter must not be co-located or operated in conjunction with any other antenna or transmitter.

When installing it in a mobile equipment. Please describe the following warning to the manual.

This equipment complies with FCC radiation exposure limits set forth for an uncontrolled environment and meets the FCC radio frequency (RF) Exposure Guidelines. This equipment should be installed and operated keeping the radiator at least 20cm or more away from person's body.

This module is only approval as a mobile equipment.

Therefore, do not install it on portable equipment.

If you wish to use it as a portable equipment, please contact Murata in advance as Class II application accompanied by SAR testing using the final product are required.

Note)

Portable equipment : Equipment for which the spaces between human body and antenna are used within 20cm.

Mobile equipment : Equipment used at position in which the spaces between human body and antenna exceeded 20cm.

### **9. Information on test modes and additional testing requirements: Applicable**

Please check the installation manual first.

Please contact Murata if you have any questions when conducting the RF certification test on the host.

We (Murata) are ready to present the control manual and others for the RF certification test.

### **10. Additional testing, Part 15 Subpart B disclaimer : Applicable**

The modular transmitter is only FCC authorized for the specific rule parts (i.e., FCC transmitter rules)

listed on the grant, and the host product manufacturer is responsible for compliance to any other FCC rules that apply to the host not covered by the modular transmitter grant of certification.

The final host product still requires Part 15 Subpart B compliance testing with the modular transmitter installed.

If the final product with this module is FCC Class A digital device, include the following in the manual of the final product:

Note: This equipment has been tested and found to comply with the limits for a Class A digital device, pursuant to part 15 of the FCC Rules. These limits are designed to provide reasonable protection against harmful interference when the equipment is operated in a commercial environment. This equipment generates, uses, and can radiate radio frequency energy and, if not installed and used in accordance with the instruction manual, may cause harmful interference to radio communications. Operation of this equipment in a residential area is likely to cause harmful interference in which case the user will be required to correct the interference at his own expense.



If the final product with this module is FCC Class B digital device, include the following in the manual of the final product:

Note: This equipment has been tested and found to comply with the limits for a Class B digital device, pursuant to part 15 of the FCC Rules. These limits are designed to provide reasonable protection against harmful interference in a residential installation. This equipment generates, uses and can radiate radio frequency energy and, if not installed and used in accordance with the instructions, may cause harmful interference to radio communications. However, there is no guarantee that interference will not occur in a particular installation. If this equipment does cause harmful interference to radio or television reception, which can be determined by turning the equipment off and on, the user is encouraged to try to correct the interference by one or more of the following measures:

- Reorient or relocate the receiving antenna.
- Increase the separation between the equipment and receiver.
- Connect the equipment into an outlet on a circuit different from that to which the receiver is connected.
- Consult the dealer or an experienced radio/TV technician for help.

### 11. Note EMI Considerations : Applicable

Note that a host manufacture is recommended to use KDB 996369 D04 Module Integration Guide recommending as

"best practice" RF design engineering testing and evaluation in case non-linear interactions generate

additional non-compliant limits due to module placement to host components or properties.

For standalone mode, reference the guidance in D04 Module Integration Guide and for simultaneous mode; see D02 Module Q&A Question 12, which permits the host manufacturer to confirm compliance.

### 12. How to make changes: Applicable

When changing from the conditions of approval, please present technical documentation that it is equivalent to a Class I change.

For example, when adding or changing an antenna, the following technical documents are required.

- 1)The document indicating the same type as the original antenna
- 2)Technical document showing that the gain is the same or lower than the gain at the time of the original approval
- 3)Technical document showing that the spurious is no more than 3 dB worse than when it was originally certified

### About Power supply(Limited condition)

This Module(LBEE5ZZ1XL and LBEE5ZZ2XS) have been approved as Limited Modular Approval. These modules do not have a voltage stabilizing circuit in the power path to the internal RF circuitry. Therefore, the Limited Condition must provide a stable power supply for the supply voltage to the module.

Please supply a stable power supply so that the voltage shown in the table below is applied.

Parameter		Min.	Typ.	Max.	unit
Supply Voltage	VDD33	3.14	3.3	3.46	V
	VDD18	1.71	1.8	1.89	V
	VIO	1.71 3.14	1.8 3.3	1.89 3.46	V
	VIO_SD	1.71 3.14	1.8 3.3	1.89 3.46	V

Microstrip trace line on the host PCB to the antenna connectors

#### ■ About the signal line between an antenna and a module

It is a 50-ohm line design.

Fine tuning of return loss etc. can be performed using a matching network.

However, it is required to check "Class1 change" and "Class2 change" which the authorities define then.

The concrete contents of a check as follows.

- 1) Different length and shapes affect radiated emissions, must confirm the same specification is used as the following page 14 and 15.
- 2) The emission level is not getting worse.

The following is the design of the EVB used for the test.

Certification tests are conducted in the following patterns.

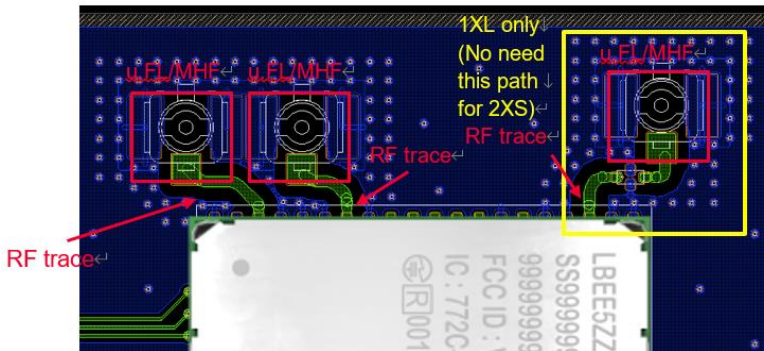

The 50ohm microstrip line needs to be copied when module is installed in the End product.  
Murata provides set makers with Gerber data or something similar.

About the Trace antenna and feed line of the jig where the certification test was conducted

Substrate type name of certification test jig: P2ML9917

feed line width : 0.4mm

Substrate thin :  $0.8 \pm 0.1$  mm

Substrate material: FR -4

Substrate thickness between GND layer and surface layer: 0.408mm

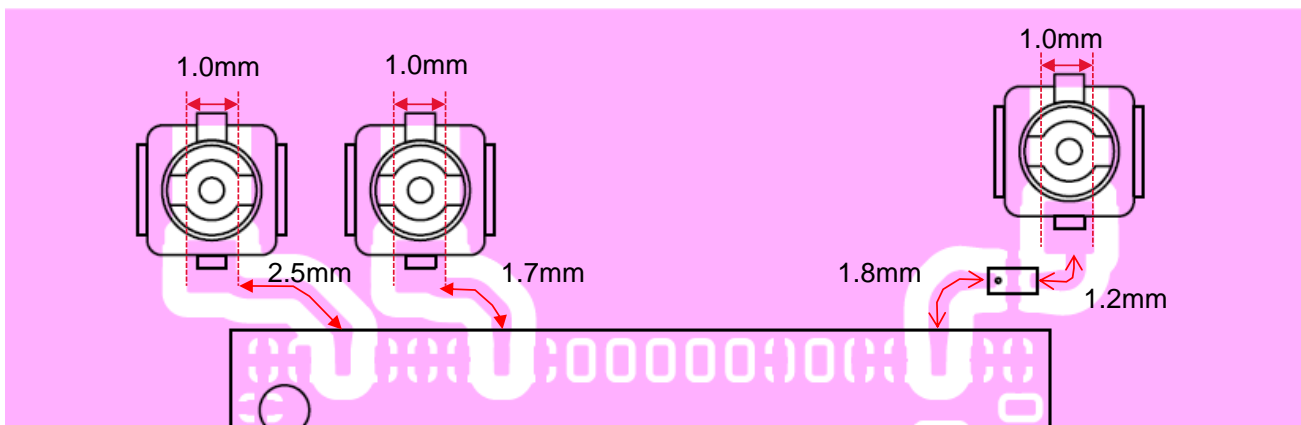

## 14.3 ISED

Model Name: "LBEE5ZZ1XL", "LBEE5ZZ2XS"

IC: 722C-LBEE5ZZ1XL

Since this module is not sold to general end users directly, there is no user manual of module. For the details about this module, please refer to the specification sheet of module. This module should be installed in the host device according to the interface specification (installation procedure)

The OEM integrator has to be aware not to provide information to the end user regarding how to install or remove this RF module in the end user's manual of the end product which integrates this module. The end user manual shall include all required regulatory information/warning as shown in User manual.

- The following information must be indicated on the host device of this module.

Contains IC: 772C-LBEE5ZZ1XL

- In case of the final product which can be carried around to outdoor.

The following indication is necessary to the final product.

- When the STA function is used in channel 52, 54, 58

At the time of the channel 52, 54 or 58 setting, please indicate "for indoor use only channel". During connecting, please show the channel number which connects. And please indicate that the end user may find out "for indoor use only channel".

- If the final product use the following frequency, please note that there is a limit.

for indoor use only(5150-5250MHz band and channel 52, 54, 58)

Pour usage intérieur seulement (5150-5250MHz band and channel 52, 54, 58)

- The following statements must be described on the user manual

of the host device of this module;

This device complies with Industry Canada's applicable licence-exempt RSSs. Operation is subject to the following two conditions:

- (1) This device may not cause interference; and
- (2) This device must accept any interference, including interference that may cause undesired operation of the device.

Le présent appareil est conforme aux CNR d'Industrie Canada applicables aux appareils radio exempts de licence. L'exploitation est autorisée aux deux conditions suivantes :

- 1) l'appareil ne doit pas produire de brouillage;
- 2) l'utilisateur de l'appareil doit accepter tout brouillage radioélectrique subi, même si le brouillage est susceptible d'en compromettre le fonctionnement.

● When installing it in a mobile equipment.

This equipment complies with IC radiation exposure limits set forth for an uncontrolled environment and meets RSS-102 of the IC radio frequency (RF) Exposure rules. This equipment should be installed and operated keeping the radiator at least 20cm or more away from person's body.

Cet équipement est conforme aux limites d'exposition aux rayonnements énoncées pour un environnement non contrôlé et respecte les règles d'exposition aux fréquences radioélectriques (RF) CNR-102 de l'IC. Cet équipement doit être installé et utilisé en gardant une distance de 20 cm ou plus entre le radiateur et le corps humain.

● When installing it in a portable equipment.

It is necessary to take a SAR test with your set mounting this module.  
 Class 4 permissive change application is necessary using the SAR report.  
 Please contact Murata.

Note)

Portable equipment : Equipment for which the spaces between human body and antenna are used within 20cm.

Mobile equipment : Equipment used at position in which the spaces between human body and antenna exceeded 20cm.

Data transmission is always initiated by software, which is the passed down through the MAC, through the digital and analog baseband, and finally to the RF chip. Several special packets are initiated by the MAC. These are the only ways the digital baseband portion will turn on the RF transmitter, which it then turns off at the end of the packet. Therefore, the transmitter will be on only while one of the aforementioned packets is being transmitted. In other words, this device automatically discontinues transmission in case of either absence of information to transmit or operational failure.

La transmission des données est toujours initiée par le logiciel, puis les données sont transmises par l'intermédiaire du MAC, par la bande de base numérique et analogique et, enfin, à la puce RF. Plusieurs paquets spéciaux sont initiés par le MAC. Ce sont les seuls moyens pour qu'une partie de la bande de base numérique active l'émetteur RF, puis désactive celui-ci à la fin du paquet. En conséquence, l'émetteur reste uniquement activé lors de la transmission d'un des paquets susmentionnés. En d'autres termes, ce dispositif interrompt automatiquement toute transmission en cas d'absence d'information à transmettre ou de défaillance.

This radio transmitter (IC Number: 772C-LBEE5ZZ1XL) has been approved by Innovation, Science and Economic Development Canada to operate with the antenna types listed below, with the maximum permissible gain indicated.  
 Antenna types not included in this list that have a gain greater than the maximum gain indicated for any type listed are strictly prohibited for use with this device.

Le présent émetteur radio (IC Number: 772C-LBEE5ZZ1XL) a été approuvé par Innovation, Sciences et Développement économique Canada pour fonctionner avec les types d'antenne énumérés ci-dessous et ayant un gain admissible maximal. Les types d'antenne non inclus dans cette liste, et dont le gain est supérieur au gain maximal indiqué pour

● If the antenna of the end product is removed, please describe the follow warning on the manual of the end product which contains this module.

This radio transmitter (772C-LBEE5ZZ1XL) has been approved by Innovation, Science and Economic Development Canada to operate with the antenna types listed below, with the maximum permissible gain indicated.

Antenna types not included in this list that have a gain greater than the maximum gain indicated for any type listed are strictly prohibited for use with this device.

: Dipole Antenna                      Gain: 3.2 dBi@2.4GHz/4.25 dBi@5GHz

Le présent émetteur radio (772C-LBEE5ZZ1XL) a été approuvé par Innovation, Sciences et Développement économique Canada pour fonctionner avec les types d'antenne énumérés ci-dessous et ayant un gain admissible maximal.

Les types d'antenne non inclus dans cette liste, et dont le gain est supérieur au gain maximal indiqué pour tout type figurant sur la liste, sont strictement interdits pour l'exploitation de l'émetteur.

: Dipole Antenna                      Gain: 3.2 dBi@2.4GHz/4.25 dBi@5GHz

### Pin Layout

<TOP VIEW>

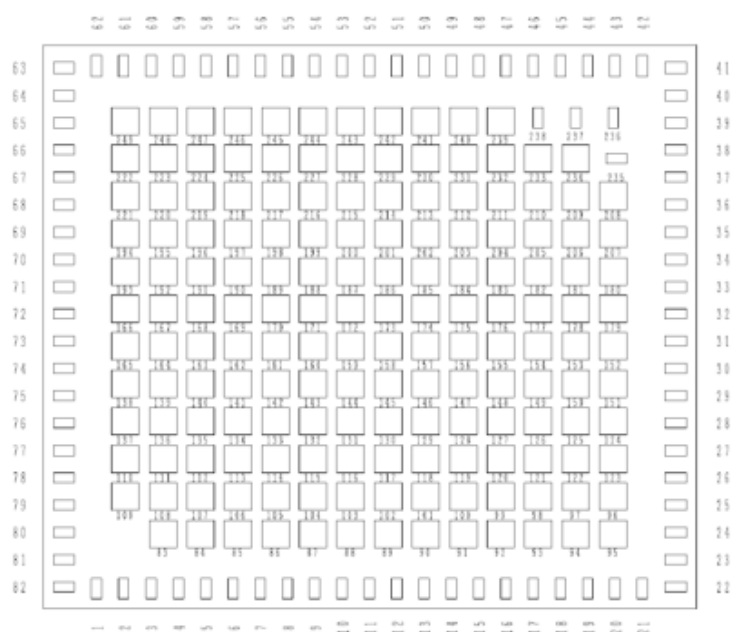

No.	Terminal Name	No.	Terminal Name	No.	Terminal Name
1	GND	31	GND	61	GPIO[26]
2	GND	32	NC	62	GPIO[27]
3	CONFIG_HOST[0]	33	NC	63	GND
4	CONFIG_HOST[1]	34	GND	64	GND
5	CONFIG_HOST[2]	35	VIO_SD	65	BT_RF_OUT
6	GPIO[1]	36	SD_CLK	66	GND
7	GPIO[0]	37	SD_CMD	67	GND
8	GPIO[14]	38	SD_D[0]	68	NC
9	GPIO[4]	39	SD_D[1]	69	GND
10	GPIO[6]	40	SD_D[2]	70	GPIO[22]
11	GPIO[5]	41	GND	71	GPIO[23]
12	GPIO[7]	42	SD_D[3]	72	GPIO[19]
13	GPIO[16]	43	PCIE_PERST_N	73	GPIO[18]
14	GPIO[15]	44	PCIE_CLKREQ_N	74	GPIO[17]
15	PDn	45	PCIE_WAKE_N	75	GND
16	GND	46	W_DISABLE1N	76	WL_B_ANT/ WL_B_BT_ANT
17	VDD33	47	GPIO[31]	77	GND
18	VDD33	48	GPIO[29]	78	GND
19	VIO	49	GPIO[30]	79	GND
20	VDD18	50	GPIO[28]	80	WL_A_ANT
21	VDD18	51	GPIO[3]	81	GND
22	GND	52	GPIO[2]	82	GND
23	PCIE_CLK_N	53	GPIO[11]	83-234	GND
24	PCIE_CLK_P	54	GPIO[10]	235	RF_CNTL0_N
25	GND	55	GPIO[9]	236	RF_CNTL3_P
26	PCIE_TX_P	56	GPIO[8]	237	RF_CNTL2_N
27	PCIE_TX_N	57	GPIO[12]	238	RF_CNTL1_P
28	GND	58	GPIO[13]	239-248	GND
29	PCIE_RX_N	59	GPIO[24]	249	NC
30	PCIE_RX_P	60	GPIO[25]	-	-

About PIN No.65 LBEE5ZZ1XL: “BT\_RF\_OUT” LBEE5ZZ2XS: “NC”

### Supply Voltage

DUT PIN Name	Min.	Typ.	Max.	unit
VDD33	3.14	3.3	3.46	V
VDD18	1.71	1.8	1.89	V
VIO	1.71	1.8	1.89	V
	3.14	3.3	3.46	
VIO_SD	1.71	1.8	1.89	V
	3.14	3.3	3.46	

VIO,VIO\_SD have two systems, 1.8V system and 3.3V system.

However, these do not affect the RF characteristics.

### Operating Temperature

	Min.	Typ.	Max.	Unit
Temperature	-40	25	85	deg. C

### Power Table

Setting RF Power

#### 2.4GHz WLAN

Mode	Rate / MCS index	Channel	MAXIMUM TUNE UP TOLERANCE [dBm]
IEEE 802.11b	All Rate	1,11	14.0 ± 2.0
		2~10	18.0 ± 2.0
IEEE 802.11g	All Rate	1,11	10.0 ± 2.0
	6Mbps,9Mbps,12Mbps,18Mbps,24Mbps,36Mbps	2~10	17.0 ± 2.0
	48Mbps,54Mbps	2~10	16.0 ± 2.0
IEEE 802.11n(HT20)	All MCS index	1	8.0 ± 2.0
	All MCS index	11	10.0 ± 2.0
	MCS0,MCS1,MCS2	2~10	16.0 ± 2.0
	MCS3,MCS4,MCS5,MCS6,MCS7	2~10	15.0 ± 2.0
IEEE 802.11n(HT40)	All MCS index	3	9.0 ± 2.0
		9	8.0 ± 2.0
		4~8	14.0 ± 2.0



Mode	MCS index	Channel	MAXIMUM TUNE UP TOLERANCE [dBm]
IEEE 802.11ac(VHT20) equivalent	All MCS index	1	8.0 ± 2.0
		10	10.0 ± 2.0
	MCS0,MCS1,MCS2	2~10	16.0 ± 2.0
	MCS3,MCS4,MCS5,MCS6,MCS7	2~10	15.0 ± 2.0
	MCS8	2~10	14.0 ± 2.0
IEEE 802.11ac(VHT40) equivalent	All MCS index	3	9.0 ± 2.0
		9	8.0 ± 2.0
		4~8	14.0 ± 2.0

Mode	MCS index	Channel	RU	MAXIMUM TUNE UP TOLERANCE [dBm]
IEEE 802.11ax(HE20)	All MCS index	1	All tone	8.0 ± 2.0
	MCS0,MCS1,MCS2	2~10	All tone	16.0 ± 2.0
	MCS3,MCS4,MCS5,MCS6,MCS7	2~10	All tone	15.0 ± 2.0
	MCS8,MCS9	2~10	All tone	14.0 ± 2.0
	MCS10,MCS11	2~10	All tone	13.0 ± 2.0
		11	All tone	10.0 ± 2.0
IEEE 802.11ax(HE40)	All MCS index	3	484 tone (Full tone)	9.0 ± 2.0
			26 tone	8.0 ± 2.0
			52 tone	8.0 ± 2.0
			106tone	8.0 ± 2.0
			242 tone	9.0 ± 2.0
	MCS0,MCS1,MCS2,MCS3,MCS4, MCS5,MCS6,MCS7,MCS8,MCS9	4~8	All tone	14.0 ± 2.0
		MCS10,MCS11	4~8	All tone
	All MCS index	9	484 tone (Full tone)	8.0 ± 2.0
			26 tone	8.0 ± 2.0
			52 tone	8.0 ± 2.0
			106 tone	8.0 ± 2.0
242 tone			6.0 ± 2.0	

## 2.4GHz BLUETOOTH

Mode	MAXIMUM TUNE UP TOLERANCE [dBm]
BR	3.0 ± 3.0
EDR	0.0 ± 3.0
LE	3.0 ± 3.0
LE 2Mbps	3.0 ± 3.0

## 5GHz WLAN

Mode	Rate	Band	Channel	MAXIMUM TUNE UP TOLERANCE [dBm]
IEEE 802.11a	All Rate	W52/W53	36~44	8.0 ± 2.0
	All Rate	W52/W53	48	9.0 ± 2.0
	All Rate	W52/W53	52,56	16.0 ± 2.0
	6Mbps,9Mbps,12Mbps,18Mbps,24Mbps,36Mbps	W52/W53	60	17.0 ± 2.0
	48Mbps,54Mbps	W52/W53	60	13.0 ± 2.0
	All Rate	W52/W53	64	16.0 ± 2.0
	All Rate	W56	100~116,132~136	14.0 ± 2.0
	All Rate	W56	140	13.0 ± 2.0
	All Rate	W56	144	16.0 ± 2.0
	6Mbps,9Mbps,12Mbps,18Mbps,24Mbps,36Mbps	W58	149~161	17.0 ± 2.0
	48Mbps,54Mbps	W58	149~161	16.0 ± 2.0
	All Rate	W58	165	12.0 ± 2.0

Mode	MCS index	Band	Channel	MAXIMUM TUNE UP TOLERANCE [dBm]
IEEE 802.11n (HT20)	All MCS index	W52/W53	36~44	8.0 ± 2.0
	All MCS index	W52/W53	48	9.0 ± 2.0
	All MCS index	W52/W53	52~60	16.0 ± 2.0
	All MCS index	W56	100~116,132~136	14.0 ± 2.0
	All MCS index	W56	140	12.0 ± 2.0
	All MCS index	W58	149~161	16.0 ± 2.0
	All MCS index	W58	165	12.0 ± 2.0

Mode	MCS index	Band	Channel	MAXIMUM TUNE UP TOLERANCE [dBm]
IEEE 802.11n (HT40)	All MCS index	W52/W53	38~46	10.0 ± 2.0
	All MCS index	W52/W53	54	14.0 ± 2.0
	All MCS index	W52/W53	62	11.0 ± 2.0
	All MCS index	W56	102	12.0 ± 2.0
	All MCS index	W56	110	13.0 ± 2.0
	All MCS index	W56	134	14.0 ± 2.0
	All MCS index	W56	142	16.0 ± 2.0
	All MCS index	W58	151	16.0 ± 2.0
	All MCS index	W58	159	12.0 ± 2.0

Mode	MCS index	Band	Channel	MAXIMUM TUNE UP TOLERANCE [dBm]
IEEE 802.11ac (VHT20)	All MCS index	W52/W53	36~44	8.0 ± 2.0
	All MCS index	W52/W53	48	9.0 ± 2.0
	MCS0,MCS1,MCS2,MCS3, MCS4,MCS5,MCS6,MCS7	W52/W53	52~60	16.0 ± 2.0
	MCS8	W52/W53	52~60	15.0 ± 2.0
	All MCS index	W52/W53	64	13.0 ± 2.0
	All MCS index	W56	100~116,132~136	14.0 ± 2.0
	All MCS index	W56	140	12.0 ± 2.0
	MCS0,MCS1,MCS2,MCS3, MCS4,MCS5,MCS6,MCS7	W56	144	16.0 ± 2.0
	MCS8	W56	144	15.0 ± 2.0
	MCS0,MCS1,MCS2,MCS3, MCS4,MCS5,MCS6,MCS7	W58	149~161	16.0 ± 2.0
	MCS8	W58	149~161	15.0 ± 2.0
	All MCS index	W58	165	12.0 ± 2.0

Mode	MCS index	Band	Channel	MAXIMUM TUNE UP TOLERANCE [dBm]
IEEE 802 11ac (VHT40)	All MCS index	W52/W53	38~46	10.0 ± 2.0
	All MCS index	W52/W53	54	14.0 ± 2.0
	All MCS index	W52/W53	62	11.0 ± 2.0
	All MCS index	W56	102	12.0 ± 2.0
	All MCS index	W56	110	13.0 ± 2.0
	All MCS index	W56	134	14.0 ± 2.0
	MCS0,MCS1,MCS2,MCS3, MCS4,MCS5,MCS6,MCS7	W56	142	16.0 ± 2.0
	MCS8,MCS9	W56	142	15.0 ± 2.0
	MCS0,MCS1,MCS2,MCS3, MCS4,MCS5,MCS6,MCS7	W58	151	16.0 ± 2.0
	MCS8,MCS9	W58	151	15.0 ± 2.0
	All MCS index	W58	159	12.0 ± 2.0

Mode	MCS index	Band	Channel	MAXIMUM TUNE UP TOLERANCE [dBm]
IEEE 802 11ac (VHT80)	All MCS index	W52/W53	42,58	9.0 ± 2.0
	All MCS index	W56	106	9.0 ± 2.0
	MCS0,MCS1,MCS2,MCS3, MCS4,MCS5,MCS6,MCS7	W56	138	15.0 ± 2.0
	MCS8,MCS9	W56	138	14.0 ± 2.0
	MCS0,MCS1,MCS2,MCS3, MCS4,MCS5,MCS6,MCS7	W58	155	15.0 ± 2.0
	MCS8,MCS9	W58	155	14.0 ± 2.0

Mode	MCS index	Band	Channel	RU	MAXIMUM TUNE UP TOLERANCE [dBm]
IEEE 802.11ax (HE20)	All MCS index	W52/W53	36~44	242 tone (Full tone)	8.0 ± 2.0
				26 tone	2.0 ± 2.0
				52 tone	3.0 ± 2.0
				106 tone	7.0 ± 2.0
	All MCS index	W52/W53	48	242 tone (Full tone)	9.0 ± 2.0
				26 tone	2.0 ± 2.0
				52 tone	3.0 ± 2.0
				106 tone	7.0 ± 2.0
	MCS0,MCS1,MCS2,MCS3, MCS4,MCS5,MCS6,MCS7	W52/W53	52~60	242 tone (Full tone)	16.0 ± 2.0
				26 tone	9.0 ± 2.0
				52 tone	10.0 ± 2.0
				106 tone	13.0 ± 2.0
	MCS8,MCS9	W52/W53	52~60	242 tone (Full tone)	15.0 ± 2.0
				26 tone	9.0 ± 2.0
				52 tone	10.0 ± 2.0
				106 tone	13.0 ± 2.0
	MCS10,MCS11	W52/W53	52~60	242 tone (Full tone)	14.0 ± 2.0
				26 tone	9.0 ± 2.0
				52 tone	10.0 ± 2.0
				106 tone	13.0 ± 2.0
All MCS index	W52/W53	64	242 tone (Full tone)	13.0 ± 2.0	
			26 tone	8.0 ± 2.0	
			52 tone	10.0 ± 2.0	
			106 tone	13.0 ± 2.0	

Mode	MCS index	Band	Channel	RU	MAXIMUM TUNE UP TOLERANCE [dBm]
IEEE 802.11ax (HE20)	All MCS index	W56	100~116, 132~136	242 tone (Full tone)	14.0 ± 2.0
				26 tone	8.0 ± 2.0
				52 tone	11.0 ± 2.0
				106 tone	12.0 ± 2.0
	All MCS index	W56	140	242 tone (Full tone)	12.0 ± 2.0
				26 tone	5.0 ± 2.0
				52 tone	9.0 ± 2.0
				106 tone	10.0 ± 2.0
	MCS0,MCS1,MCS2,MCS3, MCS4,MCS5,MCS6,MCS7	W56	144	242 tone (Full tone)	16.0 ± 2.0
				26 tone	8.0 ± 2.0
				52 tone	11.0 ± 2.0
				106 tone	12.0 ± 2.0
	MCS8,MCS9	W56	144	242 tone (Full tone)	15.0 ± 2.0
				26 tone	8.0 ± 2.0
				52 tone	11.0 ± 2.0
				106 tone	12.0 ± 2.0
	MCS10,MCS11	W56	144	242 tone (Full tone)	14.0 ± 2.0
				26 tone	8.0 ± 2.0
				52 tone	11.0 ± 2.0
				106 tone	12.0 ± 2.0
MCS0,MCS1,MCS2,MCS3, MCS4,MCS5,MCS6,MCS7	W58	149~161	All tone	16.0 ± 2.0	
MCS8,MCS9	W58	149~161	All tone	15.0 ± 2.0	
MCS10,MCS11	W58	149~161	All tone	14.0 ± 2.0	
All MCS index	W58	165	All tone	12.0 ± 2.0	

Mode	MCS index	Band	Channel	RU	MAXIMUM TUNE UP TOLERANCE [dBm]
IEEE 802.11ax (HE40)	All MCS index	W52/W53	38,46	484 tone (Full tone)	10.0 ± 2.0
				26 tone	2.0 ± 2.0
				52 tone	3.0 ± 2.0
				106 tone	7.0 ± 2.0
				242 tone	9.0 ± 2.0
	All MCS index	W52/W53	54	484 tone (Full tone)	14.0 ± 2.0
				26 tone	9.0 ± 2.0
				52 tone	10.0 ± 2.0
				106 tone	13.0 ± 2.0
				242 tone	14.0 ± 2.0
	All MCS index	W52/W53	62	484 tone (Full tone)	11.0 ± 2.0
				26 tone	8.0 ± 2.0
				52 tone	10.0 ± 2.0
				106 tone	11.0 ± 2.0
				242 tone	10.0 ± 2.0
	All MCS index	W56	102	484 tone (Full tone)	12.0 ± 2.0
				26 tone	8.0 ± 2.0
				52 tone	11.0 ± 2.0
				106 tone	12.0 ± 2.0
				242 tone	6.0 ± 2.0
	All MCS index	W56	110	484 tone (Full tone)	13.0 ± 2.0
				26 tone	8.0 ± 2.0
				52 tone	11.0 ± 2.0
				106 tone	12.0 ± 2.0
242 tone				13.0 ± 2.0	
All MCS index	W56	134	484 tone (Full tone)	14.0 ± 2.0	
			26 tone	8.0 ± 2.0	
			52 tone	11.0 ± 2.0	
			106 tone	12.0 ± 2.0	
			242 tone	9.0 ± 2.0	

Mode	MCS index	Band	Channel	RU	MAXIMUM TUNE UP TOLERANCE [dBm]
IEEE 802 11ax (HE40)	MCS0,MCS1,MCS2, MCS3,MCS4,MCS5, MCS6,MCS7	W56	142	484 tone (Full tone)	16.0 ± 2.0
				26 tone	8.0 ± 2.0
				52 tone	11.0 ± 2.0
				106 tone	12.0 ± 2.0
				242 tone	14.0 ± 2.0
	MCS8,MCS9	W56	142	484 tone (Full tone)	15.0 ± 2.0
				26 tone	8.0 ± 2.0
				52 tone	11.0 ± 2.0
				106 tone	12.0 ± 2.0
				242 tone	14.0 ± 2.0
	MCS10,MCS11	W56	142	484 tone (Full tone)	14.0 ± 2.0
				26 tone	8.0 ± 2.0
				52 tone	11.0 ± 2.0
				106 tone	12.0 ± 2.0
				242 tone	14.0 ± 2.0
	MCS0,MCS1,MCS2, MCS3,MCS4,MCS5, MCS6,MCS7	W58	151	All tone	16.0 ± 2.0
				MCS8,MCS9	15.0 ± 2.0
				MCS10,MCS11	14.0 ± 2.0
				All MCS index	12.0 ± 2.0



Mode	MCS index	Band	Channel	RU	MAXIMUM TUNE UP TOLERANCE [dBm]
IEEE 802 11ax (HE80)	All MCS index	W52/W53	42	996 tone (Full tone)	9.0 ± 2.0
				26 tone	2.0 ± 2.0
				52 tone	3.0 ± 2.0
				106 tone	7.0 ± 2.0
				242 tone	9.0 ± 2.0
				484 tone	8.0 ± 2.0
	All MCS index	W52/W53	58	996 tone (Full tone)	9.0 ± 2.0
				26 tone	8.0 ± 2.0
				52 tone	9.0 ± 2.0
				106 tone	9.0 ± 2.0
				242 tone	9.0 ± 2.0
				484 tone	8.0 ± 2.0
	All MCS index	W56	106	996 tone (Full tone)	9.0 ± 2.0
				26 tone	8.0 ± 2.0
				52 tone	9.0 ± 2.0
				106 tone	9.0 ± 2.0
				242 tone	6.0 ± 2.0
				484 tone	9.0 ± 2.0
	MCS0,MCS1,MCS2, MCS3,MCS4,MCS5, MCS6,MCS7	W56	138	996 tone (Full tone)	15.0 ± 2.0
				26 tone	8.0 ± 2.0
				52 tone	11.0 ± 2.0
				106 tone	12.0 ± 2.0
				242 tone	14.0 ± 2.0
				484 tone	15.0 ± 2.0
MCS8,MCS9, MCS10,MCS11	W56	138	996 tone (Full tone)	14.0 ± 2.0	
			26 tone	8.0 ± 2.0	
			52 tone	11.0 ± 2.0	
			106 tone	12.0 ± 2.0	
			242 tone	14.0 ± 2.0	
			484 tone	14.0 ± 2.0	

Mode	MCS index	Band	Channel	RU	MAXIMUM TUNE UP TOLERANCE [dBm]
IEEE 802.11ax (HE80)	MCS0, MCS1, MCS2, MCS3, MCS4, MCS5, MCS6, MCS7	W58	155	996 tone (Full tone)	15.0 ± 2.0
				26 tone	15.0 ± 2.0
				52 tone	15.0 ± 2.0
				106 tone	15.0 ± 2.0
				242 tone	12.0 ± 2.0
				484 tone	14.0 ± 2.0
	MCS8, MCS9, MCS10, MCS11	W58	155	996 tone (Full tone)	14.0 ± 2.0
				26 tone	14.0 ± 2.0
				52 tone	14.0 ± 2.0
				106 tone	14.0 ± 2.0
				242 tone	12.0 ± 2.0
				484 tone	14.0 ± 2.0

## Theory of Operation

Frequency of operation			Scan	Ad-hoc mode
2.4GHz	11b/g/n/ac/ax(BW20)	2412-2462MHz	Active	Yes
	11n/ac/ax(BW40)	2422-2452MHz	Active	Yes
	BT	2402-2480MHz	N/A	N/A
	BLE	2402-2480MHz	N/A	N/A
W52	11a/n/ac/ax(BW20)	5180-5240MHz	Active	Yes
	11n/ac/ax(BW40)	5190-5230MHz	Active	Yes
	11ac/ax(BW80)	5210MHz	Active	Yes
W53	11a/n/ac/ax(BW20)	5260-5320MHz	Passive	No
	11n/ac/ax(BW40)	5270-5310MHz	Passive	No
	11ac/ax(BW80)	5290MHz	Passive	No
W56	11a/n/ac/ax(BW20)	5500-5720MHz*	Passive	No
	11n/ac/ax(BW40)	5510-5710MHz*	Passive	No
	11ac/ax(BW80)	5530-5690MHz*	Passive	No
W58	11a/n/ac/ax(BW20)	5745-5825MHz	Active	Yes
	11n/ac/ax(BW40)	5755-5795MHz	Active	Yes
	11ac/ax(BW80)	5775MHz	Active	Yes

\* The frequency band 5600MHz-5640MHz (11a/n 20M band), 5590MHz-5630MHz (11n/ac/ax 40M band) and 5610MHz(11ac/ax 80M band) is restricted in ISED.

\*DFS MASTER function not available.

\*DFS client function available.

\*There is a TPC function.

### About Power supply(Limited condition)

This Module(LBEE5ZZ1XL and LBEE5ZZ2XS) have been approved as Limited Modular Approval. These modules do not have a voltage stabilizing circuit in the power path to the internal RF circuitry. Therefore, the Limited Condition must provide a stable power supply for the supply voltage to the module.

Please supply a stable power supply so that the voltage shown in the table below is applied.

Parameter		Min.	Typ.	Max.	unit
Supply Voltage	VDD33	3.14	3.3	3.46	V
	VDD18	1.71	1.8	1.89	V
	VIO	1.71 3.14	1.8 3.3	1.89 3.46	V
	VIO_SD	1.71 3.14	1.8 3.3	1.89 3.46	V

Microstrip trace line on the host PCB to the antenna connectors

#### ■ About the signal line between an antenna and a module

It is a 50-ohm line design.

Fine tuning of return loss etc. can be performed using a matching network.

However, it is required to check "Class1 change" and "Class2 change" which the authorities define then.

The concrete contents of a check as follows.

- 1) Different length and shapes affect radiated emissions, must confirm the same specification is used as the following page 14 and 15.
- 2) The emission level is not getting worse.

The following is the design of the EVB used for the test.

Certification tests are conducted in the following patterns.

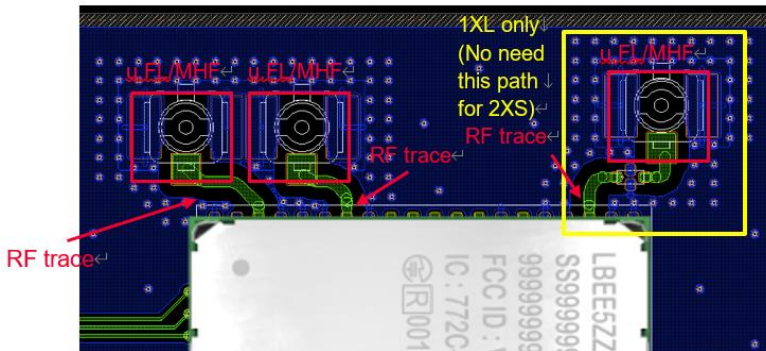

The 50ohm microstrip line needs to be copied when module is installed in the End product.  
Murata provides set makers with Gerber data or something similar.

About the Trace antenna and feed line of the jig where the certification test was conducted

Substrate type name of certification test jig: P2ML9917

feed line width : 0.4mm

Substrate thin :  $0.8 \pm 0.1$  mm

Substrate material: FR -4

Substrate thickness between GND layer and surface layer: 0.408mm

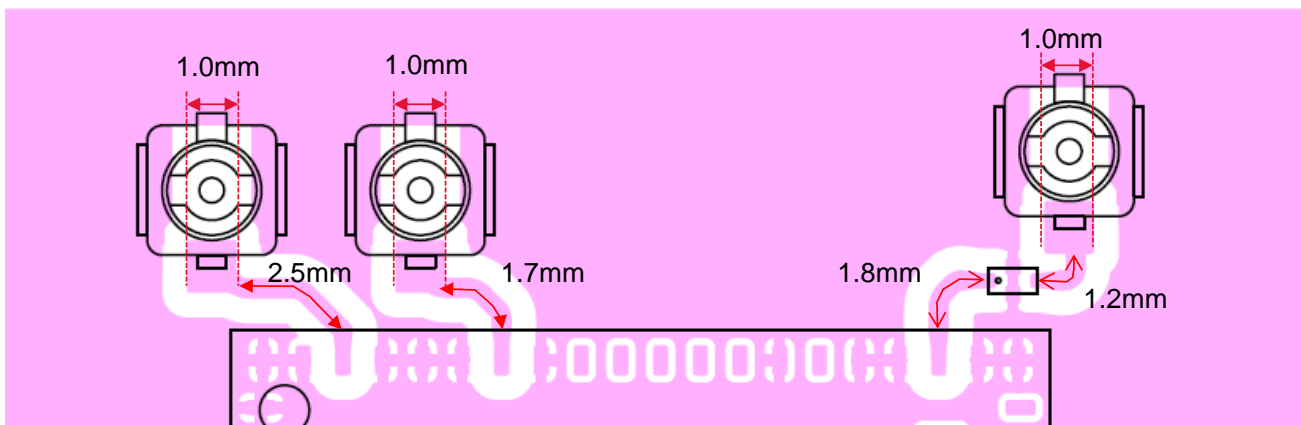

## 14.4 EU

The following report is issued:

Only the Antenna Terminated Conducted test section of each report is available for TCF of the final product.

The radiation characteristic data should be acquired by you in the final product.

Radio Equipment Directive (RED) 2014/53/EU Article 3.2

Conforms to: EN 300 328 v2.2.2:2019

Report No.: E2-2022-10030

Report No.: E2-2022-10031

Report No.: E2-2022-10032

EN 301 893 v2.1.1:2017

Report No.: E2-2022-10033

Report No.: E2-2022-10034

EN 300 440 v2.1.1:2017

Report No.: E2-2022-10035

Radio Equipment Directive (RED) 2014/53/EU Article 3.1a

Conforms to : EN 62311:2020

Report No.: ES-2022-10003

Product name: Communication Module

Model: LBEE5ZZ1XL, LBEE5ZZ2XS2EL

Manufacture: Murata manufacturing Co., Ltd.

When shipping final products with this module to Europe, make a self-declaration that the product complies with European regulations and apply the CE mark.

## Setting RF Power for Europe at 25 deg.C

## 2.4GHz WLAN

Mode	Rate / MCS index	Channel	MAXIMUM TUNE UP TOLERANCE [dBm]
IEEE 802.11b	All Rate	1~13	11.0 ± 2.0
IEEE 802.11g	All Rate	1~13	11.0 ± 2.0
IEEE 802.11n(HT20)	All MCS index	1~13	11.0 ± 2.0
IEEE 802.11n(HT40)	All MCS index	3~11	11.0 ± 2.0

Mode	Rate / MCS index	Channel	SU	MAXIMUM TUNE UP TOLERANCE [dBm]	RU	MAXIMUM TUNE UP TOLERANCE [dBm]
IEEE 802.11ax(HE20)	All MCS index	1~13	SU	11.0 ± 2.0	-	-
			-	-	242 tone (Full tone)	11.0 ± 2.0
			-	-	26 tone	6.0 ± 2.0
			-	-	52 tone	8.0 ± 2.0
			-	-	106 tone	11.0 ± 2.0
IEEE 802.11ax(HE40)	All MCS index	3~11	SU	11.0 ± 2.0	-	-
			-	-	484 tone (Full tone)	11.0 ± 2.0
			-	-	26 tone	6.0 ± 2.0
			-	-	52 tone	8.0 ± 2.0
			-	-	106 tone	11.0 ± 2.0
-	-	242 tone	11.0 ± 2.0			

## BT(BR/EDR)/BLE/IEEE802.15.4

Mode	Channel	MAXIMUM TUNE UP TOLERANCE [dBm]
BR	NA	3.0 ± 3.0
EDR	NA	0.0 ± 3.0
LE	NA	3.0 ± 3.0
LE 2Mbps	NA	3.0 ± 3.0

5GHz(W52/W53/W56) WLAN

Mode	Rate / MCS index	Channel	MAXIMUM TUNE UP TOLERANCE [dBm]
IEEE 802.11a	All Rate	36~140	13.0 ± 2.0
IEEE 802.11n(HT20)	All MCS index	36~140	13.0 ± 2.0
IEEE 802.11n(HT40)	All MCS index	38~134	13.0 ± 2.0
IEEE 802.11ac(VHT20)	All MCS index	36~140	13.0 ± 2.0
IEEE 802.11ac(VHT40)	All MCS index	38~134	13.0 ± 2.0
IEEE 802.11ac(VHT80)	All MCS index	42~122	13.0 ± 2.0

Mode	Rate / MCS index	Channel	SU	MAXIMUM TUNE UP TOLERANCE [dBm]	RU	MAXIMUM TUNE UP TOLERANCE [dBm]
IEEE 802.11ax(HE20)	All MCS index	36~140	SU	13.0 ± 2.0	-	-
			-	-	242 tone (Full tone)	13.0 ± 2.0
			-	-	26 tone	6.0 ± 2.0
			-	-	52 tone	8.0 ± 2.0
			-	-	106 tone	11.0 ± 2.0
IEEE 802.11ax(HE40)	All MCS index	38~134	SU	13.0 ± 2.0	-	-
			-	-	484 tone (Full tone)	13.0 ± 2.0
			-	-	26 tone	6.0 ± 2.0
			-	-	52 tone	8.0 ± 2.0
			-	-	106 tone	11.0 ± 2.0
IEEE 802.11ax(HE80)	All MCS index	42~122	SU	14.0 ± 2.0	-	-
			-	-	996 tone (Full tone)	14.0 ± 2.0
			-	-	26 tone	7.0 ± 2.0
			-	-	52 tone	9.0 ± 2.0
			-	-	106 tone	12.0 ± 2.0
			-	-	242 tone	14.0 ± 2.0
-	-	484 tone	14.0 ± 2.0			



## 5GHz(W58) WLAN

Mode	Rate / MCS index	Channel	MAXIMUM TUNE UP TOLERANCE [dBm]
IEEE 802.11a	All Rate	149~169	4.0 ± 2.0
IEEE 802.11n(HT20)	All MCS index	149~169	4.0 ± 2.0
IEEE 802.11n(HT40)	All MCS index	149~169	4.0 ± 2.0
IEEE 802.11ac(VHT20)	All MCS index	149~169	4.0 ± 2.0
IEEE 802.11ac(VHT40)	All MCS index	151~167	4.0 ± 2.0
IEEE 802.11ac(VHT80)	All MCS index	155	4.0 ± 2.0

Mode	Rate / MCS index	Channel	SU	MAXIMUM TUNE UP TOLERANCE [dBm]	RU	MAXIMUM TUNE UP TOLERANCE [dBm]
IEEE 802.11ax(HE20)	All MCS index	149~169	SU	4.0 ± 2.0	-	-
			-	-	242 tone (Full tone)	4.0 ± 2.0
			-	-	26 tone	4.0 ± 2.0
			-	-	52 tone	4.0 ± 2.0
			-	-	106 tone	4.0 ± 2.0
IEEE 802.11ax(HE40)	All MCS index	151~159	SU	4.0 ± 2.0	-	-
			-	-	484 tone (Full tone)	4.0 ± 2.0
			-	-	26 tone	4.0 ± 2.0
			-	-	52 tone	4.0 ± 2.0
			-	-	106 tone	4.0 ± 2.0
IEEE 802.11ax(HE80)	All MCS index	155	SU	4.0 ± 2.0	-	-
			-	-	996 tone (Full tone)	4.0 ± 2.0
			-	-	26 tone	4.0 ± 2.0
			-	-	52 tone	4.0 ± 2.0
			-	-	106 tone	4.0 ± 2.0
-	-	242 tone	4.0 ± 2.0			
-	-	484 tone	4.0 ± 2.0			

## Theory of Operation

	Frequency of operation	Scan	Ad-hoc mode	
2.4GHz	11b/g/n/ac/ax(BW20)	2412-2472MHz	Active	Yes
	11n/ac/ax(BW40)	2422-2462MHz	Active	Yes
	BT	2402-2480MHz	N/A	N/A
	BLE	2402-2480MHz	N/A	N/A
W52	11a/n/ac/ax(BW20)	5180-5240MHz	Active	Yes
	11n/ac/ax(BW40)	5190-5230MHz	Active	Yes
	11ac/ax(BW80)	5210MHz	Active	Yes
W53 *	11a/n/ac/ax(BW20)	5260-5320MHz	Passive	No
	11n/ac/ax(BW40)	5270-5310MHz	Passive	No
	11ac/ax(BW80)	5290MHz	Passive	No
W56 *	11a/n/ac/ax(BW20)	5500-5700MHz	Passive	No
	11n/ac/ax(BW40)	5510-5670MHz	Passive	No
	11ac/ax(BW80)	5530-5610MHz	Passive	No
W58	11a/n/ac/ax(BW20)	5745-5845MHz	Active	Yes
	11n/ac/ax(BW40)	5755-5835MHz	Active	Yes
	11ac/ax(BW80)	5775MHz	Active	Yes

\*DFS MASTER function not available.

\*DFS client function available.

\*There is a TPC function.

## 15 Tape and Reel Packing

This section contains the following topics:

- Dimensions of Tape (Plastic tape)
- Dimensions of Reel
- Taping Diagrams
- Leader and tail tape
- Packaging

### 15.1 Dimensions of Tape (Plastic Tape)

Figure 17 is a graphical representation of the tape dimension (plastic tape)<sup>7</sup>.

Figure 17: Dimensions of Tape (Plastic Tape)

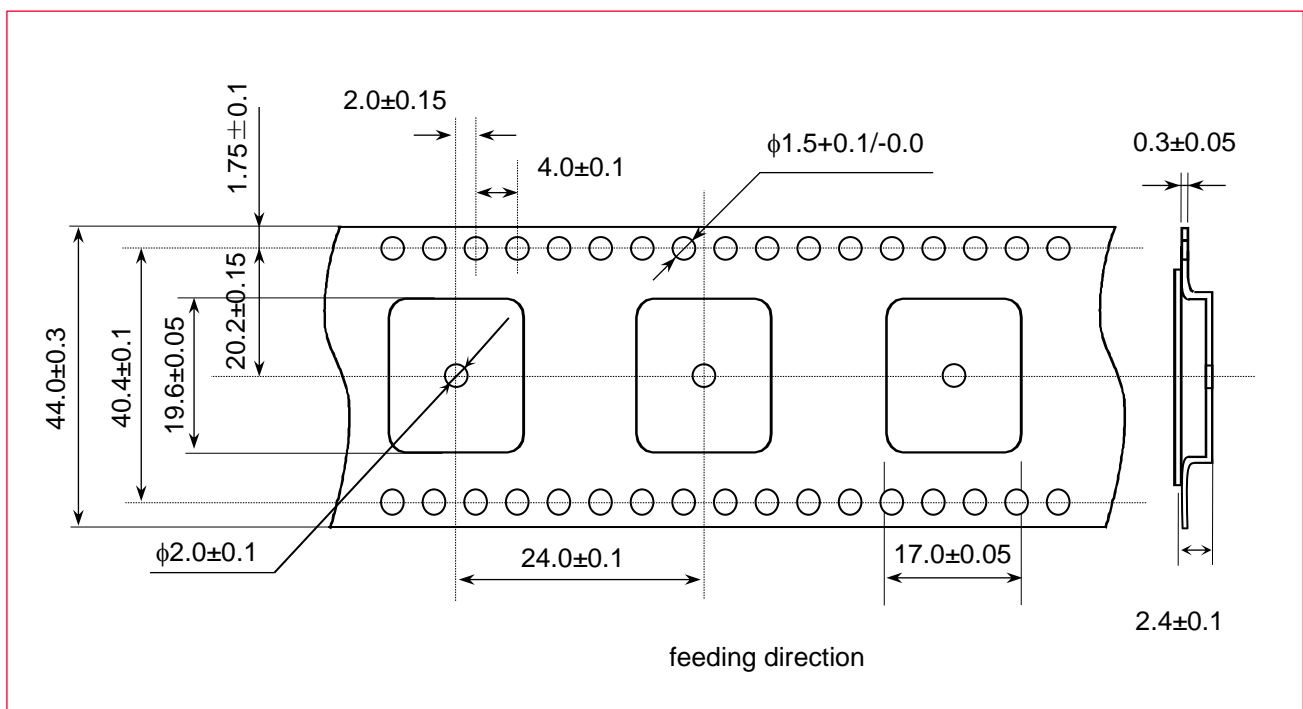

<sup>7</sup> Cumulative tolerance of maximum 40 +/- 0.15 mm for every 10 pitches.

## 15.2 Dimensions of Reel

Figure 18 shows the reel dimensions.

Figure 18: Dimensions of Reel (Unit: mm)

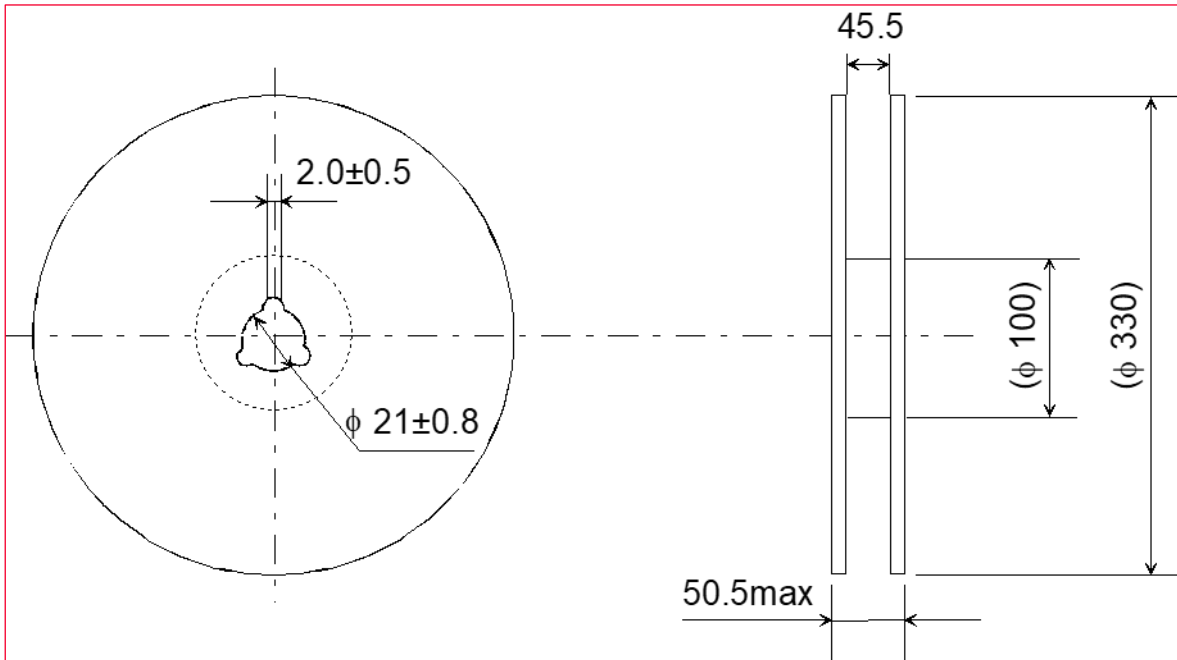

## 15.3 Taping Diagrams

Figure 19 shows the taping diagrams.

Figure 19: Taping Diagrams

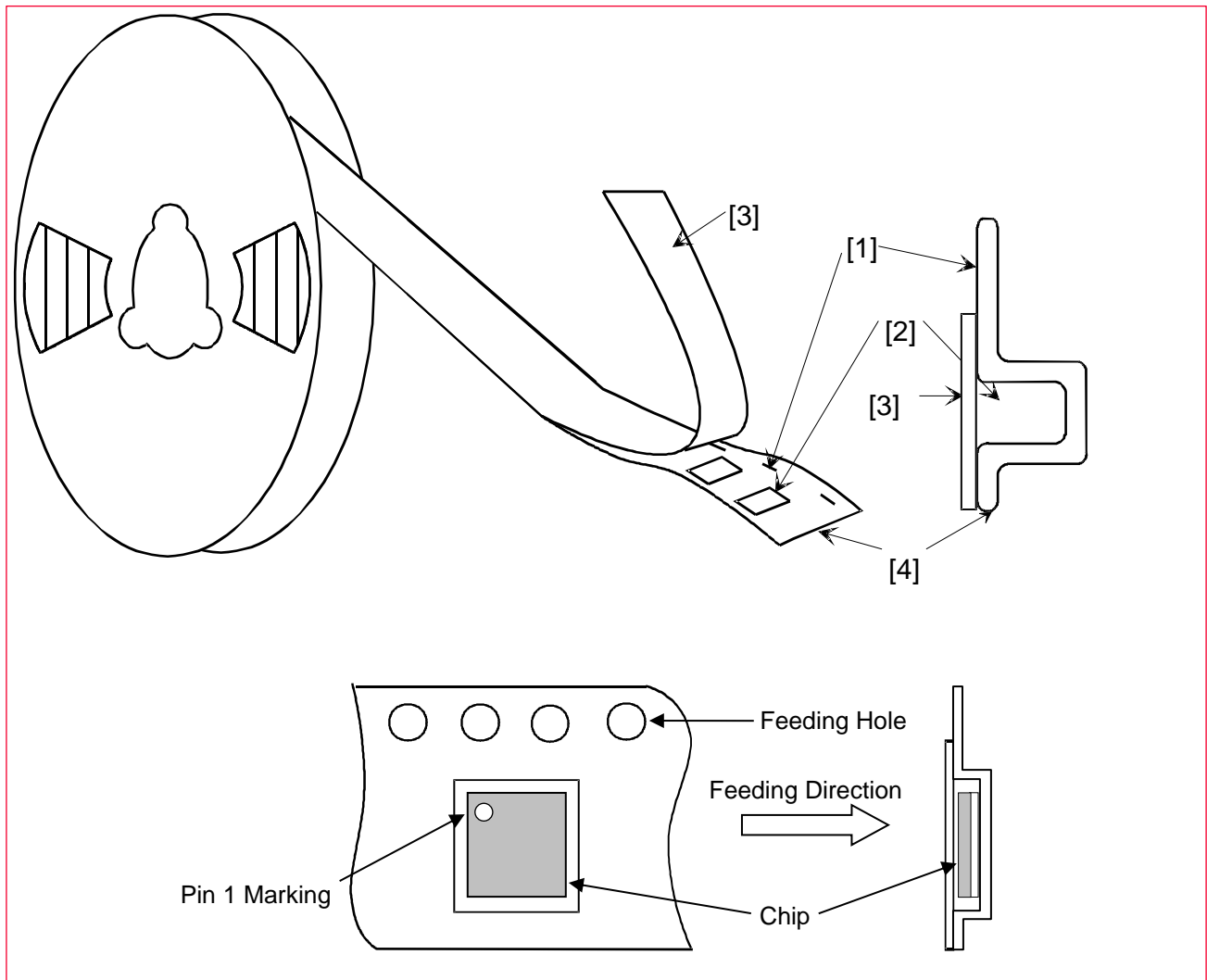

Table 66: Taping Specifications

Mark	Description
1	Feeding Hole. As specified in <a href="#">Dimensions of Tape (Plastic Tape)</a> ☐.
2	Hole for chip. As specified in <a href="#">Dimensions of Tape (Plastic Tape)</a> ☐.
3	Cover tape. 62 μm in thickness.
4	Base tape. As specified in <a href="#">Dimensions of Tape (Plastic Tape)</a> ☐.

## 15.4 Leader and Tail Tape

The leader and tail tape are shown in **Figure 20**.

**Figure 20: Leader and Tail Tape**

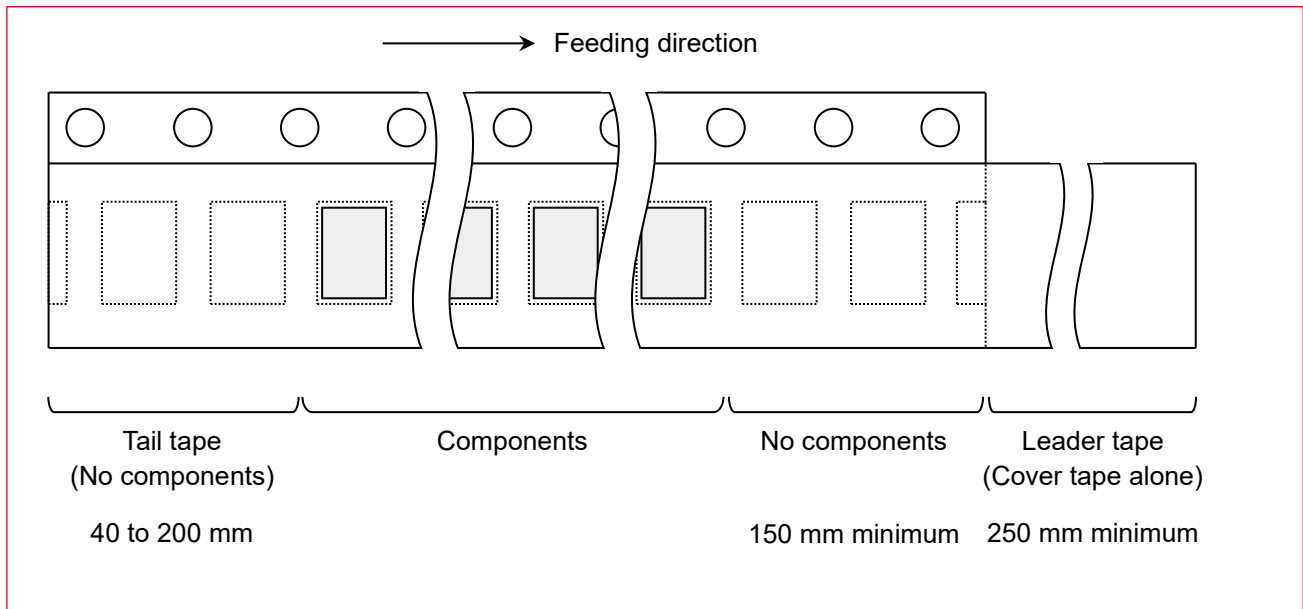

- The tape for chips is wound clockwise, the feeding holes to the right side as the tape is pulled toward the user.
- The cover tape and base tape are not adhered at no components area for 250 mm minimum.
- Tear off strength against pulling of cover tape: 5 N minimum.
- Packaging unit: 500 pcs./ reel
- Material
  - Base tape: Plastic
  - Reel: Plastic
  - Cover tape, cavity tape and reel are made the anti-static processing.
- Peeling off force: 1.1 N maximum. in the direction of peeling as shown in **Figure 21**.

**Figure 21: Peeling Force**

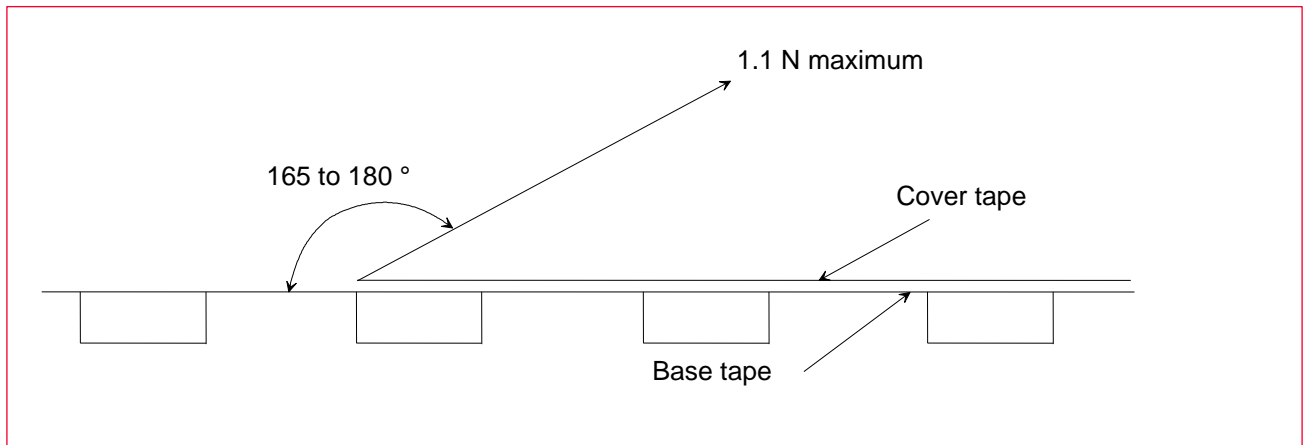

## 15.5 Packaging (Humidity Proof Packing)

The packaging is shown in **Figure 22**.

**Figure 22: Humidity Proof Packing**

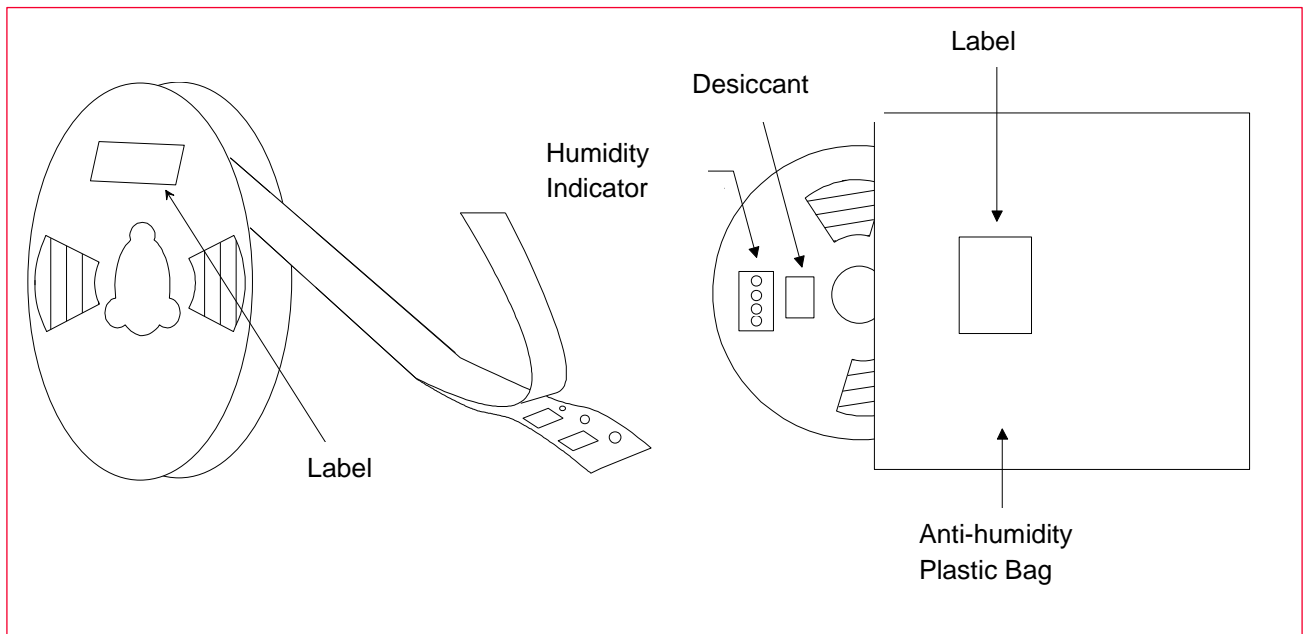

Tape and reel must be sealed with the anti-humidity plastic bag. The bag contains the desiccant and the humidity indicator.

## 16 Notice

### 16.1 Storage Conditions

- Please use this product within 6 months after receipt.
- The product shall *be* stored without opening the packing under the ambient temperature from 5 to 35 °C and humidity from 20 ~ 70 %RH.



Packing materials, in particular, may be deformed at the temperature over 40 °C

- The solderability of the product left idle for more than 6 months after receipt needs to be confirmed before it is used.
- The product shall be stored in noncorrosive gas (Cl<sub>2</sub>, NH<sub>3</sub>, SO<sub>2</sub>, NO<sub>x</sub>, etc.).
- Any excess mechanical shock including, but not limited to, sticking the packing materials by sharp object, and dropping the product, shall not be applied as that will damage the packing materials.
- This product is applicable to MSL3 (Based on IPC/JEDEC J-STD-020)
  - After the packing is opened, the product shall be stored at <30 °C / <60 %RH and the product shall be used within 168 hours after opening.
  - When the color of the indicator in the packing changed, the product shall be baked before soldering.
- Baking condition: 125 +5/-0 °C, 24 hours, 1 time
- The products shall be baked on the heat-resistant tray because the material (Base Tape, Reel Tape and Cover Tape) is not heat-resistant.

### 16.2 Handling Conditions

Be careful while handling or transporting products because excessive stress or mechanical shock may break the products.

Handle with care if you suspect that products may have cracks or damages on their terminals. If there is any such damage, the characteristics of products may change. *Do not touch* products with bare hands as that may cause poor solderability and destroy solderability by static electrical charge.

### 16.3 Standard PCB Design (Land Pattern and Dimensions)

All the ground terminals should be connected to the ground patterns. Furthermore, the ground pattern should be provided between IN and OUT terminals. Please refer to the specifications for the standard land dimensions.

The recommended land pattern and dimensions is as Murata's standard. The characteristics of products may vary depending on the pattern drawing method, grounding method, land dimensions, land forming method of the NC terminals and the PCB material and thickness. Therefore, be sure to verify the characteristics in the actual set.

When using non-standard lands, contact Murata beforehand.

## 16.4 Notice for Chip Placer

When placing products on the PCB, products may be stressed and broken by uneven forces from a worn-out chucking locating claw or a suction nozzle. To prevent products from damages, be sure to follow the specifications for the maintenance of the chip placer being used. For the positioning of products on the PCB, be aware that mechanical chucking may damage products.

## 16.5 Soldering Conditions

Soldering must be carried out by the above-mentioned conditions to prevent products damage. Set up the highest temperature of reflow within 260 °C. Contact Murata before use concerning other soldering conditions.

The recommended conditions of soldering are as in **Figure 23**.

**Figure 23: Reflow Soldering Standard Conditions (Example)**

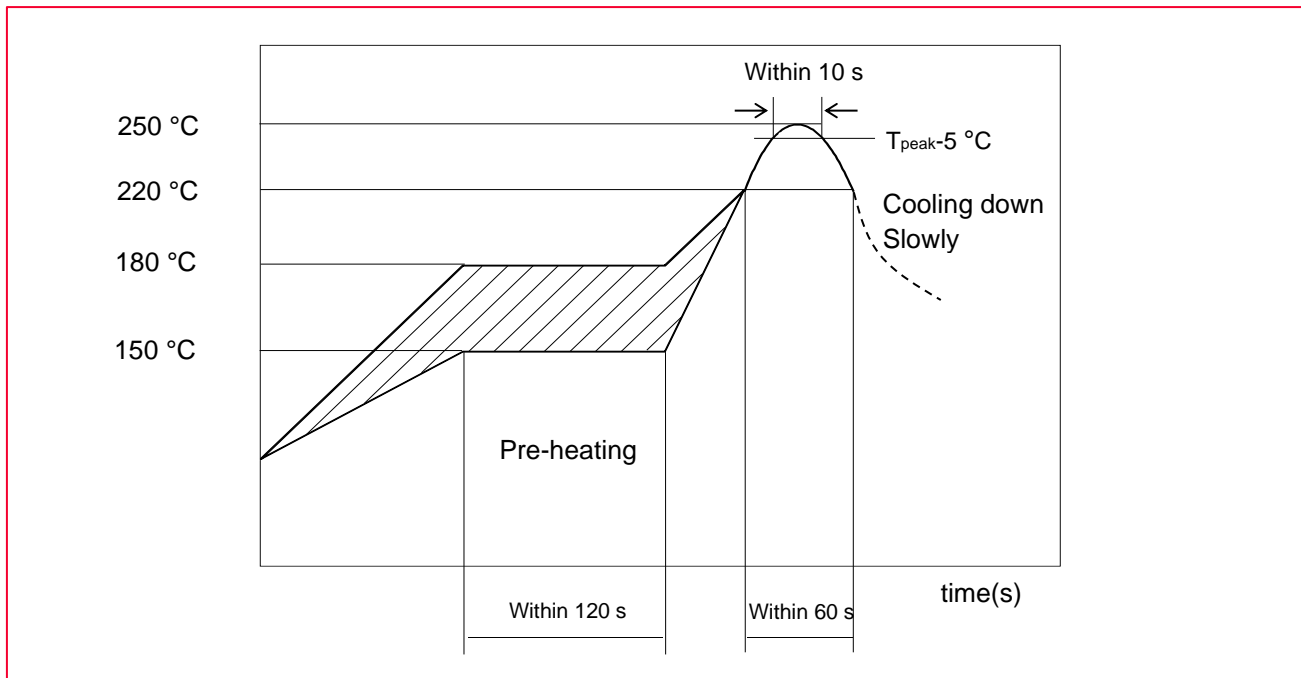

Please use the reflow within 2 times.

Use rosin type flux or weakly active flux with a chlorine content of 0.2 wt. % or less.

## 16.6 Cleaning

Since this product is moisture sensitive, cleaning is not recommended. If any cleaning process is done the customer is responsible for any issues or failures caused by the cleaning process.

## 16.7 Operational Environment Conditions

Murata products are designed to work for electronic products under normal environmental conditions (ambient temperature, humidity, and pressure). Therefore, there is no problem in using the products under the above-mentioned conditions. However, using the products under the following circumstances may damage products and cause electricity leakage and abnormal temperature may occur.



- In atmosphere containing corrosive gas (Cl<sub>2</sub>, NH<sub>3</sub>, SO<sub>x</sub>, NO<sub>x</sub> etc.).
- In atmosphere containing combustible and volatile gases.
- Dusty place.
- Direct sunlight place.
- Water splashing place.
- Humid place where water condenses.
- Freezing place.



If there is any chance of using the products under the conditions listed above, consult with Murata before actual use.



Do not apply static electricity or excessive voltage while assembling and measuring, as it might be a cause of degradation or destruction to apply static electricity to products.

## 17 Precondition to Use Our Products



PLEASE READ THIS NOTICE BEFORE USING OUR PRODUCTS.

Please make sure that your product has been evaluated and confirmed from the aspect of the fitness for the specifications of our product when our product is mounted to your product.

All the items and parameters in this product specification/datasheet/catalog have been prescribed on the premise that our product is used for the purpose, under the condition and in the environment specified in this specification. You are requested not to use our product deviating from the condition and the environment specified in this specification.

Please note that the only warranty that we provide regarding the products is its conformance to the specifications provided herein. Accordingly, we shall not be responsible for any defects in products or equipment incorporating such products, which are caused under the conditions other than those specified in this specification.

WE HEREBY DISCLAIM ALL OTHER WARRANTIES REGARDING THE PRODUCTS, EXPRESS OR IMPLIED, INCLUDING WITHOUT LIMITATION ANY WARRANTY OF FITNESS FOR A PARTICULAR PURPOSE, THAT THEY ARE DEFECT-FREE, OR AGAINST INFRINGEMENT OF INTELLECTUAL PROPERTY RIGHTS.

You agree that you will use any and all software or program code (including but not limited to hcd, firmware, nvram, and blob) we may provide or to be embedded into our product ("Software") provided that you use the Software bundled with our product. YOU AGREE THAT THE SOFTWARE SHALL BE PROVIDED TO YOU "AS IS" BASIS, MURATA MAKES NO REPRESENTATIONS OR WARRANTIES THAT THE SOFTWARE IS ERROR-FREE OR WILL OPERATE WITHOUT INTERRUPTION. AND MORE, MURATA MAKES NO REPRESENTATIONS OR WARRANTIES OF ANY KIND WHETHER EXPRESS OR IMPLIED WITH RESPECT TO THE SOFTWARE. MURATA EXPRESSLY DISCLAIM ANY AND ALL WARRANTIES OR CONDITIONS OF MERCHANTABILITY, FITNESS FOR A PARTICULAR PURPOSE NOR THE WARRANTY OF TITLE OR NON-INFRINGEMENT OF INTELLECTUAL PROPERTY RIGHTS.

You shall indemnify and hold harmless us, our affiliates, and our licensor from and against any and all claims, costs, expenses and liabilities (including attorney's fees), which arise in connection with the using the Software.

The product shall not be used in any application listed below which requires especially high reliability for the prevention of such defect as may directly cause damage to the third party's life, body or property. You acknowledge and agree that, if you use our products in such applications, we will not be responsible for any failure to meet such requirements. Furthermore, YOU AGREE TO INDEMNIFY AND DEFEND US AND OUR AFFILIATES AGAINST ALL CLAIMS, DAMAGES, COSTS, AND EXPENSES THAT MAY BE INCURRED, INCLUDING WITHOUT LIMITATION, ATTORNEY FEES AND COSTS, DUE TO THE USE OF OUR PRODUCTS AND THE SOFTWARE IN SUCH APPLICATIONS.

- Aircraft equipment.
- Aerospace equipment.
- Undersea equipment.
- Power plant control equipment.
- Medical equipment.
- Traffic signal equipment.

- Burning / explosion control equipment.
- Disaster prevention / crime prevention equipment.
- Transportation equipment (vehicles, trains, ships, elevator, etc.).
- Application of similar complexity and/ or reliability requirements to the applications listed in the above.
- We expressly prohibit you from analyzing, breaking, reverse-engineering, remodeling altering, and reproducing our product. Our product cannot be used for the product which is prohibited from being manufactured, used, and sold by the regulations and laws in the world.

We do not warrant or represent that any license, either express or implied, is granted under any our patent right, copyright, mask work right, or our other intellectual property right relating to any combination, machine, or process in which our products or services are used. Information provided by us regarding third-party products or services does not constitute a license from us to use such products or services or a warranty or endorsement thereof. Use of such information may require a license from a third party under the patents or other intellectual property of the third party, or a license from us under our patents or other intellectual property.

Please do not use our products, our technical information and other data provided by us for the purpose of developing of mass-destruction weapons and the purpose of military use.

Moreover, you must comply with "foreign exchange and foreign trade law", the "U.S. export administration regulations", etc.

Please note that we may discontinue the manufacture of our products, due to reasons such as end of supply of materials and/or components from our suppliers.

By signing on specification sheet or approval sheet, you acknowledge that you are the legal representative for your company and that you understand and accept the validity of the contents herein. When you are not able to return the signed version of specification sheet or approval sheet within 30 days from receiving date of specification sheet or approval sheet, it shall be deemed to be your consent on the content of specification sheet or approval sheet. Customer acknowledges that engineering samples may deviate from specifications and may contain defects due to their development status. We reject any liability or product warranty for engineering samples. In particular we disclaim liability for damages caused by

- The use of the engineering sample other than for evaluation purposes, particularly the installation or integration in the product to be sold by you,
- Deviation or lapse in function of engineering sample,
- Improper use of engineering samples.
- We disclaim any liability for consequential and incidental damages.

If you can't agree with the above contents, please contact sales.

## Revision History

Revision Code	Date	Changed Item	Comments
	2020.11.20	First Issue	
A	2021.03.15	5. Dimensions, Marking and Terminal Configurations 6.1 Pin Assignments	<ul style="list-style-type: none"> <li>Changed module size and pin function information.</li> </ul>
B	2021.03.29	5. Dimensions, Marking and Terminal Configurations 6.2 Pin Descriptions	<ul style="list-style-type: none"> <li>Changed module height and pin function information.</li> </ul>
C	2021.04.05	5. Dimensions, Marking and Terminal Configurations	<ul style="list-style-type: none"> <li>Corrected e5 value from 1.09 to 1.10 mm.</li> </ul>
D	2021.04.28	5. Dimensions, Marking and Terminal Configurations 12. Reference Circuit	<ul style="list-style-type: none"> <li>Added Marking information.</li> <li>Added reference circuit.</li> </ul>
E	2021.05.05	6.2 Pin Descriptions	<ul style="list-style-type: none"> <li>Corrected pin description</li> </ul>
F	2021.06.14	5. Dimensions, Marking and Terminal Configurations	<ul style="list-style-type: none"> <li>Modified Marking information.</li> </ul>
G	2021.10.18	1. Scope 2. Key Features 3. Part Number 6. Dimensions, Marking and Terminal Configurations 7.1 Pin Assignments 7.2 Pin Descriptions 7.3 Configuration Pins 7.4 Pin State 7.5 SDIO Pin Descriptions 12. Land patterns	<ul style="list-style-type: none"> <li>Updated Bluetooth version</li> <li>Added a new section</li> <li>Added MP part number</li> <li>Updated terminal size and dimensions.</li> <li>Updated a diagram and Pin 235-238</li> <li>Updated Pin 235-238 and Pin 68</li> <li>Added a new section</li> <li>Added a new section</li> <li>Added a new section</li> <li>Added Land pattern figure</li> </ul>
H	2022.02.01	4. Block Diagram 9.1 Operating Conditions 7.4 Pin States 13. Reference Circuit	<ul style="list-style-type: none"> <li>Removed sleep clock input</li> <li>Defined IO Current</li> <li>Added PDn</li> <li>Applied change of Pin 235-238 and Pin 68</li> </ul>
I	2022.04.01	5.1 Radio Certification 5.2 Bluetooth Qualification 6. Dimensions, Marking and Terminal Configurations 9.1 Operating conditions 9.2 Digital I/O Requirements 9.3 Package thermal conditions 11. Host Interface Specification 12.14 DC/RF Characteristics for Bluetooth 12.15 DC/RF Characteristics for Bluetooth	<ul style="list-style-type: none"> <li>Added certification number</li> <li>Added qualification number</li> <li>Added module structure, Defined T1.</li> <li>Added Junction temperature</li> <li>Added this section</li> <li>Added this section</li> <li>Added this section</li> <li>Added test method</li> <li>Added test method</li> </ul>
J	2022.05.09	6. Dimensions, Marking and Terminal Configurations 9.1 Operating conditions 12 DC/RF Characteristics	<ul style="list-style-type: none"> <li>Modified b3 measurement</li> <li>Defined max values of peak current.</li> <li>Defined current consumption and max input level</li> </ul>
K	2022.05.31	7.2 Pin Descriptions 7.4 Pin States 14. Reference circuit	<ul style="list-style-type: none"> <li>Updated supply voltage level of IO pins (Power domain)</li> <li>Updated supply voltage level of IO pins (Power domain)</li> <li>Connect Pin 82 to GND. Added comment on GPIO22/23.</li> </ul>

Revision Code	Date	Changed Item	Comments
L	2022.08.26	7.2 Pin Descriptions 9.1 Operating Condition 9.3 Package Thermal Conditions 14 Reference Circuit	<ul style="list-style-type: none"> <li>Corrected descriptions of Pin 56, Pin 65 and Pin 76</li> <li>Added Notes.</li> <li>Corrected value.</li> <li>Corrected connection of Pin 20 and 21.</li> </ul>
M	2022.10.03	2. Key Features 3. Part Number  6. Dimensions, Marking and Terminal Configurations 7.4 Pin States  14. Reference Circuit	<ul style="list-style-type: none"> <li>Added more information</li> <li>Added Embedded Artists' M.2 module information. Renamed section.</li> <li>Corrected e9 of dimensions</li> <li>Added comments on termination of open pins.</li> <li>Moved section to HW app note.</li> </ul> <p>Updated to new format</p>
N	2023.06.29	2 Key Feature  7.2 Pin Descriptions   7.3 Configuration Pins 7.4 Pin State 7.5 SDIO Pin Descriptions 9.1 Operating conditions 9.3 Package thermal conditions 10.1 Power-On Sequence 10.2 Power-Off Sequence 11.1 SDIO Specifications  14. Radio Regulatory Certification by Country for 1XL/2XS	<ul style="list-style-type: none"> <li>Corrected typo (MCS9 &gt; 11)</li> <li>Added B10 life and Fit</li> <li>Updated CONFIG_HOST[2]</li> <li>Updated GPIO[14]</li> <li>Changed IO Voltage of PCIE_CLKREQn and PCIE_WAKEn</li> <li>Removed DSRn and DRTn</li> <li>Removed SDIO 1-bit mode</li> <li>Added comments</li> <li>Updated GPIO[14] [15] [17]</li> <li>Removed SDIO 1-bit mode</li> <li>Updated Ta and Added Tc</li> <li>Removed</li> <li>Updated sequence</li> <li>Added comment</li> <li>Removed SDIO 1-bit mode</li> <li>Added Radio Regulatory Certification</li> </ul>



Copyright © Murata Manufacturing Co., Ltd. All rights reserved. The information and content in this document are provided “as-is” with no warranties of any kind and are for informational purpose only. Data and information have been carefully checked and are believed to be accurate; however, no liability or responsibility for any errors, omissions, or inaccuracies is assumed.

Wi-Fi® is a registered trademark of Wi-Fi Alliance. The Bluetooth® word mark and logos are registered trademarks owned by Bluetooth SIG, Inc. Other brand and product names are trademarks or registered trademarks of their respective owners.

Specifications are subject to change without notice.

## X-ON Electronics

Largest Supplier of Electrical and Electronic Components

*Click to view similar products for [Multiprotocol Modules](#) category:*

*Click to view products by [Murata](#) manufacturer:*

Other Similar products are found below :

[9260.NGWG.NV 958867](#) [AX210.NGWG.NV](#) [BM833](#) [ESP32-C3-MINI-1U-H4](#) [ESP32-WROOM-32U-16MB](#) [ESP32-WROOM-32UE](#)  
[ESP32-WROOM-32D-H4](#) [ESP32-WROOM-32U-H4](#) [ESP32-PICO-MINI-02U-N8R2](#) [ESP32-C6-WROOM-1-N4](#) [ESP32-C6-WROOM-1U-N4](#)  
[ESP32-C6-WROOM-1-N8](#) [BE200.NGWG.NV](#) [BE200.NGWG](#) [BE202.NGWG.NV](#) [BE200.NGWG.NVX](#) [AX411.NGWG.NV](#) [AX210.D2WG](#)  
[AX210.NGWG.NVX](#) [AX211.NGWG](#) [EC200UEUAA-N05-TA0AA](#) [SC20ELSATEA-8GB-UGAD](#) [SG560DEUPA-U61-TA0AA](#)  
[AX211.NGWG.NV](#) [ISM43340-M4G-L44-10CF-C6.2.1.11](#) [KG100SABMD](#) [BC40P](#) [S007-PIN254](#) [S007-PIN127](#) [ESP32-C3-12F](#)  
[FC41DAHMD](#) [EWM-W179M201E](#) [ESP32-C6-WROOM-1U-N8](#) [ATWILC3000-MR110CA](#) [RS9113-NBZ-D5W](#) [ATWINC3400-](#)  
[MR210UA122](#) [ESP32-WROOM-32](#) [AMPAK AP12356 WIFI/BT KIT](#) [AIW-154BN](#) [AIW-165BN](#) [AIW-166K1](#) [AIW-166K2](#) [AIW-166K3](#)  
[AIW-166K4](#) [AIW-355 DQ-N01](#) [AIW-355 DQ-C01](#) [EWM-W159M201E](#) [EWM-W192K1](#) [EWM-W192K2](#) [W106C](#)