

W-LAN Module Data Sheet

NXP 88W8801 Chipset
for 802.11b/g/n

Design Name: Type2DS
P/N : LBWA0ZZ2DS-SMP-688

Revision History

Revision Code	Date	Description	Comments
-	2020.07.15	First Issue	
A	2020.12.16	7. Module Pin Descriptions 9. Operating Conditions 12. DC / RF Characteristics 14. Reference Circuit 15. Tape and Reel Packing	-Updated -Added Internal 1.8V(AVVD18) -Updated -Added -Added
B	2021.01.14	5. Certification Information 12. DC/RF Characteristics 11.2 USB Specifications	-Added certification information -Updated file name of configuration files -Added information (Section 11.2.1 to 11.2.5)
C	2021.03.15	6. Dimensions, Marking and Terminal Configurations 9. Operating Conditions 10. Power Up Sequence 12. DC/RF Characteristics 12.3.3 High Rate Conditions for IEEE802.11n 14. Reference Circuit Appendix	-Added Marking -Updated Peak current -Updated -Updated DC current -Updated Tx power. -Updated Reference Circuit -Added configuration manual
D	2021.05.19	6. Dimensions, Marking and Terminal Configurations 7.2 Pin Description	-Added Dimensional tolerance -Added Internal pull values
E	2021.08.20	5. Certification Information	-Added configuration files for freeRTOS
F	2021.12.14	3. Ordering Information 9. Operating Conditions	- Added Updated the list - Defined IO current and Peak current

TABLE OF CONTENTS

Revision History.....	1
1. Scope	3
2. Key Features	3
3. Ordering Information	3
4. Block Diagram	3
5. Certification Information	4
5.1. Radio Certification	4
6. Dimensions, Marking and Terminal Configurations	5
7. Module Pin Descriptions	7
7.1. Pin Assignments	7
7.2. Pin Description.....	8
7.3. Configuration Pins	10
8. Absolute Maximum Ratings.....	11
9. Operating Conditions.....	11
9.1. Operating conditions.....	11
9.2. Digital I/O Requirements	11
10. Power Up Sequence	12
10.1. Power ON Sequence.....	12
10.2. Power OFF Sequence	12
11. Interface Timing	13
11.1. SDIO Specifications.....	13
11.1.1. Normal, High-Speed Modes.....	13
11.2. USB Specifications	14
11.2.1. USB Electrical Characteristics	15
11.2.2. High-Speed Source Electrical Characteristics	17
11.2.3. Full-Speed Source Electrical Characteristics.....	18
11.2.4. Device Event Timing Characteristics	19
11.2.5. LPM Timing Characteristics	20
12. DC / RF Characteristics	21
12.1. DC/RF Characteristics for IEEE802.11b - 2.4GHz.....	21
12.1.1. High Rate Condition for IEEE802.11b – 2.4GHz.....	21
12.1.2. Low Rate Condition for IEEE802.11b – 2.4GHz.....	22
12.2. DC/RF Characteristics for IEEE802.11g - 2.4GHz.....	23
12.2.1. High Rate Condition for IEEE802.11g – 2.4GHz.....	23
12.2.2. Low Rate Condition for IEEE802.11g – 2.4GHz.....	24
12.3. DC/RF Characteristics for IEEE802.11n - 2.4GHz.....	25
12.3.1. High Rate Condition for IEEE802.11n – 2.4GHz.....	25
12.3.2. Low Rate Condition for IEEE802.11n – 2.4GHz.....	26
13. Land Patterns	27
14. Reference Circuit.....	28
15. Tape and Reel Packing	29
16. NOTICE	32
16.1. Storage Conditions:	32
16.2. Handling Conditions:	32
16.3. Standard PCB Design (Land Pattern and Dimensions):.....	32
16.4. Notice for Chip Placer:.....	32
16.5. Soldering Conditions:	33
16.6. Cleaning:.....	33
16.7. Operational Environment Conditions:	33
17. Preconditions to Use Our Products.....	34
APPENDIX	35
User Manual.....	36
FCC	36
ISED (IC)	37
Japan.....	40

 Please be aware that an important notice concerning availability, standard warranty and use in critical applications of Murata products and disclaimers thereto appears at the end of this specification sheet.

1. Scope

This specification is applied to the IEEE802.11b/g/n W-LAN module

2. Key Features

- NXP / 88W8801
- Compliant with IEEE802.11b/g/n, SISO
- Supports standard SDIO2.0,USB2.0 interface for WLAN
- Surface mount type 25.0 x 14.0 mm(Typical), H = 2.32 mm(Max.)
- Weight : 1.07 mg
- MSL : 3
- RoHS compliant

3. Ordering Information

Ordering Part Number	Description
LBWA0ZZ2DS-688	MP order
LBWA0ZZ2DS-SMP	In case of sample order

“LBWA0ZZ2DS” is used in certification test report.

4. Block Diagram

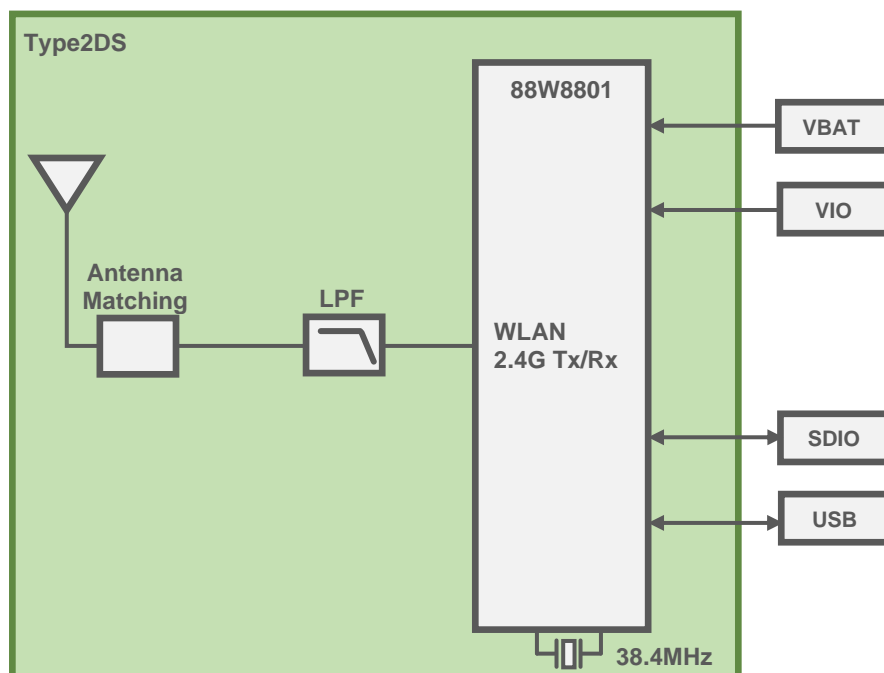

5. Certification Information

5.1. Radio Certification

*All regulatory testing is on-going

USA

FCC ID: VPYLBWA0ZZ2DS

Country Code: US

Tx Power limit file

freeRTOS: wlan_txpwrlimit_cfg_US.c

Linux: txpower_US.bin

Canada

IC: 772C-LBWA0ZZ2DS

Country Code: CA

Tx Power limit file

freeRTOS: wlan_txpwrlimit_cfg_CA.c

Linux: txpower_CA.bin

Europe

EN300328/301893, EN300440 conducted test report is prepared.

Country Code: DE

Tx Power limit file

freeRTOS: wlan_txpwrlimit_cfg_EU.c

Linux: txpower_EU.bin

Japan

Japanese type certification is prepared.

Ⓜ 001-P01579

Country Code: JP

Tx Power limit file

freeRTOS: wlan_txpwrlimit_cfg_JP.c

Linux: txpower_JP.bin

The each country code are defined by Murata's db.txt file.
Please ask your contact person from Murata.

6. Dimensions, Marking and Terminal Configurations

< Top View >

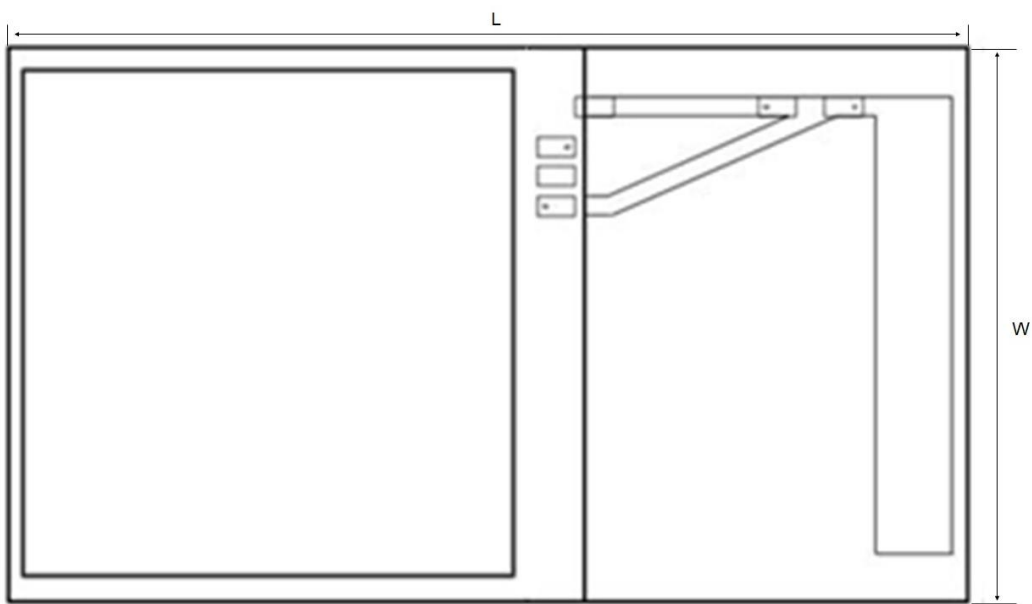

< Bottom View >

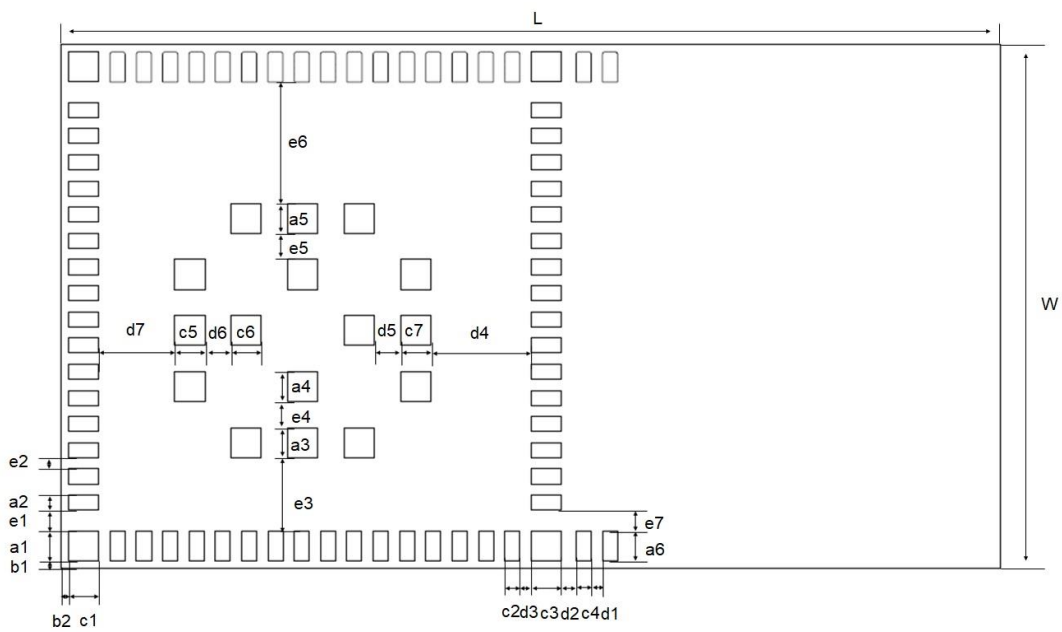

< Side View >

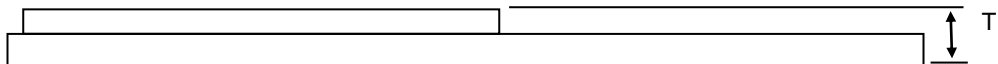

(unit : mm)

Mark	Dimensions	Mark	Dimensions	Mark	Dimensions	Mark	Dimensions
L	25.0 ± 0.2	W	14.0 ± 0.2	T	2.32 max.	a1	0.8 ± 0.1
a2	0.4 ± 0.1	a3	0.8 ± 0.2	a4	0.8 ± 0.1	a5	0.8 ± 0.1
a6	0.8 ± 0.1	b1	0.2 ± 0.2	b2	0.2 ± 0.2	c1	0.8 ± 0.1
c2	0.4 ± 0.1	c3	0.8 ± 0.1	c4	0.4 ± 0.1	c5	0.8 ± 0.1
c6	0.8 ± 0.1	c7	0.8 ± 0.1	d1	0.3 ± 0.1	d2	0.4 ± 0.1
d3	0.3 ± 0.1	d4	2.675 ± 0.1	d5	0.7 ± 0.1	d6	0.7 ± 0.1
d7	2.025 ± 0.1	e1	0.55 ± 0.1	e2	0.3 ± 0.1	e3	1.95 ± 0.1
e4	0.7 ± 0.1	e5	0.7 ± 0.1	e6	3.25 ± 0.1	e7	0.55 ± 0.1

Structure

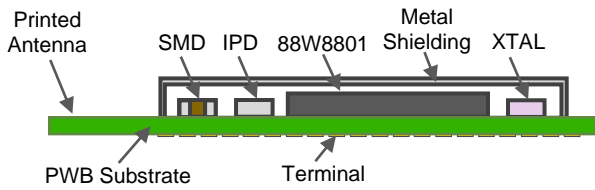

Marking

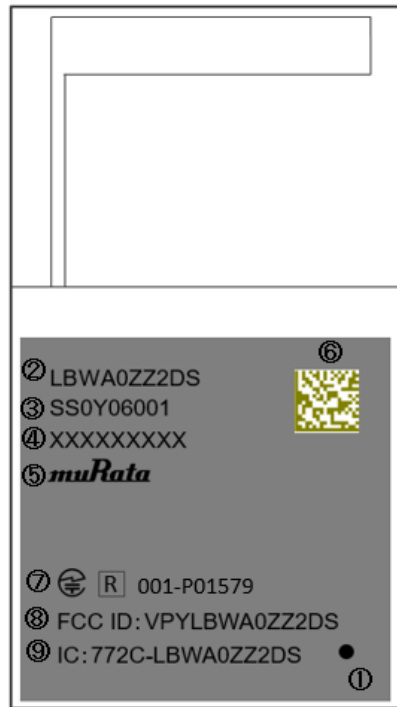

Marking	Meaning
1	Pin 1 Marking
2	Module Type
3	Inspection Number
4	Serial Number
5	Murata Logo
6	2D code
7	TELEC Mark/ID
8	FCC ID
9	IC ID

UL mark and factory code of one of below two PCB factories shall be displayed on the PCB.

SHINKO



FSQuality



7. Module Pin Descriptions

7.1. Pin Assignments

< TOP View >

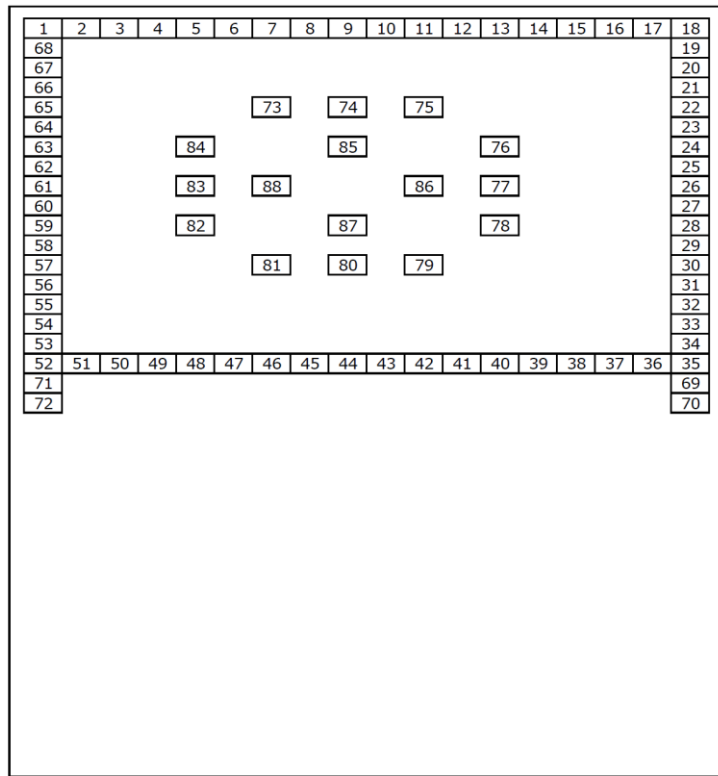

No.	Terminal Name	No.	Terminal Name	No.	Terminal Name	No.	Terminal Name
1	GND	18	GND	35	GND	52	GND
2	GND	19	GND	36	GND	53	GND
3	USB_DMNS	20	GND	37	GND	54	GND
4	USB_DPLS	21	GND	38	GND	55	VIO
5	GND	22	GND	39	GND	56	GPIO3
6	GND	23	GND	40	GND	57	GPIO2
7	GND	24	GND	41	VBAT	58	GPIO1
8	PDN	25	GND	42	GND	59	GPIO0
9	GND	26	GND	43	GND	60	GND
10	GND	27	GND	44	GND	61	VIO_SD
11	GND	28	GND	45	GND	62	SD_CLK
12	GND	29	NC	46	Reserved	63	SD_CMD
13	NC (REF_CLK_OUT)	30	GND	47	Reserved	64	SD_DAT3
14	CON0	31	Reserved	48	NC (TMS)	65	SD_DAT2
15	CON1	32	GND	49	NC (TDO)	66	SD_DAT1
16	NC (HOST_WAKE)	33	GND	50	NC (TCLK)	67	SD_DAT0
17	GND	34	GND	51	NC (TDI)	68-88	GND

7.2. Pin Description

No.	Pin Name	Type	Connection to IC pin name	Supply	Internal PU/PD	Int'l Pull Value[Ω]	Description
1	GND	-	-	-	-		Ground
2	GND	-	-	-	-		Ground
3	USB_DMNS	I/O	USB_DMNS	VBAT	-		USB Serial Differential Data Negative
4	USB_DPLS	I/O	USB_DPLS	VBAT	-		USB Serial Differential Data Positive
5	GND	-	-	-	-		Ground
6	GND	-	-	-	-		Ground
7	GND	-	-	-	-		Ground
8	PDN	I	PDn	V _{PD}	-		Full Power-Down (active low) 0 = full power-down mode 1 = normal mode • Connect to power-down pin of host or 3.3V/1.8V • External host required to drive this pin high for normal operation No internal pull-up on this pin.
9	GND	-	-	-	-		Ground
10	GND	-	-	-	-		Ground
11	GND	-	-	-	-		Ground
12	GND	-	-	-	-		Ground
13	NC (REF_CLK_OUT)	A,O	REF_CLK_OUT	AVDD18	-		NC
14	CON0	I	CON[0]	AVDD18	weak PU enable	600K	Configuration Pin (CON[0]) See Configuration Pins
15	CON1	I	CON[1]	AVDD18	weak PU enable	600K	Configuration Pin (CON[1]) See Configuration Pins
16	NC (HOST_WAKE)	I	HOST_WAKE	AVDD18	weak PD enable	700K	NC
17	GND	-	-	-	-		Ground
18	GND	-	-	-	-		Ground
19	GND	-	-	-	-		Ground
20	GND	-	-	-	-		Ground
21	GND	-	-	-	-		Ground
22	GND	-	-	-	-		Ground
23	GND	-	-	-	-		Ground
24	GND	-	-	-	-		Ground
25	GND	-	-	-	-		Ground
26	GND	-	-	-	-		Ground
27	GND	-	-	-	-		Ground
28	GND	-	-	-	-		Ground
29	NC	-	-	-	-		NC
30	GND	-	-	-	-		Ground
31	Reserved	A,IO	-	-	-		Ground
32	GND	-	-	-	-		Ground
33	GND	-	-	-	-		Ground
34	GND	-	-	-	-		Ground
35	GND	-	-	-	-		Ground
36	GND	-	-	-	-		Ground
37	GND	-	-	-	-		Ground
38	GND	-	-	-	-		Ground
39	GND	-	-	-	-		Ground
40	GND	-	-	-	-		Ground
41	VBAT	Power	VDD33	-	-		3.3V Digital Power Supply

No.	Pin Name	Type	Connection to IC pin name	Supply	Internal PU/PD	Int'l Pull Value[Ω]	Description
42	GND	-	-	-	-		Ground
43	GND	-	-	-	-		Ground
44	GND	-	-	-	-		Ground
45	GND	-	-	-	-		Ground
46	Reserved	O	RF_CNTL1_P-	-	-		NC
47	Reserved	O	RF_CNTL0_N-	-	-		NC
48	NC (TMS)	I	TMS	-	-		NC
49	NC (TDO)	O	TDO	-	-		NC
50	NC (TCLK)	I	TCK	-	-		NC
51	NC (TDI)	I	TDI	-	-		NC
52	GND	-	-	-	-		Ground
53	GND	-	-	-	-		Ground
54	GND	-	-	-	-		Ground
55	VIO	Power	VIO				1.8V/3.3V Digital I/O Power Supply
56	GPIO3	I/O	GPIO[3]	VIO	nominal PU enable	100k	GPIO Mode: GPIO[3]
57	GPIO2	I/O	GPIO[2]	VIO	weak PU enable	600k	GPIO Mode: GPIO[2]
58	GPIO1	I/O	GPIO[1]	VIO	weak PU enable	600k	GPIO Mode: GPIO[1] Host Wakeup: SoC-to-Host wakeup (output)
59	GPIO0	I/O	GPIO[0]	VIO	nominal PU enable	100k	GPIO Mode: GPIO[0]
60	GND	-	-	-	-		Ground
61	VIO_SD	Power	VIO_SD	-	-		1.8V/3.3V Digital I/O SDIO Power Supply
62	SD_CLK	I	SD_CLK	VIO_SD	nominal PU enable	100k	SDIO 4-bit Mode: Clock input SDIO 1-bit Mode: Clock input SDIO SPI Mode: Clock input
63	SD_CMD	I/O	SD_CMD/ USB_VBUS_ON	VIO_SD	nominal PU enable	100k	SDIO 4-bit Mode: Command/response (input/output) SDIO 1-bit Mode: Command line SDIO SPI Mode: Data input USB Mode: USB_VBUS_ON (input)
64	SD_DAT3	I/O	SD_DAT[3]	VIO_SD	nominal PU enable	100k	SDIO 4-bit Mode: Data line Bit[3] SDIO 1-bit Mode: Reserved SDIO SPI Mode: Card select (active low)
65	SD_DAT2	I/O	SD_DAT[2]	VIO_SD	nominal PU enable	100k	SDIO 4-bit Mode: Data line Bit[2] or read wait (optional) SDIO 1-bit Mode: Read wait (optional) SDIO SPI Mode: Reserved
66	SD_DAT1	I/O	SD_DAT[1]	VIO_SD	nominal PU enable	100k	SDIO 4-bit Mode: Data line Bit[1] SDIO 1-bit Mode: Interrupt SDIO SPI Mode: Interrupt SDO is tristate when SCSn is inactive. Enables multiple devices driving SDO line.
67	SD_DAT0	I/O	SD_DAT[0]	VIO_SD	nominal PU enable	100k	SDIO 4-bit Mode: Data line Bit[0] SDIO 1-bit Mode: Data line SDIO SPI Mode: Data output
68-88	GND	-	-	-	-		Ground

7.3. Configuration Pins

Configuration Bits	Pin Name	Configuration Function
CON[1]	CONFIG_HOST[1]	Firmware Boot Options 00 = reserved 01 = reserved 10 = SDIO 11 = USB
CON[0]	CONFIG_HOST[0]	

SDIO Pin Description

No.	Pin Name	(i) SD 4-bit Mode		(ii) SD 1-bit Mode	
62	SDI_CLK	CLK	Clock input	CLK	Clock input
67	SD_DAT0	DATA0	Data line 0	DATA	Data line
66	SD_DAT1	DATA1	Data line 1	IRQ	Interrupt
65	SD_DAT2	DATA2	Data line 2 or read wait (optional)	RW	Read wait (optional)
64	SD_DAT3	DATA3	Data line 3	NC	Reserved
63	SD_CMD	CMD	Command/response (input/output)	CMD	Command line

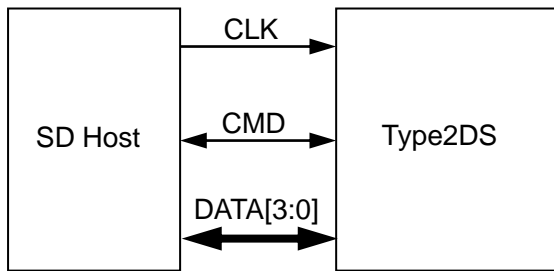

(i) SD 4-bit Mode

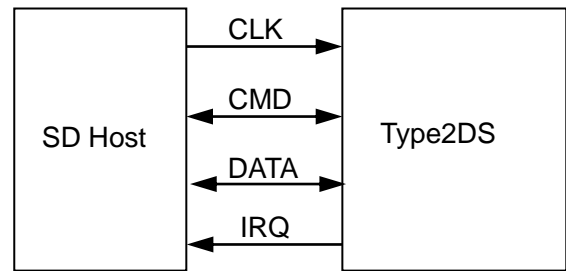

(ii) SD 1-bit Mode

8. Absolute Maximum Ratings

Parameter		Min	Max	Unit
Storage Temperature		-40	+85	deg.C
Supply Voltage	VBAT	-	4.0	V
	VIO	-	4.0	V

* Stresses in excess of the absolute ratings may cause permanent damage. Functional operation is not implied under these conditions. Exposure to absolute ratings for extended periods of time may adversely affect reliability. No damage assuming only one parameter is set at limit at a time with all other parameters are set within operating condition.

9. Operating Conditions

9.1. Operating conditions

Parameter		Min	Typ	Max	Unit
Operating Temperature Range		-40	+25	+85	deg.C
Supply Voltage	VBAT	2.97	3.3	3.63	V
	VIO	1.62	1.8	1.98	V
		2.97	3.3	3.63	V
Internal 1.8V	AVDD18	1.71	1.8	1.89	V
IO Current	VIO	-	0.1	0.5	mA
Peak current*	VBAT	-	430	550	mA

Note) Operation beyond the recommended operating conditions is neither recommended nor guaranteed.

*Peak current of VBAT (RF portion) is happen during DPD calibration when the firmware is downloaded.

9.2. Digital I/O Requirements

Symbol	Parameter	Condition	Min	Typ	Max	Unit
V _{IH}	Input high voltage	-	0.7*VIO	-	VIO+0.4	V
V _{IL}	Input low voltage	-	-0.4	-	0.3*VIO	V
V _{HYS}	Input hysteresis	-	100	-	-	mV
V _{OH}	Output high voltage	-	VIO-0.4	-	-	V
V _{OL}	Output low voltage	-	-	-	0.4	V
V _{PDH}	Input high voltage	-	1.4	-	5.5	V
V _{PDL}	Input low voltage	-	-0.4	-	0.5	V

10. Power Up Sequence

10.1. Power ON Sequence

Option 1

- External VBAT/VIO/VIO_SD from host.
- PDn driven by host

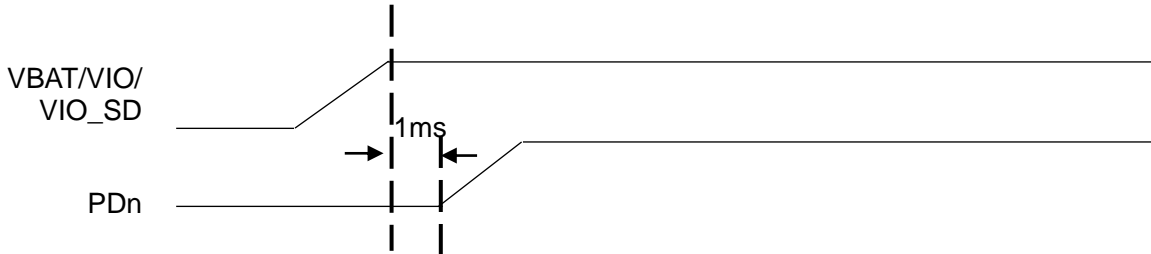

Assert PDn low (active) during VBAT/VIO/VIO_SD ramp-up.
Continue to assert low for a minimum of 1ms after VBAT/VIO/VIO_SD are stable.

Option 2

- External VBAT/VIO/VIO_SD from host.
- PDn is tied to VBAT

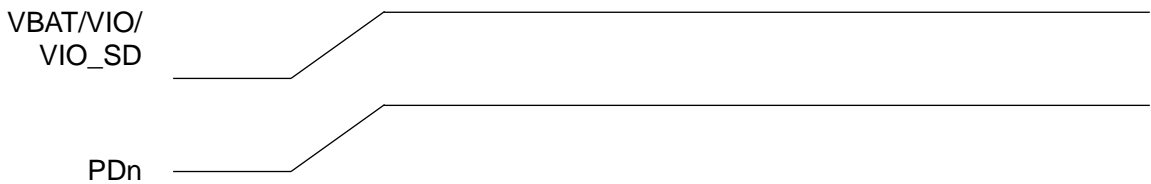

10.2. Power OFF Sequence

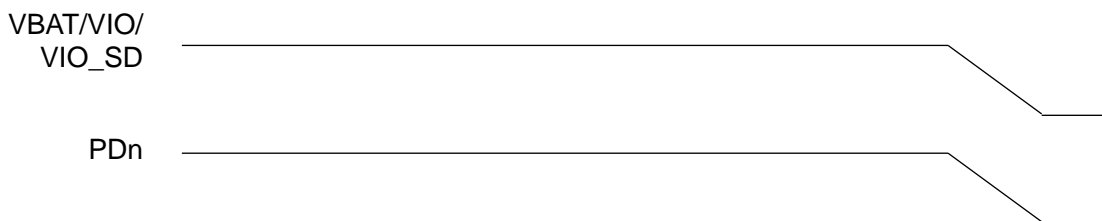

All power rails can be powered off. In this case, the state of the PDn Pin is irrelevant.

11. Interface Timing

11.1. SDIO Specifications

The SDIO host interface pins are powered from the VIO_SD voltage supply.
The SDIO electrical specifications are identical for the 1-bit SDIO and 4-bit SDIO modes.

11.1.1. Normal, High-Speed Modes

SDIO Protocol Timing Diagram—Normal Mode

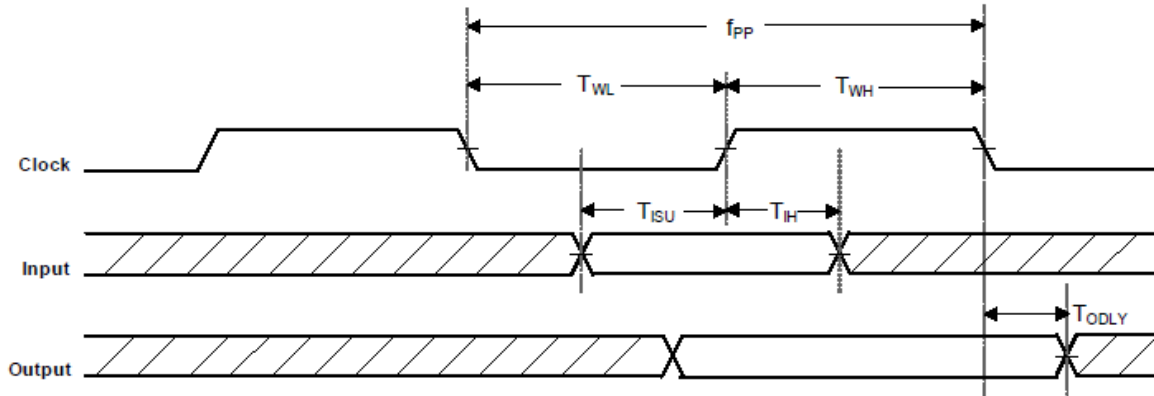

SDIO Protocol Timing Diagram—High Speed Mode (3.3V)

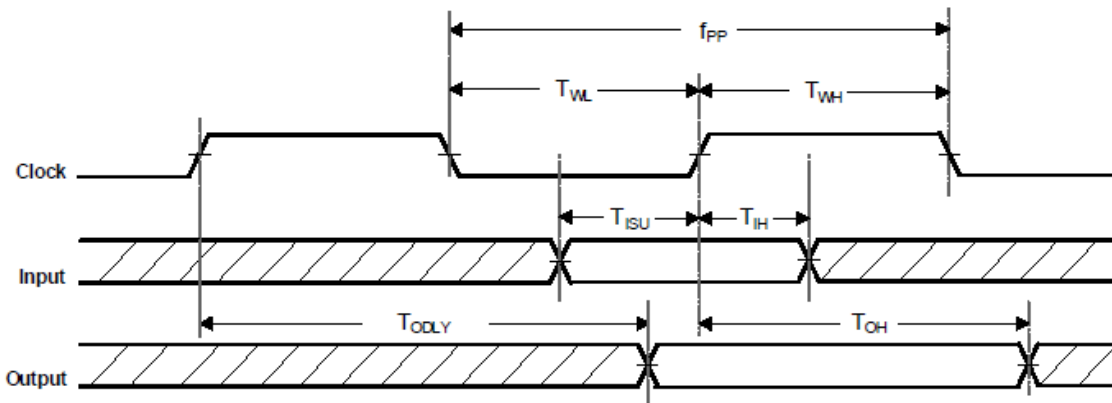

SDIO Timing Data—Normal, High-Speed Modes ¹

Note: Over full range of values specified in the Recommended Operating Conditions unless otherwise specified.

Symbol	Parameter	Condition	Min	Typ	Max	Units
f _{PP}	Clock frequency	Normal	0	-	25	MHz
		High-speed	0	-	50	MHz
T _{WL}	Clock low time	Normal	10	-	-	ns
		High-speed	7	-	-	ns
T _{WH}	Clock high time	Normal	10	-	-	ns
		High-speed	7	-	-	ns
T _{ISU}	Input setup time	Normal	5	-	-	ns
		High-speed	6	-	-	ns
T _{IH}	Input hold time	Normal	5	-	-	ns
		High-speed	2	-	-	ns
T _{ODLY}	Output delay time	Normal	-	-	14	ns
		High-speed	-	-	14	ns
T _{OH}	Output hold time	High-speed	2.5	-	-	ns

1. The SDIO-SPI CS signal timing is identical to all other SDIO inputs.

11.2. USB Specifications

The USB device interface is compliant with the Universal Serial Bus Specification, Revision 2.0, April 27, 2000. A USB host uses the USB cable bus and the USB 2.0 device interface to communicate with the chip.

Main features of the USB device interface include:

- High/full-speed operation (480/12 Mbps)
- Suspend/host resume/device resume (remote wake-up)
- Built-in DMA engine that reduces interrupt loads on the embedded processor and reduces the system bus bandwidth requirement for serving the USB device operation
- Supports Link Power Management (LPM), corresponding host resume, or device resume (remote wakeup) to exit from L1 sleep state

The USB 2.0 device interface is designed with 3.3V signal level pads.

Interface Signal Description

Module signal name	USB2.0 spec name	Type	Description
VBAT	VBUS	—	USB Bus Power Supply On-board regulator regulates voltage from VBUS level to voltage levels used by USB PHY.
SD_CMD/USB_VBUS_ON	—	I	USB Vbus On USB power valid indication
—	GND	—	USB Bus Ground Common ground on SoC device
USB_DPLS	D+	I/O	USB Bus Data Plus 1 of the differential data pair.
USB_DMNS	D-	I/O	USB Bus Data Minus 1 of the differential data pair.

USB 2.0 device host interface pins are powered from the VBAT voltage supply.

11.2.1. USB Electrical Characteristics

NOTE: Over full range of values specified in the Recommended Operating Conditions unless otherwise specified.

Symbol	Parameter	Condition	Min	Typ	Max	Units
Supply Current						
I_{CCHPF}	High-power function	--	--	--	500	mA
I_{CCLPF}	Low-power function	--	--	--	100	mA
I_{CCINIT}	Unconfigured function	--	--	--	100	mA
I_{CCSH}	Suspended high-power device	--	--	--	2.5	mA
I_{CCSL}	Suspended low-power device	--	--	--	500	μ A
Input Levels for Low/Full-Speed						
V_{IH}	Input high voltage (driven)	--	2.0	--	--	V
V_{IHZ}	Input high voltage (floating)	--	2.7	--	3.6	V
V_{IL}	Input low voltage	--	--	--	0.8	V
V_{DI}	Differential input sensitivity	--	0.2	--	--	V
V_{CM}	Differential common mode range	--	0.8	--	2.5	V
Input Levels for High-Speed						
V_{HSSQ}	High-speed squelch detection threshold (differential signal amplitude)	--	100	--	150	mV
V_{HSDSC}	High-speed disconnect detection threshold (differential signal amplitude)	--	525	--	625	mV
--	High-speed differential input signaling levels	Specified by eye pattern templates; see Section 7.1.7.2 in the USB 2.0 specification.	--	--	--	--
V_{HSCM}	High-speed data signaling common mode voltage range	--	-50	--	500	mV
Output Levels for Low/Full-Speed						
V_{OL}	Output low voltage	--	0.0	--	0.3	V
V_{OH}	Output high voltage (driven)	--	2.8	--	3.6	V
V_{OSE1}	Output SE1 voltage	--	0.8	--	--	V
V_{CRS}	Output signal crossover voltage	--	1.3	--	2.0	V

NOTE: Over full range of values specified in the Recommended Operating Conditions unless otherwise specified.

Symbol	Parameter	Condition	Min	Typ	Max	Units
Output Levels for High-Speed						
V _{HSOI}	High-speed idle level	--	-10.0	--	10.0	mV
V _{HSOH}	High-speed data signaling high	--	360	--	440	mV
V _{HSOL}	High-speed data signaling low	--	-10.0	--	10.0	mV
V _{CHIRPJ}	Chirp J level (differential voltage)	--	700	--	1100	mV
V _{CHIRPK}	Chirp K level (differential voltage)	--	-900	--	-500	mV
Decoupling Capacitance						
C _{RPB}	Upstream facing port bypass capacitance	--	1.0	--	10.0	μF
Input Capacitance for Low/Full-Speed						
C _{INUB}	Upstream facing port capacitance (without cable)	--	--	--	100	pF
C _{EDGE}	Transceiver edge rate control capacitance	--	--	--	75	pF
Input Impedance for High-Speed						
--	TDR spec for high-speed termination	Differential impedance	80	--	100	W
Terminations						
R _{PU1}	Bus pull-up resistor on upstream port (idles bus)	--	0.900	--	1.575	kΩ
R _{PUA}	Bus pull-up resistor on upstream port (receiving)	--	1.425	--	3.090	kΩ
Z _{INP}	Input impedance exclusive of pull-up/pull-down (for low/full-speed)	--	300	--	--	kΩ
V _{TERM}	Termination voltage for upstream facing port pull-up resistor (R _{PU})	--	3.0	--	3.6	V
Terminations in High-Speed						
V _{HSTERM}	Termination voltage in high-speed	--	-10	--	10	mV

11.2.2. High-Speed Source Electrical Characteristics

NOTE: Over full range of values specified in the Recommended Operating Conditions unless otherwise specified.

Symbol	Parameter	Condition	Min	Typ	Max	Units
<i>Driver Characteristics</i>						
T _{HSR}	Rise Time (10% - 90%)	--	500	--	--	ps
T _{HSF}	Fall Time (10% - 90%)	--	500	--	--	ps
--	Driver waveform requirements	Specified by eye pattern templates in Section 7.1.2 in the USB 2.0 specification.	--	--	--	--
Z _{HSDRV}	Driver output resistance (also serves as high-speed termination)	--	40.5	--	49.5	W
<i>Clock Timings</i>						
T _{HSDRAT}	High-speed data rate	--	479.760	--	480.240	Mb/s
T _{HSFRAM}	Microframe interval	--	124.9375	--	125.0625	μs
T _{HRSRFI}	Consecutive microframe interval difference	--	--	--	4 high-speed bit times	--
<i>High-Speed Data Timings</i>						
--	Data source jitter	Specified by eye pattern templates in Section 7.1.2.2 in the USB 2.0 specification.	--	--	--	--
--	Receiver jitter tolerance	Specified by eye pattern templates in Section 7.1.2.2 in the USB 2.0 specification.	--	--	--	--

11.2.3. Full-Speed Source Electrical Characteristics

NOTE: Over full range of values specified in the Recommended Operating Conditions unless otherwise specified.

Symbol	Parameter	Condition	Min	Typ	Max	Units
<i>Driver Characteristics</i>						
T _{FR}	Rise time	--	4	--	20	ns
T _{FF}	Fall time	--	4	--	20	ns
T _{FRFM}	Differential rise and fall time matching	T _{FR} /T _{FF}	90	--	111.11	%
<i>Clock Timing</i>						
T _{FDRATHS}	Full-speed data rate	Average bit rate	11.9940	--	12.0060	Mb/s
T _{FDRATE}	Frame interval	--	0.9995	--	1.00005	ms
T _{RFI}	Consecutive frame interval difference	No clock adjustment	--	--	42	ms
<i>Full-Speed Data Timing</i>						
T _{DJ1}	Source jitter total to next transition (including frequency tolerance)	--	-3.5	--	3.5	ns
T _{DJ2}	Source jitter total for paired transitions (including frequency tolerance)	--	-4	--	4	ns
T _{FDEOP}	Source jitter for differential transition to SE0 transition	--	-2	--	5	ns
T _{JR1}	Receiver jitter to next transition	--	-18.5	--	18.5	ns
T _{JR2}	Receiver jitter to next transition	--	-9	--	9	ns
T _{FEOPT}	Source SE0 interval of EOP	--	160	--	175	ns
T _{FEOPR}	Receiver SE0 interval of EOP	--	82	--	--	ns
T _{FST}	Width of SE0 interval during differential transition	--	--	--	14	ns

11.2.4. Device Event Timing Characteristics

NOTE: Over full range of values specified in the Recommended Operating Conditions unless otherwise specified.

Symbol	Parameter	Condition	Min	Typ	Max	Units
T _{SIGATT}	Time from internal power good to device pulling D+/D- beyond V _{IHZ} (min) (signaling attach)	--	--	--	100	ms
T _{ATTDB}	Debounce interval provided by USB system software after attach	--	--	--	100	ms
T _{2SUSP}	Maximum time a device can draw power > suspend power when bus is continuously in idle state	--	--	--	10	ms
T _{SUSAVGI}	Maximum duration of suspend averaging interval	--	--	--	1	s
T _{WTRSM}	Period of idle bus before device can initiate resume	Device must be remote-wake-up enabled	5	--	--	ms
T _{DRSMUP}	Duration of driving resume upstream	--	1	--	15	ms
T _{RSMCY}	Resume recovery time	Provided by USB system software	10	--	--	ms
T _{RSTRCY}	Reset recovery time	--	--	--	10	ms
T _{IPD}	Inter-packet delay (for low/full-speed)	--	2	--	--	bit times
T _{RSPIPD1}	Inter-packet delay for device response with detachable cable for low/full-speed	--	--	--	6.5	bit times
T _{RSPIPD2}	Inter-packet delay for device response with captive cable for low/full-speed	--	--	--	7.5	bit times
T _{DSETADDR}	SetAddress() completion time	--	--	--	50	ms
T _{DRQCMLTND}	Time to complete standard request with no data	--	--	--	50	ms
T _{DRETDATA1}	Time to deliver first and subsequent (except last) data for standard request	--	--	--	500	ms
T _{DRETDATAN}	Time to deliver last data for standard request	--	--	--	50	ms
T _{HRSRSPID2}	Inter-packet delay for device response with captive cable (high-speed)	--	--	--	192 bit times + 52 ns	--
Reset Handshake Protocol						
F _{FILTSE0}	Time for which a suspended high-speed capable device must see a continuous SE0 before beginning the high-speed detection handshake	--	2.5	--	--	μs

NOTE: Over full range of values specified in the Recommended Operating Conditions unless otherwise specified.

Symbol	Parameter	Condition	Min	Typ	Max	Units
T _{WTRSTFS}	Time for which a high-speed capable device operating in non-suspended full-speed must wait after start of SE0 before beginning the high-speed detection handshake	--	2.5	--	3000	μs
T _{WTREV}	Time for which a high-speed capable device operating in high-speed must wait after start of SE0 before reverting to full-speed	--	3.0	--	3.125	ms
T _{WTRSTHS}	Time for which a device must wait after reverting to full-speed before sampling the bus state for SE0 and beginning the high-speed detection handshake	--	100	--	875	μs
T _{UCH}	Minimum duration of a Chirp K from a high-speed capable device within the reset protocol	--	1.0	--	--	ms
T _{UCHEND}	Time after start of SE0 by which a high-speed capable device is required to have completed its Chirp K within the reset protocol	--	--	--	7.01	ms
T _{WTHS}	Time after end of upstream chirp at which device enters the high-speed default state if downstream chirp is detected	--	--	--	500	μs
T _{WTFS}	Time after end of upstream chirp at which device reverts to full-speed default stat if no downstream chirp is detected	--	1.0	--	2.5	ms

11.2.5. LPM Timing Characteristics

Symbol	Parameter	Condition	Min	Typ	Max	Units
TL1 _{Residency}	L1 residency	--	50	--	>50	μs
TL1 _{TokenRetry}	Device delay before transitioning to L1 after transmitting ACK	--	8	--	10	μs
TL1 _{HubDrvResume1}	Host initiated L1 exit host drives resume time	--	50 ±1	--	1200 ±1	μs
TL1 _{DevDrvResume}	Device initiated L1 exit Device drives resume time	--	50 ±1	--	--	μs
TL1 _{ExitDevRecovery}	L1 exit device recovery time	--	10	--	--	μs
TL1 _{ExitLatency1}	L1 exit latency (host initiated)	--	60	--	1210	μs
TL1 _{ExitLatency2}	L1 exit latency (device initiated)	--	70	--	1000	μs

12. DC / RF Characteristics

- ALL DC/RF characteristics are defined by following file.

WLAN Tx Power	txpower_US.bin, txpower_CA.bin, txpower_EU.bin, txpower_JP.bin
WLAN Regulatory Limit	db.txt
Energy Detect	ed_mac.bin

- Burst current definition

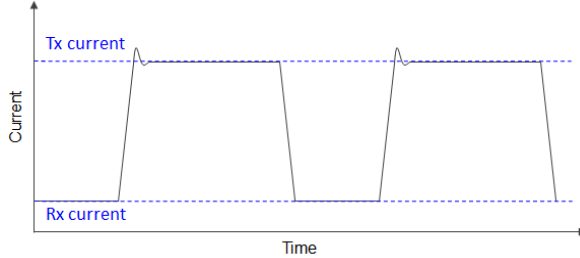

12.1. DC/RF Characteristics for IEEE802.11b - 2.4GHz

Specification	IEEE802.11b-2.4GHz
Mode	DSSS / CCK
Channel Frequency	2412 to 2472 MHz (5MHz)
Data rate	1, 2, 5.5, 11Mbps

12.1.1. High Rate Condition for IEEE802.11b – 2.4GHz

Conditions : 25deg.C, VBAT=3.3V, Output power setting=17dBm at module pad, 11Mbps mode

Items	Contents			
	Min.	Typ.	Max.	Unit
- DC Characteristics -				
1. DC current				
1) Tx mode	-	330	408	mA
2) Rx mode	-	69	92	mA
- Tx Characteristics -	Min.	Typ.	Max.	Unit
2. Output Power	14.5	17.0	19.5	dBm
3. Spectrum Mask Margin				
1) 1st side lobes(-30dBr)	0	-	-	dB
2) 2nd side lobes(-50dBr)	0	-	-	dB
4. Power-on/off ramp	-	-	2.0	usec
5. RF Carrier Suppression	15	-	-	dB
6. Modulation Accuracy	-	-	35	%
7. Frequency tolerance	-25		25	ppm
8. Spurious Emissions				
1) 30-47MHz (BW=100kHz)	-	-	-36	dBm
2) 47-74MHz (BW=100kHz)	-	-	-54	dBm
3) 74-87.5MHz (BW=100kHz)	-	-	-36	dBm
4) 87.5-118MHz (BW=100kHz)	-	-	-54	dBm
5) 118-174MHz (BW=100kHz)	-	-	-36	dBm
6) 174-230MHz (BW=100kHz)	-	-	-54	dBm
7) 230-470MHz (BW=100kHz)	-	-	-36	dBm
8) 470-862MHz (BW=100kHz)	-	-	-54	dBm
9) 862-1000MHz (BW=100kHz)	-	-	-36	dBm
10) 1000-12750MHz (BW=1MHz)	-	-	-30	dBm
- Rx Characteristics -	Min.	Typ.	Max.	Unit
9. Minimum Input Level (FER _≤ 8%)	-	-	-76	dBm
10. Maximum Input Level (FER _≤ 8%)	-10	-	-	dBm
11. Adjacent Channel Rejection (FER< 8%)	35	-	-	dB

12.1.2. Low Rate Condition for IEEE802.11b – 2.4GHz

Conditions : 25deg.C, VBAT=3.3V, Output power setting=17dBm at module pad, 1Mbps mode

Items	Contents			
	Min.	Typ.	Max.	Unit
- DC Characteristics -				
1. DC current				
1) Tx mode	-	335	417	mA
2) Rx mode	-	69	91	mA
- Tx Characteristics -				
	Min.	Typ.	Max.	Unit
2. Output Power	14.5	17.0	19.5	dBm
3. Spectrum Mask Margin				
1) 1st side lobes(-30dBr)	0	-	-	dB
2) 2nd side lobes(-50dBr)	0	-	-	dB
4. Power-on/off ramp	-	-	2.0	Usec
5. RF Carrier Suppression	15	-	-	dB
6. Modulation Accuracy	-	-	35	%
7. Frequency tolerance	-25		25	ppm
8. Spurious Emissions				
1) 30-47MHz (BW=100kHz)	-	-	-36	dBm
2) 47-74MHz (BW=100kHz)	-	-	-54	dBm
3) 74-87.5MHz (BW=100kHz)	-	-	-36	dBm
4) 87.5-118MHz (BW=100kHz)	-	-	-54	dBm
5) 118-174MHz (BW=100kHz)	-	-	-36	dBm
6) 174-230MHz (BW=100kHz)	-	-	-54	dBm
7) 230-470MHz (BW=100kHz)	-	-	-36	dBm
8) 470-862MHz (BW=100kHz)	-	-	-54	dBm
9) 862-1000MHz (BW=100kHz)	-	-	-36	dBm
10) 1000-12750MHz (BW=1MHz)	-	-	-30	dBm
- Rx Characteristics -				
	Min.	Typ.	Max.	Unit
9. Minimum Input Level (FER _≤ 8%)	-	-	-80	dBm
10. Maximum Input Level (FER _≤ 8%)	-4	-	-	dBm
11. Adjacent Channel Rejection (FER< 8%)	35	-	-	dB

12.2. DC/RF Characteristics for IEEE802.11g - 2.4GHz

Specification	IEEE802.11g
Mode	OFDM
Channel Frequency	2412 - 2472MHz
Data rate	6, 9, 12, 18, 24, 36, 48, 54Mbps

12.2.1. High Rate Condition for IEEE802.11g – 2.4GHz

Conditions : 25deg.C, VBAT=3.3V, Output power setting=14dBm at module pad, 54Mbps mode

Items	Contents			
	Min.	Typ.	Max.	Unit
- DC Characteristics -				
1. DC current				
1) Tx mode	-	302	376	mA
2) Rx mode	-	72	94	mA
- Tx Characteristics -	Min.	Typ.	Max.	Unit
2. Output Power	11.5	14.0	16.5	dBm
3. Spectrum Mask Margin				
1) 9MHz to 11MHz (0~ -20dBr)	0	-	-	dB
2) 11MHz to 20MHz (-20~ -28dBr)	0	-	-	dB
3) 20MHz to 30MHz (-28~ -40dBr)	0	-	-	dB
4) 30MHz to 33MHz (-40dBr)	0	-	-	dB
4. Constellation Error(EVM)	-	-	-25	dB
5. Frequency tolerance	-25		25	ppm
6. Spurious Emissions				
1) 30-47MHz (BW=100kHz)	-	-	-36	dBm
2) 47-74MHz (BW=100kHz)	-	-	-54	dBm
3) 74-87.5MHz (BW=100kHz)	-	-	-36	dBm
4) 87.5-118MHz (BW=100kHz)	-	-	-54	dBm
5) 118-174MHz (BW=100kHz)	-	-	-36	dBm
6) 174-230MHz (BW=100kHz)	-	-	-54	dBm
7) 230-470MHz (BW=100kHz)	-	-	-36	dBm
8) 470-862MHz (BW=100kHz)	-	-	-54	dBm
9) 862-1000MHz (BW=100kHz)	-	-	-36	dBm
10) 1000-12750MHz (BW=1MHz)	-	-	-30	dBm
- Rx Characteristics -	Min.	Typ.	Max.	Unit
7. Minimum Input Level (PER < 10%)	-	-	-65	dBm
8. Maximum Input Level (PER < 10%)	-20	-	-	dBm
9. Adjacent Channel Rejection (PER< 10%)	-1	-	-	dB

12.2.2. Low Rate Condition for IEEE802.11g – 2.4GHz

Conditions : 25deg.C, VBAT=3.3V, Output power setting=15dBm at module pad, 6Mbps mode

Items	Contents			
	Min.	Typ.	Max.	Unit
- DC Characteristics -				
1. DC current				
1) Tx mode	-	313	391	mA
2) Rx mode	-	71	93	mA
- Tx Characteristics -				
2. Output Power	12.5	15.0	17.5	dBm
3. Spectrum Mask Margin				
1) 9MHz to 11MHz (0~ -20dB)	0	-	-	dB
2) 11MHz to 20MHz (-20~ -28dB)	0	-	-	dB
3) 20MHz to 30MHz (-28~ -40dB)	0	-	-	dB
4) 30MHz to 33MHz (-40dB)	0	-	-	dB
4. Constellation Error(EVM)	-	-	-5	dB
5. Frequency tolerance	-25		25	ppm
6. Spurious Emissions				
1) 30-47MHz (BW=100kHz)	-	-	-36	dBm
2) 47-74MHz (BW=100kHz)	-	-	-54	dBm
3) 74-87.5MHz (BW=100kHz)	-	-	-36	dBm
4) 87.5-118MHz (BW=100kHz)	-	-	-54	dBm
5) 118-174MHz (BW=100kHz)	-	-	-36	dBm
6) 174-230MHz (BW=100kHz)	-	-	-54	dBm
7) 230-470MHz (BW=100kHz)	-	-	-36	dBm
8) 470-862MHz (BW=100kHz)	-	-	-54	dBm
9) 862-1000MHz (BW=100kHz)	-	-	-36	dBm
10) 1000-12750MHz (BW=1MHz)	-	-	-30	dBm
- Rx Characteristics -				
7. Minimum Input Level (PER < 10%)	-	-	-82	dBm
8. Maximum Input Level (PER < 10%)	-20	-	-	dBm
9. Adjacent Channel Rejection (PER< 10%)	-1	-	-	dB

12.3. DC/RF Characteristics for IEEE802.11n - 2.4GHz

Specification	IEEE802.11n
Mode	OFDM
Channel Frequency	2412 - 2472MHz
Data rate	MCS0-MCS7

12.3.1. High Rate Condition for IEEE802.11n – 2.4GHz

Conditions : 25deg.C, VBAT=3.3V, Output power setting=13dBm at module pad, MCS7 mode

Items	Contents			
	Min.	Typ.	Max.	Unit
- DC Characteristics -				
1. DC current				
1) Tx mode	-	302	378	mA
2) Rx mode	-	72	94	mA
- Tx Characteristics -	Min.	Typ.	Max.	Unit
2. Output Power	11.5	14.0	16.5	dBm
3. Spectrum Mask Margin				
1) 9MHz to 11MHz (0~ -20dBr)	0	-	-	dB
2) 11MHz to 20MHz (-20~ -28dBr)	0	-	-	dB
3) 20MHz to 30MHz (-28~ -45dBr)	0	-	-	dB
4) 30MHz to 33MHz (-45dBr)	0	-	-	dB
4. Constellation Error (EVM) (measured at enhanced mode)	-	-	-27	dB
5. Frequency tolerance	-25		25	ppm
6. Spurious Emissions				
1) 30-47MHz (BW=100kHz)	-	-	-36	dBm
2) 47-74MHz (BW=100kHz)	-	-	-54	dBm
3) 74-87.5MHz (BW=100kHz)	-	-	-36	dBm
4) 87.5-118MHz (BW=100kHz)	-	-	-54	dBm
5) 118-174MHz (BW=100kHz)	-	-	-36	dBm
6) 174-230MHz (BW=100kHz)	-	-	-54	dBm
7) 230-470MHz (BW=100kHz)	-	-	-36	dBm
8) 470-862MHz (BW=100kHz)	-	-	-54	dBm
9) 862-1000MHz (BW=100kHz)	-	-	-36	dBm
10) 1000-12750MHz (BW=1MHz)	-	-	-30	dBm
- Rx Characteristics -	Min.	Typ.	Max.	Unit
7. Minimum Input Level (PER ≤ 10%)	-	-	-64	dBm
8. Maximum Input Level (PER < 10%)	-20	-	-	dBm
9. Adjacent Channel Rejection (PER ≤ 10%)	-2	-	-	dB

12.3.2. Low Rate Condition for IEEE802.11n – 2.4GHz

Conditions : 25deg.C, VBAT=3.3V, Output power setting=15dBm at module pad, MCS0 mode

Items	Contents			
	Min.	Typ.	Max.	Unit
- DC Characteristics -				
1. DC current				
1) Tx mode	-	315	392	mA
2) Rx mode	-	71	93	mA
- Tx Characteristics -				
2. Output Power	12.5	15.0	17.5	dBm
3. Spectrum Mask Margin				
1) 9MHz to 11MHz (0~ -20dBr)	0	-	-	dB
2) 11MHz to 20MHz (-20~ -28dBr)	0	-	-	dB
3) 20MHz to 30MHz (-28~ -45dBr)	0	-	-	dB
4) 30MHz to 33MHz (-45dBr)	0	-	-	dB
4. Constellation Error (EVM) (measured at enhanced mode)	-	-	-5	dB
5. Frequency tolerance	-25		25	ppm
6. Spurious Emissions				
1) 30-47MHz (BW=100kHz)	-	-	-36	dBm
2) 47-74MHz (BW=100kHz)	-	-	-54	dBm
3) 74-87.5MHz (BW=100kHz)	-	-	-36	dBm
4) 87.5-118MHz (BW=100kHz)	-	-	-54	dBm
5) 118-174MHz (BW=100kHz)	-	-	-36	dBm
6) 174-230MHz (BW=100kHz)	-	-	-54	dBm
7) 230-470MHz (BW=100kHz)	-	-	-36	dBm
8) 470-862MHz (BW=100kHz)	-	-	-54	dBm
9) 862-1000MHz (BW=100kHz)	-	-	-36	dBm
10) 1000-12750MHz (BW=1MHz)	-	-	-30	dBm
- Rx Characteristics -				
7. Minimum Input Level (PER ≤ 10%)	-	-	-82	dBm
8. Maximum Input Level (PER < 10%)	-20	-	-	dBm
9. Adjacent Channel Rejection (PER ≤ 10%)	-2	-	-	dB

14. Reference Circuit

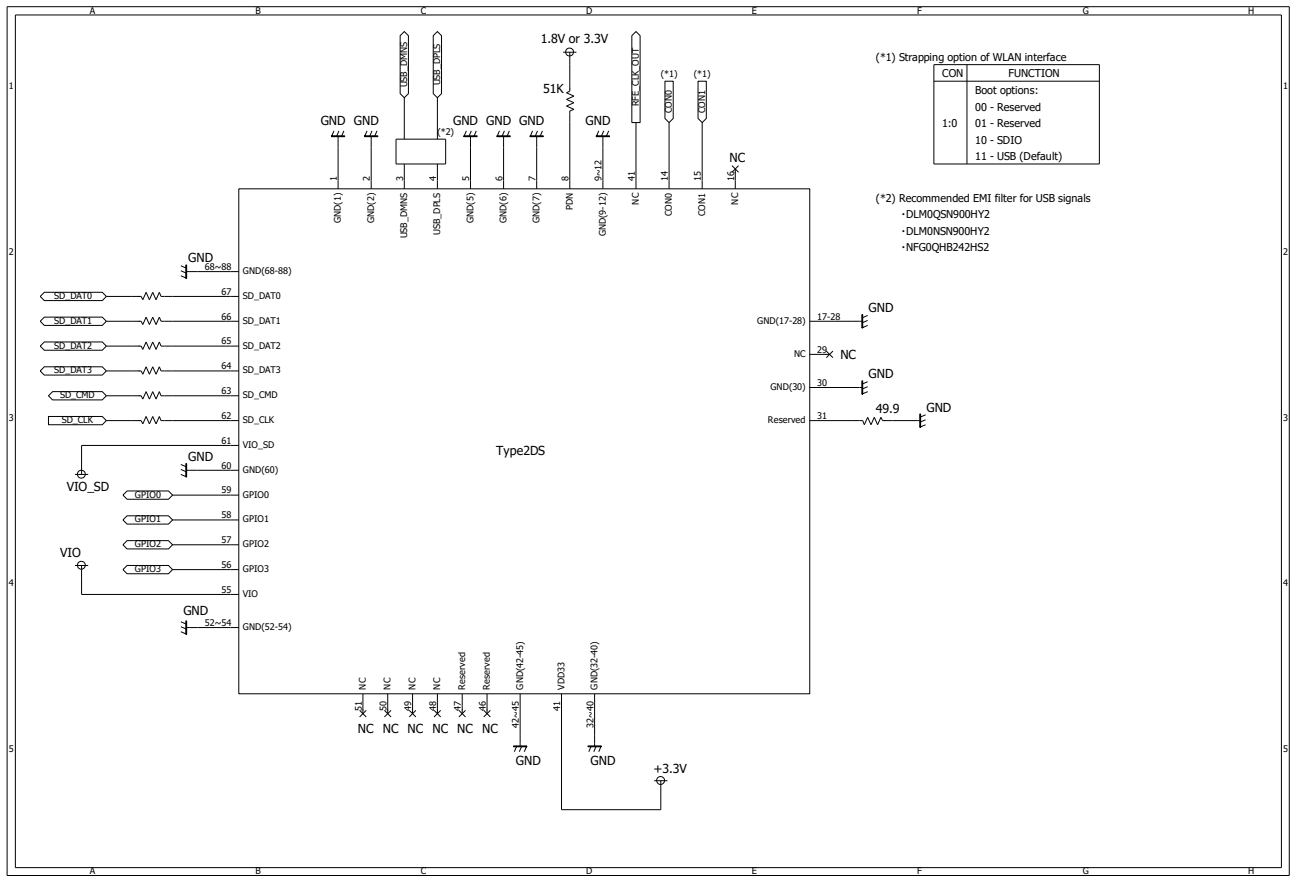

15. Tape and Reel Packing

(1) Dimensions of Tape (Plastic tape)

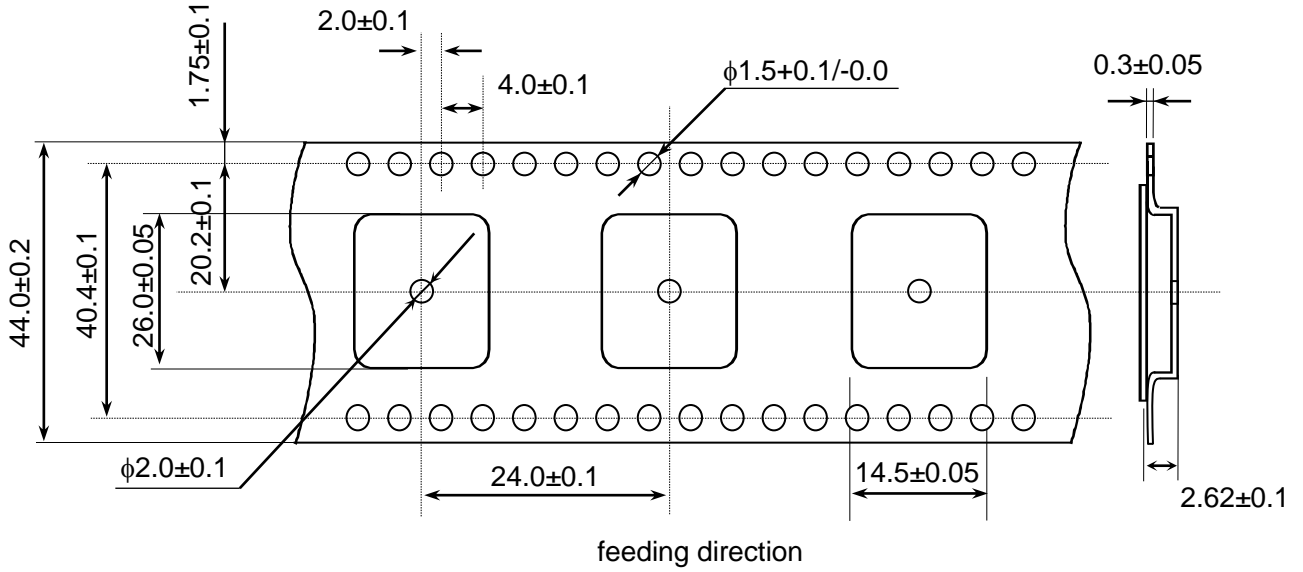

(2) Dimensions of Reel

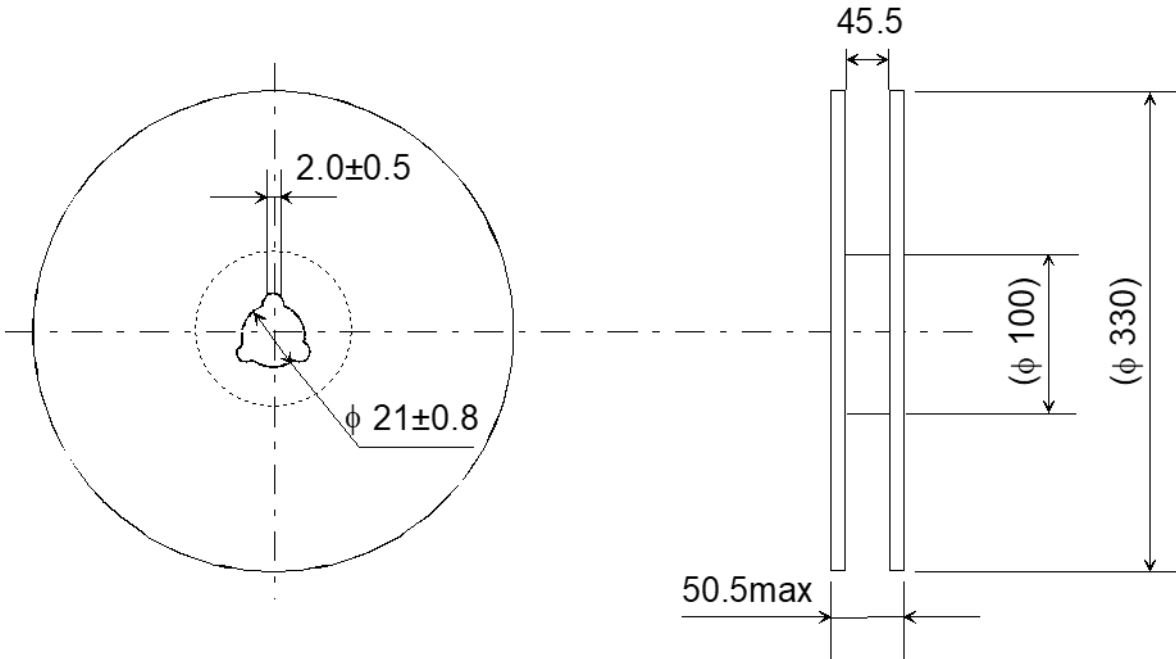

(unit : mm)

(3) Taping Diagrams

- [1] Feeding Hole : As specified in (1)
- [2] Hole for chip : As specified in (1)
- [3] Cover tape : 62μm in thickness
- [4] Base tape : As specified in (1)

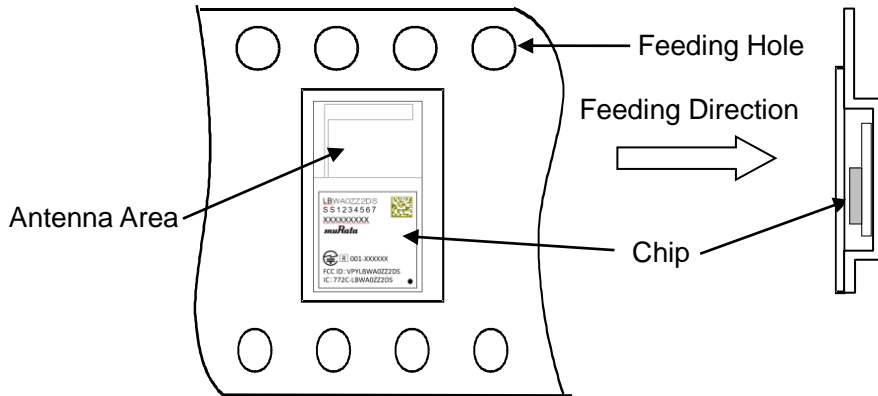
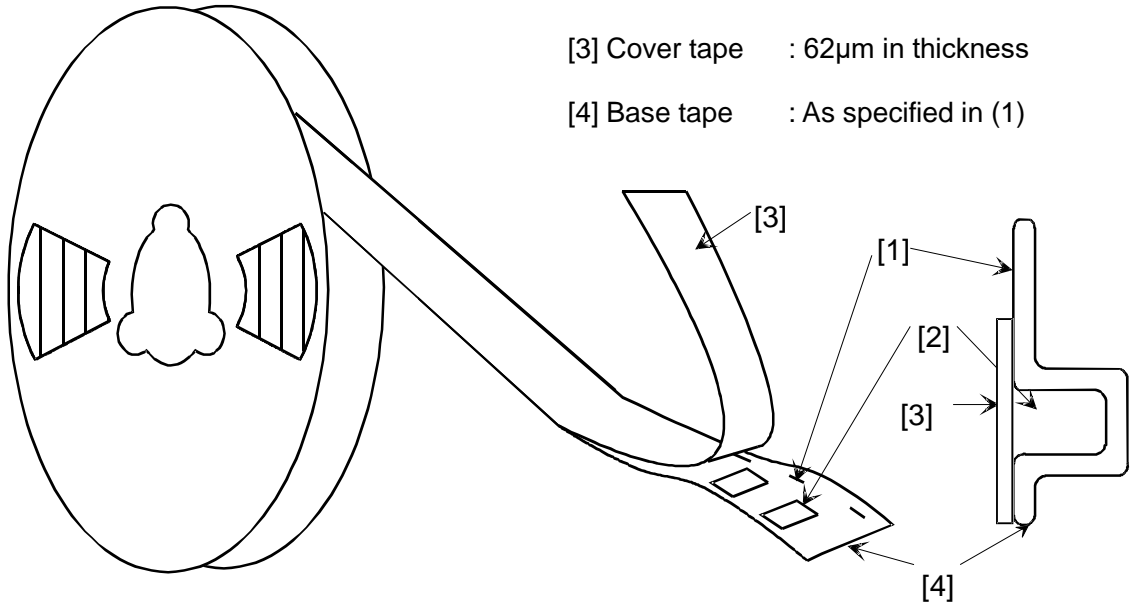

(4) Leader and Tail tape

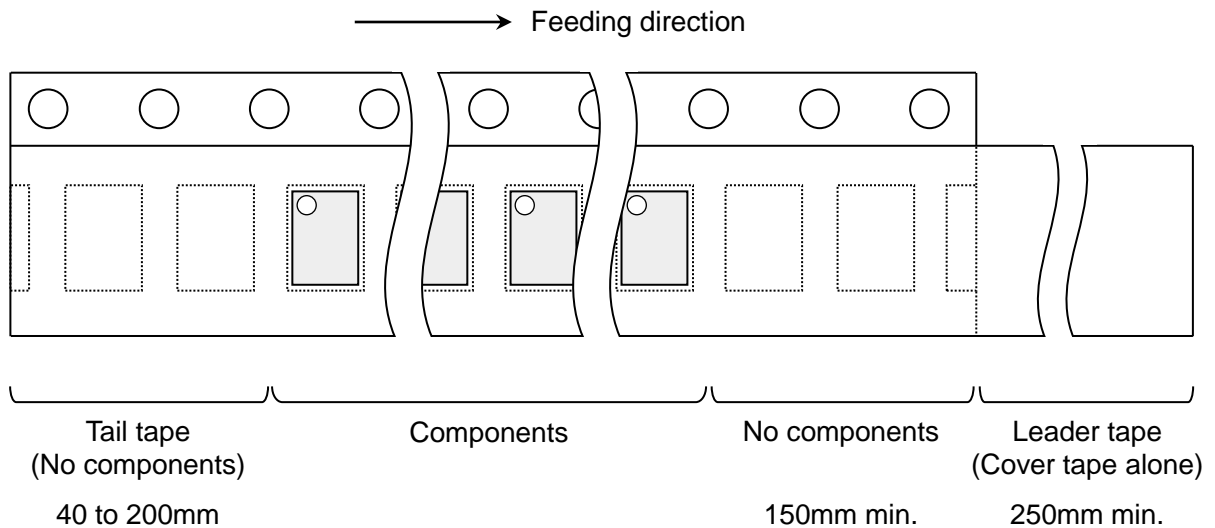

- (5) The tape for chips are wound clockwise, the feeding holes to the right side as the tape is pulled toward the user.
- (6) The cover tape and base tape are not adhered at no components area for 250mm min.
- (7) Tear off strength against pulling of cover tape : 5N min.
- (8) Packaging unit : 500pcs./ reel
- (9) material : Base tape : Plastic
Real : Plastic
Cover tape, cavity tape and reel are made the anti-static processing.
- (10) Peeling of force : 1.1N max. in the direction of peeling as shown below.

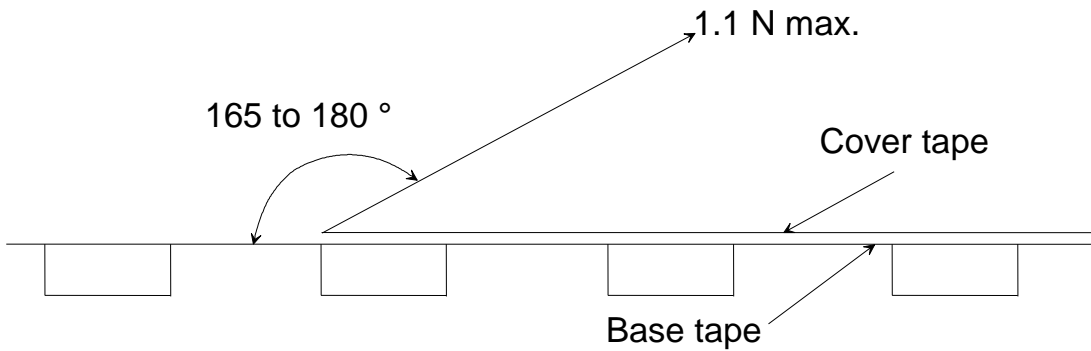

- (11) Packaging (Humidity proof Packing)

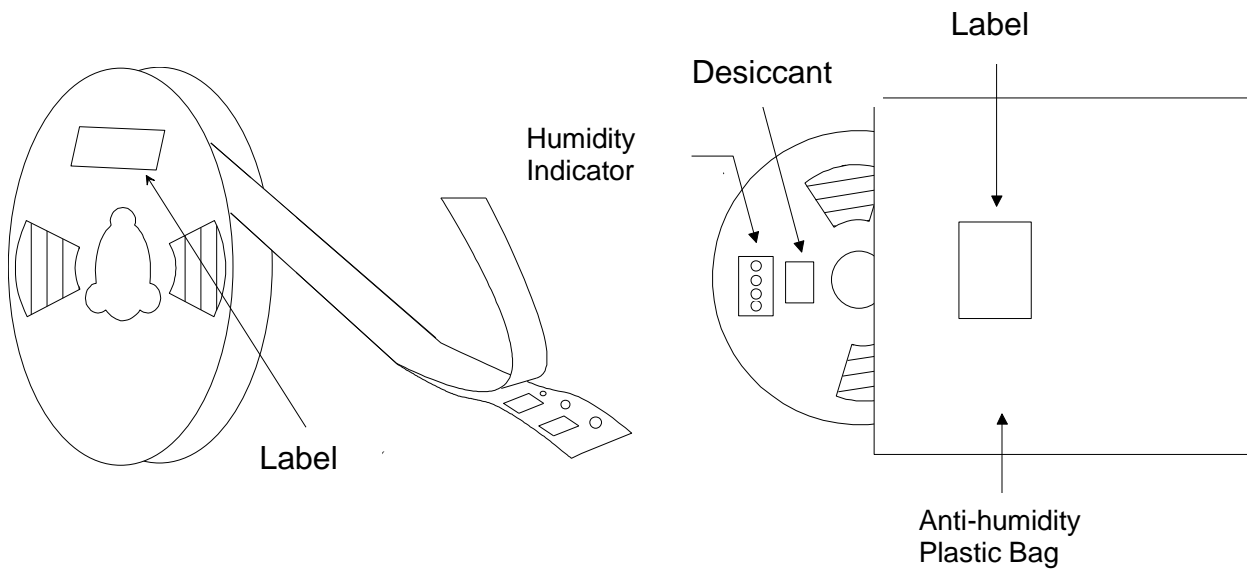

Tape and reel must be sealed with the anti-humidity plastic bag. The bag contains the desiccant and the humidity indicator.

16. NOTICE

16.1. Storage Conditions:

Please use this product within 6month after receipt.

- The product shall be stored without opening the packing under the ambient temperature from 5 to 35 °C and humidity from 20 ~ 70 %RH.
(Packing materials, in particular, may be deformed at the temperature over 40 °C)
- The product left more than 6months after reception, it needs to be confirmed the solderbility before used.
- The product shall be stored in non corrosive gas (Cl₂, NH₃, SO₂, Nox, etc.).
- Any excess mechanical shock including, but not limited to, sticking the packing materials by sharp object and dropping the product, shall not be applied in order not to damage the packing materials.

This product is applicable to MSL3 (Based on IPC/JEDEC J-STD-020)

- After the packing opened, the product shall be stored at <30 °C / <60 %RH and the product shall be used within 168 hours.
- When the color of the indicator in the packing changed, the product shall be baked before soldering.

Baking condition : 125 +5/-0 °C, 24 hours, 1 time

The products shall be baked on the heat-resistant tray because the material (Base Tape, Reel Tape and Cover Tape) are not heat-resistant.

16.2. Handling Conditions:

Be careful in handling or transporting products because excessive stress or mechanical shock may break products.

Handle with care if products may have cracks or damages on their terminals, the characteristics of products may change. Do not touch products with bare hands that may result in poor solder ability and destroy by static electrical charge.

16.3. Standard PCB Design (Land Pattern and Dimensions):

All the ground terminals should be connected to the ground patterns. Furthermore, the ground pattern should be provided between IN and OUT terminals. Please refer to the specifications for the standard land dimensions.

The recommended land pattern and dimensions is as Murata's standard. The characteristics of products may vary depending on the pattern drawing method, grounding method, land dimensions, land forming method of the NC terminals and the PCB material and thickness. Therefore, be sure to verify the characteristics in the actual set. When using non-standard lands, contact Murata beforehand.

16.4. Notice for Chip Placer:

When placing products on the PCB, products may be stressed and broken by uneven forces from a worn-out chucking locating claw or a suction nozzle. To prevent products from damages, be sure to follow the specifications for the maintenance of the chip placer being used. For the positioning of products on the PCB, be aware that mechanical chucking may damage products.

16.5. Soldering Conditions:

The recommendation conditions of soldering are as in the following figure.

Soldering must be carried out by the above mentioned conditions to prevent products from damage. Set up the highest temperature of reflow within 260 °C. Contact Murata before use if concerning other soldering conditions.

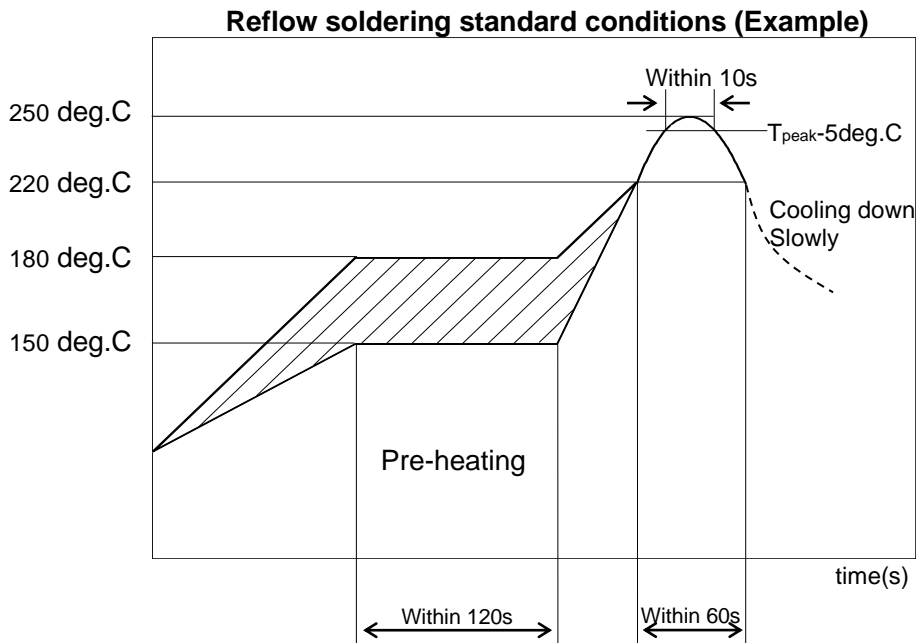

Please use the reflow within 2 times.

Use rosin type flux or weakly active flux with a chlorine content of 0.2 wt % or less.

16.6. Cleaning:

Since this Product is Moisture Sensitive, any cleaning is not recommended. If any cleaning process is done the customer is responsible for any issues or failures caused by the cleaning process.

16.7. Operational Environment Conditions:

Products are designed to work for electronic products under normal environmental conditions (ambient temperature, humidity and pressure). Therefore, products have no problems to be used under the similar conditions to the above-mentioned. However, if products are used under the following circumstances, it may damage products and leakage of electricity and abnormal temperature may occur.

- In an atmosphere containing corrosive gas (Cl₂, NH₃, SO_x, NO_x etc.).
- In an atmosphere containing combustible and volatile gases.
- Dusty place.
- Direct sunlight place.
- Water splashing place.
- Humid place where water condenses.
- Freezing place.

If there are possibilities for products to be used under the preceding clause, consult with Murata before actual use.

As it might be a cause of degradation or destruction to apply static electricity to products, do not apply static electricity or excessive voltage while assembling and measuring.

17. Preconditions to Use Our Products

PLEASE READ THIS NOTICE BEFORE USING OUR PRODUCTS.

Please make sure that your product has been evaluated and confirmed from the aspect of the fitness for the specifications of our product when our product is mounted to your product.

All the items and parameters in this product specification/datasheet/catalog have been prescribed on the premise that our product is used for the purpose, under the condition and in the environment specified in this specification. You are requested not to use our product deviating from the condition and the environment specified in this specification.

Please note that the only warranty that we provide regarding the products is its conformance to the specifications provided herein. Accordingly, we shall not be responsible for any defects in products or equipment incorporating such products, which are caused under the conditions other than those specified in this specification.

WE HEREBY DISCLAIMS ALL OTHER WARRANTIES REGARDING THE PRODUCTS, EXPRESS OR IMPLIED, INCLUDING WITHOUT LIMITATION ANY WARRANTY OF FITNESS FOR A PARTICULAR PURPOSE, THAT THEY ARE DEFECT-FREE, OR AGAINST INFRINGEMENT OF INTELLECTUAL PROPERTY RIGHTS.

You agree that you will use any and all software or program code (including but not limited to hcd, firmware, nvram, and blob) we may provide or to be embedded into our product ("Software") provided that you use the Software bundled with our product. YOU AGREE THAT THE SOFTWARE SHALL BE PROVIDED TO YOU "AS- IS" BASIS, MURATA MAKES NO REPRESENTATIONS OR WARRANTIES THAT THE SOFTWARE IS ERROR-FREE OR WILL OPERATE WITHOUT INTERRUPTION. AND MORE, MURATA MAKES NO REPRESENTATIONS OR WARRANTIES OF ANY KIND WHETHER EXPRESS OR IMPLIED WITH RESPECT TO THE SOFTWARE. MURATA EXPRESSLY DISCLAIM ANY AND ALL WARRANTIES OR CONDITIONS OF MERCHANTABILITY, FITNESS FOR A PARTICULAR PURPOSE NOR THE WARRANTY OF TITLE OR NON-INFRINGEMENT OF INTELLECTUAL PROPERTY RIGHTS.

You shall indemnify and hold harmless us, our affiliates and our licensor from and against any and all claims, costs, expenses and liabilities (including attorney's fees), which arise in connection with the using the Software.

The product shall not be used in any application listed below which requires especially high reliability for the prevention of such defect as may directly cause damage to the third party's life, body or property. You acknowledge and agree that, if you use our products in such applications, we will not be responsible for any failure to meet such requirements. Furthermore, YOU AGREE TO INDEMNIFY AND DEFEND US AND OUR AFFILIATES AGAINST ALL CLAIMS, DAMAGES, COSTS, AND EXPENSES THAT MAY BE INCURRED, INCLUDING WITHOUT LIMITATION, ATTORNEY FEES AND COSTS, DUE TO THE USE OF OUR PRODUCTS AND THE SOFTWARE IN SUCH APPLICATIONS.

- Aircraft equipment.
- Power plant control equipment
- Burning / explosion control equipment
- Transportation equipment (vehicles, trains, ships, elevator, etc.).
- Application of similar complexity and/ or reliability requirements to the applications listed in the above.
- Aerospace equipment
- Medical equipment.
- Disaster prevention / crime prevention equipment.
- Undersea equipment.
- Traffic signal equipment.

We expressly prohibit you from analyzing, breaking, reverse-engineering, remodeling altering, and reproducing our product. Our product cannot be used for the product which is prohibited from being manufactured, used, and sold by the regulations and laws in the world.

We do not warrant or represent that any license, either express or implied, is granted under any our patent right, copyright, mask work right, or our other intellectual property right relating to any combination, machine, or process in which our products or services are used. Information provided by us regarding third-party products or services does not constitute a license from us to use such products or services or a warranty or endorsement thereof. Use of such information may require a license from a third party under the patents or other intellectual property of the third party, or a license from us under our patents or other intellectual property.

Please do not use our products, our technical information and other data provided by us for the purpose of developing of mass-destruction weapons and the purpose of military use.

Moreover, you must comply with "foreign exchange and foreign trade law", the "U.S. export administration regulations", etc.

Please note that we may discontinue the manufacture of our products, due to reasons such as end of supply of materials and/or components from our suppliers.

By signing on specification sheet or approval sheet, you acknowledge that you are the legal representative for your company and that you understand and accept the validity of the contents herein. When you are not able to return the signed version of specification sheet or approval sheet within 30 days from receiving date of specification sheet or approval sheet, it shall be deemed to be your consent on the content of specification sheet or approval sheet. Customer acknowledges that engineering samples may deviate from specifications and may contain defects due to their development status. We reject any liability or product warranty for engineering samples. In particular we disclaim liability for damages caused by

- the use of the engineering sample other than for evaluation purposes, particularly the installation or integration in the product to be sold by you,
- deviation or lapse in function of engineering sample,
- improper use of engineering samples.

We disclaim any liability for consequential and incidental damages.

If you can't agree the above contents, you should inquire our sales.

APPENDIX

User Manual

FCC

Model Name: LBWA0ZZ2DS

FCC ID:VPYLBWA0ZZ2DS

Since this module is not sold to general end users directly, there is no user manual of module.

For the details about this module, please refer to the specification sheet of module.

This module should be installed in the host device according to the interface specification (installation procedure)

The OEM integrator has to be aware not to provide information to the end user regarding how to install or remove

this RF module in the end user's manual of the end product which integrates this module.

The end user manual shall include all required regulatory information/warning as shown in User manual.

This modular is a limited single modular as without its own power supply regulation, it can only be installed in the host device according to the interface specification (installation procedure).

- The following information must be indicated on the host device of this module.

Contains Transmitter Module FCC ID:VPYLBWA0ZZ2DS or Contains FCC ID: VPYLBWA0ZZ2DS

This device complies with part 15 of the FCC Rules. Operation is subject to the following two conditions: (1) This device may not cause harmful interference, and (2) this device must accept any interference received, including interference that may cause undesired operation.

*If it is difficult to describe this statement on the host product due to the size, please describe in the User's manual.

please describe in the user's manual and also either describe on the device packaging or on a removable label attached to the device.

- The following statements must be described on the user manual of the host device of this module;

FCC CAUTION

Changes or modifications not expressly approved by the party responsible for compliance could void the user's authority to operate the equipment.

This transmitter must not be co-located or operated in conjunction with any other antenna or transmitter.

When installing it in a mobile equipment.

This equipment complies with FCC radiation exposure limits set forth for an uncontrolled environment and meets the FCC radio frequency (RF) Exposure Guidelines. This equipment should be installed and operated keeping the radiator at least 20cm or more away from person's body.

When installing it in a portable equipment.

It is necessary to take a SAR test with your set mounting this module.

Class II permissive change application is necessary using the SAR report.

Please contact Murata.

Note)

Portable equipment: Equipment for which the spaces between human body and antenna are used within 20cm.

Mobile equipment: Equipment used at position in which the spaces between human body and antenna exceeded 20cm.

ISED (IC)

Model Name: LBWA0ZZ2DS

IC Number: 772C-LBWA0ZZ2DS

Since this module is not sold to general end users directly, there is no user manual of module.

For the details about this module, please refer to the specification sheet of module.

This module should be installed in the host device according to the interface specification (installation procedure).

The OEM integrator has to be aware not to provide information to the end user regarding how to install or remove

this RF module in the end user's manual of the end product which integrates this module.

The end user manual shall include all required regulatory information/warning as shown in User manual.

This modular is a limited single modular as without its own power supply regulation, it can only be installed in the host device according to the interface specification (installation procedure).

- The following information must be indicated on the host device of this module.

Contains IC: 772C-LBWA0ZZ2DS

- The following statements must be described on the user manual of the host device of this module;

This device complies with Industry Canada's applicable licence-exempt RSSs. Operation is subject to the following two conditions:

- (1) This device may not cause interference; and
- (2) This device must accept any interference, including interference that may cause undesired operation of the device.

Le présent appareil est conforme aux CNR d'Industrie Canada applicables aux appareils radio exempts de licence. L'exploitation est autorisée aux deux conditions suivantes :

- 1) l'appareil ne doit pas produire de brouillage;
- 2) l'utilisateur de l'appareil doit accepter tout brouillage radioélectrique subi, même si le brouillage est susceptible d'en compromettre le fonctionnement.

Data transmission is always initiated by software, which is the passed down through the MAC, through the digital and analog baseband, and finally to the RF chip. Several special packets are initiated by the MAC. These are the only ways the digital baseband portion will turn on the RF transmitter, which it then turns off at the end of the packet. Therefore, the transmitter will be on only while one of the aforementioned packets is being transmitted. In other words, this device automatically discontinues transmission in case of either absence of information to transmit or operational failure.

La transmission des données est toujours initiée par le logiciel, puis les données sont transmises par l'intermédiaire du MAC, par la bande de base numérique et analogique et, enfin, à la puce RF. Plusieurs paquets spéciaux sont initiés par le MAC. Ce sont les seuls moyens pour qu'une partie de la bande de base numérique active l'émetteur RF, puis désactive celui-ci à la fin du paquet. En conséquence, l'émetteur reste uniquement activé lors de la transmission d'un des paquets susmentionnés. En d'autres termes, ce dispositif interrompt automatiquement toute transmission en cas d'absence d'information à transmettre ou de défaillance.

- When installing it in a mobile equipment.

This equipment complies with IC radiation exposure limits set forth for an uncontrolled environment and meets RSS-102 of the IC radio frequency (RF) Exposure rules. This equipment should be installed and operated keeping the radiator at least 20cm or more away from person's body.

Cet équipement est conforme aux limites d'exposition aux rayonnements énoncées pour un environnement non contrôlé et respecte les règles d'exposition aux fréquences radioélectriques (RF) CNR-102 de l'IC. Cet équipement doit être installé et utilisé en gardant une distance de 20 cm ou plus entre le radiateur et le corps humain.

●When installing it in a portable equipment.

It is necessary to take a SAR test with your set mounting this module.

Class 4 permissive change application is necessary using the SAR report.

Please contact Murata.

Note)

Portable equipment: Equipment for which the spaces between human body and antenna are used within 20cm.

Mobile equipment: Equipment used at position in which the spaces between human body and antenna exceeded 20cm.

●RF Power
2.4GHz WLAN

mode	Rate	Channel	MAXIMUM TUNE UP TOLERANCE[dBm]
IEEE 802.11b	All Rate	1 - 11	19.5
IEEE 802.11g	6/9/12/18 Mbps	1, 11	14.5
		2 - 10	17.5
	24/36/48/54 Mbps	1, 11	14.5
		2 - 10	16.5
IEEE 802.11n(HT20)	MCS0/1/2/3/4	1, 11	13.5
		2 - 10	17.5
	MCS5/6/7	1, 11	13.5
		2 - 10	16.5

●Operation mode and frequency band

WLAN	STA	2.4GHz	11b/g/n	HT20	1ch-11ch
	AP	2.4GHz	11b/g/n	HT20	1ch-11ch

●Theory of Operation-Channel List

Frequency of operation			Scan	Ad-hoc mode
2.4GHz	11b/g/n (HT20)	2412-2462MHz	Active	Yes

●Antenna

■Please perform the antenna design that followed the specifications of the antenna.

■About the signal line between an antenna and a module

It is a 50-ohm line design.

Fine tuning of return loss etc. can be performed using a matching network.

However, it is required to check "Class1 change" and "Class2 change" which the authorities define then.

The concrete contents of a check are the following three points.

- 1)It is the same type as the antenna type of antenna specifications.
- 2)An antenna gain is lower than a gain given in antenna specifications.
- 3)The emission level is not getting worse.

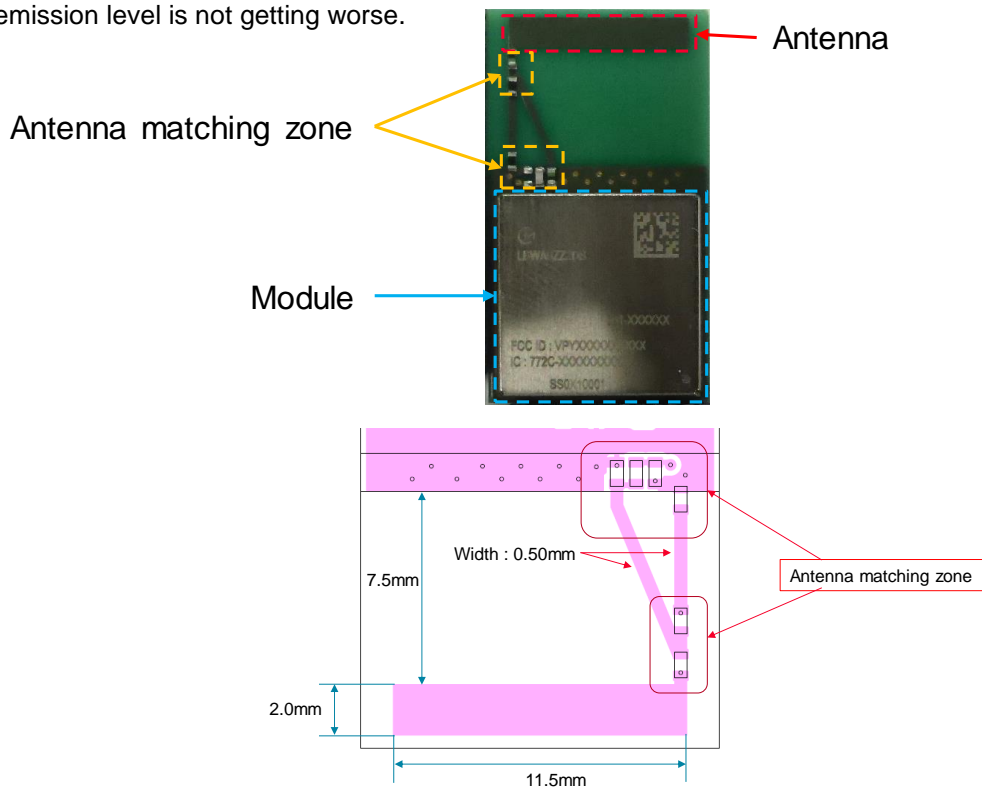

Japan

Application Model Name: LBWA0ZZ2DS
Certification Number: 001-P01579

- It is recommended to describe the following contents in the end product or user manual.
 - [This product has built-in specified radio equipment which received construction design certification (certification number: 001-P01579) based on the Certificate of Construction.]

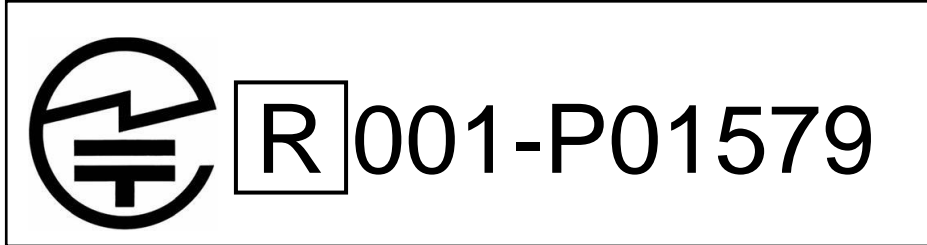

X-ON Electronics

Largest Supplier of Electrical and Electronic Components

Click to view similar products for [WiFi Modules - 802.11 category](#):

Click to view products by [Murata manufacturer](#):

Other Similar products are found below :

[KBPC10/15/2506WP](#) [ATWILC1000-MR110PA](#) [SX-PCEAN2C-SP](#) [849WM520100E](#) [7265.NGWG.SW](#) [HDG204-DN-3](#) [FXX-3061-MIX](#)
[PPC-WL-KIT02-R11](#) [450-0159R](#) [EAR00364](#) [AX210.NGWG.NV](#) [EWM-W190H02E](#) [ESP32-WROOM-32U-16MB](#) [1005869](#) [1012](#)
[QCA4004X-BL3B](#) [WLNN-AN-DP551](#) [WT51822-S4AT](#) [WT8266-S2](#) [DWM1000](#) [RN171XVS-I/RM](#) [ATWILC1000-MR110PB](#)
[ATWILC1000-MR110UB](#) [ATWILC3000-MR110CA](#) [ATWINC1500-MR210UB](#) [BP3595](#) [QCA4002X-AL3B](#) [QCA4002X-AL3A](#)
[QCA4004X-AL3B](#) [WT51822-S2](#) [SD-528](#) [ABDN-ER-DP553](#) [ENW-49A01C3EF](#) [LBEE5ZZ1CK-TEMP-DS-SD](#) [RS9113-NBZ-D5W](#)
[ATWILC1000-MR110PB-T](#) [ATWINC1500-MR210PB1952-T](#) [ATWINC1500-MR210UB1140](#) [ATWINC1500-MR210PB1954](#) [CleO35-WiFi1](#)
[SPWF04SC](#) [ENW-49C01AYKF](#) [EWM-W158F01E](#) [WGM110A1MV2](#) [ST60-2230C-PU](#) [2702534](#) [ESP-WROOM-02D \(2MB\)](#) [ESP-](#)
[WROOM-02U \(2MB\)](#) [ESP32-WROOM-32D \(4MB\)](#) [ESP32-WROOM-32U \(4MB\)](#)