

LDB212G4005C-001

In Production Recommended RoHS REACH

Appearance & Shape

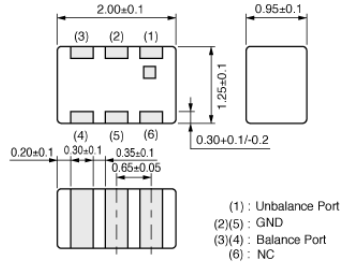

* Terminal of "NC" should be connected the floating land.
* All the technical data and information contained herein are subject to change without prior notice.
(in mm)

Features

Chip type SMD baluns constructed with copper conductor and ceramic material.
Ideal for high-frequency applications.
Small-size and low-loss baluns can be customized for the balance impedance of 50ohm to 200ohm.

1. Available in the 2300MHz to 2500MHz frequency range.
2. Impedance at balanced terminals is 50ohm.
3. Small, Low-profiled SMD.
4. Low loss.
5. Available in tape and reel packing for automatic mounting.

Packaging Information

Packaging	Specifications	Minimum Order Quantity
-	180mm Embossed Tape	4000

Attention

1. This datasheet is downloaded from the website of Murata Manufacturing Co., Ltd. Therefore, its specifications are subject to change or our products in it may be discontinued without advance notice. Please check with our sales representatives or product engineers before ordering.
2. This datasheet has only typical specifications because there is no space for detailed specifications.
Therefore, please review our product specifications or consult the approval sheet for product specifications before ordering.

LDB212G4005C-001



Specifications

Applications	WLAN BT
Center Frequency	2400.00MHz
Frequency Range	2300.00MHz to 2500.00MHz
Insertion Loss I)	0.80dB max. (at 25°C)
Insertion Loss II)	0.90dB max. (-40 to +85°C)
Unbalance Impedance (Nom.)	50Ω
Balance Impedance (Differential) (Nom.)	50Ω
Unbalance Port VSWR	2.00 max. (Balance Port:at 50ohm)
Power Capacity	0.5W
Operating Temperature Range	-40°C to 85°C
L x W (size)	2.00x1.25mm
Thickness(max.)	1.05mm

Attention

- 1.This datasheet is downloaded from the website of Murata Manufacturing Co., Ltd. Therefore, it's specifications are subject to change or our products in it may be discontinued without advance notice. Please check with our sales representatives or product engineers before ordering.
- 2.This datasheet has only typical specifications because there is no space for detailed specifications. Therefore, please review our product specifications or consult the approval sheet for product specifications before ordering.

LDB212G4005C-001

Product Data

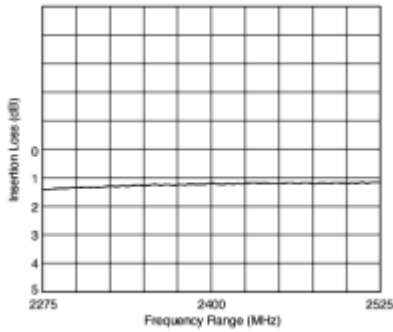

Insertion Loss Characteristics

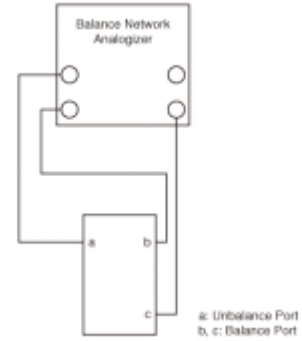

Measurement Circuit of Insertion Loss

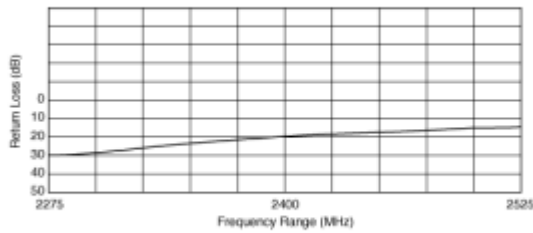

Characteristics of Unbalance Port VSWR

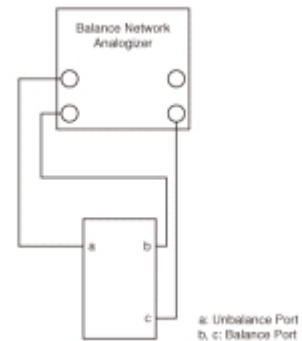

Measurement Circuit of Unbalance Port VSWR

Attention

1.This datasheet is downloaded from the website of Murata Manufacturing Co., Ltd. Therefore, it's specifications are subject to change or our products in it may be discontinued without advance notice. Please check with our sales representatives or product engineers before ordering.
2.This datasheet has only typical specifications because there is no space for detailed specifications.
Therefore, please review our product specifications or consult the approval sheet for product specifications before ordering.

X-ON Electronics

Largest Supplier of Electrical and Electronic Components

Click to view similar products for [Signal Conditioning](#) category:

Click to view products by [Murata](#) manufacturer:

Other Similar products are found below :

[MAPDCC0001](#) [MAPDCC0004](#) [PD0409J5050S2HF](#) [880157](#) [HHS-109-PIN](#) [DC1417J5005AHF](#) [AFS14A30-2185.00-T3](#) [AFS14A35-1591.50-T3](#) [DS-323-PIN](#) [B39321R801H210](#) [1A0220-3](#) [JP510S](#) [LFB212G45SG8C341](#) [LFB322G45SN1A504](#) [LFL182G45TC3B746](#) [SF2159E](#) [30057](#) [FM-104-PIN](#) [CER0813B](#) [MAPDCC0005](#) [3A325](#) [40287](#) [41180](#) [ATB3225-75032NCT](#) [BD0810N50100AHF](#) [BD2425J50200AHF](#) [C5060J5003AHF](#) [JHS-115-PIN](#) [JP503AS](#) [DC0710J5005AHF](#) [DC2327J5005AHF](#) [DC3338J5005AHF](#) [43020](#) [LFB2H2G60BB1C106](#) [LFL15869MTC1B787](#) [X3C19F1-20S](#) [XC3500P-20S](#) [10013-20](#) [SF2194E](#) [CDBLB455KCAX39-B0](#) [TGL2208-SM, EVAL](#) [RF1353C](#) [1E1305-3](#) [1F1304-3S](#) [1G1304-30](#) [B0922J7575AHF](#) [2020-6622-20](#) [TP-102-PIN](#) [TP-103-PIN](#) [BD1222J50200AHF](#)