

# LDB21942M20C-001

In Production Recommended RoHS REACH

## Appearance & Shape

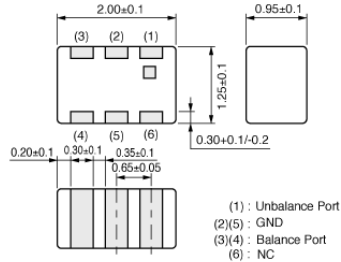

\* Terminal of "NC" should be connected the floating land.  
\* All the technical data and information contained herein are subject to change without prior notice.  
(in mm)

## Features

Chip type SMD baluns constructed with copper conductor and ceramic material.  
Ideal for high-frequency applications.  
Small-size and low-loss baluns can be customized for the balance impedance of 50ohm to 200ohm.

1. Available in the 925MHz to 960MHz frequency range.
2. Impedance at balanced terminals is 200ohm.
3. Small, Low-profiled SMD.
4. Low loss.
5. Available in tape and reel packing for automatic mounting.

## Packaging Information

Packaging	Specifications	Minimum Order Quantity
-	180mm Embossed Tape	4000

### Attention

1. This datasheet is downloaded from the website of Murata Manufacturing Co., Ltd. Therefore, its specifications are subject to change or our products in it may be discontinued without advance notice. Please check with our sales representatives or product engineers before ordering.
2. This datasheet has only typical specifications because there is no space for detailed specifications.  
Therefore, please review our product specifications or consult the approval sheet for product specifications before ordering.

# LDB21942M20C-001



## Specifications

Applications	GSM
Center Frequency	942.50MHz
Frequency Range	925.00MHz to 960.00MHz
Insertion Loss I)	1.30dB max. (at 25°C)
Insertion Loss II)	1.40dB max. (-40 to +85°C)
Unbalance Impedance (Nom.)	50Ω
Balance Impedance (Differential) (Nom.)	200Ω
Unbalance Port VSWR	2.00 max. (Balance Port:at 200ohm)
Power Capacity	0.5W
Operating Temperature Range	-40°C to 85°C
L x W (size)	2.00x1.25mm
Thickness(max.)	1.05mm

### Attention

- 1.This datasheet is downloaded from the website of Murata Manufacturing Co., Ltd. Therefore, it's specifications are subject to change or our products in it may be discontinued without advance notice. Please check with our sales representatives or product engineers before ordering.
- 2.This datasheet has only typical specifications because there is no space for detailed specifications.  
Therefore, please review our product specifications or consult the approval sheet for product specifications before ordering.

# LDB21942M20C-001

## Product Data

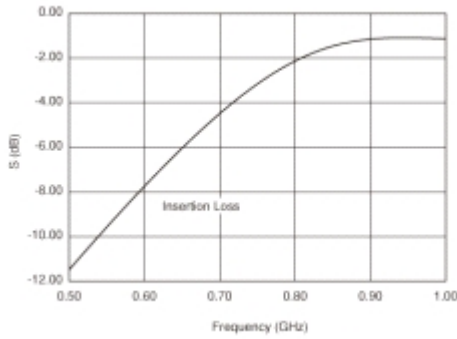

Insertion Loss Characteristics

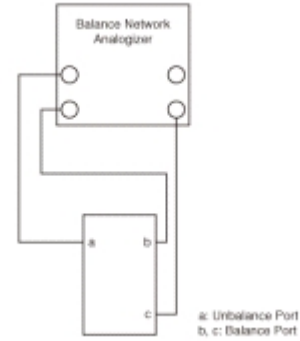

Measurement Circuit of Insertion Loss

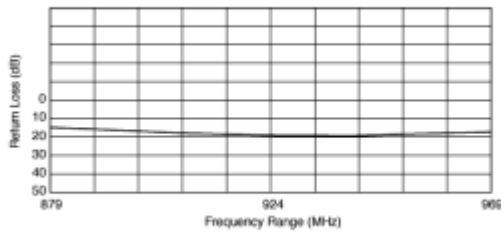

Characteristics of Unbalance Port VSWR

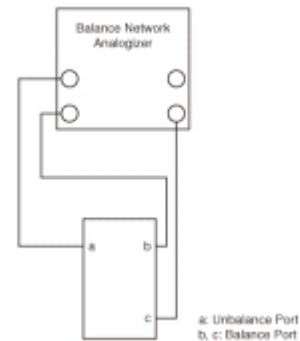

Measurement Circuit of Unbalance Port VSWR

**Attention**

1.This datasheet is downloaded from the website of Murata Manufacturing Co., Ltd. Therefore, it's specifications are subject to change or our products in it may be discontinued without advance notice. Please check with our sales representatives or product engineers before ordering.  
2.This datasheet has only typical specifications because there is no space for detailed specifications.  
Therefore, please review our product specifications or consult the approval sheet for product specifications before ordering.

## X-ON Electronics

Largest Supplier of Electrical and Electronic Components

*Click to view similar products for [Signal Conditioning](#) category:*

*Click to view products by [Murata](#) manufacturer:*

Other Similar products are found below :

[MAPDCC0001](#) [MAPDCC0004](#) [PD0409J5050S2HF](#) [880157](#) [HHS-109-PIN](#) [DC1417J5005AHF](#) [AFS14A30-2185.00-T3](#) [AFS14A35-1591.50-T3](#) [DS-323-PIN](#) [B39321R801H210](#) [1A0220-3](#) [JP510S](#) [LFB212G45SG8C341](#) [LFB322G45SN1A504](#) [LFL182G45TC3B746](#) [SF2159E](#) [30057](#) [FM-104-PIN](#) [CER0813B](#) [MAPDCC0005](#) [3A325](#) [40287](#) [41180](#) [ATB3225-75032NCT](#) [BD0810N50100AHF](#) [BD2425J50200AHF](#) [C5060J5003AHF](#) [JHS-115-PIN](#) [JP503AS](#) [DC0710J5005AHF](#) [DC2327J5005AHF](#) [DC3338J5005AHF](#) [43020](#) [LFB2H2G60BB1C106](#) [LFL15869MTC1B787](#) [X3C19F1-20S](#) [XC3500P-20S](#) [10013-20](#) [SF2194E](#) [CDBLB455KCAX39-B0](#) [TGL2208-SM, EVAL](#) [RF1353C](#) [1E1305-3](#) [1F1304-3S](#) [1G1304-30](#) [B0922J7575AHF](#) [2020-6622-20](#) [TP-102-PIN](#) [TP-103-PIN](#) [BD1222J50200AHF](#)