

Chip Multilayer Ceramic Capacitors for General



2018

Contents

Product specifications are as of September 2017.

| | | | |
|---|-----------------|-------------------|---------------|
| Explanation of Symbols in This Catalog | ··· p2 | Part Numbering | ·········· p5 |
| Selection Guide | ·········· p3 | Capacitance Table | ·········· p9 |
| Catalog information | ·········· p4 | | |
| Cap. Table | | | |
| <hr/> | | | |
| Chip Multilayer Ceramic Capacitors for General Purpose | | | |
| GRM Series | ·········· p40 | | p10 |
| GRM Series Specifications and Test Methods | ·········· p108 | | |
| <hr/> | | | |
| High Effective Capacitance & High Ripple Current Chip Multilayer Ceramic Capacitors for General Purpose | | | |
| GR3 Series | ·········· p109 | | p27 |
| GR3 Series Specifications and Test Methods (1) | ·········· p111 | | |
| GR3 Series Specifications and Test Methods (2) | ·········· p114 | | |
| GR3 Series Specifications and Test Methods (3) | ·········· p117 | | |
| <hr/> | | | |
| Soft Termination Chip Multilayer Ceramic Capacitors for General Purpose | | | |
| GRJ Series | ·········· p120 | | p28 |
| GRJ Series Specifications and Test Methods | ·········· p124 | | |
| <hr/> | | | |
| Chip Multilayer Ceramic Capacitors for Ethernet LAN and Primary-secondary Coupling of DC-DC Converters | | | |
| GR4 Series | ·········· p125 | | p30 |
| GR4 Series Specifications and Test Methods (1) | ·········· p127 | | |
| <hr/> | | | |
| Chip Multilayer Ceramic Capacitors for Camera Flash circuit only | | | |
| GR7 Series | ·········· p130 | | p30 |
| GR7 Series Specifications and Test Methods (1) | ·········· p132 | | |
| <hr/> | | | |
| High Q Chip Multilayer Ceramic Capacitors for General Purpose | | | |
| GJM Series | ·········· p135 | | p30 |
| GJM Series Specifications and Test Methods (1) | ·········· p157 | | |
| GJM Series Specifications and Test Methods (2) | ·········· p160 | | |
| <hr/> | | | |
| High Q and High Power Chip Multilayer Ceramic Capacitors for General Purpose | | | |
| GQM Series | ·········· p164 | | p31 |
| GQM Series Specifications and Test Methods (1) | ·········· p172 | | |
| GQM Series Specifications and Test Methods (2) | ·········· p175 | | |
| GQM Series Specifications and Test Methods (3) | ·········· p178 | | |
| GQM Series Specifications and Test Methods (4) | ·········· p181 | | |
| <hr/> | | | |
| Based on the Electrical Appliance and Material Safety Law of Japan Chip Multilayer Ceramic Capacitors for General Purpose | | | |
| GA2 Series | ·········· p184 | | p32 |
| GA2 Series Specifications and Test Methods (1) | ·········· p186 | | |
| <hr/> | | | |
| Safety Standard Certified Chip Multilayer Ceramic Capacitors for General Purpose / IEC60384-14 Class X2 | | | |
| GA3 Series Type GB | ·········· p189 | | p32 |
| GA3 Series Type GB Specifications and Test Methods (1) | ·········· p192 | | |
| <hr/> | | | |
| Safety Standard Certified Chip Multilayer Ceramic Capacitors for General Purpose / Acquired certifications of UL60950-1 | | | |
| GA3 Series Type GD | ·········· p196 | | p32 |
| GA3 Series Type GD Specifications and Test Methods (1) | ·········· p199 | | |
| GA3 Series Type GD Specifications and Test Methods (2) | ·········· p203 | | |
| <hr/> | | | |
| Safety Standard Certified Chip Multilayer Ceramic Capacitors for General Purpose / Acquired certifications of IEC60384-14 Class X1/Y2 and UL60950-1 | | | |
| GA3 Series Type GF | ·········· p207 | | p33 |
| GA3 Series Type GF Specifications and Test Methods (1) | ·········· p211 | | |
| GA3 Series Type GF Specifications and Test Methods (2) | ·········· p215 | | |
| <hr/> | | | |
| LW Reversed Low ESL Chip Multilayer Ceramic Capacitors for General Purpose | | | |
| LLL Series | ·········· p219 | | p34 |
| LLL Series Specifications and Test Methods | ·········· p221 | | |
| <hr/> | | | |

| | | Cap. Table |
|---|------|------------|
| 8 Terminals Low ESL Chip Multilayer Ceramic Capacitors for General Purpose | | |
| LLA Series | p222 | p34 |
| LLA Series Specifications and Test Methods (1) | p224 | |
| LLA Series Specifications and Test Methods (2) | p226 | |
| 10 Terminals Low ESL Chip Multilayer Ceramic Capacitors for General Purpose | | |
| LLM Series | p228 | p35 |
| LLM Series Specifications and Test Methods (1) | p230 | |
| LW Reversed Controlled ESR Low ESL Chip Multilayer Ceramic Capacitors for General Purpose | | |
| LLR Series | p232 | p35 |
| LLR Series Specifications and Test Methods (1) | p234 | |
| 3 Terminals Low ESL Chip Multilayer Ceramic Capacitors for General Purpose | | |
| NFM Series | p236 | p35 |
| NFM Series Specifications and Test Methods | p238 | |
| Metal Terminal Type Multilayer Ceramic Capacitors for General Purpose | | |
| KRM Series | p239 | p36 |
| KRM Series Specifications and Test Methods | p242 | |
| High Effective Capacitance & High Allowable Ripple Current Metal Terminal Type Multilayer Ceramic Capacitors for General Purpose | | |
| KR3 Series | p243 | p37 |
| KR3 Series Specifications and Test Methods (1) | p246 | |
| Wire Bonding Mount Multilayer Microchip Capacitors for General Purpose | | |
| GMA Series | p249 | p37 |
| GMA Series Specifications and Test Methods (1) | p252 | |
| GMA Series Specifications and Test Methods (2) | p254 | |
| Wire Bonding/AuSn Soldering Mount Chip Multilayer Ceramic Capacitors for General Purpose | | |
| GMD Series | p256 | p38 |
| GMD Series Specifications and Test Methods (1) | p259 | |
| GMD Series Specifications and Test Methods (2) | p261 | |
| GMD Series Specifications and Test Methods (3) | p263 | |
| ⚠Caution/Notice/Soldering and Mounting | p265 | |
| Introduction of Website SimSurfing | p291 | |
| Product Information | p292 | |

Please check the MURATA website (<https://www.murata.com/>) if you cannot find a part number in this catalog.

EU RoHS Compliant

- All the products in this catalog comply with EU RoHS.
- EU RoHS is "the European Directive 2011/65/EU on the Restriction of the Use of Certain Hazardous Substances in Electrical and Electronic Equipment."
- For more details, please refer to our web page, "Murata's Approach for EU RoHS" (<https://www.murata.com/en-eu/support/compliance/rohs>).

Qualified Standards

- The products listed here have been produced by ISO 9001 certified factory.
 <Plant>
 - Fukui Murata Mfg. Co., Ltd.
 - Izumo Murata Mfg. Co., Ltd.
 - Murata Electronics Singapore (Pte.) Ltd.
 - Wuxi Murata Electronics Co., Ltd.
 - PHILIPPINE MANUFACTURING CO. OF MURATA, INC.



Explanation of Symbols in This Catalog



Links are provided to the latest information from the PDF version of the catalog, which is available on the web.

| | |
|----------------------------|---|
| General | For applications that do not require the particular reliability such as the general equipment |
| Info-tainment | Infotainment for Automotive The product for entertainment equipment like car navigations, car audios, and body control equipment like wipers, power windows. |
| Powertrain | Powertrain/Safety for Automotive Product used for applications (running, turning, stopping and safety devices) which particularly concern human life, such as in devices for automobiles. |
| Medical Device | Medical-grade products for Implanted Medical Devices These products are intended for use in implanted medical devices such as cardiac pacemakers, cochlear implants, insulin pumps and gastric electrostimulators. They are suitable for use in non-critical circuits. *1 *1 Non-critical circuits This term refers to circuits in implanted medical devices that are not directly linked to life support, i.e. circuits that will not directly endanger the life of the patient should the functionality of the device be reduced or halted by failure of the circuit. |
| AEC-Q200 | AEC-Q200 compliant product |
| Safety standard | Safety Standard Certified Product Products that acquired safety standard certification IEC60384-14 and products based on the Electrical Appliance and Material Safety Law of Japan. |
| Japanese Safety Law | Based on the Electrical Appliance and Material Safety Law of Japan Products that are based on the electrical appliance and material safety law of Japan. |
| High Q | Low dissipation for high frequency By devising ceramic materials and electrode materials, low dissipation is achieved in frequency bands of VHF, UHF and microwave or beyond. |
| Low ESL | Low inductance This capacitor is designed so that the parasitic inductance component (ESL) that the capacitor has on the high frequency side becomes lower. |
| Fail safe | Fail safe product This capacitor is designed to prevent failures as much as possible by short mode. |
| Deflecting crack | Product resistant to deflection cracking This capacitor is designed to prevent failures as much as possible by short mode caused by cracking when there is board deflection. |
| Soldering crack | Product with solder cracking suppression "This capacitor is configured with metal terminals and leads connected to the chip. The metal terminals and leads relieve the stress from expansion and contraction of the solder, to suppress solder cracking." |
| Anti-noise | Product suitable for acoustic noise reduction and low distortion This product suppresses acoustic noise, which occurs when a ceramic capacitor is used, by devising the materials and configuration. |
| Effective Cap | No DC bias characteristics Polymer capacitor is no capacitance change with DC bias due to aluminum oxidized film for dielectric. |
| EMI FIL® | Low-inductance product suitable for noise suppression. This product has extremely low ESL and is suitable for suppression of noise, including high frequencies. This product can also be used as a low-ESL, high-performance bypass capacitor. |
| Bonding | Product for bonding Since gold is used for the external electrodes, the capacitor can be mounted by die bonding/wire bonding. |

Derating 1
 This product is suitable when a voltage continuously applied to a capacitor in an operating circuit, is used below (derated) the rated voltage of the capacitor. This model guarantees the test conditions in the endurance test, at a rated voltage x 100% at the maximum operating temperature. A reliability assurance level equivalent to a common product can be secured, by using this product within the voltage and temperature derated conditions recommended in the figure below.

D1
 Derating 1

Recommended Conditions of the Derating Operating Voltage and Temperature

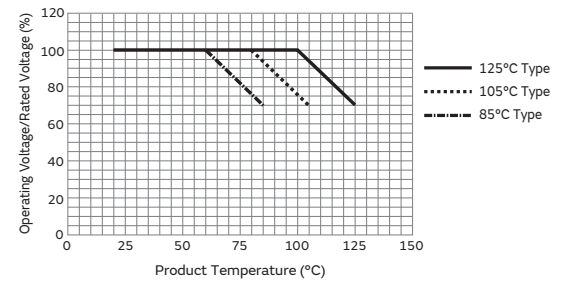

Derating 2
 When the product temperature exceeds 105°C, please use this product within the voltage and temperature derated conditions in the figure below.

D2
 Derating 2

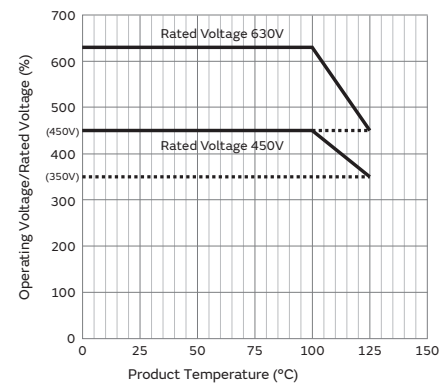

Derating 3
 Please apply the derating curve according to the operating temperature.
 Please refer to detailed specifications sheet for details.

D3
 Derating 3

Derating 4
 When the product temperature exceeds 125°C, please use this product within the voltage and temperature derated conditions in the figure below.

D4
 Derating 4

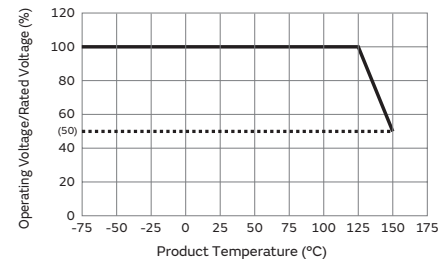

Derating 5
 Please apply the rated voltage derating over 150 °C.
 Please refer to detailed specifications sheet for details.

D5
 Derating 5

Selection Guide for Capacitors

For general

General SMD

Solder mounting

Chip type

| | | | | |
|--|------------|---|--|------|
| | GRM | | p40 | |
| | GRM | For LCD backlight inverter circuit only | | WEB |
| | GR3 | Anti-noise | High effective capacitance & high ripple current | p109 |
| | GRJ | Deflecting crack | Soft termination | p120 |
| | GXM | Water Repellent | | WEB |
| | GR4 | | For information devices only | p125 |
| | GR7 | | For camera flash circuit only | p130 |
| | GJM | High Q | | p135 |
| | GQM | High Q | High power | p164 |
| | GA2 | Japanese Safety Law | Based on the Electrical Appliance and Material Safety Law of Japan | p184 |
| | GA3 | Safety standard | | p189 |
| | LLL | Low ESL | LW reversed | p219 |
| | LLA | Low ESL | 8 terminals | p222 |
| | LLM | Low ESL | 10 terminals | p228 |
| | LLR | Low ESL | LW reversed controlled ESR | p232 |
| | NFM | Low ESL | 3 terminals | p236 |
| | GJ4 | Anti-noise | Low distortion | WEB |
| | GJ8 | Anti-noise | Low acoustic noise | WEB |

On interposer board

| | | | | |
|--|------------|------------|--|-----|
| | ZRA | Anti-noise | | WEB |
| | ZRB | Anti-noise | | WEB |

Metal terminal type

| | | | | | | |
|--|------------|------------|------------------|-----------------|--|------|
| | KRM | Anti-noise | Deflecting crack | Soldering crack | | p239 |
| | KR3 | Anti-noise | Deflecting crack | Soldering crack | High effective capacitance & high ripple current | p243 |

Resin molding SMD type

| | | | | |
|--|------------|-----------------|--|-----|
| | DK1 | Safety standard | | WEB |
|--|------------|-----------------|--|-----|

Wire bonding mounting

Chip type

| | | | | |
|--|------------|--|-----------|------|
| | GMA | | Microchip | p249 |
| | GMD | | | p256 |

Lead type

Solder mounting

| | | | | | | |
|--|------------|---------------------|--|-----------------|--|-----|
| | RDE | Anti-noise | Deflecting crack | Soldering crack | | WEB |
| | DEH | | High temperature low loss | | | WEB |
| | DEA | | High temperature Class 1 | | | WEB |
| | DEB | | Class 2 | | | WEB |
| | DEC | | | | | WEB |
| | DEF | | For LCD backlight inverter circuit only | | | WEB |
| | DHR | Ultra-high voltage | Deflecting crack | Soldering crack | | WEB |
| | DEJ | Japanese Safety Law | Based on the Electrical Appliance and Material Safety Law of Japan | | | WEB |
| | DE1 | Safety standard | X1/Y1 Class certified product | | | WEB |
| | DE2 | Safety standard | X1/Y2 Class certified product | | | WEB |

Screw termination mounting

| | | | | |
|--|------------|--------------------|-----------------------|-----|
| | DHS | Ultra-high voltage | | WEB |
| | DHK | Ultra-high voltage | High voltage AC rated | WEB |

Infotainment for automotive

SMD

Solder mounting

Chip type

| | | | | |
|--|------------|--|--|-----|
| | GRT | | | WEB |
|--|------------|--|--|-----|

Powertrain/Safety for automotive

SMD

Solder mounting

Chip type

| | | | | | | |
|--|------------|-----------------|--|------------------------------|-------------|-----|
| | GCM | | | WEB | | |
| | GC3 | Anti-noise | High effective capacitance & high ripple current | WEB | | |
| | GCJ | Fail safe | Deflecting crack | Soft termination | WEB | |
| | GGM | Water Repellent | | WEB | | |
| | GCQ | High Q | | WEB | | |
| | GCD | Fail safe | Deflecting crack | MLSC design | WEB | |
| | GCE | Fail safe | Deflecting crack | Soft termination MLSC design | WEB | |
| | GGD | Fail safe | Deflecting crack | Water Repellent | MLSC design | WEB |
| | NFM | Low ESL | | 3 terminals | WEB | |

Metal terminal type

| | | | | | | |
|--|------------|-----------------|------------------|------------------|--|-----|
| | KCM | Anti-noise | Deflecting crack | Soldering crack | | WEB |
| | KC3 | Anti-noise | Deflecting crack | Soldering crack | High effective capacitance & high ripple current | WEB |
| | KCA | Safety standard | Anti-noise | Deflecting crack | Soldering crack | WEB |

Limited to Conductive Glue Mounting

Chip type

| | | | | | |
|--|------------|------------------|-----------------|--|-----|
| | GCB | Deflecting crack | Soldering crack | Ni plating + Pd plating termination conductive glue mounting | WEB |
| | GCG | Deflecting crack | Soldering crack | AgPd termination conductive glue mounting | WEB |

Lead type

Solder mounting

| | | | | | | |
|--|------------|-----------------|------------------|-----------------|------------------------|-----|
| | RCE | Anti-noise | Deflecting crack | Soldering crack | | WEB |
| | RHE | Anti-noise | Deflecting crack | Soldering crack | 150°C operation leaded | WEB |
| | RHS | Anti-noise | Deflecting crack | Soldering crack | 200°C operation leaded | WEB |
| | DE6 | Safety standard | | | | WEB |

Medical-grade products for implanted medical devices

Medical Device SMD

Solder mounting

Chip type

| | | | | |
|--|------------|--|--|-----|
| | GCH | | | WEB |
|--|------------|--|--|-----|

Catalog Information

Catalog relates to a multilayer ceramic capacitor is below.

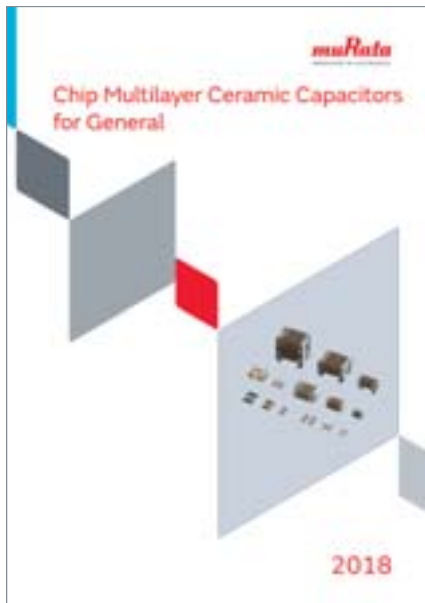

Chip Multilayer Ceramic Capacitors for General

Cat No. C02E-21

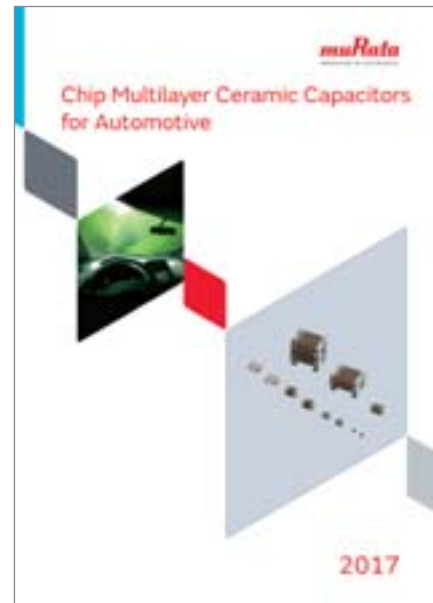

Chip Multilayer Ceramic Capacitors for Automotive

Cat No. C03E-9



Safety Certified Ceramic Capacitors/High Voltage Ceramic Capacitors

Cat No. C85E-5



Radial Lead Type Monolithic Ceramic Capacitors

Cat No. C49E-23

● Part Numbering

Chip Multilayer Ceramic Capacitors for General



(Part Number)

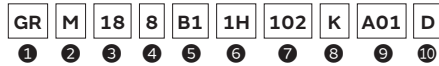

① Product ID ② Series

| Product ID | Code | Series |
|------------|------|--|
| GA | 2 | Based on the Electrical Appliance and Material Safety Law of Japan Chip Multilayer Ceramic Capacitors for General Purpose |
| | 3 | Safety Standard Certified Chip Multilayer Ceramic Capacitors for General Purpose |
| GJ | M | High Q Chip Multilayer Ceramic Capacitors for General Purpose |
| GM | A | Wire Bonding Mount Multilayer Microchip Capacitors for General Purpose |
| | D | Wire Bonding/AuSn Soldering Mount Chip Multilayer Ceramic Capacitors for General Purpose |
| GQ | M | High Q and High Power Chip Multilayer Ceramic Capacitors for General Purpose |
| GR | 3 | High Effective Capacitance & High Ripple Current Chip Multilayer Ceramic Capacitors for General Purpose |
| | 4 | Chip Multilayer Ceramic Capacitors for Camera Flash Circuit only |
| | 7 | Chip Multilayer Ceramic Capacitors for Ethernet LAN and Primary-secondary Coupling of DC-DC Converters |
| | J | Soft Termination Chip Multilayer Ceramic Capacitors for General Purpose |
| KR | M | Chip Multilayer Ceramic Capacitors for General Purpose |
| | 3 | High Effective Capacitance & High Allowable Ripple Current Metal Terminal Type Multilayer Ceramic Capacitors for General Purpose |
| LL | M | Metal Terminal Type Multilayer Ceramic Capacitors for General Purpose |
| | A | 8 Terminals Low ESL Chip Multilayer Ceramic Capacitors for General Purpose |
| | L | LW Reversed Low ESL Chip Multilayer Ceramic Capacitors for General Purpose |
| | M | 10 Terminals Low ESL Chip Multilayer Ceramic Capacitors for General Purpose |
| | R | LW Reversed Controlled ESR Low ESL Chip Multilayer Ceramic Capacitors for General Purpose |

③ Chip Dimensions (LxW)

| Code | Dimensions (LxW) | EIA |
|------|------------------|--------|
| 02 | 0.4x0.2mm | 01005 |
| 0D | 0.38x0.38mm | 015015 |
| 03 | 0.6x0.3mm | 0201 |
| 05 | 0.5x0.5mm | 0202 |
| 08 | 0.8x0.8mm | 0303 |
| 1U | 0.6x1.0mm | 02404 |
| 15 | 1.0x0.5mm | 0402 |
| 18 | 1.6x0.8mm | 0603 |
| 21 | 2.0x1.25mm | 0805 |
| 22 | 2.8x2.8mm | 1111 |
| 31 | 3.2x1.6mm | 1206 |
| 32 | 3.2x2.5mm | 1210 |
| 42 | 4.5x2.0mm | 1808 |
| 43 | 4.5x3.2mm | 1812 |
| 52 | 5.7x2.8mm | 2211 |
| 55 | 5.7x5.0mm | 2220 |

Continued on the following page. ↗

(Part Number)

| | | | | | | | | | |
|----|---|----|---|----|----|-----|---|-----|----|
| GR | M | 18 | 8 | B1 | 1H | 102 | K | A01 | D |
| 1 | 2 | 3 | 4 | 5 | 6 | 7 | 8 | 9 | 10 |

Continued from the preceding page. ↘

④ Height Dimension (T) (Except KR□)

| Code | Dimension (T) |
|------|----------------------------------|
| 2 | 0.2mm |
| 3 | 0.3mm |
| 4 | 0.4mm |
| 5 | 0.5mm |
| 6 | 0.6mm |
| 7 | 0.7mm |
| 8 | 0.8mm |
| 9 | 0.85mm |
| A | 1.0mm |
| B | 1.25mm |
| C | 1.6mm |
| D | 2.0mm |
| E | 2.5mm |
| M | 1.15mm |
| Q | 1.5mm |
| X | Depends on individual standards. |

④ Height Dimension (T) (KR□ Only)

| Code | Dimension (T) |
|------|---------------|
| E | 1.8mm |
| F | 1.9mm |
| K | 2.7mm |
| L | 2.8mm |
| Q | 3.7mm |
| T | 4.8mm |
| W | 6.4mm |

⑤ Temperature Characteristics

| Temperature Characteristic Codes | | | Temperature Characteristics | | | | Operating Temperature Range | Capacitance Change Each Temperature (%) | | | | | |
|----------------------------------|-----------------|-----------------------|-----------------------------|---|---------------------|--------------|-----------------------------|---|------|-------|------|-------|--|
| Code | Public STD Code | Reference Temperature | Temperature Range | Capacitance Change or Temperature Coefficient | -55°C | | | *6 | | -10°C | | | |
| | | | | | Max. | Min. | | Max. | Min. | Max. | Min. | | |
| 1X | SL | JIS | 20°C | 20 to 85°C | +350 to -1000ppm/°C | -55 to 125°C | - | - | - | - | - | - | |
| 2C | CH | JIS | 20°C | 20 to 125°C | 0±60ppm/°C | -55 to 125°C | 0.82 | -0.45 | 0.49 | -0.27 | 0.33 | -0.18 | |
| 3C | CJ | JIS | 20°C | 20 to 125°C | 0±120ppm/°C | -55 to 125°C | 1.37 | -0.9 | 0.82 | -0.54 | 0.55 | -0.36 | |
| 3U | UJ | JIS | 20°C | 20 to 85°C | -750±120ppm/°C | -25 to 85°C | - | - | 4.94 | 2.84 | 3.29 | 1.89 | |
| 4C | CK | JIS | 20°C | 20 to 125°C | 0±250ppm/°C | -55 to 125°C | 2.56 | -1.88 | 1.54 | -1.13 | 1.02 | -0.75 | |
| 5C | C0G | EIA | 25°C | 25 to 125°C | 0±30ppm/°C | -55 to 125°C | 0.58 | -0.24 | 0.4 | -0.17 | 0.25 | -0.11 | |
| 5G | X8G | *2 | 25°C | 25 to 150°C | 0±30ppm/°C | -55 to 150°C | 0.58 | -0.24 | 0.4 | -0.17 | 0.25 | -0.11 | |
| 7U | U2J | EIA | 25°C | 25 to 125°C *3 | -750±120ppm/°C | -55 to 125°C | 8.78 | 5.04 | 6.04 | 3.47 | 3.84 | 2.21 | |
| B1 | B *1 | JIS | 20°C | -25 to 85°C | ±10% | -25 to 85°C | - | - | - | - | - | - | |
| B3 | B | JIS | 20°C | -25 to 85°C | ±10% | -25 to 85°C | - | - | - | - | - | - | |
| C7 | X7S | EIA | 25°C | -55 to 125°C | ±22% | -55 to 125°C | - | - | - | - | - | - | |
| C8 | X6S | EIA | 25°C | -55 to 105°C | ±22% | -55 to 105°C | - | - | - | - | - | - | |
| D7 | X7T | EIA | 25°C | -55 to 125°C | +22%, -33% | -55 to 125°C | - | - | - | - | - | - | |
| D8 | X6T | EIA | 25°C | -55 to 105°C | +22%, -33% | -55 to 105°C | - | - | - | - | - | - | |
| E7 | X7U | EIA | 25°C | -55 to 125°C | +22%, -56% | -55 to 125°C | - | - | - | - | - | - | |
| R1 | R *1 | JIS | 20°C | -55 to 125°C | ±15% | -55 to 125°C | - | - | - | - | - | - | |
| R6 | X5R | EIA | 25°C | -55 to 85°C | ±15% | -55 to 85°C | - | - | - | - | - | - | |
| R7 | X7R | EIA | 25°C | -55 to 125°C | ±15% | -55 to 125°C | - | - | - | - | - | - | |
| W0 | X7T | EIA | 25°C | -55 to 125°C | ±10% *4 | -55 to 125°C | - | - | - | - | - | - | |
| | | | | | +22%, -33% *5 | | - | - | - | - | - | - | |

*1 Capacitance change is specified with 50% rated voltage applied.
 *2 Murata Temperature Characteristic Code.
 *3 Rated Voltage 100Vdc max: 25 to 85°C
 *4 Apply DC350V bias.
 *5 No DC bias.
 *6 -25°C (Reference Temperature 20°C) / -30°C (Reference Temperature 25°C)

Continued on the following page. ↗

(Part Number)

| | | | | | | | | | |
|----|---|----|---|----|----|-----|---|-----|----|
| GR | M | 18 | 8 | B1 | 1H | 102 | K | A01 | D |
| 1 | 2 | 3 | 4 | 5 | 6 | 7 | 8 | 9 | 10 |

Continued from the preceding page. ↘

⑥ Rated Voltage

| Code | Rated Voltage |
|------|---|
| OE | DC2.5V |
| OG | DC4V |
| OJ | DC6.3V |
| 1A | DC10V |
| 1C | DC16V |
| 1E | DC25V |
| 1H | DC50V |
| 1J | DC63V |
| 1K | DC80V |
| 2A | DC100V |
| 2D | DC200V |
| 2E | DC250V |
| 2W | DC450V |
| 2H | DC500V |
| 2J | DC630V |
| 3A | DC1kV |
| 3D | DC2kV |
| 3F | DC3.15kV |
| BB | DC350V |
| E2 | AC250V |
| GB | X2; AC250V (Safety Standard Certified Type GB) |
| GD | Y3; AC250V (Safety Standard Certified Type GD) |
| GF | Y2, X1/Y2; AC250V (Safety Standard Certified Type GF) |
| YA | DC35V |

⑦ Capacitance

Expressed by three-digit alphanumerics. The unit is picofarad (pF). The first and second figures are significant digits, and the third figure expresses the number of zeros which follow the two numbers. If there is a decimal point, it is expressed by the capital letter "R." In this case, all figures are significant digits. If any alphabet, other than "R", is included, this indicates the specific part number is a non-standard part.

Ex.)

| Code | Capacitance |
|------|-------------|
| R50 | 0.50pF |
| 1R0 | 1.0pF |
| 100 | 10pF |
| 103 | 10000pF |

⑧ Capacitance Tolerance

| Code | Capacitance Tolerance |
|------|--|
| B | ±0.1pF |
| C | ±0.25pF |
| D | ±0.5pF (Less than 10pF) ±0.5% (10pF and over) |
| F | ±1% |
| G | ±2% |
| J | ±5% |
| K | ±10% |
| M | ±20% |
| W | ±0.05pF |

⑨ Individual Specification Code (Except LLR)

Expressed by three figures.

⑨ ESR (LLR Only)

| Code | ESR |
|------|--------|
| E01 | 100mΩ |
| E03 | 220mΩ |
| E05 | 470mΩ |
| E07 | 1000mΩ |

⑩ Packaging

| Code | Packaging |
|-------|------------------------|
| L | ø180mm Embossed Taping |
| D/E/W | ø180mm Paper Taping |
| K | ø330mm Embossed Taping |
| J/F | ø330mm Paper Taping |
| T | Bulk Tray |

Please contact us if you find any part number not provided in this table.

3 Terminal Low ESL Multilayer Ceramic Capacitors

WEB 

(Part Number)

| | | | | | | | | |
|----|---|----|----|-----|---|----|---|---|
| NF | M | 3D | CC | 102 | R | 1H | 3 | L |
| 1 | 2 | 3 | 4 | 5 | 6 | 7 | 8 | 9 |

1 Product ID 2 Series

| Product ID | Series |
|------------|---|
| NFM | 3 Terminals Low ESL Chip Multilayer Ceramic Capacitors |

3 Dimensions (LxW)

| Code | Dimensions (LxW) | EIA |
|------|------------------|------|
| 15 | 1.0x0.5mm | 0402 |
| 18 | 1.6x0.8mm | 0603 |
| 21 | 2.0x1.25mm | 0805 |
| 3D | 3.2x1.25mm | 1205 |
| 31 | 3.2x1.6mm | 1206 |
| 41 | 4.5x1.6mm | 1806 |

4 Features

| Code | Features | |
|------|-------------|---|
| CC | For General | For Signal Lines |
| PC | | For Large Current |
| PS | | High Insertion Loss Type for Large Current |
| KC | | For Very Large Current |

5 Capacitance

Expressed by three figures. The unit is in pico-farad (pF). The first and second figures are significant digits, and the third figure expresses the number of zeros that follow the two figures.

6 Characteristics

| Code | Capacitance Temperature Characteristics |
|------|---|
| B | ±10%, ±12.5%, +10/-13% |
| C | ±22% |
| D | +22/-33% |
| F | +30/-80%, +30/-84% |
| R | ±15%, +15/-18% |

7 Rated Voltage

| Code | Rated Voltage |
|------|---------------|
| 0E | 2.5V |
| 0G | 4V |
| 0J | 6.3V |
| 1A | 10V |
| 1C | 16V |
| 1E | 25V |
| 1H | 50V |
| 2A | 100V |

8 Electrode

| Code | Electrode |
|------|------------|
| 3 | Sn Plating |

9 Packaging

| Code | Packaging |
|------|-------------------------------|
| B | Bulk |
| L | Embossed Taping (ø180mm Reel) |
| D | Paper Taping (ø180mm Reel) |

Capacitance Table

How to read the Capacitance Table

| | | | | | |
|---------------------|---------|------|------|------|------|
| L×W (mm) | 0.4×0.2 | | 0.6 | | |
| T max. (mm) | 0.22 | | 0. | | |
| Rated Voltage (Vdc) | 25 | | 50 | | |
| Cap. / TC Code | COG | CΔ | COG | CK | CJ |
| 0.10pF | | | | | |
| 0.20pF | p140 | p143 | p146 | p146 | |
| 1.0pF | p140 | p143 | | p146 | |
| 2.0pF | p140 | p143 | | p146 | |
| 3.0pF | p140 | p143 | | | p146 |

→ The values can be narrowed down in the order of size, rated voltage, and temperature characteristics.

→ Refers to the page of the part number list. Check the part number list for the applicable product number.

Temperature Characteristics Table

The Table is colored by temperature characteristic codes. Refer to the following Table for the meaning of each code.

| | | | | | | | | | |
|------------------------------------|-----|-----|-----|-----|-----|-----|-----|-----|-----|
| EIA: | COG | U2J | X7R | X7S | X7T | X7U | X6S | X6T | X5R |
| JIS: | CK | CJ | CH | SL | UJ | R | B | | |
| Murata Temperature Characteristic: | X8G | | | | | | | | |

| Temperature Characteristic Codes | | Temperature Characteristics | | | Operating Temperature Range | Capacitance Change Each Temperature (%) | | | | | |
|----------------------------------|-----|-----------------------------|-------------------|---|-----------------------------|---|-------|------|-------|-------|-------|
| | | Reference Temperature | Temperature Range | Capacitance Change or Temperature Coefficient | | -55°C | | *3 | | -10°C | |
| Public STD Code | | | | | | Max. | Min. | Max. | Min. | Max. | Min. |
| COG | EIA | 25°C | 25 to 125°C | 0±30ppm/°C | -55 to 125°C | 0.58 | -0.24 | 0.4 | -0.17 | 0.25 | -0.11 |
| CK | JIS | 20°C | 20 to 125°C | 0±250ppm/°C | -55 to 125°C | 2.56 | -1.88 | 1.54 | -1.13 | 1.02 | -0.75 |
| CJ | JIS | 20°C | 20 to 125°C | 0±120ppm/°C | -55 to 125°C | 1.37 | -0.9 | 0.82 | -0.54 | 0.55 | -0.36 |
| CH | JIS | 20°C | 20 to 125°C | 0±60ppm/°C | -55 to 125°C | 0.82 | -0.45 | 0.49 | -0.27 | 0.33 | -0.18 |
| SL | JIS | 20°C | 20 to 85°C | +350 to -1000ppm/°C | -55 to 125°C | - | - | - | - | - | - |
| U2J | EIA | 25°C | 25 to 125°C *2 | -750±120ppm/°C | -55 to 125°C | 8.78 | 5.04 | 6.04 | 3.47 | 3.84 | 2.21 |
| UJ | JIS | 20°C | 20 to 85°C | -750±120ppm/°C | -25 to 85°C | - | - | 4.94 | 2.84 | 3.29 | 1.89 |
| X8G | *1 | 25°C | 25 to 150°C | 0±30ppm/°C | -55 to 150°C | 0.58 | -0.24 | 0.4 | -0.17 | 0.25 | -0.11 |
| X7R | EIA | 25°C | -55 to 125°C | ±15% | -55 to 125°C | - | - | - | - | - | - |
| X7S | EIA | 25°C | -55 to 125°C | ±22% | -55 to 125°C | - | - | - | - | - | - |
| X7T | EIA | 25°C | -55 to 125°C | +22%, -33% | -55 to 125°C | - | - | - | - | - | - |
| X7U | EIA | 25°C | -55 to 125°C | +22%, -56% | -55 to 125°C | - | - | - | - | - | - |
| R | JIS | 20°C | -55 to 125°C | ±15% | -55 to 125°C | - | - | - | - | - | - |
| X6S | EIA | 25°C | -55 to 105°C | ±22% | -55 to 105°C | - | - | - | - | - | - |
| X6T | EIA | 25°C | -55 to 105°C | +22%, -33% | -55 to 105°C | - | - | - | - | - | - |
| X5R | EIA | 25°C | -55 to 85°C | ±15% | -55 to 85°C | - | - | - | - | - | - |
| B | JIS | 20°C | -25 to 85°C | ±10% | -25 to 85°C | - | - | - | - | - | - |

*1 Murata Temperature Characteristic Code.

*2 Rated Voltage 100Vdc max: 25 to 85°C

*3 -25°C (Reference Temperature 20°C) / -30°C (Reference Temperature 25°C)

Capacitance Table

GRM Series Temperature Compensating Type

p00 ← Part Number List JIS: **CK** **CJ** **CH** **SL** **UJ** EIA: **COG** **U2J**

| L·W (mm) | 0.4×0.2 | | | | | | 0.6×0.3 | | | | | | 1.0×0.5 | | | | | | 1.6×0.8 | | | | | | | | |
|---------------------|---------|-----|-----|-----|-----|-----|---------|-----|-----|-----|-----|----|---------|-----|-----|-----|-----|-----|---------|-----|-----|-----|-----|-----|-----|-----|----|
| | 0.22 | | | | | | 0.33 | | | | | | 0.55 | | | | | | 0.5 | | | | | | 0.9 | | |
| | 50 | | 25 | | 16 | | 100 | | 50 | | 25 | | 100 | | 50 | | 10 | | 50 | | 10 | | 100 | | | | |
| Rated Voltage (Vdc) | COG | CA | COG | CH | COG | CH | COG | CA | COG | CA | COG | CH | COG | CA | COG | CA | SL | U2J | UJ | SL | U2J | UJ | SL | U2J | UJ | COG | CA |
| 0.10pF | | | | | | | p48 | p51 | p55 | p58 | | | p62 | p65 | p69 | p72 | | | | | | | | | | | |
| 0.20pF | p41 | p44 | | | | | p48 | p51 | p55 | p58 | | | p62 | p65 | p69 | p72 | | | | | | | | | | | |
| 0.50pF | p41 | p44 | | | | | p48 | p51 | p55 | p58 | | | p62 | p65 | p69 | p72 | | | | | | | | | | | |
| 1.0pF | p41 | p44 | | | | | p48 | p51 | p55 | p58 | | | p62 | p65 | p69 | p72 | | | | | | | | | | | |
| 2.0pF | p41 | p44 | | | | | p48 | p52 | p55 | p58 | | | p62 | p66 | p69 | p73 | | | | | | | | | | | |
| 3.0pF | p41 | p45 | | | | | p48 | p52 | p55 | p59 | | | p63 | p66 | p69 | p73 | | | | | | | | | | | |
| 4.0pF | p42 | p45 | | | | | p49 | p52 | p56 | p59 | | | p63 | p66 | p70 | p73 | | | | | | | | | | | |
| 5.0pF | p42 | p45 | | | | | p49 | p52 | p56 | p59 | | | p63 | p66 | p70 | p73 | | | | | | | | | | | |
| 6.0pF | p42 | p46 | | | | | p49 | p53 | p56 | p60 | | | p63 | p67 | p70 | p74 | | | | | | | | | | | |
| 7.0pF | p43 | p46 | | | | | p50 | p53 | p57 | p60 | | | p64 | p67 | p71 | p74 | | | | | | | | | | | |
| 8.0pF | p43 | p46 | | | | | p50 | p53 | p57 | p60 | | | p64 | p68 | p71 | p74 | | | | | | | | | | | |
| 9.0pF | p43 | p47 | | | | | p50 | p54 | p57 | p61 | | | p65 | p68 | p71 | p75 | | | | | | | | | | | |
| 10pF | p44 | p47 | | | | | p51 | p54 | p58 | p61 | | | p65 | p68 | p72 | p75 | | | | | | | | | | | |
| 11pF | p44 | p47 | | | | | | | | | | | | | | | | | | | | | | | | | |
| 12pF | p44 | p47 | | | | | p51 | p54 | p58 | p61 | | | p65 | p68 | p72 | p75 | | | | | | | | | | | |
| 13pF | p44 | p47 | | | | | | | | | | | | | | | | | | | | | | | | | |
| 15pF | p44 | p47 | | | | | p51 | p54 | p58 | p61 | | | p65 | p68 | p72 | p75 | | | | | | | | | | | |
| 16pF | p44 | p47 | | | | | | | | | | | | | | | | | | | | | | | | | |
| 17pF | p44 | p47 | | | | | | | | | | | | | | | | | | | | | | | | | |
| 18pF | p44 | p47 | | | | | p51 | p54 | p58 | p61 | | | p65 | p68 | p72 | p75 | | | | | | | | | | | |
| 19pF | p44 | p47 | | | | | | | | | | | | | | | | | | | | | | | | | |
| 20pF | p44 | p47 | | | | | p51 | p54 | | | | | | | | | | | | | | | | | | | |
| 21pF | p44 | p47 | | | | | | | | | | | | | | | | | | | | | | | | | |
| 22pF | p44 | p47 | | | | | p51 | p54 | p58 | p61 | | | p65 | p68 | p72 | p75 | | | | | | | | | | | |
| 23pF | p44 | p47 | | | | | | | | | | | | | | | | | | | | | | | | | |
| 24pF | p44 | p47 | | | | | p51 | p54 | | | | | | | | | | | | | | | | | | | |
| 27pF | p44 | p47 | | | | | p51 | p54 | p58 | p61 | | | p65 | p68 | p72 | p75 | | | | | | | | | | | |
| 30pF | p44 | p47 | | | | | p51 | p54 | | | | | | | | | | | | | | | | | | | |
| 33pF | p44 | p47 | | | | | p51 | p54 | p58 | p61 | | | p65 | p68 | p72 | p75 | | | | | | | | | | | |
| 36pF | p44 | p47 | | | | | p51 | p54 | | | | | | | | | | | | | | | | | | | |
| 39pF | p44 | p47 | | | | | p51 | p54 | p58 | p61 | | | p65 | p68 | p72 | p75 | | | | | | | | | | | |
| 43pF | p44 | p47 | | | | | p51 | p54 | | | | | | | | | | | | | | | | | | | |
| 47pF | p44 | p47 | | | | | p51 | p54 | p58 | p61 | | | p65 | p68 | p72 | p75 | | | | | | | | | | | |
| 51pF | p44 | p47 | | | | | p51 | p54 | | | | | | | | | | | | | | | | | | | |
| 56pF | p44 | p47 | | | | | p51 | p54 | p58 | p61 | | | p65 | p68 | p72 | p75 | | | | | | | | | | | |
| 62pF | p44 | p47 | | | | | p51 | p55 | | | | | | | | | | | | | | | | | | | |
| 68pF | p44 | p47 | | | | | p51 | p55 | p58 | p61 | | | p65 | p68 | p72 | p75 | | | | | | | | | | | |
| 75pF | p44 | p47 | | | | | p51 | p55 | | | | | | | | | | | | | | | | | | | |
| 82pF | p44 | p47 | | | | | p51 | p55 | p58 | p61 | | | p65 | p68 | p72 | p75 | | | | | | | | | | | |
| 91pF | p44 | p47 | | | | | p51 | p55 | | | | | | | | | | | | | | | | | | | |
| 100pF | p44 | p47 | | | | | p51 | p55 | p58 | p61 | | | p65 | p69 | p72 | p75 | | | | | | | | | | | |
| 120pF | | | p47 | p47 | p47 | p47 | | | p58 | p61 | | | | | p72 | p75 | | | | | | | | | | | |
| 150pF | | | p47 | p47 | p47 | p48 | | | p58 | p61 | | | | | p72 | p75 | | | | | | | | | | | |
| 180pF | | | p47 | p47 | p47 | p48 | | | p58 | p61 | | | | | p72 | p75 | | | | | | | | | | | |
| 220pF | | | p47 | p47 | p47 | p48 | | | p58 | p61 | | | | | p72 | p76 | | | | | | | | | | | |
| 270pF | | | | | | | | | p61 | p62 | | | | | p72 | p76 | | | | | | | | | | | |
| 330pF | | | | | | | | | p61 | p62 | | | | | p72 | p76 | | | | | | | | | | | |
| 390pF | | | | | | | | | p62 | p62 | | | | | p72 | p76 | | | | | | | | | | | |
| 470pF | | | | | | | | | p62 | p62 | | | | | p72 | p76 | | | | | | | | | | | |
| 560pF | | | | | | | | | p62 | p62 | | | | | p72 | p76 | | | | | | | | | | | |
| 680pF | | | | | | | | | p62 | p62 | | | | | p72 | p76 | | | | | | | | | | | |
| 820pF | | | | | | | | | p62 | p62 | | | | | p72 | p76 | | | | | | | | | | | |
| 910pF | | | | | | | | | p62 | | | | | | | | | | | | | | | | | | |
| 1000pF | | | | | | | | | p62 | p62 | | | | | p72 | p76 | | | | | | | | | | | |
| 1200pF | | | | | | | | | | | | | | | | | p76 | p76 | p76 | | | | | | | | |
| 1500pF | | | | | | | | | | | | | | | | | p76 | p76 | p76 | | | | | | | | |
| 1800pF | | | | | | | | | | | | | | | | | p76 | p76 | p76 | | | | | | | | |
| 2200pF | | | | | | | | | | | | | | | | | p76 | p76 | p76 | p76 | p76 | p76 | | | | | |
| 2700pF | | | | | | | | | | | | | | | | | p76 | p76 | p76 | p76 | p76 | p76 | | | | | |
| 3300pF | | | | | | | | | | | | | | | | | p76 | p76 | p76 | p76 | p76 | p76 | | | | | |
| 3900pF | | | | | | | | | | | | | | | | | p76 | p76 | p76 | p76 | p76 | p76 | | | | | |
| 4700pF | | | | | | | | | | | | | | | | | p76 | p76 | p76 | p76 | p76 | p76 | | | | | |
| 5600pF | | | | | | | | | | | | | | | | | | | | | | | p76 | p76 | p76 | | |
| 6800pF | | | | | | | | | | | | | | | | | | | | | | | p76 | p76 | p76 | | |
| 8200pF | | | | | | | | | | | | | | | | | | | | | | | p76 | p76 | p76 | | |
| 10000pF | | | | | | | | | | | | | | | | | | | | | | | p76 | p76 | p76 | | |
| 12000pF | | | | | | | | | | | | | | | | | | | | | | | | | | | |
| 15000pF | | | | | | | | | | | | | | | | | | | | | | | | | | | |
| 18000pF | | | | | | | | | | | | | | | | | | | | | | | | | | | |
| 22000pF | | | | | | | | | | | | | | | | | | | | | | | | | | | |
| 27000pF | | | | | | | | | | | | | | | | | | | | | | | | | | | |
| 33000pF | | | | | | | | | | | | | | | | | | | | | | | | | | | |
| 39000pF | | | | | | | | | | | | | | | | | | | | | | | | | | | |
| 47000pF | | | | | | | | | | | | | | | | | | | | | | | | | | | |
| 56000pF | | | | | | | | | | | | | | | | | | | | | | | | | | | |
| 68000pF | | | | | | | | | | | | | | | | | | | | | | | | | | | |
| 82000pF | | | | | | | | | | | | | | | | | | | | | | | | | | | |
| 0.10μF | | | | | | | | | | | | | | | | | | | | | | | | | | | |
| 0.12μF | | | | | | | | | | | | | | | | | | | | | | | | | | | |

The indication for every 0.1 pF has been omitted for less than 10 pF. Refer to the Part Number List for details.

Capacitance Table

(→ GRM Series Temperature Compensating Type)

| p00 ← Part Number List | JIS: CK CJ CH SL UJ | | | EIA: COG U2J | | | | | | | | | | | | | | | | | | | | | | | | | |
|------------------------|---|-----|-----|--|-----|-----|----------|-----|-----|-----|-----|-----|------|-----|----|-----|----|----|-----|-----|-----|-----|----|-----|-----|-----|-----|-----|-----|
| | 1.6×0.8 | | | | | | 2.0×1.25 | | | | | | | | | | | | | | | | | | | | | | |
| | 0.9 | | | | | | 0.7 | | | | | | 0.95 | | | | | | 1.0 | | | | | | | | | | |
| L×W (mm) | 0.9 | | | | | | 0.7 | | | | | | 0.95 | | | | | | 1.0 | | | | | | | | | | |
| T max. (mm) | 0.9 | | | | | | 0.7 | | | | | | 0.95 | | | | | | 1.0 | | | | | | | | | | |
| Rated Voltage (Vdc) | 50 | | | 10 | | | 100 | | 50 | | | | 50 | | | 10 | | | 630 | 250 | 200 | | | | | | | | |
| Cap. / TC Code | COG | CA | SL | U2J | UJ | SL | U2J | UJ | COG | CH | COG | CH | SL | U2J | UJ | COG | CH | SL | U2J | UJ | SL | U2J | UJ | COG | COG | U2J | COG | | |
| 0.10pF | | | | | | | | | | | | | | | | | | | | | | | | | | | | | |
| 0.20pF | | | | | | | | | | | | | | | | | | | | | | | | | | | | | |
| 0.50pF | p83 | p86 | | | | | | | | | | | | | | | | | | | | | | | | | | | |
| 1.0pF | p83 | p86 | | | | | | | | | | | | | | | | | | | | | | | | | | | |
| 2.0pF | p83 | p87 | | | | | | | | | | | | | | | | | | | | | | | | | | | |
| 3.0pF | p83 | p87 | | | | | | | | | | | | | | | | | | | | | | | | | | | |
| 4.0pF | p84 | p87 | | | | | | | | | | | | | | | | | | | | | | | | | | | |
| 5.0pF | p84 | p87 | | | | | | | | | | | | | | | | | | | | | | | | | | | |
| 6.0pF | p84 | p88 | | | | | | | | | | | | | | | | | | | | | | | | | | | |
| 7.0pF | p85 | p88 | | | | | | | | | | | | | | | | | | | | | | | | | | | |
| 8.0pF | p85 | p88 | | | | | | | | | | | | | | | | | | | | | | | | | | | |
| 9.0pF | p85 | p89 | | | | | | | | | | | | | | | | | | | | | | | | | | | |
| 10pF | p86 | p89 | | | | | | | | | | | | | | | | | | | | | | | | p91 | p91 | | p91 |
| 11pF | | | | | | | | | | | | | | | | | | | | | | | | | | | | | |
| 12pF | p86 | p89 | | | | | | | | | | | | | | | | | | | | | | | | p91 | p91 | | p92 |
| 13pF | | | | | | | | | | | | | | | | | | | | | | | | | | | | | |
| 15pF | p86 | p89 | | | | | | | | | | | | | | | | | | | | | | | | p91 | p91 | | p92 |
| 16pF | | | | | | | | | | | | | | | | | | | | | | | | | | | | | |
| 17pF | | | | | | | | | | | | | | | | | | | | | | | | | | | | | |
| 18pF | p86 | p89 | | | | | | | | | | | | | | | | | | | | | | | | p91 | p91 | | p92 |
| 19pF | | | | | | | | | | | | | | | | | | | | | | | | | | | | | |
| 20pF | | | | | | | | | | | | | | | | | | | | | | | | | | | | | |
| 21pF | | | | | | | | | | | | | | | | | | | | | | | | | | | | | |
| 22pF | p86 | p89 | | | | | | | | | | | | | | | | | | | | | | | | p91 | p91 | | p92 |
| 23pF | | | | | | | | | | | | | | | | | | | | | | | | | | | | | |
| 24pF | | | | | | | | | | | | | | | | | | | | | | | | | | | | | |
| 27pF | p86 | p89 | | | | | | | | | | | | | | | | | | | | | | | | p91 | p91 | | p92 |
| 30pF | | | | | | | | | | | | | | | | | | | | | | | | | | | | | |
| 33pF | p86 | p89 | | | | | | | | | | | | | | | | | | | | | | | | p91 | p91 | | p92 |
| 36pF | | | | | | | | | | | | | | | | | | | | | | | | | | | | | |
| 39pF | p86 | p89 | | | | | | | | | | | | | | | | | | | | | | | | p91 | p91 | | p92 |
| 43pF | | | | | | | | | | | | | | | | | | | | | | | | | | | | | |
| 47pF | p86 | p89 | | | | | | | | | | | | | | | | | | | | | | | | p91 | p91 | | p92 |
| 51pF | | | | | | | | | | | | | | | | | | | | | | | | | | | | | |
| 56pF | p86 | p89 | | | | | | | | | | | | | | | | | | | | | | | | p91 | p91 | | p92 |
| 62pF | | | | | | | | | | | | | | | | | | | | | | | | | | | | | |
| 68pF | p86 | p89 | | | | | | | | | | | | | | | | | | | | | | | | p91 | p91 | | p92 |
| 75pF | | | | | | | | | | | | | | | | | | | | | | | | | | | | | |
| 82pF | p86 | p89 | | | | | | | | | | | | | | | | | | | | | | | | p91 | p91 | | p92 |
| 91pF | | | | | | | | | | | | | | | | | | | | | | | | | | | | | |
| 100pF | p86 | p89 | | | | | | | | p90 | p90 | | | | | | | | | | | | | | | p91 | p91 | p91 | p92 |
| 120pF | p86 | p89 | | | | | | | | p90 | p90 | | | | | | | | | | | | | | | p91 | p91 | p91 | p92 |
| 150pF | p86 | p89 | | | | | | | | p90 | p90 | p91 | p90 | | | | | | | | | | | | | p91 | p91 | p91 | p92 |
| 180pF | p86 | p89 | | | | | | | | p90 | p90 | p91 | p90 | | | | | | | | | | | | | p91 | p91 | p91 | p92 |
| 220pF | p86 | p89 | | | | | | | | p90 | p90 | p91 | p90 | | | | | | | | | | | | | p91 | p91 | p91 | p92 |
| 270pF | p86 | p89 | | | | | | | | p90 | p90 | p91 | p90 | | | | | | | | | | | | | p91 | p91 | p91 | p92 |
| 330pF | p86 | p89 | | | | | | | | p90 | p90 | p91 | p90 | | | | | | | | | | | | | p91 | p91 | p91 | p92 |
| 390pF | p86 | p89 | | | | | | | | p90 | p90 | | | | | | | | | | | | | | | p91 | p91 | p91 | |
| 470pF | p86 | p89 | | | | | | | | p90 | p90 | | | | | | | | | | | | | | | p91 | p91 | p91 | |
| 560pF | p86 | p89 | | | | | | | | p90 | p90 | | | | | | | | | | | | | | | p91 | p91 | p91 | |
| 680pF | p86 | p89 | | | | | | | | p90 | p90 | | | | | | | | | | | | | | | | p91 | p91 | |
| 820pF | p86 | p89 | | | | | | | | p90 | p90 | | | | | | | | | | | | | | | p91 | p91 | | |
| 910pF | | | | | | | | | | | | | | | | | | | | | | | | | | | | | |
| 1000pF | p86 | p89 | | | | | | | | p90 | p90 | | | | | | | | | | | | | | | p91 | p91 | | |
| 1200pF | p86 | p89 | p90 | p90 | p90 | | | | | p90 | p90 | p91 | p90 | | | | | | | | | | | | | p91 | p91 | | |
| 1500pF | p86 | p89 | p90 | p90 | p90 | | | | | p90 | p90 | p91 | p90 | | | | | | | | | | | | | p91 | p91 | | |
| 1800pF | p86 | p89 | p90 | p90 | p90 | | | | | p90 | p90 | p91 | p90 | | | | | | | | | | | | | p91 | p91 | | |
| 2200pF | p86 | p89 | p90 | p90 | p90 | | | | | p90 | p90 | p91 | p90 | | | | | | | | | | | | | p91 | p91 | | |
| 2700pF | p86 | p89 | p90 | p90 | p90 | | | | | p90 | p90 | p91 | p90 | | | | | | | | | | | | | p91 | p91 | | |
| 3300pF | p86 | p90 | p90 | p90 | p90 | | | | | p90 | p90 | p91 | p90 | | | | | | | | | | | | | | | | |
| 3900pF | p86 | p90 | p90 | p90 | p90 | | | | | | | p91 | p90 | | | | | | | | | | | | | | | | |
| 4700pF | p86 | p90 | p90 | p90 | p90 | | | | | | | p91 | p90 | | | | | | | | | | | | | | | | |
| 5600pF | p86 | p90 | p90 | p90 | p90 | | | | | | | | | | | | | | | | | | | | | p91 | p91 | | |
| 6800pF | p86 | p90 | p90 | p90 | p90 | | | | | | | | | | | | | | | | | | | | | p91 | p91 | | |
| 8200pF | p86 | p90 | p90 | p90 | p90 | | | | | | | | | | | | | | | | | | | | | p91 | p91 | | |
| 10000pF | p86 | p90 | p90 | p90 | p90 | | | | | | | | | | | | | | | | | | | | | | | | |
| 12000pF | | | | | | p90 | p90 | p90 | | | | | | | | | | | | | | | | | | p91 | p91 | p91 | p91 |
| 15000pF | | | | | | p90 | p90 | p90 | | | | | | | | | | | | | | | | | | p91 | p91 | p91 | p91 |
| 18000pF | | | | | | p90 | p90 | p90 | | | | | | | | | | | | | | | | | | p91 | p91 | p91 | p91 |
| 22000pF | | | | | | p90 | p90 | p90 | | | | | | | | | | | | | | | | | | | | | |
| 27000pF | | | | | | | | | | | | | | | | | | | | | | | | | | p91 | p91 | p91 | p91 |
| 33000pF | | | | | | | | | | | | | | | | | | | | | | | | | | | | | |
| 39000pF | | | | | | | | | | | | | | | | | | | | | | | | | | | | | |
| 47000pF | | | | | | | | | | | | | | | | | | | | | | | | | | | | | |
| 56000pF | | | | | | | | | | | | | | | | | | | | | | | | | | | | | |
| 68000pF | | | | | | | | | | | | | | | | | | | | | | | | | | | | | |
| 82000pF | | | | | | | | | | | | | | | | | | | | | | | | | | | | | |
| 0.10μF | | | | | | | | | | | | | | | | | | | | | | | | | | | | | |
| 0.12μF | | | | | | | | | | | | | | | | | | | | | | | | | | | | | |

Capacitance Table

(→ GRM Series Temperature Compensating Type)

| p00 ← Part Number List | JIS: CK CJ CH SL UJ | | | | | | | | | | | EIA: COG U2J | | | | | | | | | | | | | | | | | |
|------------------------|---|----|-----|----|------|----|----|-----|------|-----|-----|--|-----|-----|-----|-----|------|------|-----|----|----|----|-----|-----|-----|-----|-----|-----|-----|
| | L×W (mm) 2.0×1.25 | | | | | | | | | | | 3.2×1.6 | | | | | | | | | | | | | | | | | |
| | 1.0 | | | | 1.35 | | | | 1.45 | | | 0.95 | | | | | 1.0 | | | | | | | | | | | | |
| Rated Voltage (Vdc) | 200 | | 50 | | 50 | | 10 | | 630 | 250 | 200 | 100 | | 50 | | | 2000 | 1000 | 630 | | | | | | | | | | |
| Cap. / TC Code | U2J | SL | U2J | UJ | COG | CH | SL | U2J | UJ | SL | U2J | UJ | COG | COG | U2J | U2J | COG | CH | COG | CH | SL | UJ | U2J | U2J | COG | U2J | COG | U2J | COG |
| 0.10pF | | | | | | | | | | | | | | | | | | | | | | | | | | | | | |
| 0.20pF | | | | | | | | | | | | | | | | | | | | | | | | | | | | | |
| 0.50pF | | | | | | | | | | | | | | | | | | | | | | | | | | | | | |
| 1.0pF | | | | | | | | | | | | | | | | | | | | | | | | | | | | | |
| 2.0pF | | | | | | | | | | | | | | | | | | | | | | | | | | | | | |
| 3.0pF | | | | | | | | | | | | | | | | | | | | | | | | | | | | | |
| 4.0pF | | | | | | | | | | | | | | | | | | | | | | | | | | | | | |
| 5.0pF | | | | | | | | | | | | | | | | | | | | | | | | | | | | | |
| 6.0pF | | | | | | | | | | | | | | | | | | | | | | | | | | | | | |
| 7.0pF | | | | | | | | | | | | | | | | | | | | | | | | | | | | | |
| 8.0pF | | | | | | | | | | | | | | | | | | | | | | | | | | | | | |
| 9.0pF | | | | | | | | | | | | | | | | | | | | | | | | | | | | | |
| 10pF | | | | | | | | | | | | | | | | | | | | | | | | | | | | | |
| 11pF | | | | | | | | | | | | | | | | | | | | | | | | | | | | | |
| 12pF | | | | | | | | | | | | | | | | | | | | | | | | | | | | | |
| 13pF | | | | | | | | | | | | | | | | | | | | | | | | | | | | | |
| 15pF | | | | | | | | | | | | | | | | | | | | | | | | | | | | | |
| 16pF | | | | | | | | | | | | | | | | | | | | | | | | | | | | | |
| 17pF | | | | | | | | | | | | | | | | | | | | | | | | | | | | | |
| 18pF | | | | | | | | | | | | | | | | | | | | | | | | | | | | | |
| 19pF | | | | | | | | | | | | | | | | | | | | | | | | | | | | | |
| 20pF | | | | | | | | | | | | | | | | | | | | | | | | | | | | | |
| 21pF | | | | | | | | | | | | | | | | | | | | | | | | | | | | | |
| 22pF | | | | | | | | | | | | | | | | | | | | | | | | | | | | | |
| 23pF | | | | | | | | | | | | | | | | | | | | | | | | | | | | | |
| 24pF | | | | | | | | | | | | | | | | | | | | | | | | | | | | | |
| 27pF | | | | | | | | | | | | | | | | | | | | | | | | | | | | | |
| 30pF | | | | | | | | | | | | | | | | | | | | | | | | | | | | | |
| 33pF | | | | | | | | | | | | | | | | | | | | | | | | | | | | | |
| 36pF | | | | | | | | | | | | | | | | | | | | | | | | | | | | | |
| 39pF | | | | | | | | | | | | | | | | | | | | | | | | | | | | | |
| 43pF | | | | | | | | | | | | | | | | | | | | | | | | | | | | | |
| 47pF | | | | | | | | | | | | | | | | | | | | | | | | | | | | | |
| 51pF | | | | | | | | | | | | | | | | | | | | | | | | | | | | | |
| 56pF | | | | | | | | | | | | | | | | | | | | | | | | | | | | | |
| 62pF | | | | | | | | | | | | | | | | | | | | | | | | | | | | | |
| 68pF | | | | | | | | | | | | | | | | | | | | | | | | | | | | | |
| 75pF | | | | | | | | | | | | | | | | | | | | | | | | | | | | | |
| 82pF | | | | | | | | | | | | | | | | | | | | | | | | | | | | | |
| 91pF | | | | | | | | | | | | | | | | | | | | | | | | | | | | | |
| 100pF | p92 | | | | | | | | | | | | | | | | | | | | | | | | | | | | |
| 120pF | p92 | | | | | | | | | | | | | | | | | | | | | | | | | | | | |
| 150pF | p92 | | | | | | | | | | | | | | | | | | | | | | | | | | | | |
| 180pF | p92 | | | | | | | | | | | | | | | | | | | | | | | | | | | | |
| 220pF | p92 | | | | | | | | | | | | | | | | | | | | | | | | | | | | |
| 270pF | p92 | | | | | | | | | | | | | | | | | | | | | | | | | | | | |
| 330pF | p92 | | | | | | | | | | | | | | | | | | | | | | | | | | | | |
| 390pF | p92 | | | | | | | | | | | | | | | | | | | | | | | | | | | | |
| 470pF | p92 | | | | | | | | | | | | | | | | | | | | | | | | | | | | |
| 560pF | p92 | | | | | | | | | | | | | | | | | | | | | | | | | | | | |
| 680pF | p92 | | | | | | | | | | | | | | | | | | | | | | | | | | | | |
| 820pF | p92 | | | | | | | | | | | | | | | | | | | | | | | | | | | | |
| 910pF | | | | | | | | | | | | | | | | | | | | | | | | | | | | | |
| 1000pF | p92 | | | | | | | | | | | | | | | | | | | | | | | | | | | | |
| 1200pF | p92 | | | | | | | | | | | | | | | | | | | | | | | | | | | | |
| 1500pF | p92 | | | | | | | | | | | | | | | | | | | | | | | | | | | | |
| 1800pF | p92 | | | | | | | | | | | | | | | | | | | | | | | | | | | | |
| 2200pF | p92 | | | | | | | | | | | | | | | | | | | | | | | | | | | | |
| 2700pF | | | | | | | | | | | | | | | | | | | | | | | | | | | | | |
| 3300pF | | | | | | | | | | | | | | | | | | | | | | | | | | | | | |
| 3900pF | | | | | | | | | | | | | | | | | | | | | | | | | | | | | |
| 4700pF | | | | | | | | | | | | | | | | | | | | | | | | | | | | | |
| 5600pF | | | | | | | | | | | | | | | | | | | | | | | | | | | | | |
| 6800pF | | | | | | | | | | | | | | | | | | | | | | | | | | | | | |
| 8200pF | | | | | | | | | | | | | | | | | | | | | | | | | | | | | |
| 10000pF | | | | | | | | | | | | | | | | | | | | | | | | | | | | | |
| 12000pF | | | | | | | | | | | | | | | | | | | | | | | | | | | | | |
| 15000pF | | | | | | | | | | | | | | | | | | | | | | | | | | | | | |
| 18000pF | | | | | | | | | | | | | | | | | | | | | | | | | | | | | |
| 22000pF | | | | | | | | | | | | | | | | | | | | | | | | | | | | | |
| 27000pF | | | | | | | | | | | | | | | | | | | | | | | | | | | | | |
| 33000pF | | | | | | | | | | | | | | | | | | | | | | | | | | | | | |
| 39000pF | | | | | | | | | | | | | | | | | | | | | | | | | | | | | |
| 47000pF | | | | | | | | | | | | | | | | | | | | | | | | | | | | | |
| 56000pF | | | | | | | | | | | | | | | | | | | | | | | | | | | | | |
| 68000pF | | | | | | | | | | | | | | | | | | | | | | | | | | | | | |
| 82000pF | | | | | | | | | | | | | | | | | | | | | | | | | | | | | |
| 0.10μF | | | | | | | | | | | | | | | | | | | | | | | | | | | | | |
| 0.12μF | | | | | | | | | | | | | | | | | | | | | | | | | | | | | |

Continued on the following page. ↗

Capacitance Table

(→ GRM Series Temperature Compensating Type)

| p00 | ← Part Number List | | JIS: CK CJ CH SL UJ | | | | | EIA: C0G U2J | | | | |
|---------------------|--------------------|-----|---|-----|-----|---------|-----|--|------|-----|-----|--|
| L×W (mm) | 4.5×3.2 | | | | | 5.7×5.0 | | | | | | |
| T max. (mm) | 1.5 | | 2.0 | | | 1.5 | | | 2.0 | | | |
| Rated Voltage (Vdc) | 630 | 500 | 1000 | 630 | 500 | 1000 | 630 | 500 | 1000 | 630 | 500 | |
| Cap. / TC Code | U2J | U2J | U2J | U2J | U2J | U2J | U2J | U2J | U2J | U2J | U2J | |
| 0.10pF | | | | | | | | | | | | |
| 0.20pF | | | | | | | | | | | | |
| 0.50pF | | | | | | | | | | | | |
| 1.0pF | | | | | | | | | | | | |
| 2.0pF | | | | | | | | | | | | |
| 3.0pF | | | | | | | | | | | | |
| 4.0pF | | | | | | | | | | | | |
| 5.0pF | | | | | | | | | | | | |
| 6.0pF | | | | | | | | | | | | |
| 7.0pF | | | | | | | | | | | | |
| 8.0pF | | | | | | | | | | | | |
| 9.0pF | | | | | | | | | | | | |
| 10pF | | | | | | | | | | | | |
| 11pF | | | | | | | | | | | | |
| 12pF | | | | | | | | | | | | |
| 13pF | | | | | | | | | | | | |
| 15pF | | | | | | | | | | | | |
| 16pF | | | | | | | | | | | | |
| 17pF | | | | | | | | | | | | |
| 18pF | | | | | | | | | | | | |
| 19pF | | | | | | | | | | | | |
| 20pF | | | | | | | | | | | | |
| 21pF | | | | | | | | | | | | |
| 22pF | | | | | | | | | | | | |
| 23pF | | | | | | | | | | | | |
| 24pF | | | | | | | | | | | | |
| 27pF | | | | | | | | | | | | |
| 30pF | | | | | | | | | | | | |
| 33pF | | | | | | | | | | | | |
| 36pF | | | | | | | | | | | | |
| 39pF | | | | | | | | | | | | |
| 43pF | | | | | | | | | | | | |
| 47pF | | | | | | | | | | | | |
| 51pF | | | | | | | | | | | | |
| 56pF | | | | | | | | | | | | |
| 62pF | | | | | | | | | | | | |
| 68pF | | | | | | | | | | | | |
| 75pF | | | | | | | | | | | | |
| 82pF | | | | | | | | | | | | |
| 91pF | | | | | | | | | | | | |
| 100pF | | | | | | | | | | | | |
| 120pF | | | | | | | | | | | | |
| 150pF | | | | | | | | | | | | |
| 180pF | | | | | | | | | | | | |
| 220pF | | | | | | | | | | | | |
| 270pF | | | | | | | | | | | | |
| 330pF | | | | | | | | | | | | |
| 390pF | | | | | | | | | | | | |
| 470pF | | | | | | | | | | | | |
| 560pF | | | | | | | | | | | | |
| 680pF | | | | | | | | | | | | |
| 820pF | | | | | | | | | | | | |
| 910pF | | | | | | | | | | | | |
| 1000pF | | | | | | | | | | | | |
| 1200pF | | | | | | | | | | | | |
| 1500pF | | | | | | | | | | | | |
| 1800pF | | | | | | | | | | | | |
| 2200pF | | | | | | | | | | | | |
| 2700pF | | | | | | | | | | | | |
| 3300pF | | | | | | | | | | | | |
| 3900pF | | | | | | | | | | | | |
| 4700pF | | | | | | | | | | | | |
| 5600pF | | | | | | | | | | | | |
| 6800pF | | | | | | | | | | | | |
| 8200pF | | | | | | | | | | | | |
| 10000pF | | | | | | | | | | | | |
| 12000pF | | | | | | | | | | | | |
| 15000pF | | | | | | | | | | | | |
| 18000pF | | | | | | | | | | | | |
| 22000pF | | | | | | | | | | | | |
| 27000pF | | | | | | | | | | | | |
| 33000pF | | | | | | | | | | | | |
| 39000pF | | | | | | | | | | | | |
| 47000pF | | | | | | | | | | | | |
| 56000pF | | | | | | | | | | | | |
| 68000pF | | | | | | | | | | | | |
| 82000pF | | | | | | | | | | | | |
| 0.10μF | | | | | | | | | | | | |
| 0.12μF | | | | | | | | | | | | |

Capacitance Table

GRM Series High Dielectric Constant Type

p00 ← Part Number List JIS: R B EIA: X7R X7S X7T X7U X6S X6T X5R

| L×W (mm) | 0.4×0.2 | | | | | | 0.6×0.3 | | | | | | | | | | | | 1.0×0.5 | | | | | | | | | |
|---------------------|---------|-----|--------|--------|-----|-----|---------|-----|--------|-----|--------|-----|--------|--------|-----|--------|--------|--------|---------|-----|--------|-----|--------|-----|--------|------|------|------|
| T max. (mm) | 0.22 | | | | | | 0.33 | | | | | | | | | | | | 0.22 | | | | | | | | | |
| Rated Voltage (Vdc) | 16 | 10 | 6.3 | 4 | 2.5 | 50 | 35 | 25 | | | 16 | | | 10 | | | 6.3 | 4 | 10 | 6.3 | | | | | | | | |
| Cap. / TC Code | X7R | X7R | X5R, B | X5R, B | X6T | X5R | X6T | X7R | X5R, B | X5R | X7R, R | X6S | X5R, B | X7Δ, R | X6S | X5R, B | X7Δ, R | X5R, B | X7R, R | X6S | X5R, B | X6S | X5R, B | X6S | X5R, B | | | |
| 100pF | p97 | p97 | p97 | p97 | | | | p98 | p98 | | p98 | | | | | | | | | | | | | | | | | |
| 150pF | p97 | p97 | p97 | p97 | | | | p98 | p98 | | p98 | | | | | | | | | | | | | | | | | |
| 220pF | p97 | p97 | p97 | p97 | | | | p98 | p98 | | p98 | | | | | | | | | | | | | | | | | |
| 330pF | p97 | p97 | p97 | p97 | | | | p98 | p98 | | p98 | | | | | | | | | | | | | | | | | |
| 470pF | p97 | p97 | p97 | p97 | | | | p98 | p98 | | p98 | | | | | | | | | | | | | | | | | |
| 680pF | | p97 | p97 | p97 | | | | p98 | p98 | | p98 | | | | | | | | | | | | | | | | | |
| 820pF | | p97 | | | | | | | | | | | | | | | | | | | | | | | | | | |
| 1000pF | p97 | p97 | p97 | p97 | p97 | | | p98 | p98 | | p98 | p98 | | p98 | | | | | | | | | | | | | | |
| 1500pF | | | p97 | p97 | p97 | | | p98 | p98 | | p98 | p98 | | p98 | | | | | | | | | | | | | | |
| 2200pF | | | p97 | p97 | p97 | | | | | | p98 | | | | | | p99 | | | | | | | | | | | |
| 3300pF | | | p97 | p97 | p97 | | | | | | p98 | | | | | | p99 | | | | | | | | | | | |
| 4700pF | | | p97 | p97 | p97 | | | | | | p98 | | | | | | p99 | p99 | p99 | p99 | | | | p99 | | | | |
| 6800pF | | | p97 | p97 | p97 | | | | | | p98 | | | | | | p99 | p99 | p99 | p99 | | | | p99 | | | | |
| 10000pF | | | p97 | p97 | p97 | | | | | | p98 | | | | | | p99 | p99 | p99 | | | | | | | | | |
| 15000pF | | | | p97 | | p97 | | | | | | | | | | | p98 | p99 | | p99 | p99 | | p99 | p99 | | | | |
| 22000pF | | | | p97 | | p97 | | | | | | | | | | | p98 | p99 | | p99 | p99 | | p99 | p99 | | | | |
| 33000pF | | | | p97 | | p98 | | | | | | | | | | | p98 | p99 | | p99 | p99 | | p99 | p99 | | | | |
| 47000pF | | | | p97 | | p98 | | | | | | | | | | | p99 | p99 | | p99 | p99 | | | | | | | |
| 68000pF | | | | p97 | | p98 | | | | | | | | | | | p99 | p99 | | p99 | p99 | | | | | | | |
| 0.10μF | | | | p97 | p97 | p98 | p98 | | | p98 | | p98 | p98 | p98 | p98 | p99 | p99 | p99 | p99 | | | | | p99 | p100 | p100 | p100 | p100 |
| 0.15μF | | | | | | | | | | | | | | | | | | | | | | | | | | | | |
| 0.22μF | | | | | | | | | | | | | | | | | | | p99 | | | p99 | p99 | p99 | p100 | p100 | p100 | p100 |
| 0.33μF | | | | | | | | | | | | | | | | | | | | | | | | | | | | |
| 0.47μF | | | | | | | | | | | | | | | | | | | | | | | | | | | p100 | p100 |
| 0.68μF | | | | | | | | | | | | | | | | | | | | | | | | | | | | |
| 1.0μF | | | | | | | | | | | | | | | | | | | | | | | | | | | | p100 |
| 2.2μF | | | | | | | | | | | | | | | | | | | | | | | | | | | | |
| 4.7μF | | | | | | | | | | | | | | | | | | | | | | | | | | | | |
| 10μF | | | | | | | | | | | | | | | | | | | | | | | | | | | | |
| 22μF | | | | | | | | | | | | | | | | | | | | | | | | | | | | |
| 47μF | | | | | | | | | | | | | | | | | | | | | | | | | | | | |
| 100μF | | | | | | | | | | | | | | | | | | | | | | | | | | | | |
| 150μF | | | | | | | | | | | | | | | | | | | | | | | | | | | | |
| 220μF | | | | | | | | | | | | | | | | | | | | | | | | | | | | |

Continued on the following page. ↗

Capacitance Table

(→ GRM Series High Dielectric Constant Type)

p00 ← Part Number List JIS: R B EIA: X7R X7S X7T X7U X6S X6T X5R

| L×W (mm) | 1.0×0.5 | | | | | | | | | | | | | | | | | | | | | | | | | | |
|---------------------|---------|------|------|------|--------|------|------|------|------|------|------|--------|------|--------|------|------|--------|------|--------|------|------|--------|------|--------|--------|------|------|
| T max. (mm) | 0.22 | | | 0.3 | | | | 0.33 | | | | 0.55 | | | | | | | | | | | | | | | |
| Rated Voltage (Vdc) | 4 | | 2.5 | 50 | | 25 | | 16 | | 10 | 10 | | 6.3 | | 4 | 100 | | 50 | | 35 | | 25 | | 16 | | | |
| Cap. / TC Code | X7T | X6Δ | X5R | X7T | X7R, R | B | X7R | B | X7R | B | X5R | X5R, B | X6T | X5R, B | X6T | X7R | X7R, R | X6S | X5R, B | X6S | X5R | X7R, R | X6S | X5R, B | X7R, R | | |
| 100pF | | | | | | | | | | | | | | | | | | | | | | | | | | | |
| 150pF | | | | | | | | | | | | | | | | | | | | | | | | | | | |
| 220pF | | | | | p100 | p100 | p100 | | | | | | | | | p100 | p101 | p100 | | p101 | | | | | | | |
| 330pF | | | | | p100 | p100 | p100 | | | | | | | | | p100 | p101 | p100 | | p101 | | | | | | | |
| 470pF | | | | | p100 | p100 | p100 | | | | | | | | | p100 | p101 | p100 | | p101 | | | | | | | |
| 680pF | | | | | p100 | p100 | p100 | | | | | | | | | p100 | p101 | p100 | | p101 | | | | | | | |
| 820pF | | | | | | | | | | | | | | | | | | | | | | | | | | | |
| 1000pF | | | | | p100 | p100 | p100 | | | | | | | | | p100 | p101 | p100 | | p101 | | | | | | | |
| 1500pF | | | | | p100 | p100 | p100 | | | | | | | | | p100 | p101 | p100 | | p101 | | | | | | | |
| 2200pF | | | | | | | p100 | p100 | | | | | | | | p100 | p101 | p100 | | p101 | | | p101 | | | p101 | |
| 3300pF | | | | | | | | | p100 | p100 | | | | | | p100 | p101 | p101 | | p101 | | | | | | | |
| 4700pF | | | | | | | | | p100 | p100 | | | | | | p100 | p101 | p101 | | p101 | | | | | | | p102 |
| 6800pF | | | | | | | | | p100 | p100 | | | | | | | p101 | p101 | | p101 | | | p101 | | | | |
| 10000pF | | | | | | | | | p100 | p100 | | | | | | | p101 | p101 | | p101 | | | p101 | p101 | | p101 | p102 |
| 15000pF | | | | | | | | | | | p100 | | | | | | p101 | | | p101 | | | p101 | p101 | | p101 | |
| 22000pF | | | | | | | | | | | p100 | | | | | | p101 | | | p101 | | | p101 | p101 | | p101 | |
| 33000pF | | | | | | | | | | | p100 | | | | | | p101 | p101 | | p101 | | | p101 | p101 | | p101 | |
| 47000pF | | | | | | | | | | | | | | | | | p101 | p101 | | p101 | | | p101 | p101 | | p102 | |
| 68000pF | | | | | | | | | | | | | | | | | p101 | p101 | | p101 | | | p101 | p101 | p101 | p102 | p102 |
| 0.10μF | p100 | p100 | | p100 | | | | | | | | | | | | p101 | | | p101 | | | p101 | | p101 | p102 | | |
| 0.15μF | | | | | | | | | | | | | | | | | | | | | | | | | | | p102 |
| 0.22μF | p100 | p100 | | p100 | | | | | | | | | | | | | | | | p101 | p101 | | p101 | p101 | | p101 | p102 |
| 0.33μF | | | | | | | | | | | | | | | | | | | | | | | | | | | |
| 0.47μF | | p100 | | | | | | | | | | | | | | | | | | | p101 | | | | | p101 | |
| 0.68μF | | | | | | | | | | | | | | | | | | | | | | | | | | | |
| 1.0μF | | p100 | p100 | | | | | | | | | p100 | p100 | p100 | p100 | | | | p101 | | | | | | p101 | p102 | |
| 2.2μF | | | | | | | | | | | | | | | | | | | | | | | | | | | |
| 4.7μF | | | | | | | | | | | | | | | | | | | | | | | | | | | |
| 10μF | | | | | | | | | | | | | | | | | | | | | | | | | | | |
| 22μF | | | | | | | | | | | | | | | | | | | | | | | | | | | |
| 47μF | | | | | | | | | | | | | | | | | | | | | | | | | | | |
| 100μF | | | | | | | | | | | | | | | | | | | | | | | | | | | |
| 150μF | | | | | | | | | | | | | | | | | | | | | | | | | | | |
| 220μF | | | | | | | | | | | | | | | | | | | | | | | | | | | |

Continued on the following page. ↗

Capacitance Table

(→ GRM Series High Dielectric Constant Type)

p00 ← Part Number List JIS: R B EIA: X7R X7S X7T X7U X6S X6T X5R

| L×W (mm) | 1.0×0.5 | | | | | | | | | | | | | | | | | | | | | | | | |
|---------------------|---------|--------|------|-----|--------|------|------|--------|------|------|------|-----|-----|-----|--------|--------|------|-----|-----|-----|-----|-----|-----|-----|--|
| T max. (mm) | 0.55 | | | | | | | | | | 0.6 | | | | | | 0.65 | | | | 0.7 | | | | |
| Rated Voltage (Vdc) | 16 | | 10 | | 6.3 | | 4 | | 50 | | 35 | 25 | 16 | 6.3 | 4 | 2.5 | 25 | 16 | 10 | 6.3 | 25 | | | | |
| Cap. / TC Code | X6S | X5R, B | X7R | X6S | X5R, B | X7R | X6S | X5R, B | X7R | X6S | X5R | X5R | X6S | X6S | X5R, B | X5R, B | X6T | X6T | X7T | X6T | X7T | X5R | X6S | X5R | |
| 100pF | | | | | | | | | | | | | | | | | | | | | | | | | |
| 150pF | | | | | | | | | | | | | | | | | | | | | | | | | |
| 220pF | | | | | | | | | | | | | | | | | | | | | | | | | |
| 330pF | | | | | | | | | | | | | | | | | | | | | | | | | |
| 470pF | | | | | | | | | | | | | | | | | | | | | | | | | |
| 680pF | | | | | | | | | | | | | | | | | | | | | | | | | |
| 820pF | | | | | | | | | | | | | | | | | | | | | | | | | |
| 1000pF | | | | | | | | | | | | | | | | | | | | | | | | | |
| 1500pF | | | | | | | | | | | | | | | | | | | | | | | | | |
| 2200pF | | | | | | | | | | | | | | | | | | | | | | | | | |
| 3300pF | | | | | | | | | | | | | | | | | | | | | | | | | |
| 4700pF | | | | | | | | | | | | | | | | | | | | | | | | | |
| 6800pF | | | | | | | | | | | | | | | | | | | | | | | | | |
| 10000pF | | p102 | | | | | | | | | | | | | | | | | | | | | | | |
| 15000pF | | | | | | | | | | | | | | | | | | | | | | | | | |
| 22000pF | | | | | | | | | | | | | | | | | | | | | | | | | |
| 33000pF | | | | | p102 | | | | | | | | | | | | | | | | | | | | |
| 47000pF | | | | | | | | | | | | | | | | | | | | | | | | | |
| 68000pF | | | | | | | | | | | | | | | | | | | | | | | | | |
| 0.10μF | | | | | p102 | | | | | p102 | | | | | | | | | | | | | | | |
| 0.15μF | | | | | p102 | p102 | | | | p102 | p102 | | | | | | | | | | | | | | |
| 0.22μF | | p102 | p102 | | p102 | p102 | | | p102 | p102 | p102 | | | | | | | | | | | | | | |
| 0.33μF | | | | | p102 | p102 | | | | p102 | p102 | | | | | | | | | | | | | | |
| 0.47μF | p102 | | | | p102 | p102 | | | | p102 | p102 | | | | | | | | | | | | | | |
| 0.68μF | | | | | p102 | p102 | | | | p102 | p102 | | | | | | | | | | | | | | |
| 1.0μF | | p102 | p102 | | p102 | p102 | p102 | | | p102 | p102 | | | | | | | | | | | | | | |
| 2.2μF | | | | | p102 | | | | | p102 | p102 | | | | | | | | | | | | | | |
| 4.7μF | | | | | | | | | | | | | | | | | | | | | | | | | |
| 10μF | | | | | | | | | | | | | | | | | | | | | | | | | |
| 22μF | | | | | | | | | | | | | | | | | | | | | | | | | |
| 47μF | | | | | | | | | | | | | | | | | | | | | | | | | |
| 100μF | | | | | | | | | | | | | | | | | | | | | | | | | |
| 150μF | | | | | | | | | | | | | | | | | | | | | | | | | |
| 220μF | | | | | | | | | | | | | | | | | | | | | | | | | |

Continued on the following page. ↗

Capacitance Table

(→ GRM Series High Dielectric Constant Type)

| L×W (mm) | 1.0×0.5 | | | | | | | | | | 1.6×0.8 | | | | | | | | | | | | | |
|---------------------|---------|-----|-----|-----|-----|-----|-----|--------|--------|-----|---------|-----|-----|-----|-----|-----|-----|-----|--------|-----|--------|-----|-----|-----|
| | 0.7 | | | | | 0.5 | | | | | 0.55 | | | | 0.9 | | | | | | | | | |
| T max. (mm) | 0.7 | | | | | 0.5 | | | | | 0.55 | | | | 0.9 | | | | | | | | | |
| Rated Voltage (Vdc) | 16 | 10 | 6.3 | 4 | 2.5 | 25 | 16 | 6.3 | 4 | 16 | 10 | 6.3 | 250 | 200 | 25 | 16 | 10 | 6.3 | | | | | | |
| Cap. / TC Code | X6S | X5R | X7S | X6S | X7S | X5R | X5R | X5R, B | X5R, B | X5R | X5R | X6S | X5R | X7T | X6S | X7R | X7R | X7R | X5R, B | X6S | X5R, B | X7R | X5R | X6S |
| 100pF | | | | | | | | | | | | | | | | | | | | | | | | |
| 150pF | | | | | | | | | | | | | | | | | | | | | | | | |
| 220pF | | | | | | | | | | | | | | | | | | | | | | | | |
| 330pF | | | | | | | | | | | | | | | | | | | | | | | | |
| 470pF | | | | | | | | | | | | | | | | | | | | | | | | |
| 680pF | | | | | | | | | | | | | | | | | | | | | | | | |
| 820pF | | | | | | | | | | | | | | | | | | | | | | | | |
| 1000pF | | | | | | | | | | | | | | | | | | | | | | | | |
| 1500pF | | | | | | | | | | | | | | | | | | | | | | | | |
| 2200pF | | | | | | | | | | | | | | | | | | | | | | | | |
| 3300pF | | | | | | | | | | | | | | | | | | | | | | | | |
| 4700pF | | | | | | | | | | | | | | | | | | | | | | | | |
| 6800pF | | | | | | | | | | | | | | | | | | | | | | | | |
| 10000pF | | | | | | | | | | | | | | | | | | | | | | | | |
| 15000pF | | | | | | | | | | | | | | | | | | | | | | | | |
| 22000pF | | | | | | | | | | | | | | | | | | | | | | | | |
| 33000pF | | | | | | | | | | | | | | | | | | | | | | | | |
| 47000pF | | | | | | | | | | | | | | | | | | | | | | | | |
| 68000pF | | | | | | | | | | | | | | | | | | | | | | | | |
| 0.10μF | | | | | | | | | | | | | | | | | | | | | | | | |
| 0.15μF | | | | | | | | | | | | | | | | | | | | | | | | |
| 0.22μF | | | | | | | | | | | | | | | | | | | | | | | | |
| 0.33μF | | | | | | | | | | | | | | | | | | | | | | | | |
| 0.47μF | | | | | | | | | | | | | | | | | | | | | | | | |
| 0.68μF | | | | | | | | | | | | | | | | | | | | | | | | |
| 1.0μF | | | | | | | | | | | | | | | | | | | | | | | | |
| 2.2μF | | | | | | | | | | | | | | | | | | | | | | | | |
| 4.7μF | | | | | | | | | | | | | | | | | | | | | | | | |
| 10μF | | | | | | | | | | | | | | | | | | | | | | | | |
| 22μF | | | | | | | | | | | | | | | | | | | | | | | | |
| 47μF | | | | | | | | | | | | | | | | | | | | | | | | |
| 100μF | | | | | | | | | | | | | | | | | | | | | | | | |
| 150μF | | | | | | | | | | | | | | | | | | | | | | | | |
| 220μF | | | | | | | | | | | | | | | | | | | | | | | | |

Continued on the following page. ↗

Capacitance Table

(→ GRM Series High Dielectric Constant Type)

p00 ← Part Number List JIS: R B EIA: X7R X7S X7T X7U X6S X6T X5R

| L×W (mm) | 1.6×0.8 | | | | | | | | | | | | | | 2.0×1.25 | | | | | | | | | | |
|---------------------|---------|-----|------|-----|--------|-----|--------|-----|-----|-----|-----|-----|-----|-----|----------|------|-----|--------|-----|--------|-----|--------|-----|-----|-----|
| T max. (mm) | 0.9 | | 0.95 | | | | 1.0 | | | | | | | | 0.7 | 0.95 | | | | | | | | | |
| Rated Voltage (Vdc) | 6.3 | 4 | 25 | 16 | 10 | 50 | 35 | 25 | 16 | 10 | 6.3 | 4 | 16 | 50 | 35 | 25 | | | | | | | | | |
| Cap. / TC Code | X5R, B | X5R | X5R | X6S | X5R, B | X7S | X5R, B | X5R | X6S | X5R | X7S | X6S | X5R | X7S | X6S | X7T | X7T | X5R, B | X6S | X5R, B | X6S | X5R, B | X6S | X5R | X7R |
| 100pF | | | | | | | | | | | | | | | | | | | | | | | | | |
| 150pF | | | | | | | | | | | | | | | | | | | | | | | | | |
| 220pF | | | | | | | | | | | | | | | | | | | | | | | | | |
| 330pF | | | | | | | | | | | | | | | | | | | | | | | | | |
| 470pF | | | | | | | | | | | | | | | | | | | | | | | | | |
| 680pF | | | | | | | | | | | | | | | | | | | | | | | | | |
| 820pF | | | | | | | | | | | | | | | | | | | | | | | | | |
| 1000pF | | | | | | | | | | | | | | | | | | | | | | | | | |
| 1500pF | | | | | | | | | | | | | | | | | | | | | | | | | |
| 2200pF | | | | | | | | | | | | | | | | | | | | | | | | | |
| 3300pF | | | | | | | | | | | | | | | | | | | | | | | | | |
| 4700pF | | | | | | | | | | | | | | | | | | | | | | | | | |
| 6800pF | | | | | | | | | | | | | | | | | | | | | | | | | |
| 10000pF | | | | | | | | | | | | | | | | | | | | | | | | | |
| 15000pF | | | | | | | | | | | | | | | | | | | | | | | | | |
| 22000pF | | | | | | | | | | | | | | | | | | | | | | | | | |
| 33000pF | | | | | | | | | | | | | | | | | | | | | | | | | |
| 47000pF | | | | | | | | | | | | | | | | | | | | | | | | | |
| 68000pF | | | | | | | | | | | | | | | | | | | | | | | | | |
| 0.10μF | | | | | | | | | | | | | | | | | | | | | | | | | |
| 0.15μF | | | | | | | | | | | | | | | | | | | | | | | | | |
| 0.22μF | | | | | | | | | | | | | | | | | | | | | | | | | |
| 0.33μF | | | | | | | | | | | | | | | | | | | | | | | | | |
| 0.47μF | | | | | | | | | | | | | | | | | | | | | | | | | |
| 0.68μF | | | | | | | | | | | | | | | | | | | | | | | | | |
| 1.0μF | | | | | | | | | | | | | | | | | | | | | | | | | |
| 2.2μF | | | | | | | | | | | | | | | | | | | | | | | | | |
| 4.7μF | | | | | | | | | | | | | | | | | | | | | | | | | |
| 10μF | | | | | | | | | | | | | | | | | | | | | | | | | |
| 22μF | | | | | | | | | | | | | | | | | | | | | | | | | |
| 47μF | | | | | | | | | | | | | | | | | | | | | | | | | |
| 100μF | | | | | | | | | | | | | | | | | | | | | | | | | |
| 150μF | | | | | | | | | | | | | | | | | | | | | | | | | |
| 220μF | | | | | | | | | | | | | | | | | | | | | | | | | |

Continued on the following page. ↗

Capacitance Table

(→ GRM Series High Dielectric Constant Type)

p00 ← Part Number List JIS: R B EIA: X7R X7S X7T X7U X6S X6T X5R

| L×W (mm) | 2.0×1.25 | | | | | | | | | | | | | | | | | | | | | | | | | |
|---------------------|----------|--------|------|--------|------|--------|------|--------|------|------|------|------|------|-----|-----|-----|-----|-----|-----|-----|--------|-----|--------|--------|-----|--|
| T max. (mm) | 0.95 | | | | | | 1.0 | | | | | | 1.35 | | 1.4 | | | | | | | | | | | |
| Rated Voltage (Vdc) | 25 | 16 | 10 | 6.3 | 4 | 2.5 | 500 | 250 | 200 | 35 | 25 | 16 | 25 | 16 | 50 | 25 | | | | | | | | | | |
| Cap. / TC Code | X6S | X5R, B | X7R | X5R, B | X7Δ | X5R, B | X6S | X5R, B | X6S | X5R | X6T | X7R | X7R | X7R | X6S | X7S | X6S | X7S | X5R | X6S | X5R, B | X7R | X5R, B | X5R, B | X7R | |
| 100pF | | | | | | | | | | | | | | | | | | | | | | | | | | |
| 150pF | | | | | | | | | | | | | | | | | | | | | | | | | | |
| 220pF | | | | | | | | | | | | | | | | | | | | | | | | | | |
| 330pF | | | | | | | | | | | | | | | | | | | | | | | | | | |
| 470pF | | | | | | | | | | | | | | | | | | | | | | | | | | |
| 680pF | | | | | | | | | | | | | | | | | | | | | | | | | | |
| 820pF | | | | | | | | | | | | | | | | | | | | | | | | | | |
| 1000pF | | | | | | | | | | | | | | | | | | | | | | | | | | |
| 1500pF | | | | | | | | | | | | | | | | | | | | | | | | | | |
| 2200pF | | | | | | | | | | | | | | | | | | | | | | | | | | |
| 3300pF | | | | | | | | | | | | | | | | | | | | | | | | | | |
| 4700pF | | | | | | | | | | | | | | | | | | | | | | | | | | |
| 6800pF | | | | | | | | | | | | | | | | | | | | | | | | | | |
| 10000pF | | | | | | | | | | | | | | | | | | | | | | | | | | |
| 15000pF | | | | | | | | | | | | | | | | | | | | | | | | | | |
| 22000pF | | | | | | | | | | | | | | | | | | | | | | | | | | |
| 33000pF | | | | | | | | | | | | | | | | | | | | | | | | | | |
| 47000pF | | | | | | | | | | | | | | | | | | | | | | | | | | |
| 68000pF | | | | | | | | | | | | | | | | | | | | | | | | | | |
| 0.10μF | | | | | | | | | | | | | | | | | | | | | | | | | | |
| 0.15μF | | | | | | | | | | | | | | | | | | | | | | | | | | |
| 0.22μF | | | | | | | | | | | | | | | | | | | | | | | | | | |
| 0.33μF | | | | | | | | | | | | | | | | | | | | | | | | | | |
| 0.47μF | | | | | | | | | | | | | | | | | | | | | | | | | | |
| 0.68μF | | | | | | | | | | | | | | | | | | | | | | | | | | |
| 1.0μF | | | | | | | | | | | | | | | | | | | | | | | | | | |
| 2.2μF | p104 | p104 | p104 | p104 | p104 | | | | | | | | | | | | | | | | | | | | | |
| 4.7μF | | p104 | | p104 | p104 | p104 | | | | | | | | | | | | | | | | | | | | |
| 10μF | | p104 | p104 | | | | p104 | | p104 | | | | | | | | | | | | | | | | | |
| 22μF | | | | | | | p104 | p104 | | p104 | | | | | | | | | | | | | | | | |
| 47μF | | | | | | | | | | | p104 | p104 | | | | | | | | | | | | | | |
| 100μF | | | | | | | | | | | | | | | | | | | | | | | | | | |
| 150μF | | | | | | | | | | | | | | | | | | | | | | | | | | |
| 220μF | | | | | | | | | | | | | | | | | | | | | | | | | | |

Continued on the following page. ↗

Capacitance Table

(→ GRM Series High Dielectric Constant Type)

p00 ← Part Number List JIS: R B EIA: X7R X7S X7T X7U X6S X6T X5R

| L×W (mm) | 2.0×1.25 | | | | | | | | | | | | | | | | | | | | | | | | | | | |
|---------------------|----------|------|------|------|------|------|-----|-----|-----|-----|------|-----|-----|-----|-----|-----|-----|-----|-----|-----|-----|-----|-----|-----|-----|-----|-----|-----|
| T max. (mm) | 1.4 | | | | | | | | | | 1.45 | | | | | | | | | | | | | | | | | |
| Rated Voltage (Vdc) | 25 | 16 | 10 | 6.3 | 4 | 500 | 250 | 200 | 50 | 35 | 25 | 16 | 10 | 6.3 | 25 | 16 | 10 | 6.3 | 4 | 500 | 250 | 200 | 50 | 35 | 25 | 16 | 10 | 6.3 |
| Cap. / TC Code | X5R, B | X6S | B | X7R | X6S | X7U | X6S | X7R | X7R | X7R | X7S | X6S | X7S | X6S | X5R | X7S | X6S | X5R | X7S | X6S | X5R | X7S | X6S | X5R | X7T | X6S | X5R | X7T |
| 100pF | | | | | | | | | | | | | | | | | | | | | | | | | | | | |
| 150pF | | | | | | | | | | | | | | | | | | | | | | | | | | | | |
| 220pF | | | | | | | | | | | | | | | | | | | | | | | | | | | | |
| 330pF | | | | | | | | | | | | | | | | | | | | | | | | | | | | |
| 470pF | | | | | | | | | | | | | | | | | | | | | | | | | | | | |
| 680pF | | | | | | | | | | | | | | | | | | | | | | | | | | | | |
| 820pF | | | | | | | | | | | | | | | | | | | | | | | | | | | | |
| 1000pF | | | | | | | | | | | | | | | | | | | | | | | | | | | | |
| 1500pF | | | | | | | | | | | | | | | | | | | | | | | | | | | | |
| 2200pF | | | | | | | | | | | | | | | | | | | | | | | | | | | | |
| 3300pF | | | | | | | | | | | | | | | | | | | | | | | | | | | | |
| 4700pF | | | | | | | | | | | | | | | | | | | | | | | | | | | | |
| 6800pF | | | | | | | | | | | | | | | | | | | | | | | | | | | | |
| 10000pF | | | | | | | | | | | | | | | | | | | | | | | | | | | | |
| 15000pF | | | | | | | | | | | | | | | | | | | | | | | | | | | | |
| 22000pF | | | | | | | | | | | | | | | | | | | | | | | | | | | | |
| 33000pF | | | | | | | | | | | | | | | | | | | | | | | | | | | | |
| 47000pF | | | | | | | | | | | | | | | | | | | | | | | | | | | | |
| 68000pF | | | | | | | | | | | | | | | | | | | | | | | | | | | | |
| 0.10μF | | | | | | | | | | | | | | | | | | | | | | | | | | | | |
| 0.15μF | | | | | | | | | | | | | | | | | | | | | | | | | | | | |
| 0.22μF | | | | | | | | | | | | | | | | | | | | | | | | | | | | |
| 0.33μF | | | | | | | | | | | | | | | | | | | | | | | | | | | | |
| 0.47μF | | | | | | | | | | | | | | | | | | | | | | | | | | | | |
| 0.68μF | | | | | | | | | | | | | | | | | | | | | | | | | | | | |
| 1.0μF | | | | | | | | | | | | | | | | | | | | | | | | | | | | |
| 2.2μF | | | | | | | | | | | | | | | | | | | | | | | | | | | | |
| 4.7μF | | | | | | | | | | | | | | | | | | | | | | | | | | | | |
| 10μF | p105 | p105 | p105 | p105 | | | | | | | | | | | | | | | | | | | | | | | | |
| 22μF | | | p105 | p105 | p105 | p105 | | | | | | | | | | | | | | | | | | | | | | |
| 47μF | | | | | | | | | | | | | | | | | | | | | | | | | | | | |
| 100μF | | | | | | | | | | | | | | | | | | | | | | | | | | | | |
| 150μF | | | | | | | | | | | | | | | | | | | | | | | | | | | | |
| 220μF | | | | | | | | | | | | | | | | | | | | | | | | | | | | |

Continued on the following page. ↗

Capacitance Table

(→ GRM Series High Dielectric Constant Type)

| p00 | ← Part Number List | | | | JIS: R B | EIA: X7R X7S X7T X7U X6S X6T X5R | | | | | | | | | | | | | | | | | |
|---------------------|--------------------|-----|--------|-----|---|--|--------|-----|---------|------|-----|-----|-----|-----|----|------|-----|-----|-----|-----|-----|-----|--------|
| L×W (mm) | 2.0×1.25 | | | | | | | | 3.2×1.6 | | | | | | | | | | | | | | |
| T max. (mm) | 1.45 | | | | 0.95 | | | | 1.0 | 1.25 | | | | | | 1.8 | | | | | | | |
| Rated Voltage (Vdc) | 6.3 | 4 | 2.5 | 35 | 16 | 10 | 6.3 | 630 | 1000 | 630 | 500 | 250 | 200 | 50 | 25 | 1000 | 630 | 500 | 250 | 200 | 100 | 50 | |
| Cap. / TC Code | X5R, B | X6S | X5R, B | X6S | X5R | X5R, B | X5R, B | X6S | X5R, B | X7R | X7R | X7R | X7R | X7R | B | X5R | X7R | X7R | X7R | X7R | X7R | X7R | X5R, B |
| 100pF | | | | | | | | | | | | | | | | | | | | | | | |
| 150pF | | | | | | | | | | | | | | | | | | | | | | | |
| 220pF | | | | | | | | | | | | | | | | | | | | | | | |
| 330pF | | | | | | | | | | | | | | | | | | | | | | | |
| 470pF | | | | | | | | | | | | | | | | | | | | | | | |
| 680pF | | | | | | | | | | | | | | | | | | | | | | | |
| 820pF | | | | | | | | | | | | | | | | | | | | | | | |
| 1000pF | | | | | | | | | | | | | | | | | | | | | | | |
| 1500pF | | | | | | | | | | | | | | | | | | | | | | | |
| 2200pF | | | | | | | | | | | | | | | | | | | | | | | |
| 3300pF | | | | | | | | | | | | | | | | | | | | | | | |
| 4700pF | | | | | | | | | | | | | | | | | | | | | | | |
| 6800pF | | | | | | | | | | | | | | | | | | | | | | | |
| 10000pF | | | | | | | | | | | | | | | | | | | | | | | |
| 15000pF | | | | | | | | | | | | | | | | | | | | | | | |
| 22000pF | | | | | | | | | | | | | | | | | | | | | | | |
| 33000pF | | | | | | | | | | | | | | | | | | | | | | | |
| 47000pF | | | | | | | | | | | | | | | | | | | | | | | |
| 68000pF | | | | | | | | | | | | | | | | | | | | | | | |
| 0.10μF | | | | | | | | | | | | | | | | | | | | | | | |
| 0.15μF | | | | | | | | | | | | | | | | | | | | | | | |
| 0.22μF | | | | | | | | | | | | | | | | | | | | | | | |
| 0.33μF | | | | | | | | | | | | | | | | | | | | | | | |
| 0.47μF | | | | | | | | | | | | | | | | | | | | | | | |
| 0.68μF | | | | | | | | | | | | | | | | | | | | | | | |
| 1.0μF | | | | | | | | | | | | | | | | | | | | | | | |
| 2.2μF | | | | | | | | | | | | | | | | | | | | | | | |
| 4.7μF | | | | | | | | | | | | | | | | | | | | | | | |
| 10μF | | | | | | | | | | | | | | | | | | | | | | | |
| 22μF | | | | | | | | | | | | | | | | | | | | | | | |
| 47μF | | | | | | | | | | | | | | | | | | | | | | | |
| 100μF | | | | | | | | | | | | | | | | | | | | | | | |
| 150μF | | | | | | | | | | | | | | | | | | | | | | | |
| 220μF | | | | | | | | | | | | | | | | | | | | | | | |

Continued on the following page. ↗

Capacitance Table

(→ GRM Series High Dielectric Constant Type)

p00 ← Part Number List JIS: R B EIA: X7R X7S X7T X7U X6S X6T X5R

| L×W (mm) | 3.2×1.6 | | | | | | | | | | | | | | | | | | | | 3.2×2.5 | | | | | | |
|---------------------|---------|--------|------|--------|------|--------|------|------|--------|------|------|------|------|-----|------|------|------|------|------|------|---------|------|------|-----|------|------|--|
| T max. (mm) | 1.8 | | | | | | | | | | 1.9 | | | | | | | | | | 1.5 | | | | | | |
| Rated Voltage (Vdc) | 25 | | 16 | | 10 | | 6.3 | | 4 | | 25 | | 16 | | 10 | | 6.3 | | 4 | | 2.5 | | 1000 | 630 | | | |
| Cap. / TC Code | X7R | X5R, B | X6S | X5R, B | X7R | X5R, B | X7Δ | X6S | X5R, B | X7U | X6S | X6S | X7S | X5R | X6S | X5R | X6T | X5R | X7U | X6Δ | X5R | X6S | X5R | X7R | X7R | | |
| 100pF | | | | | | | | | | | | | | | | | | | | | | | | | | | |
| 150pF | | | | | | | | | | | | | | | | | | | | | | | | | | | |
| 220pF | | | | | | | | | | | | | | | | | | | | | | | | | | | |
| 330pF | | | | | | | | | | | | | | | | | | | | | | | | | | | |
| 470pF | | | | | | | | | | | | | | | | | | | | | | | | | | | |
| 680pF | | | | | | | | | | | | | | | | | | | | | | | | | | | |
| 820pF | | | | | | | | | | | | | | | | | | | | | | | | | | | |
| 1000pF | | | | | | | | | | | | | | | | | | | | | | | | | | | |
| 1500pF | | | | | | | | | | | | | | | | | | | | | | | | | | | |
| 2200pF | | | | | | | | | | | | | | | | | | | | | | | | | | | |
| 3300pF | | | | | | | | | | | | | | | | | | | | | | | | | | | |
| 4700pF | | | | | | | | | | | | | | | | | | | | | | | | | | | |
| 6800pF | | | | | | | | | | | | | | | | | | | | | | | | | | p106 | |
| 10000pF | | | | | | | | | | | | | | | | | | | | | | | | | | p106 | |
| 15000pF | | | | | | | | | | | | | | | | | | | | | | | | | | | |
| 22000pF | | | | | | | | | | | | | | | | | | | | | | | | | | p106 | |
| 33000pF | | | | | | | | | | | | | | | | | | | | | | | | | | | |
| 47000pF | | | | | | | | | | | | | | | | | | | | | | | | | | | |
| 68000pF | | | | | | | | | | | | | | | | | | | | | | | | | | | |
| 0.10μF | | | | | | | | | | | | | | | | | | | | | | | | | | | |
| 0.15μF | | | | | | | | | | | | | | | | | | | | | | | | | | | |
| 0.22μF | | | | | | | | | | | | | | | | | | | | | | | | | | | |
| 0.33μF | | | | | | | | | | | | | | | | | | | | | | | | | | | |
| 0.47μF | | | | | | | | | | | | | | | | | | | | | | | | | | | |
| 0.68μF | | | | | | | | | | | | | | | | | | | | | | | | | | | |
| 1.0μF | | | | | | | | | | | | | | | | | | | | | | | | | | | |
| 2.2μF | | | | | | | | | | | | | | | | | | | | | | | | | | | |
| 4.7μF | | | | | | | | | | | | | | | | | | | | | | | | | | | |
| 10μF | p106 | p106 | | | | | | | | | | | | | | | | | | | | | | | | | |
| 22μF | p106 | p106 | p106 | p106 | p106 | | p106 | | | | | p106 | p106 | | | | | | | | | | | | | | |
| 47μF | | | | | | p106 | p106 | p106 | p106 | p106 | p106 | p106 | | | p106 | p106 | | | | | | | | | | | |
| 100μF | | | | | | | | | | | | | | | | | p106 | p106 | p106 | p106 | p106 | p106 | | | | | |
| 150μF | | | | | | | | | | | | | | | | | | p106 | | p106 | p106 | p106 | | | | | |
| 220μF | | | | | | | | | | | | | | | | | | | | | | p106 | | | p106 | | |

Continued on the following page. ↗

Capacitance Table

(→ GRM Series High Dielectric Constant Type)

p00 ← Part Number List JIS: R B EIA: X7R X7S X7T X7U X6S X6T X5R

| L×W (mm) | 3.2×2.5 | | | | | | | | | | | | | | | | | | | | | | | | | |
|---------------------|---------|-----|-----|-----|------|-----|-----|-----|-----|-----|-----|-----|-----|-----|-----|-------|-----|-------|-----|-------|-----|-----|-------|-----|-------|--|
| T max. (mm) | 1.5 | | | 1.8 | 2.0 | | | | | 2.2 | | 2.7 | | | | | | | | | | | | | | |
| Rated Voltage (Vdc) | 500 | 250 | 200 | 100 | 1000 | 630 | 500 | 250 | 200 | 100 | 25 | 100 | 80 | 63 | 50 | 35 | 25 | 16 | | 10 | | | | | | |
| Cap. / TC Code | X7R | X7R | X7R | X7R | X7R | X7R | X7R | X7R | X7R | X7S | X7R | X7R | X7R | X7R | X7R | X5R,B | X7R | X5R,B | X7R | X5R,B | X7R | X6S | X5R,B | X7R | X5R,B | |
| 100pF | | | | | | | | | | | | | | | | | | | | | | | | | | |
| 150pF | | | | | | | | | | | | | | | | | | | | | | | | | | |
| 220pF | | | | | | | | | | | | | | | | | | | | | | | | | | |
| 330pF | | | | | | | | | | | | | | | | | | | | | | | | | | |
| 470pF | | | | | | | | | | | | | | | | | | | | | | | | | | |
| 680pF | | | | | | | | | | | | | | | | | | | | | | | | | | |
| 820pF | | | | | | | | | | | | | | | | | | | | | | | | | | |
| 1000pF | | | | | | | | | | | | | | | | | | | | | | | | | | |
| 1500pF | | | | | | | | | | | | | | | | | | | | | | | | | | |
| 2200pF | | | | | | | | | | | | | | | | | | | | | | | | | | |
| 3300pF | | | | | | | | | | | | | | | | | | | | | | | | | | |
| 4700pF | | | | | | | | | | | | | | | | | | | | | | | | | | |
| 6800pF | | | | | | | | | | | | | | | | | | | | | | | | | | |
| 10000pF | | | | | | | | | | | | | | | | | | | | | | | | | | |
| 15000pF | | | | | | | | | | | | | | | | | | | | | | | | | | |
| 22000pF | | | | | | | | | | | | | | | | | | | | | | | | | | |
| 33000pF | | | | | | | | | | | | | | | | | | | | | | | | | | |
| 47000pF | | | | | | | | | | | | | | | | | | | | | | | | | | |
| 68000pF | | | | | | | | | | | | | | | | | | | | | | | | | | |
| 100µF | | | | | | | | | | | | | | | | | | | | | | | | | | |
| 150µF | | | | | | | | | | | | | | | | | | | | | | | | | | |
| 220µF | | | | | | | | | | | | | | | | | | | | | | | | | | |
| 330µF | | | | | | | | | | | | | | | | | | | | | | | | | | |
| 470µF | | | | | | | | | | | | | | | | | | | | | | | | | | |
| 680µF | | | | | | | | | | | | | | | | | | | | | | | | | | |
| 1.0µF | | | | | | | | | | | | | | | | | | | | | | | | | | |
| 2.2µF | | | | | | | | | | | | | | | | | | | | | | | | | | |
| 4.7µF | | | | | | | | | | | | | | | | | | | | | | | | | | |
| 10µF | | | | | | | | | | | | | | | | | | | | | | | | | | |
| 22µF | | | | | | | | | | | | | | | | | | | | | | | | | | |
| 47µF | | | | | | | | | | | | | | | | | | | | | | | | | | |
| 100µF | | | | | | | | | | | | | | | | | | | | | | | | | | |
| 150µF | | | | | | | | | | | | | | | | | | | | | | | | | | |
| 220µF | | | | | | | | | | | | | | | | | | | | | | | | | | |

Continued on the following page. ↗

Capacitance Table

(→ GRM Series High Dielectric Constant Type)

| p00 | ← Part Number List | | | JIS: R B | EIA: X7R X7S X7T X7U X6S X6T X5R | | | | | | | | | | | |
|---------------------|--------------------|--------|-----|---|--|-----|------|-----|-----|---------|-----|------|-----|-----|-----|-----|
| L×W (mm) | 3.2×2.5 | | | 4.5×3.2 | | | | | | 5.7×5.0 | | | | | | |
| T max. (mm) | 2.7 | | | 1.5 | | | 2.0 | | | 2.0 | | | | | | |
| Rated Voltage (Vdc) | 6.3 | 4 | 630 | 500 | 250 | 200 | 1000 | 630 | 500 | 250 | 200 | 1000 | 630 | 500 | 250 | 200 |
| Cap. / TC Code | X7Δ | X5R, B | X7U | X7R | X7R | X7R | X7R | X7R | X7R | X7R | X7R | X7R | X7R | X7R | X7R | X7R |
| 100pF | | | | | | | | | | | | | | | | |
| 150pF | | | | | | | | | | | | | | | | |
| 220pF | | | | | | | | | | | | | | | | |
| 330pF | | | | | | | | | | | | | | | | |
| 470pF | | | | | | | | | | | | | | | | |
| 680pF | | | | | | | | | | | | | | | | |
| 820pF | | | | | | | | | | | | | | | | |
| 1000pF | | | | | | | | | | | | | | | | |
| 1500pF | | | | | | | | | | | | | | | | |
| 2200pF | | | | | | | | | | | | | | | | |
| 3300pF | | | | | | | | | | | | | | | | |
| 4700pF | | | | | | | | | | | | | | | | |
| 6800pF | | | | | | | | | | | | | | | | |
| 10000pF | | | | | | | | | | | | | | | | |
| 15000pF | | | | | | | | | | | | | | | | |
| 22000pF | | | | | | | | | | | | | | | | |
| 33000pF | | | | | | | | | | | | | | | | |
| 47000pF | | | | | | | | | | | | | | | | |
| 68000pF | | | | | | | | | | | | | | | | |
| 0.10μF | | | | | | | | | | | | | | | | |
| 0.15μF | | | | | | | | | | | | | | | | |
| 0.22μF | | | | | | | | | | | | | | | | |
| 0.33μF | | | | | | | | | | | | | | | | |
| 0.47μF | | | | | | | | | | | | | | | | |
| 0.68μF | | | | | | | | | | | | | | | | |
| 1.0μF | | | | | | | | | | | | | | | | |
| 2.2μF | | | | | | | | | | | | | | | | |
| 4.7μF | | | | | | | | | | | | | | | | |
| 10μF | | | | | | | | | | | | | | | | |
| 22μF | | | | | | | | | | | | | | | | |
| 47μF | | | | | | | | | | | | | | | | |
| 100μF | | | | | | | | | | | | | | | | |
| 150μF | | | | | | | | | | | | | | | | |
| 220μF | | | | | | | | | | | | | | | | |

Capacitance Table

GR3 Series High Dielectric Constant Type

p00 ← Part Number List EIA: X7T

| L×W (mm) | 2.0×1.25 | | 3.2×1.6 | | | | | | 3.2×2.5 | | | | 4.5×3.2 | | | 5.7×5.0 | | | | | | | | |
|---------------------|----------|------|---------|-----|------|-----|------|-----|---------|------|-----|------|---------|------|------|---------|-----|-----|-----|-----|-----|-----|------|------|
| T max. (mm) | 1.0 | 1.45 | 1.0 | | 1.25 | | 1.8 | | 1.5 | | 2.0 | | 1.5 | 2.0 | | 2.0 | | | 2.7 | | | | | |
| Rated Voltage (Vdc) | 250 | 250 | 450 | 250 | 630 | 450 | 250 | 630 | 450 | 250 | 630 | 250 | 630 | 450 | 250 | 250 | 630 | 450 | 250 | 630 | 450 | 250 | 630 | 250 |
| Cap. / TC Code | X7T | X7T | X7T | X7T | X7T | X7T | X7T | X7T | X7T | X7T | X7T | X7T | X7T | X7T | X7T | X7T | X7T | X7T | X7T | X7T | X7T | X7T | X7T | X7T |
| 10000pF | p110 | | p110 | | p110 | | | | | | | | | | | | | | | | | | | |
| 15000pF | p110 | | p110 | | | | p110 | | | | | | | | | | | | | | | | | |
| 22000pF | | p110 | | | | | | | | p110 | | | | | | | | | | | | | | |
| 33000pF | | | | | p110 | | | | | | | | p110 | | | | | | | | | | | |
| 47000pF | | | | | p110 | | | | | | | | p110 | | | | | | | | | | | |
| 68000pF | | | | | | | | | | p110 | | | | p110 | | | | | | | | | | |
| 0.10μF | | | | | | | | | | | | p110 | | p110 | | | | | | | | | p110 | |
| 0.15μF | | | | | | | | | | | | | | | p110 | | | | | | | | p110 | |
| 0.22μF | | | | | | | | | | | | | | | | p110 | | | | | | | p110 | p110 |
| 0.33μF | | | | | | | | | | | | | | | | | | | | | | | p110 | |
| 0.47μF | | | | | | | | | | | | | | | | | | | | | | | p110 | p110 |
| 0.68μF | | | | | | | | | | | | | | | | | | | | | | | | p110 |
| 1.0μF | | | | | | | | | | | | | | | | | | | | | | | | p110 |

Capacitance Table

GRJ Series High Dielectric Constant Type

p00 ← Part Number List EIA: X7R X7S X5R

| L×W (mm) | 1.6×0.8 | | | | | | 2.0×1.25 | | | | | | | | | | 3.2×1.6 | | | | | | |
|---------------------|---------|------|------|------|------|------|----------|------|------|------|------|------|-----|------|------|------|---------|------|------|------|------|------|-----------|
| T max. (mm) | 0.9 | | | | | | 1.0 | 0.7 | 0.95 | 1.0 | 1.45 | | | | | | 1.5 | 0.95 | 1.25 | | | | |
| Rated Voltage (Vdc) | 100 | 50 | 35 | 25 | 16 | 6.3 | 6.3 | 100 | 50 | 100 | 250 | 250 | 100 | 50 | 25 | 16 | 10 | 100 | 100 | 50 | 1000 | 630 | |
| Cap. / TC Code | X7R | X7R | X5R | X7R | X7R | X7R | X7S | X7R | X7R | X7R | X7R | X7R | X7R | X7R | X7R | X7R | X7R | X7S | X7R | X7R | X7R | X7R | |
| 220pF | | | | | | | | | | p121 | | | | | | | | | | | | | |
| 470pF | | | | | | | | | p121 | p121 | | | | | | | | | | | | | p122 |
| 680pF | | | | | | | | | | | | | | | | | | | | | | | p122 |
| 1000pF | p121 | p121 | | | | | | p121 | p121 | | p121 | | | | | | | | | | | | p122 p122 |
| 1500pF | | | | | | | | | | | p121 | | | | | | | | | | | | p122 p122 |
| 2200pF | p121 | p121 | | | | | | p121 | p121 | | p121 | | | | | | | | | | | | p122 p122 |
| 3300pF | | | | | | | | | | | p121 | | | | | | | | | | | | p122 p122 |
| 4700pF | p121 | p121 | | | | | | p121 | p121 | | p121 | | | | | | | | | | | | p122 p122 |
| 6800pF | | | | | | | | | | | p121 | | | | | | | | | | | | p122 |
| 10000pF | p121 | p121 | | | | | | p121 | p121 | | | p121 | | | | | | | | | | | p122 |
| 15000pF | | | | | | | | | | | | p121 | | | | | | | | | | | |
| 22000pF | p121 | p121 | | | | | | p121 | p121 | | | p121 | | | | | | | | | | | |
| 33000pF | | | | | | | | | | | | | | | | | | | | | | | |
| 47000pF | | p121 | | | p121 | | | | | | | | | p121 | p121 | | | | | | | | |
| 68000pF | | | | | | | | | | | | | | | | | | | | | | | |
| 0.10μF | p121 | p121 | | | | | | | | | | | | p121 | p121 | | | | | | p122 | p122 | |
| 0.15μF | | | | | | | | | | | | | | | | | | | | | | | |
| 0.22μF | | p121 | | | p121 | | | | | | | | | | | | | | | | | | |
| 0.33μF | | | | | | | | | | | | | | | | | | | | | | | |
| 0.47μF | | | | | | p121 | | | | | | | | | | | | | | | | | |
| 0.68μF | | | | | | | | | | | | | | | | | | | | | | | |
| 1.0μF | | | p121 | p121 | | | | | | | | | | | p121 | p121 | | | | | p121 | | |
| 2.2μF | | | | | | p121 | | | | | | | | | | | p121 | | | | | | |
| 4.7μF | | | | | | | p121 | | | | | | | | | | | | p121 | | | | |
| 10μF | | | | | | | | | | | | | | | | | | | | p121 | | | |
| 22μF | | | | | | | | | | | | | | | | | | | | | | | |
| 47μF | | | | | | | | | | | | | | | | | | | | | | | |

| L×W (mm) | 3.2×2.5 | | | | | | 4.5×3.2 | | | | 5.7×5.0 | | | |
|---------------------|---------|------|------|------|------|------|---------|------|------|------|---------|------|------|------|
| T max. (mm) | 2.8 | | | | | | 2.85 | 1.5 | 2.0 | | 2.0 | | | |
| Rated Voltage (Vdc) | 50 | 25 | 16 | 10 | 6.3 | 25 | 630 | 250 | 1000 | 630 | 250 | 1000 | 630 | 250 |
| Cap. / TC Code | X7R | X7S | X7R | X7R | X7R | X7R | X7S | X7R | X7R | X7R | X7R | X7R | X7R | X7R |
| 33000pF | | | | | | | | | | p123 | | | | |
| 47000pF | | | | | | | | | | p123 | | | | |
| 68000pF | | | | | | | | p123 | | | | p123 | | |
| 0.10μF | | | | | | | | | | p123 | | p123 | | |
| 0.15μF | | | | | | | | | p123 | | | | p123 | |
| 0.22μF | | | | | | | | | | | p123 | | p123 | |
| 0.33μF | | | | | | | | | | | | p123 | | p123 |
| 0.47μF | | | | | | | | | | | | p123 | | p123 |
| 0.68μF | | | | | | | | | | | | | p123 | p123 |
| 1.0μF | | | | | | | | | | | | | | p123 |
| 2.2μF | | | | | | | | | | | | | | |
| 4.7μF | p122 | | | | | | | | | | | | | |
| 10μF | p122 | p122 | p122 | | | | | | | | | | | |
| 22μF | | | | p122 | p122 | | p122 | | | | | | | |
| 47μF | | | | | p122 | p122 | | | | | | | | |

| 3.2×1.6 | | | | | | | | | | | | | | 3.2×2.5 | | | | | | L×W (mm) | | | |
|---------|-----|------|-----|-----|------|------|------|------|------|------|------|------|------|---------|------|------|------|------|-----|----------|-------------|---------------------|----------------|
| 1.25 | | 1.35 | | | | 1.8 | | | 1.9 | | | | | 1.5 | | | 2.0 | | | 2.3 | T max. (mm) | | |
| 250 | 100 | 50 | 25 | 16 | 1000 | 630 | 250 | 100 | 50 | 25 | 16 | 10 | 6.3 | 1000 | 630 | 250 | 1000 | 630 | 250 | 100 | | Rated Voltage (Vdc) | |
| X7R | X7R | X7R | X7R | X7R | X7R | X7R | X7R | X7R | X7R | X7R | X7R | X7R | X7R | X7R | X7R | X7R | X7R | X7R | X7R | X7R | X7R | X7S | Cap. / TC Code |
| | | | | | | | | | | | | | | | | | | | | | | | 220pF |
| | | | | | | | | | | | | | | | | | | | | | | | 470pF |
| | | | | | | | | | | | | | | | | | | | | | | | 680pF |
| | | | | | | | | | | | | | | | | | | | | | | | 1000pF |
| | | | | | | | | | | | | | | | | | | | | | | | 1500pF |
| | | | | | | | | | | | | | | | | | | | | | | | 2200pF |
| | | | | | | | | | | | | | | | | | | | | | | | 3300pF |
| | | | | | | | | | | | | | | | | | | | | | | | 4700pF |
| | | | | | | p122 | | | | | | | | | | | | | | | | | 6800pF |
| | | | | | | p122 | | | | | | | | | | | | | | | | | 10000pF |
| | | | | | | | p122 | | | | | | | | | | | | | | | | 15000pF |
| | | | | | | | p122 | | | | | | | | | | | | | | | | 22000pF |
| | | | | | | | | p122 | | | | | | | | | | | | | | | 33000pF |
| | | | | | | | | p122 | | | | | | | | | | | | | | | 47000pF |
| | | | | | | | | | p122 | | | | | | | | | | | | | | 68000pF |
| | | | | | | | | | | p122 | | | | | | | | | | | | | 0.10μF |
| | | | | | | | | | | | p122 | | | | | | | | | | | | 0.15μF |
| | | | | | | | | | | | | p122 | | | | | | | | | | | 0.22μF |
| | | | | | | | | | | | | | p122 | | | | | | | | | | 0.33μF |
| | | | | | | | | | | | | | | p122 | | | | | | | | | 0.47μF |
| | | | | | | | | | | | | | | | p122 | | | | | | | | 0.68μF |
| | | | | | | | | | | | | | | | | p122 | | | | | | | 1.0μF |
| | | | | | | | | | | | | | | | | | p122 | | | | | | 2.2μF |
| | | | | | | | | | | | | | | | | | | p122 | | | | | 4.7μF |
| | | | | | | | | | | | | | | | | | | | | | | | 10μF |
| | | | | | | | | | | | | | | | | | | | | | | | 22μF |
| | | | | | | | | | | | | | | | | | | | | | | | 47μF |

Continued to the following table. ↙

Capacitance Table

GR4 Series High Dielectric Constant Type

p00 ← Part Number List EIA: X7R

| L×W (mm) | 0.4×0.2 | 4.5×3.2 | | 5.7×5.0 |
|---------------------|---------|---------|------|---------|
| T max. (mm) | 1.5 | 1.5 | 2.0 | 2.0 |
| Rated Voltage (Vdc) | 2000 | 2000 | 2000 | 2000 |
| Cap. / TC Code | X7R | X7R | X7R | X7R |
| 100pF | p126 | | | |
| 120pF | p126 | | | |
| 150pF | p126 | | | |
| 180pF | p126 | | | |
| 220pF | p126 | | | |
| 270pF | p126 | | | |
| 330pF | p126 | | | |
| 390pF | p126 | | | |
| 470pF | p126 | | | |
| 560pF | p126 | | | |
| 680pF | p126 | | | |
| 820pF | p126 | | | |
| 1000pF | p126 | | | |
| 1200pF | p126 | | | |
| 1500pF | p126 | | | |
| 1800pF | | p126 | | |
| 2200pF | | p126 | | |
| 2700pF | | p126 | | |
| 3300pF | | p126 | | |
| 3900pF | | p126 | | |
| 4700pF | | | p126 | |
| 10000pF | | | | p126 |

GR7 Series High Dielectric Constant Type

p00 ← Part Number List EIA: X7T

| L×W (mm) | 2.0×1.25 | | 3.2×1.6 | | |
|---------------------|----------|------|---------|------|------|
| T max. (mm) | 1.0 | 1.45 | 1.0 | 1.25 | 1.8 |
| Rated Voltage (Vdc) | 350 | 350 | 350 | 350 | 350 |
| Cap. / TC Code | X7T | X7T | X7T | X7T | X7T |
| 10000pF | p131 | | p131 | | |
| 15000pF | p131 | | p131 | | |
| 22000pF | | p131 | p131 | p131 | |
| 27000pF | | p131 | p131 | | |
| 33000pF | | | p131 | p131 | |
| 47000pF | | | | | p131 |

GJM Series Temperature Compensating Type

p00 ← Part Number List JIS: CK CJ CH EIA: COG

| L×W (mm) | 0.4×0.2 | | 0.6×0.3 | | | | 1.0×0.5 | | | |
|---------------------|---------|------|---------|------|------|------|---------|------|------|------|
| T max. (mm) | 0.22 | | 0.33 | | | | 0.55 | | | |
| Rated Voltage (Vdc) | 25 | | 50 | | 25 | | 50 | | | |
| Cap. / TC Code | COG | CΔ | COG | CK | CJ | CH | COG | CΔ | COG | CΔ |
| 0.10pF | | | | | | | | | p149 | p153 |
| 0.20pF | p136 | p139 | p142 | p142 | | p142 | | | p149 | p153 |
| 1.0pF | p136 | p139 | | p142 | | | p143 | p146 | p149 | p153 |
| 2.0pF | p136 | p139 | | p142 | | | p143 | p146 | p149 | p153 |
| 3.0pF | p136 | p139 | | | p142 | | p143 | p146 | p150 | p153 |
| 4.0pF | p137 | p140 | | | | | p143 | p147 | p150 | p154 |
| 5.0pF | p137 | p140 | | | | | p144 | p147 | p150 | p154 |
| 6.0pF | p137 | p140 | | | | | p144 | p147 | p151 | p154 |
| 7.0pF | p138 | p141 | | | | | p144 | p148 | p151 | p155 |
| 8.0pF | p138 | p141 | | | | | p145 | p148 | p151 | p155 |
| 9.0pF | p138 | p142 | | | | | p145 | p148 | p152 | p155 |
| 10pF | p139 | p142 | | | | | p146 | p149 | p152 | p156 |
| 11pF | p139 | p142 | | | | | p146 | p149 | p152 | p156 |
| 12pF | p139 | p142 | | | | | p146 | p149 | p152 | p156 |
| 13pF | p139 | p142 | | | | | p146 | p149 | p152 | p156 |
| 15pF | p139 | p142 | | | | | p146 | p149 | p152 | p156 |
| 16pF | p139 | p142 | | | | | p146 | p149 | p152 | p156 |
| 18pF | p139 | p142 | | | | | p146 | p149 | p152 | p156 |
| 20pF | p139 | p142 | | | | | p146 | p149 | p152 | p156 |
| 22pF | p139 | p142 | | | | | p146 | p149 | p152 | p156 |
| 24pF | | | | | | | p146 | p149 | p152 | p156 |
| 27pF | | | | | | | p146 | p149 | p152 | p156 |
| 30pF | | | | | | | p146 | p149 | p152 | p156 |
| 33pF | | | | | | | p146 | p149 | p152 | p156 |
| 36pF | | | | | | | | | p152 | p156 |
| 39pF | | | | | | | | | p152 | p156 |
| 43pF | | | | | | | | | p152 | p156 |
| 47pF | | | | | | | | | p153 | p156 |

The indication for every 0.1 pF has been omitted for less than 10 pF. Refer to the Part Number List for details.

Capacitance Table

GQM Series Temperature Compensating Type

p00 ← Part Number List EIA: COG Murata Temperature Characteristic: X8G

| L×W (mm) | 1.0×0.5 | | 1.6×0.8 | | 2.0×1.25 | | 2.8×2.8 |
|---------------------|---------|------|---------|------|----------|------|---------|
| T max. (mm) | 0.55 | | 0.8 | | 1.0 | | 1.35 |
| Rated Voltage (Vdc) | 200 | 100 | 250 | 500 | 250 | 500 | |
| Cap. / TC Code | COG | COG | COG | X8G | X8G | COG | X8G |
| 0.10pF | p165 | | | | | | |
| 1.0pF | p165 | | p166 | p166 | p167 | p168 | p169 |
| 1.1pF | p165 | | p166 | p166 | p167 | p168 | p169 |
| 1.2pF | p165 | | p166 | p167 | p167 | p168 | p169 |
| 1.3pF | p165 | | p166 | p167 | p167 | p168 | p169 |
| 1.5pF | p165 | | p166 | p167 | p167 | p168 | p169 |
| 1.6pF | p165 | | p166 | p167 | p167 | p168 | p169 |
| 1.8pF | p165 | | p166 | p167 | p167 | p168 | p169 |
| 2.0pF | p165 | | p166 | p167 | p167 | p168 | p169 |
| 2.2pF | p165 | | p166 | p167 | p167 | p168 | p169 |
| 2.4pF | p165 | | p166 | p167 | p167 | p168 | p169 |
| 2.7pF | p165 | | p166 | p167 | p167 | p168 | p169 |
| 3.0pF | p165 | | p166 | p167 | p168 | p168 | p169 |
| 3.3pF | p165 | | p166 | p167 | p168 | p168 | p169 |
| 3.6pF | p165 | | p166 | p167 | p168 | p168 | p169 |
| 3.9pF | p165 | | p166 | p167 | p168 | p168 | p169 |
| 4.0pF | p165 | | p166 | p167 | p168 | p168 | p169 |
| 4.3pF | p165 | | p166 | p167 | p168 | p168 | p169 |
| 4.7pF | p165 | | p166 | p167 | p168 | p168 | p169 |
| 5.0pF | p165 | | p166 | p167 | p168 | p168 | p169 |
| 5.1pF | p165 | | p166 | p167 | p168 | p168 | p169 |
| 5.6pF | p165 | | p166 | p167 | p168 | p168 | p169 |
| 6.0pF | p165 | | p166 | p167 | p168 | p168 | p169 |
| 6.2pF | p165 | | p166 | p167 | p168 | p168 | p169 |
| 6.8pF | p165 | | p166 | p167 | p168 | p168 | p169 |
| 7.0pF | p165 | | p166 | p167 | p168 | p168 | p169 |
| 7.5pF | p165 | | p166 | p167 | p168 | p168 | p170 |
| 8.0pF | p165 | | p166 | p167 | p168 | p169 | p170 |
| 8.2pF | p165 | | p166 | p167 | p168 | p169 | p170 |
| 9.0pF | p165 | | p166 | p167 | p168 | p169 | p170 |
| 9.1pF | p165 | | p166 | p167 | p168 | p169 | p170 |
| 10pF | p165 | | p166 | p167 | p168 | p169 | p170 |
| 11pF | p165 | | p166 | p167 | p168 | p169 | p170 |
| 12pF | p165 | | p166 | p167 | p168 | p169 | p170 |
| 13pF | p165 | | p166 | p167 | p168 | p169 | p170 |
| 15pF | p165 | | p166 | p167 | p168 | p169 | p170 |
| 16pF | p165 | | p166 | p167 | p168 | p169 | p170 |
| 18pF | p165 | | p166 | p167 | p168 | p169 | p170 |
| 20pF | p165 | | p166 | p167 | p168 | p169 | p170 |
| 22pF | p165 | | p166 | p167 | p168 | p169 | p170 |
| 24pF | p165 | | p166 | p167 | | p169 | p170 |
| 27pF | p165 | | p166 | p167 | | p169 | p170 |
| 30pF | p165 | | p166 | p167 | | p169 | p170 |
| 33pF | p165 | | p166 | | | p169 | p170 |
| 36pF | | p165 | p166 | | | p169 | p170 |
| 39pF | | p166 | p166 | | | p169 | p170 |
| 43pF | | p166 | p166 | | | p169 | p170 |
| 47pF | | p166 | p166 | | | p169 | p170 |
| 51pF | | | | | | p169 | p170 |
| 56pF | | | | | | p169 | p170 |
| 62pF | | | | | | p169 | p170 |
| 68pF | | | | | | p169 | p170 |
| 75pF | | | | | | p169 | p170 |
| 82pF | | | | | | p169 | p170 |
| 91pF | | | | | | p169 | p171 |
| 100pF | | | | | | p169 | p171 |

The indication for every 0.1 pF has been omitted for less than 10 pF.
 Refer to the Part Number List for details.

Capacitance Table

GR2 Series High Dielectric Constant Type

p00 ← Part Number List EIA: X7R

| L×W (mm) | 4.5×2.0 | 4.5×3.2 | | 5.7×5.0 |
|---------------------|---------|---------|------|---------|
| T max. (mm) | 1.5 | 1.5 | 2.0 | 2.0 |
| Rated Voltage (Vac) | 250 | 250 | 250 | 250 |
| Cap. / TC Code | X7R | X7R | X7R | X7R |
| 470pF | p185 | | | |
| 1000pF | p185 | | | |
| 2200pF | | p185 | | |
| 3300pF | | p185 | | |
| 4700pF | | | p185 | |
| 10000pF | | p185 | | |
| 22000pF | | p185 | | |
| 47000pF | | | p185 | |
| 0.10μF | | | | p185 |

GA3 Series Type GD Temperature Compensating Type

p00 ← Part Number List JIS: SL

| L×W (mm) | 4.5×2.0 |
|---------------------|---------|
| T max. (mm) | 1.0 |
| Rated Voltage (Vac) | 250 |
| Cap. / TC Code | SL |
| 10pF | p197 |
| 12pF | p197 |
| 15pF | p197 |
| 18pF | p197 |
| 22pF | p197 |
| 27pF | p197 |
| 33pF | p197 |
| 39pF | p197 |
| 47pF | p197 |
| 56pF | p197 |
| 68pF | p197 |
| 82pF | p197 |

GA3 Series Type GB High Dielectric Constant Type

p00 ← Part Number List EIA: X7R

| L×W (mm) | 5.7×5.0 | | | |
|---------------------|---------|------|------|------|
| T max. (mm) | 1.5 | 2.0 | 2.5 | 2.9 |
| Rated Voltage (Vac) | 250 | 250 | 250 | 250 |
| Cap. / TC Code | X7R | X7R | X7R | X7R |
| 10000pF | p191 | | | |
| 15000pF | p191 | | | |
| 22000pF | | p191 | | |
| 33000pF | | | p191 | |
| 47000pF | | | p191 | |
| 56000pF | | | | p191 |

GA3 Series Type GD High Dielectric Constant Type

p00 ← Part Number List EIA: X7R

| L×W (mm) | 4.5×2.0 | 4.5×3.2 | |
|---------------------|---------|---------|------|
| T max. (mm) | 1.5 | 1.5 | 2.0 |
| Rated Voltage (Vac) | 250 | 250 | 250 |
| Cap. / TC Code | X7R | X7R | X7R |
| 100pF | p198 | | |
| 150pF | p198 | | |
| 220pF | p198 | | |
| 330pF | p198 | | |
| 470pF | p198 | | |
| 680pF | p198 | | |
| 1000pF | p198 | | |
| 1500pF | p198 | | |
| 1800pF | | p198 | |
| 2200pF | | p198 | |
| 4700pF | | | p198 |

Capacitance Table

GA3 Series Type GF Temperature Compensating Type

p00 ← Part Number List JIS: SL

| | |
|---------------------|---------|
| L×W (mm) | 4.5×2.0 |
| T max. (mm) | 1.0 |
| Rated Voltage (Vac) | 250 |
| Cap. / TC Code | SL |
| 10pF | p209 |
| 12pF | p209 |
| 15pF | p209 |
| 18pF | p209 |
| 22pF | p209 |
| 27pF | p209 |
| 33pF | p209 |
| 39pF | p209 |
| 47pF | p209 |
| 56pF | p209 |
| 68pF | p209 |
| 82pF | p209 |

GA3 Series Type GF High Dielectric Constant Type

p00 ← Part Number List EIA: X7R

| L×W (mm) | 4.5×2.0 | | 5.7×2.8 | | 5.7×5.0 | |
|---------------------|---------|------|---------|------|---------|-----|
| T max. (mm) | 1.5 | 2.2 | 1.5 | 1.5 | 2.0 | 2.0 |
| Rated Voltage (Vac) | 250 | 250 | 250 | 250 | 250 | 250 |
| Cap. / TC Code | X7R | X7R | X7R | X7R | X7R | X7R |
| 100pF | p210 | | p210 | | | |
| 150pF | p210 | | p210 | | | |
| 220pF | | p210 | p210 | | | |
| 330pF | | p210 | p210 | | | |
| 470pF | p210 | | p210 | | | |
| 680pF | p210 | | p210 | | | |
| 1000pF | | p210 | p210 | | | |
| 1500pF | | | p210 | | | |
| 1800pF | | | | p210 | | |
| 2200pF | | | | p210 | | |
| 3300pF | | | | p210 | | |
| 4700pF | | | | | p210 | |

Capacitance Table

LLL Series High Dielectric Constant Type

p00 ← Part Number List EIA: X7R X7S X6S X5R

| L×W (mm) | 0.5×1.0 | | | 0.6×1.0 | 0.8×1.6 | | | | | | | | 1.25×2.0 | | | | | | | | | | |
|---------------------|---------|------|------|---------|---------|------|------|------|------|------|-----|------|----------|------|------|------|------|-----|------|------|------|------|------|
| T max. (mm) | 0.35 | | | 0.45 | 0.5 | | | | 0.55 | 0.6 | | | | 0.5 | | | | 0.7 | | | | | |
| Rated Voltage (Vdc) | 6.3 | 4 | | 4 | 25 | 16 | 10 | 4 | 4 | 50 | 25 | 16 | 10 | 4 | 50 | 25 | 16 | 10 | 6.3 | 4 | 50 | 25 | |
| Cap. / TC Code | X6S | X7S | X6S | X5R | X7R | X7R | X7R | X7S | X7S | X7R | X7R | X7R | X7R | X7S | X7R | X7R | X7R | X7R | X7R | X7S | X7R | X7R | |
| 2200pF | | | | | | | | | | p220 | | | | | | | | | | | | | |
| 4700pF | | | | | | | | | | p220 | | | | | | | | | | | | | |
| 10000pF | | | | | p220 | | | | | | | p220 | | | p220 | | | | | | | p220 | |
| 22000pF | | | | | | p220 | | | | | | p220 | | | | p220 | | | | | | p220 | |
| 47000pF | | | | | | | p220 | | | | | p220 | | | | | p220 | | | | | | p220 |
| 0.10μF | p220 | | | | | | | p220 | | | | | | p220 | | | | | | | | | p220 |
| 0.22μF | p220 | | | | | | | | p220 | | | | | | | | | | p220 | | | | |
| 0.47μF | | p220 | | | | | | | | | | | | | | | | | | p220 | | | |
| 1.0μF | | | p220 | | | | | | | | | | | | | | | | | | p220 | | |
| 2.2μF | | | | | | | | | p220 | | | | | | | | | | | | | | |
| 4.3μF | | | | p220 | | | | | | | | | | | | | | | | | | | |
| 4.7μF | | | | | | | | | | | | | | | | | | | | | | | |
| 10μF | | | | | | | | | | | | | | | | | | | | | | | |

Continued to the following table. ↗

| L×W (mm) | 1.25×2.0 | | | | 1.6×3.2 | | | | | | | | | | | | | | |
|---------------------|----------|------|------|------|---------|------|------|------|-----|------|------|------|------|-----|------|------|------|------|------|
| T max. (mm) | 0.7 | | 0.95 | | 0.5 | | | | 0.8 | | | | 1.25 | | | | | | |
| Rated Voltage (Vdc) | 10 | 16 | 10 | 4 | 50 | 25 | 16 | 10 | 50 | 25 | 16 | 10 | 6.3 | 50 | 25 | 16 | 10 | 6.3 | |
| Cap. / TC Code | X7R | X7R | X7R | X7S | X7R | X7R | X7R | X7R | X7R | X7R | X7R | X7R | X7R | X7R | X7R | X7R | X7R | X7R | X5R |
| 2200pF | | | | | | | | | | | | | | | | | | | |
| 4700pF | | | | | | | | | | | | | | | | | | | |
| 10000pF | | | | | p220 | | | | | p220 | | | | | | | | | |
| 22000pF | | | | | p220 | | | | | p220 | | | | | | | | | |
| 47000pF | | | | | | p220 | | | | p220 | | | | | | | | | |
| 0.10μF | | | | | | p220 | | | | | p220 | | | | p220 | | | | |
| 0.22μF | p220 | p220 | | | | | p220 | | | | p220 | | | | | p220 | | | |
| 0.47μF | | | p220 | | | | | p220 | | | | p220 | | | | p220 | | | |
| 1.0μF | | | | p220 | | | | | | | | p220 | | | | | p220 | | |
| 2.2μF | | | | | p220 | | | | | | | | p220 | | | | | p220 | |
| 4.3μF | | | | | | | | | | | | | | | | | | | |
| 4.7μF | | | | | | | | | | | | | | | | | | | p220 |
| 10μF | | | | | | | | | | | | | | | | | | | p220 |

LLA Series High Dielectric Constant Type

p00 ← Part Number List EIA: X7R X7S

| L×W (mm) | 1.6×0.8 | 2.0×1.25 | | | | | | | | | | |
|---------------------|---------|----------|------|------|------|------|------|------|------|------|------|------|
| T max. (mm) | 0.55 | 0.55 | | | | | 0.95 | | | | | |
| Rated Voltage (Vdc) | 4 | 25 | 16 | 10 | 6.3 | 4 | 25 | 16 | 10 | 6.3 | 4 | |
| Cap. / TC Code | X7S | X7R | X7R | X7R | X7R | X7S | X7R | X7R | X7R | X7R | X7S | |
| 10000pF | | p223 | | | | | p223 | | | | | |
| 22000pF | | p223 | | | | | p223 | | | | | |
| 47000pF | | | p223 | | | | | p223 | | | | |
| 0.10μF | p223 | | | p223 | | | | | p223 | | | |
| 0.22μF | p223 | | | | p223 | | | | | p223 | | |
| 0.47μF | p223 | | | | | p223 | | | | | p223 | |
| 1.0μF | | | | | | | p223 | | | | p223 | |
| 2.2μF | p223 | | | | | | | | | | | p223 |
| 4.7μF | | | | | | | p223 | | | | | |

Capacitance Table

LLM Series High Dielectric Constant Type

p00 ← Part Number List EIA: X7R X7S

| | | |
|---------------------|----------|------|
| L×W (mm) | 2.0×1.25 | |
| T max. (mm) | 0.55 | |
| Rated Voltage (Vdc) | 6.3 | 4 |
| Cap. / TC Code | X7R | X7S |
| 0.22μF | p229 | |
| 0.47μF | p229 | |
| 1.0μF | | p229 |

LLR Series High Dielectric Constant Type

p00 ← Part Number List EIA: X7S

| | | | | |
|---------------------|---------|------|------|------|
| L×W (mm) | 0.8×1.6 | | | |
| T max. (mm) | 0.55 | | | |
| Rated Voltage (Vdc) | 4 | | | |
| TC Code | X7S | | | |
| Cap. / ESR (mΩ) | 100 | 220 | 470 | 1000 |
| 1.0μF | p233 | p233 | p233 | p233 |

NFM Series

p00 ← Part Number List

| L×W (mm) | 1.0×0.5 | | | | | | | | 1.6×0.8 | | | | 2.0×1.25 | | | | | | 3.2×1.25 | 3.2×1.6 | | | 4.5×1.6 | | |
|---------------------|---------|------|------|------|------|------|------|-----|---------|-----|-----|-----|----------|------|------|----|-----|------|----------|---------|-----|-----|---------|-----------|--|
| | 0.35 | | 0.5 | | | | 0.65 | 0.7 | 0.7 | | 0.9 | | 0.95 | | | | | | 0.9 | 1.5 | | | 1.2 | | |
| Rated Voltage (Vdc) | 6.3 | 4 | 16 | 10 | 6.3 | 2.5 | 2.5 | 2.5 | 16 | 6.3 | 10 | 6.3 | 50 | 25 | 16 | 10 | 6.3 | 50 | 100 | 50 | 6.3 | 100 | 50 | 25 | |
| Cap. / TC Code | - | - | - | - | - | - | - | - | - | - | - | - | - | - | - | - | - | - | - | - | - | - | - | - | |
| 100pF | | | | | | | | | p237 | | | | | | | | | | | | | | | | |
| 220pF | | | | | | | | | p237 | | | | p237 | | | | | p237 | | | | | | | |
| 470pF | | | | | | | | | p237 | | | | p237 | | | | | p237 | | | | | | p237 | |
| 1000pF | | | | | | | | | p237 | | | | p237 | | | | | p237 | | | | | | p237 | |
| 2200pF | | | p237 | p237 | | | | | p237 | | | | p237 | | | | | p237 | | | | | | p237 | |
| 10000pF | | | | | | | | | | | | | | | | | | | p237 | p237 | | | | | |
| 15000pF | | | | | | | | | | | | | | | | | | | p237 | p237 | | | | | |
| 22000pF | | | p237 | p237 | | | | | p237 | | | | p237 | | | | | p237 | p237 | p237 | | | | p237 | |
| 47000pF | | | p237 | p237 | | | | | | | | | | | | | | | | | | | | | |
| 0.10μF | | | | p237 | p237 | | | | p237 | | | | | | p237 | | | | p237 | p237 | | | | | |
| 0.20μF | | | | | | | | | | | | | | | | | | | | | | | | | |
| 0.22μF | | | | p237 | p237 | | | | | | | | | | | | | | | | | | | | |
| 0.47μF | p237 | p237 | | | | | | | | | | | | | | | | | | | | | | | |
| 1.0μF | | p237 | | | | | | | | | | | p237 | p237 | | | | p237 | p237 | | | | | | |
| 1.5μF | | | | | | | | | | | | | | | | | | | | | | | | p237 p237 | |
| 2.2μF | | | | | | | | | | | | | | | | | | | | | | | | | |
| 4.3μF | | | | | | p237 | | | | | | | | | | | | | | | | | | | |
| 4.7μF | | | | | | | | | | | | | | | | | | | | | | | | p237 | |
| 7.5μF | | | | | | | | | | | | | | | | | | | | | | | | | |
| 9.1μF | | | | | | | | | | | | | | | | | | | | | | | | | |
| 10μF | | | | | | | | | | | | | | | | | | | | | | | | p237 | |
| 27μF | | | | | | | | | | | | | | | | | | | | | | | | p237 | |

Capacitance Table

KRM Series High Dielectric Constant Type

p00 ← Part Number List EIA: X7R X7S X6S X5R

| L×W (mm) | 2.2×1.25 | | | | | 3.5×1.7 | | | | | 3.6×1.7 | 3.7×1.85 | 6.1×5.3 | | | | | | | | | | | | |
|---------------------|----------|------|------|------|-----|---------|-----|-----|-----|-----|---------|----------|---------|-----|-----|-----|-----|-----|-----|-----|-----|-----|------|----------------|-----|
| T max. (mm) | 1.9 | | 2.0 | | | 2.0 | | 2.9 | | | 2.9 | | 2.9 | | 3.0 | | | | | | | | | | 3.9 |
| Rated Voltage (Vdc) | 25 | 16 | 25 | | | 25 | 100 | 50 | 35 | 25 | 50 | 100 | 1000 | 630 | 450 | 250 | 100 | 63 | 50 | 35 | 25 | 100 | | | |
| Cap. / TC Code | X5R | X5R | X7S | X6S | X5R | X5R | X7R | X7R | X6S | X6S | X7R | X7R | X7R | X7R | X7R | X7R | X7R | X7R | X7R | X7R | X7R | X7R | X7R | | |
| 68000pF | | | | | | | | | | | | | | | | | | | | | | | p241 | | |
| 0.10μF | | | | | | | | | | | | | | | | | | | | | | | | p241 | |
| 0.15μF | | | | | | | | | | | | | | | | | | | | | | | | p241 | |
| 0.22μF | | | | | | | | | | | | | | | | | | | | | | | | p241 | |
| 0.33μF | | | | | | | | | | | | | | | | | | | | | | | | p241 | |
| 0.47μF | | | | | | | | | | | | | | | | | | | | | | | | p241 | |
| 0.68μF | | | | | | | | | | | | | | | | | | | | | | | | p241 | |
| 1.0μF | | | | | | | | | | | p241 | | | | | | | | | | | | | p241 | |
| 1.5μF | | | | | | | | | | | | | | | | | | | | | | | | | |
| 2.2μF | | | | | | | | | | | | | | | | | | | | | | | | p241 p241 | |
| 4.7μF | | | | | | | | | | | | | | | | | | | | | | | | p241 | |
| 6.8μF | | | | | | | | | | | | | | | | | | | | | | | | p241 p241 p241 | |
| 10μF | p241 | p241 | p241 | p241 | | | | | | | | | | | | | | | | | | | | p241 | |
| 15μF | | | | | | | | | | | | | | | | | | | | | | | | p241 p241 | |
| 17μF | | | | | | | | | | | | | | | | | | | | | | | | | |
| 22μF | | | | | | | | | | | | | | | | | | | | | | | | p241 | |
| 33μF | | | | | | | | | | | | | | | | | | | | | | | | | |
| 47μF | | | | | | | | | | | | | | | | | | | | | | | | | |
| 68μF | | | | | | | | | | | | | | | | | | | | | | | | | |
| 100μF | | | | | | | | | | | | | | | | | | | | | | | | | |

Continued to the following table. ↗

| L×W (mm) | 6.1×5.3 | | | | | | | | | | | | | | | | | | | |
|---------------------|---------|-----|-----|-----|-----|------|-----|-----|-----|-----|-----|-----|-----|-----|-----|-----|-----|-----|-----|--|
| T max. (mm) | 3.9 | | | | | 5.0 | | | | | | | 6.7 | | | | | | | |
| Rated Voltage (Vdc) | 63 | 50 | 35 | 25 | | 1000 | 630 | 450 | 250 | 100 | 50 | 35 | 25 | 100 | 63 | 50 | 35 | 25 | | |
| Cap. / TC Code | X7R | X7R | X7R | X7R | X7S | X7R | X7R | X7R | X7R | X7R | X7R | X7R | X7R | X7R | X7R | X7R | X7R | X7R | X7S | |
| 68000pF | | | | | | | | | | | | | | | | | | | | |
| 0.10μF | | | | | | | | | | | | | | | | | | | | |
| 0.15μF | | | | | | | | | | | | | | | | | | | | |
| 0.22μF | | | | | | | | | | | | | | | | | | | | |
| 0.33μF | | | | | | | | | | | | | | | | | | | | |
| 0.47μF | | | | | | | | | | | | | | | | | | | | |
| 0.68μF | | | | | | | | | | | | | | | | | | | | |
| 1.0μF | | | | | | | | | | | | | | | | | | | | |
| 1.5μF | | | | | | | | | | | | | | | | | | | | |
| 2.2μF | | | | | | | | | | | | | | | | | | | | |
| 4.7μF | | | | | | | | | | | | | | | | | | | | |
| 6.8μF | | | | | | | | | | | | | | | | | | | | |
| 10μF | p241 | | | | | | | | | | | | | | | | | | | |
| 15μF | | | | | | | | | | | | | | | | | | | | |
| 17μF | | | | | | | | | | | | | | | | | | | | |
| 22μF | | | | | | | | | | | | | | | | | | | | |
| 33μF | | | | | | | | | | | | | | | | | | | | |
| 47μF | | | | | | | | | | | | | | | | | | | | |
| 68μF | | | | | | | | | | | | | | | | | | | | |
| 100μF | | | | | | | | | | | | | | | | | | | | |

Capacitance Table

KR3 Series High Dielectric Constant Type

p00 ← Part Number List EIA: X7T

| L×W (mm) | 6.1×5.3 | | | | | | | | | | |
|---------------------|---------|------|------|------|------|------|------|------|------|------|------|
| T max. (mm) | 3.0 | | | 3.9 | | | 5.0 | | 6.7 | | |
| Rated Voltage (Vdc) | 630 | 450 | 250 | 630 | 450 | 250 | 450 | 250 | 630 | 450 | 250 |
| Cap. / TC Code | X7T | X7T | X7T | X7T | X7T | X7T | X7T | X7T | X7T | X7T | X7T |
| 0.10μF | p245 | | | | | | | | | | |
| 0.15μF | p245 | | | | | | | | | | |
| 0.22μF | | p245 | | p245 | | | | | | | |
| 0.27μF | | | | p245 | | | | | | | |
| 0.33μF | | p245 | | | | | | | | | |
| 0.47μF | | p245 | p245 | | | | | | p245 | | |
| 0.56μF | | | | | p245 | | | | p245 | | |
| 0.68μF | | | p245 | | | | p245 | | | | |
| 1.0μF | | | | | | p245 | p245 | | | | |
| 1.2μF | | | | | | | | | | p245 | |
| 1.5μF | | | | | | | | p245 | | | |
| 2.2μF | | | | | | | | | | | p245 |

GMA Series High Dielectric Constant Type

p00 ← Part Number List JIS: R B EIA: X7R X5R

| L×W (mm) | 0.38×0.38 | | | 0.5×0.5 | | | | | | 0.8×0.8 | | | | | | | | | |
|---------------------|-----------|------|------|---------|------|------|------|------|------|---------|----|------|------|------|------|------|------|-----|-----------|
| T max. (mm) | 0.35 | | | 0.4 | | | | | | 0.6 | | | | | | | | | |
| Rated Voltage (Vdc) | 10 | | | 100 | 25 | 10 | | | 6.3 | 100 | 25 | 10 | | | 6.3 | | | | |
| Cap. / TC Code | X7R | R | B | X7R | X7R | B | X7R | R | B | X5R | B | X7R | X7R | B | X7R | R | B | X5R | B |
| 100pF | | | | p251 | | | | | | | | | | | | | | | |
| 150pF | | | | p251 | | | | | | | | | | | | | | | |
| 220pF | | | | p251 | | | | | | | | | | | | | | | |
| 330pF | | | | p251 | | | | | | | | | | | | | | | |
| 470pF | | | | p251 | | | | | | | | | | | | | | | |
| 680pF | | | | p251 | | | | | | | | | | | | | | | |
| 1000pF | p251 | p251 | p251 | p251 | | | | | | | | | | | | | | | |
| 1500pF | p251 | p251 | p251 | | p251 | p251 | | | | | | p251 | | | | | | | |
| 1800pF | p251 | p251 | p251 | | | | | | | | | | | | | | | | |
| 2200pF | | | | | p251 | p251 | | | | | | p251 | | | | | | | |
| 3300pF | | | | | p251 | p251 | | | | | | p251 | | | | | | | |
| 4700pF | | | | | p251 | p251 | | | | | | p251 | | | | | | | |
| 6800pF | | | | | | | p251 | p251 | p251 | | | p251 | | | | | | | |
| 10000pF | p251 | p251 | | | | | p251 | p251 | p251 | | | | p251 | p251 | | | | | |
| 15000pF | | | | | | | p251 | p251 | p251 | | | | p251 | p251 | | | | | |
| 22000pF | | | | | | | p251 | p251 | p251 | | | | p251 | p251 | | | | | |
| 33000pF | | | | | | | | | | | | | | | p251 | p251 | p251 | | |
| 47000pF | | | | | | | | | | | | | | | p251 | p251 | p251 | | |
| 68000pF | | | | | | | | | | | | | | | p251 | p251 | p251 | | |
| 0.10μF | | | | | | | | | | | | p251 | p251 | | | | | | |
| 0.47μF | | | | | | | | | | | | | | | | | | | p251 p251 |

Capacitance Table

GMD Series High Dielectric Constant Type

p00 ← Part Number List JIS: R B EIA: X7R X5R

| L×W (mm) | 0.6×0.3 | | | | | | | | | | 1.0×0.5 | | | | | | | | | | | | |
|---------------------|---------|------|------|------|------|------|------|------|------|------|---------|------|------|------|------|------|------|------|------|------|------|------|--|
| T max. (mm) | 0.33 | | | | | | | | | | 0.55 | | | | | | | | | | | | |
| Rated Voltage (Vdc) | 25 | | | 16 | | | 10 | | | 6.3 | | 50 | | | 25 | | | 16 | | | 10 | | |
| Cap. / TC Code | X7R | R | B | X7R | R | B | X7R | R | B | X5R | B | X7R | R | B | X7R | R | B | X7R | R | B | X5R | B | |
| 100pF | p257 | p257 | p257 | | | | | | | | | | | | | | | | | | | | |
| 120pF | p257 | p257 | p257 | | | | | | | | | | | | | | | | | | | | |
| 150pF | p257 | p257 | p257 | | | | | | | | | | | | | | | | | | | | |
| 180pF | p257 | p257 | p257 | | | | | | | | | | | | | | | | | | | | |
| 220pF | p257 | p257 | p257 | | | | | | | | | p257 | p257 | p258 | | | | | | | | | |
| 270pF | p257 | p257 | p257 | | | | | | | | | p257 | p258 | p258 | | | | | | | | | |
| 330pF | p257 | p257 | p257 | | | | | | | | | p257 | p258 | p258 | | | | | | | | | |
| 390pF | p257 | p257 | p257 | | | | | | | | | p257 | p258 | p258 | | | | | | | | | |
| 470pF | p257 | p257 | p257 | | | | | | | | | p257 | p258 | p258 | | | | | | | | | |
| 560pF | p257 | p257 | p257 | | | | | | | | | p257 | p258 | p258 | | | | | | | | | |
| 680pF | p257 | p257 | p257 | | | | | | | | | p257 | p258 | p258 | | | | | | | | | |
| 820pF | p257 | p257 | p257 | | | | | | | | | p257 | p258 | p258 | | | | | | | | | |
| 1000pF | p257 | p257 | p257 | | | | | | | | | p257 | p258 | p258 | | | | | | | | | |
| 1200pF | p257 | p257 | p257 | | | | | | | | | p257 | p258 | p258 | | | | | | | | | |
| 1500pF | p257 | p257 | p257 | | | | | | | | | p257 | p258 | p258 | | | | | | | | | |
| 1800pF | | | | p257 | p257 | p257 | | | | | | p257 | p258 | p258 | | | | | | | | | |
| 2200pF | | | | p257 | p257 | p257 | | | | | | p257 | p258 | p258 | | | | | | | | | |
| 2700pF | | | | p257 | p257 | p257 | | | | | | p257 | p258 | p258 | | | | | | | | | |
| 3300pF | | | | p257 | p257 | p257 | | | | | | p257 | p258 | p258 | | | | | | | | | |
| 3900pF | | | | | | | p257 | p257 | p257 | | | p257 | p258 | p258 | | | | | | | | | |
| 4700pF | | | | | | | p257 | p257 | p257 | | | p257 | p258 | p258 | | | | | | | | | |
| 5600pF | | | | | | | p257 | p257 | p257 | | | | | | p258 | p258 | p258 | | | | | | |
| 6800pF | | | | | | | p257 | p257 | p257 | | | | | | p258 | p258 | p258 | | | | | | |
| 8200pF | | | | | | | p257 | p257 | p257 | | | | | | p258 | p258 | p258 | | | | | | |
| 10000pF | | | | | | | p257 | p257 | p257 | | | | | | p258 | p258 | p258 | | | | | | |
| 12000pF | | | | | | | | | | | | | | | p258 | p258 | p258 | | | | | | |
| 15000pF | | | | | | | | | | | | | | | p258 | p258 | p258 | | | | | | |
| 18000pF | | | | | | | | | | | | | | | p258 | p258 | p258 | | | | | | |
| 22000pF | | | | | | | | | | | | | | | p258 | p258 | p258 | | | | | | |
| 27000pF | | | | | | | | | | | | | | | p258 | p258 | p258 | | | | | | |
| 33000pF | | | | | | | | | | | | | | | p258 | p258 | p258 | | | | | | |
| 39000pF | | | | | | | | | | | | | | | p258 | p258 | p258 | | | | | | |
| 47000pF | | | | | | | | | | | | | | | p258 | p258 | p258 | | | | | | |
| 56000pF | | | | | | | | | | p257 | p257 | | | | | | | p258 | p258 | p258 | | | |
| 68000pF | | | | | | | | | | p257 | p257 | | | | | | | p258 | p258 | p258 | | | |
| 82000pF | | | | | | | | | | p257 | p257 | | | | | | | p258 | p258 | p258 | | | |
| 0.10μF | | | | | | | | | | p257 | p257 | | | | | | | p258 | p258 | p258 | | | |
| 0.12μF | | | | | | | | | | | | | | | | | | | | | p258 | p258 | |
| 0.15μF | | | | | | | | | | | | | | | | | | | | | p258 | p258 | |
| 0.18μF | | | | | | | | | | | | | | | | | | | | | p258 | p258 | |
| 0.22μF | | | | | | | | | | | | | | | | | | | | | p258 | p258 | |
| 0.27μF | | | | | | | | | | | | | | | | | | | | | p258 | p258 | |
| 0.33μF | | | | | | | | | | | | | | | | | | | | | p258 | p258 | |
| 0.39μF | | | | | | | | | | | | | | | | | | | | | p258 | p258 | |
| 0.47μF | | | | | | | | | | | | | | | | | | | | | p258 | p258 | |

Search Capacitors

Specifications and Test Methods, Package, Chart of Characteristic Data, please refer to the search web page.
<https://www.murata.com/en-global/products/capacitor>

Links are provided to the product detail pages on the web, and are shown below in the product number table from the PDF version of the catalog which is available on the web.

GRM Series Temperature Compensating

0.4x0.2mm

| T max. | Rated Voltage | TC Code | Cap. | Tol. | Part Number |
|--------|---------------|---------|--------|---------|--------------------|
| 0.22mm | 50Vdc | COG | 0.20pF | ±0.05pF | GRM0225C1HR20WA03# |
| | | | | ±0.1pF | GRM0225C1HR20BA03# |
| | | | 0.30pF | ±0.05pF | GRM0225C1HR30WA03# |
| | | | | ±0.1pF | GRM0225C1HR30BA03# |
| | | | 0.40pF | ±0.05pF | GRM0225C1HR40WA03# |
| | | | | ±0.1pF | GRM0225C1HR40BA03# |
| | | | 0.50pF | ±0.05pF | GRM0225C1HR50WA03# |
| | | | | ±0.1pF | GRM0225C1HR50BA03# |



Status and Features Icons

The status and features of products can be checked at once. When ? is clicked, a description of each icon will be displayed

Stock Check (Where to buy)

Some products can request free samples. Reference inventory information from agents and web-based companies.

Data Sheet

The product details page can be output in PDF.

How to read part numbers

Describes the meaning of the part number

Series Information

This links to the introduction page of each series.

Detailed Specifications Sheet

- Rated value
- Specifications and Test Methods
- Package
- Caution, Notice (Storage, Soldering and Mounting,etc.)

Characteristics Data

The following characteristics data of the main products can be acquired.

- SPICE Netlist (mod type)
- S parameter (S2P type)
- Reliability Test Data *Typical data

- Shape (Dimensions)
- Rated Values

- Specification by Packaging Code/ Minimum Order Quantity
- Weight (1 pc/ø180mm reel)

Chart of Characteristic Data

The main products published characteristic data.

- Frequency characteristics (ESR, Impedance)
- DC bias characteristics
- AC voltage characteristics
- Capacitance - temperature characteristics
- Calorific property by ripple current

Design Tools SimSurfing

The SimSurfing design tools are useful for displaying the graph, downloading CSV data and overwriting the product number graph.

Chip Multilayer Ceramic Capacitors for General Purpose

GRM Series  [WEB](#)

This is Murata primary products renowned for both small size and large capacitance value with latest advanced technology.

Features

① Achieves large-capacity and small size in a multilayer structure.

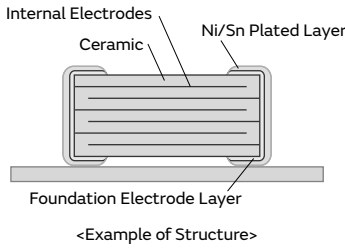

"Thin Layer Technology" for thinner layers

01005 size
 automatic lead pencil (0.5mm)

"Fine Particle Technology" for finer particles

"High Precision Lamination Technology" for more accuracy

ceramic thickness: 1µm
 Internal electrode thickness: 0.7µm

ceramic thickness: 0.5µm
 Internal electrode thickness: 0.4µm

② Sn plating is applied to the external electrodes; excellent solderability.

③ High reliability with no polarity.

| | Ceramic Capacitors | Tantalum Capacitor | Aluminum Electrolytic Capacitor | Conductive Polymer Capacitor |
|--|--------------------|--------------------|---------------------------------|------------------------------|
| Price | ○ | ○ | ◎ | ○ |
| Comparison between Impedance Frequency Characteristics | ◎ | △ | △ | ○ |
| Capacitance temperature characteristics | ○ | ◎ | ○ | ○ |
| DC breakdown voltage | ◎ | △ | △ | △ |
| Polarity | No | Yes | Yes | Yes |
| Pulse response | ◎ | △ | △ | ○ |
| Allowable ripple current | ◎ | △ | △ | △ |
| Reliability | ◎ | ○ | ○ | ○ |
| DC bias characteristics | △ | ◎ | ◎ | ◎ |

◎: Particularly excellent ○: Excellent △: Inferior

Specifications

| | |
|-------------------|--|
| Size (mm) | 0.25×0.125mm to 5.7×5.0mm |
| Rated Voltage | 2.5Vdc to 3150Vdc |
| Capacitance | 0.10pF to 330µF |
| Main Applications | 1. Rated voltage 100V Max. High Dielectric Constant Type . . . For decoupling and smoothing circuits Temperature Compensating Type . . . For tuning circuits, oscillating circuits, and high frequency filter circuits 2. Rated voltage 200V min. High Dielectric Constant Type . . . For clamp snubber circuits and smoothing circuits Temperature Compensating Type . . . Power supply damper snubber |

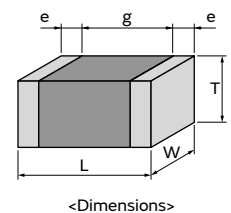

This catalog contains only a portion of the product lineup.
 Please refer to the capacitor search tool on the Murata Web site for details.

GRM Series Temperature Compensating Type Part Number List

0.4×0.2mm

| T max. | Rated Voltage | TC Code | Cap. | Tol. | Part Number |
|---------|--------------------|--------------------|--------|---------|--------------------|
| 0.22mm | 50Vdc | COG | 0.20pF | ±0.05pF | GRM0225C1HR20WA03# |
| | | | | ±0.1pF | GRM0225C1HR20BA03# |
| | | | 0.30pF | ±0.05pF | GRM0225C1HR30WA03# |
| | | | | ±0.1pF | GRM0225C1HR30BA03# |
| | | | 0.40pF | ±0.05pF | GRM0225C1HR40WA03# |
| | | | | ±0.1pF | GRM0225C1HR40BA03# |
| | | | 0.50pF | ±0.05pF | GRM0225C1HR50WA03# |
| | | | | ±0.1pF | GRM0225C1HR50BA03# |
| | | | 0.60pF | ±0.05pF | GRM0225C1HR60WA03# |
| | | | | ±0.1pF | GRM0225C1HR60BA03# |
| | | | 0.70pF | ±0.05pF | GRM0225C1HR70WA03# |
| | | | | ±0.1pF | GRM0225C1HR70BA03# |
| | | | 0.80pF | ±0.05pF | GRM0225C1HR80WA03# |
| | | | | ±0.1pF | GRM0225C1HR80BA03# |
| | | | 0.90pF | ±0.05pF | GRM0225C1HR90WA03# |
| | | | | ±0.1pF | GRM0225C1HR90BA03# |
| | | | 1.0pF | ±0.05pF | GRM0225C1H1R0WA03# |
| | | | | ±0.1pF | GRM0225C1H1R0BA03# |
| | | | | ±0.25pF | GRM0225C1H1R0CA03# |
| | | | 1.1pF | ±0.05pF | GRM0225C1H1R1WA03# |
| | | | | ±0.1pF | GRM0225C1H1R1BA03# |
| | | | | ±0.25pF | GRM0225C1H1R1CA03# |
| | | | 1.2pF | ±0.05pF | GRM0225C1H1R2WA03# |
| | | | | ±0.1pF | GRM0225C1H1R2BA03# |
| | | | | ±0.25pF | GRM0225C1H1R2CA03# |
| | | | 1.3pF | ±0.05pF | GRM0225C1H1R3WA03# |
| | | | | ±0.1pF | GRM0225C1H1R3BA03# |
| | | | | ±0.25pF | GRM0225C1H1R3CA03# |
| | | | 1.4pF | ±0.05pF | GRM0225C1H1R4WA03# |
| | | | | ±0.1pF | GRM0225C1H1R4BA03# |
| | | | | ±0.25pF | GRM0225C1H1R4CA03# |
| | | | 1.5pF | ±0.05pF | GRM0225C1H1R5WA03# |
| | | | | ±0.1pF | GRM0225C1H1R5BA03# |
| | | | | ±0.25pF | GRM0225C1H1R5CA03# |
| | | | 1.6pF | ±0.05pF | GRM0225C1H1R6WA03# |
| | | | | ±0.1pF | GRM0225C1H1R6BA03# |
| | | | | ±0.25pF | GRM0225C1H1R6CA03# |
| | | | 1.7pF | ±0.05pF | GRM0225C1H1R7WA03# |
| | | | | ±0.1pF | GRM0225C1H1R7BA03# |
| | | | | ±0.25pF | GRM0225C1H1R7CA03# |
| | | | 1.8pF | ±0.05pF | GRM0225C1H1R8WA03# |
| | | | | ±0.1pF | GRM0225C1H1R8BA03# |
| | | | | ±0.25pF | GRM0225C1H1R8CA03# |
| | | | 1.9pF | ±0.05pF | GRM0225C1H1R9WA03# |
| | | | | ±0.1pF | GRM0225C1H1R9BA03# |
| | | | | ±0.25pF | GRM0225C1H1R9CA03# |
| | | | 2.0pF | ±0.05pF | GRM0225C1H2R0WA03# |
| | | | | ±0.1pF | GRM0225C1H2R0BA03# |
| ±0.25pF | GRM0225C1H2R0CA03# | | | | |
| 2.1pF | ±0.05pF | GRM0225C1H2R1WA03# | | | |
| | ±0.1pF | GRM0225C1H2R1BA03# | | | |
| | ±0.25pF | GRM0225C1H2R1CA03# | | | |

| T max. | Rated Voltage | TC Code | Cap. | Tol. | Part Number |
|--------|---------------|--------------------|-------|---------|--------------------|
| 0.22mm | 50Vdc | COG | 2.2pF | ±0.05pF | GRM0225C1H2R2WA03# |
| | | | | ±0.1pF | GRM0225C1H2R2BA03# |
| | | | | ±0.25pF | GRM0225C1H2R2CA03# |
| | | | 2.3pF | ±0.05pF | GRM0225C1H2R3WA03# |
| | | | | ±0.1pF | GRM0225C1H2R3BA03# |
| | | | | ±0.25pF | GRM0225C1H2R3CA03# |
| | | | 2.4pF | ±0.05pF | GRM0225C1H2R4WA03# |
| | | | | ±0.1pF | GRM0225C1H2R4BA03# |
| | | | | ±0.25pF | GRM0225C1H2R4CA03# |
| | | | 2.5pF | ±0.05pF | GRM0225C1H2R5WA03# |
| | | | | ±0.1pF | GRM0225C1H2R5BA03# |
| | | | | ±0.25pF | GRM0225C1H2R5CA03# |
| | | | 2.6pF | ±0.05pF | GRM0225C1H2R6WA03# |
| | | | | ±0.1pF | GRM0225C1H2R6BA03# |
| | | | | ±0.25pF | GRM0225C1H2R6CA03# |
| | | | 2.7pF | ±0.05pF | GRM0225C1H2R7WA03# |
| | | | | ±0.1pF | GRM0225C1H2R7BA03# |
| | | | | ±0.25pF | GRM0225C1H2R7CA03# |
| | | | 2.8pF | ±0.05pF | GRM0225C1H2R8WA03# |
| | | | | ±0.1pF | GRM0225C1H2R8BA03# |
| | | | | ±0.25pF | GRM0225C1H2R8CA03# |
| | | | 2.9pF | ±0.05pF | GRM0225C1H2R9WA03# |
| | | | | ±0.1pF | GRM0225C1H2R9BA03# |
| | | | | ±0.25pF | GRM0225C1H2R9CA03# |
| | | | 3.0pF | ±0.05pF | GRM0225C1H3R0WA03# |
| | | | | ±0.1pF | GRM0225C1H3R0BA03# |
| | | | | ±0.25pF | GRM0225C1H3R0CA03# |
| | | | 3.1pF | ±0.05pF | GRM0225C1H3R1WA03# |
| | | | | ±0.1pF | GRM0225C1H3R1BA03# |
| | | | | ±0.25pF | GRM0225C1H3R1CA03# |
| | | | 3.2pF | ±0.05pF | GRM0225C1H3R2WA03# |
| | | | | ±0.1pF | GRM0225C1H3R2BA03# |
| | | | | ±0.25pF | GRM0225C1H3R2CA03# |
| | | | 3.3pF | ±0.05pF | GRM0225C1H3R3WA03# |
| | | | | ±0.1pF | GRM0225C1H3R3BA03# |
| | | | | ±0.25pF | GRM0225C1H3R3CA03# |
| | | | 3.4pF | ±0.05pF | GRM0225C1H3R4WA03# |
| | | | | ±0.1pF | GRM0225C1H3R4BA03# |
| | | | | ±0.25pF | GRM0225C1H3R4CA03# |
| | | | 3.5pF | ±0.05pF | GRM0225C1H3R5WA03# |
| | | | | ±0.1pF | GRM0225C1H3R5BA03# |
| | | | | ±0.25pF | GRM0225C1H3R5CA03# |
| | | | 3.6pF | ±0.05pF | GRM0225C1H3R6WA03# |
| | | | | ±0.1pF | GRM0225C1H3R6BA03# |
| | | | | ±0.25pF | GRM0225C1H3R6CA03# |
| | | | 3.7pF | ±0.05pF | GRM0225C1H3R7WA03# |
| | | | | ±0.1pF | GRM0225C1H3R7BA03# |
| | | | | ±0.25pF | GRM0225C1H3R7CA03# |
| 3.8pF | ±0.05pF | GRM0225C1H3R8WA03# | | | |
| | ±0.1pF | GRM0225C1H3R8BA03# | | | |
| | ±0.25pF | GRM0225C1H3R8CA03# | | | |
| 3.9pF | ±0.05pF | GRM0225C1H3R9WA03# | | | |
| | ±0.1pF | GRM0225C1H3R9BA03# | | | |
| | ±0.25pF | GRM0225C1H3R9CA03# | | | |

Part number # indicates the package specification code.

- GRM
- GR3
- GRJ
- GR4
- GR7
- GJM
- GQM
- GA2
- GA3 GB
- GA3 GD
- GA3 GF
- LLL
- LLA
- LLM
- LLR
- NFM
- KRM
- KR3
- GMA
- GMD
- ⚠Caution /Notice

GRM Series Temperature Compensating Type Part Number List

(→ 0.4×0.2mm)

| T max. | Rated Voltage | TC Code | Cap. | Tol. | Part Number | T max. | Rated Voltage | TC Code | Cap. | Tol. | Part Number | |
|--------|---------------|---------|--------|--------------------|--------------------|--------|---------------|---------|--------------------|---------|--------------------|--------------------|
| 0.22mm | 50Vdc | COG | 4.0pF | ±0.05pF | GRM0225C1H4R0WA03# | 0.22mm | 50Vdc | COG | 5.6pF | ±0.1pF | GRM0225C1H5R6BA03# | |
| | | | | ±0.1pF | GRM0225C1H4R0BA03# | | | | | ±0.25pF | GRM0225C1H5R6CA03# | |
| | | | | ±0.25pF | GRM0225C1H4R0CA03# | | | | | ±0.5pF | GRM0225C1H5R6DA03# | |
| | | | 4.1pF | ±0.05pF | GRM0225C1H4R1WA03# | | | | 5.7pF | ±0.05pF | GRM0225C1H5R7WA03# | |
| | | | | ±0.1pF | GRM0225C1H4R1BA03# | | | | | ±0.1pF | GRM0225C1H5R7BA03# | |
| | | | | ±0.25pF | GRM0225C1H4R1CA03# | | | | | ±0.25pF | GRM0225C1H5R7CA03# | |
| | | | 4.2pF | ±0.05pF | GRM0225C1H4R2WA03# | | | | 5.8pF | ±0.05pF | GRM0225C1H5R8WA03# | |
| | | | | ±0.1pF | GRM0225C1H4R2BA03# | | | | | ±0.1pF | GRM0225C1H5R8BA03# | |
| | | | | ±0.25pF | GRM0225C1H4R2CA03# | | | | | ±0.25pF | GRM0225C1H5R8CA03# | |
| | | | 4.3pF | ±0.05pF | GRM0225C1H4R3WA03# | | | | 5.9pF | ±0.05pF | GRM0225C1H5R9WA03# | |
| | | | | ±0.1pF | GRM0225C1H4R3BA03# | | | | | ±0.1pF | GRM0225C1H5R9BA03# | |
| | | | | ±0.25pF | GRM0225C1H4R3CA03# | | | | | ±0.25pF | GRM0225C1H5R9CA03# | |
| | | | 4.4pF | ±0.05pF | GRM0225C1H4R4WA03# | | | | 6.0pF | ±0.05pF | GRM0225C1H6R0WA03# | |
| | | | | ±0.1pF | GRM0225C1H4R4BA03# | | | | | ±0.1pF | GRM0225C1H6R0BA03# | |
| | | | | ±0.25pF | GRM0225C1H4R4CA03# | | | | | ±0.25pF | GRM0225C1H6R0CA03# | |
| | | | 4.5pF | ±0.05pF | GRM0225C1H4R5WA03# | | | | 6.1pF | ±0.05pF | GRM0225C1H6R1WA03# | |
| | | | | ±0.1pF | GRM0225C1H4R5BA03# | | | | | ±0.1pF | GRM0225C1H6R1BA03# | |
| | | | | ±0.25pF | GRM0225C1H4R5CA03# | | | | | ±0.25pF | GRM0225C1H6R1CA03# | |
| | | | 4.6pF | ±0.05pF | GRM0225C1H4R6WA03# | | | | 6.2pF | ±0.05pF | GRM0225C1H6R2WA03# | |
| | | | | ±0.1pF | GRM0225C1H4R6BA03# | | | | | ±0.1pF | GRM0225C1H6R2BA03# | |
| | | | | ±0.25pF | GRM0225C1H4R6CA03# | | | | | ±0.25pF | GRM0225C1H6R2CA03# | |
| | | | 4.7pF | ±0.05pF | GRM0225C1H4R7WA03# | | | | 6.3pF | ±0.05pF | GRM0225C1H6R3WA03# | |
| | | | | ±0.1pF | GRM0225C1H4R7BA03# | | | | | ±0.1pF | GRM0225C1H6R3BA03# | |
| | | | | ±0.25pF | GRM0225C1H4R7CA03# | | | | | ±0.25pF | GRM0225C1H6R3CA03# | |
| | | | 4.8pF | ±0.05pF | GRM0225C1H4R8WA03# | | | | 6.4pF | ±0.05pF | GRM0225C1H6R4WA03# | |
| | | | | ±0.1pF | GRM0225C1H4R8BA03# | | | | | ±0.1pF | GRM0225C1H6R4BA03# | |
| | | | | ±0.25pF | GRM0225C1H4R8CA03# | | | | | ±0.25pF | GRM0225C1H6R4CA03# | |
| | | | 4.9pF | ±0.05pF | GRM0225C1H4R9WA03# | | | | 6.5pF | ±0.05pF | GRM0225C1H6R5WA03# | |
| | | | | ±0.1pF | GRM0225C1H4R9BA03# | | | | | ±0.1pF | GRM0225C1H6R5BA03# | |
| | | | | ±0.25pF | GRM0225C1H4R9CA03# | | | | | ±0.25pF | GRM0225C1H6R5CA03# | |
| | | | 5.0pF | ±0.05pF | GRM0225C1H5R0WA03# | | | | 6.6pF | ±0.05pF | GRM0225C1H6R6WA03# | |
| | | | | ±0.1pF | GRM0225C1H5R0BA03# | | | | | ±0.1pF | GRM0225C1H6R6BA03# | |
| | | | | ±0.25pF | GRM0225C1H5R0CA03# | | | | | ±0.25pF | GRM0225C1H6R6CA03# | |
| | | | 5.1pF | ±0.05pF | GRM0225C1H5R1WA03# | | | | 6.7pF | ±0.05pF | GRM0225C1H6R7WA03# | |
| | | | | ±0.1pF | GRM0225C1H5R1BA03# | | | | | ±0.1pF | GRM0225C1H6R7BA03# | |
| | | | | ±0.25pF | GRM0225C1H5R1CA03# | | | | | ±0.25pF | GRM0225C1H6R7CA03# | |
| | | | 5.2pF | ±0.05pF | GRM0225C1H5R2WA03# | | | | 6.8pF | ±0.05pF | GRM0225C1H6R8WA03# | |
| | | | | ±0.1pF | GRM0225C1H5R2BA03# | | | | | ±0.1pF | GRM0225C1H6R8BA03# | |
| | | | | ±0.25pF | GRM0225C1H5R2CA03# | | | | | ±0.25pF | GRM0225C1H6R8CA03# | |
| | | | 5.3pF | ±0.05pF | GRM0225C1H5R3WA03# | | | | 6.9pF | ±0.05pF | GRM0225C1H6R9WA03# | |
| | | | | ±0.1pF | GRM0225C1H5R3BA03# | | | | | ±0.1pF | GRM0225C1H6R9BA03# | |
| | | | | ±0.25pF | GRM0225C1H5R3CA03# | | | | | ±0.25pF | GRM0225C1H6R9CA03# | |
| | | | 5.4pF | ±0.05pF | GRM0225C1H5R4WA03# | | | | | ±0.5pF | GRM0225C1H5R5DA03# | |
| | | | | ±0.1pF | GRM0225C1H5R4BA03# | | | | | 5.6pF | ±0.05pF | GRM0225C1H5R6WA03# |
| | | | | ±0.25pF | GRM0225C1H5R4CA03# | | | | | | ±0.1pF | GRM0225C1H5R5BA03# |
| | | | ±0.5pF | GRM0225C1H5R4DA03# | ±0.25pF | | | | GRM0225C1H5R5CA03# | | | |

Part number # indicates the package specification code.

- GRM
- GR3
- GRJ
- GR4
- GR7
- GJM
- GQM
- GA2
- GA3 GB
- GA3 GD
- GA3 GF
- LLL
- LLA
- LLM
- LLR
- NFM
- KRM
- KR3
- GMA
- GMD
- Caution /Notice

GRM Series Temperature Compensating Type Part Number List

(→ 0.4×0.2mm)

| T max. | Rated Voltage | TC Code | Cap. | Tol. | Part Number |
|--------|---------------|---------|-------|---------|--------------------|
| 0.22mm | 50Vdc | COG | 6.9pF | ±0.5pF | GRM0225C1H6R9DA03# |
| | | | | ±0.05pF | GRM0225C1H7R0WA03# |
| | | | 7.0pF | ±0.1pF | GRM0225C1H7R0BA03# |
| | | | | ±0.25pF | GRM0225C1H7R0CA03# |
| | | | | ±0.5pF | GRM0225C1H7R0DA03# |
| | | | | ±0.05pF | GRM0225C1H7R1WA03# |
| | | | 7.1pF | ±0.1pF | GRM0225C1H7R1BA03# |
| | | | | ±0.25pF | GRM0225C1H7R1CA03# |
| | | | | ±0.5pF | GRM0225C1H7R1DA03# |
| | | | 7.2pF | ±0.05pF | GRM0225C1H7R2WA03# |
| | | | | ±0.1pF | GRM0225C1H7R2BA03# |
| | | | | ±0.25pF | GRM0225C1H7R2CA03# |
| | | | | ±0.5pF | GRM0225C1H7R2DA03# |
| | | | 7.3pF | ±0.05pF | GRM0225C1H7R3WA03# |
| | | | | ±0.1pF | GRM0225C1H7R3BA03# |
| | | | | ±0.25pF | GRM0225C1H7R3CA03# |
| | | | | ±0.5pF | GRM0225C1H7R3DA03# |
| | | | 7.4pF | ±0.05pF | GRM0225C1H7R4WA03# |
| | | | | ±0.1pF | GRM0225C1H7R4BA03# |
| | | | | ±0.25pF | GRM0225C1H7R4CA03# |
| | | | | ±0.5pF | GRM0225C1H7R4DA03# |
| | | | 7.5pF | ±0.05pF | GRM0225C1H7R5WA03# |
| | | | | ±0.1pF | GRM0225C1H7R5BA03# |
| | | | | ±0.25pF | GRM0225C1H7R5CA03# |
| | | | | ±0.5pF | GRM0225C1H7R5DA03# |
| | | | 7.6pF | ±0.05pF | GRM0225C1H7R6WA03# |
| | | | | ±0.1pF | GRM0225C1H7R6BA03# |
| | | | | ±0.25pF | GRM0225C1H7R6CA03# |
| | | | | ±0.5pF | GRM0225C1H7R6DA03# |
| | | | 7.7pF | ±0.05pF | GRM0225C1H7R7WA03# |
| | | | | ±0.1pF | GRM0225C1H7R7BA03# |
| | | | | ±0.25pF | GRM0225C1H7R7CA03# |
| | | | | ±0.5pF | GRM0225C1H7R7DA03# |
| | | | 7.8pF | ±0.05pF | GRM0225C1H7R8WA03# |
| | | | | ±0.1pF | GRM0225C1H7R8BA03# |
| | | | | ±0.25pF | GRM0225C1H7R8CA03# |
| | | | | ±0.5pF | GRM0225C1H7R8DA03# |
| | | | 7.9pF | ±0.05pF | GRM0225C1H7R9WA03# |
| | | | | ±0.1pF | GRM0225C1H7R9BA03# |
| | | | | ±0.25pF | GRM0225C1H7R9CA03# |
| | | | | ±0.5pF | GRM0225C1H7R9DA03# |
| | | | 8.0pF | ±0.05pF | GRM0225C1H8R0WA03# |
| | | | | ±0.1pF | GRM0225C1H8R0BA03# |
| | | | | ±0.25pF | GRM0225C1H8R0CA03# |
| | | | | ±0.5pF | GRM0225C1H8R0DA03# |
| | | | 8.1pF | ±0.05pF | GRM0225C1H8R1WA03# |
| | | | | ±0.1pF | GRM0225C1H8R1BA03# |
| | | | | ±0.25pF | GRM0225C1H8R1CA03# |
| | | | | ±0.5pF | GRM0225C1H8R1DA03# |
| | | | 8.2pF | ±0.05pF | GRM0225C1H8R2WA03# |
| | | | | ±0.1pF | GRM0225C1H8R2BA03# |
| | | | | ±0.25pF | GRM0225C1H8R2CA03# |
| | | | | ±0.5pF | GRM0225C1H8R2DA03# |
| | | | 8.3pF | ±0.05pF | GRM0225C1H8R3WA03# |

| T max. | Rated Voltage | TC Code | Cap. | Tol. | Part Number |
|--------|---------------|---------|-------|---------|--------------------|
| 0.22mm | 50Vdc | COG | 8.3pF | ±0.1pF | GRM0225C1H8R3BA03# |
| | | | | ±0.25pF | GRM0225C1H8R3CA03# |
| | | | | ±0.5pF | GRM0225C1H8R3DA03# |
| | | | 8.4pF | ±0.05pF | GRM0225C1H8R4WA03# |
| | | | | ±0.1pF | GRM0225C1H8R4BA03# |
| | | | | ±0.25pF | GRM0225C1H8R4CA03# |
| | | | 8.5pF | ±0.05pF | GRM0225C1H8R5WA03# |
| | | | | ±0.1pF | GRM0225C1H8R5BA03# |
| | | | | ±0.25pF | GRM0225C1H8R5CA03# |
| | | | 8.6pF | ±0.05pF | GRM0225C1H8R6WA03# |
| | | | | ±0.1pF | GRM0225C1H8R6BA03# |
| | | | | ±0.25pF | GRM0225C1H8R6CA03# |
| | | | 8.7pF | ±0.05pF | GRM0225C1H8R7WA03# |
| | | | | ±0.1pF | GRM0225C1H8R7BA03# |
| | | | | ±0.25pF | GRM0225C1H8R7CA03# |
| | | | 8.8pF | ±0.05pF | GRM0225C1H8R8WA03# |
| | | | | ±0.1pF | GRM0225C1H8R8BA03# |
| | | | | ±0.25pF | GRM0225C1H8R8CA03# |
| | | | 8.9pF | ±0.05pF | GRM0225C1H8R9WA03# |
| | | | | ±0.1pF | GRM0225C1H8R9BA03# |
| | | | | ±0.25pF | GRM0225C1H8R9CA03# |
| | | | 9.0pF | ±0.05pF | GRM0225C1H9R0WA03# |
| | | | | ±0.1pF | GRM0225C1H9R0BA03# |
| | | | | ±0.25pF | GRM0225C1H9R0CA03# |
| | | | 9.1pF | ±0.05pF | GRM0225C1H9R1WA03# |
| | | | | ±0.1pF | GRM0225C1H9R1BA03# |
| | | | | ±0.25pF | GRM0225C1H9R1CA03# |
| | | | 9.2pF | ±0.05pF | GRM0225C1H9R2WA03# |
| | | | | ±0.1pF | GRM0225C1H9R2BA03# |
| | | | | ±0.25pF | GRM0225C1H9R2CA03# |
| | | | 9.3pF | ±0.05pF | GRM0225C1H9R3WA03# |
| | | | | ±0.1pF | GRM0225C1H9R3BA03# |
| | | | | ±0.25pF | GRM0225C1H9R3CA03# |
| | | | 9.4pF | ±0.05pF | GRM0225C1H9R4WA03# |
| | | | | ±0.1pF | GRM0225C1H9R4BA03# |
| | | | | ±0.25pF | GRM0225C1H9R4CA03# |
| | | | 9.5pF | ±0.05pF | GRM0225C1H9R5WA03# |
| | | | | ±0.1pF | GRM0225C1H9R5BA03# |
| | | | | ±0.25pF | GRM0225C1H9R5CA03# |
| | | | 9.6pF | ±0.05pF | GRM0225C1H9R6WA03# |
| | | | | ±0.1pF | GRM0225C1H9R6BA03# |
| | | | | ±0.25pF | GRM0225C1H9R6CA03# |

- GRM
- GR3
- GRJ
- GR4
- GR7
- GJM
- GQM
- GA2
- GA3 GB
- GA3 GD
- GA3 GF
- LLL
- LLA
- LLM
- LLR
- NFM
- KRM
- KR3
- GMA
- GMD
- ⚠Caution /Notice

Part number # indicates the package specification code.

GRM Series Temperature Compensating Type Part Number List

(→ 0.4×0.2mm)

| T max. | Rated Voltage | TC Code | Cap. | Tol. | Part Number | T max. | Rated Voltage | TC Code | Cap. | Tol. | Part Number |
|--------|---------------|---------|--------|---------|--------------------|--------------------|---------------|---------|--------------------|--------------------|--------------------|
| 0.22mm | 50Vdc | COG | 9.6pF | ±0.5pF | GRM0225C1H9R6DA03# | 0.22mm | 50Vdc | CK | 0.50pF | ±0.05pF | GRM0224C1HR50WA03# |
| | | | | ±0.05pF | GRM0225C1H9R7WA03# | | | | | ±0.1pF | GRM0224C1HR50BA03# |
| | | | | ±0.1pF | GRM0225C1H9R7BA03# | | | | | ±0.05pF | GRM0224C1HR51WA03# |
| | | | | ±0.25pF | GRM0225C1H9R7CA03# | | | | | ±0.05pF | GRM0224C1HR60WA03# |
| | | | | ±0.5pF | GRM0225C1H9R7DA03# | | | | | ±0.1pF | GRM0224C1HR60BA03# |
| | | | 9.8pF | ±0.05pF | GRM0225C1H9R8WA03# | 0.70pF | | | ±0.05pF | GRM0224C1HR70WA03# | |
| | | | | ±0.1pF | GRM0225C1H9R8BA03# | | | | ±0.1pF | GRM0224C1HR70BA03# | |
| | | | | ±0.25pF | GRM0225C1H9R8CA03# | | | | 0.80pF | ±0.05pF | GRM0224C1HR80WA03# |
| | | | | ±0.5pF | GRM0225C1H9R8DA03# | | | | | ±0.1pF | GRM0224C1HR80BA03# |
| | | | 9.9pF | ±0.05pF | GRM0225C1H9R9WA03# | 0.90pF | | | ±0.05pF | GRM0224C1HR90WA03# | |
| | | | | ±0.1pF | GRM0225C1H9R9BA03# | | | | ±0.1pF | GRM0224C1HR90BA03# | |
| | | | | ±0.25pF | GRM0225C1H9R9CA03# | 1.0pF | | | ±0.05pF | GRM0224C1H1R0WA03# | |
| | | | | ±0.5pF | GRM0225C1H9R9DA03# | | | | ±0.1pF | GRM0224C1H1R0BA03# | |
| | | | 10pF | ±2% | GRM0225C1H100GA03# | 1.1pF | | | ±0.05pF | GRM0224C1H1R1WA03# | |
| | | | | ±5% | GRM0225C1H100JA03# | | | | ±0.1pF | GRM0224C1H1R1BA03# | |
| | | | 11pF | ±2% | GRM0225C1H110GA03# | 1.2pF | | | ±0.25pF | GRM0224C1H1R1CA03# | |
| | | | | ±5% | GRM0225C1H110JA03# | | | | ±0.05pF | GRM0224C1H1R2WA03# | |
| | | | 12pF | ±2% | GRM0225C1H120GA03# | 1.3pF | | | ±0.1pF | GRM0224C1H1R2BA03# | |
| | | | | ±5% | GRM0225C1H120JA03# | | | | ±0.25pF | GRM0224C1H1R2CA03# | |
| | | | 13pF | ±2% | GRM0225C1H130GA03# | 1.4pF | | | ±0.05pF | GRM0224C1H1R3WA03# | |
| | | | | ±5% | GRM0225C1H130JA03# | | | | ±0.1pF | GRM0224C1H1R3BA03# | |
| | | | 15pF | ±2% | GRM0225C1H150GA03# | 1.5pF | | | ±0.25pF | GRM0224C1H1R3CA03# | |
| | | | | ±5% | GRM0225C1H150JA03# | | | | ±0.05pF | GRM0224C1H1R4WA03# | |
| | | | 16pF | ±2% | GRM0225C1H160GA03# | 1.6pF | | | ±0.1pF | GRM0224C1H1R4BA03# | |
| | | | | ±5% | GRM0225C1H160JA03# | | | | ±0.25pF | GRM0224C1H1R4CA03# | |
| | | | 17pF | ±5% | GRM0225C1H170JA02# | 1.7pF | | | ±0.05pF | GRM0224C1H1R5WA03# | |
| | | | 18pF | ±5% | GRM0225C1H180JA02# | | | | ±0.1pF | GRM0224C1H1R5BA03# | |
| | | | 19pF | ±5% | GRM0225C1H190JA02# | 1.8pF | | | ±0.25pF | GRM0224C1H1R5CA03# | |
| | | | 20pF | ±5% | GRM0225C1H200JA02# | | | | ±0.05pF | GRM0224C1H1R6WA03# | |
| | | | 21pF | ±5% | GRM0225C1H210JA02# | 1.9pF | | | ±0.1pF | GRM0224C1H1R6BA03# | |
| | | | 22pF | ±5% | GRM0225C1H220JA02# | | | | ±0.25pF | GRM0224C1H1R6CA03# | |
| | | | 23pF | ±5% | GRM0225C1H230JA02# | 2.0pF | | | ±0.05pF | GRM0224C1H2R0WA03# | |
| | | | 24pF | ±5% | GRM0225C1H240JA02# | | | | ±0.1pF | GRM0224C1H2R0BA03# | |
| | | | 27pF | ±5% | GRM0225C1H270JA02# | 2.1pF | | | ±0.25pF | GRM0224C1H2R0CA03# | |
| | | | 30pF | ±5% | GRM0225C1H300JA02# | | | | ±0.05pF | GRM0223C1H2R1WA03# | |
| | | | 33pF | ±5% | GRM0225C1H330JA02# | 2.2pF | | | ±0.1pF | GRM0223C1H2R1BA03# | |
| | | | 36pF | ±5% | GRM0225C1H360JA02# | | | | ±0.25pF | GRM0223C1H2R1CA03# | |
| | | | 39pF | ±5% | GRM0225C1H390JA02# | 2.3pF | | | ±0.05pF | GRM0223C1H2R2WA03# | |
| | | | 43pF | ±5% | GRM0225C1H430JA02# | | | | ±0.1pF | GRM0223C1H2R2BA03# | |
| | | | 47pF | ±5% | GRM0225C1H470JA02# | 2.4pF | | | ±0.25pF | GRM0223C1H2R2CA03# | |
| | | | 51pF | ±5% | GRM0225C1H510JA02# | | | | ±0.05pF | GRM0223C1H2R3WA03# | |
| | | | 56pF | ±5% | GRM0225C1H560JA02# | CJ | | | ±0.1pF | GRM0223C1H2R3BA03# | |
| | | | 62pF | ±5% | GRM0225C1H620JA02# | | | | ±0.25pF | GRM0223C1H2R3CA03# | |
| | | | 68pF | ±5% | GRM0225C1H680JA02# | 2.1pF | | | ±0.05pF | GRM0223C1H2R4WA03# | |
| | | | 75pF | ±5% | GRM0225C1H750JA02# | | | | ±0.1pF | | |
| | | | 82pF | ±5% | GRM0225C1H820JA02# | 2.2pF | | | ±0.25pF | | |
| | | | 91pF | ±5% | GRM0225C1H910JA02# | | | | ±0.05pF | | |
| | | | 100pF | ±5% | GRM0225C1H101JA02# | 2.3pF | | | ±0.1pF | | |
| | | | CK | 0.20pF | ±0.05pF | | | | GRM0224C1HR20WA03# | ±0.25pF | |
| | | | | | ±0.1pF | GRM0224C1HR20BA03# | | | ±0.05pF | | |
| | | | | 0.30pF | ±0.05pF | GRM0224C1HR30WA03# | | | ±0.1pF | | |
| | | | | | ±0.1pF | GRM0224C1HR30BA03# | | | ±0.25pF | | |
| | | | 0.40pF | ±0.05pF | GRM0224C1HR40WA03# | ±0.05pF | | | | | |
| | | | | ±0.1pF | GRM0224C1HR40BA03# | | | | | | |

Part number # indicates the package specification code.

GRM Series Temperature Compensating Type Part Number List

(→ 0.4×0.2mm)

| T max. | Rated Voltage | TC Code | Cap. | Tol. | Part Number | T max. | Rated Voltage | TC Code | Cap. | Tol. | Part Number |
|---------|--------------------|---------|---------|--------------------|--------------------|--------------------|--------------------|---------|-------|--------------------|--------------------|
| 0.22mm | 50Vdc | CJ | 2.4pF | ±0.1pF | GRM0223C1H2R4BA03# | 0.22mm | 50Vdc | CH | 4.2pF | ±0.1pF | GRM0222C1H4R2BA03# |
| | | | | ±0.25pF | GRM0223C1H2R4CA03# | | | | | ±0.25pF | GRM0222C1H4R2CA03# |
| | | | 2.5pF | ±0.05pF | GRM0223C1H2R5WA03# | | | | 4.3pF | ±0.05pF | GRM0222C1H4R3WA03# |
| | | | | ±0.1pF | GRM0223C1H2R5BA03# | | | | | ±0.1pF | GRM0222C1H4R3BA03# |
| | | | | ±0.25pF | GRM0223C1H2R5CA03# | | | | | ±0.25pF | GRM0222C1H4R3CA03# |
| | | | 2.6pF | ±0.05pF | GRM0223C1H2R6WA03# | | | | 4.4pF | ±0.05pF | GRM0222C1H4R4WA03# |
| | | | | ±0.1pF | GRM0223C1H2R6BA03# | | | | | ±0.1pF | GRM0222C1H4R4BA03# |
| | | | | ±0.25pF | GRM0223C1H2R6CA03# | | | | | ±0.25pF | GRM0222C1H4R4CA03# |
| | | | 2.7pF | ±0.05pF | GRM0223C1H2R7WA03# | | | | 4.5pF | ±0.05pF | GRM0222C1H4R5WA03# |
| | | | | ±0.1pF | GRM0223C1H2R7BA03# | | | | | ±0.1pF | GRM0222C1H4R5BA03# |
| | | | | ±0.25pF | GRM0223C1H2R7CA03# | | | | | ±0.25pF | GRM0222C1H4R5CA03# |
| | | | 2.8pF | ±0.05pF | GRM0223C1H2R8WA03# | | | | 4.6pF | ±0.05pF | GRM0222C1H4R6WA03# |
| | | | | ±0.1pF | GRM0223C1H2R8BA03# | | | | | ±0.1pF | GRM0222C1H4R6BA03# |
| | | | | ±0.25pF | GRM0223C1H2R8CA03# | | | | | ±0.25pF | GRM0222C1H4R6CA03# |
| | | | 2.9pF | ±0.05pF | GRM0223C1H2R9WA03# | | | | 4.7pF | ±0.05pF | GRM0222C1H4R7WA03# |
| | | | | ±0.1pF | GRM0223C1H2R9BA03# | | | | | ±0.1pF | GRM0222C1H4R7BA03# |
| | | | | ±0.25pF | GRM0223C1H2R9CA03# | | | | | ±0.25pF | GRM0222C1H4R7CA03# |
| | | | 3.0pF | ±0.05pF | GRM0223C1H3R0WA03# | | | | 4.8pF | ±0.05pF | GRM0222C1H4R8WA03# |
| | | | | ±0.1pF | GRM0223C1H3R0BA03# | | | | | ±0.1pF | GRM0222C1H4R8BA03# |
| | | | | ±0.25pF | GRM0223C1H3R0CA03# | | | | | ±0.25pF | GRM0222C1H4R8CA03# |
| | | | 3.1pF | ±0.05pF | GRM0223C1H3R1WA03# | | | | 4.9pF | ±0.05pF | GRM0222C1H4R9WA03# |
| | | | | ±0.1pF | GRM0223C1H3R1BA03# | | | | | ±0.1pF | GRM0222C1H4R9BA03# |
| | | | | ±0.25pF | GRM0223C1H3R1CA03# | | | | | ±0.25pF | GRM0222C1H4R9CA03# |
| | | | 3.2pF | ±0.05pF | GRM0223C1H3R2WA03# | | | | 5.0pF | ±0.05pF | GRM0222C1H5R0WA03# |
| | | ±0.1pF | | GRM0223C1H3R2BA03# | ±0.1pF | GRM0222C1H5R0BA03# | | | | | |
| | | ±0.25pF | | GRM0223C1H3R2CA03# | ±0.25pF | GRM0222C1H5R0CA03# | | | | | |
| | | 3.3pF | ±0.05pF | GRM0223C1H3R3WA03# | 5.1pF | ±0.05pF | GRM0222C1H5R1WA03# | | | | |
| | | | ±0.1pF | GRM0223C1H3R3BA03# | | ±0.1pF | GRM0222C1H5R1BA03# | | | | |
| | | | ±0.25pF | GRM0223C1H3R3CA03# | | ±0.25pF | GRM0222C1H5R1CA03# | | | | |
| | | 3.4pF | ±0.05pF | GRM0223C1H3R4WA03# | 5.2pF | ±0.05pF | GRM0222C1H5R2WA03# | | | | |
| | | | ±0.1pF | GRM0223C1H3R4BA03# | | ±0.1pF | GRM0222C1H5R2BA03# | | | | |
| | | | ±0.25pF | GRM0223C1H3R4CA03# | | ±0.25pF | GRM0222C1H5R2CA03# | | | | |
| | | 3.5pF | ±0.05pF | GRM0223C1H3R5WA03# | 5.3pF | ±0.05pF | GRM0222C1H5R3WA03# | | | | |
| | | | ±0.1pF | GRM0223C1H3R5BA03# | | ±0.1pF | GRM0222C1H5R3BA03# | | | | |
| | | | ±0.25pF | GRM0223C1H3R5CA03# | | ±0.25pF | GRM0222C1H5R3CA03# | | | | |
| | | 3.6pF | ±0.05pF | GRM0223C1H3R6WA03# | 5.4pF | ±0.05pF | GRM0222C1H5R4WA03# | | | | |
| | | | ±0.1pF | GRM0223C1H3R6BA03# | | ±0.1pF | GRM0222C1H5R4BA03# | | | | |
| | | | ±0.25pF | GRM0223C1H3R6CA03# | | ±0.25pF | GRM0222C1H5R4CA03# | | | | |
| | | 3.7pF | ±0.05pF | GRM0223C1H3R7WA03# | 5.5pF | ±0.05pF | GRM0222C1H5R5WA03# | | | | |
| | | | ±0.1pF | GRM0223C1H3R7BA03# | | ±0.1pF | GRM0222C1H5R5BA03# | | | | |
| | | | ±0.25pF | GRM0223C1H3R7CA03# | | ±0.25pF | GRM0222C1H5R5CA03# | | | | |
| | | 3.8pF | ±0.05pF | GRM0223C1H3R8WA03# | 5.6pF | ±0.05pF | GRM0222C1H5R6WA03# | | | | |
| | | | ±0.1pF | GRM0223C1H3R8BA03# | | ±0.1pF | GRM0222C1H5R6BA03# | | | | |
| | | | ±0.25pF | GRM0223C1H3R8CA03# | | ±0.25pF | GRM0222C1H5R6CA03# | | | | |
| | | 3.9pF | ±0.05pF | GRM0223C1H3R9WA03# | 5.7pF | ±0.05pF | GRM0222C1H5R7WA03# | | | | |
| | | | ±0.1pF | GRM0223C1H3R9BA03# | | ±0.1pF | GRM0222C1H5R7BA03# | | | | |
| | | | ±0.25pF | GRM0223C1H3R9CA03# | | ±0.25pF | GRM0222C1H5R7CA03# | | | | |
| | | CH | 50Vdc | 4.0pF | ±0.05pF | GRM0222C1H4R0WA03# | 0.22mm | 50Vdc | CH | 4.2pF | ±0.05pF |
| ±0.1pF | GRM0222C1H4R0BA03# | | | | ±0.1pF | GRM0222C1H5R7BA03# | | | | | |
| ±0.25pF | GRM0222C1H4R0CA03# | | | | ±0.25pF | GRM0222C1H5R7CA03# | | | | | |
| 4.1pF | ±0.05pF | | | GRM0222C1H4R1WA03# | 5.7pF | ±0.05pF | | | | GRM0222C1H5R7WA03# | |
| | ±0.1pF | | | GRM0222C1H4R1BA03# | | ±0.1pF | | | | GRM0222C1H5R7BA03# | |
| | ±0.25pF | | | GRM0222C1H4R1CA03# | | ±0.25pF | | | | GRM0222C1H5R7CA03# | |
| 4.2pF | ±0.05pF | | | GRM0222C1H4R2WA03# | 5.7pF | ±0.05pF | | | | GRM0222C1H5R7DA03# | |
| | ±0.1pF | | | GRM0222C1H4R2BA03# | | ±0.1pF | | | | GRM0222C1H5R7BA03# | |
| | ±0.25pF | | | GRM0222C1H4R2CA03# | | ±0.25pF | | | | GRM0222C1H5R7CA03# | |

- GRM
- GR3
- GRJ
- GR4
- GR7
- GJM
- GQM
- GA2
- GA3 GB
- GA3 GD
- GA3 GF
- LLL
- LLA
- LLM
- LLR
- NFM
- KRM
- KR3
- GMA
- GMD
- ⚠Caution /Notice

Part number # indicates the package specification code.

GRM Series Temperature Compensating Type Part Number List

(→ 0.4×0.2mm)

| T max. | Rated Voltage | TC Code | Cap. | Tol. | Part Number |
|--------|---------------|---------|-------|---------|--------------------|
| 0.22mm | 50Vdc | CH | 5.8pF | ±0.05pF | GRM0222C1H5R8WA03# |
| | | | | ±0.1pF | GRM0222C1H5R8BA03# |
| | | | | ±0.25pF | GRM0222C1H5R8CA03# |
| | | | | ±0.5pF | GRM0222C1H5R8DA03# |
| | | | 5.9pF | ±0.05pF | GRM0222C1H5R9WA03# |
| | | | | ±0.1pF | GRM0222C1H5R9BA03# |
| | | | | ±0.25pF | GRM0222C1H5R9CA03# |
| | | | | ±0.5pF | GRM0222C1H5R9DA03# |
| | | | 6.0pF | ±0.05pF | GRM0222C1H6R0WA03# |
| | | | | ±0.1pF | GRM0222C1H6R0BA03# |
| | | | | ±0.25pF | GRM0222C1H6R0CA03# |
| | | | | ±0.5pF | GRM0222C1H6R0DA03# |
| | | | 6.1pF | ±0.05pF | GRM0222C1H6R1WA03# |
| | | | | ±0.1pF | GRM0222C1H6R1BA03# |
| | | | | ±0.25pF | GRM0222C1H6R1CA03# |
| | | | | ±0.5pF | GRM0222C1H6R1DA03# |
| | | | 6.2pF | ±0.05pF | GRM0222C1H6R2WA03# |
| | | | | ±0.1pF | GRM0222C1H6R2BA03# |
| | | | | ±0.25pF | GRM0222C1H6R2CA03# |
| | | | | ±0.5pF | GRM0222C1H6R2DA03# |
| | | | 6.3pF | ±0.05pF | GRM0222C1H6R3WA03# |
| | | | | ±0.1pF | GRM0222C1H6R3BA03# |
| | | | | ±0.25pF | GRM0222C1H6R3CA03# |
| | | | | ±0.5pF | GRM0222C1H6R3DA03# |
| | | | 6.4pF | ±0.05pF | GRM0222C1H6R4WA03# |
| | | | | ±0.1pF | GRM0222C1H6R4BA03# |
| | | | | ±0.25pF | GRM0222C1H6R4CA03# |
| | | | | ±0.5pF | GRM0222C1H6R4DA03# |
| | | | 6.5pF | ±0.05pF | GRM0222C1H6R5WA03# |
| | | | | ±0.1pF | GRM0222C1H6R5BA03# |
| | | | | ±0.25pF | GRM0222C1H6R5CA03# |
| | | | | ±0.5pF | GRM0222C1H6R5DA03# |
| | | | 6.6pF | ±0.05pF | GRM0222C1H6R6WA03# |
| | | | | ±0.1pF | GRM0222C1H6R6BA03# |
| | | | | ±0.25pF | GRM0222C1H6R6CA03# |
| | | | | ±0.5pF | GRM0222C1H6R6DA03# |
| | | | 6.7pF | ±0.05pF | GRM0222C1H6R7WA03# |
| | | | | ±0.1pF | GRM0222C1H6R7BA03# |
| | | | | ±0.25pF | GRM0222C1H6R7CA03# |
| | | | | ±0.5pF | GRM0222C1H6R7DA03# |
| | | | 6.8pF | ±0.05pF | GRM0222C1H6R8WA03# |
| | | | | ±0.1pF | GRM0222C1H6R8BA03# |
| | | | | ±0.25pF | GRM0222C1H6R8CA03# |
| | | | | ±0.5pF | GRM0222C1H6R8DA03# |
| | | | 6.9pF | ±0.05pF | GRM0222C1H6R9WA03# |
| | | | | ±0.1pF | GRM0222C1H6R9BA03# |
| | | | | ±0.25pF | GRM0222C1H6R9CA03# |
| | | | | ±0.5pF | GRM0222C1H6R9DA03# |
| | | | 7.0pF | ±0.05pF | GRM0222C1H7R0WA03# |
| | | | | ±0.1pF | GRM0222C1H7R0BA03# |
| | | | | ±0.25pF | GRM0222C1H7R0CA03# |
| | | | | ±0.5pF | GRM0222C1H7R0DA03# |
| | | | 7.1pF | ±0.05pF | GRM0222C1H7R1WA03# |
| | | | | ±0.1pF | GRM0222C1H7R1BA03# |

| T max. | Rated Voltage | TC Code | Cap. | Tol. | Part Number |
|--------|---------------|---------|-------|---------|--------------------|
| 0.22mm | 50Vdc | CH | 7.1pF | ±0.25pF | GRM0222C1H7R1CA03# |
| | | | | ±0.5pF | GRM0222C1H7R1DA03# |
| | | | 7.2pF | ±0.05pF | GRM0222C1H7R2WA03# |
| | | | | ±0.1pF | GRM0222C1H7R2BA03# |
| | | | | ±0.25pF | GRM0222C1H7R2CA03# |
| | | | 7.3pF | ±0.05pF | GRM0222C1H7R3WA03# |
| | | | | ±0.1pF | GRM0222C1H7R3BA03# |
| | | | | ±0.25pF | GRM0222C1H7R3CA03# |
| | | | 7.4pF | ±0.05pF | GRM0222C1H7R4WA03# |
| | | | | ±0.1pF | GRM0222C1H7R4BA03# |
| | | | | ±0.25pF | GRM0222C1H7R4CA03# |
| | | | 7.5pF | ±0.05pF | GRM0222C1H7R5WA03# |
| | | | | ±0.1pF | GRM0222C1H7R5BA03# |
| | | | | ±0.25pF | GRM0222C1H7R5CA03# |
| | | | 7.6pF | ±0.05pF | GRM0222C1H7R6WA03# |
| | | | | ±0.1pF | GRM0222C1H7R6BA03# |
| | | | | ±0.25pF | GRM0222C1H7R6CA03# |
| | | | 7.7pF | ±0.05pF | GRM0222C1H7R7WA03# |
| | | | | ±0.1pF | GRM0222C1H7R7BA03# |
| | | | | ±0.25pF | GRM0222C1H7R7CA03# |
| | | | 7.8pF | ±0.05pF | GRM0222C1H7R8WA03# |
| | | | | ±0.1pF | GRM0222C1H7R8BA03# |
| | | | | ±0.25pF | GRM0222C1H7R8CA03# |
| | | | 7.9pF | ±0.05pF | GRM0222C1H7R9WA03# |
| | | | | ±0.1pF | GRM0222C1H7R9BA03# |
| | | | | ±0.25pF | GRM0222C1H7R9CA03# |
| | | | 8.0pF | ±0.05pF | GRM0222C1H8R0WA03# |
| | | | | ±0.1pF | GRM0222C1H8R0BA03# |
| | | | | ±0.25pF | GRM0222C1H8R0CA03# |
| | | | 8.1pF | ±0.05pF | GRM0222C1H8R1WA03# |
| | | | | ±0.1pF | GRM0222C1H8R1BA03# |
| | | | | ±0.25pF | GRM0222C1H8R1CA03# |
| | | | 8.2pF | ±0.05pF | GRM0222C1H8R2WA03# |
| | | | | ±0.1pF | GRM0222C1H8R2BA03# |
| | | | | ±0.25pF | GRM0222C1H8R2CA03# |
| | | | 8.3pF | ±0.05pF | GRM0222C1H8R3WA03# |
| | | | | ±0.1pF | GRM0222C1H8R3BA03# |
| | | | | ±0.25pF | GRM0222C1H8R3CA03# |
| | | | 8.4pF | ±0.05pF | GRM0222C1H8R4WA03# |
| | | | | ±0.1pF | GRM0222C1H8R4BA03# |
| | | | | ±0.25pF | GRM0222C1H8R4CA03# |

Part number # indicates the package specification code.

GRM
 GR3
 GRJ
 GR4
 GR7
 GJM
 GQM
 GA2
 GA3 GB
 GA3 GD
 GA3 GF
 LLL
 LLA
 LLM
 LLR
 NFM
 KRM
 KR3
 GMA
 GMD
 ⚠Caution /Notice

GRM Series Temperature Compensating Type Part Number List

(→ 0.4×0.2mm)

| T max. | Rated Voltage | TC Code | Cap. | Tol. | Part Number | T max. | Rated Voltage | TC Code | Cap. | Tol. | Part Number | |
|--------|---------------|---------|-------|---------|--------------------|--------|---------------|---------|---------|--------------------|--------------------|--------------------|
| 0.22mm | 50Vdc | CH | 8.5pF | ±0.05pF | GRM0222C1H8R5WA03# | 0.22mm | 50Vdc | CH | 9.8pF | ±0.25pF | GRM0222C1H9R8CA03# | |
| | | | | ±0.1pF | GRM0222C1H8R5BA03# | | | | | ±0.5pF | GRM0222C1H9R8DA03# | |
| | | | | ±0.25pF | GRM0222C1H8R5CA03# | | | | | 9.9pF | ±0.05pF | GRM0222C1H9R9WA03# |
| | | | | ±0.5pF | GRM0222C1H8R5DA03# | | | | | | ±0.1pF | GRM0222C1H9R9BA03# |
| | | | 8.6pF | ±0.05pF | GRM0222C1H8R6WA03# | | | | ±0.25pF | GRM0222C1H9R9CA03# | | |
| | | | | ±0.1pF | GRM0222C1H8R6BA03# | | | | ±0.5pF | GRM0222C1H9R9DA03# | | |
| | | | | ±0.25pF | GRM0222C1H8R6CA03# | | | | 10pF | ±2% | GRM0222C1H100GA03# | |
| | | | | ±0.5pF | GRM0222C1H8R6DA03# | | | | | ±5% | GRM0222C1H100JA03# | |
| | | | 8.7pF | ±0.05pF | GRM0222C1H8R7WA03# | | | | 11pF | ±2% | GRM0222C1H110GA03# | |
| | | | | ±0.1pF | GRM0222C1H8R7BA03# | | | | | ±5% | GRM0222C1H110JA03# | |
| | | | | ±0.25pF | GRM0222C1H8R7CA03# | | | | 12pF | ±2% | GRM0222C1H120GA03# | |
| | | | | ±0.5pF | GRM0222C1H8R7DA03# | | | | | ±5% | GRM0222C1H120JA03# | |
| | | | 8.8pF | ±0.05pF | GRM0222C1H8R8WA03# | | | | 13pF | ±2% | GRM0222C1H130GA03# | |
| | | | | ±0.1pF | GRM0222C1H8R8BA03# | | | | | ±5% | GRM0222C1H130JA03# | |
| | | | | ±0.25pF | GRM0222C1H8R8CA03# | | | | 15pF | ±2% | GRM0222C1H150GA03# | |
| | | | | ±0.5pF | GRM0222C1H8R8DA03# | | | | | ±5% | GRM0222C1H150JA03# | |
| | | | 8.9pF | ±0.05pF | GRM0222C1H8R9WA03# | | | | 16pF | ±2% | GRM0222C1H160GA03# | |
| | | | | ±0.1pF | GRM0222C1H8R9BA03# | | | | | ±5% | GRM0222C1H160JA03# | |
| | | | | ±0.25pF | GRM0222C1H8R9CA03# | | | | 17pF | ±5% | GRM0222C1H170JA02# | |
| | | | | ±0.5pF | GRM0222C1H8R9DA03# | | | | | 18pF | ±5% | GRM0222C1H180JA02# |
| | | | 9.0pF | ±0.05pF | GRM0222C1H9R0WA03# | | | | 19pF | | ±5% | GRM0222C1H190JA02# |
| | | | | ±0.1pF | GRM0222C1H9R0BA03# | | | | | 20pF | ±5% | GRM0222C1H200JA02# |
| | | | | ±0.25pF | GRM0222C1H9R0CA03# | | | | 21pF | | ±5% | GRM0222C1H210JA02# |
| | | | | ±0.5pF | GRM0222C1H9R0DA03# | | | | | 22pF | ±5% | GRM0222C1H220JA02# |
| | | | 9.1pF | ±0.05pF | GRM0222C1H9R1WA03# | | | | 23pF | | ±5% | GRM0222C1H230JA02# |
| | | | | ±0.1pF | GRM0222C1H9R1BA03# | | | | | 24pF | ±5% | GRM0222C1H240JA02# |
| | | | | ±0.25pF | GRM0222C1H9R1CA03# | | | | 27pF | | ±5% | GRM0222C1H270JA02# |
| | | | | ±0.5pF | GRM0222C1H9R1DA03# | | | | | 30pF | ±5% | GRM0222C1H300JA02# |
| | | | 9.2pF | ±0.05pF | GRM0222C1H9R2WA03# | | | | 33pF | | ±5% | GRM0222C1H330JA02# |
| | | | | ±0.1pF | GRM0222C1H9R2BA03# | | | | | 36pF | ±5% | GRM0222C1H360JA02# |
| | | | | ±0.25pF | GRM0222C1H9R2CA03# | | | | 39pF | | ±5% | GRM0222C1H390JA02# |
| | | | | ±0.5pF | GRM0222C1H9R2DA03# | | | | | 43pF | ±5% | GRM0222C1H430JA02# |
| | | | 9.3pF | ±0.05pF | GRM0222C1H9R3WA03# | | | | 47pF | | ±5% | GRM0222C1H470JA02# |
| | | | | ±0.1pF | GRM0222C1H9R3BA03# | | | | | 51pF | ±5% | GRM0222C1H510JA02# |
| | | | | ±0.25pF | GRM0222C1H9R3CA03# | | | | 56pF | | ±5% | GRM0222C1H560JA02# |
| | | | | ±0.5pF | GRM0222C1H9R3DA03# | | | | | 62pF | ±5% | GRM0222C1H620JA02# |
| | | | 9.4pF | ±0.05pF | GRM0222C1H9R4WA03# | | | | 68pF | | ±5% | GRM0222C1H680JA02# |
| | | | | ±0.1pF | GRM0222C1H9R4BA03# | | | | | 75pF | ±5% | GRM0222C1H750JA02# |
| | | | | ±0.25pF | GRM0222C1H9R4CA03# | | | | 82pF | | ±5% | GRM0222C1H820JA02# |
| | | | | ±0.5pF | GRM0222C1H9R4DA03# | | | | | 91pF | ±5% | GRM0222C1H910JA02# |
| | | | 9.5pF | ±0.05pF | GRM0222C1H9R5WA03# | | | | 100pF | | ±5% | GRM0222C1H101JA02# |
| | | | | ±0.1pF | GRM0222C1H9R5BA03# | | | | | 120pF | ±5% | GRM0225C1E121JA02# |
| | | | | ±0.25pF | GRM0222C1H9R5CA03# | | | | 150pF | | ±5% | GRM0225C1E151JA02# |
| | | | | ±0.5pF | GRM0222C1H9R5DA03# | | | | | 180pF | ±5% | GRM0225C1E181JA02# |
| | | | 9.6pF | ±0.05pF | GRM0222C1H9R6WA03# | | | | 220pF | | ±5% | GRM0225C1E221JA02# |
| | | | | ±0.1pF | GRM0222C1H9R6BA03# | | | | | 120pF | ±5% | GRM0222C1E121JA02# |
| | | | | ±0.25pF | GRM0222C1H9R6CA03# | | | | 150pF | | ±5% | GRM0222C1E151JA02# |
| | | | | ±0.5pF | GRM0222C1H9R6DA03# | | | | | 180pF | ±5% | GRM0222C1E181JA02# |
| | | | 9.7pF | ±0.05pF | GRM0222C1H9R7WA03# | | | | 220pF | | ±5% | GRM0222C1E221JA02# |
| | | | | ±0.1pF | GRM0222C1H9R7BA03# | | | | | 120pF | ±5% | GRM0225C1C121JA02# |
| | | | | ±0.25pF | GRM0222C1H9R7CA03# | | | | 150pF | | ±5% | GRM0225C1C151JA02# |
| | | | | ±0.5pF | GRM0222C1H9R7DA03# | | | | | 180pF | ±5% | GRM0225C1C181JA02# |
| | | | 9.8pF | ±0.05pF | GRM0222C1H9R8WA03# | | | | 220pF | | ±5% | GRM0225C1C221JA02# |
| | | | | ±0.1pF | GRM0222C1H9R8BA03# | | | | | CH | 120pF | ±5% |

GRM
 GR3
 GRJ
 GR4
 GR7
 GJM
 GQM
 GA2
 GA3 GB
 GA3 GD
 GA3 GF
 LLL
 LLA
 LLM
 LLR
 NFM
 KRM
 KR3
 GMA
 GMD
 ⚠Caution /Notice

Part number # indicates the package specification code.

GRM Series Temperature Compensating Type Part Number List

(→ 0.4×0.2mm)

| T max. | Rated Voltage | TC Code | Cap. | Tol. | Part Number |
|--------|---------------|---------|-------|------|--------------------|
| 0.22mm | 16Vdc | CH | 150pF | ±5% | GRM0222C1C151JA02# |
| | | | 180pF | ±5% | GRM0222C1C181JA02# |
| | | | 220pF | ±5% | GRM0222C1C221JA02# |

| T max. | Rated Voltage | TC Code | Cap. | Tol. | Part Number |
|---------|--------------------|--------------------|-------|---------|--------------------|
| 0.33mm | 100Vdc | COG | 1.9pF | ±0.25pF | GRM0335C2A1R9CA01# |
| | | | 2.0pF | ±0.05pF | GRM0335C2A2R0WA01# |
| | | | | ±0.1pF | GRM0335C2A2R0BA01# |
| | | | | ±0.25pF | GRM0335C2A2R0CA01# |
| | | | 2.1pF | ±0.05pF | GRM0335C2A2R1WA01# |
| | | | | ±0.1pF | GRM0335C2A2R1BA01# |
| | | | | ±0.25pF | GRM0335C2A2R1CA01# |
| | | | 2.2pF | ±0.05pF | GRM0335C2A2R2WA01# |
| | | | | ±0.1pF | GRM0335C2A2R2BA01# |
| | | | | ±0.25pF | GRM0335C2A2R2CA01# |
| | | | 2.3pF | ±0.05pF | GRM0335C2A2R3WA01# |
| | | | | ±0.1pF | GRM0335C2A2R3BA01# |
| | | | | ±0.25pF | GRM0335C2A2R3CA01# |
| | | | 2.4pF | ±0.05pF | GRM0335C2A2R4WA01# |
| | | | | ±0.1pF | GRM0335C2A2R4BA01# |
| | | | | ±0.25pF | GRM0335C2A2R4CA01# |
| | | | 2.5pF | ±0.05pF | GRM0335C2A2R5WA01# |
| | | | | ±0.1pF | GRM0335C2A2R5BA01# |
| | | | | ±0.25pF | GRM0335C2A2R5CA01# |
| | | | 2.6pF | ±0.05pF | GRM0335C2A2R6WA01# |
| | | | | ±0.1pF | GRM0335C2A2R6BA01# |
| | | | | ±0.25pF | GRM0335C2A2R6CA01# |
| | | | 2.7pF | ±0.05pF | GRM0335C2A2R7WA01# |
| | | | | ±0.1pF | GRM0335C2A2R7BA01# |
| | | | | ±0.25pF | GRM0335C2A2R7CA01# |
| | | | 2.8pF | ±0.05pF | GRM0335C2A2R8WA01# |
| | | | | ±0.1pF | GRM0335C2A2R8BA01# |
| | | | | ±0.25pF | GRM0335C2A2R8CA01# |
| | | | 2.9pF | ±0.05pF | GRM0335C2A2R9WA01# |
| | | | | ±0.1pF | GRM0335C2A2R9BA01# |
| | | | | ±0.25pF | GRM0335C2A2R9CA01# |
| | | | 3.0pF | ±0.05pF | GRM0335C2A3R0WA01# |
| | | | | ±0.1pF | GRM0335C2A3R0BA01# |
| | | | | ±0.25pF | GRM0335C2A3R0CA01# |
| | | | 3.1pF | ±0.05pF | GRM0335C2A3R1WA01# |
| | | | | ±0.1pF | GRM0335C2A3R1BA01# |
| ±0.25pF | GRM0335C2A3R1CA01# | | | | |
| 3.2pF | ±0.05pF | GRM0335C2A3R2WA01# | | | |
| | ±0.1pF | GRM0335C2A3R2BA01# | | | |
| | ±0.25pF | GRM0335C2A3R2CA01# | | | |
| 3.3pF | ±0.05pF | GRM0335C2A3R3WA01# | | | |
| | ±0.1pF | GRM0335C2A3R3BA01# | | | |
| | ±0.25pF | GRM0335C2A3R3CA01# | | | |
| 3.4pF | ±0.05pF | GRM0335C2A3R4WA01# | | | |
| | ±0.1pF | GRM0335C2A3R4BA01# | | | |
| | ±0.25pF | GRM0335C2A3R4CA01# | | | |
| 3.5pF | ±0.05pF | GRM0335C2A3R5WA01# | | | |
| | ±0.1pF | GRM0335C2A3R5BA01# | | | |
| | ±0.25pF | GRM0335C2A3R5CA01# | | | |
| 3.6pF | ±0.05pF | GRM0335C2A3R6WA01# | | | |
| | ±0.1pF | GRM0335C2A3R6BA01# | | | |
| | ±0.25pF | GRM0335C2A3R6CA01# | | | |
| 3.7pF | ±0.05pF | GRM0335C2A3R7WA01# | | | |
| | ±0.1pF | GRM0335C2A3R7BA01# | | | |

0.6×0.3mm

| T max. | Rated Voltage | TC Code | Cap. | Tol. | Part Number |
|--------|---------------|---------|--------|---------|--------------------|
| 0.33mm | 100Vdc | COG | 0.10pF | ±0.05pF | GRM0335C2AR10WA01# |
| | | | 0.20pF | ±0.05pF | GRM0335C2AR20WA01# |
| | | | | ±0.1pF | GRM0335C2AR20BA01# |
| | | | 0.30pF | ±0.05pF | GRM0335C2AR30WA01# |
| | | | | ±0.1pF | GRM0335C2AR30BA01# |
| | | | 0.40pF | ±0.05pF | GRM0335C2AR40WA01# |
| | | | | ±0.1pF | GRM0335C2AR40BA01# |
| | | | 0.50pF | ±0.05pF | GRM0335C2AR50WA01# |
| | | | | ±0.1pF | GRM0335C2AR50BA01# |
| | | | 0.60pF | ±0.05pF | GRM0335C2AR60WA01# |
| | | | | ±0.1pF | GRM0335C2AR60BA01# |
| | | | 0.70pF | ±0.05pF | GRM0335C2AR70WA01# |
| | | | | ±0.1pF | GRM0335C2AR70BA01# |
| | | | 0.80pF | ±0.05pF | GRM0335C2AR80WA01# |
| | | | | ±0.1pF | GRM0335C2AR80BA01# |
| | | | 0.90pF | ±0.05pF | GRM0335C2AR90WA01# |
| | | | | ±0.1pF | GRM0335C2AR90BA01# |
| | | | 1.0pF | ±0.05pF | GRM0335C2A1R0WA01# |
| | | | | ±0.1pF | GRM0335C2A1R0BA01# |
| | | | | ±0.25pF | GRM0335C2A1R0CA01# |
| | | | 1.1pF | ±0.05pF | GRM0335C2A1R1WA01# |
| | | | | ±0.1pF | GRM0335C2A1R1BA01# |
| | | | | ±0.25pF | GRM0335C2A1R1CA01# |
| | | | 1.2pF | ±0.05pF | GRM0335C2A1R2WA01# |
| | | | | ±0.1pF | GRM0335C2A1R2BA01# |
| | | | | ±0.25pF | GRM0335C2A1R2CA01# |
| | | | 1.3pF | ±0.05pF | GRM0335C2A1R3WA01# |
| | | | | ±0.1pF | GRM0335C2A1R3BA01# |
| | | | | ±0.25pF | GRM0335C2A1R3CA01# |
| | | | 1.4pF | ±0.05pF | GRM0335C2A1R4WA01# |
| | | | | ±0.1pF | GRM0335C2A1R4BA01# |
| | | | | ±0.25pF | GRM0335C2A1R4CA01# |
| | | | 1.5pF | ±0.05pF | GRM0335C2A1R5WA01# |
| | | | | ±0.1pF | GRM0335C2A1R5BA01# |
| | | | | ±0.25pF | GRM0335C2A1R5CA01# |
| | | | 1.6pF | ±0.05pF | GRM0335C2A1R6WA01# |
| | | | | ±0.1pF | GRM0335C2A1R6BA01# |
| | | | | ±0.25pF | GRM0335C2A1R6CA01# |
| | | | 1.7pF | ±0.05pF | GRM0335C2A1R7WA01# |
| | | | | ±0.1pF | GRM0335C2A1R7BA01# |
| | | | | ±0.25pF | GRM0335C2A1R7CA01# |
| | | | 1.8pF | ±0.05pF | GRM0335C2A1R8WA01# |
| | | | | ±0.1pF | GRM0335C2A1R8BA01# |
| | | | | ±0.25pF | GRM0335C2A1R8CA01# |
| | | | 1.9pF | ±0.05pF | GRM0335C2A1R9WA01# |
| | | | | ±0.1pF | GRM0335C2A1R9BA01# |

Part number # indicates the package specification code.

GRM
 GR3
 GRJ
 GR4
 GR7
 GJM
 GQM
 GA2
 GA3 GB
 GA3 GD
 GA3 GF
 LLL
 LLA
 LLM
 LLR
 NFM
 KRM
 KR3
 GMA
 GMD
 ⚠Caution /Notice

GRM Series Temperature Compensating Type Part Number List

(→ 0.6×0.3mm)

| T max. | Rated Voltage | TC Code | Cap. | Tol. | Part Number |
|--------|---------------|---------|-------|---------|--------------------|
| 0.33mm | 100Vdc | COG | 3.7pF | ±0.25pF | GRM0335C2A3R7CA01# |
| | | | | ±0.05pF | GRM0335C2A3R8WA01# |
| | | | 3.8pF | ±0.1pF | GRM0335C2A3R8BA01# |
| | | | | ±0.25pF | GRM0335C2A3R8CA01# |
| | | | | ±0.05pF | GRM0335C2A3R9WA01# |
| | | | 3.9pF | ±0.1pF | GRM0335C2A3R9BA01# |
| | | | | ±0.25pF | GRM0335C2A3R9CA01# |
| | | | | ±0.05pF | GRM0335C2A4R0WA01# |
| | | | 4.0pF | ±0.1pF | GRM0335C2A4R0BA01# |
| | | | | ±0.25pF | GRM0335C2A4R0CA01# |
| | | | | ±0.05pF | GRM0335C2A4R1WA01# |
| | | | 4.1pF | ±0.1pF | GRM0335C2A4R1BA01# |
| | | | | ±0.25pF | GRM0335C2A4R1CA01# |
| | | | | ±0.05pF | GRM0335C2A4R2WA01# |
| | | | 4.2pF | ±0.1pF | GRM0335C2A4R2BA01# |
| | | | | ±0.25pF | GRM0335C2A4R2CA01# |
| | | | | ±0.05pF | GRM0335C2A4R3WA01# |
| | | | 4.3pF | ±0.1pF | GRM0335C2A4R3BA01# |
| | | | | ±0.25pF | GRM0335C2A4R3CA01# |
| | | | | ±0.05pF | GRM0335C2A4R4WA01# |
| | | | 4.4pF | ±0.1pF | GRM0335C2A4R4BA01# |
| | | | | ±0.25pF | GRM0335C2A4R4CA01# |
| | | | | ±0.05pF | GRM0335C2A4R5WA01# |
| | | | 4.5pF | ±0.1pF | GRM0335C2A4R5BA01# |
| | | | | ±0.25pF | GRM0335C2A4R5CA01# |
| | | | | ±0.05pF | GRM0335C2A4R6WA01# |
| | | | 4.6pF | ±0.1pF | GRM0335C2A4R6BA01# |
| | | | | ±0.25pF | GRM0335C2A4R6CA01# |
| | | | | ±0.05pF | GRM0335C2A4R7WA01# |
| | | | 4.7pF | ±0.1pF | GRM0335C2A4R7BA01# |
| | | | | ±0.25pF | GRM0335C2A4R7CA01# |
| | | | | ±0.05pF | GRM0335C2A4R8WA01# |
| | | | 4.8pF | ±0.1pF | GRM0335C2A4R8BA01# |
| | | | | ±0.25pF | GRM0335C2A4R8CA01# |
| | | | | ±0.05pF | GRM0335C2A4R9WA01# |
| | | | 4.9pF | ±0.1pF | GRM0335C2A4R9BA01# |
| | | | | ±0.25pF | GRM0335C2A4R9CA01# |
| | | | | ±0.05pF | GRM0335C2A5R0WA01# |
| | | | 5.0pF | ±0.1pF | GRM0335C2A5R0BA01# |
| | | | | ±0.25pF | GRM0335C2A5R0CA01# |
| | | | | ±0.05pF | GRM0335C2A5R1WA01# |
| | | | 5.1pF | ±0.1pF | GRM0335C2A5R1BA01# |
| | | | | ±0.25pF | GRM0335C2A5R1CA01# |
| | | | | ±0.5pF | GRM0335C2A5R1DA01# |
| | | | | ±0.05pF | GRM0335C2A5R2WA01# |
| | | | 5.2pF | ±0.1pF | GRM0335C2A5R2BA01# |
| | | | | ±0.25pF | GRM0335C2A5R2CA01# |
| | | | | ±0.5pF | GRM0335C2A5R2DA01# |
| | | | | ±0.05pF | GRM0335C2A5R3WA01# |
| | | | 5.3pF | ±0.1pF | GRM0335C2A5R3BA01# |
| | | | | ±0.25pF | GRM0335C2A5R3CA01# |
| | | | | ±0.5pF | GRM0335C2A5R3DA01# |
| | | | | ±0.05pF | GRM0335C2A5R4WA01# |
| | | | 5.4pF | ±0.1pF | GRM0335C2A5R4BA01# |

| T max. | Rated Voltage | TC Code | Cap. | Tol. | Part Number |
|--------|---------------|---------|-------|---------|--------------------|
| 0.33mm | 100Vdc | COG | 5.4pF | ±0.25pF | GRM0335C2A5R4CA01# |
| | | | | ±0.5pF | GRM0335C2A5R4DA01# |
| | | | 5.5pF | ±0.05pF | GRM0335C2A5R5WA01# |
| | | | | ±0.1pF | GRM0335C2A5R5BA01# |
| | | | | ±0.25pF | GRM0335C2A5R5CA01# |
| | | | 5.6pF | ±0.05pF | GRM0335C2A5R6WA01# |
| | | | | ±0.1pF | GRM0335C2A5R6BA01# |
| | | | | ±0.25pF | GRM0335C2A5R6CA01# |
| | | | 5.7pF | ±0.05pF | GRM0335C2A5R7WA01# |
| | | | | ±0.1pF | GRM0335C2A5R7BA01# |
| | | | | ±0.25pF | GRM0335C2A5R7CA01# |
| | | | 5.8pF | ±0.05pF | GRM0335C2A5R8WA01# |
| | | | | ±0.1pF | GRM0335C2A5R8BA01# |
| | | | | ±0.25pF | GRM0335C2A5R8CA01# |
| | | | 5.9pF | ±0.05pF | GRM0335C2A5R9WA01# |
| | | | | ±0.1pF | GRM0335C2A5R9BA01# |
| | | | | ±0.25pF | GRM0335C2A5R9CA01# |
| | | | 6.0pF | ±0.05pF | GRM0335C2A6R0WA01# |
| | | | | ±0.1pF | GRM0335C2A6R0BA01# |
| | | | | ±0.25pF | GRM0335C2A6R0CA01# |
| | | | 6.1pF | ±0.05pF | GRM0335C2A6R1WA01# |
| | | | | ±0.1pF | GRM0335C2A6R1BA01# |
| | | | | ±0.25pF | GRM0335C2A6R1CA01# |
| | | | 6.2pF | ±0.05pF | GRM0335C2A6R2WA01# |
| | | | | ±0.1pF | GRM0335C2A6R2BA01# |
| | | | | ±0.25pF | GRM0335C2A6R2CA01# |
| | | | 6.3pF | ±0.05pF | GRM0335C2A6R3WA01# |
| | | | | ±0.1pF | GRM0335C2A6R3BA01# |
| | | | | ±0.25pF | GRM0335C2A6R3CA01# |
| | | | 6.4pF | ±0.05pF | GRM0335C2A6R4WA01# |
| | | | | ±0.1pF | GRM0335C2A6R4BA01# |
| | | | | ±0.25pF | GRM0335C2A6R4CA01# |
| | | | 6.5pF | ±0.05pF | GRM0335C2A6R5WA01# |
| | | | | ±0.1pF | GRM0335C2A6R5BA01# |
| | | | | ±0.25pF | GRM0335C2A6R5CA01# |
| | | | 6.6pF | ±0.05pF | GRM0335C2A6R6WA01# |
| | | | | ±0.1pF | GRM0335C2A6R6BA01# |
| | | | | ±0.25pF | GRM0335C2A6R6CA01# |
| | | | 6.7pF | ±0.05pF | GRM0335C2A6R7WA01# |
| | | | | ±0.1pF | GRM0335C2A6R7BA01# |
| | | | | ±0.25pF | GRM0335C2A6R7CA01# |
| | | | 6.8pF | ±0.05pF | GRM0335C2A6R8WA01# |
| | | | | ±0.1pF | GRM0335C2A6R8BA01# |

- GRM
- GR3
- GRJ
- GR4
- GR7
- GJM
- GQM
- GA2
- GA3 GB
- GA3 GD
- GA3 GF
- LLL
- LLA
- LLM
- LLR
- NFM
- KRM
- KR3
- GMA
- GMD
- ⚠Caution /Notice

Part number # indicates the package specification code.

GRM Series Temperature Compensating Type Part Number List

(→ 0.6×0.3mm)

| T max. | Rated Voltage | TC Code | Cap. | Tol. | Part Number |
|--------|---------------|---------|-------|---------|--------------------|
| 0.33mm | 100Vdc | COG | 6.8pF | ±0.05pF | GRM0335C2A6R8WA01# |
| | | | | ±0.1pF | GRM0335C2A6R8BA01# |
| | | | | ±0.25pF | GRM0335C2A6R8CA01# |
| | | | | ±0.5pF | GRM0335C2A6R8DA01# |
| | | | 6.9pF | ±0.05pF | GRM0335C2A6R9WA01# |
| | | | | ±0.1pF | GRM0335C2A6R9BA01# |
| | | | | ±0.25pF | GRM0335C2A6R9CA01# |
| | | | | ±0.5pF | GRM0335C2A6R9DA01# |
| | | | 7.0pF | ±0.05pF | GRM0335C2A7R0WA01# |
| | | | | ±0.1pF | GRM0335C2A7R0BA01# |
| | | | | ±0.25pF | GRM0335C2A7R0CA01# |
| | | | | ±0.5pF | GRM0335C2A7R0DA01# |
| | | | 7.1pF | ±0.05pF | GRM0335C2A7R1WA01# |
| | | | | ±0.1pF | GRM0335C2A7R1BA01# |
| | | | | ±0.25pF | GRM0335C2A7R1CA01# |
| | | | | ±0.5pF | GRM0335C2A7R1DA01# |
| | | | 7.2pF | ±0.05pF | GRM0335C2A7R2WA01# |
| | | | | ±0.1pF | GRM0335C2A7R2BA01# |
| | | | | ±0.25pF | GRM0335C2A7R2CA01# |
| | | | | ±0.5pF | GRM0335C2A7R2DA01# |
| | | | 7.3pF | ±0.05pF | GRM0335C2A7R3WA01# |
| | | | | ±0.1pF | GRM0335C2A7R3BA01# |
| | | | | ±0.25pF | GRM0335C2A7R3CA01# |
| | | | | ±0.5pF | GRM0335C2A7R3DA01# |
| | | | 7.4pF | ±0.05pF | GRM0335C2A7R4WA01# |
| | | | | ±0.1pF | GRM0335C2A7R4BA01# |
| | | | | ±0.25pF | GRM0335C2A7R4CA01# |
| | | | | ±0.5pF | GRM0335C2A7R4DA01# |
| | | | 7.5pF | ±0.05pF | GRM0335C2A7R5WA01# |
| | | | | ±0.1pF | GRM0335C2A7R5BA01# |
| | | | | ±0.25pF | GRM0335C2A7R5CA01# |
| | | | | ±0.5pF | GRM0335C2A7R5DA01# |
| | | | 7.6pF | ±0.05pF | GRM0335C2A7R6WA01# |
| | | | | ±0.1pF | GRM0335C2A7R6BA01# |
| | | | | ±0.25pF | GRM0335C2A7R6CA01# |
| | | | | ±0.5pF | GRM0335C2A7R6DA01# |
| | | | 7.7pF | ±0.05pF | GRM0335C2A7R7WA01# |
| | | | | ±0.1pF | GRM0335C2A7R7BA01# |
| | | | | ±0.25pF | GRM0335C2A7R7CA01# |
| | | | | ±0.5pF | GRM0335C2A7R7DA01# |
| | | | 7.8pF | ±0.05pF | GRM0335C2A7R8WA01# |
| | | | | ±0.1pF | GRM0335C2A7R8BA01# |
| | | | | ±0.25pF | GRM0335C2A7R8CA01# |
| | | | | ±0.5pF | GRM0335C2A7R8DA01# |
| | | | 7.9pF | ±0.05pF | GRM0335C2A7R9WA01# |
| | | | | ±0.1pF | GRM0335C2A7R9BA01# |
| | | | | ±0.25pF | GRM0335C2A7R9CA01# |
| | | | | ±0.5pF | GRM0335C2A7R9DA01# |
| | | | 8.0pF | ±0.05pF | GRM0335C2A8R0WA01# |
| | | | | ±0.1pF | GRM0335C2A8R0BA01# |
| | | | | ±0.25pF | GRM0335C2A8R0CA01# |
| | | | | ±0.5pF | GRM0335C2A8R0DA01# |
| | | | 8.1pF | ±0.05pF | GRM0335C2A8R1WA01# |
| | | | | ±0.1pF | GRM0335C2A8R1BA01# |

| T max. | Rated Voltage | TC Code | Cap. | Tol. | Part Number |
|--------|---------------|---------|-------|---------|--------------------|
| 0.33mm | 100Vdc | COG | 8.1pF | ±0.25pF | GRM0335C2A8R1CA01# |
| | | | | ±0.5pF | GRM0335C2A8R1DA01# |
| | | | 8.2pF | ±0.05pF | GRM0335C2A8R2WA01# |
| | | | | ±0.1pF | GRM0335C2A8R2BA01# |
| | | | | ±0.25pF | GRM0335C2A8R2CA01# |
| | | | | ±0.5pF | GRM0335C2A8R2DA01# |
| | | | 8.3pF | ±0.05pF | GRM0335C2A8R3WA01# |
| | | | | ±0.1pF | GRM0335C2A8R3BA01# |
| | | | | ±0.25pF | GRM0335C2A8R3CA01# |
| | | | | ±0.5pF | GRM0335C2A8R3DA01# |
| | | | 8.4pF | ±0.05pF | GRM0335C2A8R4WA01# |
| | | | | ±0.1pF | GRM0335C2A8R4BA01# |
| | | | | ±0.25pF | GRM0335C2A8R4CA01# |
| | | | | ±0.5pF | GRM0335C2A8R4DA01# |
| | | | 8.5pF | ±0.05pF | GRM0335C2A8R5WA01# |
| | | | | ±0.1pF | GRM0335C2A8R5BA01# |
| | | | | ±0.25pF | GRM0335C2A8R5CA01# |
| | | | | ±0.5pF | GRM0335C2A8R5DA01# |
| | | | 8.6pF | ±0.05pF | GRM0335C2A8R6WA01# |
| | | | | ±0.1pF | GRM0335C2A8R6BA01# |
| | | | | ±0.25pF | GRM0335C2A8R6CA01# |
| | | | | ±0.5pF | GRM0335C2A8R6DA01# |
| | | | 8.7pF | ±0.05pF | GRM0335C2A8R7WA01# |
| | | | | ±0.1pF | GRM0335C2A8R7BA01# |
| | | | | ±0.25pF | GRM0335C2A8R7CA01# |
| | | | | ±0.5pF | GRM0335C2A8R7DA01# |
| | | | 8.8pF | ±0.05pF | GRM0335C2A8R8WA01# |
| | | | | ±0.1pF | GRM0335C2A8R8BA01# |
| | | | | ±0.25pF | GRM0335C2A8R8CA01# |
| | | | | ±0.5pF | GRM0335C2A8R8DA01# |
| | | | 8.9pF | ±0.05pF | GRM0335C2A8R9WA01# |
| | | | | ±0.1pF | GRM0335C2A8R9BA01# |
| | | | | ±0.25pF | GRM0335C2A8R9CA01# |
| | | | | ±0.5pF | GRM0335C2A8R9DA01# |
| | | | 9.0pF | ±0.05pF | GRM0335C2A9R0WA01# |
| | | | | ±0.1pF | GRM0335C2A9R0BA01# |
| | | | | ±0.25pF | GRM0335C2A9R0CA01# |
| | | | | ±0.5pF | GRM0335C2A9R0DA01# |
| | | | 9.1pF | ±0.05pF | GRM0335C2A9R1WA01# |
| | | | | ±0.1pF | GRM0335C2A9R1BA01# |
| | | | | ±0.25pF | GRM0335C2A9R1CA01# |
| | | | | ±0.5pF | GRM0335C2A9R1DA01# |
| | | | 9.2pF | ±0.05pF | GRM0335C2A9R2WA01# |
| | | | | ±0.1pF | GRM0335C2A9R2BA01# |
| | | | | ±0.25pF | GRM0335C2A9R2CA01# |
| | | | | ±0.5pF | GRM0335C2A9R2DA01# |
| | | | 9.3pF | ±0.05pF | GRM0335C2A9R3WA01# |
| | | | | ±0.1pF | GRM0335C2A9R3BA01# |
| | | | | ±0.25pF | GRM0335C2A9R3CA01# |
| | | | | ±0.5pF | GRM0335C2A9R3DA01# |
| | | | 9.4pF | ±0.05pF | GRM0335C2A9R4WA01# |
| | | | | ±0.1pF | GRM0335C2A9R4BA01# |
| | | | | ±0.25pF | GRM0335C2A9R4CA01# |
| | | | | ±0.5pF | GRM0335C2A9R4DA01# |

Part number # indicates the package specification code.

- GRM
- GR3
- GRJ
- GR4
- GR7
- GJM
- GQM
- GA2
- GA3 GB
- GA3 GD
- GA3 GF
- LLL
- LLA
- LLM
- LLR
- NFM
- KRM
- KR3
- GMA
- GMD
- ⚠Caution /Notice

GRM Series Temperature Compensating Type Part Number List

(→ 0.6×0.3mm)

| T max. | Rated Voltage | TC Code | Cap. | Tol. | Part Number |
|--------|---------------|---------|-------|---------|--------------------|
| 0.33mm | 100Vdc | COG | 9.5pF | ±0.05pF | GRM0335C2A9R5WA01# |
| | | | | ±0.1pF | GRM0335C2A9R5BA01# |
| | | | | ±0.25pF | GRM0335C2A9R5CA01# |
| | | | | ±0.5pF | GRM0335C2A9R5DA01# |
| | | | 9.6pF | ±0.05pF | GRM0335C2A9R6WA01# |
| | | | | ±0.1pF | GRM0335C2A9R6BA01# |
| | | | | ±0.25pF | GRM0335C2A9R6CA01# |
| | | | | ±0.5pF | GRM0335C2A9R6DA01# |
| | | | 9.7pF | ±0.05pF | GRM0335C2A9R7WA01# |
| | | | | ±0.1pF | GRM0335C2A9R7BA01# |
| | | | | ±0.25pF | GRM0335C2A9R7CA01# |
| | | | | ±0.5pF | GRM0335C2A9R7DA01# |
| | | | 9.8pF | ±0.05pF | GRM0335C2A9R8WA01# |
| | | | | ±0.1pF | GRM0335C2A9R8BA01# |
| | | | | ±0.25pF | GRM0335C2A9R8CA01# |
| | | | | ±0.5pF | GRM0335C2A9R8DA01# |
| | | | 9.9pF | ±0.05pF | GRM0335C2A9R9WA01# |
| | | | | ±0.1pF | GRM0335C2A9R9BA01# |
| | | | | ±0.25pF | GRM0335C2A9R9CA01# |
| | | | | ±0.5pF | GRM0335C2A9R9DA01# |
| | | | 10pF | ±2% | GRM0335C2A100GA01# |
| | | | | ±5% | GRM0335C2A100JA01# |
| | | | 12pF | ±2% | GRM0335C2A120GA01# |
| | | | | ±5% | GRM0335C2A120JA01# |
| | | | 15pF | ±2% | GRM0335C2A150GA01# |
| | | | | ±5% | GRM0335C2A150JA01# |
| | | | 18pF | ±2% | GRM0335C2A180GA01# |
| | | | | ±5% | GRM0335C2A180JA01# |
| | | | 20pF | ±2% | GRM0335C2A200GA01# |
| | | | | ±5% | GRM0335C2A200JA01# |
| | | | 22pF | ±2% | GRM0335C2A220GA01# |
| | | | | ±5% | GRM0335C2A220JA01# |
| | | | 24pF | ±2% | GRM0335C2A240GA01# |
| | | | | ±5% | GRM0335C2A240JA01# |
| | | | 27pF | ±2% | GRM0335C2A270GA01# |
| | | | | ±5% | GRM0335C2A270JA01# |
| | | | 30pF | ±2% | GRM0335C2A300GA01# |
| | | | | ±5% | GRM0335C2A300JA01# |
| | | | 33pF | ±2% | GRM0335C2A330GA01# |
| | | | | ±5% | GRM0335C2A330JA01# |
| | | | 36pF | ±2% | GRM0335C2A360GA01# |
| | | | | ±5% | GRM0335C2A360JA01# |
| | | | 39pF | ±2% | GRM0335C2A390GA01# |
| | | | | ±5% | GRM0335C2A390JA01# |
| | | | 43pF | ±2% | GRM0335C2A430GA01# |
| | | | | ±5% | GRM0335C2A430JA01# |
| | | | 47pF | ±2% | GRM0335C2A470GA01# |
| | | | | ±5% | GRM0335C2A470JA01# |
| | | | 51pF | ±2% | GRM0335C2A510GA01# |
| | | | | ±5% | GRM0335C2A510JA01# |
| | | | 56pF | ±2% | GRM0335C2A560GA01# |
| | | | | ±5% | GRM0335C2A560JA01# |
| | | | 62pF | ±2% | GRM0335C2A620GA01# |
| | | | | ±5% | GRM0335C2A620JA01# |

| T max. | Rated Voltage | TC Code | Cap. | Tol. | Part Number | |
|--------|---------------|---------|---------|--------------------|--------------------|--------------------|
| 0.33mm | 100Vdc | COG | 68pF | ±2% | GRM0335C2A680GA01# | |
| | | | | ±5% | GRM0335C2A680JA01# | |
| | | | 75pF | ±2% | GRM0335C2A750GA01# | |
| | | | | ±5% | GRM0335C2A750JA01# | |
| | | | 82pF | ±2% | GRM0335C2A820GA01# | |
| | | | | ±5% | GRM0335C2A820JA01# | |
| | | | 91pF | ±2% | GRM0335C2A910GA01# | |
| | | | | ±5% | GRM0335C2A910JA01# | |
| | | | 100pF | ±2% | GRM0335C2A101GA01# | |
| | | | | ±5% | GRM0335C2A101JA01# | |
| | | | | CK | ±0.05pF | GRM0334C2AR10WA01# |
| | | | ±0.20pF | | ±0.05pF | GRM0334C2AR20WA01# |
| | | | | | ±0.1pF | GRM0334C2AR20BA01# |
| | | | ±0.30pF | | ±0.05pF | GRM0334C2AR30WA01# |
| | | | | | ±0.1pF | GRM0334C2AR30BA01# |
| | | | ±0.40pF | | ±0.05pF | GRM0334C2AR40WA01# |
| | | | | | ±0.1pF | GRM0334C2AR40BA01# |
| | | | ±0.50pF | | ±0.05pF | GRM0334C2AR50WA01# |
| | | | | | ±0.1pF | GRM0334C2AR50BA01# |
| | | | ±0.60pF | | ±0.05pF | GRM0334C2AR60WA01# |
| | | | | | ±0.1pF | GRM0334C2AR60BA01# |
| | | | ±0.70pF | | ±0.05pF | GRM0334C2AR70WA01# |
| | | | | | ±0.1pF | GRM0334C2AR70BA01# |
| | | | ±0.80pF | | ±0.05pF | GRM0334C2AR80WA01# |
| | | | | | ±0.1pF | GRM0334C2AR80BA01# |
| | | | ±0.90pF | | ±0.05pF | GRM0334C2AR90WA01# |
| | | | | | ±0.1pF | GRM0334C2AR90BA01# |
| | | | ±1.0pF | | ±0.05pF | GRM0334C2A1R0WA01# |
| | | | | | ±0.1pF | GRM0334C2A1R0BA01# |
| | | | | | ±0.25pF | GRM0334C2A1R0CA01# |
| | | ±1.1pF | ±0.05pF | | GRM0334C2A1R1WA01# | |
| | | | ±0.1pF | | GRM0334C2A1R1BA01# | |
| | | | ±0.25pF | | GRM0334C2A1R1CA01# | |
| | | ±1.2pF | ±0.05pF | | GRM0334C2A1R2WA01# | |
| | | | ±0.1pF | | GRM0334C2A1R2BA01# | |
| | | | ±0.25pF | | GRM0334C2A1R2CA01# | |
| | | ±1.3pF | ±0.05pF | | GRM0334C2A1R3WA01# | |
| | | | ±0.1pF | | GRM0334C2A1R3BA01# | |
| | | | ±0.25pF | | GRM0334C2A1R3CA01# | |
| | | ±1.4pF | ±0.05pF | | GRM0334C2A1R4WA01# | |
| | | | ±0.1pF | GRM0334C2A1R4BA01# | | |
| | | | ±0.25pF | GRM0334C2A1R4CA01# | | |
| | | ±1.5pF | ±0.05pF | GRM0334C2A1R5WA01# | | |
| | | | ±0.1pF | GRM0334C2A1R5BA01# | | |
| | | | ±0.25pF | GRM0334C2A1R5CA01# | | |
| | | ±1.6pF | ±0.05pF | GRM0334C2A1R6WA01# | | |
| | | | ±0.1pF | GRM0334C2A1R6BA01# | | |
| | | | ±0.25pF | GRM0334C2A1R6CA01# | | |
| | | ±1.7pF | ±0.05pF | GRM0334C2A1R7WA01# | | |
| | | | ±0.1pF | GRM0334C2A1R7BA01# | | |
| | | | ±0.25pF | GRM0334C2A1R7CA01# | | |
| | | ±1.8pF | ±0.05pF | GRM0334C2A1R8WA01# | | |
| | | | ±0.1pF | GRM0334C2A1R8BA01# | | |
| | | | ±0.25pF | GRM0334C2A1R8CA01# | | |

- GRM
- GR3
- GRJ
- GR4
- GR7
- GJM
- GQM
- GA2
- GA3 GB
- GA3 GD
- GA3 GF
- LLL
- LLA
- LLM
- LLR
- NFM
- KRM
- KR3
- GMA
- GMD
- ⚠Caution /Notice

Part number # indicates the package specification code.

GRM Series Temperature Compensating Type Part Number List

(→ 0.6×0.3mm)

| T max. | Rated Voltage | TC Code | Cap. | Tol. | Part Number | T max. | Rated Voltage | TC Code | Cap. | Tol. | Part Number | | | |
|--------|---------------|---------|---------|--------------------|--------------------|---------|--------------------|--------------------|--------------------|---------|--------------------|--------------------|--------------------|--------------------|
| 0.33mm | 100Vdc | CK | 1.9pF | ±0.05pF | GRM0334C2A1R9WA01# | 0.33mm | 100Vdc | CJ | 3.7pF | ±0.05pF | GRM0333C2A3R7WA01# | | | |
| | | | | ±0.1pF | GRM0334C2A1R9BA01# | | | | | ±0.1pF | GRM0333C2A3R7BA01# | | | |
| | | | | ±0.25pF | GRM0334C2A1R9CA01# | | | | | ±0.25pF | GRM0333C2A3R7CA01# | | | |
| | | | 2.0pF | ±0.05pF | GRM0334C2A2R0WA01# | | | | | 3.8pF | ±0.05pF | GRM0333C2A3R8WA01# | | |
| | | | | ±0.1pF | GRM0334C2A2R0BA01# | | | | | | ±0.1pF | GRM0333C2A3R8BA01# | | |
| | | | | ±0.25pF | GRM0334C2A2R0CA01# | | | | | | ±0.25pF | GRM0333C2A3R8CA01# | | |
| | | | 2.1pF | ±0.05pF | GRM0333C2A2R1WA01# | | | | | | 3.9pF | ±0.05pF | GRM0333C2A3R9WA01# | |
| | | | | ±0.1pF | GRM0333C2A2R1BA01# | | | | | | | ±0.1pF | GRM0333C2A3R9BA01# | |
| | | | | ±0.25pF | GRM0333C2A2R1CA01# | | | | | | | ±0.25pF | GRM0333C2A3R9CA01# | |
| | | | 2.2pF | ±0.05pF | GRM0333C2A2R2WA01# | | | | 4.0pF | | | ±0.05pF | GRM0332C2A4R0WA01# | |
| | | | | ±0.1pF | GRM0333C2A2R2BA01# | | | | | | | ±0.1pF | GRM0332C2A4R0BA01# | |
| | | | | ±0.25pF | GRM0333C2A2R2CA01# | | | | | | | ±0.25pF | GRM0332C2A4R0CA01# | |
| | | | 2.3pF | ±0.05pF | GRM0333C2A2R3WA01# | | | | | 4.1pF | | ±0.05pF | GRM0332C2A4R1WA01# | |
| | | | | ±0.1pF | GRM0333C2A2R3BA01# | | | | | | | ±0.1pF | GRM0332C2A4R1BA01# | |
| | | | | ±0.25pF | GRM0333C2A2R3CA01# | | | | | | | ±0.25pF | GRM0332C2A4R1CA01# | |
| | | | 2.4pF | ±0.05pF | GRM0333C2A2R4WA01# | | | | | | 4.2pF | ±0.05pF | GRM0332C2A4R2WA01# | |
| | | | | ±0.1pF | GRM0333C2A2R4BA01# | | | | | | | ±0.1pF | GRM0332C2A4R2BA01# | |
| | | | | ±0.25pF | GRM0333C2A2R4CA01# | | | | | | | ±0.25pF | GRM0332C2A4R2CA01# | |
| | | | 2.5pF | ±0.05pF | GRM0333C2A2R5WA01# | | | | 4.3pF | | | ±0.05pF | GRM0332C2A4R3WA01# | |
| | | | | ±0.1pF | GRM0333C2A2R5BA01# | | | | | | | ±0.1pF | GRM0332C2A4R3BA01# | |
| | | | | ±0.25pF | GRM0333C2A2R5CA01# | | | | | | | ±0.25pF | GRM0332C2A4R3CA01# | |
| | | | 2.6pF | ±0.05pF | GRM0333C2A2R6WA01# | | | | | 4.4pF | | ±0.05pF | GRM0332C2A4R4WA01# | |
| | | | | ±0.1pF | GRM0333C2A2R6BA01# | | | | | | | ±0.1pF | GRM0332C2A4R4BA01# | |
| | | | | ±0.25pF | GRM0333C2A2R6CA01# | | | | | | | ±0.25pF | GRM0332C2A4R4CA01# | |
| | | | 2.7pF | ±0.05pF | GRM0333C2A2R7WA01# | | | | | | 4.5pF | ±0.05pF | GRM0332C2A4R5WA01# | |
| | | | | ±0.1pF | GRM0333C2A2R7BA01# | | | | | | | ±0.1pF | GRM0332C2A4R5BA01# | |
| | | | | ±0.25pF | GRM0333C2A2R7CA01# | | | | | | | ±0.25pF | GRM0332C2A4R5CA01# | |
| | | | 2.8pF | ±0.05pF | GRM0333C2A2R8WA01# | | | | 4.6pF | | | ±0.05pF | GRM0332C2A4R6WA01# | |
| | | | | ±0.1pF | GRM0333C2A2R8BA01# | | | | | | | ±0.1pF | GRM0332C2A4R6BA01# | |
| | | | | ±0.25pF | GRM0333C2A2R8CA01# | | | | | | | ±0.25pF | GRM0332C2A4R6CA01# | |
| | | | 2.9pF | ±0.05pF | GRM0333C2A2R9WA01# | | | | | 4.7pF | | ±0.05pF | GRM0332C2A4R7WA01# | |
| | | | | ±0.1pF | GRM0333C2A2R9BA01# | | | | | | | ±0.1pF | GRM0332C2A4R7BA01# | |
| | | | | ±0.25pF | GRM0333C2A2R9CA01# | | | | | | | ±0.25pF | GRM0332C2A4R7CA01# | |
| | | | 3.0pF | ±0.05pF | GRM0333C2A3R0WA01# | | | | | | 4.8pF | ±0.05pF | GRM0332C2A4R8WA01# | |
| | | | | ±0.1pF | GRM0333C2A3R0BA01# | | | | | | | ±0.1pF | GRM0332C2A4R8BA01# | |
| | | | | ±0.25pF | GRM0333C2A3R0CA01# | | | | | | | ±0.25pF | GRM0332C2A4R8CA01# | |
| | | 3.1pF | ±0.05pF | GRM0333C2A3R1WA01# | 4.9pF | ±0.05pF | GRM0332C2A4R9WA01# | | | | | | | |
| | | | ±0.1pF | GRM0333C2A3R1BA01# | | ±0.1pF | GRM0332C2A4R9BA01# | | | | | | | |
| | | | ±0.25pF | GRM0333C2A3R1CA01# | | ±0.25pF | GRM0332C2A4R9CA01# | | | | | | | |
| | | 3.2pF | ±0.05pF | GRM0333C2A3R2WA01# | | 5.0pF | ±0.05pF | GRM0332C2A5R0WA01# | | | | | | |
| | | | ±0.1pF | GRM0333C2A3R2BA01# | | | ±0.1pF | GRM0332C2A5R0BA01# | | | | | | |
| | | | ±0.25pF | GRM0333C2A3R2CA01# | | | ±0.25pF | GRM0332C2A5R0CA01# | | | | | | |
| | | 3.3pF | ±0.05pF | GRM0333C2A3R3WA01# | | | 5.1pF | ±0.05pF | GRM0332C2A5R1WA01# | | | | | |
| | | | ±0.1pF | GRM0333C2A3R3BA01# | | | | ±0.1pF | GRM0332C2A5R1BA01# | | | | | |
| | | | ±0.25pF | GRM0333C2A3R3CA01# | | | | ±0.25pF | GRM0332C2A5R1CA01# | | | | | |
| | | 3.4pF | ±0.05pF | GRM0333C2A3R4WA01# | 5.2pF | | | ±0.05pF | GRM0332C2A5R2WA01# | | | | | |
| | | | ±0.1pF | GRM0333C2A3R4BA01# | | | | ±0.1pF | GRM0332C2A5R2BA01# | | | | | |
| | | | ±0.25pF | GRM0333C2A3R4CA01# | | | | ±0.25pF | GRM0332C2A5R2CA01# | | | | | |
| | | 3.5pF | ±0.05pF | GRM0333C2A3R5WA01# | | 5.3pF | | ±0.05pF | GRM0332C2A5R3WA01# | | | | | |
| | | | ±0.1pF | GRM0333C2A3R5BA01# | | | | ±0.1pF | GRM0332C2A5R3BA01# | | | | | |
| | | | ±0.25pF | GRM0333C2A3R5CA01# | | | | ±0.25pF | GRM0332C2A5R3CA01# | | | | | |
| | | 3.6pF | ±0.05pF | GRM0333C2A3R6WA01# | | | 5.3pF | ±0.05pF | GRM0332C2A5R3WA01# | | | | | |
| | | | ±0.1pF | GRM0333C2A3R6BA01# | | | | ±0.1pF | GRM0332C2A5R3BA01# | | | | | |
| | | | ±0.25pF | GRM0333C2A3R6CA01# | | | | ±0.25pF | GRM0332C2A5R3CA01# | | | | | |
| | | | | | | | | | | | | | ±0.5pF | GRM0332C2A5R3DA01# |

Part number # indicates the package specification code.

- GRM
- GR3
- GRJ
- GR4
- GR7
- GJM
- GQM
- GA2
- GA3 GB
- GA3 GD
- GA3 GF
- LLL
- LLA
- LLM
- LLR
- NFM
- KRM
- KR3
- GMA
- GMD
- ⚠Caution /Notice

GRM Series Temperature Compensating Type Part Number List

(→ 0.6×0.3mm)

| T max. | Rated Voltage | TC Code | Cap. | Tol. | Part Number |
|--------|---------------|---------|-------|---------|--------------------|
| 0.33mm | 100Vdc | CH | 5.4pF | ±0.05pF | GRM0332C2A5R4WA01# |
| | | | | ±0.1pF | GRM0332C2A5R4BA01# |
| | | | | ±0.25pF | GRM0332C2A5R4CA01# |
| | | | | ±0.5pF | GRM0332C2A5R4DA01# |
| | | | 5.5pF | ±0.05pF | GRM0332C2A5R5WA01# |
| | | | | ±0.1pF | GRM0332C2A5R5BA01# |
| | | | | ±0.25pF | GRM0332C2A5R5CA01# |
| | | | | ±0.5pF | GRM0332C2A5R5DA01# |
| | | | 5.6pF | ±0.05pF | GRM0332C2A5R6WA01# |
| | | | | ±0.1pF | GRM0332C2A5R6BA01# |
| | | | | ±0.25pF | GRM0332C2A5R6CA01# |
| | | | | ±0.5pF | GRM0332C2A5R6DA01# |
| | | | 5.7pF | ±0.05pF | GRM0332C2A5R7WA01# |
| | | | | ±0.1pF | GRM0332C2A5R7BA01# |
| | | | | ±0.25pF | GRM0332C2A5R7CA01# |
| | | | | ±0.5pF | GRM0332C2A5R7DA01# |
| | | | 5.8pF | ±0.05pF | GRM0332C2A5R8WA01# |
| | | | | ±0.1pF | GRM0332C2A5R8BA01# |
| | | | | ±0.25pF | GRM0332C2A5R8CA01# |
| | | | | ±0.5pF | GRM0332C2A5R8DA01# |
| | | | 5.9pF | ±0.05pF | GRM0332C2A5R9WA01# |
| | | | | ±0.1pF | GRM0332C2A5R9BA01# |
| | | | | ±0.25pF | GRM0332C2A5R9CA01# |
| | | | | ±0.5pF | GRM0332C2A5R9DA01# |
| | | | 6.0pF | ±0.05pF | GRM0332C2A6R0WA01# |
| | | | | ±0.1pF | GRM0332C2A6R0BA01# |
| | | | | ±0.25pF | GRM0332C2A6R0CA01# |
| | | | | ±0.5pF | GRM0332C2A6R0DA01# |
| | | | 6.1pF | ±0.05pF | GRM0332C2A6R1WA01# |
| | | | | ±0.1pF | GRM0332C2A6R1BA01# |
| | | | | ±0.25pF | GRM0332C2A6R1CA01# |
| | | | | ±0.5pF | GRM0332C2A6R1DA01# |
| | | | 6.2pF | ±0.05pF | GRM0332C2A6R2WA01# |
| | | | | ±0.1pF | GRM0332C2A6R2BA01# |
| | | | | ±0.25pF | GRM0332C2A6R2CA01# |
| | | | | ±0.5pF | GRM0332C2A6R2DA01# |
| | | | 6.3pF | ±0.05pF | GRM0332C2A6R3WA01# |
| | | | | ±0.1pF | GRM0332C2A6R3BA01# |
| | | | | ±0.25pF | GRM0332C2A6R3CA01# |
| | | | | ±0.5pF | GRM0332C2A6R3DA01# |
| | | | 6.4pF | ±0.05pF | GRM0332C2A6R4WA01# |
| | | | | ±0.1pF | GRM0332C2A6R4BA01# |
| | | | | ±0.25pF | GRM0332C2A6R4CA01# |
| | | | | ±0.5pF | GRM0332C2A6R4DA01# |
| | | | 6.5pF | ±0.05pF | GRM0332C2A6R5WA01# |
| | | | | ±0.1pF | GRM0332C2A6R5BA01# |
| | | | | ±0.25pF | GRM0332C2A6R5CA01# |
| | | | | ±0.5pF | GRM0332C2A6R5DA01# |
| | | | 6.6pF | ±0.05pF | GRM0332C2A6R6WA01# |
| | | | | ±0.1pF | GRM0332C2A6R6BA01# |
| | | | | ±0.25pF | GRM0332C2A6R6CA01# |
| | | | | ±0.5pF | GRM0332C2A6R6DA01# |
| | | | 6.7pF | ±0.05pF | GRM0332C2A6R7WA01# |
| | | | | ±0.1pF | GRM0332C2A6R7BA01# |

| T max. | Rated Voltage | TC Code | Cap. | Tol. | Part Number |
|--------|---------------|---------|-------|---------|--------------------|
| 0.33mm | 100Vdc | CH | 6.7pF | ±0.25pF | GRM0332C2A6R7CA01# |
| | | | | ±0.5pF | GRM0332C2A6R7DA01# |
| | | | 6.8pF | ±0.05pF | GRM0332C2A6R8WA01# |
| | | | | ±0.1pF | GRM0332C2A6R8BA01# |
| | | | | ±0.25pF | GRM0332C2A6R8CA01# |
| | | | 6.9pF | ±0.05pF | GRM0332C2A6R9WA01# |
| | | | | ±0.1pF | GRM0332C2A6R9BA01# |
| | | | | ±0.25pF | GRM0332C2A6R9CA01# |
| | | | 7.0pF | ±0.05pF | GRM0332C2A7R0WA01# |
| | | | | ±0.1pF | GRM0332C2A7R0BA01# |
| | | | | ±0.25pF | GRM0332C2A7R0CA01# |
| | | | 7.1pF | ±0.05pF | GRM0332C2A7R1WA01# |
| | | | | ±0.1pF | GRM0332C2A7R1BA01# |
| | | | | ±0.25pF | GRM0332C2A7R1CA01# |
| | | | 7.2pF | ±0.05pF | GRM0332C2A7R2WA01# |
| | | | | ±0.1pF | GRM0332C2A7R2BA01# |
| | | | | ±0.25pF | GRM0332C2A7R2CA01# |
| | | | 7.3pF | ±0.05pF | GRM0332C2A7R3WA01# |
| | | | | ±0.1pF | GRM0332C2A7R3BA01# |
| | | | | ±0.25pF | GRM0332C2A7R3CA01# |
| | | | 7.4pF | ±0.05pF | GRM0332C2A7R4WA01# |
| | | | | ±0.1pF | GRM0332C2A7R4BA01# |
| | | | | ±0.25pF | GRM0332C2A7R4CA01# |
| | | | 7.5pF | ±0.05pF | GRM0332C2A7R5WA01# |
| | | | | ±0.1pF | GRM0332C2A7R5BA01# |
| | | | | ±0.25pF | GRM0332C2A7R5CA01# |
| | | | 7.6pF | ±0.05pF | GRM0332C2A7R6WA01# |
| | | | | ±0.1pF | GRM0332C2A7R6BA01# |
| | | | | ±0.25pF | GRM0332C2A7R6CA01# |
| | | | 7.7pF | ±0.05pF | GRM0332C2A7R7WA01# |
| | | | | ±0.1pF | GRM0332C2A7R7BA01# |
| | | | | ±0.25pF | GRM0332C2A7R7CA01# |
| | | | 7.8pF | ±0.05pF | GRM0332C2A7R8WA01# |
| | | | | ±0.1pF | GRM0332C2A7R8BA01# |
| | | | | ±0.25pF | GRM0332C2A7R8CA01# |
| | | | 7.9pF | ±0.05pF | GRM0332C2A7R9WA01# |
| | | | | ±0.1pF | GRM0332C2A7R9BA01# |
| | | | | ±0.25pF | GRM0332C2A7R9CA01# |
| | | | 8.0pF | ±0.05pF | GRM0332C2A8R0WA01# |
| | | | | ±0.1pF | GRM0332C2A8R0BA01# |
| | | | | ±0.25pF | GRM0332C2A8R0CA01# |

- GRM
- GR3
- GRJ
- GR4
- GR7
- GJM
- GQM
- GA2
- GA3 GB
- GA3 GD
- GA3 GF
- LLL
- LLA
- LLM
- LLR
- NFM
- KRM
- KR3
- GMA
- GMD
- ⚠Caution /Notice

Part number # indicates the package specification code.

GRM Series Temperature Compensating Type Part Number List

(→ 0.6×0.3mm)

| T max. | Rated Voltage | TC Code | Cap. | Tol. | Part Number |
|--------|---------------|--------------------|-------|---------|--------------------|
| 0.33mm | 100Vdc | CH | 8.1pF | ±0.05pF | GRM0332C2A8R1WA01# |
| | | | | ±0.1pF | GRM0332C2A8R1BA01# |
| | | | | ±0.25pF | GRM0332C2A8R1CA01# |
| | | | | ±0.5pF | GRM0332C2A8R1DA01# |
| | | | 8.2pF | ±0.05pF | GRM0332C2A8R2WA01# |
| | | | | ±0.1pF | GRM0332C2A8R2BA01# |
| | | | | ±0.25pF | GRM0332C2A8R2CA01# |
| | | | | ±0.5pF | GRM0332C2A8R2DA01# |
| | | | 8.3pF | ±0.05pF | GRM0332C2A8R3WA01# |
| | | | | ±0.1pF | GRM0332C2A8R3BA01# |
| | | | | ±0.25pF | GRM0332C2A8R3CA01# |
| | | | | ±0.5pF | GRM0332C2A8R3DA01# |
| | | | 8.4pF | ±0.05pF | GRM0332C2A8R4WA01# |
| | | | | ±0.1pF | GRM0332C2A8R4BA01# |
| | | | | ±0.25pF | GRM0332C2A8R4CA01# |
| | | | | ±0.5pF | GRM0332C2A8R4DA01# |
| | | | 8.5pF | ±0.05pF | GRM0332C2A8R5WA01# |
| | | | | ±0.1pF | GRM0332C2A8R5BA01# |
| | | | | ±0.25pF | GRM0332C2A8R5CA01# |
| | | | | ±0.5pF | GRM0332C2A8R5DA01# |
| | | | 8.6pF | ±0.05pF | GRM0332C2A8R6WA01# |
| | | | | ±0.1pF | GRM0332C2A8R6BA01# |
| | | | | ±0.25pF | GRM0332C2A8R6CA01# |
| | | | | ±0.5pF | GRM0332C2A8R6DA01# |
| | | | 8.7pF | ±0.05pF | GRM0332C2A8R7WA01# |
| | | | | ±0.1pF | GRM0332C2A8R7BA01# |
| | | | | ±0.25pF | GRM0332C2A8R7CA01# |
| | | | | ±0.5pF | GRM0332C2A8R7DA01# |
| | | | 8.8pF | ±0.05pF | GRM0332C2A8R8WA01# |
| | | | | ±0.1pF | GRM0332C2A8R8BA01# |
| | | | | ±0.25pF | GRM0332C2A8R8CA01# |
| | | | | ±0.5pF | GRM0332C2A8R8DA01# |
| | | | 8.9pF | ±0.05pF | GRM0332C2A8R9WA01# |
| | | | | ±0.1pF | GRM0332C2A8R9BA01# |
| | | | | ±0.25pF | GRM0332C2A8R9CA01# |
| | | | | ±0.5pF | GRM0332C2A8R9DA01# |
| | | | 9.0pF | ±0.05pF | GRM0332C2A9R0WA01# |
| | | | | ±0.1pF | GRM0332C2A9R0BA01# |
| | | | | ±0.25pF | GRM0332C2A9R0CA01# |
| | | | | ±0.5pF | GRM0332C2A9R0DA01# |
| | | | 9.1pF | ±0.05pF | GRM0332C2A9R1WA01# |
| | | | | ±0.1pF | GRM0332C2A9R1BA01# |
| | | | | ±0.25pF | GRM0332C2A9R1CA01# |
| | | | | ±0.5pF | GRM0332C2A9R1DA01# |
| | | | 9.2pF | ±0.05pF | GRM0332C2A9R2WA01# |
| | | | | ±0.1pF | GRM0332C2A9R2BA01# |
| | | | | ±0.25pF | GRM0332C2A9R2CA01# |
| | | | | ±0.5pF | GRM0332C2A9R2DA01# |
| 9.3pF | ±0.05pF | GRM0332C2A9R3WA01# | | | |
| | ±0.1pF | GRM0332C2A9R3BA01# | | | |
| | ±0.25pF | GRM0332C2A9R3CA01# | | | |
| | ±0.5pF | GRM0332C2A9R3DA01# | | | |
| 9.4pF | ±0.05pF | GRM0332C2A9R4WA01# | | | |
| | ±0.1pF | GRM0332C2A9R4BA01# | | | |

| T max. | Rated Voltage | TC Code | Cap. | Tol. | Part Number |
|--------|--------------------|---------|-------|---------|--------------------|
| 0.33mm | 100Vdc | CH | 9.4pF | ±0.25pF | GRM0332C2A9R4CA01# |
| | | | | ±0.5pF | GRM0332C2A9R4DA01# |
| | | | 9.5pF | ±0.05pF | GRM0332C2A9R5WA01# |
| | | | | ±0.1pF | GRM0332C2A9R5BA01# |
| | | | | ±0.25pF | GRM0332C2A9R5CA01# |
| | | | 9.6pF | ±0.05pF | GRM0332C2A9R6WA01# |
| | | | | ±0.1pF | GRM0332C2A9R6BA01# |
| | | | | ±0.25pF | GRM0332C2A9R6CA01# |
| | | | 9.7pF | ±0.05pF | GRM0332C2A9R7WA01# |
| | | | | ±0.1pF | GRM0332C2A9R7BA01# |
| | | | | ±0.25pF | GRM0332C2A9R7CA01# |
| | | | 9.8pF | ±0.05pF | GRM0332C2A9R8WA01# |
| | | | | ±0.1pF | GRM0332C2A9R8BA01# |
| | | | | ±0.25pF | GRM0332C2A9R8CA01# |
| | | | 9.9pF | ±0.05pF | GRM0332C2A9R9WA01# |
| | | | | ±0.1pF | GRM0332C2A9R9BA01# |
| | | | | ±0.25pF | GRM0332C2A9R9CA01# |
| | | | 10pF | ±2% | GRM0332C2A100GA01# |
| | | | | ±5% | GRM0332C2A100JA01# |
| | | | 12pF | ±2% | GRM0332C2A120GA01# |
| | | | | ±5% | GRM0332C2A120JA01# |
| | | | 15pF | ±2% | GRM0332C2A150GA01# |
| | | | | ±5% | GRM0332C2A150JA01# |
| | | | 18pF | ±2% | GRM0332C2A180GA01# |
| | | | | ±5% | GRM0332C2A180JA01# |
| | | | 20pF | ±2% | GRM0332C2A200GA01# |
| | | | | ±5% | GRM0332C2A200JA01# |
| | | | 22pF | ±2% | GRM0332C2A220GA01# |
| | | | | ±5% | GRM0332C2A220JA01# |
| | | | 24pF | ±2% | GRM0332C2A240GA01# |
| | | | | ±5% | GRM0332C2A240JA01# |
| | | | 27pF | ±2% | GRM0332C2A270GA01# |
| | | | | ±5% | GRM0332C2A270JA01# |
| | | | 30pF | ±2% | GRM0332C2A300GA01# |
| | | | | ±5% | GRM0332C2A300JA01# |
| | | | 33pF | ±2% | GRM0332C2A330GA01# |
| | | | | ±5% | GRM0332C2A330JA01# |
| | | | 36pF | ±2% | GRM0332C2A360GA01# |
| | | | | ±5% | GRM0332C2A360JA01# |
| | | | 39pF | ±2% | GRM0332C2A390GA01# |
| | | | | ±5% | GRM0332C2A390JA01# |
| | | | 43pF | ±2% | GRM0332C2A430GA01# |
| | | | | ±5% | GRM0332C2A430JA01# |
| | | | 47pF | ±2% | GRM0332C2A470GA01# |
| | | | | ±5% | GRM0332C2A470JA01# |
| | | | 51pF | ±2% | GRM0332C2A510GA01# |
| | | | | ±5% | GRM0332C2A510JA01# |
| | | | 56pF | ±2% | GRM0332C2A560GA01# |
| ±5% | GRM0332C2A560JA01# | | | | |

Part number # indicates the package specification code.



GRM Series Temperature Compensating Type Part Number List

(→ 0.6×0.3mm)

| T max. | Rated Voltage | TC Code | Cap. | Tol. | Part Number | T max. | Rated Voltage | TC Code | Cap. | Tol. | Part Number |
|--------|---------------|--------------------|--------------------|--------------------|--------------------|--------------------|--------------------|--------------------|--------------------|---------|--------------------|
| 0.33mm | 100Vdc | CH | 62pF | ±2% | GRM0332C2A620GA01# | 0.33mm | 50Vdc | COG | 1.8pF | ±0.1pF | GRM0335C1H1R8BA01# |
| | | | | ±5% | GRM0332C2A620JA01# | | | | | ±0.25pF | GRM0335C1H1R8CA01# |
| | | | 68pF | ±2% | GRM0332C2A680GA01# | | | | 1.9pF | ±0.05pF | GRM0335C1H1R9WA01# |
| | | | | ±5% | GRM0332C2A680JA01# | | | | | ±0.1pF | GRM0335C1H1R9BA01# |
| | | | 75pF | ±2% | GRM0332C2A750GA01# | | | | 2.0pF | ±0.25pF | GRM0335C1H1R9CA01# |
| | | | | ±5% | GRM0332C2A750JA01# | | | | | ±0.05pF | GRM0335C1H2R0WA01# |
| | | | 82pF | ±2% | GRM0332C2A820GA01# | | | | 2.1pF | ±0.1pF | GRM0335C1H2R0BA01# |
| | | | | ±5% | GRM0332C2A820JA01# | | | | | ±0.25pF | GRM0335C1H2R0CA01# |
| | | | 91pF | ±2% | GRM0332C2A910GA01# | | | | 2.1pF | ±0.05pF | GRM0335C1H2R1WA01# |
| | | | | ±5% | GRM0332C2A910JA01# | | | | | ±0.1pF | GRM0335C1H2R1BA01# |
| | 100pF | ±2% | GRM0332C2A101GA01# | 2.1pF | ±0.25pF | | | | GRM0335C1H2R1CA01# | | |
| | | ±5% | GRM0332C2A101JA01# | | ±0.05pF | | | | GRM0335C1H2R2WA01# | | |
| | 50Vdc | COG | 0.10pF | ±0.05pF | GRM0335C1HR10WA01# | | | | 2.2pF | ±0.1pF | GRM0335C1H2R2BA01# |
| | | | | ±0.1pF | GRM0335C1HR20BA01# | | | | | ±0.25pF | GRM0335C1H2R2CA01# |
| | | | 0.20pF | ±0.05pF | GRM0335C1HR20WA01# | | | | 2.3pF | ±0.05pF | GRM0335C1H2R3WA01# |
| | | | | ±0.1pF | GRM0335C1HR30BA01# | | | | | ±0.1pF | GRM0335C1H2R3BA01# |
| | | | 0.30pF | ±0.05pF | GRM0335C1HR30WA01# | | | | 2.3pF | ±0.25pF | GRM0335C1H2R3CA01# |
| | | | | ±0.1pF | GRM0335C1HR30BA01# | | | | | 2.4pF | ±0.05pF |
| | | | 0.40pF | ±0.05pF | GRM0335C1HR40WA01# | | | | 2.4pF | | ±0.1pF |
| | | | | ±0.1pF | GRM0335C1HR40BA01# | | | | | ±0.25pF | GRM0335C1H2R4CA01# |
| 0.50pF | | | ±0.05pF | GRM0335C1HR50WA01# | 2.5pF | ±0.05pF | GRM0335C1H2R5WA01# | | | | |
| | | | ±0.1pF | GRM0335C1HR50BA01# | | ±0.1pF | GRM0335C1H2R5BA01# | | | | |
| 0.60pF | | | ±0.05pF | GRM0335C1HR60WA01# | 2.5pF | ±0.25pF | GRM0335C1H2R5CA01# | | | | |
| | | | ±0.1pF | GRM0335C1HR60BA01# | | 2.6pF | ±0.05pF | GRM0335C1H2R6WA01# | | | |
| 0.70pF | | | ±0.05pF | GRM0335C1HR70WA01# | 2.6pF | | ±0.1pF | GRM0335C1H2R6BA01# | | | |
| | | | ±0.1pF | GRM0335C1HR70BA01# | | ±0.25pF | GRM0335C1H2R6CA01# | | | | |
| 0.80pF | | | ±0.05pF | GRM0335C1HR80WA01# | 2.7pF | ±0.05pF | GRM0335C1H2R7WA01# | | | | |
| | | | ±0.1pF | GRM0335C1HR80BA01# | | ±0.1pF | GRM0335C1H2R7BA01# | | | | |
| 0.90pF | | | ±0.05pF | GRM0335C1HR90WA01# | 2.7pF | ±0.25pF | GRM0335C1H2R7CA01# | | | | |
| | | | ±0.1pF | GRM0335C1HR90BA01# | | 2.8pF | ±0.05pF | GRM0335C1H2R8WA01# | | | |
| 1.0pF | | | ±0.05pF | GRM0335C1H1R0WA01# | 2.8pF | | ±0.1pF | GRM0335C1H2R8BA01# | | | |
| | | | ±0.1pF | GRM0335C1H1R0BA01# | | ±0.25pF | GRM0335C1H2R8CA01# | | | | |
| | | | ±0.25pF | GRM0335C1H1R0CA01# | | 2.9pF | ±0.05pF | GRM0335C1H2R9WA01# | | | |
| 1.1pF | | | ±0.05pF | GRM0335C1H1R1WA01# | 2.9pF | | ±0.1pF | GRM0335C1H2R9BA01# | | | |
| | | | ±0.1pF | GRM0335C1H1R1BA01# | | | ±0.25pF | GRM0335C1H2R9CA01# | | | |
| | | | ±0.25pF | GRM0335C1H1R1CA01# | | 3.0pF | ±0.05pF | GRM0335C1H3R0WA01# | | | |
| 1.2pF | | | ±0.05pF | GRM0335C1H1R2WA01# | 3.0pF | | ±0.1pF | GRM0335C1H3R0BA01# | | | |
| | | | ±0.1pF | GRM0335C1H1R2BA01# | | | ±0.25pF | GRM0335C1H3R0CA01# | | | |
| | | | ±0.25pF | GRM0335C1H1R2CA01# | | 3.1pF | ±0.05pF | GRM0335C1H3R1WA01# | | | |
| 1.3pF | | | ±0.05pF | GRM0335C1H1R3WA01# | 3.1pF | | ±0.1pF | GRM0335C1H3R1BA01# | | | |
| | | | ±0.1pF | GRM0335C1H1R3BA01# | | | ±0.25pF | GRM0335C1H3R1CA01# | | | |
| | | | ±0.25pF | GRM0335C1H1R3CA01# | | 3.2pF | ±0.05pF | GRM0335C1H3R2WA01# | | | |
| 1.4pF | | | ±0.05pF | GRM0335C1H1R4WA01# | 3.2pF | | ±0.1pF | GRM0335C1H3R2BA01# | | | |
| | | | ±0.1pF | GRM0335C1H1R4BA01# | | | ±0.25pF | GRM0335C1H3R2CA01# | | | |
| | | | ±0.25pF | GRM0335C1H1R4CA01# | | 3.3pF | ±0.05pF | GRM0335C1H3R3WA01# | | | |
| 1.5pF | | | ±0.05pF | GRM0335C1H1R5WA01# | 3.3pF | | ±0.1pF | GRM0335C1H3R3BA01# | | | |
| | | | ±0.1pF | GRM0335C1H1R5BA01# | | | ±0.25pF | GRM0335C1H3R3CA01# | | | |
| | | | ±0.25pF | GRM0335C1H1R5CA01# | | 3.4pF | ±0.05pF | GRM0335C1H3R4WA01# | | | |
| 1.6pF | | | ±0.05pF | GRM0335C1H1R6WA01# | 3.4pF | | ±0.1pF | GRM0335C1H3R4BA01# | | | |
| | | | ±0.1pF | GRM0335C1H1R6BA01# | | | ±0.25pF | GRM0335C1H3R4CA01# | | | |
| | | | ±0.25pF | GRM0335C1H1R6CA01# | | 3.5pF | ±0.05pF | GRM0335C1H3R5WA01# | | | |
| 1.7pF | | | ±0.05pF | GRM0335C1H1R7WA01# | 3.5pF | | ±0.1pF | GRM0335C1H3R5BA01# | | | |
| | ±0.1pF | GRM0335C1H1R7BA01# | ±0.25pF | GRM0335C1H3R5CA01# | | | | | | | |
| | ±0.25pF | GRM0335C1H1R7CA01# | 3.6pF | ±0.05pF | | GRM0335C1H3R6WA01# | | | | | |
| 1.8pF | ±0.05pF | GRM0335C1H1R8WA01# | | | | | | | | | |

Part number # indicates the package specification code.

- GRM
- GR3
- GRJ
- GR4
- GR7
- GJM
- GQM
- GA2
- GA3 GB
- GA3 GD
- GA3 GF
- LLL
- LLA
- LLM
- LLR
- NFM
- KRM
- KR3
- GMA
- GMD
- ⚠Caution /Notice

GRM Series Temperature Compensating Type Part Number List

(→ 0.6×0.3mm)

| T max. | Rated Voltage | TC Code | Cap. | Tol. | Part Number |
|--------|---------------|---------|-------|---------|--------------------|
| 0.33mm | 50Vdc | COG | 3.6pF | ±0.1pF | GRM0335C1H3R6BA01# |
| | | | | ±0.25pF | GRM0335C1H3R6CA01# |
| | | | 3.7pF | ±0.05pF | GRM0335C1H3R7WA01# |
| | | | | ±0.1pF | GRM0335C1H3R7BA01# |
| | | | | ±0.25pF | GRM0335C1H3R7CA01# |
| | | | 3.8pF | ±0.05pF | GRM0335C1H3R8WA01# |
| | | | | ±0.1pF | GRM0335C1H3R8BA01# |
| | | | | ±0.25pF | GRM0335C1H3R8CA01# |
| | | | 3.9pF | ±0.05pF | GRM0335C1H3R9WA01# |
| | | | | ±0.1pF | GRM0335C1H3R9BA01# |
| | | | | ±0.25pF | GRM0335C1H3R9CA01# |
| | | | 4.0pF | ±0.05pF | GRM0335C1H4R0WA01# |
| | | | | ±0.1pF | GRM0335C1H4R0BA01# |
| | | | | ±0.25pF | GRM0335C1H4R0CA01# |
| | | | 4.1pF | ±0.05pF | GRM0335C1H4R1WA01# |
| | | | | ±0.1pF | GRM0335C1H4R1BA01# |
| | | | | ±0.25pF | GRM0335C1H4R1CA01# |
| | | | 4.2pF | ±0.05pF | GRM0335C1H4R2WA01# |
| | | | | ±0.1pF | GRM0335C1H4R2BA01# |
| | | | | ±0.25pF | GRM0335C1H4R2CA01# |
| | | | 4.3pF | ±0.05pF | GRM0335C1H4R3WA01# |
| | | | | ±0.1pF | GRM0335C1H4R3BA01# |
| | | | | ±0.25pF | GRM0335C1H4R3CA01# |
| | | | 4.4pF | ±0.05pF | GRM0335C1H4R4WA01# |
| | | | | ±0.1pF | GRM0335C1H4R4BA01# |
| | | | | ±0.25pF | GRM0335C1H4R4CA01# |
| | | | 4.5pF | ±0.05pF | GRM0335C1H4R5WA01# |
| | | | | ±0.1pF | GRM0335C1H4R5BA01# |
| | | | | ±0.25pF | GRM0335C1H4R5CA01# |
| | | | 4.6pF | ±0.05pF | GRM0335C1H4R6WA01# |
| | | | | ±0.1pF | GRM0335C1H4R6BA01# |
| | | | | ±0.25pF | GRM0335C1H4R6CA01# |
| | | | 4.7pF | ±0.05pF | GRM0335C1H4R7WA01# |
| | | | | ±0.1pF | GRM0335C1H4R7BA01# |
| | | | | ±0.25pF | GRM0335C1H4R7CA01# |
| | | | 4.8pF | ±0.05pF | GRM0335C1H4R8WA01# |
| | | | | ±0.1pF | GRM0335C1H4R8BA01# |
| | | | | ±0.25pF | GRM0335C1H4R8CA01# |
| | | | 4.9pF | ±0.05pF | GRM0335C1H4R9WA01# |
| | | | | ±0.1pF | GRM0335C1H4R9BA01# |
| | | | | ±0.25pF | GRM0335C1H4R9CA01# |
| | | | 5.0pF | ±0.05pF | GRM0335C1H5R0WA01# |
| | | | | ±0.1pF | GRM0335C1H5R0BA01# |
| | | | | ±0.25pF | GRM0335C1H5R0CA01# |
| | | | 5.1pF | ±0.05pF | GRM0335C1H5R1WA01# |
| | | | | ±0.1pF | GRM0335C1H5R1BA01# |
| | | | | ±0.25pF | GRM0335C1H5R1CA01# |
| | | | | ±0.5pF | GRM0335C1H5R1DA01# |
| | | | 5.2pF | ±0.05pF | GRM0335C1H5R2WA01# |
| | | | | ±0.1pF | GRM0335C1H5R2BA01# |
| | | | | ±0.25pF | GRM0335C1H5R2CA01# |
| | | | | ±0.5pF | GRM0335C1H5R2DA01# |
| | | | 5.3pF | ±0.05pF | GRM0335C1H5R3WA01# |
| | | | | ±0.1pF | GRM0335C1H5R3BA01# |

| T max. | Rated Voltage | TC Code | Cap. | Tol. | Part Number |
|--------|---------------|---------|-------|---------|--------------------|
| 0.33mm | 50Vdc | COG | 5.3pF | ±0.25pF | GRM0335C1H5R3CA01# |
| | | | | ±0.5pF | GRM0335C1H5R3DA01# |
| | | | 5.4pF | ±0.05pF | GRM0335C1H5R4WA01# |
| | | | | ±0.1pF | GRM0335C1H5R4BA01# |
| | | | | ±0.25pF | GRM0335C1H5R4CA01# |
| | | | 5.5pF | ±0.05pF | GRM0335C1H5R5WA01# |
| | | | | ±0.1pF | GRM0335C1H5R5BA01# |
| | | | | ±0.25pF | GRM0335C1H5R5CA01# |
| | | | 5.6pF | ±0.05pF | GRM0335C1H5R6WA01# |
| | | | | ±0.1pF | GRM0335C1H5R6BA01# |
| | | | | ±0.25pF | GRM0335C1H5R6CA01# |
| | | | 5.7pF | ±0.05pF | GRM0335C1H5R7WA01# |
| | | | | ±0.1pF | GRM0335C1H5R7BA01# |
| | | | | ±0.25pF | GRM0335C1H5R7CA01# |
| | | | 5.8pF | ±0.05pF | GRM0335C1H5R8WA01# |
| | | | | ±0.1pF | GRM0335C1H5R8BA01# |
| | | | | ±0.25pF | GRM0335C1H5R8CA01# |
| | | | 5.9pF | ±0.05pF | GRM0335C1H5R9WA01# |
| | | | | ±0.1pF | GRM0335C1H5R9BA01# |
| | | | | ±0.25pF | GRM0335C1H5R9CA01# |
| | | | 6.0pF | ±0.05pF | GRM0335C1H6R0WA01# |
| | | | | ±0.1pF | GRM0335C1H6R0BA01# |
| | | | | ±0.25pF | GRM0335C1H6R0CA01# |
| | | | 6.1pF | ±0.05pF | GRM0335C1H6R1WA01# |
| | | | | ±0.1pF | GRM0335C1H6R1BA01# |
| | | | | ±0.25pF | GRM0335C1H6R1CA01# |
| | | | 6.2pF | ±0.05pF | GRM0335C1H6R2WA01# |
| | | | | ±0.1pF | GRM0335C1H6R2BA01# |
| | | | | ±0.25pF | GRM0335C1H6R2CA01# |
| | | | 6.3pF | ±0.05pF | GRM0335C1H6R3WA01# |
| | | | | ±0.1pF | GRM0335C1H6R3BA01# |
| | | | | ±0.25pF | GRM0335C1H6R3CA01# |
| | | | 6.4pF | ±0.05pF | GRM0335C1H6R4WA01# |
| | | | | ±0.1pF | GRM0335C1H6R4BA01# |
| | | | | ±0.25pF | GRM0335C1H6R4CA01# |
| | | | 6.5pF | ±0.05pF | GRM0335C1H6R5WA01# |
| | | | | ±0.1pF | GRM0335C1H6R5BA01# |
| | | | | ±0.25pF | GRM0335C1H6R5CA01# |
| | | | 6.6pF | ±0.05pF | GRM0335C1H6R6WA01# |
| | | | | ±0.1pF | GRM0335C1H6R6BA01# |
| | | | | ±0.25pF | GRM0335C1H6R6CA01# |

Part number # indicates the package specification code.

- GRM
- GR3
- GRJ
- GR4
- GR7
- GJM
- GQM
- GA2
- GA3 GB
- GA3 GD
- GA3 GF
- LLL
- LLA
- LLM
- LLR
- NFM
- KRM
- KR3
- GMA
- GMD
- ⚠Caution /Notice

GRM Series Temperature Compensating Type Part Number List

(→ 0.6×0.3mm)

| T max. | Rated Voltage | TC Code | Cap. | Tol. | Part Number | T max. | Rated Voltage | TC Code | Cap. | Tol. | Part Number | |
|--------|---------------|---------|-------|---------|--------------------|--------|---------------|---------|---------|--------------------|--------------------|--------------------|
| 0.33mm | 50Vdc | COG | 6.7pF | ±0.05pF | GRM0335C1H6R7WA01# | 0.33mm | 50Vdc | COG | 8.0pF | ±0.25pF | GRM0335C1H8R0CA01# | |
| | | | | ±0.1pF | GRM0335C1H6R7BA01# | | | | | ±0.5pF | GRM0335C1H8R0DA01# | |
| | | | | ±0.25pF | GRM0335C1H6R7CA01# | | | | | 8.1pF | ±0.05pF | GRM0335C1H8R1WA01# |
| | | | | ±0.5pF | GRM0335C1H6R7DA01# | | | | | | ±0.1pF | GRM0335C1H8R1BA01# |
| | | | 6.8pF | ±0.05pF | GRM0335C1H6R8WA01# | | | | ±0.25pF | GRM0335C1H8R1CA01# | | |
| | | | | ±0.1pF | GRM0335C1H6R8BA01# | | | | ±0.5pF | GRM0335C1H8R1DA01# | | |
| | | | | ±0.25pF | GRM0335C1H6R8CA01# | | | | 8.2pF | ±0.05pF | GRM0335C1H8R2WA01# | |
| | | | | ±0.5pF | GRM0335C1H6R8DA01# | | | | | ±0.1pF | GRM0335C1H8R2BA01# | |
| | | | 6.9pF | ±0.05pF | GRM0335C1H6R9WA01# | | | | ±0.25pF | GRM0335C1H8R2CA01# | | |
| | | | | ±0.1pF | GRM0335C1H6R9BA01# | | | | ±0.5pF | GRM0335C1H8R2DA01# | | |
| | | | | ±0.25pF | GRM0335C1H6R9CA01# | | | | 8.3pF | ±0.05pF | GRM0335C1H8R3WA01# | |
| | | | | ±0.5pF | GRM0335C1H6R9DA01# | | | | | ±0.1pF | GRM0335C1H8R3BA01# | |
| | | | 7.0pF | ±0.05pF | GRM0335C1H7R0WA01# | | | | ±0.25pF | GRM0335C1H8R3CA01# | | |
| | | | | ±0.1pF | GRM0335C1H7R0BA01# | | | | ±0.5pF | GRM0335C1H8R3DA01# | | |
| | | | | ±0.25pF | GRM0335C1H7R0CA01# | | | | 8.4pF | ±0.05pF | GRM0335C1H8R4WA01# | |
| | | | | ±0.5pF | GRM0335C1H7R0DA01# | | | | | ±0.1pF | GRM0335C1H8R4BA01# | |
| | | | 7.1pF | ±0.05pF | GRM0335C1H7R1WA01# | | | | ±0.25pF | GRM0335C1H8R4CA01# | | |
| | | | | ±0.1pF | GRM0335C1H7R1BA01# | | | | ±0.5pF | GRM0335C1H8R4DA01# | | |
| | | | | ±0.25pF | GRM0335C1H7R1CA01# | | | | 8.5pF | ±0.05pF | GRM0335C1H8R5WA01# | |
| | | | | ±0.5pF | GRM0335C1H7R1DA01# | | | | | ±0.1pF | GRM0335C1H8R5BA01# | |
| | | | 7.2pF | ±0.05pF | GRM0335C1H7R2WA01# | | | | ±0.25pF | GRM0335C1H8R5CA01# | | |
| | | | | ±0.1pF | GRM0335C1H7R2BA01# | | | | ±0.5pF | GRM0335C1H8R5DA01# | | |
| | | | | ±0.25pF | GRM0335C1H7R2CA01# | | | | 8.6pF | ±0.05pF | GRM0335C1H8R6WA01# | |
| | | | | ±0.5pF | GRM0335C1H7R2DA01# | | | | | ±0.1pF | GRM0335C1H8R6BA01# | |
| | | | 7.3pF | ±0.05pF | GRM0335C1H7R3WA01# | | | | ±0.25pF | GRM0335C1H8R6CA01# | | |
| | | | | ±0.1pF | GRM0335C1H7R3BA01# | | | | ±0.5pF | GRM0335C1H8R6DA01# | | |
| | | | | ±0.25pF | GRM0335C1H7R3CA01# | | | | 8.7pF | ±0.05pF | GRM0335C1H8R7WA01# | |
| | | | | ±0.5pF | GRM0335C1H7R3DA01# | | | | | ±0.1pF | GRM0335C1H8R7BA01# | |
| | | | 7.4pF | ±0.05pF | GRM0335C1H7R4WA01# | | | | ±0.25pF | GRM0335C1H8R7CA01# | | |
| | | | | ±0.1pF | GRM0335C1H7R4BA01# | | | | ±0.5pF | GRM0335C1H8R7DA01# | | |
| | | | | ±0.25pF | GRM0335C1H7R4CA01# | | | | 8.8pF | ±0.05pF | GRM0335C1H8R8WA01# | |
| | | | | ±0.5pF | GRM0335C1H7R4DA01# | | | | | ±0.1pF | GRM0335C1H8R8BA01# | |
| | | | 7.5pF | ±0.05pF | GRM0335C1H7R5WA01# | | | | ±0.25pF | GRM0335C1H8R8CA01# | | |
| | | | | ±0.1pF | GRM0335C1H7R5BA01# | | | | ±0.5pF | GRM0335C1H8R8DA01# | | |
| | | | | ±0.25pF | GRM0335C1H7R5CA01# | | | | 8.9pF | ±0.05pF | GRM0335C1H8R9WA01# | |
| | | | | ±0.5pF | GRM0335C1H7R5DA01# | | | | | ±0.1pF | GRM0335C1H8R9BA01# | |
| | | | 7.6pF | ±0.05pF | GRM0335C1H7R6WA01# | | | | ±0.25pF | GRM0335C1H8R9CA01# | | |
| | | | | ±0.1pF | GRM0335C1H7R6BA01# | | | | ±0.5pF | GRM0335C1H8R9DA01# | | |
| | | | | ±0.25pF | GRM0335C1H7R6CA01# | | | | 9.0pF | ±0.05pF | GRM0335C1H9R0WA01# | |
| | | | | ±0.5pF | GRM0335C1H7R6DA01# | | | | | ±0.1pF | GRM0335C1H9R0BA01# | |
| | | | 7.7pF | ±0.05pF | GRM0335C1H7R7WA01# | | | | ±0.25pF | GRM0335C1H9R0CA01# | | |
| | | | | ±0.1pF | GRM0335C1H7R7BA01# | | | | ±0.5pF | GRM0335C1H9R0DA01# | | |
| | | | | ±0.25pF | GRM0335C1H7R7CA01# | | | | 9.1pF | ±0.05pF | GRM0335C1H9R1WA01# | |
| | | | | ±0.5pF | GRM0335C1H7R7DA01# | | | | | ±0.1pF | GRM0335C1H9R1BA01# | |
| | | | 7.8pF | ±0.05pF | GRM0335C1H7R8WA01# | | | | ±0.25pF | GRM0335C1H9R1CA01# | | |
| | | | | ±0.1pF | GRM0335C1H7R8BA01# | | | | ±0.5pF | GRM0335C1H9R1DA01# | | |
| | | | | ±0.25pF | GRM0335C1H7R8CA01# | | | | 9.2pF | ±0.05pF | GRM0335C1H9R2WA01# | |
| | | | | ±0.5pF | GRM0335C1H7R8DA01# | | | | | ±0.1pF | GRM0335C1H9R2BA01# | |
| | | | 7.9pF | ±0.05pF | GRM0335C1H7R9WA01# | | | | ±0.25pF | GRM0335C1H9R2CA01# | | |
| | | | | ±0.1pF | GRM0335C1H7R9BA01# | | | | ±0.5pF | GRM0335C1H9R2DA01# | | |
| | | | | ±0.25pF | GRM0335C1H7R9CA01# | | | | 9.3pF | ±0.05pF | GRM0335C1H9R3WA01# | |
| | | | | ±0.5pF | GRM0335C1H7R9DA01# | | | | | ±0.1pF | GRM0335C1H9R3BA01# | |
| | | | 8.0pF | ±0.05pF | GRM0335C1H8R0WA01# | | | | ±0.25pF | GRM0335C1H9R3CA01# | | |
| | | | | ±0.1pF | GRM0335C1H8R0BA01# | | | | ±0.5pF | GRM0335C1H9R3DA01# | | |

GRM
 GR3
 GRJ
 GR4
 GR7
 GJM
 GQM
 GA2
 GA3 GB
 GA3 GD
 GA3 GF
 LLL
 LLA
 LLM
 LLR
 NFM
 KRM
 KR3
 GMA
 GMD
 ⚠Caution /Notice

Part number # indicates the package specification code.

GRM Series Temperature Compensating Type Part Number List

(→ 0.6×0.3mm)

| T max. | Rated Voltage | TC Code | Cap. | Tol. | Part Number |
|--------|---------------|---------|-------|---------|--------------------|
| 0.33mm | 50Vdc | COG | 9.4pF | ±0.05pF | GRM0335C1H9R4WA01# |
| | | | | ±0.1pF | GRM0335C1H9R4BA01# |
| | | | | ±0.25pF | GRM0335C1H9R4CA01# |
| | | | | ±0.5pF | GRM0335C1H9R4DA01# |
| | | | 9.5pF | ±0.05pF | GRM0335C1H9R5WA01# |
| | | | | ±0.1pF | GRM0335C1H9R5BA01# |
| | | | | ±0.25pF | GRM0335C1H9R5CA01# |
| | | | | ±0.5pF | GRM0335C1H9R5DA01# |
| | | | 9.6pF | ±0.05pF | GRM0335C1H9R6WA01# |
| | | | | ±0.1pF | GRM0335C1H9R6BA01# |
| | | | | ±0.25pF | GRM0335C1H9R6CA01# |
| | | | | ±0.5pF | GRM0335C1H9R6DA01# |
| | | | 9.7pF | ±0.05pF | GRM0335C1H9R7WA01# |
| | | | | ±0.1pF | GRM0335C1H9R7BA01# |
| | | | | ±0.25pF | GRM0335C1H9R7CA01# |
| | | | | ±0.5pF | GRM0335C1H9R7DA01# |
| | | | 9.8pF | ±0.05pF | GRM0335C1H9R8WA01# |
| | | | | ±0.1pF | GRM0335C1H9R8BA01# |
| | | | | ±0.25pF | GRM0335C1H9R8CA01# |
| | | | | ±0.5pF | GRM0335C1H9R8DA01# |
| | | | 9.9pF | ±0.05pF | GRM0335C1H9R9WA01# |
| | | | | ±0.1pF | GRM0335C1H9R9BA01# |
| | | | | ±0.25pF | GRM0335C1H9R9CA01# |
| | | | | ±0.5pF | GRM0335C1H9R9DA01# |
| | | | 10pF | ±2% | GRM0335C1H100GA01# |
| | | | | ±5% | GRM0335C1H100JA01# |
| | | | 12pF | ±2% | GRM0335C1H120GA01# |
| | | | | ±5% | GRM0335C1H120JA01# |
| | | | 15pF | ±2% | GRM0335C1H150GA01# |
| | | | | ±5% | GRM0335C1H150JA01# |
| | | | 18pF | ±2% | GRM0335C1H180GA01# |
| | | | | ±5% | GRM0335C1H180JA01# |
| | | | 22pF | ±2% | GRM0335C1H220GA01# |
| | | | | ±5% | GRM0335C1H220JA01# |
| | | | 27pF | ±2% | GRM0335C1H270GA01# |
| | | | | ±5% | GRM0335C1H270JA01# |
| | | | 33pF | ±2% | GRM0335C1H330GA01# |
| | | | | ±5% | GRM0335C1H330JA01# |
| | | | 39pF | ±2% | GRM0335C1H390GA01# |
| | | | | ±5% | GRM0335C1H390JA01# |
| | | | 47pF | ±2% | GRM0335C1H470GA01# |
| | | | | ±5% | GRM0335C1H470JA01# |
| | | | 56pF | ±2% | GRM0335C1H560GA01# |
| | | | | ±5% | GRM0335C1H560JA01# |
| | | | 68pF | ±2% | GRM0335C1H680GA01# |
| | | | | ±5% | GRM0335C1H680JA01# |
| | | | 82pF | ±2% | GRM0335C1H820GA01# |
| | | | | ±5% | GRM0335C1H820JA01# |
| | | | 100pF | ±2% | GRM0335C1H101GA01# |
| | | | | ±5% | GRM0335C1H101JA01# |
| | | | 120pF | ±2% | GRM0335C1H121GA01# |
| | | | | ±5% | GRM0335C1H121JA01# |
| | | | 150pF | ±2% | GRM0335C1H151GA01# |
| | | | | ±5% | GRM0335C1H151JA01# |

| T max. | Rated Voltage | TC Code | Cap. | Tol. | Part Number | | |
|--------|---------------|---------|-------|--------|--------------------|--------------------|--------------------|
| 0.33mm | 50Vdc | COG | 180pF | ±2% | GRM0335C1H181GA01# | | |
| | | | | ±5% | GRM0335C1H181JA01# | | |
| | | | | 220pF | ±2% | GRM0335C1H221GA01# | |
| | | | | | ±5% | GRM0335C1H221JA01# | |
| | | | CK | 0.10pF | ±0.05pF | GRM0334C1HR10WA01# | |
| | | | | | 0.20pF | ±0.05pF | GRM0334C1HR20WA01# |
| | | | | | | ±0.1pF | GRM0334C1HR20BA01# |
| | | | | | 0.30pF | ±0.05pF | GRM0334C1HR30WA01# |
| | | | | | | ±0.1pF | GRM0334C1HR30BA01# |
| | | | | | 0.40pF | ±0.05pF | GRM0334C1HR40WA01# |
| | | | | | | ±0.1pF | GRM0334C1HR40BA01# |
| | | | | | 0.50pF | ±0.05pF | GRM0334C1HR50WA01# |
| | | | | | | ±0.1pF | GRM0334C1HR50BA01# |
| | | | | | 0.60pF | ±0.05pF | GRM0334C1HR60WA01# |
| | | | | | | ±0.1pF | GRM0334C1HR60BA01# |
| | | | | | 0.70pF | ±0.05pF | GRM0334C1HR70WA01# |
| | | | | | | ±0.1pF | GRM0334C1HR70BA01# |
| | | | | | 0.80pF | ±0.05pF | GRM0334C1HR80WA01# |
| | | | | | | ±0.1pF | GRM0334C1HR80BA01# |
| | | | | | 0.90pF | ±0.05pF | GRM0334C1HR90WA01# |
| | | | | | | ±0.1pF | GRM0334C1HR90BA01# |
| | | | | | 1.0pF | ±0.05pF | GRM0334C1H1R0WA01# |
| | | | | | | ±0.1pF | GRM0334C1H1R0BA01# |
| | | | | | | ±0.25pF | GRM0334C1H1R0CA01# |
| | | | | | 1.1pF | ±0.05pF | GRM0334C1H1R1WA01# |
| | | | | | | ±0.1pF | GRM0334C1H1R1BA01# |
| | | | | | | ±0.25pF | GRM0334C1H1R1CA01# |
| | | | | | 1.2pF | ±0.05pF | GRM0334C1H1R2WA01# |
| | | | | | | ±0.1pF | GRM0334C1H1R2BA01# |
| | | | | | | ±0.25pF | GRM0334C1H1R2CA01# |
| | | | | | 1.3pF | ±0.05pF | GRM0334C1H1R3WA01# |
| | | | | | | ±0.1pF | GRM0334C1H1R3BA01# |
| | | | | | | ±0.25pF | GRM0334C1H1R3CA01# |
| | | | | | 1.4pF | ±0.05pF | GRM0334C1H1R4WA01# |
| | | | | | | ±0.1pF | GRM0334C1H1R4BA01# |
| | | | | | | ±0.25pF | GRM0334C1H1R4CA01# |
| | | | | | 1.5pF | ±0.05pF | GRM0334C1H1R5WA01# |
| | | | | | | ±0.1pF | GRM0334C1H1R5BA01# |
| | | | | | | ±0.25pF | GRM0334C1H1R5CA01# |
| | | | | | 1.6pF | ±0.05pF | GRM0334C1H1R6WA01# |
| | | | | | | ±0.1pF | GRM0334C1H1R6BA01# |
| | | | | | | ±0.25pF | GRM0334C1H1R6CA01# |
| | | | | | 1.7pF | ±0.05pF | GRM0334C1H1R7WA01# |
| | | | | | | ±0.1pF | GRM0334C1H1R7BA01# |
| | | | | | | ±0.25pF | GRM0334C1H1R7CA01# |
| | | | | | 1.8pF | ±0.05pF | GRM0334C1H1R8WA01# |
| | | | | | | ±0.1pF | GRM0334C1H1R8BA01# |
| | | | | | | ±0.25pF | GRM0334C1H1R8CA01# |
| | | | | | 1.9pF | ±0.05pF | GRM0334C1H1R9WA01# |
| | | | | | | ±0.1pF | GRM0334C1H1R9BA01# |
| | | | | | | ±0.25pF | GRM0334C1H1R9CA01# |
| | | | | | 2.0pF | ±0.05pF | GRM0334C1H2R0WA01# |
| | | | | | | ±0.1pF | GRM0334C1H2R0BA01# |
| | | | | | | ±0.25pF | GRM0334C1H2R0CA01# |

Part number # indicates the package specification code.

- GRM
- GR3
- GRJ
- GR4
- GR7
- GJM
- GQM
- GA2
- GA3 GB
- GA3 GD
- GA3 GF
- LLL
- LLA
- LLM
- LLR
- NFM
- KRM
- KR3
- GMA
- GMD
- ⚠Caution /Notice

GRM Series Temperature Compensating Type Part Number List

(→ 0.6×0.3mm)

| T max. | Rated Voltage | TC Code | Cap. | Tol. | Part Number |
|--------|---------------|---------|-------|---------|--------------------|
| 0.33mm | 50Vdc | CJ | 2.1pF | ±0.05pF | GRM0333C1H2R1WA01# |
| | | | | ±0.1pF | GRM0333C1H2R1BA01# |
| | | | | ±0.25pF | GRM0333C1H2R1CA01# |
| | | | 2.2pF | ±0.05pF | GRM0333C1H2R2WA01# |
| | | | | ±0.1pF | GRM0333C1H2R2BA01# |
| | | | | ±0.25pF | GRM0333C1H2R2CA01# |
| | | | 2.3pF | ±0.05pF | GRM0333C1H2R3WA01# |
| | | | | ±0.1pF | GRM0333C1H2R3BA01# |
| | | | | ±0.25pF | GRM0333C1H2R3CA01# |
| | | | 2.4pF | ±0.05pF | GRM0333C1H2R4WA01# |
| | | | | ±0.1pF | GRM0333C1H2R4BA01# |
| | | | | ±0.25pF | GRM0333C1H2R4CA01# |
| | | | 2.5pF | ±0.05pF | GRM0333C1H2R5WA01# |
| | | | | ±0.1pF | GRM0333C1H2R5BA01# |
| | | | | ±0.25pF | GRM0333C1H2R5CA01# |
| | | | 2.6pF | ±0.05pF | GRM0333C1H2R6WA01# |
| | | | | ±0.1pF | GRM0333C1H2R6BA01# |
| | | | | ±0.25pF | GRM0333C1H2R6CA01# |
| | | | 2.7pF | ±0.05pF | GRM0333C1H2R7WA01# |
| | | | | ±0.1pF | GRM0333C1H2R7BA01# |
| | | | | ±0.25pF | GRM0333C1H2R7CA01# |
| | | | 2.8pF | ±0.05pF | GRM0333C1H2R8WA01# |
| | | | | ±0.1pF | GRM0333C1H2R8BA01# |
| | | | | ±0.25pF | GRM0333C1H2R8CA01# |
| | | | 2.9pF | ±0.05pF | GRM0333C1H2R9WA01# |
| | | | | ±0.1pF | GRM0333C1H2R9BA01# |
| | | | | ±0.25pF | GRM0333C1H2R9CA01# |
| | | | 3.0pF | ±0.05pF | GRM0333C1H3R0WA01# |
| | | | | ±0.1pF | GRM0333C1H3R0BA01# |
| | | | | ±0.25pF | GRM0333C1H3R0CA01# |
| | | | 3.1pF | ±0.05pF | GRM0333C1H3R1WA01# |
| | | | | ±0.1pF | GRM0333C1H3R1BA01# |
| | | | | ±0.25pF | GRM0333C1H3R1CA01# |
| | | | 3.2pF | ±0.05pF | GRM0333C1H3R2WA01# |
| | | | | ±0.1pF | GRM0333C1H3R2BA01# |
| | | | | ±0.25pF | GRM0333C1H3R2CA01# |
| | | | 3.3pF | ±0.05pF | GRM0333C1H3R3WA01# |
| | | | | ±0.1pF | GRM0333C1H3R3BA01# |
| | | | | ±0.25pF | GRM0333C1H3R3CA01# |
| | | | 3.4pF | ±0.05pF | GRM0333C1H3R4WA01# |
| | | | | ±0.1pF | GRM0333C1H3R4BA01# |
| | | | | ±0.25pF | GRM0333C1H3R4CA01# |
| | | | 3.5pF | ±0.05pF | GRM0333C1H3R5WA01# |
| | | | | ±0.1pF | GRM0333C1H3R5BA01# |
| | | | | ±0.25pF | GRM0333C1H3R5CA01# |
| | | | 3.6pF | ±0.05pF | GRM0333C1H3R6WA01# |
| | | | | ±0.1pF | GRM0333C1H3R6BA01# |
| | | | | ±0.25pF | GRM0333C1H3R6CA01# |
| | | | 3.7pF | ±0.05pF | GRM0333C1H3R7WA01# |
| | | | | ±0.1pF | GRM0333C1H3R7BA01# |
| | | | | ±0.25pF | GRM0333C1H3R7CA01# |
| | | | 3.8pF | ±0.05pF | GRM0333C1H3R8WA01# |
| | | | | ±0.1pF | GRM0333C1H3R8BA01# |
| | | | | ±0.25pF | GRM0333C1H3R8CA01# |

| T max. | Rated Voltage | TC Code | Cap. | Tol. | Part Number |
|--------|---------------|---------|---------|--------------------|--------------------|
| 0.33mm | 50Vdc | CJ | 3.9pF | ±0.05pF | GRM0333C1H3R9WA01# |
| | | | | ±0.1pF | GRM0333C1H3R9BA01# |
| | | | | ±0.25pF | GRM0333C1H3R9CA01# |
| | | CH | 4.0pF | ±0.05pF | GRM0332C1H4R0WA01# |
| | | | | ±0.1pF | GRM0332C1H4R0BA01# |
| | | | | ±0.25pF | GRM0332C1H4R0CA01# |
| | | 4.1pF | ±0.05pF | GRM0332C1H4R1WA01# | |
| | | | ±0.1pF | GRM0332C1H4R1BA01# | |
| | | | ±0.25pF | GRM0332C1H4R1CA01# | |
| | | 4.2pF | ±0.05pF | GRM0332C1H4R2WA01# | |
| | | | ±0.1pF | GRM0332C1H4R2BA01# | |
| | | | ±0.25pF | GRM0332C1H4R2CA01# | |
| | | 4.3pF | ±0.05pF | GRM0332C1H4R3WA01# | |
| | | | ±0.1pF | GRM0332C1H4R3BA01# | |
| | | | ±0.25pF | GRM0332C1H4R3CA01# | |
| | | 4.4pF | ±0.05pF | GRM0332C1H4R4WA01# | |
| | | | ±0.1pF | GRM0332C1H4R4BA01# | |
| | | | ±0.25pF | GRM0332C1H4R4CA01# | |
| | | 4.5pF | ±0.05pF | GRM0332C1H4R5WA01# | |
| | | | ±0.1pF | GRM0332C1H4R5BA01# | |
| | | | ±0.25pF | GRM0332C1H4R5CA01# | |
| | | 4.6pF | ±0.05pF | GRM0332C1H4R6WA01# | |
| | | | ±0.1pF | GRM0332C1H4R6BA01# | |
| | | | ±0.25pF | GRM0332C1H4R6CA01# | |
| | | 4.7pF | ±0.05pF | GRM0332C1H4R7WA01# | |
| | | | ±0.1pF | GRM0332C1H4R7BA01# | |
| | | | ±0.25pF | GRM0332C1H4R7CA01# | |
| | | 4.8pF | ±0.05pF | GRM0332C1H4R8WA01# | |
| | | | ±0.1pF | GRM0332C1H4R8BA01# | |
| | | | ±0.25pF | GRM0332C1H4R8CA01# | |
| | | 4.9pF | ±0.05pF | GRM0332C1H4R9WA01# | |
| | | | ±0.1pF | GRM0332C1H4R9BA01# | |
| | | | ±0.25pF | GRM0332C1H4R9CA01# | |
| | | 5.0pF | ±0.05pF | GRM0332C1H5R0WA01# | |
| | | | ±0.1pF | GRM0332C1H5R0BA01# | |
| | | | ±0.25pF | GRM0332C1H5R0CA01# | |
| | | 5.1pF | ±0.05pF | GRM0332C1H5R1WA01# | |
| | | | ±0.1pF | GRM0332C1H5R1BA01# | |
| | | | ±0.25pF | GRM0332C1H5R1CA01# | |
| | | 5.2pF | ±0.05pF | GRM0332C1H5R2WA01# | |
| | | | ±0.1pF | GRM0332C1H5R2BA01# | |
| | | | ±0.25pF | GRM0332C1H5R2CA01# | |
| | | 5.3pF | ±0.05pF | GRM0332C1H5R3WA01# | |
| | | | ±0.1pF | GRM0332C1H5R3BA01# | |
| | | | ±0.25pF | GRM0332C1H5R3CA01# | |
| | | 5.4pF | ±0.05pF | GRM0332C1H5R4WA01# | |
| | | | ±0.1pF | GRM0332C1H5R4BA01# | |
| | | | ±0.25pF | GRM0332C1H5R4CA01# | |
| | | 5.5pF | ±0.05pF | GRM0332C1H5R5WA01# | |
| | | | ±0.1pF | GRM0332C1H5R5BA01# | |
| | | | ±0.25pF | GRM0332C1H5R5CA01# | |

- GRM
- GR3
- GRJ
- GR4
- GR7
- GJM
- GQM
- GA2
- GA3 GB
- GA3 GD
- GA3 GF
- LLL
- LLA
- LLM
- LLR
- NFM
- KRM
- KR3
- GMA
- GMD
- ⚠Caution /Notice

Part number # indicates the package specification code.

GRM Series Temperature Compensating Type Part Number List

(→ 0.6×0.3mm)

| T max. | Rated Voltage | TC Code | Cap. | Tol. | Part Number | T max. | Rated Voltage | TC Code | Cap. | Tol. | Part Number |
|--------|---------------|---------|--------|--------------------|--------------------|---------|---------------|---------|--------------------|--------------------|--------------------|
| 0.33mm | 50Vdc | CH | 5.5pF | ±0.25pF | GRM0332C1H5R5CA01# | 0.33mm | 50Vdc | CH | 6.9pF | ±0.05pF | GRM0332C1H6R9WA01# |
| | | | | ±0.5pF | GRM0332C1H5R5DA01# | | | | | ±0.1pF | GRM0332C1H6R9BA01# |
| | | | 5.6pF | ±0.05pF | GRM0332C1H5R6WA01# | ±0.25pF | | | GRM0332C1H6R9CA01# | | |
| | | | | ±0.1pF | GRM0332C1H5R6BA01# | ±0.5pF | | | GRM0332C1H6R9DA01# | | |
| | | | | ±0.25pF | GRM0332C1H5R6CA01# | 7.0pF | | | ±0.05pF | GRM0332C1H7R0WA01# | |
| | | | | ±0.5pF | GRM0332C1H5R6DA01# | | | | ±0.1pF | GRM0332C1H7R0BA01# | |
| | | | 5.7pF | ±0.05pF | GRM0332C1H5R7WA01# | | | | ±0.25pF | GRM0332C1H7R0CA01# | |
| | | | | ±0.1pF | GRM0332C1H5R7BA01# | ±0.5pF | | | GRM0332C1H7R0DA01# | | |
| | | | | ±0.25pF | GRM0332C1H5R7CA01# | 7.1pF | | | ±0.05pF | GRM0332C1H7R1WA01# | |
| | | | ±0.5pF | GRM0332C1H5R7DA01# | ±0.1pF | | | | GRM0332C1H7R1BA01# | | |
| | | | 5.8pF | ±0.05pF | GRM0332C1H5R8WA01# | | | | ±0.25pF | GRM0332C1H7R1CA01# | |
| | | | | ±0.1pF | GRM0332C1H5R8BA01# | ±0.5pF | | | GRM0332C1H7R1DA01# | | |
| | | | | ±0.25pF | GRM0332C1H5R8CA01# | 7.2pF | | | ±0.05pF | GRM0332C1H7R2WA01# | |
| | | | | ±0.5pF | GRM0332C1H5R8DA01# | | | | ±0.1pF | GRM0332C1H7R2BA01# | |
| | | | 5.9pF | ±0.05pF | GRM0332C1H5R9WA01# | | | | ±0.25pF | GRM0332C1H7R2CA01# | |
| | | | | ±0.1pF | GRM0332C1H5R9BA01# | ±0.5pF | | | GRM0332C1H7R2DA01# | | |
| | | | | ±0.25pF | GRM0332C1H5R9CA01# | 7.3pF | | | ±0.05pF | GRM0332C1H7R3WA01# | |
| | | | | ±0.5pF | GRM0332C1H5R9DA01# | | | | ±0.1pF | GRM0332C1H7R3BA01# | |
| | | | 6.0pF | ±0.05pF | GRM0332C1H6R0WA01# | | | | ±0.25pF | GRM0332C1H7R3CA01# | |
| | | | | ±0.1pF | GRM0332C1H6R0BA01# | ±0.5pF | | | GRM0332C1H7R3DA01# | | |
| | | | | ±0.25pF | GRM0332C1H6R0CA01# | 7.4pF | | | ±0.05pF | GRM0332C1H7R4WA01# | |
| | | | | ±0.5pF | GRM0332C1H6R0DA01# | | | | ±0.1pF | GRM0332C1H7R4BA01# | |
| | | | 6.1pF | ±0.05pF | GRM0332C1H6R1WA01# | | | | ±0.25pF | GRM0332C1H7R4CA01# | |
| | | | | ±0.1pF | GRM0332C1H6R1BA01# | ±0.5pF | | | GRM0332C1H7R4DA01# | | |
| | | | | ±0.25pF | GRM0332C1H6R1CA01# | 7.5pF | | | ±0.05pF | GRM0332C1H7R5WA01# | |
| | | | | ±0.5pF | GRM0332C1H6R1DA01# | | | | ±0.1pF | GRM0332C1H7R5BA01# | |
| | | | 6.2pF | ±0.05pF | GRM0332C1H6R2WA01# | | | | ±0.25pF | GRM0332C1H7R5CA01# | |
| | | | | ±0.1pF | GRM0332C1H6R2BA01# | ±0.5pF | | | GRM0332C1H7R5DA01# | | |
| | | | | ±0.25pF | GRM0332C1H6R2CA01# | 7.6pF | | | ±0.05pF | GRM0332C1H7R6WA01# | |
| | | | | ±0.5pF | GRM0332C1H6R2DA01# | | | | ±0.1pF | GRM0332C1H7R6BA01# | |
| | | | 6.3pF | ±0.05pF | GRM0332C1H6R3WA01# | | | | ±0.25pF | GRM0332C1H7R6CA01# | |
| | | | | ±0.1pF | GRM0332C1H6R3BA01# | ±0.5pF | | | GRM0332C1H7R6DA01# | | |
| | | | | ±0.25pF | GRM0332C1H6R3CA01# | 7.7pF | | | ±0.05pF | GRM0332C1H7R7WA01# | |
| | | | | ±0.5pF | GRM0332C1H6R3DA01# | | | | ±0.1pF | GRM0332C1H7R7BA01# | |
| | | | 6.4pF | ±0.05pF | GRM0332C1H6R4WA01# | | | | ±0.25pF | GRM0332C1H7R7CA01# | |
| | | | | ±0.1pF | GRM0332C1H6R4BA01# | ±0.5pF | | | GRM0332C1H7R7DA01# | | |
| | | | | ±0.25pF | GRM0332C1H6R4CA01# | 7.8pF | | | ±0.05pF | GRM0332C1H7R8WA01# | |
| | | | | ±0.5pF | GRM0332C1H6R4DA01# | | | | ±0.1pF | GRM0332C1H7R8BA01# | |
| | | | 6.5pF | ±0.05pF | GRM0332C1H6R5WA01# | | | | ±0.25pF | GRM0332C1H7R8CA01# | |
| | | | | ±0.1pF | GRM0332C1H6R5BA01# | ±0.5pF | | | GRM0332C1H7R8DA01# | | |
| | | | | ±0.25pF | GRM0332C1H6R5CA01# | 7.9pF | | | ±0.05pF | GRM0332C1H7R9WA01# | |
| | | | | ±0.5pF | GRM0332C1H6R5DA01# | | | | ±0.1pF | GRM0332C1H7R9BA01# | |
| | | | 6.6pF | ±0.05pF | GRM0332C1H6R6WA01# | | | | ±0.25pF | GRM0332C1H7R9CA01# | |
| | | | | ±0.1pF | GRM0332C1H6R6BA01# | ±0.5pF | | | GRM0332C1H7R9DA01# | | |
| | | | | ±0.25pF | GRM0332C1H6R6CA01# | 8.0pF | | | ±0.05pF | GRM0332C1H8R0WA01# | |
| | | | | ±0.5pF | GRM0332C1H6R6DA01# | | | | ±0.1pF | GRM0332C1H8R0BA01# | |
| | | | 6.7pF | ±0.05pF | GRM0332C1H6R7WA01# | | | | ±0.25pF | GRM0332C1H8R0CA01# | |
| | | | | ±0.1pF | GRM0332C1H6R7BA01# | ±0.5pF | | | GRM0332C1H8R0DA01# | | |
| | | | | ±0.25pF | GRM0332C1H6R7CA01# | 8.1pF | | | ±0.05pF | GRM0332C1H8R1WA01# | |
| | | | | ±0.5pF | GRM0332C1H6R7DA01# | | | | ±0.1pF | GRM0332C1H8R1BA01# | |
| | | | 6.8pF | ±0.05pF | GRM0332C1H6R8WA01# | | | | ±0.25pF | GRM0332C1H8R1CA01# | |
| | | | | ±0.1pF | GRM0332C1H6R8BA01# | ±0.5pF | | | GRM0332C1H8R1DA01# | | |
| | | | | ±0.25pF | GRM0332C1H6R8CA01# | 8.2pF | | | ±0.05pF | GRM0332C1H8R2WA01# | |
| | | | | ±0.5pF | GRM0332C1H6R8DA01# | | | | ±0.1pF | GRM0332C1H8R2BA01# | |

Part number # indicates the package specification code.



GRM Series Temperature Compensating Type Part Number List

(→ 0.6×0.3mm)

| T max. | Rated Voltage | TC Code | Cap. | Tol. | Part Number | T max. | Rated Voltage | TC Code | Cap. | Tol. | Part Number | |
|--------|---------------|---------|--------|--------------------|--------------------|--------|---------------|---------|---------|--------------------|--------------------|--------------------|
| 0.33mm | 50Vdc | CH | 8.2pF | ±0.25pF | GRM0332C1H8R2CA01# | 0.33mm | 50Vdc | CH | 9.6pF | ±0.05pF | GRM0332C1H9R6WA01# | |
| | | | | ±0.5pF | GRM0332C1H8R2DA01# | | | | | ±0.1pF | GRM0332C1H9R6BA01# | |
| | | | 8.3pF | ±0.05pF | GRM0332C1H8R3WA01# | | | | ±0.25pF | GRM0332C1H9R6CA01# | | |
| | | | | ±0.1pF | GRM0332C1H8R3BA01# | | | | ±0.5pF | GRM0332C1H9R6DA01# | | |
| | | | | ±0.25pF | GRM0332C1H8R3CA01# | | | | 9.7pF | ±0.05pF | GRM0332C1H9R7WA01# | |
| | | | | ±0.5pF | GRM0332C1H8R3DA01# | | | | | ±0.1pF | GRM0332C1H9R7BA01# | |
| | | | 8.4pF | ±0.05pF | GRM0332C1H8R4WA01# | | | | | ±0.25pF | GRM0332C1H9R7CA01# | |
| | | | | ±0.1pF | GRM0332C1H8R4BA01# | | | | ±0.5pF | GRM0332C1H9R7DA01# | | |
| | | | | ±0.25pF | GRM0332C1H8R4CA01# | | | | 9.8pF | ±0.05pF | GRM0332C1H9R8WA01# | |
| | | | ±0.5pF | GRM0332C1H8R4DA01# | ±0.1pF | | | | | GRM0332C1H9R8BA01# | | |
| | | | 8.5pF | ±0.05pF | GRM0332C1H8R5WA01# | | | | | ±0.25pF | GRM0332C1H9R8CA01# | |
| | | | | ±0.1pF | GRM0332C1H8R5BA01# | | | | ±0.5pF | GRM0332C1H9R8DA01# | | |
| | | | | ±0.25pF | GRM0332C1H8R5CA01# | | | | 9.9pF | ±0.05pF | GRM0332C1H9R9WA01# | |
| | | | | ±0.5pF | GRM0332C1H8R5DA01# | | | | | ±0.1pF | GRM0332C1H9R9BA01# | |
| | | | 8.6pF | ±0.05pF | GRM0332C1H8R6WA01# | | | | | ±0.25pF | GRM0332C1H9R9CA01# | |
| | | | | ±0.1pF | GRM0332C1H8R6BA01# | | | | ±0.5pF | GRM0332C1H9R9DA01# | | |
| | | | | ±0.25pF | GRM0332C1H8R6CA01# | | | | 10pF | ±2% | GRM0332C1H100GA01# | |
| | | | | ±0.5pF | GRM0332C1H8R6DA01# | | | | | ±5% | GRM0332C1H100JA01# | |
| | | | 8.7pF | ±0.05pF | GRM0332C1H8R7WA01# | | | | 12pF | ±2% | GRM0332C1H120GA01# | |
| | | | | ±0.1pF | GRM0332C1H8R7BA01# | | | | | ±5% | GRM0332C1H120JA01# | |
| | | | | ±0.25pF | GRM0332C1H8R7CA01# | | | | 15pF | ±2% | GRM0332C1H150GA01# | |
| | | | | ±0.5pF | GRM0332C1H8R7DA01# | | | | | ±5% | GRM0332C1H150JA01# | |
| | | | 8.8pF | ±0.05pF | GRM0332C1H8R8WA01# | | | | 18pF | ±2% | GRM0332C1H180GA01# | |
| | | | | ±0.1pF | GRM0332C1H8R8BA01# | | | | | ±5% | GRM0332C1H180JA01# | |
| | | | | ±0.25pF | GRM0332C1H8R8CA01# | | | | 22pF | ±2% | GRM0332C1H220GA01# | |
| | | | | ±0.5pF | GRM0332C1H8R8DA01# | | | | | ±5% | GRM0332C1H220JA01# | |
| | | | 8.9pF | ±0.05pF | GRM0332C1H8R9WA01# | | | | 27pF | ±2% | GRM0332C1H270GA01# | |
| | | | | ±0.1pF | GRM0332C1H8R9BA01# | | | | | ±5% | GRM0332C1H270JA01# | |
| | | | | ±0.25pF | GRM0332C1H8R9CA01# | | | | 33pF | ±2% | GRM0332C1H330GA01# | |
| | | | | ±0.5pF | GRM0332C1H8R9DA01# | | | | | ±5% | GRM0332C1H330JA01# | |
| | | | 9.0pF | ±0.05pF | GRM0332C1H9R0WA01# | | | | 39pF | ±2% | GRM0332C1H390GA01# | |
| | | | | ±0.1pF | GRM0332C1H9R0BA01# | | | | | ±5% | GRM0332C1H390JA01# | |
| | | | | ±0.25pF | GRM0332C1H9R0CA01# | | | | 47pF | ±2% | GRM0332C1H470GA01# | |
| | | | | ±0.5pF | GRM0332C1H9R0DA01# | | | | | ±5% | GRM0332C1H470JA01# | |
| | | | 9.1pF | ±0.05pF | GRM0332C1H9R1WA01# | | | | 56pF | ±2% | GRM0332C1H560GA01# | |
| | | | | ±0.1pF | GRM0332C1H9R1BA01# | | | | | ±5% | GRM0332C1H560JA01# | |
| | | | | ±0.25pF | GRM0332C1H9R1CA01# | | | | 68pF | ±2% | GRM0332C1H680GA01# | |
| | | | | ±0.5pF | GRM0332C1H9R1DA01# | | | | | ±5% | GRM0332C1H680JA01# | |
| | | | 9.2pF | ±0.05pF | GRM0332C1H9R2WA01# | | | | 82pF | ±2% | GRM0332C1H820GA01# | |
| | | | | ±0.1pF | GRM0332C1H9R2BA01# | | | | | ±5% | GRM0332C1H820JA01# | |
| | | | | ±0.25pF | GRM0332C1H9R2CA01# | | | | 100pF | ±2% | GRM0332C1H101GA01# | |
| | | | | ±0.5pF | GRM0332C1H9R2DA01# | | | | | ±5% | GRM0332C1H101JA01# | |
| | | | 9.3pF | ±0.05pF | GRM0332C1H9R3WA01# | | | | 120pF | ±2% | GRM0332C1H121GA01# | |
| | | | | ±0.1pF | GRM0332C1H9R3BA01# | | | | | ±5% | GRM0332C1H121JA01# | |
| | | | | ±0.25pF | GRM0332C1H9R3CA01# | | | | 150pF | ±2% | GRM0332C1H151GA01# | |
| | | | | ±0.5pF | GRM0332C1H9R3DA01# | | | | | ±5% | GRM0332C1H151JA01# | |
| | | | 9.4pF | ±0.05pF | GRM0332C1H9R4WA01# | | | | 180pF | ±2% | GRM0332C1H181GA01# | |
| | | | | ±0.1pF | GRM0332C1H9R4BA01# | | | | | ±5% | GRM0332C1H181JA01# | |
| | | | | ±0.25pF | GRM0332C1H9R4CA01# | | | | 220pF | ±2% | GRM0332C1H221GA01# | |
| | | | | ±0.5pF | GRM0332C1H9R4DA01# | | | | | ±5% | GRM0332C1H221JA01# | |
| | | | 9.5pF | ±0.05pF | GRM0332C1H9R5WA01# | | | | 270pF | ±2% | GRM0335C1E271GA01# | |
| | | | | ±0.1pF | GRM0332C1H9R5BA01# | | | | | ±5% | GRM0335C1E271JA01# | |
| | | | | ±0.25pF | GRM0332C1H9R5CA01# | | | | | 330pF | ±2% | GRM0335C1E331GA01# |
| | | | | ±0.5pF | GRM0332C1H9R5DA01# | | | | | | ±5% | GRM0335C1E331JA01# |
| | | | 25Vdc | COG | | | | | | | | |

GRM
 GR3
 GRJ
 GR4
 GR7
 GJM
 GQM
 GA2
 GA3 GB
 GA3 GD
 GA3 GF
 LLL
 LLA
 LLM
 LLR
 NFM
 KRM
 KR3
 GMA
 GMD
 ⚠Caution /Notice

Part number # indicates the package specification code.

GRM Series Temperature Compensating Type Part Number List

(→ 0.6×0.3mm)

| T max. | Rated Voltage | TC Code | Cap. | Tol. | Part Number | |
|--------|---------------|---------|--------|-------|--------------------|--------------------|
| 0.33mm | 25Vdc | COG | 390pF | ±2% | GRM0335C1E391GA01# | |
| | | | | ±5% | GRM0335C1E391JA01# | |
| | | | 470pF | ±2% | GRM0335C1E471GA01# | |
| | | | | ±5% | GRM0335C1E471JA01# | |
| | | | 560pF | ±2% | GRM0335C1E561GA01# | |
| | | | | ±5% | GRM0335C1E561JA01# | |
| | | | 680pF | ±2% | GRM0335C1E681GA01# | |
| | | | | ±5% | GRM0335C1E681JA01# | |
| | | | 820pF | ±2% | GRM0335C1E821GA01# | |
| | | | | ±5% | GRM0335C1E821JA01# | |
| | | | 910pF | ±2% | GRM0335C1E911GA01# | |
| | | | | ±5% | GRM0335C1E911JA01# | |
| | | | 1000pF | ±2% | GRM0335C1E102GA01# | |
| | | | | ±5% | GRM0335C1E102JA01# | |
| | | | CH | 270pF | ±2% | GRM0332C1E271GA01# |
| | | | | | ±5% | GRM0332C1E271JA01# |
| | | | | 330pF | ±2% | GRM0332C1E331GA01# |
| | | | | | ±5% | GRM0332C1E331JA01# |
| | | 390pF | | ±2% | GRM0332C1E391GA01# | |
| | | | | ±5% | GRM0332C1E391JA01# | |
| | | 470pF | | ±2% | GRM0332C1E471GA01# | |
| | | | | ±5% | GRM0332C1E471JA01# | |
| | | 560pF | | ±2% | GRM0332C1E561GA01# | |
| | | | | ±5% | GRM0332C1E561JA01# | |
| | | 680pF | | ±2% | GRM0332C1E681GA01# | |
| | | | | ±5% | GRM0332C1E681JA01# | |
| | | 820pF | | ±2% | GRM0332C1E821GA01# | |
| | | | | ±5% | GRM0332C1E821JA01# | |
| | | 1000pF | | ±2% | GRM0332C1E102GA01# | |
| | | | | ±5% | GRM0332C1E102JA01# | |

1.0×0.5mm

| T max. | Rated Voltage | TC Code | Cap. | Tol. | Part Number |
|--------|---------------|---------|--------|---------|--------------------|
| 0.55mm | 100Vdc | COG | 0.10pF | ±0.05pF | GRM1555C2AR10WA01# |
| | | | | ±0.1pF | GRM1555C2AR10BA01# |
| | | | 0.20pF | ±0.05pF | GRM1555C2AR20WA01# |
| | | | | ±0.1pF | GRM1555C2AR20BA01# |
| | | | 0.30pF | ±0.05pF | GRM1555C2AR30WA01# |
| | | | | ±0.1pF | GRM1555C2AR30BA01# |
| | | | 0.40pF | ±0.05pF | GRM1555C2AR40WA01# |
| | | | | ±0.1pF | GRM1555C2AR40BA01# |
| | | | 0.50pF | ±0.05pF | GRM1555C2AR50WA01# |
| | | | | ±0.1pF | GRM1555C2AR50BA01# |
| | | | 0.60pF | ±0.05pF | GRM1555C2AR60WA01# |
| | | | | ±0.1pF | GRM1555C2AR60BA01# |
| | | | 0.70pF | ±0.05pF | GRM1555C2AR70WA01# |
| | | | | ±0.1pF | GRM1555C2AR70BA01# |
| | | | 0.80pF | ±0.05pF | GRM1555C2AR80WA01# |
| | | | | ±0.1pF | GRM1555C2AR80BA01# |
| | | | 0.90pF | ±0.05pF | GRM1555C2AR90WA01# |
| | | | | ±0.1pF | GRM1555C2AR90BA01# |
| | | | 1.0pF | ±0.05pF | GRM1555C2A1R0WA01# |
| | | | | ±0.1pF | GRM1555C2A1R0BA01# |

| T max. | Rated Voltage | TC Code | Cap. | Tol. | Part Number |
|--------|---------------|---------|-------|---------|--------------------|
| 0.55mm | 100Vdc | COG | 1.0pF | ±0.25pF | GRM1555C2A1R0CA01# |
| | | | | ±0.05pF | GRM1555C2A1R1WA01# |
| | | | | ±0.1pF | GRM1555C2A1R1BA01# |
| | | | 1.1pF | ±0.25pF | GRM1555C2A1R1CA01# |
| | | | | ±0.05pF | GRM1555C2A1R2WA01# |
| | | | | ±0.1pF | GRM1555C2A1R2BA01# |
| | | | 1.2pF | ±0.25pF | GRM1555C2A1R2CA01# |
| | | | | ±0.05pF | GRM1555C2A1R3WA01# |
| | | | | ±0.1pF | GRM1555C2A1R3BA01# |
| | | | 1.3pF | ±0.25pF | GRM1555C2A1R3CA01# |
| | | | | ±0.05pF | GRM1555C2A1R4WA01# |
| | | | | ±0.1pF | GRM1555C2A1R4BA01# |
| | | | 1.4pF | ±0.25pF | GRM1555C2A1R4CA01# |
| | | | | ±0.05pF | GRM1555C2A1R5WA01# |
| | | | | ±0.1pF | GRM1555C2A1R5BA01# |
| | | | 1.5pF | ±0.25pF | GRM1555C2A1R5CA01# |
| | | | | ±0.05pF | GRM1555C2A1R6WA01# |
| | | | | ±0.1pF | GRM1555C2A1R6BA01# |
| | | | 1.6pF | ±0.25pF | GRM1555C2A1R6CA01# |
| | | | | ±0.05pF | GRM1555C2A1R7WA01# |
| | | | | ±0.1pF | GRM1555C2A1R7BA01# |
| | | | 1.7pF | ±0.25pF | GRM1555C2A1R7CA01# |
| | | | | ±0.05pF | GRM1555C2A1R8WA01# |
| | | | | ±0.1pF | GRM1555C2A1R8BA01# |
| | | | 1.8pF | ±0.25pF | GRM1555C2A1R8CA01# |
| | | | | ±0.05pF | GRM1555C2A1R9WA01# |
| | | | | ±0.1pF | GRM1555C2A1R9BA01# |
| | | | 1.9pF | ±0.25pF | GRM1555C2A1R9CA01# |
| | | | | ±0.05pF | GRM1555C2A2R0WA01# |
| | | | | ±0.1pF | GRM1555C2A2R0BA01# |
| | | | 2.0pF | ±0.25pF | GRM1555C2A2R0CA01# |
| | | | | ±0.05pF | GRM1555C2A2R1WA01# |
| | | | | ±0.1pF | GRM1555C2A2R1BA01# |
| | | | 2.1pF | ±0.25pF | GRM1555C2A2R1CA01# |
| | | | | ±0.05pF | GRM1555C2A2R2WA01# |
| | | | | ±0.1pF | GRM1555C2A2R2BA01# |
| | | | 2.2pF | ±0.25pF | GRM1555C2A2R2CA01# |
| | | | | ±0.05pF | GRM1555C2A2R3WA01# |
| | | | | ±0.1pF | GRM1555C2A2R3BA01# |
| | | | 2.3pF | ±0.25pF | GRM1555C2A2R3CA01# |
| | | | | ±0.05pF | GRM1555C2A2R4WA01# |
| | | | | ±0.1pF | GRM1555C2A2R4BA01# |
| | | | 2.4pF | ±0.25pF | GRM1555C2A2R4CA01# |
| | | | | ±0.05pF | GRM1555C2A2R5WA01# |
| | | | | ±0.1pF | GRM1555C2A2R5BA01# |
| | | | 2.5pF | ±0.25pF | GRM1555C2A2R5CA01# |
| | | | | ±0.05pF | GRM1555C2A2R6WA01# |
| | | | | ±0.1pF | GRM1555C2A2R6BA01# |
| | | | 2.6pF | ±0.25pF | GRM1555C2A2R6CA01# |
| | | | | ±0.05pF | GRM1555C2A2R7WA01# |
| | | | | ±0.1pF | GRM1555C2A2R7BA01# |
| | | | 2.7pF | ±0.25pF | GRM1555C2A2R7CA01# |
| | | | | ±0.05pF | GRM1555C2A2R8WA01# |
| | | | | ±0.1pF | GRM1555C2A2R8BA01# |
| | | | 2.8pF | ±0.25pF | GRM1555C2A2R8CA01# |

Part number # indicates the package specification code.

GRM
 GR3
 GRJ
 GR4
 GR7
 GJM
 GQM
 GA2
 GA3 GB
 GA3 GD
 GA3 GF
 LLL
 LLA
 LLM
 LLR
 NFM
 KRM
 KR3
 GMA
 GMD
 ⚠Caution /Notice

GRM Series Temperature Compensating Type Part Number List

(→ 1.0×0.5mm)

| T max. | Rated Voltage | TC Code | Cap. | Tol. | Part Number | T max. | Rated Voltage | TC Code | Cap. | Tol. | Part Number | | |
|---------|--------------------|--------------------|---------|---------|--------------------|--------|---------------|---------|---------|--------------------|--------------------|---------|--------------------|
| 0.55mm | 100Vdc | COG | 2.8pF | ±0.25pF | GRM1555C2A2R8CA01# | 0.55mm | 100Vdc | COG | 4.6pF | ±0.25pF | GRM1555C2A4R6CA01# | | |
| | | | | 2.9pF | ±0.05pF | | | | | GRM1555C2A2R9WA01# | 4.7pF | ±0.05pF | GRM1555C2A4R7WA01# |
| | | | | | ±0.1pF | | | | | GRM1555C2A2R9BA01# | | ±0.1pF | GRM1555C2A4R7BA01# |
| | | | ±0.25pF | | GRM1555C2A2R9CA01# | | | | ±0.25pF | GRM1555C2A4R7CA01# | | | |
| | | | 3.0pF | ±0.05pF | GRM1555C2A3R0WA01# | | | | 4.8pF | ±0.05pF | GRM1555C2A4R8WA01# | | |
| | | | | ±0.1pF | GRM1555C2A3R0BA01# | | | | | ±0.1pF | GRM1555C2A4R8BA01# | | |
| | | | | ±0.25pF | GRM1555C2A3R0CA01# | | | | | ±0.25pF | GRM1555C2A4R8CA01# | | |
| | | | 3.1pF | ±0.05pF | GRM1555C2A3R1WA01# | | | | 4.9pF | ±0.05pF | GRM1555C2A4R9WA01# | | |
| | | | | ±0.1pF | GRM1555C2A3R1BA01# | | | | | ±0.1pF | GRM1555C2A4R9BA01# | | |
| | | | | ±0.25pF | GRM1555C2A3R1CA01# | | | | | ±0.25pF | GRM1555C2A4R9CA01# | | |
| | | | 3.2pF | ±0.05pF | GRM1555C2A3R2WA01# | | | | 5.0pF | ±0.05pF | GRM1555C2A5R0WA01# | | |
| | | | | ±0.1pF | GRM1555C2A3R2BA01# | | | | | ±0.1pF | GRM1555C2A5R0BA01# | | |
| | | | | ±0.25pF | GRM1555C2A3R2CA01# | | | | | ±0.25pF | GRM1555C2A5R0CA01# | | |
| | | | 3.3pF | ±0.05pF | GRM1555C2A3R3WA01# | | | | 5.1pF | ±0.05pF | GRM1555C2A5R1WA01# | | |
| | | | | ±0.1pF | GRM1555C2A3R3BA01# | | | | | ±0.1pF | GRM1555C2A5R1BA01# | | |
| | | | | ±0.25pF | GRM1555C2A3R3CA01# | | | | | ±0.25pF | GRM1555C2A5R1CA01# | | |
| | | | 3.4pF | ±0.05pF | GRM1555C2A3R4WA01# | | | | 5.2pF | ±0.05pF | GRM1555C2A5R2WA01# | | |
| | | | | ±0.1pF | GRM1555C2A3R4BA01# | | | | | ±0.1pF | GRM1555C2A5R2BA01# | | |
| | | | | ±0.25pF | GRM1555C2A3R4CA01# | | | | | ±0.25pF | GRM1555C2A5R2CA01# | | |
| | | | 3.5pF | ±0.05pF | GRM1555C2A3R5WA01# | | | | 5.3pF | ±0.05pF | GRM1555C2A5R3WA01# | | |
| | | | | ±0.1pF | GRM1555C2A3R5BA01# | | | | | ±0.1pF | GRM1555C2A5R3BA01# | | |
| | | | | ±0.25pF | GRM1555C2A3R5CA01# | | | | | ±0.25pF | GRM1555C2A5R3CA01# | | |
| | | | 3.6pF | ±0.05pF | GRM1555C2A3R6WA01# | | | | 5.4pF | ±0.05pF | GRM1555C2A5R4WA01# | | |
| | | | | ±0.1pF | GRM1555C2A3R6BA01# | | | | | ±0.1pF | GRM1555C2A5R4BA01# | | |
| | | | | ±0.25pF | GRM1555C2A3R6CA01# | | | | | ±0.25pF | GRM1555C2A5R4CA01# | | |
| | | | 3.7pF | ±0.05pF | GRM1555C2A3R7WA01# | | | | 5.5pF | ±0.05pF | GRM1555C2A5R5WA01# | | |
| | | | | ±0.1pF | GRM1555C2A3R7BA01# | | | | | ±0.1pF | GRM1555C2A5R5BA01# | | |
| | | | | ±0.25pF | GRM1555C2A3R7CA01# | | | | | ±0.25pF | GRM1555C2A5R5CA01# | | |
| | | | 3.8pF | ±0.05pF | GRM1555C2A3R8WA01# | | | | 5.6pF | ±0.05pF | GRM1555C2A5R6WA01# | | |
| | | | | ±0.1pF | GRM1555C2A3R8BA01# | | | | | ±0.1pF | GRM1555C2A5R6BA01# | | |
| | | | | ±0.25pF | GRM1555C2A3R8CA01# | | | | | ±0.25pF | GRM1555C2A5R6CA01# | | |
| | | | 3.9pF | ±0.05pF | GRM1555C2A3R9WA01# | | | | 5.7pF | ±0.05pF | GRM1555C2A5R7WA01# | | |
| | | | | ±0.1pF | GRM1555C2A3R9BA01# | | | | | ±0.1pF | GRM1555C2A5R7BA01# | | |
| | | | | ±0.25pF | GRM1555C2A3R9CA01# | | | | | ±0.25pF | GRM1555C2A5R7CA01# | | |
| | | | 4.0pF | ±0.05pF | GRM1555C2A4R0WA01# | | | | 5.8pF | ±0.05pF | GRM1555C2A5R8WA01# | | |
| | | | | ±0.1pF | GRM1555C2A4R0BA01# | | | | | ±0.1pF | GRM1555C2A5R8BA01# | | |
| | | | | ±0.25pF | GRM1555C2A4R0CA01# | | | | | ±0.25pF | GRM1555C2A5R8CA01# | | |
| | | | 4.1pF | ±0.05pF | GRM1555C2A4R1WA01# | | | | 5.9pF | ±0.05pF | GRM1555C2A5R9WA01# | | |
| | | | | ±0.1pF | GRM1555C2A4R1BA01# | | | | | ±0.1pF | GRM1555C2A5R9BA01# | | |
| | | | | ±0.25pF | GRM1555C2A4R1CA01# | | | | | ±0.25pF | GRM1555C2A5R9CA01# | | |
| | | | 4.2pF | ±0.05pF | GRM1555C2A4R2WA01# | | | | 6.0pF | ±0.05pF | GRM1555C2A6R0WA01# | | |
| | | | | ±0.1pF | GRM1555C2A4R2BA01# | | | | | ±0.1pF | GRM1555C2A6R0BA01# | | |
| | | | | ±0.25pF | GRM1555C2A4R2CA01# | | | | | ±0.25pF | GRM1555C2A6R0CA01# | | |
| | | | 4.3pF | ±0.05pF | GRM1555C2A4R3WA01# | | | | 6.1pF | ±0.05pF | GRM1555C2A6R1WA01# | | |
| | | | | ±0.1pF | GRM1555C2A4R3BA01# | | | | | | | | |
| | | | | ±0.25pF | GRM1555C2A4R3CA01# | | | | | | | | |
| | | | 4.4pF | ±0.05pF | GRM1555C2A4R4WA01# | | | | | | | | |
| | | | | ±0.1pF | GRM1555C2A4R4BA01# | | | | | | | | |
| ±0.25pF | GRM1555C2A4R4CA01# | | | | | | | | | | | | |
| 4.5pF | ±0.05pF | GRM1555C2A4R5WA01# | | | | | | | | | | | |
| | ±0.1pF | GRM1555C2A4R5BA01# | | | | | | | | | | | |
| | ±0.25pF | GRM1555C2A4R5CA01# | | | | | | | | | | | |
| 4.6pF | ±0.05pF | GRM1555C2A4R6WA01# | | | | | | | | | | | |
| | ±0.1pF | GRM1555C2A4R6BA01# | | | | | | | | | | | |

Part number # indicates the package specification code.

GRM
 GR3
 GRJ
 GR4
 GR7
 GJM
 GQM
 GA2
 GA3 GB
 GA3 GD
 GA3 GF
 LLL
 LLA
 LLM
 LLR
 NFM
 KRM
 KR3
 GMA
 GMD
 ⚠Caution /Notice

GRM Series Temperature Compensating Type Part Number List

(→ 1.0×0.5mm)

| T max. | Rated Voltage | TC Code | Cap. | Tol. | Part Number | T max. | Rated Voltage | TC Code | Cap. | Tol. | Part Number |
|--------|---------------|---------|--------|--------------------|--------------------|--------|---------------|---------|---------|--------------------|--------------------|
| 0.55mm | 100Vdc | COG | 6.1pF | ±0.1pF | GRM1555C2A6R1BA01# | 0.55mm | 100Vdc | COG | 7.4pF | ±0.5pF | GRM1555C2A7R4DA01# |
| | | | | ±0.25pF | GRM1555C2A6R1CA01# | | | | | ±0.05pF | GRM1555C2A7R5WA01# |
| | | | | ±0.5pF | GRM1555C2A6R1DA01# | | | | | ±0.1pF | GRM1555C2A7R5BA01# |
| | | | 6.2pF | ±0.05pF | GRM1555C2A6R2WA01# | | | | ±0.25pF | GRM1555C2A7R5CA01# | |
| | | | | ±0.1pF | GRM1555C2A6R2BA01# | | | | ±0.5pF | GRM1555C2A7R5DA01# | |
| | | | | ±0.25pF | GRM1555C2A6R2CA01# | | | | 7.6pF | ±0.05pF | GRM1555C2A7R6WA01# |
| | | | ±0.5pF | GRM1555C2A6R2DA01# | ±0.1pF | | | | | GRM1555C2A7R6BA01# | |
| | | | 6.3pF | ±0.05pF | GRM1555C2A6R3WA01# | | | | | ±0.25pF | GRM1555C2A7R6CA01# |
| | | | | ±0.1pF | GRM1555C2A6R3BA01# | | | | ±0.5pF | GRM1555C2A7R6DA01# | |
| | | | | ±0.25pF | GRM1555C2A6R3CA01# | | | | 7.7pF | ±0.05pF | GRM1555C2A7R7WA01# |
| | | | ±0.5pF | GRM1555C2A6R3DA01# | ±0.1pF | | | | | GRM1555C2A7R7BA01# | |
| | | | 6.4pF | ±0.05pF | GRM1555C2A6R4WA01# | | | | | ±0.25pF | GRM1555C2A7R7CA01# |
| | | | | ±0.1pF | GRM1555C2A6R4BA01# | | | | ±0.5pF | GRM1555C2A7R7DA01# | |
| | | | | ±0.25pF | GRM1555C2A6R4CA01# | | | | 7.8pF | ±0.05pF | GRM1555C2A7R8WA01# |
| | | | ±0.5pF | GRM1555C2A6R4DA01# | ±0.1pF | | | | | GRM1555C2A7R8BA01# | |
| | | | 6.5pF | ±0.05pF | GRM1555C2A6R5WA01# | | | | | ±0.25pF | GRM1555C2A7R8CA01# |
| | | | | ±0.1pF | GRM1555C2A6R5BA01# | | | | ±0.5pF | GRM1555C2A7R8DA01# | |
| | | | | ±0.25pF | GRM1555C2A6R5CA01# | | | | 7.9pF | ±0.05pF | GRM1555C2A7R9WA01# |
| | | | ±0.5pF | GRM1555C2A6R5DA01# | ±0.1pF | | | | | GRM1555C2A7R9BA01# | |
| | | | 6.6pF | ±0.05pF | GRM1555C2A6R6WA01# | | | | | ±0.25pF | GRM1555C2A7R9CA01# |
| | | | | ±0.1pF | GRM1555C2A6R6BA01# | | | | ±0.5pF | GRM1555C2A7R9DA01# | |
| | | | | ±0.25pF | GRM1555C2A6R6CA01# | | | | 8.0pF | ±0.05pF | GRM1555C2A8R0WA01# |
| | | | ±0.5pF | GRM1555C2A6R6DA01# | ±0.1pF | | | | | GRM1555C2A8R0BA01# | |
| | | | 6.7pF | ±0.05pF | GRM1555C2A6R7WA01# | | | | | ±0.25pF | GRM1555C2A8R0CA01# |
| | | | | ±0.1pF | GRM1555C2A6R7BA01# | | | | ±0.5pF | GRM1555C2A8R0DA01# | |
| | | | | ±0.25pF | GRM1555C2A6R7CA01# | | | | 8.1pF | ±0.05pF | GRM1555C2A8R1WA01# |
| | | | ±0.5pF | GRM1555C2A6R7DA01# | ±0.1pF | | | | | GRM1555C2A8R1BA01# | |
| | | | 6.8pF | ±0.05pF | GRM1555C2A6R8WA01# | | | | | ±0.25pF | GRM1555C2A8R1CA01# |
| | | | | ±0.1pF | GRM1555C2A6R8BA01# | | | | ±0.5pF | GRM1555C2A8R1DA01# | |
| | | | | ±0.25pF | GRM1555C2A6R8CA01# | | | | 8.2pF | ±0.05pF | GRM1555C2A8R2WA01# |
| | | | ±0.5pF | GRM1555C2A6R8DA01# | ±0.1pF | | | | | GRM1555C2A8R2BA01# | |
| | | | 6.9pF | ±0.05pF | GRM1555C2A6R9WA01# | | | | | ±0.25pF | GRM1555C2A8R2CA01# |
| | | | | ±0.1pF | GRM1555C2A6R9BA01# | | | | ±0.5pF | GRM1555C2A8R2DA01# | |
| | | | | ±0.25pF | GRM1555C2A6R9CA01# | | | | 8.3pF | ±0.05pF | GRM1555C2A8R3WA01# |
| | | | ±0.5pF | GRM1555C2A6R9DA01# | ±0.1pF | | | | | GRM1555C2A8R3BA01# | |
| | | | 7.0pF | ±0.05pF | GRM1555C2A7R0WA01# | | | | | ±0.25pF | GRM1555C2A8R3CA01# |
| | | | | ±0.1pF | GRM1555C2A7R0BA01# | | | | ±0.5pF | GRM1555C2A8R3DA01# | |
| | | | | ±0.25pF | GRM1555C2A7R0CA01# | | | | 8.4pF | ±0.05pF | GRM1555C2A8R4WA01# |
| | | | ±0.5pF | GRM1555C2A7R0DA01# | ±0.1pF | | | | | GRM1555C2A8R4BA01# | |
| | | | 7.1pF | ±0.05pF | GRM1555C2A7R1WA01# | | | | | ±0.25pF | GRM1555C2A8R4CA01# |
| | | | | ±0.1pF | GRM1555C2A7R1BA01# | | | | ±0.5pF | GRM1555C2A8R4DA01# | |
| | | | | ±0.25pF | GRM1555C2A7R1CA01# | | | | 8.5pF | ±0.05pF | GRM1555C2A8R5WA01# |
| | | | ±0.5pF | GRM1555C2A7R1DA01# | ±0.1pF | | | | | GRM1555C2A8R5BA01# | |
| | | | 7.2pF | ±0.05pF | GRM1555C2A7R2WA01# | | | | | ±0.25pF | GRM1555C2A8R5CA01# |
| | | | | ±0.1pF | GRM1555C2A7R2BA01# | | | | ±0.5pF | GRM1555C2A8R5DA01# | |
| | | | | ±0.25pF | GRM1555C2A7R2CA01# | | | | 8.6pF | ±0.05pF | GRM1555C2A8R6WA01# |
| | | | ±0.5pF | GRM1555C2A7R2DA01# | ±0.1pF | | | | | GRM1555C2A8R6BA01# | |
| | | | 7.3pF | ±0.05pF | GRM1555C2A7R3WA01# | | | | | ±0.25pF | GRM1555C2A8R6CA01# |
| | | | | ±0.1pF | GRM1555C2A7R3BA01# | | | | ±0.5pF | GRM1555C2A8R6DA01# | |
| | | | | ±0.25pF | GRM1555C2A7R3CA01# | | | | 8.7pF | ±0.05pF | GRM1555C2A8R7WA01# |
| | | | ±0.5pF | GRM1555C2A7R3DA01# | ±0.1pF | | | | | GRM1555C2A8R7BA01# | |
| | | | 7.4pF | ±0.05pF | GRM1555C2A7R4WA01# | | | | | ±0.25pF | GRM1555C2A8R7CA01# |
| | | | | ±0.1pF | GRM1555C2A7R4BA01# | | | | ±0.5pF | GRM1555C2A8R7DA01# | |
| | | | | ±0.25pF | GRM1555C2A7R4CA01# | | | | 8.8pF | ±0.05pF | GRM1555C2A8R8WA01# |

Part number # indicates the package specification code.

GRM Series Temperature Compensating Type Part Number List

(→ 1.0×0.5mm)

| T max. | Rated Voltage | TC Code | Cap. | Tol. | Part Number | T max. | Rated Voltage | TC Code | Cap. | Tol. | Part Number | | |
|--------|---------------|---------|--------|--------------------|--------------------|--------|---------------|---------|-------|--------------------|--------------------|--------------------|--------------------|
| 0.55mm | 100Vdc | COG | 8.8pF | ±0.1pF | GRM1555C2A8R8BA01# | 0.55mm | 100Vdc | COG | 18pF | ±5% | GRM1555C2A180JA01# | | |
| | | | | ±0.25pF | GRM1555C2A8R8CA01# | | | | | 22pF | ±2% | GRM1555C2A220GA01# | |
| | | | | ±0.5pF | GRM1555C2A8R8DA01# | | | | | | ±5% | GRM1555C2A220JA01# | |
| | | | 8.9pF | ±0.05pF | GRM1555C2A8R9WA01# | | | | 27pF | ±2% | GRM1555C2A270GA01# | | |
| | | | | ±0.1pF | GRM1555C2A8R9BA01# | | | | | ±5% | GRM1555C2A270JA01# | | |
| | | | | ±0.25pF | GRM1555C2A8R9CA01# | | | | 33pF | ±2% | GRM1555C2A330GA01# | | |
| | | | | ±0.5pF | GRM1555C2A8R9DA01# | | | | | ±5% | GRM1555C2A330JA01# | | |
| | | | 9.0pF | ±0.05pF | GRM1555C2A9R0WA01# | | | | 39pF | ±2% | GRM1555C2A390GA01# | | |
| | | | | ±0.1pF | GRM1555C2A9R0BA01# | | | | | ±5% | GRM1555C2A390JA01# | | |
| | | | | ±0.25pF | GRM1555C2A9R0CA01# | | | | 47pF | ±2% | GRM1555C2A470GA01# | | |
| | | | | ±0.5pF | GRM1555C2A9R0DA01# | | | | | ±5% | GRM1555C2A470JA01# | | |
| | | | 9.1pF | ±0.05pF | GRM1555C2A9R1WA01# | | | | 56pF | ±2% | GRM1555C2A560GA01# | | |
| | | | | ±0.1pF | GRM1555C2A9R1BA01# | | | | | ±5% | GRM1555C2A560JA01# | | |
| | | | | ±0.25pF | GRM1555C2A9R1CA01# | | | | 68pF | ±2% | GRM1555C2A680GA01# | | |
| | | | | ±0.5pF | GRM1555C2A9R1DA01# | | | | | ±5% | GRM1555C2A680JA01# | | |
| | | | 9.2pF | ±0.05pF | GRM1555C2A9R2WA01# | | | | 82pF | ±2% | GRM1555C2A820GA01# | | |
| | | | | ±0.1pF | GRM1555C2A9R2BA01# | | | | | ±5% | GRM1555C2A820JA01# | | |
| | | | | ±0.25pF | GRM1555C2A9R2CA01# | | | | 100pF | ±2% | GRM1555C2A101GA01# | | |
| | | | | ±0.5pF | GRM1555C2A9R2DA01# | | | | | ±5% | GRM1555C2A101JA01# | | |
| | | | 9.3pF | ±0.05pF | GRM1555C2A9R3WA01# | | | | CK | ±0.05pF | GRM1554C2AR10WA01# | | |
| | | | | ±0.1pF | GRM1555C2A9R3BA01# | | | | | ±0.05pF | GRM1554C2AR20WA01# | | |
| | | | | ±0.25pF | GRM1555C2A9R3CA01# | | | | | ±0.1pF | GRM1554C2AR20BA01# | | |
| | | | | ±0.5pF | GRM1555C2A9R3DA01# | | | | | 0.30pF | ±0.05pF | GRM1554C2AR30WA01# | |
| | | | 9.4pF | ±0.05pF | GRM1555C2A9R4WA01# | | | | | | ±0.1pF | GRM1554C2AR30BA01# | |
| | | | | ±0.1pF | GRM1555C2A9R4BA01# | | | | | 0.40pF | ±0.05pF | GRM1554C2AR40WA01# | |
| | | | | ±0.25pF | GRM1555C2A9R4CA01# | | | | | | ±0.1pF | GRM1554C2AR40BA01# | |
| | | | ±0.5pF | GRM1555C2A9R4DA01# | 0.50pF | | | | | ±0.05pF | GRM1554C2AR50WA01# | | |
| | | | 9.5pF | ±0.05pF | | | | | | GRM1555C2A9R5WA01# | ±0.1pF | GRM1554C2AR50BA01# | |
| | | | | ±0.1pF | GRM1555C2A9R5BA01# | | | | | 0.60pF | ±0.05pF | GRM1554C2AR60WA01# | |
| | | | | ±0.25pF | GRM1555C2A9R5CA01# | | | | | | ±0.1pF | GRM1554C2AR60BA01# | |
| | | | ±0.5pF | GRM1555C2A9R5DA01# | 0.70pF | | | | | ±0.05pF | GRM1554C2AR70WA01# | | |
| | | | 9.6pF | ±0.05pF | | | | | | GRM1555C2A9R6WA01# | ±0.1pF | GRM1554C2AR70BA01# | |
| | | | | ±0.1pF | GRM1555C2A9R6BA01# | | | | | 0.80pF | ±0.05pF | GRM1554C2AR80WA01# | |
| | | | | ±0.25pF | GRM1555C2A9R6CA01# | | | | | | ±0.1pF | GRM1554C2AR80BA01# | |
| | | | ±0.5pF | GRM1555C2A9R6DA01# | 0.90pF | | | | | ±0.05pF | GRM1554C2AR90WA01# | | |
| | | | 9.7pF | ±0.05pF | | | | | | GRM1555C2A9R7WA01# | ±0.1pF | GRM1554C2AR90BA01# | |
| | | | | ±0.1pF | GRM1555C2A9R7BA01# | | | | | 1.0pF | ±0.05pF | GRM1554C2A1R0WA01# | |
| | | | | ±0.25pF | GRM1555C2A9R7CA01# | | | | | | ±0.1pF | GRM1554C2A1R0BA01# | |
| | | | ±0.5pF | GRM1555C2A9R7DA01# | ±0.25pF | | | | | GRM1554C2A1R0CA01# | 1.1pF | ±0.05pF | GRM1554C2A1R1WA01# |
| | | | 9.8pF | ±0.05pF | GRM1555C2A9R8WA01# | | | | | ±0.1pF | | GRM1554C2A1R1BA01# | |
| | | | | ±0.1pF | GRM1555C2A9R8BA01# | | | | | ±0.25pF | | GRM1554C2A1R1CA01# | |
| | | | | ±0.25pF | GRM1555C2A9R8CA01# | | | | | 1.2pF | ±0.05pF | GRM1554C2A1R2WA01# | |
| | | | ±0.5pF | GRM1555C2A9R8DA01# | ±0.1pF | | | | | | GRM1554C2A1R2BA01# | | |
| | | | 9.9pF | ±0.05pF | GRM1555C2A9R9WA01# | | | | | ±0.25pF | GRM1554C2A1R2CA01# | | |
| | | | | ±0.1pF | GRM1555C2A9R9BA01# | | | | | 1.3pF | ±0.05pF | GRM1554C2A1R3WA01# | |
| | | | | ±0.25pF | GRM1555C2A9R9CA01# | | | | | | ±0.1pF | GRM1554C2A1R3BA01# | |
| | | | ±0.5pF | GRM1555C2A9R9DA01# | 1.4pF | | | | | ±0.25pF | GRM1554C2A1R3CA01# | | |
| | | | 10pF | ±2% | | | | | | GRM1555C2A100GA01# | ±0.05pF | GRM1554C2A1R4WA01# | |
| | | | | ±5% | GRM1555C2A100JA01# | | | | | ±0.1pF | GRM1554C2A1R4BA01# | | |
| | | | 12pF | ±2% | GRM1555C2A120GA01# | | | | | ±0.25pF | GRM1554C2A1R4CA01# | | |
| | | | | ±5% | GRM1555C2A120JA01# | | | | | 1.5pF | ±0.05pF | GRM1554C2A1R5WA01# | |
| | | | 15pF | ±2% | GRM1555C2A150GA01# | | | | | | ±0.1pF | GRM1554C2A1R5BA01# | |
| | | | | ±5% | GRM1555C2A150JA01# | | | | | ±0.25pF | GRM1554C2A1R5CA01# | | |
| | | | 18pF | ±2% | GRM1555C2A180GA01# | | | | | | | | |

- GRM
- GR3
- GRJ
- GR4
- GR7
- GJM
- GQM
- GA2
- GA3 GB
- GA3 GD
- GA3 GF
- LLL
- LLA
- LLM
- LLR
- NFM
- KRM
- KR3
- GMA
- GMD
- ⚠Caution /Notice

Part number # indicates the package specification code.

GRM Series Temperature Compensating Type Part Number List

(→ 1.0×0.5mm)

| T max. | Rated Voltage | TC Code | Cap. | Tol. | Part Number | T max. | Rated Voltage | TC Code | Cap. | Tol. | Part Number | | |
|--------|---------------|---------|---------|--------------------|--------------------|--------|---------------|--------------------|--------------------|---------|--------------------|---------|--------------------|
| 0.55mm | 100Vdc | CK | 1.6pF | ±0.05pF | GRM1554C2A1R6WA01# | 0.55mm | 100Vdc | CJ | 3.4pF | ±0.05pF | GRM1553C2A3R4WA01# | | |
| | | | | ±0.1pF | GRM1554C2A1R6BA01# | | | | | ±0.1pF | GRM1553C2A3R4BA01# | | |
| | | | | ±0.25pF | GRM1554C2A1R6CA01# | | | | | ±0.25pF | GRM1553C2A3R4CA01# | | |
| | | | 1.7pF | ±0.05pF | GRM1554C2A1R7WA01# | | | | 3.5pF | ±0.05pF | GRM1553C2A3R5WA01# | | |
| | | | | ±0.1pF | GRM1554C2A1R7BA01# | | | | | ±0.1pF | GRM1553C2A3R5BA01# | | |
| | | | | ±0.25pF | GRM1554C2A1R7CA01# | | | | | ±0.25pF | GRM1553C2A3R5CA01# | | |
| | | | 1.8pF | ±0.05pF | GRM1554C2A1R8WA01# | | | | 3.6pF | ±0.05pF | GRM1553C2A3R6WA01# | | |
| | | | | ±0.1pF | GRM1554C2A1R8BA01# | | | | | ±0.1pF | GRM1553C2A3R6BA01# | | |
| | | | | ±0.25pF | GRM1554C2A1R8CA01# | | | | | ±0.25pF | GRM1553C2A3R6CA01# | | |
| | | | 1.9pF | ±0.05pF | GRM1554C2A1R9WA01# | | | | 3.7pF | ±0.05pF | GRM1553C2A3R7WA01# | | |
| | | | | ±0.1pF | GRM1554C2A1R9BA01# | | | | | ±0.1pF | GRM1553C2A3R7BA01# | | |
| | | | | ±0.25pF | GRM1554C2A1R9CA01# | | | | | ±0.25pF | GRM1553C2A3R7CA01# | | |
| | | | 2.0pF | ±0.05pF | GRM1554C2A2R0WA01# | | | | 3.8pF | ±0.05pF | GRM1553C2A3R8WA01# | | |
| | | | | ±0.1pF | GRM1554C2A2R0BA01# | | | | | ±0.1pF | GRM1553C2A3R8BA01# | | |
| | | | | ±0.25pF | GRM1554C2A2R0CA01# | | | | | ±0.25pF | GRM1553C2A3R8CA01# | | |
| | | | CJ | 2.1pF | ±0.05pF | | | | GRM1553C2A2R1WA01# | CH | 4.0pF | ±0.05pF | GRM1552C2A4R0WA01# |
| | | | | | ±0.1pF | | | | GRM1553C2A2R1BA01# | | | ±0.1pF | GRM1552C2A4R0BA01# |
| | | | | | ±0.25pF | | | | GRM1553C2A2R1CA01# | | | ±0.25pF | GRM1552C2A4R0CA01# |
| | | | | 2.2pF | ±0.05pF | | | | GRM1553C2A2R2WA01# | | 4.1pF | ±0.05pF | GRM1552C2A4R1WA01# |
| | | | | | ±0.1pF | | | | GRM1553C2A2R2BA01# | | | ±0.1pF | GRM1552C2A4R1BA01# |
| | | | | | ±0.25pF | | | | GRM1553C2A2R2CA01# | | | ±0.25pF | GRM1552C2A4R1CA01# |
| | | | | 2.3pF | ±0.05pF | | | | GRM1553C2A2R3WA01# | | 4.2pF | ±0.05pF | GRM1552C2A4R2WA01# |
| | | | | | ±0.1pF | | | | GRM1553C2A2R3BA01# | | | ±0.1pF | GRM1552C2A4R2BA01# |
| | | | | | ±0.25pF | | | | GRM1553C2A2R3CA01# | | | ±0.25pF | GRM1552C2A4R2CA01# |
| | | | | 2.4pF | ±0.05pF | | | | GRM1553C2A2R4WA01# | | 4.3pF | ±0.05pF | GRM1552C2A4R3WA01# |
| | | | | | ±0.1pF | | | | GRM1553C2A2R4BA01# | | | ±0.1pF | GRM1552C2A4R3BA01# |
| | | | | | ±0.25pF | | | | GRM1553C2A2R4CA01# | | | ±0.25pF | GRM1552C2A4R3CA01# |
| | | | | 2.5pF | ±0.05pF | | | | GRM1553C2A2R5WA01# | | 4.4pF | ±0.05pF | GRM1552C2A4R4WA01# |
| | | | | | ±0.1pF | | | | GRM1553C2A2R5BA01# | | | ±0.1pF | GRM1552C2A4R4BA01# |
| | | | | | ±0.25pF | | | | GRM1553C2A2R5CA01# | | | ±0.25pF | GRM1552C2A4R4CA01# |
| | | | | 2.6pF | ±0.05pF | | | | GRM1553C2A2R6WA01# | | 4.5pF | ±0.05pF | GRM1552C2A4R5WA01# |
| | | | | | ±0.1pF | | | | GRM1553C2A2R6BA01# | | | ±0.1pF | GRM1552C2A4R5BA01# |
| | | | | | ±0.25pF | | | | GRM1553C2A2R6CA01# | | | ±0.25pF | GRM1552C2A4R5CA01# |
| | | | | 2.7pF | ±0.05pF | | | | GRM1553C2A2R7WA01# | | 4.6pF | ±0.05pF | GRM1552C2A4R6WA01# |
| | | | | | ±0.1pF | | | | GRM1553C2A2R7BA01# | | | ±0.1pF | GRM1552C2A4R6BA01# |
| | | | | | ±0.25pF | | | | GRM1553C2A2R7CA01# | | | ±0.25pF | GRM1552C2A4R6CA01# |
| | | 2.8pF | | ±0.05pF | GRM1553C2A2R8WA01# | 4.7pF | ±0.05pF | GRM1552C2A4R7WA01# | | | | | |
| | | | | ±0.1pF | GRM1553C2A2R8BA01# | | ±0.1pF | GRM1552C2A4R7BA01# | | | | | |
| | | | | ±0.25pF | GRM1553C2A2R8CA01# | | ±0.25pF | GRM1552C2A4R7CA01# | | | | | |
| | | 2.9pF | | ±0.05pF | GRM1553C2A2R9WA01# | 4.8pF | ±0.05pF | GRM1552C2A4R8WA01# | | | | | |
| | | | | ±0.1pF | GRM1553C2A2R9BA01# | | ±0.1pF | GRM1552C2A4R8BA01# | | | | | |
| | | | | ±0.25pF | GRM1553C2A2R9CA01# | | ±0.25pF | GRM1552C2A4R8CA01# | | | | | |
| | | 3.0pF | | ±0.05pF | GRM1553C2A3R0WA01# | 5.0pF | ±0.05pF | GRM1552C2A5R0WA01# | | | | | |
| | | | | ±0.1pF | GRM1553C2A3R0BA01# | | ±0.1pF | GRM1552C2A5R0BA01# | | | | | |
| | | | | ±0.25pF | GRM1553C2A3R0CA01# | | ±0.25pF | GRM1552C2A5R0CA01# | | | | | |
| | | 3.1pF | | ±0.05pF | GRM1553C2A3R1WA01# | | 5.1pF | ±0.05pF | GRM1552C2A5R1WA01# | | | | |
| | | | | ±0.1pF | GRM1553C2A3R1BA01# | | | ±0.1pF | GRM1552C2A5R1BA01# | | | | |
| | | | | ±0.25pF | GRM1553C2A3R1CA01# | | | ±0.25pF | GRM1552C2A5R1CA01# | | | | |
| | | 3.2pF | | ±0.05pF | GRM1553C2A3R2WA01# | | | | | | | | |
| | | | | ±0.1pF | GRM1553C2A3R2BA01# | | | | | | | | |
| | | | | ±0.25pF | GRM1553C2A3R2CA01# | | | | | | | | |
| | | 3.3pF | ±0.05pF | GRM1553C2A3R3WA01# | | | | | | | | | |
| | | | ±0.1pF | GRM1553C2A3R3BA01# | | | | | | | | | |
| | | | ±0.25pF | GRM1553C2A3R3CA01# | | | | | | | | | |

Part number # indicates the package specification code.



GRM Series Temperature Compensating Type Part Number List

(→ 1.0×0.5mm)

| T max. | Rated Voltage | TC Code | Cap. | Tol. | Part Number | |
|--------|---------------|---------|---------|--------------------|--------------------|--------------------|
| 0.55mm | 100Vdc | CH | 5.1pF | ±0.5pF | GRM1552C2A5R1DA01# | |
| | | | | ±0.05pF | GRM1552C2A5R2WA01# | |
| | | | | | ±0.1pF | GRM1552C2A5R2BA01# |
| | | | ±0.25pF | | GRM1552C2A5R2CA01# | |
| | | | ±0.5pF | GRM1552C2A5R2DA01# | | |
| | | | | 5.3pF | ±0.05pF | GRM1552C2A5R3WA01# |
| | | | | | ±0.1pF | GRM1552C2A5R3BA01# |
| | | | ±0.25pF | | GRM1552C2A5R3CA01# | |
| | | | ±0.5pF | GRM1552C2A5R3DA01# | | |
| | | | 5.4pF | ±0.05pF | GRM1552C2A5R4WA01# | |
| | | | | ±0.1pF | GRM1552C2A5R4BA01# | |
| | | | | ±0.25pF | GRM1552C2A5R4CA01# | |
| | | | ±0.5pF | GRM1552C2A5R4DA01# | | |
| | | | 5.5pF | ±0.05pF | GRM1552C2A5R5WA01# | |
| | | | | ±0.1pF | GRM1552C2A5R5BA01# | |
| | | | | ±0.25pF | GRM1552C2A5R5CA01# | |
| | | | ±0.5pF | GRM1552C2A5R5DA01# | | |
| | | | 5.6pF | ±0.05pF | GRM1552C2A5R6WA01# | |
| | | | | ±0.1pF | GRM1552C2A5R6BA01# | |
| | | | | ±0.25pF | GRM1552C2A5R6CA01# | |
| | | | ±0.5pF | GRM1552C2A5R6DA01# | | |
| | | | 5.7pF | ±0.05pF | GRM1552C2A5R7WA01# | |
| | | | | ±0.1pF | GRM1552C2A5R7BA01# | |
| | | | | ±0.25pF | GRM1552C2A5R7CA01# | |
| | | | ±0.5pF | GRM1552C2A5R7DA01# | | |
| | | | 5.8pF | ±0.05pF | GRM1552C2A5R8WA01# | |
| | | | | ±0.1pF | GRM1552C2A5R8BA01# | |
| | | | | ±0.25pF | GRM1552C2A5R8CA01# | |
| | | | ±0.5pF | GRM1552C2A5R8DA01# | | |
| | | | 5.9pF | ±0.05pF | GRM1552C2A5R9WA01# | |
| | | | | ±0.1pF | GRM1552C2A5R9BA01# | |
| | | | | ±0.25pF | GRM1552C2A5R9CA01# | |
| | | | ±0.5pF | GRM1552C2A5R9DA01# | | |
| | | | 6.0pF | ±0.05pF | GRM1552C2A6R0WA01# | |
| | | | | ±0.1pF | GRM1552C2A6R0BA01# | |
| | | | | ±0.25pF | GRM1552C2A6R0CA01# | |
| | | | ±0.5pF | GRM1552C2A6R0DA01# | | |
| | | | 6.1pF | ±0.05pF | GRM1552C2A6R1WA01# | |
| | | | | ±0.1pF | GRM1552C2A6R1BA01# | |
| | | | | ±0.25pF | GRM1552C2A6R1CA01# | |
| | | | ±0.5pF | GRM1552C2A6R1DA01# | | |
| | | | 6.2pF | ±0.05pF | GRM1552C2A6R2WA01# | |
| | | | | ±0.1pF | GRM1552C2A6R2BA01# | |
| | | | | ±0.25pF | GRM1552C2A6R2CA01# | |
| | | | ±0.5pF | GRM1552C2A6R2DA01# | | |
| | | | 6.3pF | ±0.05pF | GRM1552C2A6R3WA01# | |
| | | | | ±0.1pF | GRM1552C2A6R3BA01# | |
| | | | | ±0.25pF | GRM1552C2A6R3CA01# | |
| | | | ±0.5pF | GRM1552C2A6R3DA01# | | |
| | | | 6.4pF | ±0.05pF | GRM1552C2A6R4WA01# | |
| | | | | ±0.1pF | GRM1552C2A6R4BA01# | |
| | | | | ±0.25pF | GRM1552C2A6R4CA01# | |
| | | | ±0.5pF | GRM1552C2A6R4DA01# | | |
| | | | 6.5pF | ±0.05pF | GRM1552C2A6R5WA01# | |

| T max. | Rated Voltage | TC Code | Cap. | Tol. | Part Number |
|--------|---------------|---------|--------|--------------------|--------------------|
| 0.55mm | 100Vdc | CH | 6.5pF | ±0.1pF | GRM1552C2A6R5BA01# |
| | | | | ±0.25pF | GRM1552C2A6R5CA01# |
| | | | | ±0.5pF | GRM1552C2A6R5DA01# |
| | | | 6.6pF | ±0.05pF | GRM1552C2A6R6WA01# |
| | | | | ±0.1pF | GRM1552C2A6R6BA01# |
| | | | | ±0.25pF | GRM1552C2A6R6CA01# |
| | | | ±0.5pF | GRM1552C2A6R6DA01# | |
| | | | 6.7pF | ±0.05pF | GRM1552C2A6R7WA01# |
| | | | | ±0.1pF | GRM1552C2A6R7BA01# |
| | | | | ±0.25pF | GRM1552C2A6R7CA01# |
| | | | ±0.5pF | GRM1552C2A6R7DA01# | |
| | | | 6.8pF | ±0.05pF | GRM1552C2A6R8WA01# |
| | | | | ±0.1pF | GRM1552C2A6R8BA01# |
| | | | | ±0.25pF | GRM1552C2A6R8CA01# |
| | | | ±0.5pF | GRM1552C2A6R8DA01# | |
| | | | 6.9pF | ±0.05pF | GRM1552C2A6R9WA01# |
| | | | | ±0.1pF | GRM1552C2A6R9BA01# |
| | | | | ±0.25pF | GRM1552C2A6R9CA01# |
| | | | ±0.5pF | GRM1552C2A6R9DA01# | |
| | | | 7.0pF | ±0.05pF | GRM1552C2A7R0WA01# |
| | | | | ±0.1pF | GRM1552C2A7R0BA01# |
| | | | | ±0.25pF | GRM1552C2A7R0CA01# |
| | | | ±0.5pF | GRM1552C2A7R0DA01# | |
| | | | 7.1pF | ±0.05pF | GRM1552C2A7R1WA01# |
| | | | | ±0.1pF | GRM1552C2A7R1BA01# |
| | | | | ±0.25pF | GRM1552C2A7R1CA01# |
| | | | ±0.5pF | GRM1552C2A7R1DA01# | |
| | | | 7.2pF | ±0.05pF | GRM1552C2A7R2WA01# |
| | | | | ±0.1pF | GRM1552C2A7R2BA01# |
| | | | | ±0.25pF | GRM1552C2A7R2CA01# |
| | | | ±0.5pF | GRM1552C2A7R2DA01# | |
| | | | 7.3pF | ±0.05pF | GRM1552C2A7R3WA01# |
| | | | | ±0.1pF | GRM1552C2A7R3BA01# |
| | | | | ±0.25pF | GRM1552C2A7R3CA01# |
| | | | ±0.5pF | GRM1552C2A7R3DA01# | |
| | | | 7.4pF | ±0.05pF | GRM1552C2A7R4WA01# |
| | | | | ±0.1pF | GRM1552C2A7R4BA01# |
| | | | | ±0.25pF | GRM1552C2A7R4CA01# |
| | | | ±0.5pF | GRM1552C2A7R4DA01# | |
| | | | 7.5pF | ±0.05pF | GRM1552C2A7R5WA01# |
| | | | | ±0.1pF | GRM1552C2A7R5BA01# |
| | | | | ±0.25pF | GRM1552C2A7R5CA01# |
| | | | ±0.5pF | GRM1552C2A7R5DA01# | |
| | | | 7.6pF | ±0.05pF | GRM1552C2A7R6WA01# |
| | | | | ±0.1pF | GRM1552C2A7R6BA01# |
| | | | | ±0.25pF | GRM1552C2A7R6CA01# |
| | | | ±0.5pF | GRM1552C2A7R6DA01# | |
| | | | 7.7pF | ±0.05pF | GRM1552C2A7R7WA01# |
| | | | | ±0.1pF | GRM1552C2A7R7BA01# |
| | | | | ±0.25pF | GRM1552C2A7R7CA01# |
| | | | ±0.5pF | GRM1552C2A7R7DA01# | |
| | | | 7.8pF | ±0.05pF | GRM1552C2A7R8WA01# |
| | | | | ±0.1pF | GRM1552C2A7R8BA01# |
| | | | | ±0.25pF | GRM1552C2A7R8CA01# |

- GRM
- GR3
- GRJ
- GR4
- GR7
- GJM
- GQM
- GA2
- GA3 GB
- GA3 GD
- GA3 GF
- LLL
- LLA
- LLM
- LLR
- NFM
- KRM
- KR3
- GMA
- GMD
- ⚠Caution /Notice

Part number # indicates the package specification code.

GRM Series Temperature Compensating Type Part Number List

(→ 1.0×0.5mm)

| T max. | Rated Voltage | TC Code | Cap. | Tol. | Part Number | T max. | Rated Voltage | TC Code | Cap. | Tol. | Part Number | |
|--------|---------------|---------|--------|--------------------|--------------------|--------|---------------|---------|--------------------|---------|--------------------|--------------------|
| 0.55mm | 100Vdc | CH | 7.8pF | ±0.5pF | GRM1552C2A7R8DA01# | 0.55mm | 100Vdc | CH | 9.2pF | ±0.1pF | GRM1552C2A9R2BA01# | |
| | | | | ±0.05pF | GRM1552C2A7R9WA01# | | | | | ±0.25pF | GRM1552C2A9R2CA01# | |
| | | | | ±0.1pF | GRM1552C2A7R9BA01# | | | | | ±0.5pF | GRM1552C2A9R2DA01# | |
| | | | | ±0.25pF | GRM1552C2A7R9CA01# | | | | | 9.3pF | ±0.05pF | GRM1552C2A9R3WA01# |
| | | | ±0.5pF | GRM1552C2A7R9DA01# | ±0.1pF | | | | GRM1552C2A9R3BA01# | | | |
| | | | 8.0pF | ±0.05pF | GRM1552C2A8R0WA01# | | | | ±0.25pF | | GRM1552C2A9R3CA01# | |
| | | | | ±0.1pF | GRM1552C2A8R0BA01# | | | | ±0.5pF | | GRM1552C2A9R3DA01# | |
| | | | | ±0.25pF | GRM1552C2A8R0CA01# | | | | 9.4pF | ±0.05pF | GRM1552C2A9R4WA01# | |
| | | | | ±0.5pF | GRM1552C2A8R0DA01# | | | | | ±0.1pF | GRM1552C2A9R4BA01# | |
| | | | 8.1pF | ±0.05pF | GRM1552C2A8R1WA01# | | | | | ±0.25pF | GRM1552C2A9R4CA01# | |
| | | | | ±0.1pF | GRM1552C2A8R1BA01# | | | | | ±0.5pF | GRM1552C2A9R4DA01# | |
| | | | | ±0.25pF | GRM1552C2A8R1CA01# | | | | 9.5pF | ±0.05pF | GRM1552C2A9R5WA01# | |
| | | | | ±0.5pF | GRM1552C2A8R1DA01# | | | | | ±0.1pF | GRM1552C2A9R5BA01# | |
| | | | 8.2pF | ±0.05pF | GRM1552C2A8R2WA01# | | | | | ±0.25pF | GRM1552C2A9R5CA01# | |
| | | | | ±0.1pF | GRM1552C2A8R2BA01# | | | | | ±0.5pF | GRM1552C2A9R5DA01# | |
| | | | | ±0.25pF | GRM1552C2A8R2CA01# | | | | 9.6pF | ±0.05pF | GRM1552C2A9R6WA01# | |
| | | | | ±0.5pF | GRM1552C2A8R2DA01# | | | | | ±0.1pF | GRM1552C2A9R6BA01# | |
| | | | 8.3pF | ±0.05pF | GRM1552C2A8R3WA01# | | | | | ±0.25pF | GRM1552C2A9R6CA01# | |
| | | | | ±0.1pF | GRM1552C2A8R3BA01# | | | | | ±0.5pF | GRM1552C2A9R6DA01# | |
| | | | | ±0.25pF | GRM1552C2A8R3CA01# | | | | 9.7pF | ±0.05pF | GRM1552C2A9R7WA01# | |
| | | | | ±0.5pF | GRM1552C2A8R3DA01# | | | | | ±0.1pF | GRM1552C2A9R7BA01# | |
| | | | 8.4pF | ±0.05pF | GRM1552C2A8R4WA01# | | | | | ±0.25pF | GRM1552C2A9R7CA01# | |
| | | | | ±0.1pF | GRM1552C2A8R4BA01# | | | | | ±0.5pF | GRM1552C2A9R7DA01# | |
| | | | | ±0.25pF | GRM1552C2A8R4CA01# | | | | 9.8pF | ±0.05pF | GRM1552C2A9R8WA01# | |
| | | | | ±0.5pF | GRM1552C2A8R4DA01# | | | | | ±0.1pF | GRM1552C2A9R8BA01# | |
| | | | 8.5pF | ±0.05pF | GRM1552C2A8R5WA01# | | | | | ±0.25pF | GRM1552C2A9R8CA01# | |
| | | | | ±0.1pF | GRM1552C2A8R5BA01# | | | | | ±0.5pF | GRM1552C2A9R8DA01# | |
| | | | | ±0.25pF | GRM1552C2A8R5CA01# | | | | 9.9pF | ±0.05pF | GRM1552C2A9R9WA01# | |
| | | | | ±0.5pF | GRM1552C2A8R5DA01# | | | | | ±0.1pF | GRM1552C2A9R9BA01# | |
| | | | 8.6pF | ±0.05pF | GRM1552C2A8R6WA01# | | | | | ±0.25pF | GRM1552C2A9R9CA01# | |
| | | | | ±0.1pF | GRM1552C2A8R6BA01# | | | | | ±0.5pF | GRM1552C2A9R9DA01# | |
| | | | | ±0.25pF | GRM1552C2A8R6CA01# | | | | 10pF | ±2% | GRM1552C2A100GA01# | |
| | | | | ±0.5pF | GRM1552C2A8R6DA01# | | | | | ±5% | GRM1552C2A100JA01# | |
| | | | 8.7pF | ±0.05pF | GRM1552C2A8R7WA01# | | | | | 12pF | ±2% | GRM1552C2A120GA01# |
| | | | | ±0.1pF | GRM1552C2A8R7BA01# | | | | | | ±5% | GRM1552C2A120JA01# |
| | | | | ±0.25pF | GRM1552C2A8R7CA01# | | | | 15pF | | ±2% | GRM1552C2A150GA01# |
| | | | | ±0.5pF | GRM1552C2A8R7DA01# | | | | | | ±5% | GRM1552C2A150JA01# |
| | | | 8.8pF | ±0.05pF | GRM1552C2A8R8WA01# | | | | | 18pF | ±2% | GRM1552C2A180GA01# |
| | | | | ±0.1pF | GRM1552C2A8R8BA01# | | | | | | ±5% | GRM1552C2A180JA01# |
| | | | | ±0.25pF | GRM1552C2A8R8CA01# | | | | 22pF | | ±2% | GRM1552C2A220GA01# |
| | | | | ±0.5pF | GRM1552C2A8R8DA01# | | | | | | ±5% | GRM1552C2A220JA01# |
| | | | 8.9pF | ±0.05pF | GRM1552C2A8R9WA01# | | | | | 27pF | ±2% | GRM1552C2A270GA01# |
| | | | | ±0.1pF | GRM1552C2A8R9BA01# | | | | | | ±5% | GRM1552C2A270JA01# |
| | | | | ±0.25pF | GRM1552C2A8R9CA01# | | | | 33pF | | ±2% | GRM1552C2A330GA01# |
| | | | | ±0.5pF | GRM1552C2A8R9DA01# | | | | | | ±5% | GRM1552C2A330JA01# |
| | | | 9.0pF | ±0.05pF | GRM1552C2A9R0WA01# | | | | | 39pF | ±2% | GRM1552C2A390GA01# |
| | | | | ±0.1pF | GRM1552C2A9R0BA01# | | | | | | ±5% | GRM1552C2A390JA01# |
| | | | | ±0.25pF | GRM1552C2A9R0CA01# | | | | 47pF | | ±2% | GRM1552C2A470GA01# |
| | | | | ±0.5pF | GRM1552C2A9R0DA01# | | | | | | ±5% | GRM1552C2A470JA01# |
| | | | 9.1pF | ±0.05pF | GRM1552C2A9R1WA01# | | | | | 56pF | ±2% | GRM1552C2A560GA01# |
| | | | | ±0.1pF | GRM1552C2A9R1BA01# | | | | | | ±5% | GRM1552C2A560JA01# |
| | | | | ±0.25pF | GRM1552C2A9R1CA01# | | | | 68pF | | ±2% | GRM1552C2A680GA01# |
| | | | | ±0.5pF | GRM1552C2A9R1DA01# | | | | | | ±5% | GRM1552C2A680JA01# |
| | | | 9.2pF | ±0.05pF | GRM1552C2A9R2WA01# | | | | | 82pF | ±2% | GRM1552C2A820GA01# |

Part number # indicates the package specification code.



GRM Series Temperature Compensating Type Part Number List

(→ 1.0×0.5mm)

| T max. | Rated Voltage | TC Code | Cap. | Tol. | Part Number |
|--------|---------------|--------------------|---------|--------------------|--------------------|
| 0.55mm | 100Vdc | CH | 82pF | ±5% | GRM1552C2A820JA01# |
| | | | 100pF | ±2% | GRM1552C2A101GA01# |
| ±5% | | | | GRM1552C2A101JA01# | |
| 50Vdc | COG | 0.10pF | ±0.05pF | GRM1555C1HR10WA01# | |
| | | | ±0.1pF | GRM1555C1HR20BA01# | |
| | | 0.20pF | ±0.05pF | GRM1555C1HR20WA01# | |
| | | | ±0.1pF | GRM1555C1HR20BA01# | |
| | | 0.30pF | ±0.05pF | GRM1555C1HR30WA01# | |
| | | | ±0.1pF | GRM1555C1HR30BA01# | |
| | | 0.40pF | ±0.05pF | GRM1555C1HR40WA01# | |
| | | | ±0.1pF | GRM1555C1HR40BA01# | |
| | | 0.50pF | ±0.05pF | GRM1555C1HR50WA01# | |
| | | | ±0.1pF | GRM1555C1HR50BA01# | |
| | | 0.60pF | ±0.05pF | GRM1555C1HR60WA01# | |
| | | | ±0.1pF | GRM1555C1HR60BA01# | |
| | | 0.70pF | ±0.05pF | GRM1555C1HR70WA01# | |
| | | | ±0.1pF | GRM1555C1HR70BA01# | |
| | | 0.80pF | ±0.05pF | GRM1555C1HR80WA01# | |
| | | | ±0.1pF | GRM1555C1HR80BA01# | |
| | | 0.90pF | ±0.05pF | GRM1555C1HR90WA01# | |
| | | | ±0.1pF | GRM1555C1HR90BA01# | |
| | | 1.0pF | ±0.05pF | GRM1555C1H1R0WA01# | |
| | | | ±0.1pF | GRM1555C1H1R0BA01# | |
| | | | ±0.25pF | GRM1555C1H1R0CA01# | |
| | | 1.1pF | ±0.05pF | GRM1555C1H1R1WA01# | |
| | | | ±0.1pF | GRM1555C1H1R1BA01# | |
| | | | ±0.25pF | GRM1555C1H1R1CA01# | |
| | | 1.2pF | ±0.05pF | GRM1555C1H1R2WA01# | |
| | | | ±0.1pF | GRM1555C1H1R2BA01# | |
| | | | ±0.25pF | GRM1555C1H1R2CA01# | |
| | | 1.3pF | ±0.05pF | GRM1555C1H1R3WA01# | |
| | | | ±0.1pF | GRM1555C1H1R3BA01# | |
| | | | ±0.25pF | GRM1555C1H1R3CA01# | |
| | | 1.4pF | ±0.05pF | GRM1555C1H1R4WA01# | |
| | | | ±0.1pF | GRM1555C1H1R4BA01# | |
| | | | ±0.25pF | GRM1555C1H1R4CA01# | |
| | | 1.5pF | ±0.05pF | GRM1555C1H1R5WA01# | |
| | | | ±0.1pF | GRM1555C1H1R5BA01# | |
| | | | ±0.25pF | GRM1555C1H1R5CA01# | |
| | | 1.6pF | ±0.05pF | GRM1555C1H1R6WA01# | |
| | | | ±0.1pF | GRM1555C1H1R6BA01# | |
| | | | ±0.25pF | GRM1555C1H1R6CA01# | |
| | | 1.7pF | ±0.05pF | GRM1555C1H1R7WA01# | |
| | | | ±0.1pF | GRM1555C1H1R7BA01# | |
| | | | ±0.25pF | GRM1555C1H1R7CA01# | |
| | | 1.8pF | ±0.05pF | GRM1555C1H1R8WA01# | |
| | | | ±0.1pF | GRM1555C1H1R8BA01# | |
| | | | ±0.25pF | GRM1555C1H1R8CA01# | |
| | | 1.9pF | ±0.05pF | GRM1555C1H1R9WA01# | |
| | | | ±0.1pF | GRM1555C1H1R9BA01# | |
| | | | ±0.25pF | GRM1555C1H1R9CA01# | |
| 2.0pF | ±0.05pF | GRM1555C1H2R0WA01# | | | |
| | ±0.1pF | GRM1555C1H2R0BA01# | | | |
| | ±0.25pF | GRM1555C1H2R0CA01# | | | |
| 2.1pF | ±0.05pF | GRM1555C1H2R1WA01# | | | |

| T max. | Rated Voltage | TC Code | Cap. | Tol. | Part Number |
|--------|---------------|--------------------|-------|---------|--------------------|
| 0.55mm | 50Vdc | COG | 2.1pF | ±0.1pF | GRM1555C1H2R1BA01# |
| | | | | ±0.25pF | GRM1555C1H2R1CA01# |
| | | | 2.2pF | ±0.05pF | GRM1555C1H2R2WA01# |
| | | | | ±0.1pF | GRM1555C1H2R2BA01# |
| | | | 2.3pF | ±0.05pF | GRM1555C1H2R3WA01# |
| | | | | ±0.25pF | GRM1555C1H2R3CA01# |
| | | | 2.4pF | ±0.05pF | GRM1555C1H2R4WA01# |
| | | | | ±0.1pF | GRM1555C1H2R4BA01# |
| | | | | ±0.25pF | GRM1555C1H2R4CA01# |
| | | | 2.5pF | ±0.05pF | GRM1555C1H2R5WA01# |
| | | | | ±0.1pF | GRM1555C1H2R5BA01# |
| | | | | ±0.25pF | GRM1555C1H2R5CA01# |
| | | | 2.6pF | ±0.05pF | GRM1555C1H2R6WA01# |
| | | | | ±0.1pF | GRM1555C1H2R6BA01# |
| | | | | ±0.25pF | GRM1555C1H2R6CA01# |
| | | | 2.7pF | ±0.05pF | GRM1555C1H2R7WA01# |
| | | | | ±0.1pF | GRM1555C1H2R7BA01# |
| | | | | ±0.25pF | GRM1555C1H2R7CA01# |
| | | | 2.8pF | ±0.05pF | GRM1555C1H2R8WA01# |
| | | | | ±0.1pF | GRM1555C1H2R8BA01# |
| | | | | ±0.25pF | GRM1555C1H2R8CA01# |
| | | | 2.9pF | ±0.05pF | GRM1555C1H2R9WA01# |
| | | | | ±0.1pF | GRM1555C1H2R9BA01# |
| | | | | ±0.25pF | GRM1555C1H2R9CA01# |
| | | | 3.0pF | ±0.05pF | GRM1555C1H3R0WA01# |
| | | | | ±0.1pF | GRM1555C1H3R0BA01# |
| | | | | ±0.25pF | GRM1555C1H3R0CA01# |
| | | | 3.1pF | ±0.05pF | GRM1555C1H3R1WA01# |
| | | | | ±0.1pF | GRM1555C1H3R1BA01# |
| | | | | ±0.25pF | GRM1555C1H3R1CA01# |
| | | | 3.2pF | ±0.05pF | GRM1555C1H3R2WA01# |
| | | | | ±0.1pF | GRM1555C1H3R2BA01# |
| | | | | ±0.25pF | GRM1555C1H3R2CA01# |
| | | | 3.3pF | ±0.05pF | GRM1555C1H3R3WA01# |
| | | | | ±0.1pF | GRM1555C1H3R3BA01# |
| | | | | ±0.25pF | GRM1555C1H3R3CA01# |
| | | | 3.4pF | ±0.05pF | GRM1555C1H3R4WA01# |
| | | | | ±0.1pF | GRM1555C1H3R4BA01# |
| | | | | ±0.25pF | GRM1555C1H3R4CA01# |
| | | | 3.5pF | ±0.05pF | GRM1555C1H3R5WA01# |
| | | | | ±0.1pF | GRM1555C1H3R5BA01# |
| | | | | ±0.25pF | GRM1555C1H3R5CA01# |
| | | | 3.6pF | ±0.05pF | GRM1555C1H3R6WA01# |
| | | | | ±0.1pF | GRM1555C1H3R6BA01# |
| | | | | ±0.25pF | GRM1555C1H3R6CA01# |
| | | | 3.7pF | ±0.05pF | GRM1555C1H3R7WA01# |
| | | | | ±0.1pF | GRM1555C1H3R7BA01# |
| | | | | ±0.25pF | GRM1555C1H3R7CA01# |
| 3.8pF | ±0.05pF | GRM1555C1H3R8WA01# | | | |
| | ±0.1pF | GRM1555C1H3R8BA01# | | | |
| | ±0.25pF | GRM1555C1H3R8CA01# | | | |
| 3.9pF | ±0.05pF | GRM1555C1H3R9WA01# | | | |

- GRM
- GR3
- GRJ
- GR4
- GR7
- GJM
- GQM
- GA2
- GA3 GB
- GA3 GD
- GA3 GF
- LLL
- LLA
- LLM
- LLR
- NFM
- KRM
- KR3
- GMA
- GMD
- ⚠Caution /Notice

Part number # indicates the package specification code.

GRM Series Temperature Compensating Type Part Number List

(→ 1.0×0.5mm)

| T max. | Rated Voltage | TC Code | Cap. | Tol. | Part Number |
|--------|---------------|---------|-------|---------|--------------------|
| 0.55mm | 50Vdc | COG | 3.9pF | ±0.1pF | GRM1555C1H3R9BA01# |
| | | | | ±0.25pF | GRM1555C1H3R9CA01# |
| | | | 4.0pF | ±0.05pF | GRM1555C1H4ROWA01# |
| | | | | ±0.1pF | GRM1555C1H4ROBA01# |
| | | | | ±0.25pF | GRM1555C1H4ROCA01# |
| | | | | ±0.05pF | GRM1555C1H4R1WA01# |
| | | | 4.1pF | ±0.1pF | GRM1555C1H4R1BA01# |
| | | | | ±0.25pF | GRM1555C1H4R1CA01# |
| | | | | ±0.05pF | GRM1555C1H4R2WA01# |
| | | | 4.2pF | ±0.1pF | GRM1555C1H4R2BA01# |
| | | | | ±0.25pF | GRM1555C1H4R2CA01# |
| | | | | ±0.05pF | GRM1555C1H4R3WA01# |
| | | | 4.3pF | ±0.1pF | GRM1555C1H4R3BA01# |
| | | | | ±0.25pF | GRM1555C1H4R3CA01# |
| | | | | ±0.05pF | GRM1555C1H4R4WA01# |
| | | | 4.4pF | ±0.1pF | GRM1555C1H4R4BA01# |
| | | | | ±0.25pF | GRM1555C1H4R4CA01# |
| | | | | ±0.05pF | GRM1555C1H4R5WA01# |
| | | | 4.5pF | ±0.1pF | GRM1555C1H4R5BA01# |
| | | | | ±0.25pF | GRM1555C1H4R5CA01# |
| | | | | ±0.05pF | GRM1555C1H4R6WA01# |
| | | | 4.6pF | ±0.1pF | GRM1555C1H4R6BA01# |
| | | | | ±0.25pF | GRM1555C1H4R6CA01# |
| | | | | ±0.05pF | GRM1555C1H4R7WA01# |
| | | | 4.7pF | ±0.1pF | GRM1555C1H4R7BA01# |
| | | | | ±0.25pF | GRM1555C1H4R7CA01# |
| | | | | ±0.05pF | GRM1555C1H4R8WA01# |
| | | | 4.8pF | ±0.1pF | GRM1555C1H4R8BA01# |
| | | | | ±0.25pF | GRM1555C1H4R8CA01# |
| | | | | ±0.05pF | GRM1555C1H4R9WA01# |
| | | | 4.9pF | ±0.1pF | GRM1555C1H4R9BA01# |
| | | | | ±0.25pF | GRM1555C1H4R9CA01# |
| | | | | ±0.05pF | GRM1555C1H5R0WA01# |
| | | | 5.0pF | ±0.1pF | GRM1555C1H5R0BA01# |
| | | | | ±0.25pF | GRM1555C1H5R0CA01# |
| | | | | ±0.05pF | GRM1555C1H5R1WA01# |
| | | | 5.1pF | ±0.1pF | GRM1555C1H5R1BA01# |
| | | | | ±0.25pF | GRM1555C1H5R1CA01# |
| | | | | ±0.5pF | GRM1555C1H5R1DA01# |
| | | | | ±0.05pF | GRM1555C1H5R2WA01# |
| | | | 5.2pF | ±0.1pF | GRM1555C1H5R2BA01# |
| | | | | ±0.25pF | GRM1555C1H5R2CA01# |
| | | | | ±0.5pF | GRM1555C1H5R2DA01# |
| | | | | ±0.05pF | GRM1555C1H5R3WA01# |
| | | | 5.3pF | ±0.1pF | GRM1555C1H5R3BA01# |
| | | | | ±0.25pF | GRM1555C1H5R3CA01# |
| | | | | ±0.5pF | GRM1555C1H5R3DA01# |
| | | | | ±0.05pF | GRM1555C1H5R4WA01# |
| | | | 5.4pF | ±0.1pF | GRM1555C1H5R4BA01# |
| | | | | ±0.25pF | GRM1555C1H5R4CA01# |
| | | | | ±0.5pF | GRM1555C1H5R4DA01# |
| | | | | ±0.05pF | GRM1555C1H5R5WA01# |
| | | | 5.5pF | ±0.1pF | GRM1555C1H5R5BA01# |
| | | | | ±0.25pF | GRM1555C1H5R5CA01# |

| T max. | Rated Voltage | TC Code | Cap. | Tol. | Part Number |
|--------|---------------|---------|-------|---------|--------------------|
| 0.55mm | 50Vdc | COG | 5.5pF | ±0.5pF | GRM1555C1H5R5DA01# |
| | | | | ±0.05pF | GRM1555C1H5R6WA01# |
| | | | 5.6pF | ±0.1pF | GRM1555C1H5R6BA01# |
| | | | | ±0.25pF | GRM1555C1H5R6CA01# |
| | | | | ±0.5pF | GRM1555C1H5R6DA01# |
| | | | | ±0.05pF | GRM1555C1H5R7WA01# |
| | | | 5.7pF | ±0.1pF | GRM1555C1H5R7BA01# |
| | | | | ±0.25pF | GRM1555C1H5R7CA01# |
| | | | | ±0.5pF | GRM1555C1H5R7DA01# |
| | | | 5.8pF | ±0.05pF | GRM1555C1H5R8WA01# |
| | | | | ±0.1pF | GRM1555C1H5R8BA01# |
| | | | | ±0.25pF | GRM1555C1H5R8CA01# |
| | | | 5.9pF | ±0.5pF | GRM1555C1H5R8DA01# |
| | | | | ±0.05pF | GRM1555C1H5R9WA01# |
| | | | | ±0.1pF | GRM1555C1H5R9BA01# |
| | | | 6.0pF | ±0.25pF | GRM1555C1H5R9CA01# |
| | | | | ±0.5pF | GRM1555C1H5R9DA01# |
| | | | | ±0.05pF | GRM1555C1H6R0WA01# |
| | | | | ±0.1pF | GRM1555C1H6R0BA01# |
| | | | 6.1pF | ±0.25pF | GRM1555C1H6R0CA01# |
| | | | | ±0.5pF | GRM1555C1H6R0DA01# |
| | | | | ±0.05pF | GRM1555C1H6R1WA01# |
| | | | | ±0.1pF | GRM1555C1H6R1BA01# |
| | | | 6.2pF | ±0.25pF | GRM1555C1H6R1CA01# |
| | | | | ±0.5pF | GRM1555C1H6R1DA01# |
| | | | | ±0.05pF | GRM1555C1H6R2WA01# |
| | | | 6.3pF | ±0.1pF | GRM1555C1H6R2BA01# |
| | | | | ±0.25pF | GRM1555C1H6R2CA01# |
| | | | | ±0.5pF | GRM1555C1H6R2DA01# |
| | | | | ±0.05pF | GRM1555C1H6R3WA01# |
| | | | 6.4pF | ±0.1pF | GRM1555C1H6R3BA01# |
| | | | | ±0.25pF | GRM1555C1H6R3CA01# |
| | | | | ±0.5pF | GRM1555C1H6R3DA01# |
| | | | | ±0.05pF | GRM1555C1H6R4WA01# |
| | | | 6.5pF | ±0.1pF | GRM1555C1H6R4BA01# |
| | | | | ±0.25pF | GRM1555C1H6R4CA01# |
| | | | | ±0.5pF | GRM1555C1H6R4DA01# |
| | | | | ±0.05pF | GRM1555C1H6R5WA01# |
| | | | 6.6pF | ±0.1pF | GRM1555C1H6R5BA01# |
| | | | | ±0.25pF | GRM1555C1H6R5CA01# |
| | | | | ±0.5pF | GRM1555C1H6R5DA01# |
| | | | 6.7pF | ±0.05pF | GRM1555C1H6R6WA01# |
| | | | | ±0.1pF | GRM1555C1H6R6BA01# |
| | | | | ±0.25pF | GRM1555C1H6R6CA01# |
| | | | 6.8pF | ±0.5pF | GRM1555C1H6R6DA01# |
| | | | | ±0.05pF | GRM1555C1H6R7WA01# |
| | | | | ±0.1pF | GRM1555C1H6R7BA01# |
| | | | 6.9pF | ±0.25pF | GRM1555C1H6R7CA01# |
| | | | | ±0.5pF | GRM1555C1H6R7DA01# |
| | | | | ±0.05pF | GRM1555C1H6R8WA01# |
| | | | 7.0pF | ±0.1pF | GRM1555C1H6R8BA01# |
| | | | | ±0.25pF | GRM1555C1H6R8CA01# |
| | | | | ±0.5pF | GRM1555C1H6R8DA01# |
| | | | 7.1pF | ±0.05pF | GRM1555C1H6R9WA01# |

Part number # indicates the package specification code.

GRM Series Temperature Compensating Type Part Number List

(→ 1.0×0.5mm)

| T max. | Rated Voltage | TC Code | Cap. | Tol. | Part Number | T max. | Rated Voltage | TC Code | Cap. | Tol. | Part Number | |
|--------|---------------|---------|--------|--------------------|--------------------|--------|---------------|---------|---------|--------------------|--------------------|--------------------|
| 0.55mm | 50Vdc | COG | 6.9pF | ±0.1pF | GRM1555C1H6R9BA01# | 0.55mm | 50Vdc | COG | 8.2pF | ±0.5pF | GRM1555C1H8R2DA01# | |
| | | | | ±0.25pF | GRM1555C1H6R9CA01# | | | | | 8.3pF | ±0.05pF | GRM1555C1H8R3WA01# |
| | | | | ±0.5pF | GRM1555C1H6R9DA01# | | | | | | ±0.1pF | GRM1555C1H8R3BA01# |
| | | | 7.0pF | ±0.05pF | GRM1555C1H7R0WA01# | | | | ±0.25pF | | GRM1555C1H8R3CA01# | |
| | | | | ±0.1pF | GRM1555C1H7R0BA01# | | | | ±0.5pF | GRM1555C1H8R3DA01# | | |
| | | | | ±0.25pF | GRM1555C1H7R0CA01# | | | | 8.4pF | ±0.05pF | GRM1555C1H8R4WA01# | |
| | | | ±0.5pF | GRM1555C1H7R0DA01# | ±0.1pF | | | | | GRM1555C1H8R4BA01# | | |
| | | | 7.1pF | ±0.05pF | GRM1555C1H7R1WA01# | | | | | ±0.25pF | GRM1555C1H8R4CA01# | |
| | | | | ±0.1pF | GRM1555C1H7R1BA01# | | | | ±0.5pF | GRM1555C1H8R4DA01# | | |
| | | | | ±0.25pF | GRM1555C1H7R1CA01# | | | | 8.5pF | ±0.05pF | GRM1555C1H8R5WA01# | |
| | | | ±0.5pF | GRM1555C1H7R1DA01# | ±0.1pF | | | | | GRM1555C1H8R5BA01# | | |
| | | | 7.2pF | ±0.05pF | GRM1555C1H7R2WA01# | | | | | ±0.25pF | GRM1555C1H8R5CA01# | |
| | | | | ±0.1pF | GRM1555C1H7R2BA01# | | | | ±0.5pF | GRM1555C1H8R5DA01# | | |
| | | | | ±0.25pF | GRM1555C1H7R2CA01# | | | | 8.6pF | ±0.05pF | GRM1555C1H8R6WA01# | |
| | | | ±0.5pF | GRM1555C1H7R2DA01# | ±0.1pF | | | | | GRM1555C1H8R6BA01# | | |
| | | | 7.3pF | ±0.05pF | GRM1555C1H7R3WA01# | | | | | ±0.25pF | GRM1555C1H8R6CA01# | |
| | | | | ±0.1pF | GRM1555C1H7R3BA01# | | | | ±0.5pF | GRM1555C1H8R6DA01# | | |
| | | | | ±0.25pF | GRM1555C1H7R3CA01# | | | | 8.7pF | ±0.05pF | GRM1555C1H8R7WA01# | |
| | | | ±0.5pF | GRM1555C1H7R3DA01# | ±0.1pF | | | | | GRM1555C1H8R7BA01# | | |
| | | | 7.4pF | ±0.05pF | GRM1555C1H7R4WA01# | | | | | ±0.25pF | GRM1555C1H8R7CA01# | |
| | | | | ±0.1pF | GRM1555C1H7R4BA01# | | | | ±0.5pF | GRM1555C1H8R7DA01# | | |
| | | | | ±0.25pF | GRM1555C1H7R4CA01# | | | | 8.8pF | ±0.05pF | GRM1555C1H8R8WA01# | |
| | | | ±0.5pF | GRM1555C1H7R4DA01# | ±0.1pF | | | | | GRM1555C1H8R8BA01# | | |
| | | | 7.5pF | ±0.05pF | GRM1555C1H7R5WA01# | | | | | ±0.25pF | GRM1555C1H8R8CA01# | |
| | | | | ±0.1pF | GRM1555C1H7R5BA01# | | | | ±0.5pF | GRM1555C1H8R8DA01# | | |
| | | | | ±0.25pF | GRM1555C1H7R5CA01# | | | | 8.9pF | ±0.05pF | GRM1555C1H8R9WA01# | |
| | | | ±0.5pF | GRM1555C1H7R5DA01# | ±0.1pF | | | | | GRM1555C1H8R9BA01# | | |
| | | | 7.6pF | ±0.05pF | GRM1555C1H7R6WA01# | | | | | ±0.25pF | GRM1555C1H8R9CA01# | |
| | | | | ±0.1pF | GRM1555C1H7R6BA01# | | | | ±0.5pF | GRM1555C1H8R9DA01# | | |
| | | | | ±0.25pF | GRM1555C1H7R6CA01# | | | | 9.0pF | ±0.05pF | GRM1555C1H9R0WA01# | |
| | | | ±0.5pF | GRM1555C1H7R6DA01# | ±0.1pF | | | | | GRM1555C1H9R0BA01# | | |
| | | | 7.7pF | ±0.05pF | GRM1555C1H7R7WA01# | | | | | ±0.25pF | GRM1555C1H9R0CA01# | |
| | | | | ±0.1pF | GRM1555C1H7R7BA01# | | | | ±0.5pF | GRM1555C1H9R0DA01# | | |
| | | | | ±0.25pF | GRM1555C1H7R7CA01# | | | | 9.1pF | ±0.05pF | GRM1555C1H9R1WA01# | |
| | | | ±0.5pF | GRM1555C1H7R7DA01# | ±0.1pF | | | | | GRM1555C1H9R1BA01# | | |
| | | | 7.8pF | ±0.05pF | GRM1555C1H7R8WA01# | | | | | ±0.25pF | GRM1555C1H9R1CA01# | |
| | | | | ±0.1pF | GRM1555C1H7R8BA01# | | | | ±0.5pF | GRM1555C1H9R1DA01# | | |
| | | | | ±0.25pF | GRM1555C1H7R8CA01# | | | | 9.2pF | ±0.05pF | GRM1555C1H9R2WA01# | |
| | | | ±0.5pF | GRM1555C1H7R8DA01# | ±0.1pF | | | | | GRM1555C1H9R2BA01# | | |
| | | | 7.9pF | ±0.05pF | GRM1555C1H7R9WA01# | | | | | ±0.25pF | GRM1555C1H9R2CA01# | |
| | | | | ±0.1pF | GRM1555C1H7R9BA01# | | | | ±0.5pF | GRM1555C1H9R2DA01# | | |
| | | | | ±0.25pF | GRM1555C1H7R9CA01# | | | | 9.3pF | ±0.05pF | GRM1555C1H9R3WA01# | |
| | | | ±0.5pF | GRM1555C1H7R9DA01# | ±0.1pF | | | | | GRM1555C1H9R3BA01# | | |
| | | | 8.0pF | ±0.05pF | GRM1555C1H8R0WA01# | | | | | ±0.25pF | GRM1555C1H9R3CA01# | |
| | | | | ±0.1pF | GRM1555C1H8R0BA01# | | | | ±0.5pF | GRM1555C1H9R3DA01# | | |
| | | | | ±0.25pF | GRM1555C1H8R0CA01# | | | | 9.4pF | ±0.05pF | GRM1555C1H9R4WA01# | |
| | | | ±0.5pF | GRM1555C1H8R0DA01# | ±0.1pF | | | | | GRM1555C1H9R4BA01# | | |
| | | | 8.1pF | ±0.05pF | GRM1555C1H8R1WA01# | | | | | ±0.25pF | GRM1555C1H9R4CA01# | |
| | | | | ±0.1pF | GRM1555C1H8R1BA01# | | | | ±0.5pF | GRM1555C1H9R4DA01# | | |
| | | | | ±0.25pF | GRM1555C1H8R1CA01# | | | | 9.5pF | ±0.05pF | GRM1555C1H9R5WA01# | |
| | | | ±0.5pF | GRM1555C1H8R1DA01# | ±0.1pF | | | | | GRM1555C1H9R5BA01# | | |
| | | | 8.2pF | ±0.05pF | GRM1555C1H8R2WA01# | | | | | ±0.25pF | GRM1555C1H9R5CA01# | |
| | | | | ±0.1pF | GRM1555C1H8R2BA01# | | | | ±0.5pF | GRM1555C1H9R5DA01# | | |
| | | | | ±0.25pF | GRM1555C1H8R2CA01# | | | | 9.6pF | ±0.05pF | GRM1555C1H9R6WA01# | |

- GRM
- GR3
- GRJ
- GR4
- GR7
- GJM
- GQM
- GA2
- GA3 GB
- GA3 GD
- GA3 GF
- LLL
- LLA
- LLM
- LLR
- NFM
- KRM
- KR3
- GMA
- GMD
- ⚠Caution /Notice

Part number # indicates the package specification code.

GRM Series Temperature Compensating Type Part Number List

(→ 1.0×0.5mm)

| T max. | Rated Voltage | TC Code | Cap. | Tol. | Part Number |
|--------|---------------|---------|-------|---------|--------------------|
| 0.55mm | 50Vdc | COG | 9.6pF | ±0.1pF | GRM1555C1H9R6BA01# |
| | | | | ±0.25pF | GRM1555C1H9R6CA01# |
| | | | | ±0.5pF | GRM1555C1H9R6DA01# |
| | | | 9.7pF | ±0.05pF | GRM1555C1H9R7WA01# |
| | | | | ±0.1pF | GRM1555C1H9R7BA01# |
| | | | | ±0.25pF | GRM1555C1H9R7CA01# |
| | | | | ±0.5pF | GRM1555C1H9R7DA01# |
| | | | 9.8pF | ±0.05pF | GRM1555C1H9R8WA01# |
| | | | | ±0.1pF | GRM1555C1H9R8BA01# |
| | | | | ±0.25pF | GRM1555C1H9R8CA01# |
| | | | | ±0.5pF | GRM1555C1H9R8DA01# |
| | | | 9.9pF | ±0.05pF | GRM1555C1H9R9WA01# |
| | | | | ±0.1pF | GRM1555C1H9R9BA01# |
| | | | | ±0.25pF | GRM1555C1H9R9CA01# |
| | | | | ±0.5pF | GRM1555C1H9R9DA01# |
| | | | 10pF | ±2% | GRM1555C1H100GA01# |
| | | | | ±5% | GRM1555C1H100JA01# |
| | | | 12pF | ±2% | GRM1555C1H120GA01# |
| | | | | ±5% | GRM1555C1H120JA01# |
| | | | 15pF | ±2% | GRM1555C1H150GA01# |
| | | | | ±5% | GRM1555C1H150JA01# |
| | | | 18pF | ±2% | GRM1555C1H180GA01# |
| | | | | ±5% | GRM1555C1H180JA01# |
| | | | 22pF | ±2% | GRM1555C1H220GA01# |
| | | | | ±5% | GRM1555C1H220JA01# |
| | | | 27pF | ±2% | GRM1555C1H270GA01# |
| | | | | ±5% | GRM1555C1H270JA01# |
| | | | 33pF | ±2% | GRM1555C1H330GA01# |
| | | | | ±5% | GRM1555C1H330JA01# |
| | | | 39pF | ±2% | GRM1555C1H390GA01# |
| | | | | ±5% | GRM1555C1H390JA01# |
| | | | 47pF | ±2% | GRM1555C1H470GA01# |
| | | | | ±5% | GRM1555C1H470JA01# |
| | | | 56pF | ±2% | GRM1555C1H560GA01# |
| | | | | ±5% | GRM1555C1H560JA01# |
| | | | 68pF | ±2% | GRM1555C1H680GA01# |
| | | | | ±5% | GRM1555C1H680JA01# |
| | | | 82pF | ±2% | GRM1555C1H820GA01# |
| | | | | ±5% | GRM1555C1H820JA01# |
| | | | 100pF | ±2% | GRM1555C1H101GA01# |
| | | | | ±5% | GRM1555C1H101JA01# |
| | | | 120pF | ±2% | GRM1555C1H121GA01# |
| | | | | ±5% | GRM1555C1H121JA01# |
| | | | 150pF | ±2% | GRM1555C1H151GA01# |
| | | | | ±5% | GRM1555C1H151JA01# |
| | | | 180pF | ±2% | GRM1555C1H181GA01# |
| | | | | ±5% | GRM1555C1H181JA01# |
| | | | 220pF | ±2% | GRM1555C1H221GA01# |
| | | | | ±5% | GRM1555C1H221JA01# |
| | | | 270pF | ±2% | GRM1555C1H271GA01# |
| | | | | ±5% | GRM1555C1H271JA01# |
| | | | 330pF | ±2% | GRM1555C1H331GA01# |
| | | | | ±5% | GRM1555C1H331JA01# |
| | | | 390pF | ±2% | GRM1555C1H391GA01# |

| T max. | Rated Voltage | TC Code | Cap. | Tol. | Part Number | |
|--------|---------------|---------|---------|--------------------|--------------------|--------------------|
| 0.55mm | 50Vdc | COG | 390pF | ±5% | GRM1555C1H391JA01# | |
| | | | | ±2% | GRM1555C1H471GA01# | |
| | | | 470pF | ±5% | GRM1555C1H471JA01# | |
| | | | | ±2% | GRM1555C1H561GA01# | |
| | | | 560pF | ±5% | GRM1555C1H561JA01# | |
| | | | | ±2% | GRM1555C1H681GA01# | |
| | | | 680pF | ±5% | GRM1555C1H681JA01# | |
| | | | | ±2% | GRM1555C1H821GA01# | |
| | | | 820pF | ±5% | GRM1555C1H821JA01# | |
| | | | | ±2% | GRM1555C1H102GA01# | |
| | | | 1000pF | ±5% | GRM1555C1H102JA01# | |
| | | | | CK | ±0.05pF | GRM1554C1HR10WA01# |
| | | | 0.20pF | | ±0.05pF | GRM1554C1HR20WA01# |
| | | | | | ±0.1pF | GRM1554C1HR20BA01# |
| | | | 0.30pF | | ±0.05pF | GRM1554C1HR30WA01# |
| | | | | | ±0.1pF | GRM1554C1HR30BA01# |
| | | | 0.40pF | | ±0.05pF | GRM1554C1HR40WA01# |
| | | | | | ±0.1pF | GRM1554C1HR40BA01# |
| | | | 0.50pF | | ±0.05pF | GRM1554C1HR50WA01# |
| | | | | | ±0.1pF | GRM1554C1HR50BA01# |
| | | | 0.60pF | | ±0.05pF | GRM1554C1HR60WA01# |
| | | | | | ±0.1pF | GRM1554C1HR60BA01# |
| | | | 0.70pF | | ±0.05pF | GRM1554C1HR70WA01# |
| | | | | | ±0.1pF | GRM1554C1HR70BA01# |
| | | | 0.80pF | | ±0.05pF | GRM1554C1HR80WA01# |
| | | | | | ±0.1pF | GRM1554C1HR80BA01# |
| | | | 0.90pF | | ±0.05pF | GRM1554C1HR90WA01# |
| | | ±0.1pF | | | GRM1554C1HR90BA01# | |
| | | 1.0pF | ±0.05pF | | GRM1554C1H1R0WA01# | |
| | | | ±0.1pF | | GRM1554C1H1R0BA01# | |
| | | | ±0.25pF | | GRM1554C1H1R0CA01# | |
| | | 1.1pF | ±0.05pF | | GRM1554C1H1R1WA01# | |
| | | | ±0.1pF | | GRM1554C1H1R1BA01# | |
| | | | ±0.25pF | | GRM1554C1H1R1CA01# | |
| | | 1.2pF | ±0.05pF | | GRM1554C1H1R2WA01# | |
| | | | ±0.1pF | | GRM1554C1H1R2BA01# | |
| | | | ±0.25pF | | GRM1554C1H1R2CA01# | |
| | | 1.3pF | ±0.05pF | | GRM1554C1H1R3WA01# | |
| | | | ±0.1pF | GRM1554C1H1R3BA01# | | |
| | | | ±0.25pF | GRM1554C1H1R3CA01# | | |
| | | 1.4pF | ±0.05pF | GRM1554C1H1R4WA01# | | |
| | | | ±0.1pF | GRM1554C1H1R4BA01# | | |
| | | | ±0.25pF | GRM1554C1H1R4CA01# | | |
| | | 1.5pF | ±0.05pF | GRM1554C1H1R5WA01# | | |
| | | | ±0.1pF | GRM1554C1H1R5BA01# | | |
| | | | ±0.25pF | GRM1554C1H1R5CA01# | | |
| | | 1.6pF | ±0.05pF | GRM1554C1H1R6WA01# | | |
| | | | ±0.1pF | GRM1554C1H1R6BA01# | | |
| | | | ±0.25pF | GRM1554C1H1R6CA01# | | |
| | | 1.7pF | ±0.05pF | GRM1554C1H1R7WA01# | | |
| | | | ±0.1pF | GRM1554C1H1R7BA01# | | |
| | | | ±0.25pF | GRM1554C1H1R7CA01# | | |
| | | 1.8pF | ±0.05pF | GRM1554C1H1R8WA01# | | |
| | | | ±0.1pF | GRM1554C1H1R8BA01# | | |

Part number # indicates the package specification code.

GRM Series Temperature Compensating Type Part Number List

(→ 1.0×0.5mm)

| T max. | Rated Voltage | TC Code | Cap. | Tol. | Part Number | T max. | Rated Voltage | TC Code | Cap. | Tol. | Part Number | | |
|--------|---------------|---------|---------|--------------------|--------------------|--------------------|--------------------|---------|--------------------|---------|--------------------|--------------------|--------------------|
| 0.55mm | 50Vdc | CK | 1.8pF | ±0.25pF | GRM1554C1H1R8CA01# | 0.55mm | 50Vdc | CJ | 3.6pF | ±0.25pF | GRM1553C1H3R6CA01# | | |
| | | | | ±0.05pF | GRM1554C1H1R9WA01# | | | | | 3.7pF | ±0.05pF | GRM1553C1H3R7WA01# | |
| | | | | | ±0.1pF | | | | | | GRM1554C1H1R9BA01# | ±0.1pF | GRM1553C1H3R7BA01# |
| | | | ±0.25pF | | GRM1554C1H1R9CA01# | | | | ±0.25pF | | GRM1553C1H3R7CA01# | | |
| | | | 2.0pF | ±0.05pF | GRM1554C1H2R0WA01# | | | | 3.8pF | ±0.05pF | GRM1553C1H3R8WA01# | | |
| | | | | ±0.1pF | GRM1554C1H2R0BA01# | | | | | ±0.1pF | GRM1553C1H3R8BA01# | | |
| | | | | ±0.25pF | GRM1554C1H2R0CA01# | | | | | ±0.25pF | GRM1553C1H3R8CA01# | | |
| | | | CJ | 2.1pF | ±0.05pF | | | | GRM1553C1H2R1WA01# | CH | 4.0pF | ±0.05pF | GRM1552C1H4R0WA01# |
| | | | | | ±0.1pF | | | | GRM1553C1H2R1BA01# | | | ±0.1pF | GRM1552C1H4R0BA01# |
| | | | | | ±0.25pF | | | | GRM1553C1H2R1CA01# | | | ±0.25pF | GRM1552C1H4R0CA01# |
| | | | | 2.2pF | ±0.05pF | | | | GRM1553C1H2R2WA01# | | 4.1pF | ±0.05pF | GRM1552C1H4R1WA01# |
| | | | | | ±0.1pF | | | | GRM1553C1H2R2BA01# | | | ±0.1pF | GRM1552C1H4R1BA01# |
| | | | | | ±0.25pF | | | | GRM1553C1H2R2CA01# | | | ±0.25pF | GRM1552C1H4R1CA01# |
| | | | | 2.3pF | ±0.05pF | | | | GRM1553C1H2R3WA01# | | 4.2pF | ±0.05pF | GRM1552C1H4R2WA01# |
| | | | | | ±0.1pF | | | | GRM1553C1H2R3BA01# | | | ±0.1pF | GRM1552C1H4R2BA01# |
| | | | | | ±0.25pF | | | | GRM1553C1H2R3CA01# | | | ±0.25pF | GRM1552C1H4R2CA01# |
| | | | 2.4pF | ±0.05pF | GRM1553C1H2R4WA01# | | | | 4.3pF | ±0.05pF | GRM1552C1H4R3WA01# | | |
| | | | | ±0.1pF | GRM1553C1H2R4BA01# | | | | | ±0.1pF | GRM1552C1H4R3BA01# | | |
| | | ±0.25pF | | GRM1553C1H2R4CA01# | ±0.25pF | GRM1552C1H4R3CA01# | | | | | | | |
| | | 2.5pF | ±0.05pF | GRM1553C1H2R5WA01# | 4.4pF | ±0.05pF | GRM1552C1H4R4WA01# | | | | | | |
| | | | ±0.1pF | GRM1553C1H2R5BA01# | | ±0.1pF | GRM1552C1H4R4BA01# | | | | | | |
| | | | ±0.25pF | GRM1553C1H2R5CA01# | | ±0.25pF | GRM1552C1H4R4CA01# | | | | | | |
| | | 2.6pF | ±0.05pF | GRM1553C1H2R6WA01# | 4.5pF | ±0.05pF | GRM1552C1H4R5WA01# | | | | | | |
| | | | ±0.1pF | GRM1553C1H2R6BA01# | | ±0.1pF | GRM1552C1H4R5BA01# | | | | | | |
| | | | ±0.25pF | GRM1553C1H2R6CA01# | | ±0.25pF | GRM1552C1H4R5CA01# | | | | | | |
| | | 2.7pF | ±0.05pF | GRM1553C1H2R7WA01# | 4.6pF | ±0.05pF | GRM1552C1H4R6WA01# | | | | | | |
| | | | ±0.1pF | GRM1553C1H2R7BA01# | | ±0.1pF | GRM1552C1H4R6BA01# | | | | | | |
| | | | ±0.25pF | GRM1553C1H2R7CA01# | | ±0.25pF | GRM1552C1H4R6CA01# | | | | | | |
| | | 2.8pF | ±0.05pF | GRM1553C1H2R8WA01# | 4.7pF | ±0.05pF | GRM1552C1H4R7WA01# | | | | | | |
| | | | ±0.1pF | GRM1553C1H2R8BA01# | | ±0.1pF | GRM1552C1H4R7BA01# | | | | | | |
| | | | ±0.25pF | GRM1553C1H2R8CA01# | | ±0.25pF | GRM1552C1H4R7CA01# | | | | | | |
| | | 2.9pF | ±0.05pF | GRM1553C1H2R9WA01# | 4.8pF | ±0.05pF | GRM1552C1H4R8WA01# | | | | | | |
| | | | ±0.1pF | GRM1553C1H2R9BA01# | | ±0.1pF | GRM1552C1H4R8BA01# | | | | | | |
| | | | ±0.25pF | GRM1553C1H2R9CA01# | | ±0.25pF | GRM1552C1H4R8CA01# | | | | | | |
| | | 3.0pF | ±0.05pF | GRM1553C1H3R0WA01# | 4.9pF | ±0.05pF | GRM1552C1H4R9WA01# | | | | | | |
| | | | ±0.1pF | GRM1553C1H3R0BA01# | | ±0.1pF | GRM1552C1H4R9BA01# | | | | | | |
| | | | ±0.25pF | GRM1553C1H3R0CA01# | | ±0.25pF | GRM1552C1H4R9CA01# | | | | | | |
| | | 3.1pF | ±0.05pF | GRM1553C1H3R1WA01# | 5.0pF | ±0.05pF | GRM1552C1H5R0WA01# | | | | | | |
| | | | ±0.1pF | GRM1553C1H3R1BA01# | | ±0.1pF | GRM1552C1H5R0BA01# | | | | | | |
| | | | ±0.25pF | GRM1553C1H3R1CA01# | | ±0.25pF | GRM1552C1H5R0CA01# | | | | | | |
| | | 3.2pF | ±0.05pF | GRM1553C1H3R2WA01# | 5.1pF | ±0.05pF | GRM1552C1H5R1WA01# | | | | | | |
| | | | ±0.1pF | GRM1553C1H3R2BA01# | | ±0.1pF | GRM1552C1H5R1BA01# | | | | | | |
| | | | ±0.25pF | GRM1553C1H3R2CA01# | | ±0.25pF | GRM1552C1H5R1CA01# | | | | | | |
| | | 3.3pF | ±0.05pF | GRM1553C1H3R3WA01# | 5.2pF | ±0.05pF | GRM1552C1H5R2WA01# | | | | | | |
| | | | ±0.1pF | GRM1553C1H3R3BA01# | | ±0.1pF | GRM1552C1H5R2BA01# | | | | | | |
| | | | ±0.25pF | GRM1553C1H3R3CA01# | | ±0.25pF | GRM1552C1H5R2CA01# | | | | | | |
| | | 3.4pF | ±0.05pF | GRM1553C1H3R4WA01# | 5.3pF | ±0.05pF | GRM1552C1H5R3WA01# | | | | | | |
| | | | ±0.1pF | GRM1553C1H3R4BA01# | | ±0.1pF | GRM1552C1H5R3BA01# | | | | | | |
| | | | ±0.25pF | GRM1553C1H3R4CA01# | | ±0.25pF | GRM1552C1H5R3CA01# | | | | | | |
| | | 3.5pF | ±0.05pF | GRM1553C1H3R5WA01# | | | | | | | | | |
| | | | ±0.1pF | GRM1553C1H3R5BA01# | | | | | | | | | |
| | | | ±0.25pF | GRM1553C1H3R5CA01# | | | | | | | | | |
| | | 3.6pF | ±0.05pF | GRM1553C1H3R6WA01# | | | | | | | | | |
| | | | ±0.1pF | GRM1553C1H3R6BA01# | | | | | | | | | |

- GRM
- GR3
- GRJ
- GR4
- GR7
- GJM
- GJM
- GQM
- GA2
- GA3 GB
- GA3 GD
- GA3 GF
- LLL
- LLA
- LLM
- LLR
- NFM
- KRM
- KR3
- GMA
- GMD
- ⚠Caution /Notice

Part number # indicates the package specification code.

GRM Series Temperature Compensating Type Part Number List

(→ 1.0×0.5mm)

| T max. | Rated Voltage | TC Code | Cap. | Tol. | Part Number |
|--------|---------------|---------|---------|---------|--------------------|
| 0.55mm | 50Vdc | CH | 5.3pF | ±0.5pF | GRM1552C1H5R3DA01# |
| | | | | ±0.05pF | GRM1552C1H5R4WA01# |
| | | | | | ±0.1pF |
| | | | ±0.25pF | | GRM1552C1H5R4CA01# |
| | | | 5.4pF | ±0.5pF | GRM1552C1H5R4DA01# |
| | | | | ±0.05pF | GRM1552C1H5R5WA01# |
| | | | | ±0.1pF | GRM1552C1H5R5BA01# |
| | | | 5.5pF | ±0.25pF | GRM1552C1H5R5CA01# |
| | | | | ±0.5pF | GRM1552C1H5R5DA01# |
| | | | | ±0.05pF | GRM1552C1H5R6WA01# |
| | | | 5.6pF | ±0.1pF | GRM1552C1H5R6BA01# |
| | | | | ±0.25pF | GRM1552C1H5R6CA01# |
| | | | | ±0.5pF | GRM1552C1H5R6DA01# |
| | | | 5.7pF | ±0.05pF | GRM1552C1H5R7WA01# |
| | | | | ±0.1pF | GRM1552C1H5R7BA01# |
| | | | | ±0.25pF | GRM1552C1H5R7CA01# |
| | | | 5.8pF | ±0.5pF | GRM1552C1H5R7DA01# |
| | | | | ±0.05pF | GRM1552C1H5R8WA01# |
| | | | | ±0.1pF | GRM1552C1H5R8BA01# |
| | | | 5.9pF | ±0.25pF | GRM1552C1H5R8CA01# |
| | | | | ±0.5pF | GRM1552C1H5R8DA01# |
| | | | | ±0.05pF | GRM1552C1H5R9WA01# |
| | | | 6.0pF | ±0.1pF | GRM1552C1H5R9BA01# |
| | | | | ±0.25pF | GRM1552C1H5R9CA01# |
| | | | | ±0.5pF | GRM1552C1H5R9DA01# |
| | | | 6.1pF | ±0.05pF | GRM1552C1H6R0WA01# |
| | | | | ±0.1pF | GRM1552C1H6R0BA01# |
| | | | | ±0.25pF | GRM1552C1H6R0CA01# |
| | | | 6.2pF | ±0.5pF | GRM1552C1H6R0DA01# |
| | | | | ±0.05pF | GRM1552C1H6R1WA01# |
| | | | | ±0.1pF | GRM1552C1H6R1BA01# |
| | | | 6.3pF | ±0.25pF | GRM1552C1H6R1CA01# |
| | | | | ±0.5pF | GRM1552C1H6R1DA01# |
| | | | | ±0.05pF | GRM1552C1H6R2WA01# |
| | | | 6.4pF | ±0.1pF | GRM1552C1H6R2BA01# |
| | | | | ±0.25pF | GRM1552C1H6R2CA01# |
| | | | | ±0.5pF | GRM1552C1H6R2DA01# |
| | | | 6.5pF | ±0.05pF | GRM1552C1H6R3WA01# |
| | | | | ±0.1pF | GRM1552C1H6R3BA01# |
| | | | | ±0.25pF | GRM1552C1H6R3CA01# |
| | | | 6.6pF | ±0.5pF | GRM1552C1H6R3DA01# |
| | | | | ±0.05pF | GRM1552C1H6R4WA01# |
| | | | | ±0.1pF | GRM1552C1H6R4BA01# |
| | | | 6.7pF | ±0.25pF | GRM1552C1H6R4CA01# |
| | | | | ±0.5pF | GRM1552C1H6R4DA01# |
| | | | | ±0.05pF | GRM1552C1H6R5WA01# |
| | | | 6.8pF | ±0.1pF | GRM1552C1H6R5BA01# |
| | | | | ±0.25pF | GRM1552C1H6R5CA01# |
| | | | | ±0.5pF | GRM1552C1H6R5DA01# |
| | | | 6.9pF | ±0.05pF | GRM1552C1H6R6WA01# |
| | | | | ±0.1pF | GRM1552C1H6R6BA01# |
| | | | | ±0.25pF | GRM1552C1H6R6CA01# |
| | | | 7.0pF | ±0.5pF | GRM1552C1H6R6DA01# |
| | | | | ±0.05pF | GRM1552C1H6R7WA01# |
| | | | | ±0.1pF | GRM1552C1H6R7BA01# |
| | | | 7.1pF | ±0.25pF | GRM1552C1H6R7CA01# |
| | | | | ±0.5pF | GRM1552C1H6R7DA01# |
| | | | | ±0.05pF | GRM1552C1H6R8WA01# |
| | | | 7.2pF | ±0.1pF | GRM1552C1H6R8BA01# |
| | | | | ±0.25pF | GRM1552C1H6R8CA01# |
| | | | | ±0.5pF | GRM1552C1H6R8DA01# |
| | | | 7.3pF | ±0.05pF | GRM1552C1H6R9WA01# |
| | | | | ±0.1pF | GRM1552C1H6R9BA01# |
| | | | | ±0.25pF | GRM1552C1H6R9CA01# |
| | | | 7.4pF | ±0.5pF | GRM1552C1H6R9DA01# |
| | | | | ±0.05pF | GRM1552C1H7R0WA01# |
| | | | | ±0.1pF | GRM1552C1H7R0BA01# |
| | | | 7.5pF | ±0.25pF | GRM1552C1H7R0CA01# |
| | | | | ±0.5pF | GRM1552C1H7R0DA01# |
| | | | | ±0.05pF | GRM1552C1H7R1WA01# |
| | | | 7.6pF | ±0.1pF | GRM1552C1H7R1BA01# |
| | | | | ±0.25pF | GRM1552C1H7R1CA01# |
| | | | | ±0.5pF | GRM1552C1H7R1DA01# |
| | | | 7.7pF | ±0.05pF | GRM1552C1H7R2WA01# |
| | | | | ±0.1pF | GRM1552C1H7R2BA01# |
| | | | | ±0.25pF | GRM1552C1H7R2CA01# |
| | | | 7.8pF | ±0.5pF | GRM1552C1H7R2DA01# |
| | | | | ±0.05pF | GRM1552C1H7R3WA01# |
| | | | | ±0.1pF | GRM1552C1H7R3BA01# |
| | | | 7.9pF | ±0.25pF | GRM1552C1H7R3CA01# |
| | | | | ±0.5pF | GRM1552C1H7R3DA01# |
| | | | | ±0.05pF | GRM1552C1H7R4WA01# |
| | | | 8.0pF | ±0.1pF | GRM1552C1H7R4BA01# |
| | | | | ±0.25pF | GRM1552C1H7R4CA01# |
| | | | | ±0.5pF | GRM1552C1H7R4DA01# |

| T max. | Rated Voltage | TC Code | Cap. | Tol. | Part Number |
|--------|---------------|---------|-------|---------|--------------------|
| 0.55mm | 50Vdc | CH | 6.7pF | ±0.1pF | GRM1552C1H6R7BA01# |
| | | | | ±0.25pF | GRM1552C1H6R7CA01# |
| | | | | ±0.5pF | GRM1552C1H6R7DA01# |
| | | | 6.8pF | ±0.05pF | GRM1552C1H6R8WA01# |
| | | | | ±0.1pF | GRM1552C1H6R8BA01# |
| | | | | ±0.25pF | GRM1552C1H6R8CA01# |
| | | | 6.9pF | ±0.5pF | GRM1552C1H6R8DA01# |
| | | | | ±0.05pF | GRM1552C1H6R9WA01# |
| | | | | ±0.1pF | GRM1552C1H6R9BA01# |
| | | | 7.0pF | ±0.25pF | GRM1552C1H6R9CA01# |
| | | | | ±0.5pF | GRM1552C1H6R9DA01# |
| | | | | ±0.05pF | GRM1552C1H7R0WA01# |
| | | | 7.1pF | ±0.1pF | GRM1552C1H7R0BA01# |
| | | | | ±0.25pF | GRM1552C1H7R0CA01# |
| | | | | ±0.5pF | GRM1552C1H7R0DA01# |
| | | | 7.2pF | ±0.05pF | GRM1552C1H7R1WA01# |
| | | | | ±0.1pF | GRM1552C1H7R1BA01# |
| | | | | ±0.25pF | GRM1552C1H7R1CA01# |
| | | | 7.3pF | ±0.5pF | GRM1552C1H7R1DA01# |
| | | | | ±0.05pF | GRM1552C1H7R2WA01# |
| | | | | ±0.1pF | GRM1552C1H7R2BA01# |
| | | | 7.4pF | ±0.25pF | GRM1552C1H7R2CA01# |
| | | | | ±0.5pF | GRM1552C1H7R2DA01# |
| | | | | ±0.05pF | GRM1552C1H7R3WA01# |
| | | | 7.5pF | ±0.1pF | GRM1552C1H7R3BA01# |
| | | | | ±0.25pF | GRM1552C1H7R3CA01# |
| | | | | ±0.5pF | GRM1552C1H7R3DA01# |
| | | | 7.6pF | ±0.05pF | GRM1552C1H7R4WA01# |
| | | | | ±0.1pF | GRM1552C1H7R4BA01# |
| | | | | ±0.25pF | GRM1552C1H7R4CA01# |
| | | | 7.7pF | ±0.5pF | GRM1552C1H7R4DA01# |
| | | | | ±0.05pF | GRM1552C1H7R5WA01# |
| | | | | ±0.1pF | GRM1552C1H7R5BA01# |
| | | | 7.8pF | ±0.25pF | GRM1552C1H7R5CA01# |
| | | | | ±0.5pF | GRM1552C1H7R5DA01# |
| | | | | ±0.05pF | GRM1552C1H7R6WA01# |
| | | | 7.9pF | ±0.1pF | GRM1552C1H7R6BA01# |
| | | | | ±0.25pF | GRM1552C1H7R6CA01# |
| | | | | ±0.5pF | GRM1552C1H7R6DA01# |
| | | | 8.0pF | ±0.05pF | GRM1552C1H7R7WA01# |
| | | | | ±0.1pF | GRM1552C1H7R7BA01# |
| | | | | ±0.25pF | GRM1552C1H7R7CA01# |
| | | | 8.0pF | ±0.5pF | GRM1552C1H7R7DA01# |
| | | | | ±0.05pF | GRM1552C1H7R8WA01# |
| | | | | ±0.1pF | GRM1552C1H7R8BA01# |
| | | | 8.0pF | ±0.25pF | GRM1552C1H7R8CA01# |
| | | | | ±0.5pF | GRM1552C1H7R8DA01# |
| | | | | ±0.05pF | GRM1552C1H7R9WA01# |
| | | | 8.0pF | ±0.1pF | GRM1552C1H7R9BA01# |
| | | | | ±0.25pF | GRM1552C1H7R9CA01# |
| | | | | ±0.5pF | GRM1552C1H7R9DA01# |
| | | | 8.0pF | ±0.05pF | GRM1552C1H8R0WA01# |
| | | | | ±0.1pF | GRM1552C1H8R0BA01# |
| | | | | ±0.25pF | GRM1552C1H8R0CA01# |

Part number # indicates the package specification code.

GRM Series Temperature Compensating Type Part Number List

(→ 1.0×0.5mm)

| T max. | Rated Voltage | TC Code | Cap. | Tol. | Part Number |
|--------|---------------|---------|-------|---------|--------------------|
| 0.55mm | 50Vdc | CH | 8.0pF | ±0.5pF | GRM1552C1H8R0DA01# |
| | | | | ±0.05pF | GRM1552C1H8R1WA01# |
| | | | 8.1pF | ±0.1pF | GRM1552C1H8R1BA01# |
| | | | | ±0.25pF | GRM1552C1H8R1CA01# |
| | | | | ±0.5pF | GRM1552C1H8R1DA01# |
| | | | | ±0.05pF | GRM1552C1H8R2WA01# |
| | | | 8.2pF | ±0.1pF | GRM1552C1H8R2BA01# |
| | | | | ±0.25pF | GRM1552C1H8R2CA01# |
| | | | | ±0.5pF | GRM1552C1H8R2DA01# |
| | | | | ±0.05pF | GRM1552C1H8R3WA01# |
| | | | 8.3pF | ±0.1pF | GRM1552C1H8R3BA01# |
| | | | | ±0.25pF | GRM1552C1H8R3CA01# |
| | | | | ±0.5pF | GRM1552C1H8R3DA01# |
| | | | | ±0.05pF | GRM1552C1H8R4WA01# |
| | | | 8.4pF | ±0.1pF | GRM1552C1H8R4BA01# |
| | | | | ±0.25pF | GRM1552C1H8R4CA01# |
| | | | | ±0.5pF | GRM1552C1H8R4DA01# |
| | | | | ±0.05pF | GRM1552C1H8R5WA01# |
| | | | 8.5pF | ±0.1pF | GRM1552C1H8R5BA01# |
| | | | | ±0.25pF | GRM1552C1H8R5CA01# |
| | | | | ±0.5pF | GRM1552C1H8R5DA01# |
| | | | | ±0.05pF | GRM1552C1H8R6WA01# |
| | | | 8.6pF | ±0.1pF | GRM1552C1H8R6BA01# |
| | | | | ±0.25pF | GRM1552C1H8R6CA01# |
| | | | | ±0.5pF | GRM1552C1H8R6DA01# |
| | | | | ±0.05pF | GRM1552C1H8R7WA01# |
| | | | 8.7pF | ±0.1pF | GRM1552C1H8R7BA01# |
| | | | | ±0.25pF | GRM1552C1H8R7CA01# |
| | | | | ±0.5pF | GRM1552C1H8R7DA01# |
| | | | | ±0.05pF | GRM1552C1H8R8WA01# |
| | | | 8.8pF | ±0.1pF | GRM1552C1H8R8BA01# |
| | | | | ±0.25pF | GRM1552C1H8R8CA01# |
| | | | | ±0.5pF | GRM1552C1H8R8DA01# |
| | | | | ±0.05pF | GRM1552C1H8R9WA01# |
| | | | 8.9pF | ±0.1pF | GRM1552C1H8R9BA01# |
| | | | | ±0.25pF | GRM1552C1H8R9CA01# |
| | | | | ±0.5pF | GRM1552C1H8R9DA01# |
| | | | | ±0.05pF | GRM1552C1H9R0WA01# |
| | | | 9.0pF | ±0.1pF | GRM1552C1H9R0BA01# |
| | | | | ±0.25pF | GRM1552C1H9R0CA01# |
| | | | | ±0.5pF | GRM1552C1H9R0DA01# |
| | | | | ±0.05pF | GRM1552C1H9R1WA01# |
| | | | 9.1pF | ±0.1pF | GRM1552C1H9R1BA01# |
| | | | | ±0.25pF | GRM1552C1H9R1CA01# |
| | | | | ±0.5pF | GRM1552C1H9R1DA01# |
| | | | | ±0.05pF | GRM1552C1H9R2WA01# |
| | | | 9.2pF | ±0.1pF | GRM1552C1H9R2BA01# |
| | | | | ±0.25pF | GRM1552C1H9R2CA01# |
| | | | | ±0.5pF | GRM1552C1H9R2DA01# |
| | | | | ±0.05pF | GRM1552C1H9R3WA01# |
| | | | 9.3pF | ±0.1pF | GRM1552C1H9R3BA01# |
| | | | | ±0.25pF | GRM1552C1H9R3CA01# |
| | | | | ±0.5pF | GRM1552C1H9R3DA01# |
| | | | | ±0.05pF | GRM1552C1H9R4WA01# |

| T max. | Rated Voltage | TC Code | Cap. | Tol. | Part Number |
|--------|---------------|---------|-------|---------|--------------------|
| 0.55mm | 50Vdc | CH | 9.4pF | ±0.1pF | GRM1552C1H9R4BA01# |
| | | | | ±0.25pF | GRM1552C1H9R4CA01# |
| | | | | ±0.5pF | GRM1552C1H9R4DA01# |
| | | | 9.5pF | ±0.05pF | GRM1552C1H9R5WA01# |
| | | | | ±0.1pF | GRM1552C1H9R5BA01# |
| | | | | ±0.25pF | GRM1552C1H9R5CA01# |
| | | | 9.6pF | ±0.5pF | GRM1552C1H9R5DA01# |
| | | | | ±0.05pF | GRM1552C1H9R6WA01# |
| | | | | ±0.1pF | GRM1552C1H9R6BA01# |
| | | | 9.7pF | ±0.25pF | GRM1552C1H9R6CA01# |
| | | | | ±0.5pF | GRM1552C1H9R6DA01# |
| | | | | ±0.05pF | GRM1552C1H9R7WA01# |
| | | | 9.8pF | ±0.1pF | GRM1552C1H9R7BA01# |
| | | | | ±0.25pF | GRM1552C1H9R7CA01# |
| | | | | ±0.5pF | GRM1552C1H9R7DA01# |
| | | | 9.9pF | ±0.05pF | GRM1552C1H9R8WA01# |
| | | | | ±0.1pF | GRM1552C1H9R8BA01# |
| | | | | ±0.25pF | GRM1552C1H9R8CA01# |
| | | | 10pF | ±0.5pF | GRM1552C1H9R8DA01# |
| | | | | ±0.05pF | GRM1552C1H9R9WA01# |
| | | | | ±0.1pF | GRM1552C1H9R9BA01# |
| | | | 12pF | ±0.25pF | GRM1552C1H9R9CA01# |
| | | | | ±0.5pF | GRM1552C1H9R9DA01# |
| | | | | ±2% | GRM1552C1H100GA01# |
| | | | 15pF | ±5% | GRM1552C1H100JA01# |
| | | | | ±2% | GRM1552C1H120GA01# |
| | | | | ±5% | GRM1552C1H120JA01# |
| | | | 18pF | ±2% | GRM1552C1H150GA01# |
| | | | | ±5% | GRM1552C1H150JA01# |
| | | | | ±2% | GRM1552C1H180GA01# |
| | | | 22pF | ±5% | GRM1552C1H180JA01# |
| | | | | ±2% | GRM1552C1H220GA01# |
| | | | | ±5% | GRM1552C1H220JA01# |
| | | | 27pF | ±2% | GRM1552C1H270GA01# |
| | | | | ±5% | GRM1552C1H270JA01# |
| | | | | ±2% | GRM1552C1H330GA01# |
| | | | 33pF | ±5% | GRM1552C1H330JA01# |
| | | | | ±2% | GRM1552C1H390GA01# |
| | | | | ±5% | GRM1552C1H390JA01# |
| | | | 39pF | ±2% | GRM1552C1H470GA01# |
| | | | | ±5% | GRM1552C1H470JA01# |
| | | | | ±2% | GRM1552C1H560GA01# |
| | | | 47pF | ±5% | GRM1552C1H560JA01# |
| | | | | ±2% | GRM1552C1H680GA01# |
| | | | | ±5% | GRM1552C1H680JA01# |
| | | | 56pF | ±2% | GRM1552C1H820GA01# |
| | | | | ±5% | GRM1552C1H820JA01# |
| | | | | ±2% | GRM1552C1H101GA01# |
| | | | 68pF | ±5% | GRM1552C1H101JA01# |
| | | | | ±2% | GRM1552C1H121GA01# |
| | | | | ±5% | GRM1552C1H121JA01# |
| | | | 82pF | ±2% | GRM1552C1H151GA01# |
| | | | | ±5% | GRM1552C1H151JA01# |
| | | | | ±2% | GRM1552C1H181GA01# |
| | | | 100pF | ±5% | GRM1552C1H181JA01# |

- GRM
- GR3
- GRJ
- GR4
- GR7
- GJM
- GQM
- GA2
- GA3 GB
- GA3 GD
- GA3 GF
- LLL
- LLA
- LLM
- LLR
- NFM
- KRM
- KR3
- GMA
- GMD
- ⚠Caution /Notice

Part number # indicates the package specification code.

GRM Series Temperature Compensating Type Part Number List

(→ 1.0×0.5mm)

| T max. | Rated Voltage | TC Code | Cap. | Tol. | Part Number | | |
|--------|---------------|---------|--------|--------------------|--------------------|--------------------|--------------------|
| 0.55mm | 50Vdc | CH | 180pF | ±5% | GRM1552C1H181JA01# | | |
| | | | | ±2% | GRM1552C1H221GA01# | | |
| | | | ±5% | GRM1552C1H221JA01# | | | |
| | | | 270pF | ±2% | GRM1552C1H271GA01# | | |
| | | | | ±5% | GRM1552C1H271JA01# | | |
| | | | 330pF | ±2% | GRM1552C1H331GA01# | | |
| | | | | ±5% | GRM1552C1H331JA01# | | |
| | | | 390pF | ±2% | GRM1552C1H391GA01# | | |
| | | | | ±5% | GRM1552C1H391JA01# | | |
| | | | 470pF | ±2% | GRM1552C1H471GA01# | | |
| | | | | ±5% | GRM1552C1H471JA01# | | |
| | | | 560pF | ±2% | GRM1552C1H561GA01# | | |
| | | | | ±5% | GRM1552C1H561JA01# | | |
| | | | 680pF | ±2% | GRM1552C1H681GA01# | | |
| | | | | ±5% | GRM1552C1H681JA01# | | |
| | | | 820pF | ±2% | GRM1552C1H821GA01# | | |
| | | | | ±5% | GRM1552C1H821JA01# | | |
| | | | 1000pF | ±2% | GRM1552C1H102GA01# | | |
| | | | | ±5% | GRM1552C1H102JA01# | | |
| | | | 10Vdc | SL | 1200pF | ±5% | GRM1551X1A122JA01# |
| | | | | | 1500pF | ±5% | GRM1551X1A152JA01# |
| | | | | | 1800pF | ±5% | GRM1551X1A182JA01# |
| | | | | | 2200pF | ±5% | GRM1551X1A222JA01# |
| | | | | | 2700pF | ±5% | GRM1551X1A272JA01# |
| | 3300pF | ±5% | | | GRM1551X1A332JA01# | | |
| | 3900pF | ±5% | | | GRM1551X1A392JA01# | | |
| | 4700pF | ±5% | | | GRM1551X1A472JA01# | | |
| | U2J | 1200pF | | | ±5% | GRM1557U1A122JA01# | |
| | | 1500pF | | | ±5% | GRM1557U1A152JA01# | |
| | | 1800pF | | | ±5% | GRM1557U1A182JA01# | |
| | | 2200pF | | | ±5% | GRM1557U1A222JA01# | |
| | | 2700pF | | ±5% | GRM1557U1A272JA01# | | |
| | | 3300pF | | ±5% | GRM1557U1A332JA01# | | |
| | | 3900pF | | ±5% | GRM1557U1A392JA01# | | |
| | | 4700pF | | ±5% | GRM1557U1A472JA01# | | |
| | | UJ | | 1200pF | ±5% | GRM1553U1A122JA01# | |
| | | | | 1500pF | ±5% | GRM1553U1A152JA01# | |
| | | | | 1800pF | ±5% | GRM1553U1A182JA01# | |
| | | | | 2200pF | ±5% | GRM1553U1A222JA01# | |
| | 2700pF | | | ±5% | GRM1553U1A272JA01# | | |
| | 3300pF | | | ±5% | GRM1553U1A332JA01# | | |
| | 3900pF | | | ±5% | GRM1553U1A392JA01# | | |
| | 4700pF | | | ±5% | GRM1553U1A472JA01# | | |

| T max. | Rated Voltage | TC Code | Cap. | Tol. | Part Number | | |
|--------|---------------|---------|--------------------|--------------------|--------------------|--------------------|--------------------|
| 0.5mm | 50Vdc | U2J | 2700pF | ±5% | GRM1857U1H272JA44# | | |
| | | | | ±5% | GRM1857U1H332JA44# | | |
| | | | ±5% | GRM1857U1H392JA44# | | | |
| | | | ±5% | GRM1857U1H472JA44# | | | |
| | | | UJ | 2200pF | ±5% | GRM1853U1H222JA44# | |
| | | | | 2700pF | ±5% | GRM1853U1H272JA44# | |
| | | | | 3300pF | ±5% | GRM1853U1H332JA44# | |
| | | | | 3900pF | ±5% | GRM1853U1H392JA44# | |
| | | | | 4700pF | ±5% | GRM1853U1H472JA44# | |
| | | | | 10Vdc | SL | 5600pF | ±5% |
| | | | 6800pF | | | ±5% | GRM1851X1A682JA44# |
| | | | 8200pF | | | ±5% | GRM1851X1A822JA44# |
| | | 10000pF | ±5% | | | GRM1851X1A103JA44# | |
| | | U2J | 5600pF | | ±5% | GRM1857U1A562JA44# | |
| | | | 6800pF | | ±5% | GRM1857U1A682JA44# | |
| | | | 8200pF | | ±5% | GRM1857U1A822JA44# | |
| | | | 10000pF | | ±5% | GRM1857U1A103JA44# | |
| | | | UJ | | 5600pF | ±5% | GRM1853U1A562JA44# |
| | | | | | 6800pF | ±5% | GRM1853U1A682JA44# |
| | | | | | 8200pF | ±5% | GRM1853U1A822JA44# |
| | | | | | 10000pF | ±5% | GRM1853U1A103JA44# |
| | | 0.9mm | 100Vdc | COG | 0.50pF | ±0.05pF | GRM1885C2AR50WA01# |
| | | | | | | ±0.1pF | GRM1885C2AR50BA01# |
| | | | | | 0.60pF | ±0.05pF | GRM1885C2AR60WA01# |
| | ±0.1pF | | | | | GRM1885C2AR60BA01# | |
| | 0.70pF | | | | ±0.05pF | GRM1885C2AR70WA01# | |
| | | | | | ±0.1pF | GRM1885C2AR70BA01# | |
| | 0.80pF | | | | ±0.05pF | GRM1885C2AR80WA01# | |
| | | | | | ±0.1pF | GRM1885C2AR80BA01# | |
| | 0.90pF | | | | ±0.05pF | GRM1885C2AR90WA01# | |
| | | | | | ±0.1pF | GRM1885C2AR90BA01# | |
| | 1.0pF | | | | ±0.05pF | GRM1885C2A1R0WA01# | |
| | | | | | ±0.1pF | GRM1885C2A1R0BA01# | |
| | | | | | ±0.25pF | GRM1885C2A1R0CA01# | |
| | | | | | 1.1pF | ±0.05pF | GRM1885C2A1R1WA01# |
| | ±0.1pF | | | | | GRM1885C2A1R1BA01# | |
| | 1.2pF | | | | ±0.05pF | GRM1885C2A1R2WA01# | |
| | | | | | ±0.1pF | GRM1885C2A1R2BA01# | |
| | 1.3pF | | | | ±0.05pF | GRM1885C2A1R3WA01# | |
| | | | | | ±0.1pF | GRM1885C2A1R3BA01# | |
| | 1.4pF | | | | ±0.05pF | GRM1885C2A1R4WA01# | |
| | | | | | ±0.1pF | GRM1885C2A1R4BA01# | |
| | 1.5pF | | | | ±0.05pF | GRM1885C2A1R5WA01# | |
| | | | | | ±0.1pF | GRM1885C2A1R5BA01# | |
| | 1.6pF | | | | ±0.05pF | GRM1885C2A1R6WA01# | |
| | | ±0.1pF | GRM1885C2A1R6BA01# | | | | |
| | 1.7pF | ±0.05pF | GRM1885C2A1R7WA01# | | | | |
| | | ±0.1pF | GRM1885C2A1R7BA01# | | | | |

1.6×0.8mm

| T max. | Rated Voltage | TC Code | Cap. | Tol. | Part Number | |
|--------|---------------|---------|--------|--------|--------------------|--------------------|
| 0.5mm | 50Vdc | SL | 2200pF | ±5% | GRM1851X1H222JA44# | |
| | | | 2700pF | ±5% | GRM1851X1H272JA44# | |
| | | | 3300pF | ±5% | GRM1851X1H332JA44# | |
| | | | 3900pF | ±5% | GRM1851X1H392JA44# | |
| | | | 4700pF | ±5% | GRM1851X1H472JA44# | |
| | | | U2J | 2200pF | ±5% | GRM1857U1H222JA44# |

Part number # indicates the package specification code.

GRM Series Temperature Compensating Type Part Number List

(→ 1.6×0.8mm)

| T max. | Rated Voltage | TC Code | Cap. | Tol. | Part Number | T max. | Rated Voltage | TC Code | Cap. | Tol. | Part Number | | |
|--------|---------------|---------|---------|---------|--------------------|--------|---------------|---------|---------|--------------------|--------------------|---------|--------------------|
| 0.9mm | 100Vdc | COG | 1.7pF | ±0.25pF | GRM1885C2A1R7CA01# | 0.9mm | 100Vdc | COG | 3.5pF | ±0.25pF | GRM1885C2A3R5CA01# | | |
| | | | | 1.8pF | ±0.05pF | | | | | GRM1885C2A1R8WA01# | 3.6pF | ±0.05pF | GRM1885C2A3R6WA01# |
| | | | | | ±0.1pF | | | | | GRM1885C2A1R8BA01# | | ±0.1pF | GRM1885C2A3R6BA01# |
| | | | ±0.25pF | | GRM1885C2A1R8CA01# | | | | ±0.25pF | GRM1885C2A3R6CA01# | | | |
| | | | 1.9pF | ±0.05pF | GRM1885C2A1R9WA01# | | | | 3.7pF | ±0.05pF | GRM1885C2A3R7WA01# | | |
| | | | | ±0.1pF | GRM1885C2A1R9BA01# | | | | | ±0.1pF | GRM1885C2A3R7BA01# | | |
| | | | | ±0.25pF | GRM1885C2A1R9CA01# | | | | | ±0.25pF | GRM1885C2A3R7CA01# | | |
| | | | 2.0pF | ±0.05pF | GRM1885C2A2R0WA01# | | | | 3.8pF | ±0.05pF | GRM1885C2A3R8WA01# | | |
| | | | | ±0.1pF | GRM1885C2A2R0BA01# | | | | | ±0.1pF | GRM1885C2A3R8BA01# | | |
| | | | | ±0.25pF | GRM1885C2A2R0CA01# | | | | | ±0.25pF | GRM1885C2A3R8CA01# | | |
| | | | 2.1pF | ±0.05pF | GRM1885C2A2R1WA01# | | | | 3.9pF | ±0.05pF | GRM1885C2A3R9WA01# | | |
| | | | | ±0.1pF | GRM1885C2A2R1BA01# | | | | | ±0.1pF | GRM1885C2A3R9BA01# | | |
| | | | | ±0.25pF | GRM1885C2A2R1CA01# | | | | | ±0.25pF | GRM1885C2A3R9CA01# | | |
| | | | 2.2pF | ±0.05pF | GRM1885C2A2R2WA01# | | | | 4.0pF | ±0.05pF | GRM1885C2A4R0WA01# | | |
| | | | | ±0.1pF | GRM1885C2A2R2BA01# | | | | | ±0.1pF | GRM1885C2A4R0BA01# | | |
| | | | | ±0.25pF | GRM1885C2A2R2CA01# | | | | | ±0.25pF | GRM1885C2A4R0CA01# | | |
| | | | 2.3pF | ±0.05pF | GRM1885C2A2R3WA01# | | | | 4.1pF | ±0.05pF | GRM1885C2A4R1WA01# | | |
| | | | | ±0.1pF | GRM1885C2A2R3BA01# | | | | | ±0.1pF | GRM1885C2A4R1BA01# | | |
| | | | | ±0.25pF | GRM1885C2A2R3CA01# | | | | | ±0.25pF | GRM1885C2A4R1CA01# | | |
| | | | 2.4pF | ±0.05pF | GRM1885C2A2R4WA01# | | | | 4.2pF | ±0.05pF | GRM1885C2A4R2WA01# | | |
| | | | | ±0.1pF | GRM1885C2A2R4BA01# | | | | | ±0.1pF | GRM1885C2A4R2BA01# | | |
| | | | | ±0.25pF | GRM1885C2A2R4CA01# | | | | | ±0.25pF | GRM1885C2A4R2CA01# | | |
| | | | 2.5pF | ±0.05pF | GRM1885C2A2R5WA01# | | | | 4.3pF | ±0.05pF | GRM1885C2A4R3WA01# | | |
| | | | | ±0.1pF | GRM1885C2A2R5BA01# | | | | | ±0.1pF | GRM1885C2A4R3BA01# | | |
| | | | | ±0.25pF | GRM1885C2A2R5CA01# | | | | | ±0.25pF | GRM1885C2A4R3CA01# | | |
| | | | 2.6pF | ±0.05pF | GRM1885C2A2R6WA01# | | | | 4.4pF | ±0.05pF | GRM1885C2A4R4WA01# | | |
| | | | | ±0.1pF | GRM1885C2A2R6BA01# | | | | | ±0.1pF | GRM1885C2A4R4BA01# | | |
| | | | | ±0.25pF | GRM1885C2A2R6CA01# | | | | | ±0.25pF | GRM1885C2A4R4CA01# | | |
| | | | 2.7pF | ±0.05pF | GRM1885C2A2R7WA01# | | | | 4.5pF | ±0.05pF | GRM1885C2A4R5WA01# | | |
| | | | | ±0.1pF | GRM1885C2A2R7BA01# | | | | | ±0.1pF | GRM1885C2A4R5BA01# | | |
| | | | | ±0.25pF | GRM1885C2A2R7CA01# | | | | | ±0.25pF | GRM1885C2A4R5CA01# | | |
| | | | 2.8pF | ±0.05pF | GRM1885C2A2R8WA01# | | | | 4.6pF | ±0.05pF | GRM1885C2A4R6WA01# | | |
| | | | | ±0.1pF | GRM1885C2A2R8BA01# | | | | | ±0.1pF | GRM1885C2A4R6BA01# | | |
| | | | | ±0.25pF | GRM1885C2A2R8CA01# | | | | | ±0.25pF | GRM1885C2A4R6CA01# | | |
| | | | 2.9pF | ±0.05pF | GRM1885C2A2R9WA01# | | | | 4.7pF | ±0.05pF | GRM1885C2A4R7WA01# | | |
| | | | | ±0.1pF | GRM1885C2A2R9BA01# | | | | | ±0.1pF | GRM1885C2A4R7BA01# | | |
| | | | | ±0.25pF | GRM1885C2A2R9CA01# | | | | | ±0.25pF | GRM1885C2A4R7CA01# | | |
| | | | 3.0pF | ±0.05pF | GRM1885C2A3R0WA01# | | | | 4.8pF | ±0.05pF | GRM1885C2A4R8WA01# | | |
| | | | | ±0.1pF | GRM1885C2A3R0BA01# | | | | | ±0.1pF | GRM1885C2A4R8BA01# | | |
| | | | | ±0.25pF | GRM1885C2A3R0CA01# | | | | | ±0.25pF | GRM1885C2A4R8CA01# | | |
| | | | 3.1pF | ±0.05pF | GRM1885C2A3R1WA01# | | | | 4.9pF | ±0.05pF | GRM1885C2A4R9WA01# | | |
| | | | | ±0.1pF | GRM1885C2A3R1BA01# | | | | | ±0.1pF | GRM1885C2A4R9BA01# | | |
| | | | | ±0.25pF | GRM1885C2A3R1CA01# | | | | | ±0.25pF | GRM1885C2A4R9CA01# | | |
| | | | 3.2pF | ±0.05pF | GRM1885C2A3R2WA01# | | | | 5.0pF | ±0.05pF | GRM1885C2A5R0WA01# | | |
| | | | | ±0.1pF | GRM1885C2A3R2BA01# | | | | | ±0.1pF | GRM1885C2A5R0BA01# | | |
| | | | | ±0.25pF | GRM1885C2A3R2CA01# | | | | | ±0.25pF | GRM1885C2A5R0CA01# | | |
| | | | 3.3pF | ±0.05pF | GRM1885C2A3R3WA01# | | | | 5.1pF | ±0.05pF | GRM1885C2A5R1WA01# | | |
| | | | | ±0.1pF | GRM1885C2A3R3BA01# | | | | | ±0.1pF | GRM1885C2A5R1BA01# | | |
| | | | | ±0.25pF | GRM1885C2A3R3CA01# | | | | | ±0.25pF | GRM1885C2A5R1CA01# | | |
| | | | 3.4pF | ±0.05pF | GRM1885C2A3R4WA01# | | | | 5.2pF | ±0.5pF | GRM1885C2A5R1DA01# | | |
| | | | | ±0.1pF | GRM1885C2A3R4BA01# | | | | | ±0.05pF | GRM1885C2A5R2WA01# | | |
| | | | | ±0.25pF | GRM1885C2A3R4CA01# | | | | | ±0.1pF | GRM1885C2A5R2BA01# | | |
| | | | 3.5pF | ±0.05pF | GRM1885C2A3R5WA01# | | | | | ±0.25pF | GRM1885C2A5R2CA01# | | |
| | | | | ±0.1pF | GRM1885C2A3R5BA01# | | | | | ±0.5pF | GRM1885C2A5R2DA01# | | |

GRM
 GR3
 GRJ
 GR4
 GR7
 GJM
 GQM
 GA2
 GA3 GB
 GA3 GD
 GA3 GF
 LLL
 LLA
 LLM
 LLR
 NFM
 KRM
 KR3
 GMA
 GMD
 ⚠Caution /Notice

Part number # indicates the package specification code.

GRM Series Temperature Compensating Type Part Number List

(→ 1.6×0.8mm)

| T max. | Rated Voltage | TC Code | Cap. | Tol. | Part Number | T max. | Rated Voltage | TC Code | Cap. | Tol. | Part Number | |
|--------|---------------|---------|-------|---------|--------------------|--------|---------------|---------|---------|--------------------|--------------------|--------------------|
| 0.9mm | 100Vdc | COG | 5.3pF | ±0.05pF | GRM1885C2A5R3WA01# | 0.9mm | 100Vdc | COG | 6.6pF | ±0.25pF | GRM1885C2A6R6CA01# | |
| | | | | ±0.1pF | GRM1885C2A5R3BA01# | | | | | ±0.5pF | GRM1885C2A6R6DA01# | |
| | | | | ±0.25pF | GRM1885C2A5R3CA01# | | | | | 6.7pF | ±0.05pF | GRM1885C2A6R7WA01# |
| | | | | ±0.5pF | GRM1885C2A5R3DA01# | | | | | | ±0.1pF | GRM1885C2A6R7BA01# |
| | | | 5.4pF | ±0.05pF | GRM1885C2A5R4WA01# | | | | ±0.25pF | GRM1885C2A6R7CA01# | | |
| | | | | ±0.1pF | GRM1885C2A5R4BA01# | | | | ±0.5pF | GRM1885C2A6R7DA01# | | |
| | | | | ±0.25pF | GRM1885C2A5R4CA01# | | | | 6.8pF | ±0.05pF | GRM1885C2A6R8WA01# | |
| | | | | ±0.5pF | GRM1885C2A5R4DA01# | | | | | ±0.1pF | GRM1885C2A6R8BA01# | |
| | | | 5.5pF | ±0.05pF | GRM1885C2A5R5WA01# | | | | ±0.25pF | GRM1885C2A6R8CA01# | | |
| | | | | ±0.1pF | GRM1885C2A5R5BA01# | | | | ±0.5pF | GRM1885C2A6R8DA01# | | |
| | | | | ±0.25pF | GRM1885C2A5R5CA01# | | | | 6.9pF | ±0.05pF | GRM1885C2A6R9WA01# | |
| | | | | ±0.5pF | GRM1885C2A5R5DA01# | | | | | ±0.1pF | GRM1885C2A6R9BA01# | |
| | | | 5.6pF | ±0.05pF | GRM1885C2A5R6WA01# | | | | ±0.25pF | GRM1885C2A6R9CA01# | | |
| | | | | ±0.1pF | GRM1885C2A5R6BA01# | | | | ±0.5pF | GRM1885C2A6R9DA01# | | |
| | | | | ±0.25pF | GRM1885C2A5R6CA01# | | | | 7.0pF | ±0.05pF | GRM1885C2A7R0WA01# | |
| | | | | ±0.5pF | GRM1885C2A5R6DA01# | | | | | ±0.1pF | GRM1885C2A7R0BA01# | |
| | | | 5.7pF | ±0.05pF | GRM1885C2A5R7WA01# | | | | ±0.25pF | GRM1885C2A7R0CA01# | | |
| | | | | ±0.1pF | GRM1885C2A5R7BA01# | | | | ±0.5pF | GRM1885C2A7R0DA01# | | |
| | | | | ±0.25pF | GRM1885C2A5R7CA01# | | | | 7.1pF | ±0.05pF | GRM1885C2A7R1WA01# | |
| | | | | ±0.5pF | GRM1885C2A5R7DA01# | | | | | ±0.1pF | GRM1885C2A7R1BA01# | |
| | | | 5.8pF | ±0.05pF | GRM1885C2A5R8WA01# | | | | ±0.25pF | GRM1885C2A7R1CA01# | | |
| | | | | ±0.1pF | GRM1885C2A5R8BA01# | | | | ±0.5pF | GRM1885C2A7R1DA01# | | |
| | | | | ±0.25pF | GRM1885C2A5R8CA01# | | | | 7.2pF | ±0.05pF | GRM1885C2A7R2WA01# | |
| | | | | ±0.5pF | GRM1885C2A5R8DA01# | | | | | ±0.1pF | GRM1885C2A7R2BA01# | |
| | | | 5.9pF | ±0.05pF | GRM1885C2A5R9WA01# | | | | ±0.25pF | GRM1885C2A7R2CA01# | | |
| | | | | ±0.1pF | GRM1885C2A5R9BA01# | | | | ±0.5pF | GRM1885C2A7R2DA01# | | |
| | | | | ±0.25pF | GRM1885C2A5R9CA01# | | | | 7.3pF | ±0.05pF | GRM1885C2A7R3WA01# | |
| | | | | ±0.5pF | GRM1885C2A5R9DA01# | | | | | ±0.1pF | GRM1885C2A7R3BA01# | |
| | | | 6.0pF | ±0.05pF | GRM1885C2A6R0WA01# | | | | ±0.25pF | GRM1885C2A7R3CA01# | | |
| | | | | ±0.1pF | GRM1885C2A6R0BA01# | | | | ±0.5pF | GRM1885C2A7R3DA01# | | |
| | | | | ±0.25pF | GRM1885C2A6R0CA01# | | | | 7.4pF | ±0.05pF | GRM1885C2A7R4WA01# | |
| | | | | ±0.5pF | GRM1885C2A6R0DA01# | | | | | ±0.1pF | GRM1885C2A7R4BA01# | |
| | | | 6.1pF | ±0.05pF | GRM1885C2A6R1WA01# | | | | ±0.25pF | GRM1885C2A7R4CA01# | | |
| | | | | ±0.1pF | GRM1885C2A6R1BA01# | | | | ±0.5pF | GRM1885C2A7R4DA01# | | |
| | | | | ±0.25pF | GRM1885C2A6R1CA01# | | | | 7.5pF | ±0.05pF | GRM1885C2A7R5WA01# | |
| | | | | ±0.5pF | GRM1885C2A6R1DA01# | | | | | ±0.1pF | GRM1885C2A7R5BA01# | |
| | | | 6.2pF | ±0.05pF | GRM1885C2A6R2WA01# | | | | ±0.25pF | GRM1885C2A7R5CA01# | | |
| | | | | ±0.1pF | GRM1885C2A6R2BA01# | | | | ±0.5pF | GRM1885C2A7R5DA01# | | |
| | | | | ±0.25pF | GRM1885C2A6R2CA01# | | | | 7.6pF | ±0.05pF | GRM1885C2A7R6WA01# | |
| | | | | ±0.5pF | GRM1885C2A6R2DA01# | | | | | ±0.1pF | GRM1885C2A7R6BA01# | |
| | | | 6.3pF | ±0.05pF | GRM1885C2A6R3WA01# | | | | ±0.25pF | GRM1885C2A7R6CA01# | | |
| | | | | ±0.1pF | GRM1885C2A6R3BA01# | | | | ±0.5pF | GRM1885C2A7R6DA01# | | |
| | | | | ±0.25pF | GRM1885C2A6R3CA01# | | | | 7.7pF | ±0.05pF | GRM1885C2A7R7WA01# | |
| | | | | ±0.5pF | GRM1885C2A6R3DA01# | | | | | ±0.1pF | GRM1885C2A7R7BA01# | |
| | | | 6.4pF | ±0.05pF | GRM1885C2A6R4WA01# | | | | ±0.25pF | GRM1885C2A7R7CA01# | | |
| | | | | ±0.1pF | GRM1885C2A6R4BA01# | | | | ±0.5pF | GRM1885C2A7R7DA01# | | |
| | | | | ±0.25pF | GRM1885C2A6R4CA01# | | | | 7.8pF | ±0.05pF | GRM1885C2A7R8WA01# | |
| | | | | ±0.5pF | GRM1885C2A6R4DA01# | | | | | ±0.1pF | GRM1885C2A7R8BA01# | |
| | | | 6.5pF | ±0.05pF | GRM1885C2A6R5WA01# | | | | ±0.25pF | GRM1885C2A7R8CA01# | | |
| | | | | ±0.1pF | GRM1885C2A6R5BA01# | | | | ±0.5pF | GRM1885C2A7R8DA01# | | |
| | | | | ±0.25pF | GRM1885C2A6R5CA01# | | | | 7.9pF | ±0.05pF | GRM1885C2A7R9WA01# | |
| | | | | ±0.5pF | GRM1885C2A6R5DA01# | | | | | ±0.1pF | GRM1885C2A7R9BA01# | |
| | | | 6.6pF | ±0.05pF | GRM1885C2A6R6WA01# | | | | ±0.25pF | GRM1885C2A7R9CA01# | | |
| | | | | ±0.1pF | GRM1885C2A6R6BA01# | | | | ±0.5pF | GRM1885C2A7R9DA01# | | |

Part number # indicates the package specification code.



GRM Series Temperature Compensating Type Part Number List

(→ 1.6×0.8mm)

| T max. | Rated Voltage | TC Code | Cap. | Tol. | Part Number | T max. | Rated Voltage | TC Code | Cap. | Tol. | Part Number | |
|--------|---------------|---------|-------|---------|--------------------|--------|---------------|---------|---------|---------|--------------------|--------------------|
| 0.9mm | 100Vdc | COG | 8.0pF | ±0.05pF | GRM1885C2A8R0WA01# | 0.9mm | 100Vdc | COG | 9.3pF | ±0.25pF | GRM1885C2A9R3CA01# | |
| | | | | ±0.1pF | GRM1885C2A8R0BA01# | | | | | ±0.5pF | GRM1885C2A9R3DA01# | |
| | | | | ±0.25pF | GRM1885C2A8R0CA01# | | | | | 9.4pF | ±0.05pF | GRM1885C2A9R4WA01# |
| | | | | ±0.5pF | GRM1885C2A8R0DA01# | | | | | | ±0.1pF | GRM1885C2A9R4BA01# |
| | | | 8.1pF | ±0.05pF | GRM1885C2A8R1WA01# | | | | ±0.25pF | | GRM1885C2A9R4CA01# | |
| | | | | ±0.1pF | GRM1885C2A8R1BA01# | | | | ±0.5pF | | GRM1885C2A9R4DA01# | |
| | | | | ±0.25pF | GRM1885C2A8R1CA01# | | | | 9.5pF | ±0.05pF | GRM1885C2A9R5WA01# | |
| | | | | ±0.5pF | GRM1885C2A8R1DA01# | | | | | ±0.1pF | GRM1885C2A9R5BA01# | |
| | | | 8.2pF | ±0.05pF | GRM1885C2A8R2WA01# | | | | | ±0.25pF | GRM1885C2A9R5CA01# | |
| | | | | ±0.1pF | GRM1885C2A8R2BA01# | | | | | ±0.5pF | GRM1885C2A9R5DA01# | |
| | | | | ±0.25pF | GRM1885C2A8R2CA01# | | | | 9.6pF | ±0.05pF | GRM1885C2A9R6WA01# | |
| | | | | ±0.5pF | GRM1885C2A8R2DA01# | | | | | ±0.1pF | GRM1885C2A9R6BA01# | |
| | | | 8.3pF | ±0.05pF | GRM1885C2A8R3WA01# | | | | | ±0.25pF | GRM1885C2A9R6CA01# | |
| | | | | ±0.1pF | GRM1885C2A8R3BA01# | | | | | ±0.5pF | GRM1885C2A9R6DA01# | |
| | | | | ±0.25pF | GRM1885C2A8R3CA01# | | | | 9.7pF | ±0.05pF | GRM1885C2A9R7WA01# | |
| | | | | ±0.5pF | GRM1885C2A8R3DA01# | | | | | ±0.1pF | GRM1885C2A9R7BA01# | |
| | | | 8.4pF | ±0.05pF | GRM1885C2A8R4WA01# | | | | | ±0.25pF | GRM1885C2A9R7CA01# | |
| | | | | ±0.1pF | GRM1885C2A8R4BA01# | | | | | ±0.5pF | GRM1885C2A9R7DA01# | |
| | | | | ±0.25pF | GRM1885C2A8R4CA01# | | | | 9.8pF | ±0.05pF | GRM1885C2A9R8WA01# | |
| | | | | ±0.5pF | GRM1885C2A8R4DA01# | | | | | ±0.1pF | GRM1885C2A9R8BA01# | |
| | | | 8.5pF | ±0.05pF | GRM1885C2A8R5WA01# | | | | | ±0.25pF | GRM1885C2A9R8CA01# | |
| | | | | ±0.1pF | GRM1885C2A8R5BA01# | | | | | ±0.5pF | GRM1885C2A9R8DA01# | |
| | | | | ±0.25pF | GRM1885C2A8R5CA01# | | | | 9.9pF | ±0.05pF | GRM1885C2A9R9WA01# | |
| | | | | ±0.5pF | GRM1885C2A8R5DA01# | | | | | ±0.1pF | GRM1885C2A9R9BA01# | |
| | | | 8.6pF | ±0.05pF | GRM1885C2A8R6WA01# | | | | | ±0.25pF | GRM1885C2A9R9CA01# | |
| | | | | ±0.1pF | GRM1885C2A8R6BA01# | | | | | ±0.5pF | GRM1885C2A9R9DA01# | |
| | | | | ±0.25pF | GRM1885C2A8R6CA01# | | | | 10pF | ±5% | GRM1885C2A100JA01# | |
| | | | | ±0.5pF | GRM1885C2A8R6DA01# | | | | 12pF | ±5% | GRM1885C2A120JA01# | |
| | | | 8.7pF | ±0.05pF | GRM1885C2A8R7WA01# | | | | 15pF | ±5% | GRM1885C2A150JA01# | |
| | | | | ±0.1pF | GRM1885C2A8R7BA01# | | | | 18pF | ±5% | GRM1885C2A180JA01# | |
| | | | | ±0.25pF | GRM1885C2A8R7CA01# | | | | 22pF | ±5% | GRM1885C2A220JA01# | |
| | | | | ±0.5pF | GRM1885C2A8R7DA01# | | | | 27pF | ±5% | GRM1885C2A270JA01# | |
| | | | 8.8pF | ±0.05pF | GRM1885C2A8R8WA01# | | | | 33pF | ±5% | GRM1885C2A330JA01# | |
| | | | | ±0.1pF | GRM1885C2A8R8BA01# | | | | 39pF | ±5% | GRM1885C2A390JA01# | |
| | | | | ±0.25pF | GRM1885C2A8R8CA01# | | | | 47pF | ±5% | GRM1885C2A470JA01# | |
| | | | | ±0.5pF | GRM1885C2A8R8DA01# | | | | 56pF | ±5% | GRM1885C2A560JA01# | |
| | | | 8.9pF | ±0.05pF | GRM1885C2A8R9WA01# | | | | 68pF | ±5% | GRM1885C2A680JA01# | |
| | | | | ±0.1pF | GRM1885C2A8R9BA01# | | | | 82pF | ±5% | GRM1885C2A820JA01# | |
| | | | | ±0.25pF | GRM1885C2A8R9CA01# | | | | 100pF | ±5% | GRM1885C2A101JA01# | |
| | | | | ±0.5pF | GRM1885C2A8R9DA01# | | | | 120pF | ±5% | GRM1885C2A121JA01# | |
| | | | 9.0pF | ±0.05pF | GRM1885C2A9R0WA01# | | | | 150pF | ±5% | GRM1885C2A151JA01# | |
| | | | | ±0.1pF | GRM1885C2A9R0BA01# | | | | 180pF | ±5% | GRM1885C2A181JA01# | |
| | | | | ±0.25pF | GRM1885C2A9R0CA01# | | | | 220pF | ±5% | GRM1885C2A221JA01# | |
| | | | | ±0.5pF | GRM1885C2A9R0DA01# | | | | 270pF | ±5% | GRM1885C2A271JA01# | |
| | | | 9.1pF | ±0.05pF | GRM1885C2A9R1WA01# | | | | 330pF | ±5% | GRM1885C2A331JA01# | |
| | | | | ±0.1pF | GRM1885C2A9R1BA01# | | | | 390pF | ±5% | GRM1885C2A391JA01# | |
| | | | | ±0.25pF | GRM1885C2A9R1CA01# | | | | 470pF | ±5% | GRM1885C2A471JA01# | |
| | | | | ±0.5pF | GRM1885C2A9R1DA01# | | | | 560pF | ±5% | GRM1885C2A561JA01# | |
| | | | 9.2pF | ±0.05pF | GRM1885C2A9R2WA01# | | | | 680pF | ±5% | GRM1885C2A681JA01# | |
| | | | | ±0.1pF | GRM1885C2A9R2BA01# | | | | 820pF | ±5% | GRM1885C2A821JA01# | |
| | | | | ±0.25pF | GRM1885C2A9R2CA01# | | | | 1000pF | ±5% | GRM1885C2A102JA01# | |
| | | | | ±0.5pF | GRM1885C2A9R2DA01# | | | | 1200pF | ±5% | GRM1885C2A122JA01# | |
| | | | 9.3pF | ±0.05pF | GRM1885C2A9R3WA01# | | | | 1500pF | ±5% | GRM1885C2A152JA01# | |
| | | | | ±0.1pF | GRM1885C2A9R3BA01# | | | | CK | 0.50pF | ±0.05pF | GRM1884C2AR50WA01# |

Part number # indicates the package specification code.

GRM Series Temperature Compensating Type Part Number List

(→ 1.6×0.8mm)

| T max. | Rated Voltage | TC Code | Cap. | Tol. | Part Number | T max. | Rated Voltage | TC Code | Cap. | Tol. | Part Number |
|--------|---------------|---------|---------|--------------------|--------------------|--------------------|--------------------|--------------------|---------|--------------------|--------------------|
| 0.9mm | 100Vdc | CK | 0.50pF | ±0.1pF | GRM1884C2AR50BA01# | 0.9mm | 100Vdc | CJ | 2.5pF | ±0.05pF | GRM1883C2A2R5WA01# |
| | | | | ±0.05pF | GRM1884C2AR60WA01# | | | | | ±0.1pF | GRM1883C2A2R5BA01# |
| | | | | ±0.1pF | GRM1884C2AR60BA01# | | | | | ±0.25pF | GRM1883C2A2R5CA01# |
| | | | 0.70pF | ±0.05pF | GRM1884C2AR70WA01# | | | | 2.6pF | ±0.05pF | GRM1883C2A2R6WA01# |
| | | | | ±0.1pF | GRM1884C2AR70BA01# | | | | | ±0.1pF | GRM1883C2A2R6BA01# |
| | | | | ±0.25pF | GRM1883C2A2R6CA01# | | | | | | |
| | | | 0.80pF | ±0.05pF | GRM1884C2AR80WA01# | | | | 2.7pF | ±0.05pF | GRM1883C2A2R7WA01# |
| | | | | ±0.1pF | GRM1884C2AR80BA01# | | | | | ±0.1pF | GRM1883C2A2R7BA01# |
| | | | | ±0.25pF | GRM1883C2A2R7CA01# | | | | | | |
| | | | 0.90pF | ±0.05pF | GRM1884C2AR90WA01# | | | | 2.8pF | ±0.05pF | GRM1883C2A2R8WA01# |
| | | | | ±0.1pF | GRM1884C2AR90BA01# | | | | | ±0.1pF | GRM1883C2A2R8BA01# |
| | | | | ±0.25pF | GRM1883C2A2R8CA01# | | | | | | |
| | | | 1.0pF | ±0.05pF | GRM1884C2A1R0WA01# | | | | 2.9pF | ±0.05pF | GRM1883C2A2R9WA01# |
| | | | | ±0.1pF | GRM1884C2A1R0BA01# | | | | | ±0.1pF | GRM1883C2A2R9BA01# |
| | | | | ±0.25pF | GRM1883C2A2R9CA01# | | | | | | |
| | | | 1.1pF | ±0.05pF | GRM1884C2A1R1WA01# | | | | 3.0pF | ±0.05pF | GRM1883C2A3R0WA01# |
| | | | | ±0.1pF | GRM1884C2A1R1BA01# | | | | | ±0.1pF | GRM1883C2A3R0BA01# |
| | | | | ±0.25pF | GRM1883C2A3R0CA01# | | | | | | |
| | | | 1.2pF | ±0.05pF | GRM1884C2A1R2WA01# | | | | 3.1pF | ±0.05pF | GRM1883C2A3R1WA01# |
| | | | | ±0.1pF | GRM1884C2A1R2BA01# | | | | | ±0.1pF | GRM1883C2A3R1BA01# |
| | | | | ±0.25pF | GRM1883C2A3R1CA01# | | | | | | |
| | | | 1.3pF | ±0.05pF | GRM1884C2A1R3WA01# | | | | 3.2pF | ±0.05pF | GRM1883C2A3R2WA01# |
| | | | | ±0.1pF | GRM1884C2A1R3BA01# | | | | | ±0.1pF | GRM1883C2A3R2BA01# |
| | | | | ±0.25pF | GRM1883C2A3R2CA01# | | | | | | |
| | | 1.4pF | ±0.05pF | GRM1884C2A1R4WA01# | 3.3pF | ±0.05pF | GRM1883C2A3R3WA01# | | | | |
| | | | ±0.1pF | GRM1884C2A1R4BA01# | | ±0.1pF | GRM1883C2A3R3BA01# | | | | |
| | | | ±0.25pF | GRM1883C2A3R3CA01# | | | | | | | |
| | | 1.5pF | ±0.05pF | GRM1884C2A1R5WA01# | 3.4pF | ±0.05pF | GRM1883C2A3R4WA01# | | | | |
| | | | ±0.1pF | GRM1884C2A1R5BA01# | | ±0.1pF | GRM1883C2A3R4BA01# | | | | |
| | | | ±0.25pF | GRM1883C2A3R4CA01# | | | | | | | |
| | | 1.6pF | ±0.05pF | GRM1884C2A1R6WA01# | 3.5pF | ±0.05pF | GRM1883C2A3R5WA01# | | | | |
| | | | ±0.1pF | GRM1884C2A1R6BA01# | | ±0.1pF | GRM1883C2A3R5BA01# | | | | |
| | | | ±0.25pF | GRM1883C2A3R5CA01# | | | | | | | |
| | | 1.7pF | ±0.05pF | GRM1884C2A1R7WA01# | 3.6pF | ±0.05pF | GRM1883C2A3R6WA01# | | | | |
| | | | ±0.1pF | GRM1884C2A1R7BA01# | | ±0.1pF | GRM1883C2A3R6BA01# | | | | |
| | | | ±0.25pF | GRM1883C2A3R6CA01# | | | | | | | |
| | | 1.8pF | ±0.05pF | GRM1884C2A1R8WA01# | 3.7pF | ±0.05pF | GRM1883C2A3R7WA01# | | | | |
| | | | ±0.1pF | GRM1884C2A1R8BA01# | | ±0.1pF | GRM1883C2A3R7BA01# | | | | |
| | | | ±0.25pF | GRM1883C2A3R7CA01# | | | | | | | |
| | | 1.9pF | ±0.05pF | GRM1884C2A1R9WA01# | 3.8pF | ±0.05pF | GRM1883C2A3R8WA01# | | | | |
| | | | ±0.1pF | GRM1884C2A1R9BA01# | | ±0.1pF | GRM1883C2A3R8BA01# | | | | |
| | | | ±0.25pF | GRM1883C2A3R8CA01# | | | | | | | |
| | | 2.0pF | ±0.05pF | GRM1884C2A2R0WA01# | 3.9pF | ±0.05pF | GRM1883C2A3R9WA01# | | | | |
| | | | ±0.1pF | GRM1884C2A2R0BA01# | | ±0.1pF | GRM1883C2A3R9BA01# | | | | |
| | | | ±0.25pF | GRM1883C2A3R9CA01# | | | | | | | |
| | | CJ | 100Vdc | 2.1pF | ±0.05pF | GRM1883C2A2R1WA01# | CH | 4.0pF | ±0.05pF | GRM1882C2A4R0WA01# | |
| | | | | | ±0.1pF | GRM1883C2A2R1BA01# | | | ±0.1pF | GRM1882C2A4R0BA01# | |
| | | | | | ±0.25pF | GRM1883C2A2R1CA01# | | | ±0.25pF | GRM1882C2A4R0CA01# | |
| 2.2pF | ±0.05pF | | | GRM1883C2A2R2WA01# | 4.1pF | ±0.05pF | | GRM1882C2A4R1WA01# | | | |
| | ±0.1pF | | | GRM1883C2A2R2BA01# | | ±0.1pF | | GRM1882C2A4R1BA01# | | | |
| | ±0.25pF | | | GRM1883C2A2R2CA01# | | ±0.25pF | | GRM1882C2A4R1CA01# | | | |
| 2.3pF | ±0.05pF | | | GRM1883C2A2R3WA01# | 4.2pF | ±0.05pF | | GRM1882C2A4R2WA01# | | | |
| | ±0.1pF | | | GRM1883C2A2R3BA01# | | ±0.1pF | | GRM1882C2A4R2BA01# | | | |
| | ±0.25pF | | | GRM1883C2A2R3CA01# | | ±0.25pF | | GRM1882C2A4R2CA01# | | | |
| 2.4pF | ±0.05pF | | | GRM1883C2A2R4WA01# | | | | | | | |
| | ±0.1pF | | | GRM1883C2A2R4BA01# | | | | | | | |
| | ±0.25pF | | | GRM1883C2A2R4CA01# | | | | | | | |

Part number # indicates the package specification code.



GRM Series Temperature Compensating Type Part Number List

(→ 1.6×0.8mm)

| T max. | Rated Voltage | TC Code | Cap. | Tol. | Part Number |
|--------|---------------|---------|-------|---------|--------------------|
| 0.9mm | 100Vdc | CH | 4.3pF | ±0.05pF | GRM1882C2A4R3WA01# |
| | | | | ±0.1pF | GRM1882C2A4R3BA01# |
| | | | | ±0.25pF | GRM1882C2A4R3CA01# |
| | | | 4.4pF | ±0.05pF | GRM1882C2A4R4WA01# |
| | | | | ±0.1pF | GRM1882C2A4R4BA01# |
| | | | | ±0.25pF | GRM1882C2A4R4CA01# |
| | | | 4.5pF | ±0.05pF | GRM1882C2A4R5WA01# |
| | | | | ±0.1pF | GRM1882C2A4R5BA01# |
| | | | | ±0.25pF | GRM1882C2A4R5CA01# |
| | | | 4.6pF | ±0.05pF | GRM1882C2A4R6WA01# |
| | | | | ±0.1pF | GRM1882C2A4R6BA01# |
| | | | | ±0.25pF | GRM1882C2A4R6CA01# |
| | | | 4.7pF | ±0.05pF | GRM1882C2A4R7WA01# |
| | | | | ±0.1pF | GRM1882C2A4R7BA01# |
| | | | | ±0.25pF | GRM1882C2A4R7CA01# |
| | | | 4.8pF | ±0.05pF | GRM1882C2A4R8WA01# |
| | | | | ±0.1pF | GRM1882C2A4R8BA01# |
| | | | | ±0.25pF | GRM1882C2A4R8CA01# |
| | | | 4.9pF | ±0.05pF | GRM1882C2A4R9WA01# |
| | | | | ±0.1pF | GRM1882C2A4R9BA01# |
| | | | | ±0.25pF | GRM1882C2A4R9CA01# |
| | | | 5.0pF | ±0.05pF | GRM1882C2A5R0WA01# |
| | | | | ±0.1pF | GRM1882C2A5R0BA01# |
| | | | | ±0.25pF | GRM1882C2A5R0CA01# |
| | | | 5.1pF | ±0.05pF | GRM1882C2A5R1WA01# |
| | | | | ±0.1pF | GRM1882C2A5R1BA01# |
| | | | | ±0.25pF | GRM1882C2A5R1CA01# |
| | | | | ±0.5pF | GRM1882C2A5R1DA01# |
| | | | 5.2pF | ±0.05pF | GRM1882C2A5R2WA01# |
| | | | | ±0.1pF | GRM1882C2A5R2BA01# |
| | | | | ±0.25pF | GRM1882C2A5R2CA01# |
| | | | | ±0.5pF | GRM1882C2A5R2DA01# |
| | | | 5.3pF | ±0.05pF | GRM1882C2A5R3WA01# |
| | | | | ±0.1pF | GRM1882C2A5R3BA01# |
| | | | | ±0.25pF | GRM1882C2A5R3CA01# |
| | | | | ±0.5pF | GRM1882C2A5R3DA01# |
| | | | 5.4pF | ±0.05pF | GRM1882C2A5R4WA01# |
| | | | | ±0.1pF | GRM1882C2A5R4BA01# |
| | | | | ±0.25pF | GRM1882C2A5R4CA01# |
| | | | | ±0.5pF | GRM1882C2A5R4DA01# |
| | | | 5.5pF | ±0.05pF | GRM1882C2A5R5WA01# |
| | | | | ±0.1pF | GRM1882C2A5R5BA01# |
| | | | | ±0.25pF | GRM1882C2A5R5CA01# |
| | | | | ±0.5pF | GRM1882C2A5R5DA01# |
| | | | 5.6pF | ±0.05pF | GRM1882C2A5R6WA01# |
| | | | | ±0.1pF | GRM1882C2A5R6BA01# |
| | | | | ±0.25pF | GRM1882C2A5R6CA01# |
| | | | | ±0.5pF | GRM1882C2A5R6DA01# |
| | | | 5.7pF | ±0.05pF | GRM1882C2A5R7WA01# |
| | | | | ±0.1pF | GRM1882C2A5R7BA01# |
| | | | | ±0.25pF | GRM1882C2A5R7CA01# |
| | | | | ±0.5pF | GRM1882C2A5R7DA01# |
| | | | 5.8pF | ±0.05pF | GRM1882C2A5R8WA01# |
| | | | | ±0.1pF | GRM1882C2A5R8BA01# |

| T max. | Rated Voltage | TC Code | Cap. | Tol. | Part Number |
|--------|---------------|---------|-------|---------|--------------------|
| 0.9mm | 100Vdc | CH | 5.8pF | ±0.25pF | GRM1882C2A5R8CA01# |
| | | | | ±0.5pF | GRM1882C2A5R8DA01# |
| | | | 5.9pF | ±0.05pF | GRM1882C2A5R9WA01# |
| | | | | ±0.1pF | GRM1882C2A5R9BA01# |
| | | | | ±0.25pF | GRM1882C2A5R9CA01# |
| | | | 6.0pF | ±0.05pF | GRM1882C2A6R0WA01# |
| | | | | ±0.1pF | GRM1882C2A6R0BA01# |
| | | | | ±0.25pF | GRM1882C2A6R0CA01# |
| | | | 6.1pF | ±0.05pF | GRM1882C2A6R1WA01# |
| | | | | ±0.1pF | GRM1882C2A6R1BA01# |
| | | | | ±0.25pF | GRM1882C2A6R1CA01# |
| | | | 6.2pF | ±0.05pF | GRM1882C2A6R2WA01# |
| | | | | ±0.1pF | GRM1882C2A6R2BA01# |
| | | | | ±0.25pF | GRM1882C2A6R2CA01# |
| | | | 6.3pF | ±0.05pF | GRM1882C2A6R3WA01# |
| | | | | ±0.1pF | GRM1882C2A6R3BA01# |
| | | | | ±0.25pF | GRM1882C2A6R3CA01# |
| | | | 6.4pF | ±0.05pF | GRM1882C2A6R4WA01# |
| | | | | ±0.1pF | GRM1882C2A6R4BA01# |
| | | | | ±0.25pF | GRM1882C2A6R4CA01# |
| | | | 6.5pF | ±0.05pF | GRM1882C2A6R5WA01# |
| | | | | ±0.1pF | GRM1882C2A6R5BA01# |
| | | | | ±0.25pF | GRM1882C2A6R5CA01# |
| | | | 6.6pF | ±0.05pF | GRM1882C2A6R6WA01# |
| | | | | ±0.1pF | GRM1882C2A6R6BA01# |
| | | | | ±0.25pF | GRM1882C2A6R6CA01# |
| | | | 6.7pF | ±0.05pF | GRM1882C2A6R7WA01# |
| | | | | ±0.1pF | GRM1882C2A6R7BA01# |
| | | | | ±0.25pF | GRM1882C2A6R7CA01# |
| | | | 6.8pF | ±0.05pF | GRM1882C2A6R8WA01# |
| | | | | ±0.1pF | GRM1882C2A6R8BA01# |
| | | | | ±0.25pF | GRM1882C2A6R8CA01# |
| | | | 6.9pF | ±0.05pF | GRM1882C2A6R9WA01# |
| | | | | ±0.1pF | GRM1882C2A6R9BA01# |
| | | | | ±0.25pF | GRM1882C2A6R9CA01# |
| | | | 7.0pF | ±0.05pF | GRM1882C2A7R0WA01# |
| | | | | ±0.1pF | GRM1882C2A7R0BA01# |
| | | | | ±0.25pF | GRM1882C2A7R0CA01# |
| | | | 7.1pF | ±0.05pF | GRM1882C2A7R1WA01# |
| | | | | ±0.1pF | GRM1882C2A7R1BA01# |
| | | | | ±0.25pF | GRM1882C2A7R1CA01# |

- GRM
- GR3
- GRJ
- GR4
- GR7
- GJM
- GQM
- GA2
- GA3 GB
- GA3 GD
- GA3 GF
- LLL
- LLA
- LLM
- LLR
- NFM
- KRM
- KR3
- GMA
- GMD
- ⚠Caution /Notice

Part number # indicates the package specification code.

GRM Series Temperature Compensating Type Part Number List

(→ 1.6×0.8mm)

| T max. | Rated Voltage | TC Code | Cap. | Tol. | Part Number |
|--------|---------------|---------|-------|---------|--------------------|
| 0.9mm | 100Vdc | CH | 7.2pF | ±0.05pF | GRM1882C2A7R2WA01# |
| | | | | ±0.1pF | GRM1882C2A7R2BA01# |
| | | | | ±0.25pF | GRM1882C2A7R2CA01# |
| | | | | ±0.5pF | GRM1882C2A7R2DA01# |
| | | | 7.3pF | ±0.05pF | GRM1882C2A7R3WA01# |
| | | | | ±0.1pF | GRM1882C2A7R3BA01# |
| | | | | ±0.25pF | GRM1882C2A7R3CA01# |
| | | | | ±0.5pF | GRM1882C2A7R3DA01# |
| | | | 7.4pF | ±0.05pF | GRM1882C2A7R4WA01# |
| | | | | ±0.1pF | GRM1882C2A7R4BA01# |
| | | | | ±0.25pF | GRM1882C2A7R4CA01# |
| | | | | ±0.5pF | GRM1882C2A7R4DA01# |
| | | | 7.5pF | ±0.05pF | GRM1882C2A7R5WA01# |
| | | | | ±0.1pF | GRM1882C2A7R5BA01# |
| | | | | ±0.25pF | GRM1882C2A7R5CA01# |
| | | | | ±0.5pF | GRM1882C2A7R5DA01# |
| | | | 7.6pF | ±0.05pF | GRM1882C2A7R6WA01# |
| | | | | ±0.1pF | GRM1882C2A7R6BA01# |
| | | | | ±0.25pF | GRM1882C2A7R6CA01# |
| | | | | ±0.5pF | GRM1882C2A7R6DA01# |
| | | | 7.7pF | ±0.05pF | GRM1882C2A7R7WA01# |
| | | | | ±0.1pF | GRM1882C2A7R7BA01# |
| | | | | ±0.25pF | GRM1882C2A7R7CA01# |
| | | | | ±0.5pF | GRM1882C2A7R7DA01# |
| | | | 7.8pF | ±0.05pF | GRM1882C2A7R8WA01# |
| | | | | ±0.1pF | GRM1882C2A7R8BA01# |
| | | | | ±0.25pF | GRM1882C2A7R8CA01# |
| | | | | ±0.5pF | GRM1882C2A7R8DA01# |
| | | | 7.9pF | ±0.05pF | GRM1882C2A7R9WA01# |
| | | | | ±0.1pF | GRM1882C2A7R9BA01# |
| | | | | ±0.25pF | GRM1882C2A7R9CA01# |
| | | | | ±0.5pF | GRM1882C2A7R9DA01# |
| | | | 8.0pF | ±0.05pF | GRM1882C2A8R0WA01# |
| | | | | ±0.1pF | GRM1882C2A8R0BA01# |
| | | | | ±0.25pF | GRM1882C2A8R0CA01# |
| | | | | ±0.5pF | GRM1882C2A8R0DA01# |
| | | | 8.1pF | ±0.05pF | GRM1882C2A8R1WA01# |
| | | | | ±0.1pF | GRM1882C2A8R1BA01# |
| | | | | ±0.25pF | GRM1882C2A8R1CA01# |
| | | | | ±0.5pF | GRM1882C2A8R1DA01# |
| | | | 8.2pF | ±0.05pF | GRM1882C2A8R2WA01# |
| | | | | ±0.1pF | GRM1882C2A8R2BA01# |
| | | | | ±0.25pF | GRM1882C2A8R2CA01# |
| | | | | ±0.5pF | GRM1882C2A8R2DA01# |
| | | | 8.3pF | ±0.05pF | GRM1882C2A8R3WA01# |
| | | | | ±0.1pF | GRM1882C2A8R3BA01# |
| | | | | ±0.25pF | GRM1882C2A8R3CA01# |
| | | | | ±0.5pF | GRM1882C2A8R3DA01# |
| | | | 8.4pF | ±0.05pF | GRM1882C2A8R4WA01# |
| | | | | ±0.1pF | GRM1882C2A8R4BA01# |
| | | | | ±0.25pF | GRM1882C2A8R4CA01# |
| | | | | ±0.5pF | GRM1882C2A8R4DA01# |
| | | | 8.5pF | ±0.05pF | GRM1882C2A8R5WA01# |
| | | | | ±0.1pF | GRM1882C2A8R5BA01# |

| T max. | Rated Voltage | TC Code | Cap. | Tol. | Part Number |
|--------|---------------|---------|-------|---------|--------------------|
| 0.9mm | 100Vdc | CH | 8.5pF | ±0.25pF | GRM1882C2A8R5CA01# |
| | | | | ±0.5pF | GRM1882C2A8R5DA01# |
| | | | 8.6pF | ±0.05pF | GRM1882C2A8R6WA01# |
| | | | | ±0.1pF | GRM1882C2A8R6BA01# |
| | | | | ±0.25pF | GRM1882C2A8R6CA01# |
| | | | 8.7pF | ±0.05pF | GRM1882C2A8R7WA01# |
| | | | | ±0.1pF | GRM1882C2A8R7BA01# |
| | | | | ±0.25pF | GRM1882C2A8R7CA01# |
| | | | 8.8pF | ±0.05pF | GRM1882C2A8R8WA01# |
| | | | | ±0.1pF | GRM1882C2A8R8BA01# |
| | | | | ±0.25pF | GRM1882C2A8R8CA01# |
| | | | 8.9pF | ±0.05pF | GRM1882C2A8R9WA01# |
| | | | | ±0.1pF | GRM1882C2A8R9BA01# |
| | | | | ±0.25pF | GRM1882C2A8R9CA01# |
| | | | 9.0pF | ±0.05pF | GRM1882C2A9R0WA01# |
| | | | | ±0.1pF | GRM1882C2A9R0BA01# |
| | | | | ±0.25pF | GRM1882C2A9R0CA01# |
| | | | 9.1pF | ±0.05pF | GRM1882C2A9R1WA01# |
| | | | | ±0.1pF | GRM1882C2A9R1BA01# |
| | | | | ±0.25pF | GRM1882C2A9R1CA01# |
| | | | 9.2pF | ±0.05pF | GRM1882C2A9R2WA01# |
| | | | | ±0.1pF | GRM1882C2A9R2BA01# |
| | | | | ±0.25pF | GRM1882C2A9R2CA01# |
| | | | 9.3pF | ±0.05pF | GRM1882C2A9R3WA01# |
| | | | | ±0.1pF | GRM1882C2A9R3BA01# |
| | | | | ±0.25pF | GRM1882C2A9R3CA01# |
| | | | 9.4pF | ±0.05pF | GRM1882C2A9R4WA01# |
| | | | | ±0.1pF | GRM1882C2A9R4BA01# |
| | | | | ±0.25pF | GRM1882C2A9R4CA01# |
| | | | 9.5pF | ±0.05pF | GRM1882C2A9R5WA01# |
| | | | | ±0.1pF | GRM1882C2A9R5BA01# |
| | | | | ±0.25pF | GRM1882C2A9R5CA01# |
| | | | 9.6pF | ±0.05pF | GRM1882C2A9R6WA01# |
| | | | | ±0.1pF | GRM1882C2A9R6BA01# |
| | | | | ±0.25pF | GRM1882C2A9R6CA01# |
| | | | 9.7pF | ±0.05pF | GRM1882C2A9R7WA01# |
| | | | | ±0.1pF | GRM1882C2A9R7BA01# |
| | | | | ±0.25pF | GRM1882C2A9R7CA01# |
| | | | 9.8pF | ±0.05pF | GRM1882C2A9R8WA01# |
| | | | | ±0.1pF | GRM1882C2A9R8BA01# |
| | | | | ±0.25pF | GRM1882C2A9R8CA01# |

Part number # indicates the package specification code.

GRM
 GR3
 GRJ
 GR4
 GR7
 GJM
 GQM
 GA2
 GA3 GB
 GA3 GD
 GA3 GF
 LLL
 LLA
 LLM
 LLR
 NFM
 KRM
 KR3
 GMA
 GMD
 ⚠Caution /Notice

GRM Series Temperature Compensating Type Part Number List

(→ 1.6×0.8mm)

| T max. | Rated Voltage | TC Code | Cap. | Tol. | Part Number | T max. | Rated Voltage | TC Code | Cap. | Tol. | Part Number | | |
|---------|--------------------|--------------------|--------|---------|--------------------|--------------------|--------------------|---------|---------|--------------------|--------------------|--------------------|--------------------|
| 0.9mm | 100Vdc | CH | 9.9pF | ±0.05pF | GRM1882C2A9R9WA01# | 0.9mm | 50Vdc | COG | 1.4pF | ±0.1pF | GRM1885C1H1R4BA01# | | |
| | | | | ±0.1pF | GRM1882C2A9R9BA01# | | | | | ±0.25pF | GRM1885C1H1R4CA01# | | |
| | | | | ±0.25pF | GRM1882C2A9R9CA01# | | | | | 1.5pF | ±0.05pF | GRM1885C1H1R5WA01# | |
| | | | | ±0.5pF | GRM1882C2A9R9DA01# | | | | | | ±0.1pF | GRM1885C1H1R5BA01# | |
| | | | 10pF | ±5% | GRM1882C2A100JA01# | | | | 1.6pF | ±0.05pF | GRM1885C1H1R6WA01# | | |
| | | | | ±5% | GRM1882C2A120JA01# | | | | | ±0.1pF | GRM1885C1H1R6BA01# | | |
| | | | 15pF | ±5% | GRM1882C2A150JA01# | | | | 1.7pF | ±0.25pF | GRM1885C1H1R6CA01# | | |
| | | | 18pF | ±5% | GRM1882C2A180JA01# | | | | | ±0.05pF | GRM1885C1H1R7WA01# | | |
| | | | 22pF | ±5% | GRM1882C2A220JA01# | | | | ±0.1pF | GRM1885C1H1R7BA01# | | | |
| | | | 27pF | ±5% | GRM1882C2A270JA01# | | | | ±0.25pF | GRM1885C1H1R7CA01# | | | |
| | | | 33pF | ±5% | GRM1882C2A330JA01# | | | | 1.8pF | ±0.05pF | GRM1885C1H1R8WA01# | | |
| | | | 39pF | ±5% | GRM1882C2A390JA01# | | | | | ±0.1pF | GRM1885C1H1R8BA01# | | |
| | | | 47pF | ±5% | GRM1882C2A470JA01# | | | | ±0.25pF | GRM1885C1H1R8CA01# | | | |
| | | | 56pF | ±5% | GRM1882C2A560JA01# | | | | 1.9pF | ±0.05pF | GRM1885C1H1R9WA01# | | |
| | | | 68pF | ±5% | GRM1882C2A680JA01# | | | | | ±0.1pF | GRM1885C1H1R9BA01# | | |
| | | | 82pF | ±5% | GRM1882C2A820JA01# | | | | ±0.25pF | GRM1885C1H1R9CA01# | | | |
| | | | 100pF | ±5% | GRM1882C2A101JA01# | | | | 2.0pF | ±0.05pF | GRM1885C1H2R0WA01# | | |
| | | | 120pF | ±5% | GRM1882C2A121JA01# | | | | | ±0.1pF | GRM1885C1H2R0BA01# | | |
| | | | 150pF | ±5% | GRM1882C2A151JA01# | | | | ±0.25pF | GRM1885C1H2R0CA01# | | | |
| | | | 180pF | ±5% | GRM1882C2A181JA01# | | | | 2.1pF | ±0.05pF | GRM1885C1H2R1WA01# | | |
| | | | 220pF | ±5% | GRM1882C2A221JA01# | | | | | ±0.1pF | GRM1885C1H2R1BA01# | | |
| | | | 270pF | ±5% | GRM1882C2A271JA01# | | | | ±0.25pF | GRM1885C1H2R1CA01# | | | |
| | | | 330pF | ±5% | GRM1882C2A331JA01# | | | | 2.2pF | ±0.05pF | GRM1885C1H2R2WA01# | | |
| | | | 390pF | ±5% | GRM1882C2A391JA01# | | | | | ±0.1pF | GRM1885C1H2R2BA01# | | |
| | | | 470pF | ±5% | GRM1882C2A471JA01# | | | | ±0.25pF | GRM1885C1H2R2CA01# | | | |
| | | | 560pF | ±5% | GRM1882C2A561JA01# | | | | 2.3pF | ±0.05pF | GRM1885C1H2R3WA01# | | |
| | | | 680pF | ±5% | GRM1882C2A681JA01# | | | | | ±0.1pF | GRM1885C1H2R3BA01# | | |
| | | | 820pF | ±5% | GRM1882C2A821JA01# | | | | ±0.25pF | GRM1885C1H2R3CA01# | | | |
| | | | 1000pF | ±5% | GRM1882C2A102JA01# | | | | 2.4pF | ±0.05pF | GRM1885C1H2R4WA01# | | |
| | | | 1200pF | ±5% | GRM1882C2A122JA01# | | | | | ±0.1pF | GRM1885C1H2R4BA01# | | |
| | | | 1500pF | ±5% | GRM1882C2A152JA01# | | | | ±0.25pF | GRM1885C1H2R4CA01# | | | |
| | | | 50Vdc | COG | 0.50pF | | | | ±0.05pF | GRM1885C1HR50WA01# | 2.5pF | ±0.05pF | GRM1885C1H2R5WA01# |
| | | | | | | | | | ±0.1pF | GRM1885C1HR50BA01# | | ±0.1pF | GRM1885C1H2R5BA01# |
| | | | | | 0.60pF | | | | ±0.05pF | GRM1885C1HR60WA01# | ±0.25pF | GRM1885C1H2R5CA01# | |
| | | | | | | | | | ±0.1pF | GRM1885C1HR60BA01# | 2.6pF | ±0.05pF | GRM1885C1H2R6WA01# |
| | | | | | 0.70pF | | | | ±0.05pF | GRM1885C1HR70WA01# | | ±0.1pF | GRM1885C1H2R6BA01# |
| | | | | | | | | | ±0.1pF | GRM1885C1HR70BA01# | ±0.25pF | GRM1885C1H2R6CA01# | |
| | | | | | 0.80pF | | | | ±0.05pF | GRM1885C1HR80WA01# | 2.7pF | ±0.05pF | GRM1885C1H2R7WA01# |
| | | | | | | | | | ±0.1pF | GRM1885C1HR80BA01# | | ±0.1pF | GRM1885C1H2R7BA01# |
| | | | | | 0.90pF | | | | ±0.05pF | GRM1885C1HR90WA01# | ±0.25pF | GRM1885C1H2R7CA01# | |
| | | | | | | | | | ±0.1pF | GRM1885C1HR90BA01# | 2.8pF | ±0.05pF | GRM1885C1H2R8WA01# |
| | | | | | 1.0pF | | | | ±0.05pF | GRM1885C1H1R0WA01# | | ±0.1pF | GRM1885C1H2R8BA01# |
| | | | | | | | | | ±0.1pF | GRM1885C1H1R0BA01# | ±0.25pF | GRM1885C1H2R8CA01# | |
| | | | | | 1.1pF | | | | ±0.25pF | GRM1885C1H1R0CA01# | 2.9pF | ±0.05pF | GRM1885C1H2R9WA01# |
| | | | | | | | | | ±0.05pF | GRM1885C1H1R1WA01# | | ±0.1pF | GRM1885C1H2R9BA01# |
| 1.2pF | ±0.1pF | GRM1885C1H1R1BA01# | | | ±0.25pF | GRM1885C1H2R9CA01# | | | | | | | |
| | ±0.25pF | GRM1885C1H1R1CA01# | | | 3.0pF | ±0.05pF | GRM1885C1H3R0WA01# | | | | | | |
| 1.3pF | ±0.05pF | GRM1885C1H1R2WA01# | | | | ±0.1pF | GRM1885C1H3R0BA01# | | | | | | |
| | ±0.1pF | GRM1885C1H1R2BA01# | | | ±0.25pF | GRM1885C1H3R0CA01# | | | | | | | |
| 1.4pF | ±0.25pF | GRM1885C1H1R2CA01# | | | 3.1pF | ±0.05pF | GRM1885C1H3R1WA01# | | | | | | |
| | ±0.05pF | GRM1885C1H1R3WA01# | | | | ±0.1pF | GRM1885C1H3R1BA01# | | | | | | |
| 1.5pF | ±0.1pF | GRM1885C1H1R3BA01# | | | ±0.25pF | GRM1885C1H3R1CA01# | | | | | | | |
| | ±0.25pF | GRM1885C1H1R3CA01# | | | 3.2pF | ±0.05pF | GRM1885C1H3R2WA01# | | | | | | |
| ±0.05pF | GRM1885C1H1R4WA01# | | | | | | | | | | | | |

GRM
 GR3
 GRJ
 GRU
 GR4
 GR7
 GJM
 GQM
 GA2
 GA3 GB
 GA3 GD
 GA3 GF
 LLL
 LLA
 LLM
 LLR
 NFM
 KRM
 KR3
 GMA
 GMD
 ⚠Caution /Notice

Part number # indicates the package specification code.

GRM Series Temperature Compensating Type Part Number List

(→ 1.6×0.8mm)

| T max. | Rated Voltage | TC Code | Cap. | Tol. | Part Number |
|--------|---------------|--------------------|-------|---------|--------------------|
| 0.9mm | 50Vdc | COG | 3.2pF | ±0.1pF | GRM1885C1H3R2BA01# |
| | | | | ±0.25pF | GRM1885C1H3R2CA01# |
| | | | 3.3pF | ±0.05pF | GRM1885C1H3R3WA01# |
| | | | | ±0.1pF | GRM1885C1H3R3BA01# |
| | | | | ±0.25pF | GRM1885C1H3R3CA01# |
| | | | 3.4pF | ±0.05pF | GRM1885C1H3R4WA01# |
| | | | | ±0.1pF | GRM1885C1H3R4BA01# |
| | | | | ±0.25pF | GRM1885C1H3R4CA01# |
| | | | 3.5pF | ±0.05pF | GRM1885C1H3R5WA01# |
| | | | | ±0.1pF | GRM1885C1H3R5BA01# |
| | | | | ±0.25pF | GRM1885C1H3R5CA01# |
| | | | 3.6pF | ±0.05pF | GRM1885C1H3R6WA01# |
| | | | | ±0.1pF | GRM1885C1H3R6BA01# |
| | | | | ±0.25pF | GRM1885C1H3R6CA01# |
| | | | 3.7pF | ±0.05pF | GRM1885C1H3R7WA01# |
| | | | | ±0.1pF | GRM1885C1H3R7BA01# |
| | | | | ±0.25pF | GRM1885C1H3R7CA01# |
| | | | 3.8pF | ±0.05pF | GRM1885C1H3R8WA01# |
| | | | | ±0.1pF | GRM1885C1H3R8BA01# |
| | | | | ±0.25pF | GRM1885C1H3R8CA01# |
| | | | 3.9pF | ±0.05pF | GRM1885C1H3R9WA01# |
| | | | | ±0.1pF | GRM1885C1H3R9BA01# |
| | | | | ±0.25pF | GRM1885C1H3R9CA01# |
| | | | 4.0pF | ±0.05pF | GRM1885C1H4R0WA01# |
| | | | | ±0.1pF | GRM1885C1H4R0BA01# |
| | | | | ±0.25pF | GRM1885C1H4R0CA01# |
| | | | 4.1pF | ±0.05pF | GRM1885C1H4R1WA01# |
| | | | | ±0.1pF | GRM1885C1H4R1BA01# |
| | | | | ±0.25pF | GRM1885C1H4R1CA01# |
| | | | 4.2pF | ±0.05pF | GRM1885C1H4R2WA01# |
| | | | | ±0.1pF | GRM1885C1H4R2BA01# |
| | | | | ±0.25pF | GRM1885C1H4R2CA01# |
| | | | 4.3pF | ±0.05pF | GRM1885C1H4R3WA01# |
| | | | | ±0.1pF | GRM1885C1H4R3BA01# |
| | | | | ±0.25pF | GRM1885C1H4R3CA01# |
| | | | 4.4pF | ±0.05pF | GRM1885C1H4R4WA01# |
| | | | | ±0.1pF | GRM1885C1H4R4BA01# |
| | | | | ±0.25pF | GRM1885C1H4R4CA01# |
| | | | 4.5pF | ±0.05pF | GRM1885C1H4R5WA01# |
| | | | | ±0.1pF | GRM1885C1H4R5BA01# |
| | | | | ±0.25pF | GRM1885C1H4R5CA01# |
| | | | 4.6pF | ±0.05pF | GRM1885C1H4R6WA01# |
| | | | | ±0.1pF | GRM1885C1H4R6BA01# |
| | | | | ±0.25pF | GRM1885C1H4R6CA01# |
| | | | 4.7pF | ±0.05pF | GRM1885C1H4R7WA01# |
| | | | | ±0.1pF | GRM1885C1H4R7BA01# |
| | | | | ±0.25pF | GRM1885C1H4R7CA01# |
| | | | 4.8pF | ±0.05pF | GRM1885C1H4R8WA01# |
| | | | | ±0.1pF | GRM1885C1H4R8BA01# |
| | | | | ±0.25pF | GRM1885C1H4R8CA01# |
| 4.9pF | ±0.05pF | GRM1885C1H4R9WA01# | | | |
| | ±0.1pF | GRM1885C1H4R9BA01# | | | |
| | ±0.25pF | GRM1885C1H4R9CA01# | | | |
| 5.0pF | ±0.05pF | GRM1885C1H5R0WA01# | | | |

| T max. | Rated Voltage | TC Code | Cap. | Tol. | Part Number |
|--------|---------------|---------|-------|---------|--------------------|
| 0.9mm | 50Vdc | COG | 5.0pF | ±0.1pF | GRM1885C1H5R0BA01# |
| | | | | ±0.25pF | GRM1885C1H5R0CA01# |
| | | | 5.1pF | ±0.05pF | GRM1885C1H5R1WA01# |
| | | | | ±0.1pF | GRM1885C1H5R1BA01# |
| | | | | ±0.25pF | GRM1885C1H5R1CA01# |
| | | | 5.2pF | ±0.05pF | GRM1885C1H5R2WA01# |
| | | | | ±0.1pF | GRM1885C1H5R2BA01# |
| | | | | ±0.25pF | GRM1885C1H5R2CA01# |
| | | | 5.3pF | ±0.05pF | GRM1885C1H5R3WA01# |
| | | | | ±0.1pF | GRM1885C1H5R3BA01# |
| | | | | ±0.25pF | GRM1885C1H5R3CA01# |
| | | | 5.4pF | ±0.05pF | GRM1885C1H5R4WA01# |
| | | | | ±0.1pF | GRM1885C1H5R4BA01# |
| | | | | ±0.25pF | GRM1885C1H5R4CA01# |
| | | | 5.5pF | ±0.05pF | GRM1885C1H5R5WA01# |
| | | | | ±0.1pF | GRM1885C1H5R5BA01# |
| | | | | ±0.25pF | GRM1885C1H5R5CA01# |
| | | | 5.6pF | ±0.05pF | GRM1885C1H5R6WA01# |
| | | | | ±0.1pF | GRM1885C1H5R6BA01# |
| | | | | ±0.25pF | GRM1885C1H5R6CA01# |
| | | | 5.7pF | ±0.05pF | GRM1885C1H5R7WA01# |
| | | | | ±0.1pF | GRM1885C1H5R7BA01# |
| | | | | ±0.25pF | GRM1885C1H5R7CA01# |
| | | | 5.8pF | ±0.05pF | GRM1885C1H5R8WA01# |
| | | | | ±0.1pF | GRM1885C1H5R8BA01# |
| | | | | ±0.25pF | GRM1885C1H5R8CA01# |
| | | | 5.9pF | ±0.05pF | GRM1885C1H5R9WA01# |
| | | | | ±0.1pF | GRM1885C1H5R9BA01# |
| | | | | ±0.25pF | GRM1885C1H5R9CA01# |
| | | | 6.0pF | ±0.05pF | GRM1885C1H6R0WA01# |
| | | | | ±0.1pF | GRM1885C1H6R0BA01# |
| | | | | ±0.25pF | GRM1885C1H6R0CA01# |
| | | | 6.1pF | ±0.05pF | GRM1885C1H6R1WA01# |
| | | | | ±0.1pF | GRM1885C1H6R1BA01# |
| | | | | ±0.25pF | GRM1885C1H6R1CA01# |
| | | | 6.2pF | ±0.05pF | GRM1885C1H6R2WA01# |
| | | | | ±0.1pF | GRM1885C1H6R2BA01# |
| | | | | ±0.25pF | GRM1885C1H6R2CA01# |
| | | | 6.3pF | ±0.05pF | GRM1885C1H6R3WA01# |
| | | | | ±0.1pF | GRM1885C1H6R3BA01# |
| | | | | ±0.25pF | GRM1885C1H6R3CA01# |
| | | | 5.0pF | ±0.5pF | GRM1885C1H6R3DA01# |

Part number # indicates the package specification code.

GRM
 GR3
 GRJ
 GR4
 GR7
 GJM
 GQM
 GA2
 GA3 GB
 GA3 GD
 GA3 GF
 LLL
 LLA
 LLM
 LLR
 NFM
 KRM
 KR3
 GMA
 GMD
 ⚠Caution /Notice

GRM Series Temperature Compensating Type Part Number List

(→ 1.6×0.8mm)

| T max. | Rated Voltage | TC Code | Cap. | Tol. | Part Number | T max. | Rated Voltage | TC Code | Cap. | Tol. | Part Number | |
|--------|---------------|---------|-------|---------|--------------------|--------|---------------|---------|---------|--------------------|--------------------|--------------------|
| 0.9mm | 50Vdc | COG | 6.4pF | ±0.05pF | GRM1885C1H6R4WA01# | 0.9mm | 50Vdc | COG | 7.7pF | ±0.25pF | GRM1885C1H7R7CA01# | |
| | | | | ±0.1pF | GRM1885C1H6R4BA01# | | | | | ±0.5pF | GRM1885C1H7R7DA01# | |
| | | | | ±0.25pF | GRM1885C1H6R4CA01# | | | | | 7.8pF | ±0.05pF | GRM1885C1H7R8WA01# |
| | | | | ±0.5pF | GRM1885C1H6R4DA01# | | | | | | ±0.1pF | GRM1885C1H7R8BA01# |
| | | | 6.5pF | ±0.05pF | GRM1885C1H6R5WA01# | | | | ±0.25pF | GRM1885C1H7R8CA01# | | |
| | | | | ±0.1pF | GRM1885C1H6R5BA01# | | | | ±0.5pF | GRM1885C1H7R8DA01# | | |
| | | | | ±0.25pF | GRM1885C1H6R5CA01# | | | | 7.9pF | ±0.05pF | GRM1885C1H7R9WA01# | |
| | | | | ±0.5pF | GRM1885C1H6R5DA01# | | | | | ±0.1pF | GRM1885C1H7R9BA01# | |
| | | | 6.6pF | ±0.05pF | GRM1885C1H6R6WA01# | | | | ±0.25pF | GRM1885C1H7R9CA01# | | |
| | | | | ±0.1pF | GRM1885C1H6R6BA01# | | | | ±0.5pF | GRM1885C1H7R9DA01# | | |
| | | | | ±0.25pF | GRM1885C1H6R6CA01# | | | | 8.0pF | ±0.05pF | GRM1885C1H8R0WA01# | |
| | | | | ±0.5pF | GRM1885C1H6R6DA01# | | | | | ±0.1pF | GRM1885C1H8R0BA01# | |
| | | | 6.7pF | ±0.05pF | GRM1885C1H6R7WA01# | | | | ±0.25pF | GRM1885C1H8R0CA01# | | |
| | | | | ±0.1pF | GRM1885C1H6R7BA01# | | | | ±0.5pF | GRM1885C1H8R0DA01# | | |
| | | | | ±0.25pF | GRM1885C1H6R7CA01# | | | | 8.1pF | ±0.05pF | GRM1885C1H8R1WA01# | |
| | | | | ±0.5pF | GRM1885C1H6R7DA01# | | | | | ±0.1pF | GRM1885C1H8R1BA01# | |
| | | | 6.8pF | ±0.05pF | GRM1885C1H6R8WA01# | | | | ±0.25pF | GRM1885C1H8R1CA01# | | |
| | | | | ±0.1pF | GRM1885C1H6R8BA01# | | | | ±0.5pF | GRM1885C1H8R1DA01# | | |
| | | | | ±0.25pF | GRM1885C1H6R8CA01# | | | | 8.2pF | ±0.05pF | GRM1885C1H8R2WA01# | |
| | | | | ±0.5pF | GRM1885C1H6R8DA01# | | | | | ±0.1pF | GRM1885C1H8R2BA01# | |
| | | | 6.9pF | ±0.05pF | GRM1885C1H6R9WA01# | | | | ±0.25pF | GRM1885C1H8R2CA01# | | |
| | | | | ±0.1pF | GRM1885C1H6R9BA01# | | | | ±0.5pF | GRM1885C1H8R2DA01# | | |
| | | | | ±0.25pF | GRM1885C1H6R9CA01# | | | | 8.3pF | ±0.05pF | GRM1885C1H8R3WA01# | |
| | | | | ±0.5pF | GRM1885C1H6R9DA01# | | | | | ±0.1pF | GRM1885C1H8R3BA01# | |
| | | | 7.0pF | ±0.05pF | GRM1885C1H7R0WA01# | | | | ±0.25pF | GRM1885C1H8R3CA01# | | |
| | | | | ±0.1pF | GRM1885C1H7R0BA01# | | | | ±0.5pF | GRM1885C1H8R3DA01# | | |
| | | | | ±0.25pF | GRM1885C1H7R0CA01# | | | | 8.4pF | ±0.05pF | GRM1885C1H8R4WA01# | |
| | | | | ±0.5pF | GRM1885C1H7R0DA01# | | | | | ±0.1pF | GRM1885C1H8R4BA01# | |
| | | | 7.1pF | ±0.05pF | GRM1885C1H7R1WA01# | | | | ±0.25pF | GRM1885C1H8R4CA01# | | |
| | | | | ±0.1pF | GRM1885C1H7R1BA01# | | | | ±0.5pF | GRM1885C1H8R4DA01# | | |
| | | | | ±0.25pF | GRM1885C1H7R1CA01# | | | | 8.5pF | ±0.05pF | GRM1885C1H8R5WA01# | |
| | | | | ±0.5pF | GRM1885C1H7R1DA01# | | | | | ±0.1pF | GRM1885C1H8R5BA01# | |
| | | | 7.2pF | ±0.05pF | GRM1885C1H7R2WA01# | | | | ±0.25pF | GRM1885C1H8R5CA01# | | |
| | | | | ±0.1pF | GRM1885C1H7R2BA01# | | | | ±0.5pF | GRM1885C1H8R5DA01# | | |
| | | | | ±0.25pF | GRM1885C1H7R2CA01# | | | | 8.6pF | ±0.05pF | GRM1885C1H8R6WA01# | |
| | | | | ±0.5pF | GRM1885C1H7R2DA01# | | | | | ±0.1pF | GRM1885C1H8R6BA01# | |
| | | | 7.3pF | ±0.05pF | GRM1885C1H7R3WA01# | | | | ±0.25pF | GRM1885C1H8R6CA01# | | |
| | | | | ±0.1pF | GRM1885C1H7R3BA01# | | | | ±0.5pF | GRM1885C1H8R6DA01# | | |
| | | | | ±0.25pF | GRM1885C1H7R3CA01# | | | | 8.7pF | ±0.05pF | GRM1885C1H8R7WA01# | |
| | | | | ±0.5pF | GRM1885C1H7R3DA01# | | | | | ±0.1pF | GRM1885C1H8R7BA01# | |
| | | | 7.4pF | ±0.05pF | GRM1885C1H7R4WA01# | | | | ±0.25pF | GRM1885C1H8R7CA01# | | |
| | | | | ±0.1pF | GRM1885C1H7R4BA01# | | | | ±0.5pF | GRM1885C1H8R7DA01# | | |
| | | | | ±0.25pF | GRM1885C1H7R4CA01# | | | | 8.8pF | ±0.05pF | GRM1885C1H8R8WA01# | |
| | | | | ±0.5pF | GRM1885C1H7R4DA01# | | | | | ±0.1pF | GRM1885C1H8R8BA01# | |
| | | | 7.5pF | ±0.05pF | GRM1885C1H7R5WA01# | | | | ±0.25pF | GRM1885C1H8R8CA01# | | |
| | | | | ±0.1pF | GRM1885C1H7R5BA01# | | | | ±0.5pF | GRM1885C1H8R8DA01# | | |
| | | | | ±0.25pF | GRM1885C1H7R5CA01# | | | | 8.9pF | ±0.05pF | GRM1885C1H8R9WA01# | |
| | | | | ±0.5pF | GRM1885C1H7R5DA01# | | | | | ±0.1pF | GRM1885C1H8R9BA01# | |
| | | | 7.6pF | ±0.05pF | GRM1885C1H7R6WA01# | | | | ±0.25pF | GRM1885C1H8R9CA01# | | |
| | | | | ±0.1pF | GRM1885C1H7R6BA01# | | | | ±0.5pF | GRM1885C1H8R9DA01# | | |
| | | | | ±0.25pF | GRM1885C1H7R6CA01# | | | | 9.0pF | ±0.05pF | GRM1885C1H9R0WA01# | |
| | | | | ±0.5pF | GRM1885C1H7R6DA01# | | | | | ±0.1pF | GRM1885C1H9R0BA01# | |
| | | | 7.7pF | ±0.05pF | GRM1885C1H7R7WA01# | | | | ±0.25pF | GRM1885C1H9R0CA01# | | |
| | | | | ±0.1pF | GRM1885C1H7R7BA01# | | | | ±0.5pF | GRM1885C1H9R0DA01# | | |

GRM
 GR3
 GRJ
 GR4
 GR7
 GJM
 GQM
 GA2
 GA3 GB
 GA3 GD
 GA3 GF
 LLL
 LLA
 LLM
 LLR
 NFM
 KRM
 KR3
 GMA
 GMD
 ⚠Caution /Notice

Part number # indicates the package specification code.

GRM Series Temperature Compensating Type Part Number List

(→ 1.6×0.8mm)

| T max. | Rated Voltage | TC Code | Cap. | Tol. | Part Number | T max. | Rated Voltage | TC Code | Cap. | Tol. | Part Number | |
|--------|---------------|--------------------|---------|--------------------|--------------------|--------|---------------|---------|---------|--------------------|--------------------|--------------------|
| 0.9mm | 50Vdc | COG | 9.1pF | ±0.05pF | GRM1885C1H9R1WA01# | 0.9mm | 50Vdc | COG | 330pF | ±5% | GRM1885C1H331JA01# | |
| | | | | ±0.1pF | GRM1885C1H9R1BA01# | | | | | 390pF | ±5% | GRM1885C1H391JA01# |
| | | | | ±0.25pF | GRM1885C1H9R1CA01# | | | | | 470pF | ±5% | GRM1885C1H471JA01# |
| | | | | ±0.5pF | GRM1885C1H9R1DA01# | | | | | 560pF | ±5% | GRM1885C1H561JA01# |
| | | | 9.2pF | ±0.05pF | GRM1885C1H9R2WA01# | | | | 680pF | ±5% | GRM1885C1H681JA01# | |
| | | | | ±0.1pF | GRM1885C1H9R2BA01# | | | | 820pF | ±5% | GRM1885C1H821JA01# | |
| | | | | ±0.25pF | GRM1885C1H9R2CA01# | | | | 1000pF | ±5% | GRM1885C1H102JA01# | |
| | | | | ±0.5pF | GRM1885C1H9R2DA01# | | | | 1200pF | ±5% | GRM1885C1H122JA01# | |
| | | | 9.3pF | ±0.05pF | GRM1885C1H9R3WA01# | | | | 1500pF | ±5% | GRM1885C1H152JA01# | |
| | | | | ±0.1pF | GRM1885C1H9R3BA01# | | | | 1800pF | ±5% | GRM1885C1H182JA01# | |
| | | | | ±0.25pF | GRM1885C1H9R3CA01# | | | | 2200pF | ±5% | GRM1885C1H222JA01# | |
| | | | | ±0.5pF | GRM1885C1H9R3DA01# | | | | 2700pF | ±5% | GRM1885C1H272JA01# | |
| | | | 9.4pF | ±0.05pF | GRM1885C1H9R4WA01# | | | | 3300pF | ±5% | GRM1885C1H332JA01# | |
| | | | | ±0.1pF | GRM1885C1H9R4BA01# | | | | 3900pF | ±5% | GRM1885C1H392JA01# | |
| | | | | ±0.25pF | GRM1885C1H9R4CA01# | | | | 4700pF | ±5% | GRM1885C1H472JA01# | |
| | | | | ±0.5pF | GRM1885C1H9R4DA01# | | | | 5600pF | ±5% | GRM1885C1H562JA01# | |
| | | | 9.5pF | ±0.05pF | GRM1885C1H9R5WA01# | | | | 6800pF | ±5% | GRM1885C1H682JA01# | |
| | | | | ±0.1pF | GRM1885C1H9R5BA01# | | | | 8200pF | ±5% | GRM1885C1H822JA01# | |
| | | | | ±0.25pF | GRM1885C1H9R5CA01# | | | | 10000pF | ±5% | GRM1885C1H103JA01# | |
| | | | | ±0.5pF | GRM1885C1H9R5DA01# | | | | CK | 0.50pF | ±0.05pF | GRM1884C1HR50WA01# |
| | | | 9.6pF | ±0.05pF | GRM1885C1H9R6WA01# | | | | | ±0.1pF | GRM1884C1HR50BA01# | |
| | | | | ±0.1pF | GRM1885C1H9R6BA01# | | | | | 0.60pF | ±0.05pF | GRM1884C1HR60WA01# |
| | | | | ±0.25pF | GRM1885C1H9R6CA01# | | | | | ±0.1pF | GRM1884C1HR60BA01# | |
| | | | | ±0.5pF | GRM1885C1H9R6DA01# | | | | 0.70pF | ±0.05pF | GRM1884C1HR70WA01# | |
| | | | 9.7pF | ±0.05pF | GRM1885C1H9R7WA01# | | | | ±0.1pF | GRM1884C1HR70BA01# | | |
| | | | | ±0.1pF | GRM1885C1H9R7BA01# | | | | 0.80pF | ±0.05pF | GRM1884C1HR80WA01# | |
| | | | | ±0.25pF | GRM1885C1H9R7CA01# | | | | ±0.1pF | GRM1884C1HR80BA01# | | |
| | | | | ±0.5pF | GRM1885C1H9R7DA01# | | | | 0.90pF | ±0.05pF | GRM1884C1HR90WA01# | |
| | | | 9.8pF | ±0.05pF | GRM1885C1H9R8WA01# | | | | ±0.1pF | GRM1884C1HR90BA01# | | |
| | | | | ±0.1pF | GRM1885C1H9R8BA01# | | | | 1.0pF | ±0.05pF | GRM1884C1H1R0WA01# | |
| | | | | ±0.25pF | GRM1885C1H9R8CA01# | | | | ±0.1pF | GRM1884C1H1R0BA01# | | |
| | | | | ±0.5pF | GRM1885C1H9R8DA01# | | | | ±0.25pF | GRM1884C1H1R0CA01# | | |
| | | | 9.9pF | ±0.05pF | GRM1885C1H9R9WA01# | | | | 1.1pF | ±0.05pF | GRM1884C1H1R1WA01# | |
| | | | | ±0.1pF | GRM1885C1H9R9BA01# | | | | ±0.1pF | GRM1884C1H1R1BA01# | | |
| | | | | ±0.25pF | GRM1885C1H9R9CA01# | | | | ±0.25pF | GRM1884C1H1R1CA01# | | |
| | | | | ±0.5pF | GRM1885C1H9R9DA01# | | | | 1.2pF | ±0.05pF | GRM1884C1H1R2WA01# | |
| | | | 10pF | ±5% | GRM1885C1H100JA01# | | | | ±0.1pF | GRM1884C1H1R2BA01# | | |
| | | | 12pF | ±5% | GRM1885C1H120JA01# | | | | ±0.25pF | GRM1884C1H1R2CA01# | | |
| | | | 15pF | ±5% | GRM1885C1H150JA01# | | | | 1.3pF | ±0.05pF | GRM1884C1H1R3WA01# | |
| | | | 18pF | ±5% | GRM1885C1H180JA01# | | | | | ±0.1pF | GRM1884C1H1R3BA01# | |
| | | | 22pF | ±5% | GRM1885C1H220JA01# | | | | | ±0.25pF | GRM1884C1H1R3CA01# | |
| | | | 27pF | ±5% | GRM1885C1H270JA01# | | | | | 1.4pF | ±0.05pF | GRM1884C1H1R4WA01# |
| | | | 33pF | ±5% | GRM1885C1H330JA01# | | | | ±0.1pF | GRM1884C1H1R4BA01# | | |
| | | | 39pF | ±5% | GRM1885C1H390JA01# | | | | ±0.25pF | GRM1884C1H1R4CA01# | | |
| | | | 47pF | ±5% | GRM1885C1H470JA01# | | | | 1.5pF | ±0.05pF | GRM1884C1H1R5WA01# | |
| | | | 56pF | ±5% | GRM1885C1H560JA01# | | | | | ±0.1pF | GRM1884C1H1R5BA01# | |
| | | | 68pF | ±5% | GRM1885C1H680JA01# | | | | | ±0.25pF | GRM1884C1H1R5CA01# | |
| | | | 82pF | ±5% | GRM1885C1H820JA01# | | | | | 1.6pF | ±0.05pF | GRM1884C1H1R6WA01# |
| | | | 100pF | ±5% | GRM1885C1H101JA01# | | | | ±0.1pF | GRM1884C1H1R6BA01# | | |
| | | | 120pF | ±5% | GRM1885C1H121JA01# | | | | ±0.25pF | GRM1884C1H1R6CA01# | | |
| | | | 150pF | ±5% | GRM1885C1H151JA01# | | | | 1.7pF | ±0.05pF | GRM1884C1H1R7WA01# | |
| | | | 180pF | ±5% | GRM1885C1H181JA01# | | | | | ±0.1pF | GRM1884C1H1R7BA01# | |
| 220pF | ±5% | GRM1885C1H221JA01# | ±0.25pF | GRM1884C1H1R7CA01# | | | | | | | | |
| 270pF | ±5% | GRM1885C1H271JA01# | 1.8pF | ±0.05pF | GRM1884C1H1R8WA01# | | | | | | | |

Part number # indicates the package specification code.



GRM Series Temperature Compensating Type Part Number List

(→ 1.6×0.8mm)

| T max. | Rated Voltage | TC Code | Cap. | Tol. | Part Number | T max. | Rated Voltage | TC Code | Cap. | Tol. | Part Number | | | |
|--------|---------------|---------|---------|--------------------|--------------------|---------|--------------------|--------------------|--------------------|---------|--------------------|--------------------|---------|--------------------|
| 0.9mm | 50Vdc | CK | 1.8pF | ±0.1pF | GRM1884C1H1R8BA01# | 0.9mm | 50Vdc | CJ | 3.6pF | ±0.1pF | GRM1883C1H3R6BA01# | | | |
| | | | | ±0.25pF | GRM1884C1H1R8CA01# | | | | | ±0.25pF | GRM1883C1H3R6CA01# | | | |
| | | | | ±0.05pF | GRM1884C1H1R9WA01# | | | | | ±0.05pF | GRM1883C1H3R7WA01# | | | |
| | | | 1.9pF | ±0.1pF | GRM1884C1H1R9BA01# | | | | 3.7pF | ±0.1pF | GRM1883C1H3R7BA01# | | | |
| | | | | ±0.25pF | GRM1884C1H1R9CA01# | | | | | ±0.25pF | GRM1883C1H3R7CA01# | | | |
| | | | | ±0.05pF | GRM1884C1H2R0WA01# | | | | | 3.8pF | ±0.05pF | GRM1883C1H3R8WA01# | | |
| | | | ±0.1pF | GRM1884C1H2R0BA01# | ±0.1pF | | | | GRM1883C1H3R8BA01# | | | | | |
| | | | ±0.25pF | GRM1884C1H2R0CA01# | ±0.25pF | | | | GRM1883C1H3R8CA01# | | | | | |
| | | | CJ | 2.1pF | ±0.05pF | | | | GRM1883C1H2R1WA01# | 3.9pF | ±0.05pF | GRM1883C1H3R9WA01# | | |
| | | | | | ±0.1pF | | | | GRM1883C1H2R1BA01# | | ±0.1pF | GRM1883C1H3R9BA01# | | |
| | | | | | ±0.25pF | | | | GRM1883C1H2R1CA01# | | ±0.25pF | GRM1883C1H3R9CA01# | | |
| | | | | 2.2pF | ±0.05pF | | | | GRM1883C1H2R2WA01# | | CH | 4.0pF | ±0.05pF | GRM1882C1H4R0WA01# |
| | | | | | ±0.1pF | | | | GRM1883C1H2R2BA01# | | | | ±0.1pF | GRM1882C1H4R0BA01# |
| | | | | | ±0.25pF | | | | GRM1883C1H2R2CA01# | | | | ±0.25pF | GRM1882C1H4R0CA01# |
| | | | | 2.3pF | ±0.05pF | | | | GRM1883C1H2R3WA01# | | | 4.1pF | ±0.05pF | GRM1882C1H4R1WA01# |
| | | | | | ±0.1pF | | | | GRM1883C1H2R3BA01# | | | | ±0.1pF | GRM1882C1H4R1BA01# |
| | | | | | ±0.25pF | | | | GRM1883C1H2R3CA01# | | | | ±0.25pF | GRM1882C1H4R1CA01# |
| | | | | 2.4pF | ±0.05pF | | | | GRM1883C1H2R4WA01# | | | 4.2pF | ±0.05pF | GRM1882C1H4R2WA01# |
| | | ±0.1pF | | | GRM1883C1H2R4BA01# | ±0.1pF | GRM1882C1H4R2BA01# | | | | | | | |
| | | ±0.25pF | | | GRM1883C1H2R4CA01# | ±0.25pF | GRM1882C1H4R2CA01# | | | | | | | |
| | | 2.5pF | | ±0.05pF | GRM1883C1H2R5WA01# | 4.3pF | ±0.05pF | GRM1882C1H4R3WA01# | | | | | | |
| | | | | ±0.1pF | GRM1883C1H2R5BA01# | | ±0.1pF | GRM1882C1H4R3BA01# | | | | | | |
| | | | | ±0.25pF | GRM1883C1H2R5CA01# | | ±0.25pF | GRM1882C1H4R3CA01# | | | | | | |
| | | 2.6pF | | ±0.05pF | GRM1883C1H2R6WA01# | 4.4pF | ±0.05pF | GRM1882C1H4R4WA01# | | | | | | |
| | | | | ±0.1pF | GRM1883C1H2R6BA01# | | ±0.1pF | GRM1882C1H4R4BA01# | | | | | | |
| | | | | ±0.25pF | GRM1883C1H2R6CA01# | | ±0.25pF | GRM1882C1H4R4CA01# | | | | | | |
| | | 2.7pF | ±0.05pF | GRM1883C1H2R7WA01# | 4.5pF | ±0.05pF | GRM1882C1H4R5WA01# | | | | | | | |
| | | | ±0.1pF | GRM1883C1H2R7BA01# | | ±0.1pF | GRM1882C1H4R5BA01# | | | | | | | |
| | | | ±0.25pF | GRM1883C1H2R7CA01# | | ±0.25pF | GRM1882C1H4R5CA01# | | | | | | | |
| | | 2.8pF | ±0.05pF | GRM1883C1H2R8WA01# | 4.6pF | ±0.05pF | GRM1882C1H4R6WA01# | | | | | | | |
| | | | ±0.1pF | GRM1883C1H2R8BA01# | | ±0.1pF | GRM1882C1H4R6BA01# | | | | | | | |
| | | | ±0.25pF | GRM1883C1H2R8CA01# | | ±0.25pF | GRM1882C1H4R6CA01# | | | | | | | |
| | | 2.9pF | ±0.05pF | GRM1883C1H2R9WA01# | 4.7pF | ±0.05pF | GRM1882C1H4R7WA01# | | | | | | | |
| | | | ±0.1pF | GRM1883C1H2R9BA01# | | ±0.1pF | GRM1882C1H4R7BA01# | | | | | | | |
| | | | ±0.25pF | GRM1883C1H2R9CA01# | | ±0.25pF | GRM1882C1H4R7CA01# | | | | | | | |
| | | 3.0pF | ±0.05pF | GRM1883C1H3R0WA01# | 4.8pF | ±0.05pF | GRM1882C1H4R8WA01# | | | | | | | |
| | | | ±0.1pF | GRM1883C1H3R0BA01# | | ±0.1pF | GRM1882C1H4R8BA01# | | | | | | | |
| | | | ±0.25pF | GRM1883C1H3R0CA01# | | ±0.25pF | GRM1882C1H4R8CA01# | | | | | | | |
| | | 3.1pF | ±0.05pF | GRM1883C1H3R1WA01# | 4.9pF | ±0.05pF | GRM1882C1H4R9WA01# | | | | | | | |
| | | | ±0.1pF | GRM1883C1H3R1BA01# | | ±0.1pF | GRM1882C1H4R9BA01# | | | | | | | |
| | | | ±0.25pF | GRM1883C1H3R1CA01# | | ±0.25pF | GRM1882C1H4R9CA01# | | | | | | | |
| | | 3.2pF | ±0.05pF | GRM1883C1H3R2WA01# | 5.0pF | ±0.05pF | GRM1882C1H5R0WA01# | | | | | | | |
| | | | ±0.1pF | GRM1883C1H3R2BA01# | | ±0.1pF | GRM1882C1H5R0BA01# | | | | | | | |
| | | | ±0.25pF | GRM1883C1H3R2CA01# | | ±0.25pF | GRM1882C1H5R0CA01# | | | | | | | |
| | | 3.3pF | ±0.05pF | GRM1883C1H3R3WA01# | 5.1pF | ±0.05pF | GRM1882C1H5R1WA01# | | | | | | | |
| | | | ±0.1pF | GRM1883C1H3R3BA01# | | ±0.1pF | GRM1882C1H5R1BA01# | | | | | | | |
| | | | ±0.25pF | GRM1883C1H3R3CA01# | | ±0.25pF | GRM1882C1H5R1CA01# | | | | | | | |
| | | 3.4pF | ±0.05pF | GRM1883C1H3R4WA01# | 5.2pF | ±0.05pF | GRM1882C1H5R2WA01# | | | | | | | |
| | | | ±0.1pF | GRM1883C1H3R4BA01# | | ±0.1pF | GRM1882C1H5R2BA01# | | | | | | | |
| | | | ±0.25pF | GRM1883C1H3R4CA01# | | ±0.25pF | GRM1882C1H5R2CA01# | | | | | | | |
| | | 3.5pF | ±0.05pF | GRM1883C1H3R5WA01# | 5.3pF | ±0.05pF | GRM1882C1H5R3WA01# | | | | | | | |
| | | | ±0.1pF | GRM1883C1H3R5BA01# | | ±0.1pF | GRM1882C1H5R3BA01# | | | | | | | |
| | | | ±0.25pF | GRM1883C1H3R5CA01# | | ±0.25pF | GRM1882C1H5R3CA01# | | | | | | | |

Part number # indicates the package specification code.



GRM Series Temperature Compensating Type Part Number List

(→ 1.6×0.8mm)

| T max. | Rated Voltage | TC Code | Cap. | Tol. | Part Number | T max. | Rated Voltage | TC Code | Cap. | Tol. | Part Number |
|--------|---------------|---------|--------|--------------------|--------------------|---------|---------------|---------|--------------------|--------------------|--------------------|
| 0.9mm | 50Vdc | CH | 5.3pF | ±0.25pF | GRM1882C1H5R3CA01# | 0.9mm | 50Vdc | CH | 6.7pF | ±0.05pF | GRM1882C1H6R7WA01# |
| | | | | ±0.5pF | GRM1882C1H5R3DA01# | | | | | ±0.1pF | GRM1882C1H6R7BA01# |
| | | | 5.4pF | ±0.05pF | GRM1882C1H5R4WA01# | ±0.25pF | | | GRM1882C1H6R7CA01# | | |
| | | | | ±0.1pF | GRM1882C1H5R4BA01# | ±0.5pF | | | GRM1882C1H6R7DA01# | | |
| | | | | ±0.25pF | GRM1882C1H5R4CA01# | 6.8pF | | | ±0.05pF | GRM1882C1H6R8WA01# | |
| | | | | ±0.5pF | GRM1882C1H5R4DA01# | | | | ±0.1pF | GRM1882C1H6R8BA01# | |
| | | | 5.5pF | ±0.05pF | GRM1882C1H5R5WA01# | | | | ±0.25pF | GRM1882C1H6R8CA01# | |
| | | | | ±0.1pF | GRM1882C1H5R5BA01# | ±0.5pF | | | GRM1882C1H6R8DA01# | | |
| | | | | ±0.25pF | GRM1882C1H5R5CA01# | 6.9pF | | | ±0.05pF | GRM1882C1H6R9WA01# | |
| | | | ±0.5pF | GRM1882C1H5R5DA01# | ±0.1pF | | | | GRM1882C1H6R9BA01# | | |
| | | | 5.6pF | ±0.05pF | GRM1882C1H5R6WA01# | | | | ±0.25pF | GRM1882C1H6R9CA01# | |
| | | | | ±0.1pF | GRM1882C1H5R6BA01# | ±0.5pF | | | GRM1882C1H6R9DA01# | | |
| | | | | ±0.25pF | GRM1882C1H5R6CA01# | 7.0pF | | | ±0.05pF | GRM1882C1H7R0WA01# | |
| | | | | ±0.5pF | GRM1882C1H5R6DA01# | | | | ±0.1pF | GRM1882C1H7R0BA01# | |
| | | | 5.7pF | ±0.05pF | GRM1882C1H5R7WA01# | | | | ±0.25pF | GRM1882C1H7R0CA01# | |
| | | | | ±0.1pF | GRM1882C1H5R7BA01# | ±0.5pF | | | GRM1882C1H7R0DA01# | | |
| | | | | ±0.25pF | GRM1882C1H5R7CA01# | 7.1pF | | | ±0.05pF | GRM1882C1H7R1WA01# | |
| | | | | ±0.5pF | GRM1882C1H5R7DA01# | | | | ±0.1pF | GRM1882C1H7R1BA01# | |
| | | | 5.8pF | ±0.05pF | GRM1882C1H5R8WA01# | | | | ±0.25pF | GRM1882C1H7R1CA01# | |
| | | | | ±0.1pF | GRM1882C1H5R8BA01# | ±0.5pF | | | GRM1882C1H7R1DA01# | | |
| | | | | ±0.25pF | GRM1882C1H5R8CA01# | 7.2pF | | | ±0.05pF | GRM1882C1H7R2WA01# | |
| | | | | ±0.5pF | GRM1882C1H5R8DA01# | | | | ±0.1pF | GRM1882C1H7R2BA01# | |
| | | | 5.9pF | ±0.05pF | GRM1882C1H5R9WA01# | | | | ±0.25pF | GRM1882C1H7R2CA01# | |
| | | | | ±0.1pF | GRM1882C1H5R9BA01# | ±0.5pF | | | GRM1882C1H7R2DA01# | | |
| | | | | ±0.25pF | GRM1882C1H5R9CA01# | 7.3pF | | | ±0.05pF | GRM1882C1H7R3WA01# | |
| | | | | ±0.5pF | GRM1882C1H5R9DA01# | | | | ±0.1pF | GRM1882C1H7R3BA01# | |
| | | | 6.0pF | ±0.05pF | GRM1882C1H6R0WA01# | | | | ±0.25pF | GRM1882C1H7R3CA01# | |
| | | | | ±0.1pF | GRM1882C1H6R0BA01# | ±0.5pF | | | GRM1882C1H7R3DA01# | | |
| | | | | ±0.25pF | GRM1882C1H6R0CA01# | 7.4pF | | | ±0.05pF | GRM1882C1H7R4WA01# | |
| | | | | ±0.5pF | GRM1882C1H6R0DA01# | | | | ±0.1pF | GRM1882C1H7R4BA01# | |
| | | | 6.1pF | ±0.05pF | GRM1882C1H6R1WA01# | | | | ±0.25pF | GRM1882C1H7R4CA01# | |
| | | | | ±0.1pF | GRM1882C1H6R1BA01# | ±0.5pF | | | GRM1882C1H7R4DA01# | | |
| | | | | ±0.25pF | GRM1882C1H6R1CA01# | 7.5pF | | | ±0.05pF | GRM1882C1H7R5WA01# | |
| | | | | ±0.5pF | GRM1882C1H6R1DA01# | | | | ±0.1pF | GRM1882C1H7R5BA01# | |
| | | | 6.2pF | ±0.05pF | GRM1882C1H6R2WA01# | | | | ±0.25pF | GRM1882C1H7R5CA01# | |
| | | | | ±0.1pF | GRM1882C1H6R2BA01# | ±0.5pF | | | GRM1882C1H7R5DA01# | | |
| | | | | ±0.25pF | GRM1882C1H6R2CA01# | 7.6pF | | | ±0.05pF | GRM1882C1H7R6WA01# | |
| | | | | ±0.5pF | GRM1882C1H6R2DA01# | | | | ±0.1pF | GRM1882C1H7R6BA01# | |
| | | | 6.3pF | ±0.05pF | GRM1882C1H6R3WA01# | | | | ±0.25pF | GRM1882C1H7R6CA01# | |
| | | | | ±0.1pF | GRM1882C1H6R3BA01# | ±0.5pF | | | GRM1882C1H7R6DA01# | | |
| | | | | ±0.25pF | GRM1882C1H6R3CA01# | 7.7pF | | | ±0.05pF | GRM1882C1H7R7WA01# | |
| | | | | ±0.5pF | GRM1882C1H6R3DA01# | | | | ±0.1pF | GRM1882C1H7R7BA01# | |
| | | | 6.4pF | ±0.05pF | GRM1882C1H6R4WA01# | | | | ±0.25pF | GRM1882C1H7R7CA01# | |
| | | | | ±0.1pF | GRM1882C1H6R4BA01# | ±0.5pF | | | GRM1882C1H7R7DA01# | | |
| | | | | ±0.25pF | GRM1882C1H6R4CA01# | 7.8pF | | | ±0.05pF | GRM1882C1H7R8WA01# | |
| | | | | ±0.5pF | GRM1882C1H6R4DA01# | | | | ±0.1pF | GRM1882C1H7R8BA01# | |
| | | | 6.5pF | ±0.05pF | GRM1882C1H6R5WA01# | | | | ±0.25pF | GRM1882C1H7R8CA01# | |
| | | | | ±0.1pF | GRM1882C1H6R5BA01# | ±0.5pF | | | GRM1882C1H7R8DA01# | | |
| | | | | ±0.25pF | GRM1882C1H6R5CA01# | 7.9pF | | | ±0.05pF | GRM1882C1H7R9WA01# | |
| | | | | ±0.5pF | GRM1882C1H6R5DA01# | | | | ±0.1pF | GRM1882C1H7R9BA01# | |
| | | | 6.6pF | ±0.05pF | GRM1882C1H6R6WA01# | | | | ±0.25pF | GRM1882C1H7R9CA01# | |
| | | | | ±0.1pF | GRM1882C1H6R6BA01# | ±0.5pF | | | GRM1882C1H7R9DA01# | | |
| | | | | ±0.25pF | GRM1882C1H6R6CA01# | 8.0pF | | | ±0.05pF | GRM1882C1H8R0WA01# | |
| | | | | ±0.5pF | GRM1882C1H6R6DA01# | | | | ±0.1pF | GRM1882C1H8R0BA01# | |

Part number # indicates the package specification code.



GRM Series Temperature Compensating Type Part Number List

(→ 1.6×0.8mm)

| T max. | Rated Voltage | TC Code | Cap. | Tol. | Part Number | T max. | Rated Voltage | TC Code | Cap. | Tol. | Part Number |
|--------|---------------|---------|--------|--------------------|--------------------|---------|---------------|---------|--------------------|--------------------|--------------------|
| 0.9mm | 50Vdc | CH | 8.0pF | ±0.25pF | GRM1882C1H8R0CA01# | 0.9mm | 50Vdc | CH | 9.4pF | ±0.05pF | GRM1882C1H9R4WA01# |
| | | | | ±0.5pF | GRM1882C1H8R0DA01# | | | | | ±0.1pF | GRM1882C1H9R4BA01# |
| | | | 8.1pF | ±0.05pF | GRM1882C1H8R1WA01# | ±0.25pF | | | GRM1882C1H9R4CA01# | | |
| | | | | ±0.1pF | GRM1882C1H8R1BA01# | ±0.5pF | | | GRM1882C1H9R4DA01# | | |
| | | | | ±0.25pF | GRM1882C1H8R1CA01# | 9.5pF | | | ±0.05pF | GRM1882C1H9R5WA01# | |
| | | | | ±0.5pF | GRM1882C1H8R1DA01# | | | | ±0.1pF | GRM1882C1H9R5BA01# | |
| | | | 8.2pF | ±0.05pF | GRM1882C1H8R2WA01# | | | | ±0.25pF | GRM1882C1H9R5CA01# | |
| | | | | ±0.1pF | GRM1882C1H8R2BA01# | ±0.5pF | | | GRM1882C1H9R5DA01# | | |
| | | | | ±0.25pF | GRM1882C1H8R2CA01# | 9.6pF | | | ±0.05pF | GRM1882C1H9R6WA01# | |
| | | | ±0.5pF | GRM1882C1H8R2DA01# | ±0.1pF | | | | GRM1882C1H9R6BA01# | | |
| | | | 8.3pF | ±0.05pF | GRM1882C1H8R3WA01# | | | | ±0.25pF | GRM1882C1H9R6CA01# | |
| | | | | ±0.1pF | GRM1882C1H8R3BA01# | ±0.5pF | | | GRM1882C1H9R6DA01# | | |
| | | | | ±0.25pF | GRM1882C1H8R3CA01# | 9.7pF | | | ±0.05pF | GRM1882C1H9R7WA01# | |
| | | | | ±0.5pF | GRM1882C1H8R3DA01# | | | | ±0.1pF | GRM1882C1H9R7BA01# | |
| | | | 8.4pF | ±0.05pF | GRM1882C1H8R4WA01# | | | | ±0.25pF | GRM1882C1H9R7CA01# | |
| | | | | ±0.1pF | GRM1882C1H8R4BA01# | ±0.5pF | | | GRM1882C1H9R7DA01# | | |
| | | | | ±0.25pF | GRM1882C1H8R4CA01# | 9.8pF | | | ±0.05pF | GRM1882C1H9R8WA01# | |
| | | | | ±0.5pF | GRM1882C1H8R4DA01# | | | | ±0.1pF | GRM1882C1H9R8BA01# | |
| | | | 8.5pF | ±0.05pF | GRM1882C1H8R5WA01# | | | | ±0.25pF | GRM1882C1H9R8CA01# | |
| | | | | ±0.1pF | GRM1882C1H8R5BA01# | ±0.5pF | | | GRM1882C1H9R8DA01# | | |
| | | | | ±0.25pF | GRM1882C1H8R5CA01# | 9.9pF | | | ±0.05pF | GRM1882C1H9R9WA01# | |
| | | | | ±0.5pF | GRM1882C1H8R5DA01# | | | | ±0.1pF | GRM1882C1H9R9BA01# | |
| | | | 8.6pF | ±0.05pF | GRM1882C1H8R6WA01# | | | | ±0.25pF | GRM1882C1H9R9CA01# | |
| | | | | ±0.1pF | GRM1882C1H8R6BA01# | ±0.5pF | | | GRM1882C1H9R9DA01# | | |
| | | | | ±0.25pF | GRM1882C1H8R6CA01# | 10pF | | | ±5% | GRM1882C1H100JA01# | |
| | | | | ±0.5pF | GRM1882C1H8R6DA01# | | | | 12pF | ±5% | GRM1882C1H120JA01# |
| | | | 8.7pF | ±0.05pF | GRM1882C1H8R7WA01# | | | | | 15pF | ±5% |
| | | | | ±0.1pF | GRM1882C1H8R7BA01# | 18pF | | | | | ±5% |
| | | | | ±0.25pF | GRM1882C1H8R7CA01# | | | | 22pF | | ±5% |
| | | | | ±0.5pF | GRM1882C1H8R7DA01# | | | | | 27pF | ±5% |
| | | | 8.8pF | ±0.05pF | GRM1882C1H8R8WA01# | 33pF | | | | | ±5% |
| | | | | ±0.1pF | GRM1882C1H8R8BA01# | | | | 39pF | | ±5% |
| | | | | ±0.25pF | GRM1882C1H8R8CA01# | | | | | 47pF | ±5% |
| | | | | ±0.5pF | GRM1882C1H8R8DA01# | 56pF | | | | | ±5% |
| | | | 8.9pF | ±0.05pF | GRM1882C1H8R9WA01# | | | | 68pF | | ±5% |
| | | | | ±0.1pF | GRM1882C1H8R9BA01# | | | | | 82pF | ±5% |
| | | | | ±0.25pF | GRM1882C1H8R9CA01# | 100pF | | | | | ±5% |
| | | | | ±0.5pF | GRM1882C1H8R9DA01# | | | | 120pF | | ±5% |
| | | | 9.0pF | ±0.05pF | GRM1882C1H9R0WA01# | | | | | 150pF | ±5% |
| | | | | ±0.1pF | GRM1882C1H9R0BA01# | 180pF | | | | | ±5% |
| | | | | ±0.25pF | GRM1882C1H9R0CA01# | | | | 220pF | | ±5% |
| | | | | ±0.5pF | GRM1882C1H9R0DA01# | | | | | 270pF | ±5% |
| | | | 9.1pF | ±0.05pF | GRM1882C1H9R1WA01# | 330pF | | | | | ±5% |
| | | | | ±0.1pF | GRM1882C1H9R1BA01# | | | | 390pF | | ±5% |
| | | | | ±0.25pF | GRM1882C1H9R1CA01# | | | | | 470pF | ±5% |
| | | | | ±0.5pF | GRM1882C1H9R1DA01# | 560pF | | | | | ±5% |
| | | | 9.2pF | ±0.05pF | GRM1882C1H9R2WA01# | | | | 680pF | | ±5% |
| | | | | ±0.1pF | GRM1882C1H9R2BA01# | | | | | 820pF | ±5% |
| | | | | ±0.25pF | GRM1882C1H9R2CA01# | 1000pF | | | | | ±5% |
| | | | | ±0.5pF | GRM1882C1H9R2DA01# | | | | 1200pF | | ±5% |
| | | | 9.3pF | ±0.05pF | GRM1882C1H9R3WA01# | | | | | 1500pF | ±5% |
| | | | | ±0.1pF | GRM1882C1H9R3BA01# | 1800pF | | | | | ±5% |
| | | | | ±0.25pF | GRM1882C1H9R3CA01# | | | | 2200pF | | ±5% |
| | | | | ±0.5pF | GRM1882C1H9R3DA01# | | | | | 2700pF | ±5% |

GRM
 GR3
 GRJ
 GR4
 GR7
 GJM
 GQM
 GA2
 GA3 GB
 GA3 GD
 GA3 GF
 LLL
 LLA
 LLM
 LLR
 NFM
 KRM
 KR3
 GMA
 GMD
 ⚠Caution /Notice

Part number # indicates the package specification code.

GRM Series Temperature Compensating Type Part Number List

(→ 1.6×0.8mm)

| T max. | Rated Voltage | TC Code | Cap. | Tol. | Part Number |
|--------|---------------|---------|--------------------|--------------------|--------------------|
| 0.9mm | 50Vdc | CH | 3300pF | ±5% | GRM1882C1H332JA01# |
| | | | 3900pF | ±5% | GRM1882C1H392JA01# |
| | | | 4700pF | ±5% | GRM1882C1H472JA01# |
| | | | 5600pF | ±5% | GRM1882C1H562JA01# |
| | | | 6800pF | ±5% | GRM1882C1H682JA01# |
| | | | 8200pF | ±5% | GRM1882C1H822JA01# |
| | | | 10000pF | ±5% | GRM1882C1H103JA01# |
| | | SL | 1200pF | ±5% | GRM1881X1H122JA01# |
| | | | 1500pF | ±5% | GRM1881X1H152JA01# |
| | | | 1800pF | ±5% | GRM1881X1H182JA01# |
| | | | 2200pF | ±5% | GRM1881X1H222JA01# |
| | | | 2700pF | ±5% | GRM1881X1H272JA01# |
| | | | 3300pF | ±5% | GRM1881X1H332JA01# |
| | | | 3900pF | ±5% | GRM1881X1H392JA01# |
| | | | 4700pF | ±5% | GRM1881X1H472JA01# |
| | | | 5600pF | ±5% | GRM1881X1H562JA01# |
| | | | 6800pF | ±5% | GRM1881X1H682JA01# |
| | | U2J | 1200pF | ±5% | GRM1887U1H122JA01# |
| | | | 1500pF | ±5% | GRM1887U1H152JA01# |
| | | | 1800pF | ±5% | GRM1887U1H182JA01# |
| | | | 2200pF | ±5% | GRM1887U1H222JA01# |
| | | | 2700pF | ±5% | GRM1887U1H272JA01# |
| | | | 3300pF | ±5% | GRM1887U1H332JA01# |
| | | | 3900pF | ±5% | GRM1887U1H392JA01# |
| | | | 4700pF | ±5% | GRM1887U1H472JA01# |
| | | | 5600pF | ±5% | GRM1887U1H562JA01# |
| | | | 6800pF | ±5% | GRM1887U1H682JA01# |
| UJ | 1000pF | ±5% | GRM1883U1H102JA01# | | |
| | 1200pF | ±5% | GRM1883U1H122JA01# | | |
| | 1500pF | ±5% | GRM1883U1H152JA01# | | |
| | 1800pF | ±5% | GRM1883U1H182JA01# | | |
| | 2200pF | ±5% | GRM1883U1H222JA01# | | |
| | 2700pF | ±5% | GRM1883U1H272JA01# | | |
| | 3300pF | ±5% | GRM1883U1H332JA01# | | |
| | 3900pF | ±5% | GRM1883U1H392JA01# | | |
| | 4700pF | ±5% | GRM1883U1H472JA01# | | |
| | 5600pF | ±5% | GRM1883U1H562JA01# | | |
| 10Vdc | SL | 12000pF | ±5% | GRM1881X1A123JA01# | |
| | | 15000pF | ±5% | GRM1881X1A153JA01# | |
| | | 18000pF | ±5% | GRM1881X1A183JA01# | |
| | | 22000pF | ±5% | GRM1881X1A223JA01# | |
| | U2J | 12000pF | ±5% | GRM1887U1A123JA01# | |
| | | 15000pF | ±5% | GRM1887U1A153JA01# | |
| | | 18000pF | ±5% | GRM1887U1A183JA01# | |
| | | 22000pF | ±5% | GRM1887U1A223JA01# | |
| | UJ | 12000pF | ±5% | GRM1883U1A123JA01# | |
| | | 15000pF | ±5% | GRM1883U1A153JA01# | |

| T max. | Rated Voltage | TC Code | Cap. | Tol. | Part Number |
|--------|---------------|---------|---------|------|--------------------|
| 0.9mm | 10Vdc | UJ | 18000pF | ±5% | GRM1883U1A183JA01# |
| | | | 22000pF | ±5% | GRM1883U1A223JA01# |

2.0×1.25mm

| T max. | Rated Voltage | TC Code | Cap. | Tol. | Part Number |
|--------|---------------|---------|--------|--------------------|--------------------|
| 0.7mm | 100Vdc | COG | 100pF | ±5% | GRM2165C2A101JA01# |
| | | | 120pF | ±5% | GRM2165C2A121JA01# |
| | | | 150pF | ±5% | GRM2165C2A151JA01# |
| | | | 180pF | ±5% | GRM2165C2A181JA01# |
| | | | 220pF | ±5% | GRM2165C2A221JA01# |
| | | | 270pF | ±5% | GRM2165C2A271JA01# |
| | | | 330pF | ±5% | GRM2165C2A331JA01# |
| | | | 390pF | ±5% | GRM2165C2A391JA01# |
| | | | 470pF | ±5% | GRM2165C2A471JA01# |
| | | | 560pF | ±5% | GRM2165C2A561JA01# |
| | | | 680pF | ±5% | GRM2165C2A681JA01# |
| | | | 820pF | ±5% | GRM2165C2A821JA01# |
| | | | 1000pF | ±5% | GRM2165C2A102JA01# |
| | | | 1200pF | ±5% | GRM2165C2A122JA01# |
| | | | 1500pF | ±5% | GRM2165C2A152JA01# |
| | | | 1800pF | ±5% | GRM2165C2A182JA01# |
| | | | 2200pF | ±5% | GRM2165C2A222JA01# |
| | | | 2700pF | ±5% | GRM2165C2A272JA01# |
| | | | 3300pF | ±5% | GRM2165C2A332JA01# |
| | | | CH | 100pF | ±5% |
| | | 120pF | | ±5% | GRM2162C2A121JA01# |
| | | 150pF | | ±5% | GRM2162C2A151JA01# |
| | | 180pF | | ±5% | GRM2162C2A181JA01# |
| | | 220pF | | ±5% | GRM2162C2A221JA01# |
| | | 270pF | | ±5% | GRM2162C2A271JA01# |
| | | 330pF | | ±5% | GRM2162C2A331JA01# |
| | | 390pF | | ±5% | GRM2162C2A391JA01# |
| | | 470pF | | ±5% | GRM2162C2A471JA01# |
| | | 560pF | | ±5% | GRM2162C2A561JA01# |
| | | 680pF | | ±5% | GRM2162C2A681JA01# |
| | | 820pF | | ±5% | GRM2162C2A821JA01# |
| | | 1000pF | | ±5% | GRM2162C2A102JA01# |
| | | 50Vdc | COG | 1200pF | ±5% |
| 1500pF | ±5% | | | GRM2165C1H152JA01# | |
| 1800pF | ±5% | | | GRM2165C1H182JA01# | |
| 2200pF | ±5% | | | GRM2165C1H222JA01# | |
| 2700pF | ±5% | | | GRM2165C1H272JA01# | |
| 3300pF | ±5% | | | GRM2165C1H332JA01# | |
| 3900pF | ±5% | | | GRM2165C1H392JA01# | |
| 4700pF | ±5% | | | GRM2165C1H472JA01# | |
| CH | 1200pF | | | ±5% | GRM2162C1H122JA01# |

Part number # indicates the package specification code.

GRM Series Temperature Compensating Type Part Number List

(→ 2.0×1.25mm)

| T max. | Rated Voltage | TC Code | Cap. | Tol. | Part Number | T max. | Rated Voltage | TC Code | Cap. | Tol. | Part Number | | |
|---------|---------------|--------------------|--------------------|--------------------|--------------------|--------------------|--------------------|--------------------|--------------------|--------------------|--------------------|--------------------|--------------------|
| 0.7mm | 50Vdc | CH | 1500pF | ±5% | GRM2162C1H152JA01# | 1.0mm | 630Vdc | COG | 220pF | ±5% | GRM21A5C2J221JWA1# | | |
| | | | 1800pF | ±5% | GRM2162C1H182JA01# | | | | 270pF | ±5% | GRM21A5C2J271JWA1# | | |
| | | | 2200pF | ±5% | GRM2162C1H222JA01# | | | | 330pF | ±5% | GRM21A5C2J331JWA1# | | |
| | | | 2700pF | ±5% | GRM2162C1H272JA01# | | | | 390pF | ±5% | GRM21A5C2J391JWA1# | | |
| | | | 3300pF | ±5% | GRM2162C1H332JA01# | | | | 470pF | ±5% | GRM21A5C2J471JWA1# | | |
| | | | 3900pF | ±5% | GRM2162C1H392JA01# | | | | 560pF | ±5% | GRM21A5C2J561JWA1# | | |
| | | | 4700pF | ±5% | GRM2162C1H472JA01# | | | | 250Vdc | COG | 10pF | ±5% | GRM21A5C2E100JW01# |
| | | SL | 12000pF | ±5% | GRM2161X1H123JA01# | | | | | | 12pF | ±5% | GRM21A5C2E120JW01# |
| | | | 15000pF | ±5% | GRM2161X1H153JA01# | | | | | | 15pF | ±5% | GRM21A5C2E150JW01# |
| | | | 18000pF | ±5% | GRM2161X1H183JA01# | | | | | | 18pF | ±5% | GRM21A5C2E180JW01# |
| | | U2J | 12000pF | ±5% | GRM2167U1H123JA01# | | | | | | 22pF | ±5% | GRM21A5C2E220JW01# |
| | | | 15000pF | ±5% | GRM2167U1H153JA01# | | | | | | 27pF | ±5% | GRM21A5C2E270JW01# |
| | | | 18000pF | ±5% | GRM2167U1H183JA01# | | | | | | 33pF | ±5% | GRM21A5C2E330JW01# |
| | | UJ | 10000pF | ±5% | GRM2163U1H103JA01# | | | | 39pF | ±5% | GRM21A5C2E390JW01# | | |
| | | | 12000pF | ±5% | GRM2163U1H123JA01# | | | 47pF | ±5% | GRM21A5C2E470JW01# | | | |
| | | | 15000pF | ±5% | GRM2163U1H153JA01# | | | 56pF | ±5% | GRM21A5C2E560JW01# | | | |
| | | | 18000pF | ±5% | GRM2163U1H183JA01# | | | 68pF | ±5% | GRM21A5C2E680JW01# | | | |
| | | 0.95mm | 50Vdc | COG | 5600pF | | | ±5% | GRM2195C1H562JA01# | 82pF | ±5% | GRM21A5C2E820JW01# | |
| | | | | | 6800pF | | | ±5% | GRM2195C1H682JA01# | 100pF | ±5% | GRM21A5C2E101JW01# | |
| | | | | | 8200pF | | | ±5% | GRM2195C1H822JA01# | 120pF | ±5% | GRM21A5C2E121JW01# | |
| | | | | | 10000pF | | | ±5% | GRM2195C1H103JA01# | 150pF | ±5% | GRM21A5C2E151JW01# | |
| 12000pF | ±5% | | | | GRM2195C1H123JA01# | 180pF | ±5% | GRM21A5C2E181JW01# | | | | | |
| 15000pF | ±5% | | | | GRM2195C1H153JA01# | 220pF | ±5% | GRM21A5C2E221JW01# | | | | | |
| CH | 5600pF | | | ±5% | GRM2192C1H562JA01# | 270pF | ±5% | GRM21A5C2E271JW01# | | | | | |
| | 6800pF | | | ±5% | GRM2192C1H682JA01# | 330pF | ±5% | GRM21A5C2E331JW01# | | | | | |
| | 8200pF | | | ±5% | GRM2192C1H822JA01# | 390pF | ±5% | GRM21A5C2E391JWA1# | | | | | |
| | 10000pF | | | ±5% | GRM2192C1H103JA01# | 470pF | ±5% | GRM21A5C2E471JWA1# | | | | | |
| | 12000pF | | | ±5% | GRM2192C1H123JA01# | 560pF | ±5% | GRM21A5C2E561JWA1# | | | | | |
| | 15000pF | | | ±5% | GRM2192C1H153JA01# | 680pF | ±5% | GRM21A5C2E681JWA1# | | | | | |
| SL | 22000pF | | | ±5% | GRM2191X1H223JA01# | 820pF | ±5% | GRM21A5C2E821JWA1# | | | | | |
| | 27000pF | | | ±5% | GRM2191X1H273JA01# | 1000pF | ±5% | GRM21A5C2E102JWA1# | | | | | |
| U2J | 22000pF | | ±5% | GRM2197U1H223JA01# | 1200pF | ±5% | GRM21A5C2E122JWA1# | | | | | | |
| | 27000pF | | ±5% | GRM2197U1H273JA01# | 1500pF | ±5% | GRM21A5C2E152JWA1# | | | | | | |
| UJ | 22000pF | | ±5% | GRM2193U1H223JA01# | 1800pF | ±5% | GRM21A5C2E182JWA1# | | | | | | |
| | 27000pF | | ±5% | GRM2193U1H273JA01# | 2200pF | ±5% | GRM21A5C2E222JWA1# | | | | | | |
| 10Vdc | SL | | 56000pF | ±5% | GRM2191X1A563JA01# | 2700pF | ±5% | GRM21A5C2E272JWA1# | | | | | |
| | | | U2J | 56000pF | ±5% | GRM2197U1A563JA01# | U2J | 100pF | ±5% | GRM21A7U2E101JW31# | | | |
| | | | UJ | 56000pF | ±5% | GRM2193U1A563JA01# | | 120pF | ±5% | GRM21A7U2E121JW31# | | | |
| | 10pF | ±5% | GRM21A5C2J100JWA1# | 150pF | ±5% | GRM21A7U2E151JW31# | | | | | | | |
| | 12pF | ±5% | GRM21A5C2J120JWA1# | 180pF | ±5% | GRM21A7U2E181JW31# | | | | | | | |
| 15pF | ±5% | GRM21A5C2J150JWA1# | 220pF | ±5% | GRM21A7U2E221JW31# | | | | | | | | |
| 1.0mm | 630Vdc | COG | 18pF | ±5% | GRM21A5C2J180JWA1# | 270pF | ±5% | GRM21A7U2E271JW31# | | | | | |
| | | | 22pF | ±5% | GRM21A5C2J220JWA1# | 330pF | ±5% | GRM21A7U2E331JW31# | | | | | |
| | | | 27pF | ±5% | GRM21A5C2J270JWA1# | 390pF | ±5% | GRM21A7U2E391JW31# | | | | | |
| | | | 33pF | ±5% | GRM21A5C2J330JWA1# | 470pF | ±5% | GRM21A7U2E471JW31# | | | | | |
| | | | 39pF | ±5% | GRM21A5C2J390JWA1# | 560pF | ±5% | GRM21A7U2E561JW31# | | | | | |
| | | | 47pF | ±5% | GRM21A5C2J470JWA1# | 680pF | ±5% | GRM21A7U2E681JW31# | | | | | |
| | | | 56pF | ±5% | GRM21A5C2J560JWA1# | 820pF | ±5% | GRM21A7U2E821JW31# | | | | | |
| | | | 68pF | ±5% | GRM21A5C2J680JWA1# | 1000pF | ±5% | GRM21A7U2E102JW31# | | | | | |
| | | | 82pF | ±5% | GRM21A5C2J820JWA1# | 1200pF | ±5% | GRM21A7U2E122JW31# | | | | | |
| | | | 100pF | ±5% | GRM21A5C2J101JWA1# | 1500pF | ±5% | GRM21A7U2E152JW31# | | | | | |
| | | | 120pF | ±5% | GRM21A5C2J121JWA1# | 1800pF | ±5% | GRM21A7U2E182JW31# | | | | | |
| | | | 150pF | ±5% | GRM21A5C2J151JWA1# | 2200pF | ±5% | GRM21A7U2E222JW31# | | | | | |
| | | | 180pF | ±5% | GRM21A5C2J181JWA1# | 200Vdc | COG | 10pF | ±5% | GRM21A5C2D100JW01# | | | |

Part number # indicates the package specification code.

GRM Series Temperature Compensating Type Part Number List

(→ 2.0×1.25mm)

| T max. | Rated Voltage | TC Code | Cap. | Tol. | Part Number | | | |
|--------|---------------|---------|---------|--------------------|--------------------|--------------------|--------------------|--------------------|
| 1.0mm | 200Vdc | COG | 12pF | ±5% | GRM21A5C2D120JW01# | | | |
| | | | 15pF | ±5% | GRM21A5C2D150JW01# | | | |
| | | | 18pF | ±5% | GRM21A5C2D180JW01# | | | |
| | | | | | | 22pF | ±5% | GRM21A5C2D220JW01# |
| | | | | | | 27pF | ±5% | GRM21A5C2D270JW01# |
| | | | | | | 33pF | ±5% | GRM21A5C2D330JW01# |
| | | | | | | 39pF | ±5% | GRM21A5C2D390JW01# |
| | | | | | | 47pF | ±5% | GRM21A5C2D470JW01# |
| | | | | | | 56pF | ±5% | GRM21A5C2D560JW01# |
| | | | | | | 68pF | ±5% | GRM21A5C2D680JW01# |
| | | | | | | 82pF | ±5% | GRM21A5C2D820JW01# |
| | | | | | | 100pF | ±5% | GRM21A5C2D101JW01# |
| | | | | | | 120pF | ±5% | GRM21A5C2D121JW01# |
| | | | | | | 150pF | ±5% | GRM21A5C2D151JW01# |
| | | | | | | 180pF | ±5% | GRM21A5C2D181JW01# |
| | | | | | | 220pF | ±5% | GRM21A5C2D221JW01# |
| | | | | | | 270pF | ±5% | GRM21A5C2D271JW01# |
| | | | | | | 330pF | ±5% | GRM21A5C2D331JW01# |
| | | | | | U2J | 100pF | ±5% | GRM21A7U2D101JW31# |
| | | | | | | 120pF | ±5% | GRM21A7U2D121JW31# |
| | | | | | | 150pF | ±5% | GRM21A7U2D151JW31# |
| | | | | | | 180pF | ±5% | GRM21A7U2D181JW31# |
| | | | | | | 220pF | ±5% | GRM21A7U2D221JW31# |
| | | | | | | 270pF | ±5% | GRM21A7U2D271JW31# |
| | | | | | | 330pF | ±5% | GRM21A7U2D331JW31# |
| | | | | | | 390pF | ±5% | GRM21A7U2D391JW31# |
| | | | | | | 470pF | ±5% | GRM21A7U2D471JW31# |
| | | | | | | 560pF | ±5% | GRM21A7U2D561JW31# |
| | | | | | | 680pF | ±5% | GRM21A7U2D681JW31# |
| | | | | | | 820pF | ±5% | GRM21A7U2D821JW31# |
| | | | | | 1000pF | ±5% | GRM21A7U2D102JW31# | |
| | | | | | 1200pF | ±5% | GRM21A7U2D122JW31# | |
| | | | | | 1500pF | ±5% | GRM21A7U2D152JW31# | |
| | | | 1800pF | ±5% | GRM21A7U2D182JW31# | | | |
| | | | 2200pF | ±5% | GRM21A7U2D222JW31# | | | |
| | | 50Vdc | SL | 33000pF | ±5% | GRM21A1X1H333JA39# | | |
| | | | U2J | 33000pF | ±5% | GRM21A7U1H333JA39# | | |
| | | | UJ | 33000pF | ±5% | GRM21A3U1H333JA39# | | |
| | 1.35mm | 50Vdc | COG | 18000pF | ±5% | GRM21B5C1H183JA01# | | |
| | | | | 22000pF | ±5% | GRM21B5C1H223JA01# | | |
| | | | | 27000pF | ±5% | GRM21B5C1H273JA01# | | |
| | | | CH | 18000pF | ±5% | GRM21B2C1H183JA01# | | |
| | | | | 22000pF | ±5% | GRM21B2C1H223JA01# | | |
| | | | SL | 39000pF | ±5% | GRM21B1X1H393JA01# | | |
| | | 47000pF | | ±5% | GRM21B1X1H473JA01# | | | |
| U2J | | 39000pF | ±5% | GRM21B7U1H393JA01# | | | | |
| | | 47000pF | ±5% | GRM21B7U1H473JA01# | | | | |
| UJ | | 39000pF | ±5% | GRM21B3U1H393JA01# | | | | |
| | | 47000pF | ±5% | GRM21B3U1H473JA01# | | | | |
| | | 47000pF | ±5% | GRM21B3U1H473JA01# | | | | |
| 10Vdc | | SL | 68000pF | ±5% | GRM21B1X1A683JA01# | | | |
| | | | 82000pF | ±5% | GRM21B1X1A823JA01# | | | |
| | | | 0.10μF | ±5% | GRM21B1X1A104JA01# | | | |
| | U2J | 68000pF | ±5% | GRM21B7U1A683JA01# | | | | |
| | | 82000pF | ±5% | GRM21B7U1A823JA01# | | | | |
| | | 0.10μF | ±5% | GRM21B7U1A104JA01# | | | | |

| T max. | Rated Voltage | TC Code | Cap. | Tol. | Part Number | | |
|--------|---------------|---------|---------|--------------------|--------------------|--------------------|--------------------|
| 1.35mm | 10Vdc | UJ | 68000pF | ±5% | GRM21B3U1A683JA01# | | |
| | | | 82000pF | ±5% | GRM21B3U1A823JA01# | | |
| | | | 0.10μF | ±5% | GRM21B3U1A104JA01# | | |
| 1.45mm | 630Vdc | COG | 680pF | ±5% | GRM21B5C2J681JWA3# | | |
| | | | 820pF | ±5% | GRM21B5C2J821JWA3# | | |
| | | | 1000pF | ±5% | GRM21B5C2J102JWA3# | | |
| | | | 1200pF | ±5% | GRM21B5C2J122JWA3# | | |
| | | | 250Vdc | COG | 3300pF | ±5% | GRM21B5C2E332JWA1# |
| | | | | | 3900pF | ±5% | GRM21B5C2E392JWA1# |
| | 4700pF | ±5% | | | GRM21B5C2E472JWA1# | | |
| | U2J | 2700pF | | | ±5% | GRM21B7U2E272JW32# | |
| | | 3300pF | | | ±5% | GRM21B7U2E332JW32# | |
| | | 3900pF | | | ±5% | GRM21B7U2E392JW32# | |
| | | 4700pF | ±5% | GRM21B7U2E472JW32# | | | |
| | | 5600pF | ±5% | GRM21B7U2E562JW32# | | | |
| 200Vdc | | U2J | 2700pF | ±5% | GRM21B7U2D272JW32# | | |
| | 3300pF | | ±5% | GRM21B7U2D332JW32# | | | |
| | 3900pF | | ±5% | GRM21B7U2D392JW32# | | | |
| | 4700pF | | ±5% | GRM21B7U2D472JW32# | | | |
| | 5600pF | | ±5% | GRM21B7U2D562JW32# | | | |
| | 5600pF | | ±5% | GRM21B7U2D562JW32# | | | |

3.2×1.6mm

| T max. | Rated Voltage | TC Code | Cap. | Tol. | Part Number |
|--------|---------------|---------|---------|------|--------------------|
| 0.95mm | 100Vdc | COG | 1800pF | ±5% | GRM3195C2A182JA01# |
| | | | 2200pF | ±5% | GRM3195C2A222JA01# |
| | | | 2700pF | ±5% | GRM3195C2A272JA01# |
| | | | 3300pF | ±5% | GRM3195C2A332JA01# |
| | | | 3900pF | ±5% | GRM3195C2A392JA01# |
| | | | 4700pF | ±5% | GRM3195C2A472JA01# |
| | | | 5600pF | ±5% | GRM3195C2A562JA01# |
| | | | 6800pF | ±5% | GRM3195C2A682JA01# |
| | | | 8200pF | ±5% | GRM3195C2A822JA01# |
| | | | 10000pF | ±5% | GRM3195C2A103JA01# |
| | | | 12000pF | ±5% | GRM3195C2A123JA01# |
| | | | 15000pF | ±5% | GRM3195C2A153JA01# |
| | | | 18000pF | ±5% | GRM3195C2A183JA01# |
| | | | 22000pF | ±5% | GRM3195C2A223JA01# |
| | | | 27000pF | ±5% | GRM3195C2A273JA01# |
| | | CH | 33000pF | ±5% | GRM3195C2A333JA01# |
| | | | 39000pF | ±5% | GRM3195C2A393JA01# |
| | | | 1800pF | ±5% | GRM3192C2A182JA01# |
| | | | 2200pF | ±5% | GRM3192C2A222JA01# |
| | | | 2700pF | ±5% | GRM3192C2A272JA01# |
| | | | 3300pF | ±5% | GRM3192C2A332JA01# |
| | | | 3900pF | ±5% | GRM3192C2A392JA01# |
| | | | 4700pF | ±5% | GRM3192C2A472JA01# |
| | | | 5600pF | ±5% | GRM3192C2A562JA01# |
| | | | 6800pF | ±5% | GRM3192C2A682JA01# |
| | | | 8200pF | ±5% | GRM3192C2A822JA01# |
| | | | 10000pF | ±5% | GRM3192C2A103JA01# |
| | | | 12000pF | ±5% | GRM3192C2A123JA01# |
| | | | 15000pF | ±5% | GRM3192C2A153JA01# |

Part number # indicates the package specification code.



GRM Series Temperature Compensating Type Part Number List

(→ 3.2×1.6mm)

| T max. | Rated Voltage | TC Code | Cap. | Tol. | Part Number | | T max. | Rated Voltage | TC Code | Cap. | Tol. | Part Number | | | | | |
|---------|---------------|---------|--------------------|--------------------|--------------------|--------------------|--------------------|--------------------|--------------------|--------------------|--------|--------------------|--------------------|------|--------------------|--------------------|--|
| 0.95mm | 100Vdc | CH | 1800pF | ±5% | GRM3192C2A183JA01# | | 1.0mm | 1000Vdc | U2J | 10pF | ±5% | GRM31A7U3A100JW31# | | | | | |
| | | | 2200pF | ±5% | GRM3192C2A223JA01# | | | | | 12pF | ±5% | GRM31A7U3A120JW31# | | | | | |
| | | | 2700pF | ±5% | GRM3192C2A273JA01# | D1 | | | | 15pF | ±5% | GRM31A7U3A150JW31# | | | | | |
| | | | 3300pF | ±5% | GRM3192C2A333JA01# | D1 | | | | 18pF | ±5% | GRM31A7U3A180JW31# | | | | | |
| | | | 3900pF | ±5% | GRM3192C2A393JA01# | D1 | | | | 22pF | ±5% | GRM31A7U3A220JW31# | | | | | |
| | 50Vdc | COG | 12000pF | ±5% | GRM3195C1H123JA01# | | | | | 27pF | ±5% | GRM31A7U3A270JW31# | | | | | |
| | | | 15000pF | ±5% | GRM3195C1H153JA01# | | | | | 33pF | ±5% | GRM31A7U3A330JW31# | | | | | |
| | | | 18000pF | ±5% | GRM3195C1H183JA01# | | | | | 39pF | ±5% | GRM31A7U3A390JW31# | | | | | |
| | | | 22000pF | ±5% | GRM3195C1H223JA01# | | | | | 47pF | ±5% | GRM31A7U3A470JW31# | | | | | |
| | | | 27000pF | ±5% | GRM3195C1H273JA01# | | | | | 56pF | ±5% | GRM31A7U3A560JW31# | | | | | |
| | | | 33000pF | ±5% | GRM3195C1H333JA01# | | | | | 68pF | ±5% | GRM31A7U3A680JW31# | | | | | |
| | | | 39000pF | ±5% | GRM3195C1H393JA01# | | | | | 82pF | ±5% | GRM31A7U3A820JW31# | | | | | |
| | | | CH | 12000pF | ±5% | GRM3192C1H123JA01# | | | | | 100pF | ±5% | GRM31A7U3A101JW31# | | | | |
| | | | | 15000pF | ±5% | GRM3192C1H153JA01# | | | | | 120pF | ±5% | GRM31A7U3A121JW31# | | | | |
| | | | | 18000pF | ±5% | GRM3192C1H183JA01# | | | | | 150pF | ±5% | GRM31A7U3A151JW31# | | | | |
| | | 22000pF | | ±5% | GRM3192C1H223JA01# | | | | | 180pF | ±5% | GRM31A7U3A181JW31# | | | | | |
| | | 27000pF | | ±5% | GRM3192C1H273JA01# | | | | | 220pF | ±5% | GRM31A7U3A221JW31# | | | | | |
| | | 33000pF | | ±5% | GRM3192C1H333JA01# | | | | | 270pF | ±5% | GRM31A7U3A271JW31# | | | | | |
| | | 39000pF | | ±5% | GRM3192C1H393JA01# | | | | | 330pF | ±5% | GRM31A7U3A331JW31# | | | | | |
| | | SL | | 56000pF | ±5% | GRM3191X1H563JA01# | | | | | 630Vdc | COG | 10pF | ±5% | GRM31A5C2J100JW01# | | |
| | | | | U2J | 56000pF | ±5% | | | | GRM3197U1H563JA01# | | | | 12pF | ±5% | GRM31A5C2J120JW01# | |
| | | UJ | | 56000pF | ±5% | GRM3193U1H563JA01# | | | | | | | 15pF | ±5% | GRM31A5C2J150JW01# | | |
| | | 1.0mm | 2000Vdc | U2J | 10pF | ±5% | | | | GRM31A7U3D100JW31# | | | | 18pF | ±5% | GRM31A5C2J180JW01# | |
| | | | | | 12pF | ±5% | | | | GRM31A7U3D120JW31# | | | | 22pF | ±5% | GRM31A5C2J220JW01# | |
| | | | | | 15pF | ±5% | | | | GRM31A7U3D150JW31# | | | | 27pF | ±5% | GRM31A5C2J270JW01# | |
| | 18pF | | | | ±5% | GRM31A7U3D180JW31# | | | | | | | 33pF | ±5% | GRM31A5C2J330JW01# | | |
| | 22pF | | | | ±5% | GRM31A7U3D220JW31# | | | | | | | 39pF | ±5% | GRM31A5C2J390JW01# | | |
| | 27pF | | | | ±5% | GRM31A7U3D270JW31# | | | | | | | 47pF | ±5% | GRM31A5C2J470JW01# | | |
| | 33pF | | | | ±5% | GRM31A7U3D330JW31# | | | | | | | 56pF | ±5% | GRM31A5C2J560JW01# | | |
| | 39pF | | | | ±5% | GRM31A7U3D390JW31# | | | | | | | 68pF | ±5% | GRM31A5C2J680JW01# | | |
| | 47pF | | | | ±5% | GRM31A7U3D470JW31# | | | | | | | 82pF | ±5% | GRM31A5C2J820JW01# | | |
| | 56pF | | | | ±5% | GRM31A7U3D560JW31# | | | | | | | 100pF | ±5% | GRM31A5C2J101JW01# | | |
| | 68pF | | | | ±5% | GRM31A7U3D680JW31# | | | | | | | 120pF | ±5% | GRM31A5C2J121JW01# | | |
| 1000Vdc | COG | | | | 10pF | ±5% | GRM31A5C3A100JW01# | | 150pF | ±5% | | | GRM31A5C2J151JW01# | | | | |
| | | | | | 12pF | ±5% | GRM31A5C3A120JW01# | | 180pF | ±5% | | | GRM31A5C2J181JW01# | | | | |
| | | | 15pF | ±5% | GRM31A5C3A150JW01# | | 220pF | ±5% | GRM31A5C2J221JW01# | | | | | | | | |
| | | | 18pF | ±5% | GRM31A5C3A180JW01# | | 270pF | ±5% | GRM31A5C2J271JW01# | | | | | | | | |
| | | | 22pF | ±5% | GRM31A5C3A220JW01# | | 330pF | ±5% | GRM31A5C2J331JW01# | | | | | | | | |
| | | | 27pF | ±5% | GRM31A5C3A270JW01# | | 390pF | ±5% | GRM31A5C2J391JW01# | | | | | | | | |
| | | | 33pF | ±5% | GRM31A5C3A330JW01# | | 470pF | ±5% | GRM31A5C2J471JW01# | | | | | | | | |
| U2J | 39pF | | ±5% | GRM31A5C3A390JW01# | | 560pF | ±5% | GRM31A5C2J561JW01# | | | | | | | | | |
| | 47pF | | ±5% | GRM31A5C3A470JW01# | | 1200pF | ±5% | GRM31A5C2J122JWA1# | | | | | | | | | |
| | 56pF | ±5% | GRM31A5C3A560JW01# | | 1500pF | ±5% | GRM31A5C2J152JWA1# | | | | | | | | | | |
| | 68pF | ±5% | GRM31A5C3A680JW01# | | 1800pF | ±5% | GRM31A5C2J182JWA1# | | | | | | | | | | |
| | 82pF | ±5% | GRM31A5C3A820JW01# | | U2J | 10pF | ±5% | GRM31A7U2J100JW31# | | | | | | | | | |
| | 100pF | ±5% | GRM31A5C3A101JW01# | | | 12pF | ±5% | GRM31A7U2J120JW31# | | | | | | | | | |
| | 120pF | ±5% | GRM31A5C3A121JW01# | | | 15pF | ±5% | GRM31A7U2J150JW31# | | | | | | | | | |
| | 150pF | ±5% | GRM31A5C3A151JW01# | | | 18pF | ±5% | GRM31A7U2J180JW31# | | | | | | | | | |
| | 180pF | ±5% | GRM31A5C3A181JW01# | | | 22pF | ±5% | GRM31A7U2J220JW31# | | | | | | | | | |
| | 220pF | ±5% | GRM31A5C3A221JW01# | | | 27pF | ±5% | GRM31A7U2J270JW31# | | | | | | | | | |
| | 270pF | ±5% | GRM31A5C3A271JWA1# | | | 33pF | ±5% | GRM31A7U2J330JW31# | | | | | | | | | |
| | 330pF | ±5% | GRM31A5C3A331JWA1# | | | 39pF | ±5% | GRM31A7U2J390JW31# | | | | | | | | | |
| | 390pF | ±5% | GRM31A5C3A391JWA1# | | | 47pF | ±5% | GRM31A7U2J470JW31# | | | | | | | | | |
| | 470pF | ±5% | GRM31A5C3A471JWA1# | | | 56pF | ±5% | GRM31A7U2J560JW31# | | | | | | | | | |

Part number # indicates the package specification code.

GRM Series Temperature Compensating Type Part Number List

(→ 3.2×1.6mm)

| T max. | Rated Voltage | TC Code | Cap. | Tol. | Part Number | T max. | Rated Voltage | TC Code | Cap. | Tol. | Part Number | | | | |
|--------|---------------|--------------------|--------|--------------------|--------------------|--------------------|--------------------|--------------------|--------------------|--------------------|--------------------|--------------------|--------------------|-----|--------------------|
| 1.0mm | 630Vdc | U2J | 68pF | ±5% | GRM31A7U2J680JW31# | 1.0mm | 500Vdc | U2J | 120pF | ±5% | GRM31A7U2H121JW31# | | | | |
| | | | 82pF | ±5% | GRM31A7U2J820JW31# | | | | 150pF | ±5% | GRM31A7U2H151JW31# | | | | |
| | | | 100pF | ±5% | GRM31A7U2J101JW31# | | | | 180pF | ±5% | GRM31A7U2H181JW31# | | | | |
| | | | 120pF | ±5% | GRM31A7U2J121JW31# | | | | 220pF | ±5% | GRM31A7U2H221JW31# | | | | |
| | | | 150pF | ±5% | GRM31A7U2J151JW31# | | | | 270pF | ±5% | GRM31A7U2H271JW31# | | | | |
| | | | 180pF | ±5% | GRM31A7U2J181JW31# | | | | 330pF | ±5% | GRM31A7U2H331JW31# | | | | |
| | | | 220pF | ±5% | GRM31A7U2J221JW31# | | | | 390pF | ±5% | GRM31A7U2H391JW31# | | | | |
| | | | 270pF | ±5% | GRM31A7U2J271JW31# | | | | 470pF | ±5% | GRM31A7U2H471JW31# | | | | |
| | | | 330pF | ±5% | GRM31A7U2J331JW31# | | | | 560pF | ±5% | GRM31A7U2H561JW31# | | | | |
| | | | 390pF | ±5% | GRM31A7U2J391JW31# | | | | 680pF | ±5% | GRM31A7U2H681JW31# | | | | |
| | | | 470pF | ±5% | GRM31A7U2J471JW31# | | | | 820pF | ±5% | GRM31A7U2H821JW31# | | | | |
| | | | 560pF | ±5% | GRM31A7U2J561JW31# | | | | 1000pF | ±5% | GRM31A7U2H102JW31# | | | | |
| | | | 680pF | ±5% | GRM31A7U2J681JW31# | | | | 1200pF | ±5% | GRM31A7U2H122JW31# | | | | |
| | | | 820pF | ±5% | GRM31A7U2J821JW31# | | | | 1500pF | ±5% | GRM31A7U2H152JW31# | | | | |
| | | | 1000pF | ±5% | GRM31A7U2J102JW31# | | | | 1800pF | ±5% | GRM31A7U2H182JW31# | | | | |
| | | | 1200pF | ±5% | GRM31A7U2J122JW31# | | | | 2200pF | ±5% | GRM31A7U2H222JW31# | | | | |
| | | | 1500pF | ±5% | GRM31A7U2J152JW31# | | | | 250Vdc | COG | 390pF | ±5% | GRM31A5C2E391JWA1# | | |
| | | | 1800pF | ±5% | GRM31A7U2J182JW31# | | | | | | 470pF | ±5% | GRM31A5C2E471JWA1# | | |
| | | | 2200pF | ±5% | GRM31A7U2J222JW31# | | | | | | 560pF | ±5% | GRM31A5C2E561JWA1# | | |
| | | | 500Vdc | COG | 10pF | | | | | | ±5% | GRM31A5C2H100JW01# | 680pF | ±5% | GRM31A5C2E681JWA1# |
| | | | | | 12pF | | | | | | ±5% | GRM31A5C2H120JW01# | 820pF | ±5% | GRM31A5C2E821JWA1# |
| | | | | | 15pF | | | | | | ±5% | GRM31A5C2H150JW01# | 1000pF | ±5% | GRM31A5C2E102JWA1# |
| 18pF | ±5% | GRM31A5C2H180JW01# | | | 1200pF | ±5% | GRM31A5C2E122JWA1# | | | | | | | | |
| 22pF | ±5% | GRM31A5C2H220JW01# | | | 1500pF | ±5% | GRM31A5C2E152JWA1# | | | | | | | | |
| 27pF | ±5% | GRM31A5C2H270JW01# | | | 1800pF | ±5% | GRM31A5C2E182JWA1# | | | | | | | | |
| 33pF | ±5% | GRM31A5C2H330JW01# | | | 2200pF | ±5% | GRM31A5C2E222JWA1# | | | | | | | | |
| 39pF | ±5% | GRM31A5C2H390JW01# | | | 2700pF | ±5% | GRM31A5C2E272JWA1# | | | | | | | | |
| 47pF | ±5% | GRM31A5C2H470JW01# | | | 3300pF | ±5% | GRM31A5C2E332JWA1# | | | | | | | | |
| 56pF | ±5% | GRM31A5C2H560JW01# | | | 3900pF | ±5% | GRM31A5C2E392JWA1# | | | | | | | | |
| 68pF | ±5% | GRM31A5C2H680JW01# | | | 4700pF | ±5% | GRM31A5C2E472JWA1# | | | | | | | | |
| 82pF | ±5% | GRM31A5C2H820JW01# | | | 5600pF | ±5% | GRM31A5C2E562JWA1# | | | | | | | | |
| 100pF | ±5% | GRM31A5C2H101JW01# | | | 6800pF | ±5% | GRM31A5C2E682JWA1# | | | | | | | | |
| 120pF | ±5% | GRM31A5C2H121JW01# | | | U2J | 2700pF | ±5% | GRM31A7U2E272JW31# | | | | | | | |
| 150pF | ±5% | GRM31A5C2H151JW01# | | | | 3300pF | ±5% | GRM31A7U2E332JW31# | | | | | | | |
| 180pF | ±5% | GRM31A5C2H181JW01# | | | | 3900pF | ±5% | GRM31A7U2E392JW31# | | | | | | | |
| 220pF | ±5% | GRM31A5C2H221JW01# | | | | 4700pF | ±5% | GRM31A7U2E472JW31# | | | | | | | |
| 270pF | ±5% | GRM31A5C2H271JW01# | | | | 5600pF | ±5% | GRM31A7U2E562JW31# | | | | | | | |
| 330pF | ±5% | GRM31A5C2H331JW01# | | | | 200Vdc | U2J | 2700pF | | | ±5% | GRM31A7U2D272JW31# | | | |
| 390pF | ±5% | GRM31A5C2H391JW01# | | | 3300pF | | | ±5% | GRM31A7U2D332JW31# | | | | | | |
| 470pF | ±5% | GRM31A5C2H471JW01# | | | 3900pF | | | ±5% | GRM31A7U2D392JW31# | | | | | | |
| 560pF | ±5% | GRM31A5C2H561JW01# | | | 4700pF | | | ±5% | GRM31A7U2D472JW31# | | | | | | |
| U2J | U2J | 10pF | ±5% | GRM31A7U2H100JW31# | 5600pF | | | ±5% | GRM31A7U2D562JW31# | | | | | | |
| | | 12pF | ±5% | GRM31A7U2H120JW31# | 1.25mm | | | 1000Vdc | COG | 560pF | ±5% | GRM31B5C3A561JWA1# | | | |
| | | 15pF | ±5% | GRM31A7U2H150JW31# | | 680pF | ±5% | | | GRM31B5C3A681JWA1# | | | | | |
| | | 18pF | ±5% | GRM31A7U2H180JW31# | | U2J | 390pF | | | ±5% | GRM31B7U3A391JW31# | | | | |
| | | 22pF | ±5% | GRM31A7U2H220JW31# | | | 470pF | | | ±5% | GRM31B7U3A471JW31# | | | | |
| | | 27pF | ±5% | GRM31A7U2H270JW31# | | | 560pF | | | ±5% | GRM31B7U3A561JW31# | | | | |
| | | 33pF | ±5% | GRM31A7U2H330JW31# | | | 680pF | | | ±5% | GRM31B7U3A681JW31# | | | | |
| | | 39pF | ±5% | GRM31A7U2H390JW31# | 630Vdc | | COG | 680pF | ±5% | GRM31B5C2J681JW01# | | | | | |
| | | 47pF | ±5% | GRM31A7U2H470JW31# | | | | 820pF | ±5% | GRM31B5C2J821JW01# | | | | | |
| | | 56pF | ±5% | GRM31A7U2H560JW31# | | 1000pF | | ±5% | GRM31B5C2J102JW01# | | | | | | |
| 68pF | ±5% | GRM31A7U2H680JW31# | 2200pF | ±5% | | GRM31B5C2J222JWA1# | | | | | | | | | |
| 82pF | ±5% | GRM31A7U2H820JW31# | 2700pF | ±5% | | GRM31B5C2J272JWA1# | | | | | | | | | |
| 100pF | ±5% | GRM31A7U2H101JW31# | U2J | 2700pF | | ±5% | | GRM31B7U2J272JW31# | | | | | | | |

Part number # indicates the package specification code.



GRM Series Temperature Compensating Type Part Number List

(→ 3.2×1.6mm)

| T max. | Rated Voltage | TC Code | Cap. | Tol. | Part Number | |
|---------|---------------|---------|---------|--------------------|--------------------|--------------------|
| 1.25mm | 630Vdc | U2J | 3300pF | ±5% | GRM31B7U2J332JW31# | |
| | | 500Vdc | COG | 680pF | ±5% | GRM31B5C2H681JW01# |
| | 820pF | | | ±5% | GRM31B5C2H821JW01# | |
| | 1000pF | | | ±5% | GRM31B5C2H102JW01# | |
| | U2J | | 2700pF | ±5% | GRM31B7U2H272JW31# | |
| | 250Vdc | COG | 8200pF | ±5% | GRM31B5C2E822JWA1# | |
| | | | 10000pF | ±5% | GRM31B5C2E103JWA1# | |
| | | | 12000pF | ±5% | GRM31B5C2E123JWA1# | |
| | | U2J | 6800pF | ±5% | GRM31B7U2E682JW31# | |
| | | | 8200pF | ±5% | GRM31B7U2E822JW31# | |
| | | | 10000pF | ±5% | GRM31B7U2E103JW31# | |
| | | | 12000pF | ±5% | GRM31B7U2E123JW31# | |
| | | | 200Vdc | U2J | 6800pF | ±5% |
| | 8200pF | ±5% | | | GRM31B7U2D822JW31# | |
| | 10000pF | ±5% | | | GRM31B7U2D103JW31# | |
| | 100Vdc | COG | 47000pF | ±5% | GRM31M5C2A473JA01# | D1 |
| | | | 56000pF | ±5% | GRM31M5C2A563JA01# | D1 |
| | | CH | 47000pF | ±5% | GRM31M2C2A473JA01# | D1 |
| | | | 56000pF | ±5% | GRM31M2C2A563JA01# | D1 |
| | 50Vdc | COG | 47000pF | ±5% | GRM31M5C1H473JA01# | |
| | | | 56000pF | ±5% | GRM31M5C1H563JA01# | |
| | | CH | 47000pF | ±5% | GRM31M2C1H473JA01# | |
| | | | 56000pF | ±5% | GRM31M2C1H563JA01# | |
| | | SL | 68000pF | ±5% | GRM31M1X1H683JA01# | |
| 82000pF | | | ±5% | GRM31M1X1H823JA01# | | |
| U2J | | 0.10μF | ±5% | GRM31M1X1H104JA01# | | |
| | | 68000pF | ±5% | GRM31M7U1H683JA01# | | |
| | | 82000pF | ±5% | GRM31M7U1H823JA01# | | |
| UJ | | 0.10μF | ±5% | GRM31M7U1H104JA01# | | |
| | | 68000pF | ±5% | GRM31M3U1H683JA01# | | |
| | | 82000pF | ±5% | GRM31M3U1H823JA01# | | |
| 1.8mm | 1000Vdc | COG | 820pF | ±5% | GRM31C5C3A821JWA3# | |
| | | | 1000pF | ±5% | GRM31C5C3A102JWA3# | |
| | | U2J | 820pF | ±5% | GRM31C7U3A821JW32# | |
| | | | 1000pF | ±5% | GRM31C7U3A102JW32# | |
| | 630Vdc | COG | 3300pF | ±5% | GRM31C5C2J332JWA3# | |
| | | | U2J | 3900pF | ±5% | GRM31C7U2J392JW32# |
| | 500Vdc | U2J | 4700pF | ±5% | GRM31C7U2J472JW32# | |
| | | | 3900pF | ±5% | GRM31C7U2H392JW32# | |
| | 250Vdc | COG | 15000pF | ±5% | GRM31C5C2E153JWA3# | |
| | | | U2J | 15000pF | ±5% | GRM31C7U2E153JW32# |
| | 100Vdc | COG | 18000pF | ±5% | GRM31C7U2E183JW32# | |
| | | | 22000pF | ±5% | GRM31C7U2E223JW32# | |
| | | | 68000pF | ±5% | GRM31C5C2A683JA01# | D1 |
| | 50Vdc | COG | 82000pF | ±5% | GRM31C5C2A823JA01# | D1 |
| | | | 0.10μF | ±5% | GRM31C5C2A104JA01# | D1 |
| | | | 68000pF | ±5% | GRM31C2C2A683JA01# | D1 |
| | | | 82000pF | ±5% | GRM31C2C2A823JA01# | D1 |
| | 250Vdc | U2J | 0.10μF | ±5% | GRM31C2C2A104JA01# | D1 |
| 68000pF | | | ±5% | GRM31C5C1H683JA01# | | |
| 50Vdc | COG | 82000pF | ±5% | GRM31C5C1H823JA01# | | |

| T max. | Rated Voltage | TC Code | Cap. | Tol. | Part Number | | |
|--------|---------------|---------|---------|---------|--------------------|--------------------|--|
| 1.8mm | 50Vdc | COG | 0.10μF | ±5% | GRM31C5C1H104JA01# | | |
| | | | CH | 68000pF | ±5% | GRM31C2C1H683JA01# | |
| | | CH | 82000pF | ±5% | GRM31C2C1H823JA01# | | |
| | | | 0.10μF | ±5% | GRM31C2C1H104JA01# | | |
| | 25Vdc | COG | 0.12μF | ±5% | GRM31C5C1E124JA01# | | |
| | | | CH | 0.12μF | ±5% | GRM31C2C1E124JA01# | |
| | 16Vdc | COG | 0.12μF | ±5% | GRM31C5C1C124JA01# | | |
| | | | CH | 0.12μF | ±5% | GRM31C2C1C124JA01# | |

3.2×2.5mm

| T max. | Rated Voltage | TC Code | Cap. | Tol. | Part Number | | |
|---------|---------------|---------|---------|--------------------|--------------------|--------------------|--------------------|
| 1.0mm | 2000Vdc | U2J | 82pF | ±5% | GRM32A7U3D820JW31# | | |
| | | | 100pF | ±5% | GRM32A7U3D101JW31# | | |
| | | | 120pF | ±5% | GRM32A7U3D121JW31# | | |
| | | | 150pF | ±5% | GRM32A7U3D151JW31# | | |
| | 630Vdc | U2J | 1200pF | ±5% | GRM32A7U2J122JW31# | | |
| | | | 1500pF | ±5% | GRM32A7U2J152JW31# | | |
| | | | 1800pF | ±5% | GRM32A7U2J182JW31# | | |
| | | | 2200pF | ±5% | GRM32A7U2J222JW31# | | |
| | 500Vdc | U2J | 1200pF | ±5% | GRM32A7U2H122JW31# | | |
| | | | 1500pF | ±5% | GRM32A7U2H152JW31# | | |
| | | | 1800pF | ±5% | GRM32A7U2H182JW31# | | |
| | | | 2200pF | ±5% | GRM32A7U2H222JW31# | | |
| | 1.25mm | 2000Vdc | U2J | 180pF | ±5% | GRM32B7U3D181JW31# | |
| | | | | 220pF | ±5% | GRM32B7U3D221JW31# | |
| | | 1000Vdc | U2J | 1200pF | ±5% | GRM32B7U3A122JW31# | |
| | | | | 630Vdc | U2J | 5600pF | ±5% |
| | 500Vdc | U2J | 5600pF | ±5% | GRM32B7U2H562JW31# | | |
| | | | 1.5mm | 1000Vdc | U2J | 1500pF | ±5% |
| 630Vdc | U2J | 6800pF | | | | ±5% | GRM32Q7U2J682JW31# |
| 500Vdc | U2J | 6800pF | | ±5% | GRM32Q7U2H682JW31# | | |
| | | 250Vdc | | U2J | 27000pF | ±5% | GRM32Q7U2E273JW31# |
| 2.0mm | 1000Vdc | U2J | 1800pF | ±5% | GRM32D7U3A182JW31# | | |
| | | | 2200pF | ±5% | GRM32D7U3A222JW31# | | |
| | 630Vdc | U2J | 8200pF | ±5% | GRM32D7U2J822JW31# | | |
| | | | 10000pF | ±5% | GRM32D7U2J103JW31# | | |
| | 500Vdc | U2J | 8200pF | ±5% | GRM32D7U2H822JW31# | | |
| | | | 10000pF | ±5% | GRM32D7U2H103JW31# | | |
| | 250Vdc | U2J | 33000pF | ±5% | GRM32D7U2E333JW31# | | |
| | | | 39000pF | ±5% | GRM32D7U2E393JW31# | | |
| 47000pF | | | ±5% | GRM32D7U2E473JW31# | | | |

4.5×2.0mm

| T max. | Rated Voltage | TC Code | Cap. | Tol. | Part Number | |
|--------|---------------|---------|------|------|--------------------|--|
| 1.0mm | 3150Vdc | U2J | 10pF | ±5% | GRM42A7U3F100JW31# | |
| | | | 12pF | ±5% | GRM42A7U3F120JW31# | |
| | | | 15pF | ±5% | GRM42A7U3F150JW31# | |
| | | | 18pF | ±5% | GRM42A7U3F180JW31# | |
| | | | 22pF | ±5% | GRM42A7U3F220JW31# | |
| | | | 27pF | ±5% | GRM42A7U3F270JW31# | |

Part number # indicates the package specification code.

GRM Series Temperature Compensating Type Part Number List

(→ 4.5×2.0mm)

| T max. | Rated Voltage | TC Code | Cap. | Tol. | Part Number |
|--------|---------------|---------|-------|------|--------------------|
| 1.0mm | 3150Vdc | U2J | 33pF | ±5% | GRM42A7U3F330JW31# |
| | | | 39pF | ±5% | GRM42A7U3F390JW31# |
| | | | 47pF | ±5% | GRM42A7U3F470JW31# |
| | | | 56pF | ±5% | GRM42A7U3F560JW31# |
| | | | 68pF | ±5% | GRM42A7U3F680JW31# |
| | | | 82pF | ±5% | GRM42A7U3F820JW31# |
| | | | 100pF | ±5% | GRM42A7U3F101JW31# |

4.5×3.2mm

| T max. | Rated Voltage | TC Code | Cap. | Tol. | Part Number |
|--------|---------------|---------|---------|------|--------------------|
| 1.5mm | 1000Vdc | U2J | 2700pF | ±5% | GRM43Q7U3A272JW31# |
| | | | 3300pF | ±5% | GRM43Q7U3A332JW31# |
| | 630Vdc | U2J | 12000pF | ±5% | GRM43Q7U2J123JW31# |
| | | | 500Vdc | U2J | 12000pF |
| 2.0mm | 1000Vdc | U2J | 3900pF | ±5% | GRM43D7U3A392JW31# |
| | | | 4700pF | ±5% | GRM43D7U3A472JW31# |
| | 630Vdc | U2J | 15000pF | ±5% | GRM43D7U2J153JW31# |
| | | | 18000pF | ±5% | GRM43D7U2J183JW31# |
| | | | 22000pF | ±5% | GRM43D7U2J223JW31# |
| | 500Vdc | U2J | 15000pF | ±5% | GRM43D7U2H153JW31# |
| | | | 18000pF | ±5% | GRM43D7U2H183JW31# |
| | | | 22000pF | ±5% | GRM43D7U2H223JW31# |

5.7×5.0mm

| T max. | Rated Voltage | TC Code | Cap. | Tol. | Part Number |
|--------|---------------|---------|---------|------|--------------------|
| 1.5mm | 1000Vdc | U2J | 5600pF | ±5% | GRM55Q7U3A562JW31# |
| | | | 6800pF | ±5% | GRM55Q7U3A682JW31# |
| | 630Vdc | U2J | 27000pF | ±5% | GRM55Q7U2J273JW31# |
| | | | 500Vdc | U2J | 27000pF |
| 2.0mm | 1000Vdc | U2J | 8200pF | ±5% | GRM55D7U3A822JW31# |
| | | | 10000pF | ±5% | GRM55D7U3A103JW31# |
| | 630Vdc | U2J | 33000pF | ±5% | GRM55D7U2J333JW31# |
| | | | 39000pF | ±5% | GRM55D7U2J393JW31# |
| | | | 47000pF | ±5% | GRM55D7U2J473JW31# |
| | 500Vdc | U2J | 33000pF | ±5% | GRM55D7U2H333JW31# |
| | | | 39000pF | ±5% | GRM55D7U2H393JW31# |
| | | | 47000pF | ±5% | GRM55D7U2H473JW31# |

GRM
 GR3
 GRJ
 GR4
 GR7
 GJM
 GQM
 GA2
 GA3 GB
 GA3 GD
 GA3 GF
 LLL
 LLA
 LLM
 LLR
 NFM
 KRM
 KR3
 GMA
 GMD
 ⚠Caution /Notice

GRM Series High Dielectric Constant Type Part Number List

0.4×0.2mm

| T max. | Rated Voltage | TC Code | Cap. | Tol. | Part Number | | |
|--------|---------------|--------------------|--------|--------------------|--------------------|------|--------------------|
| 0.22mm | 16Vdc | X7R | 100pF | ±10% | GRM022R71C101KE14# | | |
| | | | | ±20% | GRM022R71C101ME14# | | |
| | | | 150pF | ±10% | GRM022R71C151KE14# | | |
| | | | | ±20% | GRM022R71C151ME14# | | |
| | | | 220pF | ±10% | GRM022R71C221KE14# | | |
| | | | | ±20% | GRM022R71C221ME14# | | |
| | | | 330pF | ±10% | GRM022R71C331KE14# | | |
| | | | | ±20% | GRM022R71C331ME14# | | |
| | | | 470pF | ±10% | GRM022R71C471KE14# | | |
| | | | | ±20% | GRM022R71C471ME14# | | |
| | | | 1000pF | ±10% | GRM022R71C102KE14# | | |
| | | | | ±20% | GRM022R71C102ME14# | | |
| | | | 10Vdc | X7R | 100pF | ±10% | GRM022R71A101KA01# |
| | | | | | | ±20% | GRM022R71A101MA01# |
| | | | | | 150pF | ±10% | GRM022R71A151KA01# |
| | | | | | | ±20% | GRM022R71A151MA01# |
| | | | | | 220pF | ±10% | GRM022R71A221KA01# |
| | | | | | | ±20% | GRM022R71A221MA01# |
| | 330pF | ±10% | | | GRM022R71A331KA01# | | |
| | | ±20% | | | GRM022R71A331MA01# | | |
| | 470pF | ±10% | | | GRM022R71A471KA01# | | |
| | | ±20% | | | GRM022R71A471MA01# | | |
| | 680pF | ±10% | | | GRM022R71A681KA12# | | |
| | | ±20% | | | GRM022R71A681MA12# | | |
| | 820pF | ±10% | | | GRM022R71A821KA12# | | |
| | | ±20% | | | GRM022R71A821MA12# | | |
| | 1000pF | ±10% | | | GRM022R71A102KA12# | | |
| | | ±20% | | | GRM022R71A102MA12# | | |
| | X5R | X5R | | | 100pF | ±10% | GRM022R61A101KA01# |
| | | | | | | ±20% | GRM022R61A101MA01# |
| | | | 150pF | ±10% | GRM022R61A151KA01# | | |
| | | | | ±20% | GRM022R61A151MA01# | | |
| | | | 220pF | ±10% | GRM022R61A221KA01# | | |
| | | | | ±20% | GRM022R61A221MA01# | | |
| | | | 330pF | ±10% | GRM022R61A331KA01# | | |
| | | | | ±20% | GRM022R61A331MA01# | | |
| 470pF | | | ±10% | GRM022R61A471KA01# | | | |
| | | | ±20% | GRM022R61A471MA01# | | | |
| 680pF | | | ±10% | GRM022R61A681KE19# | | | |
| | | | ±20% | GRM022R61A681ME19# | | | |
| 1000pF | | | ±10% | GRM022R61A102KE19# | | | |
| | | | ±20% | GRM022R61A102ME19# | | | |
| 1500pF | | | ±10% | GRM022R61A152KE19# | | | |
| | | | ±20% | GRM022R61A152ME19# | | | |
| 2200pF | | | ±10% | GRM022R61A222KE19# | | | |
| | | | ±20% | GRM022R61A222ME19# | | | |
| 3300pF | ±10% | GRM022R61A332KE19# | | | | | |
| | ±20% | GRM022R61A332ME19# | | | | | |
| 4700pF | ±10% | GRM022R61A472KE19# | | | | | |
| | ±20% | GRM022R61A472ME19# | | | | | |
| 6800pF | ±10% | GRM022R61A682KE19# | | | | | |
| | ±20% | GRM022R61A682ME19# | | | | | |

| T max. | Rated Voltage | TC Code | Cap. | Tol. | Part Number | | | |
|---------|---------------|---------|--------------------|--------------------|--------------------|------------------------------|---------|------------------------------|
| 0.22mm | 10Vdc | X5R | 1000pF | ±10% | GRM022R61A103KE19# | | | |
| | | | | ±20% | GRM022R61A103ME19# | | | |
| | | | B | 100pF | ±10% | GRM022B11A101KA01# | | |
| | | | | | ±20% | GRM022B11A101MA01# | | |
| | | | 150pF | ±10% | GRM022B11A151KA01# | | | |
| | | | | ±20% | GRM022B11A151MA01# | | | |
| | | | 220pF | ±10% | GRM022B11A221KA01# | | | |
| | | | | ±20% | GRM022B11A221MA01# | | | |
| | | | 330pF | ±10% | GRM022B11A331KA01# | | | |
| | | | | ±20% | GRM022B11A331MA01# | | | |
| | | | 470pF | ±10% | GRM022B11A471KA01# | | | |
| | | | | ±20% | GRM022B11A471MA01# | | | |
| | | | 680pF | ±10% | GRM022B31A681KE19# | | | |
| | | | | ±20% | GRM022B31A681ME19# | | | |
| | | | 1000pF | ±10% | GRM022B31A102KE19# | | | |
| | | | | ±20% | GRM022B31A102ME19# | | | |
| | | | 1500pF | ±10% | GRM022B31A152KE19# | | | |
| | | | | ±20% | GRM022B31A152ME19# | | | |
| | | 2200pF | ±10% | GRM022B31A222KE19# | | | | |
| | | | ±20% | GRM022B31A222ME19# | | | | |
| | | 3300pF | ±10% | GRM022B31A332KE19# | | | | |
| | | | ±20% | GRM022B31A332ME19# | | | | |
| | | 4700pF | ±10% | GRM022B31A472KE19# | | | | |
| | | | ±20% | GRM022B31A472ME19# | | | | |
| | | 6800pF | ±10% | GRM022B31A682KE19# | | | | |
| | | | ±20% | GRM022B31A682ME19# | | | | |
| | | 10000pF | ±10% | GRM022B31A103KE19# | | | | |
| | | | ±20% | GRM022B31A103ME19# | | | | |
| | | 6.3Vdc | X5R | 1000pF | ±20% | GRM022R60J102ME19# | | |
| | | | | | ±20% | GRM022R60J152ME19# | | |
| | | | | 2200pF | ±20% | GRM022R60J222ME19# | | |
| | | | | | ±20% | GRM022R60J332ME19# | | |
| | | | | 4700pF | ±20% | GRM022R60J472ME19# | | |
| | | | | | ±20% | GRM022R60J682ME19# | | |
| | | | | 10000pF | ±20% | GRM022R60J103ME19# | | |
| | | | | | ±20% | GRM022R60J153ME15# D1 | | |
| | | | | 22000pF | ±10% | GRM022R60J223KE15# D1 | | |
| | | | | | ±20% | GRM022R60J223ME15# D1 | | |
| | | | | 33000pF | ±20% | GRM022R60J333ME15# D1 | | |
| | | | | | ±20% | GRM022R60J473ME15# D1 | | |
| | | | | 68000pF | ±20% | GRM022R60J683ME15# D1 | | |
| | | | | | ±20% | GRM022R60J104ME15# D1 | | |
| | | | | B | B | 1000pF | ±20% | GRM022B30J102ME19# |
| | | | | | | | ±20% | GRM022B30J152ME19# |
| | | | | | | 2200pF | ±20% | GRM022B30J222ME19# |
| | | | | | | | ±20% | GRM022B30J332ME19# |
| | | 4700pF | ±20% | | | GRM022B30J472ME19# | | |
| | | | ±20% | | | GRM022B30J682ME19# | | |
| | | 6800pF | ±20% | | | GRM022B30J103ME19# | | |
| | | | ±20% | | | GRM022B30J103ME19# | | |
| | | 4Vdc | X6T | | | 0.10µF | ±20% | GRM022D80G104ME15# D1 |
| | | | | | | | ±20% | GRM022R60G153KE15# |
| | | | | | | X5R | 15000pF | ±10% |
| | | | ±20% | | | | | GRM022R60G153ME15# |
| 22000pF | ±10% | | GRM022R60G223KE15# | | | | | |
| | ±20% | | GRM022R60G223ME15# | | | | | |

- GRM
- GR3
- GRJ
- GR4
- GR7
- GJM
- GQM
- GA2
- GA3 GB
- GA3 GD
- GA3 GF
- LLL
- LLA
- LLM
- LLR
- NFM
- KRM
- KR3
- GMA
- GMD
- ⚠Caution /Notice

Part number # indicates the package specification code.

GRM Series High Dielectric Constant Type Part Number List

(→ 0.4×0.2mm)

| T max. | Rated Voltage | TC Code | Cap. | Tol. | Part Number |
|--------|---------------|---------|---------|--------------------|--------------------|
| 0.22mm | 4Vdc | X5R | 33000pF | ±10% | GRM022R60G333KE15# |
| | | | | ±20% | GRM022R60G333ME15# |
| | | | 47000pF | ±10% | GRM022R60G473KE15# |
| | | | | ±20% | GRM022R60G473ME15# |
| | | | 68000pF | ±20% | GRM022R60G683ME15# |
| | | | | 0.10μF | ±20% |
| 2.5Vdc | X6T | 0.10μF | ±20% | GRM022D80E104ME15# | |

| T max. | Rated Voltage | TC Code | Cap. | Tol. | Part Number |
|---------|---------------|------------------------------|------------------------------|------------------------------|------------------------------|
| 0.33mm | 25Vdc | X7R | 4700pF | ±20% | GRM033R71E472ME14# D1 |
| | | | | ±10% | GRM033R71E682KE14# D1 |
| | | | 6800pF | ±20% | GRM033R71E682ME14# D1 |
| | | | | ±10% | GRM033R71E103KE14# D1 |
| | | | 10000pF | ±20% | GRM033R71E103ME14# D1 |
| | | | | ±10% | GRM033R71E103ME14# D1 |
| | | R | 100pF | ±10% | GRM033R11E101KA01# |
| | | | 150pF | ±10% | GRM033R11E151KA01# |
| | | | 220pF | ±10% | GRM033R11E221KA01# |
| | | | 330pF | ±10% | GRM033R11E331KA01# |
| | | | 470pF | ±10% | GRM033R11E471KA01# |
| | | | 680pF | ±10% | GRM033R11E681KA01# |
| | X6S | 0.10μF | ±10% | GRM033C81E104KE14# D1 | |
| | | | ±20% | GRM033C81E104ME14# D1 | |
| | | X5R | 4700pF | ±10% | GRM033R61E472KA12# D1 |
| | | | | ±20% | GRM033R61E472MA12# D1 |
| | | | 6800pF | ±10% | GRM033R61E682KA12# D1 |
| | | | | ±20% | GRM033R61E682MA12# D1 |
| | 10000pF | ±10% | GRM033R61E103KA12# D1 | | |
| | | ±20% | GRM033R61E103MA12# D1 | | |
| | 16Vdc | X7R | 2200pF | ±10% | GRM033R71C222KA88# |
| | | | | ±20% | GRM033R71C332KA88# |
| | | | 3300pF | ±10% | GRM033R71C472KE14# |
| | | | | ±20% | GRM033R71C472ME14# |
| 4700pF | | | ±10% | GRM033R71C682KE14# | |
| | | | ±20% | GRM033R71C682ME14# | |
| X7S | | 0.10μF | ±10% | GRM033C71C104KE14# D1 | |
| | | | ±20% | GRM033C71C104ME14# D1 | |
| | | R | 2200pF | ±10% | GRM033R11C222KA88# |
| | | | 3300pF | ±10% | GRM033R11C332KA88# |
| | | X6S | 0.10μF | ±10% | GRM033C81C104KE14# |
| | | | | ±20% | GRM033C81C104ME14# |
| X5R | 10000pF | | ±10% | GRM033R61C103KA12# | |
| | | | ±20% | GRM033R61C103MA12# | |
| | 15000pF | | ±10% | GRM033R61C153KE84# D1 | |
| | | | ±20% | GRM033R61C153ME84# D1 | |
| 22000pF | ±10% | GRM033R61C223KE84# D1 | | | |
| | ±20% | GRM033R61C223ME84# D1 | | | |
| 33000pF | ±10% | GRM033R61C333KE84# D1 | | | |
| | ±20% | GRM033R61C333ME84# D1 | | | |

0.6×0.3mm

| T max. | Rated Voltage | TC Code | Cap. | Tol. | Part Number | | |
|--------|---------------|---------|------------------------------|--------|--------------------|--------------------|------------------------------|
| 0.33mm | 50Vdc | X7R | 100pF | ±10% | GRM033R71H101KA12# | | |
| | | | | ±20% | GRM033R71H101MA12# | | |
| | | | 150pF | ±10% | GRM033R71H151KA12# | | |
| | | | | ±20% | GRM033R71H151MA12# | | |
| | | | 220pF | ±10% | GRM033R71H221KA12# | | |
| | | | | ±20% | GRM033R71H221MA12# | | |
| | | | 330pF | ±10% | GRM033R71H331KA12# | | |
| | | | | ±20% | GRM033R71H331MA12# | | |
| | | | 470pF | ±10% | GRM033R71H471KA12# | | |
| | | | | ±20% | GRM033R71H471MA12# | | |
| | | | 680pF | ±10% | GRM033R71H681KA12# | | |
| | | | | ±20% | GRM033R71H681MA12# | | |
| | | | 1000pF | ±10% | GRM033R71H102KA12# | | |
| | | | | ±20% | GRM033R71H102MA12# | | |
| | | | 1500pF | ±10% | GRM033R71H152KA12# | | |
| | | | | ±20% | GRM033R71H152MA12# | | |
| | | | X5R | 470pF | ±10% | GRM033R61H471KA12# | |
| | | | | | ±20% | GRM033R61H471MA12# | |
| | | | | B | 100pF | ±10% | GRM033B31H101KA12# |
| | | | | | | ±20% | GRM033B31H101MA12# |
| | | | | 150pF | ±10% | GRM033B31H151KA12# | |
| | | | | | ±20% | GRM033B31H151MA12# | |
| | | | | 220pF | ±10% | GRM033B31H221KA12# | |
| | | | | | ±20% | GRM033B31H221MA12# | |
| | | | | 330pF | ±10% | GRM033B31H331KA12# | |
| | | | | | ±20% | GRM033B31H331MA12# | |
| | | | | 470pF | ±10% | GRM033B31H471KA12# | |
| | | | | | ±20% | GRM033B31H471MA12# | |
| | | | | 680pF | ±10% | GRM033B31H681KA12# | |
| | | | | | ±20% | GRM033B31H681MA12# | |
| | | | | 1000pF | ±10% | GRM033B31H102KA12# | |
| | | | | | ±20% | GRM033B31H102MA12# | |
| | | | | 1500pF | ±10% | GRM033B31H152KA12# | |
| | | | | | ±20% | GRM033B31H152MA12# | |
| | | | 35Vdc | X5R | 0.10μF | ±10% | GRM033R6YA104KE14# D1 |
| | | | | | | ±20% | GRM033R6YA104ME14# D1 |
| | 25Vdc | X7R | | 1000pF | ±10% | GRM033R71E102KA01# | |
| | | | | 1500pF | ±10% | GRM033R71E152KA01# | |
| | | | | 2200pF | ±10% | GRM033R71E222KA12# | |
| | | | | | ±20% | GRM033R71E222MA12# | |
| | 3300pF | ±10% | GRM033R71E332KA12# | | | | |
| | | ±20% | GRM033R71E332MA12# | | | | |
| | 4700pF | ±10% | GRM033R71E472KE14# D1 | | | | |

Part number # indicates the package specification code.



GRM Series High Dielectric Constant Type Part Number List

(→ 0.6×0.3mm)

| T max. | Rated Voltage | TC Code | Cap. | Tol. | Part Number | | |
|---------|---------------|--------------------|--------------------|--------------------|--------------------|--------------------|--|
| 0.33mm | 16Vdc | X5R | 3300pF | ±20% | GRM033R61C333ME84# | D1 | |
| | | | 4700pF | ±10% | GRM033R61C473KE84# | D1 | |
| | | | | ±20% | GRM033R61C473ME84# | D1 | |
| | | | 6800pF | ±10% | GRM033R61C683KE84# | D1 | |
| | | | | ±20% | GRM033R61C683ME84# | D1 | |
| | | | 0.10μF | ±10% | GRM033R61C104KE14# | | |
| | | | | ±20% | GRM033R61C104ME14# | | |
| | | | B | 2200pF | ±10% | GRM033B31C222KA87# | |
| | | | | | ±20% | GRM033B31C222MA87# | |
| | | | | 3300pF | ±10% | GRM033B31C332KA87# | |
| | | ±20% | | | GRM033B31C332MA87# | | |
| | | 10000pF | | ±10% | GRM033B31C103KA12# | | |
| | | | | ±20% | GRM033B31C103MA12# | | |
| | | 15000pF | | ±10% | GRM033B31C153KE84# | D1 | |
| | | | | ±20% | GRM033B31C153ME84# | D1 | |
| | | 22000pF | | ±10% | GRM033B31C223KE84# | D1 | |
| | | | | ±20% | GRM033B31C223ME84# | D1 | |
| | | 33000pF | | ±10% | GRM033B31C333KE84# | D1 | |
| | | | | ±20% | GRM033B31C333ME84# | D1 | |
| | | 47000pF | | ±10% | GRM033B31C473KE84# | D1 | |
| | ±20% | | | GRM033B31C473ME84# | D1 | | |
| | 68000pF | ±10% | | GRM033B31C683KE84# | D1 | | |
| | | ±20% | | GRM033B31C683ME84# | D1 | | |
| | 0.10μF | ±10% | | GRM033B31C104KE84# | D1 | | |
| | | ±20% | | GRM033B31C104ME84# | D1 | | |
| | 10Vdc | X7R | 4700pF | ±10% | GRM033R71A472KA01# | | |
| | | | | ±20% | GRM033R71A472MA01# | | |
| | | | 6800pF | ±10% | GRM033R71A682KA01# | | |
| | | | | ±20% | GRM033R71A682MA01# | | |
| | | | 10000pF | ±10% | GRM033R71A103KA01# | | |
| | | | | ±20% | GRM033R71A103MA01# | | |
| | | | X7S | 0.10μF | ±10% | GRM033C71A104KE14# | |
| | | | | | ±20% | GRM033C71A104ME14# | |
| | | | R | 4700pF | ±10% | GRM033R11A472KA01# | |
| | | | | | ±20% | GRM033R11A472MA01# | |
| | | 6800pF | | ±10% | GRM033R11A682KA01# | | |
| | | | | ±20% | GRM033R11A682MA01# | | |
| | | 10000pF | ±10% | GRM033R11A103KA01# | | | |
| | | | ±20% | GRM033R11A103MA01# | | | |
| | | X5R | 4700pF | ±10% | GRM033R61A472KA01# | | |
| | | | | ±20% | GRM033R61A472MA01# | | |
| | | | 6800pF | ±10% | GRM033R61A682KA01# | | |
| | | | | ±20% | GRM033R61A682MA01# | | |
| | | | 15000pF | ±10% | GRM033R61A153KE84# | | |
| | | | | ±20% | GRM033R61A153ME84# | | |
| | 22000pF | | ±10% | GRM033R61A223KE84# | | | |
| | | | ±20% | GRM033R61A223ME84# | | | |
| | 33000pF | | ±10% | GRM033R61A333KE84# | | | |
| | | | ±20% | GRM033R61A333ME84# | | | |
| | 47000pF | | ±10% | GRM033R61A473KE84# | | | |
| ±20% | | | GRM033R61A473ME84# | | | | |
| 68000pF | ±10% | | GRM033R61A683KE84# | | | | |
| | ±20% | | GRM033R61A683ME84# | | | | |
| 0.10μF | ±10% | GRM033R61A104KE84# | | | | | |
| | ±20% | GRM033R61A104ME84# | | | | | |

| T max. | Rated Voltage | TC Code | Cap. | Tol. | Part Number | | |
|---------|---------------|--------------------|--------------------|--------------------|--------------------|--------------------|--------------------|
| 0.33mm | 10Vdc | X5R | 0.10μF | ±20% | GRM033R61A104ME84# | | |
| | | | 0.22μF | ±20% | GRM033R61A224ME90# | D1 | |
| | | | | B | 4700pF | ±10% | GRM033B11A472KA01# |
| | | | ±20% | | | GRM033B11A472MA01# | |
| | | | 6800pF | ±10% | GRM033B11A682KA01# | | |
| | | | | ±20% | GRM033B11A682MA01# | | |
| | | | 15000pF | ±10% | GRM033B31A153KE84# | | |
| | | | | ±20% | GRM033B31A153ME84# | | |
| | | | 22000pF | ±10% | GRM033B31A223KE84# | | |
| | | | | ±20% | GRM033B31A223ME84# | | |
| | | 33000pF | ±10% | GRM033B31A333KE84# | | | |
| | | | ±20% | GRM033B31A333ME84# | | | |
| | | 47000pF | ±10% | GRM033B31A473KE84# | | | |
| | | | ±20% | GRM033B31A473ME84# | | | |
| | | 68000pF | ±10% | GRM033B31A683KE84# | | | |
| | | | ±20% | GRM033B31A683ME84# | | | |
| | | 0.10μF | ±10% | GRM033B31A104KE84# | | | |
| | | | ±20% | GRM033B31A104ME84# | | | |
| | | 6.3Vdc | X7R | 4700pF | ±10% | GRM033R70J472KA01# | |
| | | | | | ±10% | GRM033R70J682KA01# | |
| | ±10% | | | | GRM033R70J103KA01# | | |
| | R | | 4700pF | ±10% | GRM033R10J472KA01# | | |
| | | | | ±10% | GRM033R10J682KA01# | | |
| | | | | ±10% | GRM033R10J103KA01# | | |
| | X6S | | 15000pF | ±10% | GRM033C80J153KE01# | | |
| | | | | ±20% | GRM033C80J153ME01# | | |
| | | | 22000pF | ±10% | GRM033C80J223KE01# | | |
| | | | | ±20% | GRM033C80J223ME01# | | |
| | 33000pF | ±10% | GRM033C80J333KE01# | | | | |
| | | ±20% | GRM033C80J333ME01# | | | | |
| | 47000pF | ±10% | GRM033C80J473KE19# | | | | |
| | | ±20% | GRM033C80J473ME19# | | | | |
| | 68000pF | ±10% | GRM033C80J683KE84# | D1 | | | |
| | | ±20% | GRM033C80J683ME84# | D1 | | | |
| | 0.10μF | ±10% | GRM033C80J104KE84# | D1 | | | |
| | | ±20% | GRM033C80J104ME84# | D1 | | | |
| | 0.22μF | ±20% | GRM033C80J224ME90# | D1 | | | |
| | | X5R | 0.22μF | ±20% | GRM033R60J224ME90# | | |
| | B | 4700pF | ±10% | GRM033B10J472KA01# | | | |
| | | | ±10% | GRM033B10J682KA01# | | | |
| 15000pF | | ±10% | GRM033B10J153KE01# | | | | |
| | | ±20% | GRM033B10J153ME01# | | | | |
| 22000pF | | ±10% | GRM033B10J223KE01# | | | | |
| | | ±20% | GRM033B10J223ME01# | | | | |
| 33000pF | ±10% | GRM033B10J333KE01# | | | | | |
| | ±20% | GRM033B10J333ME01# | | | | | |
| 4Vdc | X6S | 0.22μF | ±20% | GRM033C80G224ME90# | | | |

1.0×0.5mm

| T max. | Rated Voltage | TC Code | Cap. | Tol. | Part Number | |
|--------|---------------|---------|--------|------|--------------------|-----------|
| 0.22mm | 10Vdc | X5R | 0.10μF | ±10% | GRM152R61A104KE19# | D1 |
| | | | | ±20% | GRM152R61A104ME19# | D1 |

Part number # indicates the package specification code.

GRM Series High Dielectric Constant Type Part Number List

(→ 1.0×0.5mm)

| T max. | Rated Voltage | TC Code | Cap. | Tol. | Part Number | | |
|--------|---------------|---------|--------------------|--------------------|--------------------|--------------------|-----------|
| 0.22mm | 10Vdc | X5R | 0.22µF | ±10% | GRM152R61A224KE19# | D1 | |
| | | | | ±20% | GRM152R61A224ME19# | D1 | |
| | | | B | 0.10µF | ±10% | GRM152B31A104KE19# | D1 |
| | | | | | ±20% | GRM152B31A104ME19# | D1 |
| | | | | 0.22µF | ±10% | GRM152B31A224KE19# | D1 |
| | | | | | ±20% | GRM152B31A224ME19# | D1 |
| | | 6.3Vdc | X6S | 0.10µF | ±10% | GRM152C80J104KE19# | D1 |
| | | | | | ±20% | GRM152C80J104ME19# | D1 |
| | | | | 0.22µF | ±10% | GRM152C80J224KE19# | D1 |
| | | | | | ±20% | GRM152C80J224ME19# | D1 |
| | | | X5R | 0.10µF | ±10% | GRM152R60J104KE19# | |
| | | | | | ±20% | GRM152R60J104ME19# | |
| | 0.22µF | ±10% | GRM152R60J224KE19# | | | | |
| | | ±20% | GRM152R60J224ME19# | | | | |
| | B | 0.10µF | ±10% | GRM152B30J104KE19# | | | |
| | | | ±20% | GRM152B30J104ME19# | | | |
| | | 0.22µF | ±10% | GRM152B30J224KE19# | | | |
| | | | ±20% | GRM152B30J224ME19# | | | |
| | 0.47µF | ±20% | GRM152R60J474ME15# | D1 | | | |
| | | ±20% | GRM152R60J105ME15# | D1 | | | |
| | 4Vdc | X7T | 0.10µF | ±10% | GRM152D70G104KE15# | D1 | |
| | | | | ±20% | GRM152D70G104ME15# | D1 | |
| | | | 0.22µF | ±10% | GRM152D70G224KE15# | D1 | |
| | | | | ±20% | GRM152D70G224ME15# | D1 | |
| | | | X6S | 0.10µF | ±10% | GRM152C80G104KE19# | |
| | | | | | ±20% | GRM152C80G104ME19# | |
| | | 0.22µF | ±10% | GRM152C80G224KE19# | | | |
| | | | ±20% | GRM152C80G224ME19# | | | |
| | | X6T | 0.47µF | ±20% | GRM152D80G474ME15# | | |
| | | | | ±20% | GRM152D80G105ME15# | D1 | |
| | | X5R | 1.0µF | ±20% | GRM152R60G105ME15# | | |
| | | | | | | | |
| | 2.5Vdc | X7T | 0.10µF | ±10% | GRM152D70E104KE19# | | |
| | | | | ±20% | GRM152D70E104ME19# | | |
| | | | 0.22µF | ±10% | GRM152D70E224KE19# | | |
| | | | | ±20% | GRM152D70E224ME19# | | |
| | | X6T | 1.0µF | ±20% | GRM152D80G105ME15# | | |
| | | | | | | | |
| | 0.3mm | 50Vdc | X7R | 220pF | ±10% | GRM15XR71H221KA86# | |
| | | | | | ±10% | GRM15XR71H331KA86# | |
| | | | | 470pF | ±10% | GRM15XR71H471KA86# | |
| | | | | | ±10% | GRM15XR71H681KA86# | |
| | | | | 1000pF | ±10% | GRM15XR71H102KA86# | |
| | | | | | ±10% | GRM15XR71H152KA86# | |
| | | | R | 220pF | ±10% | GRM15XR11H221KA86# | |
| | | | | | ±10% | GRM15XR11H331KA86# | |
| | | | | 470pF | ±10% | GRM15XR11H471KA86# | |
| | | | | | ±10% | GRM15XR11H681KA86# | |
| 1000pF | | | | ±10% | GRM15XR11H102KA86# | | |
| | | | | ±10% | GRM15XR11H152KA86# | | |
| B | | 220pF | ±10% | GRM15XB11H221KA86# | | | |
| | | | ±20% | GRM15XB11H221MA86# | | | |
| | | 330pF | ±10% | GRM15XB11H331KA86# | | | |
| | | | ±20% | GRM15XB11H331MA86# | | | |
| | | 470pF | ±10% | GRM15XB11H471KA86# | | | |
| | | | ±20% | GRM15XB11H471MA86# | | | |

| T max. | Rated Voltage | TC Code | Cap. | Tol. | Part Number | | |
|--------|---------------|--------------------|--------------------|--------------------|--------------------|--------------------|--------------------|
| 0.3mm | 50Vdc | B | 680pF | ±10% | GRM15XB11H681KA86# | | |
| | | | | ±20% | GRM15XB11H681MA86# | | |
| | | | 1000pF | ±10% | GRM15XB11H102KA86# | | |
| | | | | ±20% | GRM15XB11H102MA86# | | |
| | | | 1500pF | ±10% | GRM15XB11H152KA86# | | |
| | | | | ±20% | GRM15XB11H152MA86# | | |
| | | 25Vdc | X7R | 2200pF | ±10% | GRM15XR71E222KA86# | |
| | | | | | ±20% | GRM15XR71E222MA86# | |
| | | | | B | 2200pF | ±10% | GRM15XB11E222KA86# |
| | | | B | 2200pF | ±10% | GRM15XB11E222MA86# | |
| | | | | | ±20% | GRM15XB11E222MA86# | |
| | | | | 16Vdc | X7R | 3300pF | ±10% |
| | ±20% | GRM15XR71C332MA86# | | | | | |
| | 4700pF | ±10% | GRM15XR71C472KA86# | | | | |
| | | ±20% | GRM15XR71C472MA86# | | | | |
| | 6800pF | ±10% | GRM15XR71C682KA86# | | | | |
| | | ±20% | GRM15XR71C682MA86# | | | | |
| | 10000pF | ±10% | GRM15XR71C103KA86# | | | | |
| | | ±20% | GRM15XR71C103MA86# | | | | |
| | B | 3300pF | ±10% | GRM15XB11C332KA86# | | | |
| | | | ±20% | GRM15XB11C332MA86# | | | |
| | | 4700pF | ±10% | GRM15XB11C472KA86# | | | |
| | | | ±20% | GRM15XB11C472MA86# | | | |
| | | 6800pF | ±10% | GRM15XB11C682KA86# | | | |
| | | | ±20% | GRM15XB11C682MA86# | | | |
| | 10000pF | ±10% | GRM15XB11C103KA86# | | | | |
| | | ±20% | GRM15XB11C103MA86# | | | | |
| | 10Vdc | X5R | 15000pF | ±10% | GRM15XR61A153KA86# | | |
| | | | | ±20% | GRM15XR61A153MA86# | | |
| | | | 22000pF | ±10% | GRM15XR61A223KA86# | | |
| | | B | 33000pF | ±10% | GRM15XR61A333KA86# | | |
| | | | | ±20% | GRM15XR61A333MA86# | | |
| | | | | | | | |
| | 0.33mm | 10Vdc | X5R | 1.0µF | ±20% | GRM153R61A105ME95# | D1 |
| | | | B | 1.0µF | ±20% | GRM153B31A105ME95# | D1 |
| | | 6.3Vdc | X6T | 1.0µF | ±20% | GRM153D80J105ME95# | D1 |
| | | | X5R | 1.0µF | ±20% | GRM153R60J105ME95# | |
| | | B | 1.0µF | ±20% | GRM153B30J105ME95# | | |
| | | | | | | | |
| | 4Vdc | X6T | 1.0µF | ±20% | GRM153D80G105ME95# | | |
| | 0.55mm | 100Vdc | X7R | 220pF | ±10% | GRM155R72A221KA01# | |
| | | | | 330pF | ±10% | GRM155R72A331KA01# | |
| | | | | 470pF | ±10% | GRM155R72A471KA01# | |
| | | | | 680pF | ±10% | GRM155R72A681KA01# | |
| | | | | 1000pF | ±10% | GRM155R72A102KA01# | |
| | | | | 1500pF | ±10% | GRM155R72A152KA01# | |
| | | 50Vdc | X7R | 220pF | ±10% | GRM155R72A222KA01# | |
| | | | | 330pF | ±10% | GRM155R72A332KA01# | |
| 470pF | | | | ±10% | GRM155R72A472KA01# | | |
| 680pF | | | | ±10% | GRM155R72A682KA01# | | |
| 1000pF | | | | ±10% | GRM155R72A102KA01# | | |
| 1500pF | | | | ±10% | GRM155R72A152KA01# | | |

Part number # indicates the package specification code.

GRM Series High Dielectric Constant Type Part Number List

(→ 1.0×0.5mm)

| T max. | Rated Voltage | TC Code | Cap. | Tol. | Part Number | T max. | Rated Voltage | TC Code | Cap. | Tol. | Part Number | | |
|--------|---------------|--------------------|---------|--------------------|--------------------|--------------------|---------------|---------|--------------------|--------------------|--------------------|--------------------|--------------------|
| 0.55mm | 50Vdc | X7R | 3300pF | ±10% | GRM155R71H332KA01# | 0.55mm | 50Vdc | B | 3300pF | ±20% | GRM155B11H332MA01# | | |
| | | | 4700pF | ±10% | GRM155R71H472KA01# | | | | 4700pF | ±10% | GRM155B11H472KA01# | | |
| | | | 6800pF | ±10% | GRM155R71H682KA88# | | | | | ±20% | GRM155B11H472MA01# | | |
| | | | 10000pF | ±10% | GRM155R71H103KA88# | | | | 6800pF | ±10% | GRM155B31H682KA88# | | |
| | | | 15000pF | ±10% | GRM155R71H153KA12# | | | | | ±20% | GRM155B31H682MA88# | | |
| | | | 22000pF | ±10% | GRM155R71H223KA12# | | | | 10000pF | ±10% | GRM155B31H103KA88# | | |
| | | | 33000pF | ±10% | GRM155R71H333KE14# | | | | | ±20% | GRM155B31H103MA88# | | |
| | | | | ±20% | GRM155R71H333ME14# | | | | 15000pF | ±10% | GRM155B31H153KA12# | | |
| | | | 47000pF | ±10% | GRM155R71H473KE14# | | | | | ±20% | GRM155B31H153MA12# | | |
| | | | | ±20% | GRM155R71H473ME14# | | | | 22000pF | ±10% | GRM155B31H223KA12# | | |
| | | | 68000pF | ±10% | GRM155R71H683KE14# | | | | | ±20% | GRM155B31H223MA12# | | |
| | | | | ±20% | GRM155R71H683ME14# | | | | 0.10µF | ±10% | GRM155B31H104KE14# | | |
| | | | 0.10µF | ±10% | GRM155R71H104KE14# | | | | | ±20% | GRM155B31H104ME14# | | |
| | | | | ±20% | GRM155R71H104ME14# | | | | 35Vdc | X6S | 0.22µF | ±10% | GRM155C8YA224KE01# |
| | | | ±20% | GRM155C8YA224ME01# | D1 | | | | | | | | |
| | | 220pF | ±10% | GRM155R11H221KA01# | X5R | | | 0.22µF | | | ±10% | GRM155R6YA224KE01# | D1 |
| | | 330pF | ±10% | GRM155R11H331KA01# | | | | | | | ±20% | GRM155R6YA224ME01# | D1 |
| | | 470pF | ±10% | GRM155R11H471KA01# | | | | 0.47µF | | | ±10% | GRM155R6YA474KE01# | D1 |
| | | 680pF | ±10% | GRM155R11H681KA01# | | | | | | ±20% | GRM155R6YA474ME01# | D1 | |
| | | 1000pF | ±10% | GRM155R11H102KA01# | | | | 25Vdc | | X7R | 2200pF | ±10% | GRM155R71E222KA01# |
| | | 1500pF | ±10% | GRM155R11H152KA01# | 10000pF | | | | | | ±10% | GRM155R71E103KA01# | |
| | | 2200pF | ±10% | GRM155R11H222KA01# | 15000pF | | | | | | ±10% | GRM155R71E153KA61# | |
| | | 3300pF | ±10% | GRM155R11H332KA01# | 22000pF | | | | | | ±10% | GRM155R71E223KA61# | |
| | | 4700pF | ±10% | GRM155R11H472KA01# | 33000pF | | | | ±10% | | GRM155R71E333KA88# | | |
| | | 6800pF | ±10% | GRM155R11H682KA88# | 47000pF | | | | ±10% | GRM155R71E473KA88# | | | |
| | | 10000pF | ±10% | GRM155R11H103KA88# | 68000pF | | | | ±10% | GRM155R71E683KE14# | | | |
| | | | ±20% | GRM155C81H333KE14# | | | | | ±20% | GRM155R71E683ME14# | | | |
| | | | ±20% | GRM155C81H473KE14# | 0.10µF | | | | ±10% | GRM155R71E104KE14# | | | |
| | | | ±20% | GRM155C81H473ME14# | | | | | ±20% | GRM155R71E104ME14# | | | |
| | | | ±10% | GRM155C81H683KE14# | R | | | 6800pF | ±10% | GRM155R11E682KA01# | | | |
| | | | ±20% | GRM155C81H683ME14# | | | | 10000pF | ±10% | GRM155R11E103KA01# | | | |
| | | 33000pF | ±10% | GRM155R61H333KE14# | | | | 15000pF | ±10% | GRM155R11E153KA61# | | | |
| | | | ±20% | GRM155R61H333ME14# | | | | 22000pF | ±10% | GRM155R11E223KA61# | | | |
| | | 47000pF | ±10% | GRM155R61H473KE14# | | | | 33000pF | ±10% | GRM155R11E333KA88# | | | |
| | | | ±20% | GRM155R61H473ME14# | | | | 47000pF | ±10% | GRM155R11E473KA88# | | | |
| | | 68000pF | ±10% | GRM155R61H683KE14# | | | | X6S | 0.22µF | ±10% | GRM155C81E224KE01# | | |
| | | | ±20% | GRM155R61H683ME14# | | | | | | ±20% | GRM155C81E224ME01# | | |
| | | 0.10µF | ±10% | GRM155R61H104KE14# | | | | | X5R | 68000pF | ±10% | GRM155R61E683KA87# | |
| | | | ±20% | GRM155R61H104ME14# | | | | | | | ±20% | GRM155R61E683MA87# | |
| | | 33000pF | ±10% | GRM155B11H221KA01# | 0.10µF | | | | | ±10% | GRM155R61E104KA87# | | |
| | | | ±20% | GRM155B11H221MA01# | | | | ±20% | | GRM155R61E104MA87# | | | |
| | | 330pF | ±10% | GRM155B11H331KA01# | 0.22µF | | | ±10% | | GRM155R61E224KE01# | | | |
| | | | ±20% | GRM155B11H331MA01# | | | | ±20% | GRM155R61E224ME01# | | | | |
| | | 470pF | ±10% | GRM155B11H471KA01# | | | | ±10% | GRM155R61E474KE01# | | | | |
| | | | ±20% | GRM155B11H471MA01# | 1.0µF | | | ±10% | GRM155R61E105KA12# | | | | |
| | | 680pF | ±10% | GRM155B11H681KA01# | | | | ±20% | GRM155R61E105MA12# | | | | |
| | | | ±20% | GRM155B11H681MA01# | B | | | 2200pF | ±10% | GRM155B11E222KA01# | | | |
| | | 1000pF | ±10% | GRM155B11H102KA01# | | | | 10000pF | ±10% | GRM155B11E103KA01# | | | |
| | | | ±20% | GRM155B11H102MA01# | | | | | ±20% | GRM155B11E103MA01# | | | |
| | | 1500pF | ±10% | GRM155B11H152KA01# | | | | 15000pF | ±10% | GRM155B11E153KA61# | | | |
| | ±20% | GRM155B11H152MA01# | | ±20% | | GRM155B11E153MA61# | | | | | | | |
| 2200pF | ±10% | GRM155B11H222KA01# | 22000pF | ±10% | | GRM155B11E223KA61# | | | | | | | |
| | ±20% | GRM155B11H222MA01# | | ±20% | | GRM155B11E223MA61# | | | | | | | |
| 3300pF | ±10% | GRM155B11H332KA01# | 33000pF | ±10% | | GRM155B31E333KA87# | | | | | | | |

Part number # indicates the package specification code.

GRM Series High Dielectric Constant Type Part Number List

(→ 1.0×0.5mm)

| T max. | Rated Voltage | TC Code | Cap. | Tol. | Part Number | |
|--------|---------------|---------|--------------------|--------------------|--------------------|--------------------|
| 0.55mm | 25Vdc | B | 3300pF | ±20% | GRM155B31E333MA87# | |
| | | | 4700pF | ±10% | GRM155B31E473KA87# | |
| | | | | ±20% | GRM155B31E473MA87# | |
| | | | | ±10% | GRM155B31E683KA87# | |
| | | | 6800pF | ±10% | GRM155B31E683MA87# | |
| | | | | ±20% | GRM155B31E683MA87# | |
| | | 0.10μF | ±10% | GRM155B31E104KA87# | | |
| | | | ±20% | GRM155B31E104MA87# | | |
| | | 1.0μF | ±10% | GRM155B31E105KA12# | | |
| | | | ±20% | GRM155B31E105MA12# | | |
| | | 16Vdc | X7R | 4700pF | ±10% | GRM155R71C472KA01# |
| | | | | 10000pF | ±10% | GRM155R71C103KA01# |
| | | | | | ±20% | GRM155R71C103MA01# |
| | | | | | ±10% | GRM155R71C683KA88# |
| | | | | 0.15μF | ±10% | GRM155R71C154KA12# |
| | | | | | ±10% | GRM155R71C224KA12# |
| | | | R | 6800pF | ±10% | GRM155R11C683KA88# |
| | | | X6S | 0.47μF | ±10% | GRM155C81C474KE01# |
| | ±20% | | | GRM155C81C474ME01# | | |
| | X5R | | 0.22μF | ±10% | GRM155R61C224KA12# | |
| | | | ±20% | GRM155R61C224MA12# | | |
| | 1.0μF | | ±10% | GRM155R61C105KA12# | | |
| | | | ±20% | GRM155R61C105MA12# | | |
| | B | | 10000pF | ±10% | GRM155B11C103KA01# | |
| | | | ±20% | GRM155B11C103MA01# | | |
| | | | 1.0μF | ±10% | GRM155B31C105KA12# | |
| | | | | ±20% | GRM155B31C105MA12# | |
| | 10Vdc | | X7R | 0.22μF | ±10% | GRM155R71A224KE01# |
| | | ±20% | | GRM155R71A224ME01# | | |
| | | 0.47μF | | ±10% | GRM155R71A474KE01# | |
| | | | | ±20% | GRM155R71A474ME01# | |
| | | | | ±10% | GRM155R71A474ME01# | |
| | | X6S | | 1.0μF | ±10% | GRM155C81A105KA12# |
| | | | ±20% | GRM155C81A105MA12# | | |
| | | X5R | 3300pF | ±10% | GRM155R61A333KA01# | |
| | | | 0.10μF | ±10% | GRM155R61A104KA01# | |
| | | | | ±20% | GRM155R61A104MA01# | |
| | | | 0.15μF | ±10% | GRM155R61A154KE19# | |
| | | | | ±20% | GRM155R61A154ME19# | |
| | | | 0.22μF | ±10% | GRM155R61A224KE19# | |
| | | ±20% | GRM155R61A224ME19# | | | |
| | | 0.33μF | ±10% | GRM155R61A334KE15# | | |
| | | | ±20% | GRM155R61A334ME15# | | |
| | | | 0.47μF | ±10% | GRM155R61A474KE15# | |
| | | | | ±20% | GRM155R61A474ME15# | |
| | 0.68μF | | ±10% | GRM155R61A684KE15# | | |
| | | | ±20% | GRM155R61A684ME15# | | |
| | 1.0μF | ±20% | GRM155R61A105ME01# | | | |
| B | 0.15μF | ±10% | GRM155B31A154KE18# | | | |
| | | ±20% | GRM155B31A154ME18# | | | |
| | 0.22μF | ±10% | GRM155B31A224KE18# | | | |
| | | ±20% | GRM155B31A224ME18# | | | |
| | 0.33μF | ±10% | GRM155B31A334KE14# | | | |
| | | ±20% | GRM155B31A334ME14# | | | |
| | 0.47μF | ±10% | GRM155B31A474KE14# | | | |
| | | ±20% | GRM155B31A474ME14# | | | |

| T max. | Rated Voltage | TC Code | Cap. | Tol. | Part Number | |
|--------|---------------|--------------------|--------------------|--------------------|--------------------|--------------------|
| 0.55mm | 10Vdc | B | 0.68μF | ±10% | GRM155B31A684KE15# | |
| | | | ±20% | GRM155B31A684ME15# | | |
| | | | 1.0μF | ±20% | GRM155B31A105ME01# | |
| | | | 2.2μF | ±10% | GRM155B31A225KE95# | |
| | | | | ±20% | GRM155B31A225ME95# | |
| | | | 6.3Vdc | X7R | 1.0μF | ±10% |
| | | ±20% | | | GRM155R70J105MA12# | |
| | | X6S | 0.22μF | ±10% | GRM155C80J224KE01# | |
| | | | | ±20% | GRM155C80J224ME01# | |
| | | | 2.2μF | ±10% | GRM155C80J225KE95# | |
| | | | | ±20% | GRM155C80J225ME95# | |
| | | | X5R | 0.10μF | ±10% | GRM155R60J104KA01# |
| | ±20% | | | GRM155R60J104MA01# | | |
| | 0.15μF | ±10% | GRM155R60J154KE01# | | | |
| | | | ±20% | GRM155R60J154ME01# | | |
| | | 0.22μF | ±10% | GRM155R60J224KE01# | | |
| | | | ±20% | GRM155R60J224ME01# | | |
| | | 0.33μF | ±10% | GRM155R60J334KE01# | | |
| | | | ±20% | GRM155R60J334ME01# | | |
| | 0.47μF | ±10% | GRM155R60J474KE19# | | | |
| | | ±20% | GRM155R60J474ME19# | | | |
| | 0.68μF | ±10% | GRM155R60J684KE19# | | | |
| | | ±20% | GRM155R60J684ME19# | | | |
| | 1.0μF | ±20% | GRM155R60J105ME19# | | | |
| | | B | 0.15μF | ±10% | GRM155B10J154KE01# | |
| | ±20% | | | GRM155B10J154ME01# | | |
| | 0.22μF | | ±10% | GRM155B10J224KE01# | | |
| | | | ±20% | GRM155B10J224ME01# | | |
| | 0.33μF | | ±10% | GRM155B10J334KE01# | | |
| | | | ±20% | GRM155B10J334ME01# | | |
| | 0.47μF | ±10% | GRM155B30J474KE18# | | | |
| | | ±20% | GRM155B30J474ME18# | | | |
| | 0.68μF | ±10% | GRM155B30J684KE18# | | | |
| | | ±20% | GRM155B30J684ME18# | | | |
| | 1.0μF | ±20% | GRM155B30J105ME18# | | | |
| | | ±20% | GRM155B30J225ME95# | | | |
| | ±20% | GRM155B30J225ME95# | | | | |
| | | 4Vdc | X7R | 1.0μF | ±10% | GRM155R70G105KA12# |
| | ±20% | | | GRM155R70G105MA12# | | |
| | X6S | | 0.22μF | ±10% | GRM155C80G224KE01# | |
| | | | ±20% | GRM155C80G224ME01# | | |
| | X5R | | 1.0μF | ±20% | GRM155R60G105ME01# | |
| | | | 0.6mm | 50Vdc | X5R | 0.47μF |
| | ±10% | GRM155R61H474KE11# | | | | |
| | 35Vdc | X5R | | 1.0μF | ±10% | GRM155R61A105KE11# |
| | | | | ±10% | GRM155R61A105KE11# | |
| | 25Vdc | X6S | | 1.0μF | ±10% | GRM155C81E105KE11# |
| | | | | ±20% | GRM155C81E105ME11# | |
| 16Vdc | X6S | 1.0μF | ±10% | GRM155C81C105KE11# | | |
| | | ±20% | GRM155C81C105ME11# | | | |
| 6.3Vdc | X5R | 4.7μF | ±20% | GRM155R60J475ME47# | | |
| | | ±20% | GRM155R60J475ME47# | | | |
| | B | 4.7μF | ±20% | GRM155B30J475ME47# | | |
| | | ±20% | GRM155B30J475ME47# | | | |
| 4Vdc | X5R | 4.7μF | ±20% | GRM155R60G475ME47# | | |
| | | ±20% | GRM155R60G475ME47# | | | |
| B | 4.7μF | ±20% | GRM155B30G475ME47# | | | |
| | | ±20% | GRM155B30G475ME47# | | | |
| 2.5Vdc | X6T | 4.7μF | ±20% | GRM155D80E475ME47# | | |
| | | ±20% | GRM155D80E475ME47# | | | |
| 0.65mm | 25Vdc | X6T | 2.2μF | ±20% | GRM155D81E225ME11# | |
| | | | ±20% | GRM155D81E225ME11# | | |

Part number # indicates the package specification code.

GRM Series High Dielectric Constant Type Part Number List

(→ 1.0×0.5mm)

| T max. | Rated Voltage | TC Code | Cap. | Tol. | Part Number | |
|--------|---------------|---------|-------|--------------------|--------------------|-----------|
| 0.65mm | 16Vdc | X7T | 2.2μF | ±20% | GRM155D71C225ME11# | D1 |
| | | X6T | 2.2μF | ±20% | GRM155D81C225ME11# | |
| | 10Vdc | X7T | 2.2μF | ±20% | GRM155D71A225ME11# | |
| | | X5R | 4.7μF | ±20% | GRM155R61A475MEAA# | D1 |
| | 6.3Vdc | X6S | 4.7μF | ±20% | GRM155C80J475MEAA# | D1 |
| 0.7mm | 25Vdc | X5R | 2.2μF | ±10% | GRM155R61E225KE11# | |
| | | | | ±20% | GRM155R61E225ME11# | |
| | 16Vdc | X6S | 2.2μF | ±10% | GRM155C81C225KE11# | |
| | | | | ±20% | GRM155C81C225ME11# | |
| | | X5R | 2.2μF | ±10% | GRM155R61C225KE11# | |
| | | | | ±20% | GRM155R61C225ME11# | |
| | 10Vdc | X7S | 2.2μF | ±10% | GRM155C71A225KE11# | |
| | | | | ±20% | GRM155C71A225ME11# | |
| | | X6S | 2.2μF | ±10% | GRM155C81A225KE11# | |
| | | | | ±20% | GRM155C81A225ME11# | |
| | 6.3Vdc | X7S | 2.2μF | ±10% | GRM155C70J225KE11# | |
| | | | | ±20% | GRM155C70J225ME11# | |
| 4Vdc | X5R | 10μF | ±20% | GRM155R60G106ME44# | | |
| 2.5Vdc | X5R | 10μF | ±20% | GRM155R60E106ME16# | | |

1.6×0.8mm

| T max. | Rated Voltage | TC Code | Cap. | Tol. | Part Number | |
|--------|---------------|--------------------|--------------------|--------------------|--------------------|-----------|
| 0.5mm | 25Vdc | X5R | 1.0μF | ±10% | GRM185R61E105KA12# | D1 |
| | | | | ±20% | GRM185R61E105MA12# | D1 |
| | | B | 1.0μF | ±10% | GRM185B31E105KA12# | D1 |
| | | | | ±20% | GRM185B31E105MA12# | D1 |
| | 16Vdc | X5R | 1.0μF | ±10% | GRM185R61C105KE44# | |
| | | | | ±20% | GRM185R61C105ME44# | |
| | B | 1.0μF | ±10% | GRM185B31C105KE43# | | |
| | | | ±20% | GRM185B31C105ME43# | | |
| | 6.3Vdc | X5R | 10μF | ±20% | GRM185R60J106ME15# | D1 |
| | 4Vdc | X5R | 10μF | ±20% | GRM185R60G106ME15# | |
| 0.55mm | 16Vdc | X5R | 4.7μF | ±10% | GRM185R61C475KE11# | |
| | | | | ±20% | GRM185R61C475ME11# | |
| | 10Vdc | X6S | 4.7μF | ±10% | GRM185C81A475KE11# | D1 |
| | | | | ±20% | GRM185C81A475ME11# | D1 |
| | | X5R | 4.7μF | ±10% | GRM185R61A475KE11# | |
| | | | | ±20% | GRM185R61A475ME11# | |
| 6.3Vdc | X7T | 4.7μF | ±20% | GRM185D70J475ME11# | D1 | |
| | X6S | 4.7μF | ±20% | GRM185C80J475ME11# | | |
| 0.9mm | 250Vdc | X7R | 220pF | ±10% | GRM188R72E221KW07# | |
| | | | 330pF | ±10% | GRM188R72E331KW07# | |
| | | | 470pF | ±10% | GRM188R72E471KW07# | |
| | | | 680pF | ±10% | GRM188R72E681KW07# | |
| | | | 1000pF | ±10% | GRM188R72E102KW07# | |
| | | | 1500pF | ±10% | GRM188R72E152KW07# | |
| | | | 2200pF | ±10% | GRM188R72E222KW07# | |
| | | | 200Vdc | X7R | 220pF | ±10% |
| | 330pF | ±10% | GRM188R72D331KW07# | | | |
| | 470pF | ±10% | GRM188R72D471KW07# | | | |
| 680pF | ±10% | GRM188R72D681KW07# | | | | |
| | | | 1000pF | ±10% | GRM188R72D102KW07# | |

| T max. | Rated Voltage | TC Code | Cap. | Tol. | Part Number | |
|--------|---------------|---------|--------------------|--------------------|--------------------|--------------------|
| 0.9mm | 200Vdc | X7R | 1500pF | ±10% | GRM188R72D152KW07# | |
| | | | 2200pF | ±10% | GRM188R72D222KW07# | |
| | 25Vdc | X7R | 1.0μF | ±10% | GRM188R71E105KA12# | |
| | | | | ±20% | GRM188R71E105MA12# | |
| | | X5R | 2.2μF | ±10% | GRM188R61E225KA12# | |
| | | | | ±20% | GRM188R61E225MA12# | |
| | | B | 2.2μF | ±10% | GRM188B31E225KA12# | |
| | | | | ±20% | GRM188B31E225MA12# | |
| | 16Vdc | X6S | 2.2μF | ±10% | GRM188C81C225KA12# | |
| | | | | ±20% | GRM188C81C225MA12# | |
| | | X5R | 2.2μF | ±10% | GRM188R61C225KE15# | |
| | | | | ±20% | GRM188B31C225KE14# | |
| | 10Vdc | X7R | 2.2μF | ±10% | GRM188R71A225KE15# | |
| | | | | ±20% | GRM188R71A225ME15# | |
| | | X5R | 4.7μF | ±10% | GRM188R61A475KE15# | D1 |
| | | | | ±20% | GRM188R61A475ME15# | D1 |
| | 6.3Vdc | X6S | 4.7μF | ±20% | GRM188C80J475ME15# | D1 |
| | | | | X5R | 10μF | ±20% |
| B | | 10μF | ±20% | GRM188B30J106ME47# | | |
| | | | X5R | 10μF | ±20% | GRM188R60G106ME47# |
| 0.95mm | 25Vdc | X5R | 4.7μF | ±10% | GRM188R61E475KE11# | |
| | | | | ±20% | GRM188R61E475ME11# | |
| | 16Vdc | X6S | 4.7μF | ±10% | GRM188C81C475KE11# | |
| | | | | ±20% | GRM188C81C475ME11# | |
| | | X5R | 4.7μF | ±10% | GRM188R61C475KE11# | |
| | | | | ±20% | GRM188R61C475ME11# | |
| | B | 4.7μF | ±10% | GRM188B31C475KAAJ# | D1 | |
| | | | ±20% | GRM188B31C475MAAJ# | D1 | |
| | 10Vdc | X7S | 4.7μF | ±10% | GRM188C71A475KE11# | |
| | | | | ±20% | GRM188C71A475ME11# | |
| X5R | | 10μF | ±10% | GRM188R61A106KAAJ# | | |
| | | | ±20% | GRM188R61A106MAAJ# | | |
| B | 10μF | ±20% | GRM188B31A106ME69# | D1 | | |
| 1.0mm | 50Vdc | X5R | 2.2μF | ±10% | GRM188R61H225KE11# | |
| | | | | ±20% | GRM188R61H225ME11# | |
| | 35Vdc | X6S | 2.2μF | ±10% | GRM188C8YA225KE11# | |
| | | | | ±20% | GRM188C8YA225ME11# | |
| | | X5R | 4.7μF | ±10% | GRM188R6YA475KE15# | |
| | | | | ±20% | GRM188R6YA475ME15# | |
| | 25Vdc | X7S | 2.2μF | ±10% | GRM188C71E225KE11# | |
| | | | | ±20% | GRM188C71E225ME11# | |
| | | X6S | 2.2μF | ±10% | GRM188C81E225KE11# | |
| | | | | ±20% | GRM188C81E225ME11# | |
| 4.7μF | | | ±10% | GRM188C81E475KE11# | D1 | |
| | | | ±20% | GRM188C81E475ME11# | D1 | |
| 16Vdc | X7S | 2.2μF | ±10% | GRM188R61E106MA73# | | |
| | | | ±20% | GRM188C71C225KE11# | | |
| | 4.7μF | ±10% | GRM188C71C475KE21# | | | |
| | | ±20% | GRM188C81C106MA73# | | | |
| 10Vdc | X7T | 10μF | ±20% | GRM188D71A106MA73# | | |
| 6.3Vdc | X7T | 10μF | ±20% | GRM188D70J106MA73# | | |

Part number # indicates the package specification code.

GRM Series High Dielectric Constant Type Part Number List

(→ 1.6×0.8mm)

| T max. | Rated Voltage | TC Code | Cap. | Tol. | Part Number | |
|--------|---------------|---------|------|------|--------------------|-----------|
| 1.0mm | 6.3Vdc | X5R | 22μF | ±20% | GRM188R60J226MEA0# | D1 |
| | | B | 22μF | ±20% | GRM188B30J226MEA0# | D1 |
| | 4Vdc | X6S | 22μF | ±20% | GRM188C80G226MEA0# | D1 |
| | | X5R | 22μF | ±20% | GRM188R60G226MEA0# | |
| | | B | 22μF | ±20% | GRM188B30G226MEA0# | |

2.0×1.25mm

| T max. | Rated Voltage | TC Code | Cap. | Tol. | Part Number | |
|--------|---------------|---------|--------------------|--------------------|--------------------|--------------------|
| 0.7mm | 16Vdc | X6S | 1.0μF | ±10% | GRM216C81C105KA12# | |
| 0.95mm | 50Vdc | X5R | 1.0μF | ±10% | GRM219R61H105KA73# | |
| | | | | ±20% | GRM219R61H105MA73# | |
| | | | 2.2μF | ±10% | GRM219R61H225KE15# | |
| | | ±20% | | GRM219R61H225ME15# | | |
| | | B | 1.0μF | ±10% | GRM219B31H105KA73# | |
| | | | | ±20% | GRM219B31H105MA73# | |
| | 2.2μF | | ±10% | GRM219B31H225KE15# | | |
| | | ±20% | GRM219B31H225ME15# | | | |
| | 35Vdc | X6S | 2.2μF | ±10% | GRM219C8YA225KE15# | |
| | | | | ±20% | GRM219C8YA225ME15# | |
| | | X5R | 4.7μF | ±10% | GRM219R6YA475KA73# | D1 |
| | | | | ±20% | GRM219R6YA475MA73# | D1 |
| | 25Vdc | X7R | 1.0μF | ±10% | GRM219R71E105KA88# | |
| | | | | ±20% | GRM219C81E225KE15# | |
| | | | 2.2μF | ±10% | GRM219C81E225ME15# | |
| | | | | ±20% | GRM219R61E225KA12# | |
| | | X5R | 2.2μF | ±10% | GRM219R61E225MA12# | |
| | | | | ±20% | GRM219R61E475KA73# | |
| | | | 4.7μF | ±10% | GRM219R61E475MA73# | |
| | | | | ±20% | GRM219R61E106KA12# | D1 |
| | | B | 2.2μF | ±10% | GRM219R61E106MA12# | D1 |
| | | | | ±20% | GRM219B31E225KA75# | |
| | | | 10μF | ±10% | GRM219B31E225MA75# | |
| | | | | ±20% | GRM219B31E106KA12# | D1 |
| | 16Vdc | X7R | 2.2μF | ±10% | GRM219R71C225KE15# | |
| | | | | ±20% | GRM219R71C225ME15# | |
| | | | X5R | 4.7μF | ±10% | GRM219R61C475KE15# |
| ±20% | | | | | GRM219R61C106KA73# | |
| B | | 4.7μF | ±10% | GRM219R61C106MA73# | | |
| | | | ±20% | GRM219B31C475KE15# | | |
| | | 10μF | ±10% | GRM219B31C106KA73# | | |
| | | | ±20% | GRM219B31C106MA73# | | |
| 10Vdc | | X7R | 2.2μF | ±10% | GRM219R71A225KE15# | |
| | | | | ±20% | GRM219R71A225ME15# | |
| | | X7T | 4.7μF | ±10% | GRM219D71A475KE15# | D1 |
| | | | | ±20% | GRM219D71A475ME15# | D1 |
| | X5R | 22μF | ±20% | GRM219R61A226MEA0# | D1 | |
| | | | ±20% | GRM219B31A226MEA0# | D1 | |
| 6.3Vdc | X6S | 10μF | ±10% | GRM219C80J106KE39# | | |
| | | | ±20% | GRM219C80J106ME39# | | |
| | X5R | 22μF | ±20% | GRM219R60J226MEA0# | | |
| | | | ±20% | GRM219B30J226ME47# | D1 | |

| T max. | Rated Voltage | TC Code | Cap. | Tol. | Part Number | |
|--------|---------------|---------|--------------------|--------------------|--------------------|-----------|
| 0.95mm | 4Vdc | X6S | 10μF | ±10% | GRM219C80G106KE19# | |
| | | | | ±20% | GRM219C80G106ME19# | |
| | X5R | 47μF | ±20% | GRM219R60G476ME44# | D1 | |
| | | | ±20% | GRM219D80E476ME44# | | |
| 1.0mm | 500Vdc | X7R | 1000pF | ±10% | GRM21AR72H102KW10# | |
| | | | | ±10% | GRM21AR72H152KW10# | |
| | | | | ±10% | GRM21AR72H222KW10# | |
| | | | | ±10% | GRM21AR72H332KW10# | |
| | | | | ±10% | GRM21AR72H472KW10# | |
| | | | | ±10% | GRM21AR72H682KW10# | |
| | 250Vdc | X7R | 1000pF | ±10% | GRM21AR72E102KW01# | |
| | | | | ±10% | GRM21AR72E152KW01# | |
| | | | | ±10% | GRM21AR72E222KW01# | |
| | | | | ±10% | GRM21AR72E332KW01# | |
| | | | | ±10% | GRM21AR72E472KW01# | |
| | | | | ±10% | GRM21AR72E682KW01# | |
| | 200Vdc | X7R | 1000pF | ±10% | GRM21AR72D102KW01# | |
| | | | | ±10% | GRM21AR72D152KW01# | |
| | | | | ±10% | GRM21AR72D222KW01# | |
| | | | | ±10% | GRM21AR72D332KW01# | |
| | | | | ±10% | GRM21AR72D472KW01# | |
| | | | | ±10% | GRM21AR72D682KW01# | |
| | 35Vdc | X6S | 4.7μF | ±10% | GRM219C8YA475KE21# | D1 |
| | | | | ±20% | GRM219C8YA475ME21# | D1 |
| 25Vdc | X7S | 4.7μF | ±10% | GRM219C71E475KE21# | D1 | |
| | | | ±20% | GRM219C71E475ME21# | D1 | |
| | X6S | 4.7μF | ±10% | GRM219C81E475KE21# | D1 | |
| | | | ±20% | GRM219C81E475ME21# | D1 | |
| 16Vdc | X7S | 4.7μF | ±10% | GRM219C71C475KE21# | | |
| | | | ±20% | GRM219C71C475ME21# | | |
| | X5R | 22μF | ±20% | GRM219R61C226ME15# | D1 | |
| | | | ±20% | GRM219R61C226MA12# | | |
| 1.35mm | 25Vdc | X6S | 4.7μF | ±10% | GRM21BC81E475KA12# | |
| | | | | ±20% | GRM21BC81E475MA12# | |
| | | X5R | 4.7μF | ±10% | GRM21BR61E475KA12# | |
| | | | | ±20% | GRM21BR61E475MA12# | |
| | | B | 2.2μF | ±10% | GRM21BB31E225KA75# | |
| | | | | ±20% | GRM21BB31E225MA75# | |
| | 16Vdc | X7R | 2.2μF | ±10% | GRM21BR71C225KA12# | |
| | | | | ±20% | GRM21BR71C225MA12# | |
| | | X5R | 10μF | ±10% | GRM21BR61C106KE15# | |
| | | | | ±20% | GRM21BR61C106ME15# | |
| | | B | 10μF | ±10% | GRM21BB31C106KE15# | |
| | | | | ±20% | GRM21BB31C106ME15# | |
| 1.4mm | 50Vdc | X5R | 2.2μF | ±10% | GRM21BR61H225KA73# | |
| | | | | ±20% | GRM21BR61H225MA73# | |
| | | | 4.7μF | ±10% | GRM21BR61H475KE51# | |
| | | ±20% | | GRM21BR61H475ME51# | | |
| | | B | 2.2μF | ±10% | GRM21BB31H225KA73# | |
| | | | | ±20% | GRM21BB31H225MA73# | |
| | 4.7μF | | ±10% | GRM21BB31H475KE51# | | |
| | | ±20% | GRM21BB31H475ME51# | | | |
| | 25Vdc | X7R | 2.2μF | ±10% | GRM21BR71E225KE11# | |

Part number # indicates the package specification code.



GRM Series High Dielectric Constant Type Part Number List

(→ 2.0×1.25mm)

| T max. | Rated Voltage | TC Code | Cap. | Tol. | Part Number | | |
|-----------|---------------|---------|-----------|--------------------|--------------------|--------------------|--------------------|
| 1.4mm | 25Vdc | X7R | 2.2μF | ±20% | GRM21BR71E225ME11# | | |
| | | | 10μF | ±10% | GRM21BR61E106KA73# | | |
| | | B | 10μF | ±10% | GRM21BB31E106KA73# | | |
| | | | | ±20% | GRM21BB31E106MA73# | | |
| | | | X6S | 10μF | ±10% | GRM21BC81C106KA73# | |
| | | | | | ±20% | GRM21BC81C106MA73# | |
| | 16Vdc | X6S | 10μF | ±10% | GRM21BC81C106KA73# | | |
| | 10Vdc | B | 22μF | ±20% | GRM21BB31A226ME51# | | |
| | | | | D1 | | | |
| | | X7R | 10μF | ±10% | GRM21BR70J106KE76# | | |
| | | | | D1 | | | |
| | 6.3Vdc | X6S | 22μF | ±20% | GRM21BC80J226ME51# | | |
| D1 | | | | | | | |
| 4Vdc | X7U | 22μF | ±20% | GRM21BE70G226ME51# | | | |
| | X6S | 22μF | ±20% | GRM21BC80G226ME39# | | | |
| 1.45mm | 500Vdc | X7R | 10000pF | ±10% | GRM21BR72H103KW09# | | |
| | | | 250Vdc | X7R | 10000pF | ±10% | GRM21BR72E103KW03# |
| | | | | | 15000pF | ±10% | GRM21BR72E153KW03# |
| | | | | | 22000pF | ±10% | GRM21BR72E223KW03# |
| | 200Vdc | X7R | 10000pF | ±10% | GRM21BR72D103KW03# | | |
| | | | 15000pF | ±10% | GRM21BR72D153KW03# | | |
| | | | 22000pF | ±10% | GRM21BR72D223KW03# | | |
| | | | D1 | | | | |
| | 50Vdc | X7S | 4.7μF | ±10% | GRM21BC71H475KE11# | | |
| | | | | ±20% | GRM21BC71H475ME11# | | |
| | | | | D1 | | | |
| | | X6S | 4.7μF | ±10% | GRM21BC81H475KE11# | | |
| | | | | ±20% | GRM21BC81H475ME11# | | |
| | | | | D1 | | | |
| | 35Vdc | X7S | 4.7μF | ±10% | GRM21BC7YA475KE11# | | |
| | | | | ±20% | GRM21BC7YA475ME11# | | |
| | | | | D1 | | | |
| | | X6S | 10μF | ±10% | GRM21BC8YA106KE11# | | |
| | | | | ±20% | GRM21BC8YA106ME11# | | |
| | | | | D1 | | | |
| | X5R | 10μF | ±10% | GRM21BR6YA106KE43# | | | |
| | | | ±20% | GRM21BR6YA106ME43# | | | |
| | | | D1 | | | | |
| | 25Vdc | X7S | 4.7μF | ±10% | GRM21BC71E475KE11# | | |
| | | | | ±20% | GRM21BC71E475ME11# | | |
| | | | | D1 | | | |
| | | | 10μF | ±10% | GRM21BC71E106KE11# | | |
| | | | | ±20% | GRM21BC71E106ME11# | | |
| | | | | D1 | | | |
| | | X6S | 10μF | ±10% | GRM21BC81E106KE11# | | |
| | | | | ±20% | GRM21BC81E106ME11# | | |
| | | | X5R | 22μF | ±20% | GRM21BR61E226ME44# | |
| | | | | | D1 | | |
| | 16Vdc | X7S | 10μF | ±10% | GRM21BC71C106KE11# | | |
| | | | | ±20% | GRM21BC71C106ME11# | | |
| | | | | D1 | | | |
| X6S | | 22μF | ±20% | GRM21BC81C226ME44# | | | |
| | | | D1 | | | | |
| | | | D1 | | | | |
| 10Vdc | X7T | 22μF | ±20% | GRM21BD71A226ME44# | | | |
| | | | D1 | | | | |
| | | | D1 | | | | |
| | X6S | 22μF | ±20% | GRM21BC81A226ME44# | | | |
| | | | ±20% | GRM21BR61A226ME44# | | | |
| | | | ±20% | GRM21BR61A476ME15# | | | |
| 6.3Vdc | X7T | 22μF | ±20% | GRM21BD70J226ME44# | | | |
| | | | D1 | | | | |
| | | | D1 | | | | |
| | X5R | 47μF | ±20% | GRM21BR60J476ME15# | | | |
| | | | D1 | | | | |
| | | | D1 | | | | |
| 4Vdc | X6S | 47μF | ±20% | GRM21BC80G476ME15# | | | |
| | | | ±20% | GRM21BC80G107ME15# | | | |
| | | | D1 | | | | |
| | X5R | 47μF | ±20% | GRM21BR60G476ME15# | | | |
| | | | ±20% | GRM21BB30G476ME15# | | | |
| | | | D1 | | | | |
| 2.5Vdc | X6S | 100μF | ±20% | GRM21BC80E107ME15# | | | |

3.2×1.6mm

| T max. | Rated Voltage | TC Code | Cap. | Tol. | Part Number | | | |
|---------|---------------|--------------------|-----------|--------------------|--------------------|--------------------|--------------------|--------------------|
| 0.95mm | 35Vdc | X5R | 10μF | ±10% | GRM319R6YA106KA12# | | | |
| | | | | ±20% | GRM319R6YA106MA12# | | | |
| | | | 16Vdc | X5R | 10μF | ±10% | GRM319R61C106KE15# | |
| | | | | | | ±20% | GRM319R61C106ME15# | |
| | | | | B | 10μF | ±10% | GRM319B31C106KE15# | |
| | | | | | | ±20% | GRM319B31C106ME15# | |
| | 10Vdc | X5R | 22μF | ±20% | GRM319R61A226ME15# | | | |
| | | | | ±20% | GRM319B31A226ME15# | | | |
| | | | | D1 | | | | |
| | | 6.3Vdc | X6S | 22μF | ±20% | GRM319C80J226ME15# | | |
| | | | | | ±20% | GRM319R60J226ME15# | | |
| | | | | | ±20% | GRM319B30J226ME15# | | |
| 1.0mm | 630Vdc | X7R | 1000pF | ±10% | GRM31AR72J102KW01# | | | |
| | | | 1500pF | ±10% | GRM31AR72J152KW01# | | | |
| | | | 2200pF | ±10% | GRM31AR72J222KW01# | | | |
| | | | 3300pF | ±10% | GRM31AR72J332KW01# | | | |
| | | | 4700pF | ±10% | GRM31AR72J472KW01# | | | |
| | | | 6800pF | ±10% | GRM31AR72J682KW01# | | | |
| | | | 10000pF | ±10% | GRM31AR72J103KW01# | | | |
| | | | 1.25mm | 1000Vdc | X7R | 470pF | ±10% | GRM31BR73A471KW01# |
| | | | | | | 680pF | ±10% | GRM31BR73A681KW01# |
| | | | 630Vdc | X7R | 1000pF | ±10% | GRM31BR73A102KW01# | |
| | 1500pF | ±10% | | | GRM31BR73A152KW01# | | | |
| | 2200pF | ±10% | | | GRM31BR73A222KW01# | | | |
| 3300pF | ±10% | GRM31BR73A332KW01# | | | | | | |
| 4700pF | ±10% | GRM31BR73A472KW01# | | | | | | |
| 6800pF | ±10% | GRM31BR72J682KW01# | | | | | | |
| 500Vdc | X7R | 15000pF | | | ±10% | GRM31BR72H153KW10# | | |
| 22000pF | ±10% | GRM31BR72H223KW10# | | | | | | |
| 250Vdc | X7R | 15000pF | | | ±10% | GRM31BR72E153KW01# | | |
| 22000pF | ±10% | GRM31BR72E223KW01# | | | | | | |
| 68000pF | ±10% | GRM31BR72E683KW01# | | | | | | |
| 200Vdc | X7R | 15000pF | ±10% | GRM31BR72D153KW01# | | | | |
| 22000pF | ±10% | GRM31BR72D223KW01# | | | | | | |
| 68000pF | ±10% | GRM31BR72D683KW01# | | | | | | |
| 50Vdc | B | 1.0μF | ±10% | GRM31MB31H105KA87# | | | | |
| 25Vdc | X5R | 10μF | ±20% | GRM31MR61E106MA12# | | | | |
| 1.8mm | 1000Vdc | X7R | 6800pF | ±10% | GRM31CR73A682KW03# | | | |
| | | | 10000pF | ±10% | GRM31CR73A103KW03# | | | |
| | | | D1 | | | | | |
| | 630Vdc | X7R | 15000pF | ±10% | GRM31CR72J153KW03# | | | |
| | | | | ±10% | GRM31CR72J223KW03# | | | |
| | | | | D1 | | | | |
| | 500Vdc | X7R | 33000pF | ±10% | GRM31CR72H333KW09# | | | |
| | | | | ±10% | GRM31CR72H473KW09# | | | |
| | | | | D1 | | | | |
| | 250Vdc | X7R | 33000pF | ±10% | GRM31CR72E333KW03# | | | |
| | | | | ±10% | GRM31CR72E473KW03# | | | |
| | | | | ±10% | GRM31CR72E104KW03# | | | |
| 200Vdc | X7R | 33000pF | ±10% | GRM31CR72D333KW03# | | | | |
| | | | ±10% | GRM31CR72D473KW03# | | | | |
| | | | ±10% | GRM31CR72D104KW03# | | | | |
| 100Vdc | X7R | 1.0μF | ±10% | GRM31CR72A105KA01# | | | | |
| 50Vdc | X7R | 4.7μF | ±10% | GRM31CR71H475KA12# | | | | |

Part number # indicates the package specification code.

GRM Series High Dielectric Constant Type Part Number List

(→ 3.2×1.6mm)

| T max. | Rated Voltage | TC Code | Cap. | Tol. | Part Number | |
|--------|---------------|---------|-------|--------------------|--------------------|------------------------------|
| 1.8mm | 50Vdc | X7R | 4.7μF | ±20% | GRM31CR71H475MA12# | |
| | | | 10μF | ±10% | GRM31CR61H106KA12# | |
| | | | | ±20% | GRM31CR61H106MA12# | |
| | | B | 4.7μF | ±10% | GRM31CB31H475KA12# | |
| | | | | ±20% | GRM31CB31H475MA12# | |
| | | | 10μF | ±10% | GRM31CB31H106KA12# | |
| | | | | ±20% | GRM31CB31H106MA12# | |
| | | 25Vdc | X7R | 10μF | ±10% | GRM31CR71E106KA12# |
| | | | | | ±20% | GRM31CR71E106MA12# |
| | | | | X5R | 22μF | ±20% |
| | | | B | 10μF | ±10% | GRM31CB31E106KA75# |
| | | | | 22μF | ±20% | GRM31CB31E226ME15# |
| | 16Vdc | | X6S | 22μF | ±20% | GRM31CC81C226ME15# |
| | | 22μF | | ±20% | GRM31CR61C226ME15# | |
| | | B | 22μF | ±20% | GRM31CB31C226ME15# | |
| | 10Vdc | X7R | 22μF | ±20% | GRM31CR71A226ME15# | |
| | | | X5R | 47μF | ±20% | GRM31CR61A476ME15# |
| | | B | 47μF | ±20% | GRM31CB31A476ME15# | |
| | 6.3Vdc | X7R | 22μF | ±20% | GRM31CR70J226ME19# | |
| | | | X7U | 47μF | ±20% | GRM31CE70J476ME15# D1 |
| | | X6S | 47μF | ±20% | GRM31CC80J476ME18# | |
| | | | X5R | 47μF | ±20% | GRM31CR60J476ME19# |
| | B | 47μF | ±20% | GRM31CB30J476ME18# | | |
| | | 4Vdc | X7U | 47μF | ±20% | GRM31CE70G476ME15# |
| | X6S | | | 47μF | ±20% | GRM31CC80G476ME19# |
| | 1.9mm | 25Vdc | X6S | 22μF | ±20% | GRM31CC81E226ME11# |
| | | | | X7S | 22μF | ±20% |
| | | 16Vdc | X5R | 47μF | ±20% | GRM31CR61C476ME44# |
| | | | | X6S | 47μF | ±20% |
| | | 10Vdc | X5R | 100μF | ±20% | GRM31CR61A107ME05# D1 |
| | | | | X6T | 100μF | ±20% |
| | | 6.3Vdc | X5R | 100μF | ±20% | GRM31CR60J107ME39# |
| | | | | 150μF | ±20% | GRM31CR60J157ME11# D1 |
| | | | X7U | 100μF | ±20% | GRM31CE70G107ME39# D1 |
| | | 4Vdc | X6S | 150μF | ±20% | GRM31CC80G157ME11# D1 |
| | | | | X6T | 100μF | ±20% |
| X5R | | | 100μF | ±20% | GRM31CR60G107ME39# | |
| | | | 150μF | ±20% | GRM31CR60G157ME11# | |
| | | 220μF | ±20% | GRM31CR60G227ME11# | | |
| 2.5Vdc | | X6S | 150μF | ±20% | GRM31CC80E157ME11# | |
| | | | X5R | 220μF | ±20% | GRM31CR60E227ME11# |

3.2×2.5mm

| T max. | Rated Voltage | TC Code | Cap. | Tol. | Part Number |
|--------|---------------|---------|---------|------|--------------------|
| 1.5mm | 1000Vdc | X7R | 6800pF | ±10% | GRM32QR73A682KW01# |
| | | | 10000pF | ±10% | GRM32QR73A103KW01# |
| | 630Vdc | X7R | 22000pF | ±10% | GRM32QR72J223KW01# |
| | | | 500Vdc | X7R | 68000pF |
| | 250Vdc | X7R | 68000pF | ±10% | GRM32QR72E683KW01# |
| | | | 0.15μF | ±10% | GRM32QR72E154KW01# |
| | 200Vdc | X7R | 68000pF | ±10% | GRM32QR72D683KW01# |
| | | | 0.15μF | ±10% | GRM32QR72D154KW01# |

| T max. | Rated Voltage | TC Code | Cap. | Tol. | Part Number |
|--------|---------------|---------|--------------------|------------------------------|------------------------------|
| 1.8mm | 100Vdc | X7R | 1.0μF | ±10% | GRM32CR72A105KA35# |
| | | | | ±20% | GRM32CR72A105MA35# |
| 2.0mm | 1000Vdc | X7R | 15000pF | ±10% | GRM32DR73A153KW01# |
| | | | | 22000pF | ±10% |
| | 630Vdc | X7R | 33000pF | ±10% | GRM32DR72J333KW01# |
| | | | | 47000pF | ±10% |
| | 500Vdc | X7R | 0.10μF | ±10% | GRM32DR72H104KW10# |
| | 250Vdc | X7R | 0.10μF | ±10% | GRM32DR72E104KW01# |
| 0.22μF | | | | ±10% | GRM32DR72E224KW01# |
| 200Vdc | X7R | 0.10μF | ±10% | GRM32DR72D104KW01# | |
| | | | 0.22μF | ±10% | GRM32DR72D224KW01# |
| 2.2mm | 100Vdc | X7S | 4.7μF | ±10% | GRM32DC72A475KE01# |
| | | | | ±20% | GRM32DC72A475ME01# |
| 25Vdc | X7R | 10μF | ±10% | GRM32DR71E106KA12# | |
| | | | ±20% | GRM32DR71E106MA12# | |
| 2.7mm | 100Vdc | X7R | 2.2μF | ±10% | GRM32ER72A225KA35# |
| | | | | ±20% | GRM32ER72A225MA35# |
| | 80Vdc | X7R | 4.7μF | ±10% | GRM32ER71K475KE14# D1 |
| | | | | ±20% | GRM32ER71K475ME14# D1 |
| 63Vdc | X7R | 10μF | ±10% | GRM32ER71J106KA12# D1 | |
| | | | ±20% | GRM32ER71J106MA12# D1 | |
| 50Vdc | X7R | 4.7μF | ±10% | GRM32ER71H475KA88# | |
| | | | 10μF | ±10% | GRM32ER71H106KA12# |
| | | ±20% | GRM32ER71H106MA12# | | |
| | X5R | 10μF | ±10% | GRM32ER61H106KA12# | |
| | | | ±20% | GRM32ER61H106MA12# | |
| | | B | 10μF | ±10% | GRM32EB31H106KA12# |
| | | ±20% | GRM32EB31H106MA12# | | |
| 35Vdc | X7R | 10μF | ±10% | GRM32ER7YA106KA12# | |
| | | | ±20% | GRM32ER7YA106MA12# | |
| | X5R | 10μF | ±10% | GRM32ER6YA106KA12# | |
| | | | ±20% | GRM32ER6YA106MA12# | |
| 25Vdc | X7R | 22μF | ±10% | GRM32ER71E226ME15# | |
| | | | ±20% | GRM32ER61E226ME15# | |
| | B | 22μF | ±10% | GRM32EB31E226ME15# | |
| | | | ±20% | GRM32EB31E226MA15# | |
| 16Vdc | X7R | 22μF | ±10% | GRM32ER71C226ME15# | |
| | | | ±20% | GRM32EC81C476ME15# D1 | |
| | X5R | 47μF | ±10% | GRM32ER61C476ME15# | |
| | | | ±20% | GRM32EB31C476ME15# | |
| 10Vdc | X7R | 47μF | ±10% | GRM32ER71A476ME15# | |
| | | | ±20% | GRM32ER61A476ME20# | |
| | X5R | 100μF | ±10% | GRM32ER61A107ME20# D1 | |
| | | | ±20% | GRM32EB31A476ME20# | |
| 6.3Vdc | X7R | 47μF | ±10% | GRM32ER70J476ME20# | |
| | | | ±20% | GRM32EE70J107ME15# D1 | |
| 4Vdc | X7U | 100μF | ±10% | GRM32ER60J107ME20# | |
| | | | ±20% | GRM32EB30J107ME16# | |
| | | | ±10% | GRM32EE70G107ME19# | |

Part number # indicates the package specification code.

GRM Series High Dielectric Constant Type Part Number List

4.5×3.2mm

| T max. | Rated Voltage | TC Code | Cap. | Tol. | Part Number |
|--------|---------------|---------|---------|------|--------------------|
| 1.5mm | 630Vdc | X7R | 68000pF | ±10% | GRM43QR72J683KW01# |
| | 500Vdc | X7R | 0.15μF | ±10% | GRM43QR72H154KW10# |
| | 250Vdc | X7R | 0.15μF | ±10% | GRM43QR72E154KW01# |
| | 200Vdc | X7R | 0.15μF | ±10% | GRM43QR72D154KW01# |
| 2.0mm | 1000Vdc | X7R | 33000pF | ±10% | GRM43DR73A333KW01# |
| | | | 47000pF | ±10% | GRM43DR73A473KW01# |
| | 630Vdc | X7R | 0.10μF | ±10% | GRM43DR72J104KW01# |
| | 500Vdc | X7R | 0.22μF | ±10% | GRM43DR72H224KW10# |
| | 250Vdc | X7R | 0.22μF | ±10% | GRM43DR72E224KW01# |
| | | | 0.33μF | ±10% | GRM43DR72E334KW01# |
| | | | 0.47μF | ±10% | GRM43DR72E474KW01# |
| | 200Vdc | X7R | 0.22μF | ±10% | GRM43DR72D224KW01# |
| | | | 0.33μF | ±10% | GRM43DR72D334KW01# |
| | | | 0.47μF | ±10% | GRM43DR72D474KW01# |

5.7×5.0mm

| T max. | Rated Voltage | TC Code | Cap. | Tol. | Part Number |
|--------|---------------|---------|---------|------|--------------------|
| 2.0mm | 1000Vdc | X7R | 68000pF | ±10% | GRM55DR73A683KW01# |
| | | | 0.10μF | ±10% | GRM55DR73A104KW01# |
| | 630Vdc | X7R | 0.15μF | ±10% | GRM55DR72J154KW01# |
| | | | 0.22μF | ±10% | GRM55DR72J224KW01# |
| | 500Vdc | X7R | 0.33μF | ±10% | GRM55DR72H334KW10# |
| | | | 0.47μF | ±10% | GRM55DR72H474KW10# |
| | 250Vdc | X7R | 0.33μF | ±10% | GRM55DR72E334KW01# |
| | | | 0.47μF | ±10% | GRM55DR72E474KW01# |
| | | | 0.68μF | ±10% | GRM55DR72E684KW01# |
| | | | 1.0μF | ±10% | GRM55DR72E105KW01# |
| | 200Vdc | X7R | 0.33μF | ±10% | GRM55DR72D334KW01# |
| | | | 0.47μF | ±10% | GRM55DR72D474KW01# |
| | | | 0.68μF | ±10% | GRM55DR72D684KW01# |
| | | | 1.0μF | ±10% | GRM55DR72D105KW01# |

GRM
 GR3
 GRJ
 GR4
 GR7
 GJM
 GQM
 GA2
 GA3 GB
 GA3 GD
 GA3 GF
 LLL
 LLA
 LLM
 LLR
 NFM
 KPM
 KR3
 GMA
 GMD
 ⚠Caution /Notice

GRM Series Specifications and Test Methods

Specifications and Test Methods, please refer to the search web page.
<https://www.murata.com/en-global/products/capacitor>

GRM Series Temperature Compensating

0.4×0.2mm

| T max. | Rated Voltage | TC Code | Cap. | Tol. | Part Number |
|--------|---------------|--------------------|--------|---------|--------------------|
| 0.22mm | 50Vdc | COG | 0.20pF | ±0.05pF | GRM0225C1HR20WA03# |
| | | | | ±0.1pF | GRM0225C1HR20BA03# |
| | | | 0.30pF | ±0.05pF | GRM0225C1HR30WA03# |
| | | | | ±0.1pF | GRM0225C1HR30BA03# |
| | | | 0.40pF | ±0.05pF | GRM0225C1HR40WA03# |
| | | | | ±0.1pF | GRM0225C1HR40BA03# |
| 0.50pF | ±0.05pF | GRM0225C1HR50WA03# | | | |
| | ±0.1pF | GRM0225C1HR50BA03# | | | |

Links are provided to the product detail pages on the web, and are shown below in the product number table from the PDF version of the catalog which is available on the web.



Detailed Specifications Sheet

- Rated value
- Specifications and Test Methods
- Package
- Caution, Notice

Specifications and Test Methods

| No | Item | Specification | Test Method (Ref. Standard: JIS C 5101, IEC60384) | | | | | | | | | | | | |
|------------------------|--|---|---|-------------|-----------------|---------|-------------------------|--------------|------------------------------|---------------------|-------------------------|--------------|------------------------------|---|-------------------------|
| 1 | Rated Voltage | Shown in Rated value. | The rated voltage is defined as the maximum voltage which may be applied continuously to the capacitor. When AC voltage is superimposed on DC voltage, V^{P-P} or V^{2-P} , whichever is larger, should be maintained within the rated voltage range. | | | | | | | | | | | | |
| 2 | Appearance | No defects or abnormalities. | Visual inspection. | | | | | | | | | | | | |
| 3 | Dimension | Within the specified dimensions. | Using calipers. (GRM02 size is based on Microscope) | | | | | | | | | | | | |
| 4 | Voltage proof | No defects or abnormalities. | Measurement Point : Between the terminations Test Voltage : 300% of the rated voltage (Temperature compensating type) Applied Time : 1s to 5 s Charge/discharge current : 50mA max. | | | | | | | | | | | | |
| 5 | Insulation Resistance(I.R.) | $C \leq 0.047\mu\text{F}$: More than 1000MΩ $C > 0.047\mu\text{F}$: More than 500Ω·F C: Nominal Capacitance | Measurement Point : Between the terminations Measurement Voltage : DC Rated Voltage Charging Time : 1 min Charge/discharge current : 50mA max. Measurement Temperature : Room Temperature | | | | | | | | | | | | |
| 6 | Capacitance | Shown in Rated value. | Measurement Temperature : Room Temperature | | | | | | | | | | | | |
| 7 | Q or Dissipation Factor (D.F.) | 30pF and over: $Q \geq 1000$ 30pF and below: $Q \geq 400+20C$ C: Nominal Capacitance(pF) | (1) Temperature Compensating Type <table border="1"> <thead> <tr> <th>Capacitance</th> <th>Frequency</th> <th>Voltage</th> </tr> </thead> <tbody> <tr> <td>$C \leq 1000\text{pF}$</td> <td>1.0Hz-0.1MHz</td> <td>0.5 to 5.0Vrms</td> </tr> <tr> <td>$C > 1000\text{pF}$</td> <td>1.0Hz-0.1kHz</td> <td>1.0V±0.2Vrms</td> </tr> </tbody> </table> | Capacitance | Frequency | Voltage | $C \leq 1000\text{pF}$ | 1.0Hz-0.1MHz | 0.5 to 5.0Vrms | $C > 1000\text{pF}$ | 1.0Hz-0.1kHz | 1.0V±0.2Vrms | | | |
| Capacitance | Frequency | Voltage | | | | | | | | | | | | | |
| $C \leq 1000\text{pF}$ | 1.0Hz-0.1MHz | 0.5 to 5.0Vrms | | | | | | | | | | | | | |
| $C > 1000\text{pF}$ | 1.0Hz-0.1kHz | 1.0V±0.2Vrms | | | | | | | | | | | | | |
| 8 | Temperature Characteristics of Capacitance | Nominal values of the temperature coefficient is shown in Rated value. But, the Capacitance Change under 20°C is shown in Table A. Capacitance Drift Within $\pm 0.2\%$ or $\pm 0.05\text{pF}$ (Whichever is larger.) | The capacitance change should be measured after 5 min at each specified temp. stage. In case of applying voltage, the capacitance change should be measured after 1 min with applying voltage in equilibration of each temp. stage. Capacitance value as a reference is the value in step 3. The capacitance drift is calculated by dividing the differences between the maximum and minimum measured values in the step 1,3 and 5 by the cap. value in step 3. <table border="1"> <thead> <tr> <th>Step</th> <th>Temperature(°C)</th> </tr> </thead> <tbody> <tr> <td>1</td> <td>Reference Temp. ± 2</td> </tr> <tr> <td>2</td> <td>Min. Operating Temp. ± 3</td> </tr> <tr> <td>3</td> <td>Reference Temp. ± 2</td> </tr> <tr> <td>4</td> <td>Max. Operating Temp. ± 3</td> </tr> <tr> <td>5</td> <td>Reference Temp. ± 2</td> </tr> </tbody> </table> | Step | Temperature(°C) | 1 | Reference Temp. ± 2 | 2 | Min. Operating Temp. ± 3 | 3 | Reference Temp. ± 2 | 4 | Max. Operating Temp. ± 3 | 5 | Reference Temp. ± 2 |
| Step | Temperature(°C) | | | | | | | | | | | | | | |
| 1 | Reference Temp. ± 2 | | | | | | | | | | | | | | |
| 2 | Min. Operating Temp. ± 3 | | | | | | | | | | | | | | |
| 3 | Reference Temp. ± 2 | | | | | | | | | | | | | | |
| 4 | Max. Operating Temp. ± 3 | | | | | | | | | | | | | | |
| 5 | Reference Temp. ± 2 | | | | | | | | | | | | | | |

GRM
 GR3
 GRJ
 GR4
 GR7
 GJM
 GQM
 GA2
 GA3 GB
 GA3 GD
 GA3 GF
 LLL
 LLA
 LLM
 LLR
 NFM
 KRM
 KR3
 GMA
 GMD
 ⚠Caution /Notice

High Effective Capacitance & High Ripple Current Chip Multilayer Ceramic Capacitors for General Purpose

GR3 Series



This is a general purpose high ripple resistance product excellent in DC bias characteristics.

Features

- ① When a DC bias is applied, a capacitance higher than conventional products (X7R characteristics) can be acquired.

About twice the capacitance can be secured when DC200V is applied.

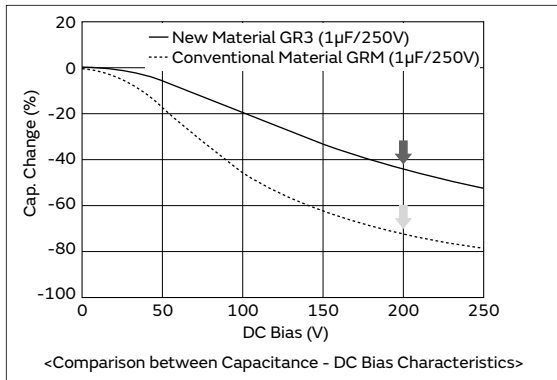

- ② Improved ripple resistance performance compared to conventional products (X7R characteristics).

In the case of a product with a capacitance of 1µF, when the exothermic temperature reaches 20°C at frequency f=300kHz, the amount of resistance of a product with conventional material is 2.9Arms; however, the new material is 4.7Arms.

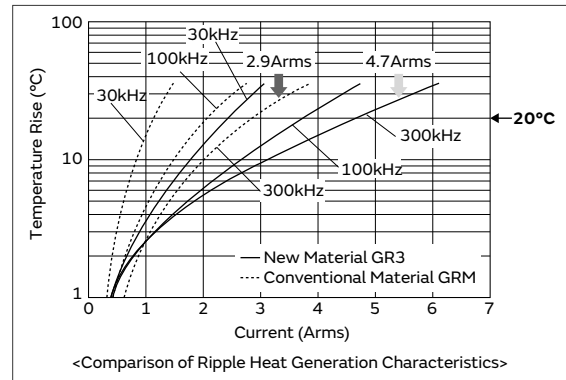

- ③ This product has a noise reduction effect.

Since dielectric materials which enable a reduction of noise are used, this product is more effective for reducing noise compared to the general purpose GRM series.

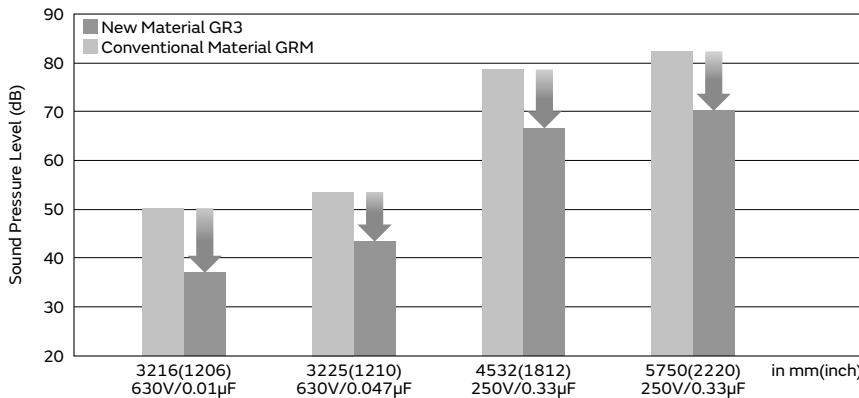

Specifications

| | |
|-------------------|--|
| Size (mm) | 2.0×1.25mm to 5.7×5.0mm |
| Rated Voltage | 250Vdc to 630Vdc |
| Capacitance | 10000pF to 1.0µF |
| Main Applications | For PFC (Power Factor Correction) Circuits of Power Supplies, EMI Suppression and Smoothing Circuits |



This catalog contains only a portion of the product lineup. Please refer to the capacitor search tool on the Murata Web site for details.

GR3 Series High Dielectric Constant Type Anti-noise Part Number List

2.0×1.25mm

| T max. | Rated Voltage | TC Code | Cap. | Tol. | Part Number | p* |
|--------|---------------|---------|---------|------|--------------------|------|
| 1.0mm | 250Vdc | X7T | 10000pF | ±10% | GR321AD72E103KW01# | p111 |
| | | | 15000pF | ±10% | GR321AD72E153KW01# | p111 |
| 1.45mm | 250Vdc | X7T | 22000pF | ±10% | GR321BD72E223KW03# | p111 |

| T max. | Rated Voltage | TC Code | Cap. | Tol. | Part Number | p* |
|--------|---------------|---------|-------|------|--------------------|------|
| 2.7mm | 250Vdc | X7T | 1.0μF | ±10% | GR355XD72E105KW05# | p111 |

3.2×1.6mm

| T max. | Rated Voltage | TC Code | Cap. | Tol. | Part Number | p* |
|--------|---------------|---------|---------|------|--------------------|------|
| 1.0mm | 450Vdc | X7T | 10000pF | ±10% | GR331AD72W103KW01# | p114 |
| | | | 15000pF | ±10% | GR331AD72W153KW01# | p114 |
| | 250Vdc | X7T | 33000pF | ±10% | GR331AD72E333KW01# | p111 |
| 1.25mm | 630Vdc | X7T | 10000pF | ±10% | GR331BD72J103KW01# | p117 |
| | 450Vdc | X7T | 22000pF | ±10% | GR331BD72W223KW01# | p114 |
| | | | 33000pF | ±10% | GR331BD72W333KW01# | p114 |
| | 250Vdc | X7T | 47000pF | ±10% | GR331BD72E473KW01# | p111 |
| 1.8mm | 630Vdc | X7T | 15000pF | ±10% | GR331CD72J153KW03# | p117 |
| | 450Vdc | X7T | 47000pF | ±10% | GR331CD72W473KW03# | p114 |
| | 250Vdc | X7T | 68000pF | ±10% | GR331CD72E683KW03# | p111 |

3.2×2.5mm

| T max. | Rated Voltage | TC Code | Cap. | Tol. | Part Number | p* |
|--------|---------------|---------|---------|------|--------------------|------|
| 1.5mm | 630Vdc | X7T | 22000pF | ±10% | GR332QD72J223KW01# | p117 |
| | 250Vdc | X7T | 0.10μF | ±10% | GR332QD72E104KW01# | p111 |
| 2.0mm | 630Vdc | X7T | 33000pF | ±10% | GR332DD72J333KW01# | p117 |
| | | | 47000pF | ±10% | GR332DD72J473KW01# | p117 |
| | 450Vdc | X7T | 68000pF | ±10% | GR332DD72W683KW01# | p114 |
| | | | 0.10μF | ±10% | GR332DD72W104KW01# | p114 |
| | 250Vdc | X7T | 0.15μF | ±10% | GR332DD72E154KW01# | p111 |

4.5×3.2mm

| T max. | Rated Voltage | TC Code | Cap. | Tol. | Part Number | p* |
|--------|---------------|---------|---------|------|--------------------|------|
| 1.5mm | 250Vdc | X7T | 0.22μF | ±10% | GR343QD72E224KW01# | p111 |
| 2.0mm | 630Vdc | X7T | 68000pF | ±10% | GR343DD72J683KW01# | p117 |
| | 450Vdc | X7T | 0.15μF | ±10% | GR343DD72W154KW01# | p114 |
| | 250Vdc | X7T | 0.33μF | ±10% | GR343DD72E334KW01# | p111 |

5.7×5.0mm

| T max. | Rated Voltage | TC Code | Cap. | Tol. | Part Number | p* |
|--------|---------------|---------|--------|--------------------|--------------------|------|
| 2.0mm | 630Vdc | X7T | 0.10μF | ±10% | GR355DD72J104KW01# | p117 |
| | | | 0.15μF | ±10% | GR355DD72J154KW01# | p117 |
| | 450Vdc | X7T | 0.22μF | ±10% | GR355DD72W224KW01# | p114 |
| | | | 0.33μF | ±10% | GR355DD72W334KW01# | p114 |
| | | | 0.47μF | ±10% | GR355DD72W474KW01# | p114 |
| | 250Vdc | X7T | 0.47μF | ±10% | GR355DD72E474KW01# | p111 |
| 0.68μF | | | ±10% | GR355DD72E684KW01# | p111 | |
| 2.7mm | 630Vdc | X7T | 0.22μF | ±10% | GR355XD72J224KW05# | p117 |

*: Refers to the page of the "Specifications and Test Methods".

Part number # indicates the package specification code.

GRM
 GR3
 GRJ
 GR4
 GR7
 GJM
 GQM
 GA2
 GA3 GB
 GA3 GD
 GA3 GF
 LLL
 LLA
 LLM
 LLR
 NFM
 KRM
 KR3
 GMA
 GMD
 ⚠Caution /Notice

1

GR3 Series Specifications and Test Methods (1)

| No | Item | Specification | Test Method (Ref. Standard: JIS C 5101, IEC60384) | | | | | | | | | | | | |
|------|--|--|---|------|------------------|---|--------------------|---|-------------------------|---|--------------------|---|-------------------------|---|--------------------|
| 1 | Appearance | No defects or abnormalities. | Visual inspection. | | | | | | | | | | | | |
| 2 | Dimension | Within the specified dimensions. | Using calipers and micrometers. | | | | | | | | | | | | |
| 3 | Voltage Proof | No defects or abnormalities. | Measurement Point: Between the terminations Test Voltage: DC500V (200% of the rated voltage) Applied Time: 1 to 5s Charge/discharge current: 50mA max. | | | | | | | | | | | | |
| 4 | Insulation Resistance (I.R.) | More than 10000MΩ or 100MΩ · μF (Whichever is smaller) | Measurement Point: Between the terminations Measurement Voltage: DC250±25V Charging Time: 60±5s Measurement Temperature: Room Temperature | | | | | | | | | | | | |
| 5 | Capacitance | Shown in Rated value. | Measurement Temperature: Room Temperature | | | | | | | | | | | | |
| 6 | Dissipation Factor (D.F.) | 0.01 max. | Measurement Frequency: 1.0±0.1kHz Measurement Voltage: AC1.0±0.2V (r.m.s.) | | | | | | | | | | | | |
| 7 | Temperature Characteristics of Capacitance | D7: Within +22/-33% (-55 to +125°C) | The capacitance change should be measured after 5 minutes at each specified temp. stage. Capacitance value as a reference is the value in step 3. <table border="1"> <thead> <tr> <th>Step</th> <th>Temperature (°C)</th> </tr> </thead> <tbody> <tr> <td>1</td> <td>Reference Temp. ±2</td> </tr> <tr> <td>2</td> <td>Min. Operating Temp. ±3</td> </tr> <tr> <td>3</td> <td>Reference Temp. ±2</td> </tr> <tr> <td>4</td> <td>Max. Operating Temp. ±3</td> </tr> <tr> <td>5</td> <td>Reference Temp. ±2</td> </tr> </tbody> </table> <ul style="list-style-type: none"> • Pretreatment Perform a heat treatment at 150+0/-10°C for 1h±5min and then let sit for 24±2h at room condition*. | Step | Temperature (°C) | 1 | Reference Temp. ±2 | 2 | Min. Operating Temp. ±3 | 3 | Reference Temp. ±2 | 4 | Max. Operating Temp. ±3 | 5 | Reference Temp. ±2 |
| Step | Temperature (°C) | | | | | | | | | | | | | | |
| 1 | Reference Temp. ±2 | | | | | | | | | | | | | | |
| 2 | Min. Operating Temp. ±3 | | | | | | | | | | | | | | |
| 3 | Reference Temp. ±2 | | | | | | | | | | | | | | |
| 4 | Max. Operating Temp. ±3 | | | | | | | | | | | | | | |
| 5 | Reference Temp. ±2 | | | | | | | | | | | | | | |
| 8 | Vibration | Appearance | Solder the capacitor on the test substrate A shown in "Complement of Test Method". Kind of Vibration: A simple harmonic motion 10Hz to 55Hz to 10Hz (1min) Total amplitude: 1.5mm This motion should be applied for a period of 2h in each 3 mutually perpendicular directions (total of 6h). | | | | | | | | | | | | |
| | | Capacitance | | | | | | | | | | | | | |
| | | D.F. | | | | | | | | | | | | | |
| 9 | Solderability | 95% of the terminations is to be soldered evenly and continuously. | Test Method: Solder bath method Flux: Solution of rosin ethanol 25 (wt)% Preheat: 80 to 120°C for 10 to 30s Solder: Sn-3.0Ag-0.5Cu (Lead Free Solder) Solder Temp.: 245±5°C Immersion time: 2±0.5s Immersing in speed: 25±2.5mm/s. | | | | | | | | | | | | |
| 10 | Resistance to Soldering Heat | Appearance | Test Method: Solder bath method Solder: Sn-3.0Ag-0.5Cu (Lead Free Solder) Solder Temp.: 260±5°C Immersion time: 10±1s Immersing in speed: 25±2.5mm/s. Exposure Time: 24±2h at room condition*. Preheat: GR331 size max.: 120 to 150°C for 1min GR332 size min.: 100 to 120°C for 1min and 170 to 200°C for 1min <ul style="list-style-type: none"> • Pretreatment Perform a heat treatment at 150+0/-10°C for 1h±5min and then let sit for 24±2h at room condition*. | | | | | | | | | | | | |
| | | Capacitance Change | | | | | | | | | | | | | |
| | | D.F. | | | | | | | | | | | | | |
| | | I.R. | | | | | | | | | | | | | |
| | | Voltage Proof | | | | | | | | | | | | | |
| 11 | Adhesive Strength of Termination | No removal of the terminations or other defect should occur. | Solder the capacitor on the test substrate A shown in "Complement of Test Method".  Applied Direction: In parallel with the test substrate and vertical with the capacitor side. | | | | | | | | | | | | |
| 12 | Substrate Bending Test | No defects or abnormalities. | Solder the capacitor on the test substrate B shown in "Complement of Test Method". Then apply the force in the direction shown in "Test Method of Substrate Bending Test" of "Complement of Test Method". Flexure: 2mm (GR321 size: 1mm) Holding Time: 5±1s Soldering Method: Reflow soldering | | | | | | | | | | | | |

* Room Condition: Temperature: 15 to 35°C, Relative humidity: 45 to 75%, Atmosphere pressure: 86 to 106kPa

Continued on the following page. ↗

GRM
 GR3
 GRJ
 GR4
 GR7
 GJM
 GQM
 GA2
 GA3 GB
 GA3 GD
 GA3 GF
 LLL
 LLA
 LLM
 LLR
 NFM
 KPM
 KR3
 GMA
 GMD
 △Caution / Notice

GR3 Series Specifications and Test Methods (1)

Continued from the preceding page. ↘

| No | Item | Specification | Test Method (Ref. Standard: JIS C 5101, IEC60384) | | | | | | | | | | | | | | | |
|--------------------|---|--|---|------------|------------|------------|---|----------------------------|------|---|------------|--------|---|----------------------------|------|---|------------|--------|
| 13 | Temperature Sudden Change | Appearance | Fix the capacitor to the supporting Test substrate A (glass epoxy board) shown in "Complement of Test Method". Perform the 5 cycles according to the four heat treatments shown in the following table. <table border="1" style="margin: 10px 0;"> <thead> <tr> <th>Step</th> <th>Temp. (°C)</th> <th>Time (min)</th> </tr> </thead> <tbody> <tr> <td>1</td> <td>Min. Operating Temp. +0/-3</td> <td>30±3</td> </tr> <tr> <td>2</td> <td>Room Temp.</td> <td>2 to 3</td> </tr> <tr> <td>3</td> <td>Max. Operating Temp. +3/-0</td> <td>30±3</td> </tr> <tr> <td>4</td> <td>Room Temp.</td> <td>2 to 3</td> </tr> </tbody> </table> Exposure Time: 24±2h at room condition*. • Pretreatment Perform a heat treatment at 150+0/-10°C for 1h±5min and then let sit for 24±2h. at room condition *. | Step | Temp. (°C) | Time (min) | 1 | Min. Operating Temp. +0/-3 | 30±3 | 2 | Room Temp. | 2 to 3 | 3 | Max. Operating Temp. +3/-0 | 30±3 | 4 | Room Temp. | 2 to 3 |
| | Step | Temp. (°C) | | Time (min) | | | | | | | | | | | | | | |
| | 1 | Min. Operating Temp. +0/-3 | | 30±3 | | | | | | | | | | | | | | |
| | 2 | Room Temp. | | 2 to 3 | | | | | | | | | | | | | | |
| | 3 | Max. Operating Temp. +3/-0 | | 30±3 | | | | | | | | | | | | | | |
| 4 | Room Temp. | 2 to 3 | | | | | | | | | | | | | | | | |
| Capacitance Change | Within ±7.5% | | | | | | | | | | | | | | | | | |
| D.F. | Within the specified initial value. | | | | | | | | | | | | | | | | | |
| I.R. | Within the specified initial value. | | | | | | | | | | | | | | | | | |
| Voltage Proof | No defects. | | | | | | | | | | | | | | | | | |
| 14 | High Temperature High Humidity (Steady) | Appearance | Fix the capacitor to the supporting Test substrate A (glass epoxy board) shown in "Complement of Test Method". Test Temperature: 40±2°C Test Humidity: 90 to 95%RH Test Time: 500+24/-0h Applied Voltage: DC250V(DC Rated Voltage) Exposure Time: 24±2h at room condition*. • Pretreatment Apply test voltage for 1h±5min at test temperature. Remove and let sit for 24±2h at room condition*. | | | | | | | | | | | | | | | |
| | Capacitance Change | Within ±12.5% | | | | | | | | | | | | | | | | |
| | D.F. | 0.02 max. | | | | | | | | | | | | | | | | |
| | I.R. | More than 1000MΩ or 10MΩ • μF (Whichever is smaller) | | | | | | | | | | | | | | | | |
| | Voltage Proof | No defects. | | | | | | | | | | | | | | | | |
| 15 | Durability | Appearance | Fix the capacitor to the supporting Test substrate A (glass epoxy board) shown in "Complement of Test Method". Test Temperature: Max. Operating Temp. ±3°C Test Time: 1000+48/-0h Applied Voltage: DC375V (150% of the rated voltage) Charge/discharge current: 50mA max. Exposure Time: 24±2h at room condition*. • Pretreatment Apply test voltage for 1h±5min at test temperature. Remove and let sit for 24±2h at room condition*. | | | | | | | | | | | | | | | |
| | Capacitance Change | Within ±12.5% | | | | | | | | | | | | | | | | |
| | D.F. | 0.02 max. | | | | | | | | | | | | | | | | |
| | I.R. | More than 1000MΩ or 10MΩ • μF (Whichever is smaller) | | | | | | | | | | | | | | | | |
| | Voltage Proof | No defects. | | | | | | | | | | | | | | | | |

* Room Condition: Temperature: 15 to 35°C, Relative humidity: 45 to 75%, Atmosphere pressure: 86 to 106kPa

Continued on the following page. ↗

GRM
 GR3
 GRJ
 GR4
 GR7
 GJM
 GQM
 GA2
 GA3 GB
 GA3 GD
 GA3 GF
 LLL
 LLA
 LLM
 LLR
 NFM
 KRM
 KR3
 GMA
 GMD
 ⚠Caution /Notice

GR3 Series Specifications and Test Methods (1)

Continued from the preceding page. ↘

Complement of Test Method

1. Test Substrate

The test substrate should be Substrate A or Substrate B as described in "Specifications and Test Methods".
 The specimen should be soldered by the conditions as described below.

Soldering Method: Reflow soldering
 Solder: Sn-3.0Ag-0.5Cu

(1) Test Substrate A

• Land Dimensions



- Material: Glass Epoxy Board
- Thickness: 1.6mm
- Thickness of Copper Foil: 0.035mm

| Part Number | Dimension (mm) | | |
|-------------|----------------|-----|------|
| | a | b | c |
| GR321 | 1.2 | 4.0 | 1.65 |
| GR331 | 2.2 | 5.0 | 2.0 |
| GR332 | 2.2 | 5.0 | 2.9 |
| GR342 | 3.5 | 7.0 | 2.4 |
| GR343 | 3.5 | 7.0 | 3.7 |
| GR352 | 4.5 | 8.0 | 3.2 |
| GR355 | 4.5 | 8.0 | 5.6 |

(2) Test Substrate B

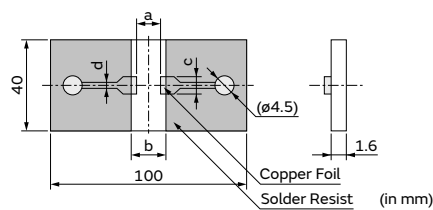

- Material: Glass Epoxy Board
- Thickness of Copper Foil: 0.035mm

| Part Number | Dimension (mm) | | | |
|-------------|----------------|-----|------|-----|
| | a | b | c | d |
| GR321 | 1.2 | 4.0 | 1.65 | 1.0 |
| GR331 | 2.2 | 5.0 | 2.0 | 1.0 |
| GR332 | 2.2 | 5.0 | 2.9 | 1.0 |
| GR342 | 3.5 | 7.0 | 2.4 | 1.0 |
| GR343 | 3.5 | 7.0 | 3.7 | 1.0 |
| GR352 | 4.5 | 8.0 | 3.2 | 1.0 |
| GR355 | 4.5 | 8.0 | 5.6 | 1.0 |

2. Test Method of Substrate Bending Test

(a) Support State



a: ±2 gap between support stand center and test stand

- Material of Test Stand and Pressure Stick
 The material should be a metal where a remarkable transformation and the distortion are not caused even if it is pressurized.
- Pressurizing Speed
 The pressurizing speed is pressurized at the speed of about 1mm/s until the flexure reaches a regulated value.



(b) Test State

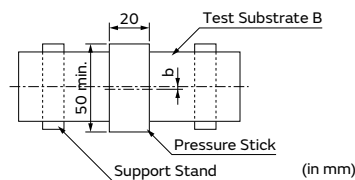

b: ±5 gap between support stand center and test stand center

GRM
 GR3
 GRJ
 GR4
 GR7
 GJM
 GQM
 GA2
 GA3 GB
 GA3 GD
 GA3 GF
 LLL
 LLA
 LLM
 LLR
 NFM
 KPM
 KR3
 GMA
 GMD
 ⚠Caution / Notice

2

GR3 Series Specifications and Test Methods (2)

| No | Item | Specification | Test Method (Ref. Standard: JIS C 5101, IEC60384) | | | | | | | | | |
|------|--|--|---|------|------------------|---|--------------------|---|-------------------------|---|--------------------|---|
| 1 | Appearance | No defects or abnormalities. | Visual inspection. | | | | | | | | | |
| 2 | Dimension | Within the specified dimensions. | Using calipers and micrometers. | | | | | | | | | |
| 3 | Voltage Proof | No defects or abnormalities. | Measurement Point: Between the terminations Test Voltage: DC675V (150% of the rated voltage) Applied Time: 1 to 5s Charge/discharge current: 50mA max. | | | | | | | | | |
| 4 | Insulation Resistance (I.R.) | More than 10000MΩ or 100MΩ • μF (Whichever is smaller) | Measurement Point: Between the terminations Measurement Voltage: DC250±25V Charging Time: 60±5s Measurement Temperature: Room Temperature | | | | | | | | | |
| 5 | Capacitance | Shown in Rated value. | Measurement Temperature: Room Temperature | | | | | | | | | |
| 6 | Dissipation Factor (D.F.) | 0.01 max. | Measurement Frequency: 1.0±0.1kHz Measurement Voltage: AC1.0±0.2V (r.m.s.) | | | | | | | | | |
| 7 | Temperature Characteristics of Capacitance | D7: Within +22/-33% (-55 to +125°C) | The capacitance change should be measured after 5 minutes at each specified temp. stage. Capacitance value as a reference is the value in step 3. | | | | | | | | | |
| | | | <table border="1"> <thead> <tr> <th>Step</th> <th>Temperature (°C)</th> </tr> </thead> <tbody> <tr> <td>1</td> <td>Reference Temp. ±2</td> </tr> <tr> <td>2</td> <td>Min. Operating Temp. ±3</td> </tr> <tr> <td>3</td> <td>Reference Temp. ±2</td> </tr> <tr> <td>4</td> <td>Max. Operating Temp. ±3</td> </tr> <tr> <td>5</td> <td>Reference Temp. ±2</td> </tr> </tbody> </table> <p>• Pretreatment Perform a heat treatment at 150+0/-10°C for 1h±5min and then let sit for 24±2h at room condition*.</p> | Step | Temperature (°C) | 1 | Reference Temp. ±2 | 2 | Min. Operating Temp. ±3 | 3 | Reference Temp. ±2 | 4 |
| Step | Temperature (°C) | | | | | | | | | | | |
| 1 | Reference Temp. ±2 | | | | | | | | | | | |
| 2 | Min. Operating Temp. ±3 | | | | | | | | | | | |
| 3 | Reference Temp. ±2 | | | | | | | | | | | |
| 4 | Max. Operating Temp. ±3 | | | | | | | | | | | |
| 5 | Reference Temp. ±2 | | | | | | | | | | | |
| 8 | Vibration | Appearance | No defects or abnormalities. | | | | | | | | | |
| | | Capacitance | Within the specified initial value. | | | | | | | | | |
| | | D.F. | Within the specified initial value. | | | | | | | | | |
| 9 | Solderability | 95% of the terminations is to be soldered evenly and continuously. | Test Method: Solder bath method Flux: Solution of rosin ethanol 25 (wt)% Preheat: 80 to 120°C for 10 to 30s Solder: Sn-3.0Ag-0.5Cu (Lead Free Solder) Solder Temp.: 245±5°C Immersion time: 2±0.5s Immersing in speed: 25±2.5mm/s. | | | | | | | | | |
| 10 | Resistance to Soldering Heat | Appearance | No defects or abnormalities. | | | | | | | | | |
| | | Capacitance Change | Within ±10% | | | | | | | | | |
| | | D.F. | Within the specified initial value. | | | | | | | | | |
| | | I.R. | Within the specified initial value. | | | | | | | | | |
| | | Voltage Proof | No defects. | | | | | | | | | |
| 11 | Adhesive Strength of Termination | No removal of the terminations or other defect should occur. | Test Method: Solder bath method Solder: Sn-3.0Ag-0.5Cu (Lead Free Solder) Solder Temp.: 260±5°C Immersion time: 10±1s Immersing in speed: 25±2.5mm/s. Exposure Time: 24±2h at room condition*. Preheat: GR331 size max.: 120 to 150°C for 1min GR332 size min.: 100 to 120°C for 1min and 170 to 200°C for 1min • Pretreatment Perform a heat treatment at 150+0/-10°C for 1h±5min and then let sit for 24±2h at room condition*. | | | | | | | | | |
| 12 | Substrate Bending Test | No defects or abnormalities. | Solder the capacitor on the test substrate B shown in "Complement of Test Method". Then apply the force in the direction shown in "Test Method of Substrate Bending Test" of "Complement of Test Method". Flexure: 2mm Holding Time: 5±1s Soldering Method: Reflow soldering | | | | | | | | | |

* Room Condition: Temperature: 15 to 35°C, Relative humidity: 45 to 75%, Atmosphere pressure: 86 to 106kPa

Continued on the following page. ↗

GRM
GR3
GRJ
GR4
GR7
GJM
GQM
GA2
GA3 GB
GA3 GD
GA3 GF
LLL
LLA
LLM
LLR
NFM
KRM
KR3
GMA
GMD
⚠Caution /Notice

GR3 Series Specifications and Test Methods (2)

Continued from the preceding page. ↘

| No | Item | Specification | Test Method (Ref. Standard: JIS C 5101, IEC60384) |
|----|---|--------------------|---|
| 13 | Temperature Sudden Change | Appearance | No defects or abnormalities. |
| | | Capacitance Change | Within $\pm 7.5\%$ |
| | | D.F. | Within the specified initial value. |
| | | I.R. | Within the specified initial value. |
| | | Voltage Proof | No defects. |
| 14 | High Temperature High Humidity (Steady) | Appearance | No defects or abnormalities. |
| | | Capacitance Change | Within $\pm 12.5\%$ |
| | | D.F. | 0.02 max. |
| | | I.R. | More than 1000M Ω or 10M $\Omega \cdot \mu\text{F}$ (Whichever is smaller) |
| | | Voltage Proof | No defects. |
| 15 | Durability | Appearance | No defects or abnormalities. |
| | | Capacitance Change | Within $\pm 12.5\%$ |
| | | D.F. | 0.02 max. |
| | | I.R. | More than 1000M Ω or 10M $\Omega \cdot \mu\text{F}$ (Whichever is smaller) |
| | | Voltage Proof | No defects. |

Fix the capacitor to the supporting Test substrate A (glass epoxy board) shown in "Complement of Test Method".
 Perform the 5 cycles according to the four heat treatments shown in the following table.

| Step | Temp. (°C) | Time (min) |
|------|----------------------------|------------|
| 1 | Min. Operating Temp. +0/-3 | 30 \pm 3 |
| 2 | Room Temp. | 2 to 3 |
| 3 | Max. Operating Temp. +3/-0 | 30 \pm 3 |
| 4 | Room Temp. | 2 to 3 |

Exposure Time: 24 \pm 2h at room condition*.
 • Pretreatment
 Perform a heat treatment at 150+0/-10°C for 1h \pm 5min and then let sit for 24 \pm 2h. at room condition*.

Fix the capacitor to the supporting Test substrate A (glass epoxy board) shown in "Complement of Test Method".
 Test Temperature: 40 \pm 2°C
 Test Humidity: 90 to 95%RH
 Test Time: 500+24/-0h
 Applied Voltage: DC450V (DC Rated Voltage)
 Exposure Time: 24 \pm 2h at room condition*.
 • Pretreatment
 Apply test voltage for 1h \pm 5min at test temperature.
 Remove and let sit for 24 \pm 2h at room condition*.

Fix the capacitor to the supporting Test substrate A (glass epoxy board) shown in "Complement of Test Method".
 Test Temperature: Max. Operating Temp. $\pm 3^\circ\text{C}$
 Test Time: 1000+48/-0h
 Applied Voltage: DC585V (130% of the rated voltage)
 Charge/discharge current: 50mA max.
 Exposure Time: 24 \pm 2h at room condition*.
 • Pretreatment
 Apply test voltage for 1h \pm 5min at test temperature.
 Remove and let sit for 24 \pm 2h at room condition*.

* Room Condition: Temperature: 15 to 35°C, Relative humidity: 45 to 75%, Atmosphere pressure: 86 to 106kPa

Continued on the following page. ↗

GRM
 GR3
 GRJ
 GR4
 GR7
 GJM
 GQM
 GA2
 GA3 GB
 GA3 GD
 GA3 GF
 LLL
 LLA
 LLM
 LLR
 NFM
 KPM
 KR3
 GMA
 GMD
 ⚠Caution / Notice

GR3 Series Specifications and Test Methods (2)

Continued from the preceding page. ↘

Complement of Test Method

1. Test Substrate

The test substrate should be Substrate A or Substrate B as described in "Specifications and Test Methods".
 The specimen should be soldered by the conditions as described below.

Soldering Method: Reflow soldering
 Solder: Sn-3.0Ag-0.5Cu

(1) Test Substrate A

- Land Dimensions

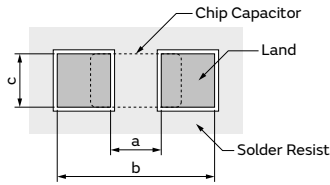

- Material: Glass Epoxy Board
- Thickness: 1.6mm
- Thickness of Copper Foil: 0.035mm

| Part Number | Dimension (mm) | | |
|-------------|----------------|-----|------|
| | a | b | c |
| GR318 | 1.0 | 3.0 | 1.2 |
| GR321 | 1.2 | 4.0 | 1.65 |
| GR331 | 2.2 | 5.0 | 2.0 |
| GR332 | 2.2 | 5.0 | 2.9 |
| GR342 | 3.5 | 7.0 | 2.4 |
| GR343 | 3.5 | 7.0 | 3.7 |
| GR352 | 4.5 | 8.0 | 3.2 |
| GR355 | 4.5 | 8.0 | 5.6 |

(2) Test Substrate B

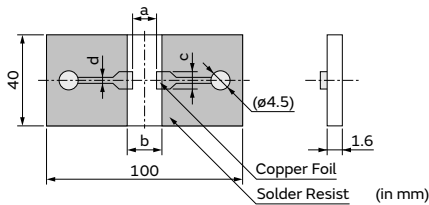

- Material: Glass Epoxy Board
- Thickness of Copper Foil: 0.035mm

| Part Number | Dimension (mm) | | | |
|-------------|----------------|-----|------|-----|
| | a | b | c | d |
| GR318 | 1.0 | 3.0 | 1.2 | 1.0 |
| GR321 | 1.2 | 4.0 | 1.65 | 1.0 |
| GR331 | 2.2 | 5.0 | 2.0 | 1.0 |
| GR332 | 2.2 | 5.0 | 2.9 | 1.0 |
| GR342 | 3.5 | 7.0 | 2.4 | 1.0 |
| GR343 | 3.5 | 7.0 | 3.7 | 1.0 |
| GR352 | 4.5 | 8.0 | 3.2 | 1.0 |
| GR355 | 4.5 | 8.0 | 5.6 | 1.0 |

2. Test Method of Substrate Bending Test

(a) Support State

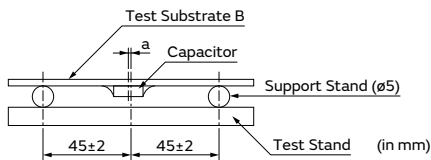

a: ±2 gap between support stand center and test stand

(b) Test State

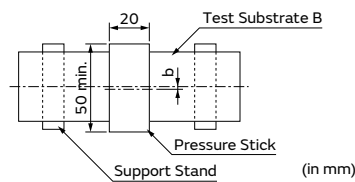

b: ±5 gap between support stand center and test stand center

- Material of Test Stand and Pressure Stick
 The material should be a metal where a remarkable transformation and the distortion are not caused even if it is pressurized.
- Pressurizing Speed
 The pressurizing speed is pressurized at the speed of about 1mm/s until the flexure reaches a regulated value.

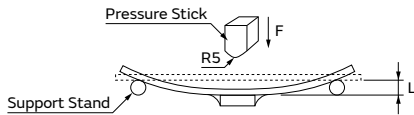

3

GR3 Series Specifications and Test Methods (3)

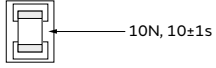
| No | Item | Specification | Test Method (Ref. Standard: JIS C 5101, IEC60384) | | | | | | | | | | | | |
|------|--|--|---|------|------------------|---|--------------------|---|-------------------------|---|--------------------|---|-------------------------|---|--------------------|
| 1 | Appearance | No defects or abnormalities. | Visual inspection. | | | | | | | | | | | | |
| 2 | Dimension | Within the specified dimensions. | Using calipers and micrometers. | | | | | | | | | | | | |
| 3 | Voltage Proof | No defects or abnormalities. | Measurement Point: Between the terminations Test Voltage: DC756V (120% of the rated voltage) Applied Time: 1 to 5s Charge/discharge current: 50mA max. | | | | | | | | | | | | |
| 4 | Insulation Resistance (I.R.) | More than 10000MΩ or 100MΩ · μF (Whichever is smaller) | Measurement Point: Between the terminations Measurement Voltage: DC500±50V Charging Time: 60±5s Measurement Temperature: Room Temperature | | | | | | | | | | | | |
| 5 | Capacitance | Shown in Rated value. | Measurement Temperature: Room Temperature | | | | | | | | | | | | |
| 6 | Dissipation Factor (D.F.) | 0.01 max. | Measurement Frequency: 1.0±0.1kHz Measurement Voltage: AC1.0±0.2V (r.m.s.) | | | | | | | | | | | | |
| 7 | Temperature Characteristics of Capacitance | D7: Within +22/-33% (-55 to +125°C) | The capacitance change should be measured after 5 minutes at each specified temp. stage. Capacitance value as a reference is the value in step 3. <table border="1"> <thead> <tr> <th>Step</th> <th>Temperature (°C)</th> </tr> </thead> <tbody> <tr> <td>1</td> <td>Reference Temp. ±2</td> </tr> <tr> <td>2</td> <td>Min. Operating Temp. ±3</td> </tr> <tr> <td>3</td> <td>Reference Temp. ±2</td> </tr> <tr> <td>4</td> <td>Max. Operating Temp. ±3</td> </tr> <tr> <td>5</td> <td>Reference Temp. ±2</td> </tr> </tbody> </table> <ul style="list-style-type: none"> • Pretreatment Perform a heat treatment at 150+0/-10°C for 1h±5min and then let sit for 24±2h at room condition*. | Step | Temperature (°C) | 1 | Reference Temp. ±2 | 2 | Min. Operating Temp. ±3 | 3 | Reference Temp. ±2 | 4 | Max. Operating Temp. ±3 | 5 | Reference Temp. ±2 |
| Step | Temperature (°C) | | | | | | | | | | | | | | |
| 1 | Reference Temp. ±2 | | | | | | | | | | | | | | |
| 2 | Min. Operating Temp. ±3 | | | | | | | | | | | | | | |
| 3 | Reference Temp. ±2 | | | | | | | | | | | | | | |
| 4 | Max. Operating Temp. ±3 | | | | | | | | | | | | | | |
| 5 | Reference Temp. ±2 | | | | | | | | | | | | | | |
| 8 | Vibration | Appearance | Solder the capacitor on the test substrate A shown in "Complement of Test Method". Kind of Vibration: A simple harmonic motion 10Hz to 55Hz to 10Hz (1min) Total amplitude: 1.5mm This motion should be applied for a period of 2h. in each 3 mutually perpendicular directions (total of 6h). | | | | | | | | | | | | |
| | | Capacitance | | | | | | | | | | | | | |
| | | D.F. | | | | | | | | | | | | | |
| 9 | Solderability | 95% of the terminations is to be soldered evenly and continuously. | Test Method: Solder bath method Flux: Solution of rosin ethanol 25 (wt)% Preheat: 80 to 120°C for 10 to 30s Solder: Sn-3.0Ag-0.5Cu (Lead Free Solder) Solder Temp.: 245±5°C Immersion time: 2±0.5s Immersing in speed: 25±2.5mm/s. | | | | | | | | | | | | |
| 10 | Resistance to Soldering Heat | Appearance | Test Method: Solder bath method Solder: Sn-3.0Ag-0.5Cu (Lead Free Solder) Solder Temp.: 260±5°C Immersion time: 10±1s Immersing in speed: 25±2.5mm/s. Exposure Time: 24±2h at room condition*. Preheat: GR331 size max.: 120 to 150°C for 1min GR332 size min.: 100 to 120°C for 1min and 170 to 200°C for 1min <ul style="list-style-type: none"> • Pretreatment Perform a heat treatment at 150+0/-10°C for 1h±5min and then let sit for 24±2h at room condition*. | | | | | | | | | | | | |
| | | Capacitance Change | | | | | | | | | | | | | |
| | | D.F. | | | | | | | | | | | | | |
| | | I.R. | | | | | | | | | | | | | |
| | | Voltage Proof | | | | | | | | | | | | | |
| 11 | Adhesive Strength of Termination | No removal of the terminations or other defect should occur. | Solder the capacitor on the test substrate A shown in "Complement of Test Method".  Applied Direction: In parallel with the test substrate and vertical with the capacitor side. | | | | | | | | | | | | |

* Room Condition: Temperature: 15 to 35°C, Relative humidity: 45 to 75%, Atmosphere pressure: 86 to 106kPa

Continued on the following page.➤

GRM
 GR3
 GRJ
 GR4
 GR7
 GJM
 GQM
 GA2
 GA3 GB
 GA3 GD
 GA3 GF
 LLL
 LLA
 LLM
 LLR
 NFM
 KRM
 KR3
 GMA
 GMD
 △Caution / Notice

GR3 Series Specifications and Test Methods (3)

Continued from the preceding page. ↘

| No | Item | Specification | Test Method (Ref. Standard: JIS C 5101, IEC60384) | | | | | | | | | | | | | | | |
|--------------------|---|------------------------------|---|--|------------|------------|---|----------------------------|------|---|------------|--------|---|----------------------------|------|---|------------|--------|
| 12 | Substrate Bending Test | No defects or abnormalities. | Solder the capacitor on the test substrate B shown in "Complement of Test Method". Then apply the force in the direction shown in "Test Method of Substrate Bending Test" of "Complement of Test Method". Flexure: 2mm Holding Time: 5±1s Soldering Method: Reflow soldering | | | | | | | | | | | | | | | |
| 13 | Temperature Sudden Change | Appearance | Fix the capacitor to the supporting Test substrate A (glass epoxy board) shown in "Complement of Test Method". Perform the 5 cycles according to the four heat treatments shown in the following table. <table border="1" style="margin: 5px 0;"> <thead> <tr> <th>Step</th> <th>Temp. (°C)</th> <th>Time (min)</th> </tr> </thead> <tbody> <tr> <td>1</td> <td>Min. Operating Temp. +0/-3</td> <td>30±3</td> </tr> <tr> <td>2</td> <td>Room Temp.</td> <td>2 to 3</td> </tr> <tr> <td>3</td> <td>Max. Operating Temp. +3/-0</td> <td>30±3</td> </tr> <tr> <td>4</td> <td>Room Temp.</td> <td>2 to 3</td> </tr> </tbody> </table> Exposure Time: 24±2h at room condition*. • Pretreatment Perform a heat treatment at 150+0/-10°C for 1h±5min and then let sit for 24±2h. at room condition*. | Step | Temp. (°C) | Time (min) | 1 | Min. Operating Temp. +0/-3 | 30±3 | 2 | Room Temp. | 2 to 3 | 3 | Max. Operating Temp. +3/-0 | 30±3 | 4 | Room Temp. | 2 to 3 |
| | | Step | | Temp. (°C) | Time (min) | | | | | | | | | | | | | |
| | | 1 | | Min. Operating Temp. +0/-3 | 30±3 | | | | | | | | | | | | | |
| | | 2 | | Room Temp. | 2 to 3 | | | | | | | | | | | | | |
| | | 3 | | Max. Operating Temp. +3/-0 | 30±3 | | | | | | | | | | | | | |
| 4 | Room Temp. | 2 to 3 | | | | | | | | | | | | | | | | |
| Capacitance Change | Within ±7.5% | | | | | | | | | | | | | | | | | |
| D.F. | Within the specified initial value. | | | | | | | | | | | | | | | | | |
| I.R. | Within the specified initial value. | | | | | | | | | | | | | | | | | |
| Voltage Proof | No defects. | | | | | | | | | | | | | | | | | |
| 14 | High Temperature High Humidity (Steady) | Appearance | Fix the capacitor to the supporting Test substrate A (glass epoxy board) shown in "Complement of Test Method". Test Temperature: 40±2°C Test Humidity: 90 to 95%RH Test Time: 500+24/-0h Applied Voltage: DC630V (DC Rated Voltage) Exposure Time: 24±2h at room condition*. • Pretreatment Apply test voltage for 1h±5min at test temperature. Remove and let sit for 24±2h at room condition*. | | | | | | | | | | | | | | | |
| | | Capacitance Change | | Within ±12.5% | | | | | | | | | | | | | | |
| | | D.F. | | 0.02 max. | | | | | | | | | | | | | | |
| | | I.R. | | More than 1000MΩ or 10MΩ • μF (Whichever is smaller) | | | | | | | | | | | | | | |
| | | Voltage Proof | | No defects. | | | | | | | | | | | | | | |
| 15 | Durability | Appearance | Fix the capacitor to the supporting Test substrate A (glass epoxy board) shown in "Complement of Test Method". Test Temperature: Max. Operating Temp. ±3°C Test Time: 1000+48/-0h Applied Voltage: DC756V (120% of the rated voltage) Charge/discharge current: 50mA max. Exposure Time: 24±2h at room condition*. • Pretreatment Apply test voltage for 1h±5min at test temperature. Remove and let sit for 24±2h at room condition*. | | | | | | | | | | | | | | | |
| | | Capacitance Change | | Within ±12.5% | | | | | | | | | | | | | | |
| | | D.F. | | 0.02 max. | | | | | | | | | | | | | | |
| | | I.R. | | More than 1000MΩ or 10MΩ • μF (Whichever is smaller) | | | | | | | | | | | | | | |
| | | Voltage Proof | | No defects. | | | | | | | | | | | | | | |

* Room Condition: Temperature: 15 to 35°C, Relative humidity: 45 to 75%, Atmosphere pressure: 86 to 106kPa

Continued on the following page. ↗

GRM
 GR3
 GRJ
 GR4
 GR7
 GJM
 GQM
 GA2
 GA3 GB
 GA3 GD
 GA3 GF
 LLL
 LLA
 LLM
 LLR
 NFM
 KRM
 KR3
 GMA
 GMD
 ⚠Caution /Notice

GR3 Series Specifications and Test Methods (3)

Continued from the preceding page. ↘

Complement of Test Method

1. Test Substrate

The test substrate should be Substrate A or Substrate B as described in "Specifications and Test Methods".
 The specimen should be soldered by the conditions as described below.

Soldering Method: Reflow soldering
 Solder: Sn-3.0Ag-0.5Cu

(1) Test Substrate A

• Land Dimensions

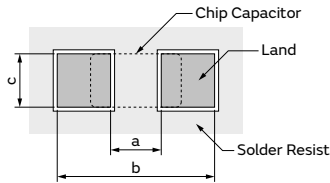

- Material: Glass Epoxy Board
- Thickness: 1.6mm
- Thickness of Copper Foil: 0.035mm

| Part Number | Dimension (mm) | | |
|-------------|----------------|-----|------|
| | a | b | c |
| GR318 | 1.0 | 3.0 | 1.2 |
| GR321 | 1.2 | 4.0 | 1.65 |
| GR331 | 2.2 | 5.0 | 2.0 |
| GR332 | 2.2 | 5.0 | 2.9 |
| GR342 | 3.5 | 7.0 | 2.4 |
| GR343 | 3.5 | 7.0 | 3.7 |
| GR352 | 4.5 | 8.0 | 3.2 |
| GR355 | 4.5 | 8.0 | 5.6 |

(2) Test Substrate B

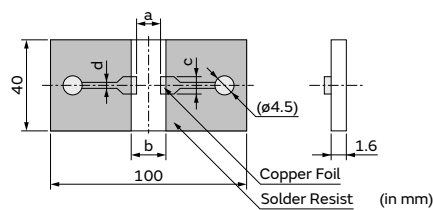

- Material: Glass Epoxy Board
- Thickness of Copper Foil: 0.035mm

| Part Number | Dimension (mm) | | | |
|-------------|----------------|-----|------|-----|
| | a | b | c | d |
| GR318 | 1.0 | 3.0 | 1.2 | 1.0 |
| GR321 | 1.2 | 4.0 | 1.65 | 1.0 |
| GR331 | 2.2 | 5.0 | 2.0 | 1.0 |
| GR332 | 2.2 | 5.0 | 2.9 | 1.0 |
| GR342 | 3.5 | 7.0 | 2.4 | 1.0 |
| GR343 | 3.5 | 7.0 | 3.7 | 1.0 |
| GR352 | 4.5 | 8.0 | 3.2 | 1.0 |
| GR355 | 4.5 | 8.0 | 5.6 | 1.0 |

2. Test Method of Substrate Bending Test

(a) Support State

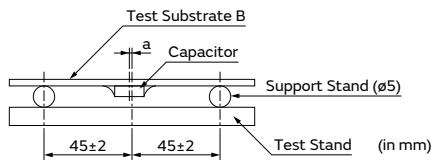

a: ±2 gap between support stand center and test stand

- Material of Test Stand and Pressure Stick
 The material should be a metal where a remarkable transformation and the distortion are not caused even if it is pressurized.
- Pressurizing Speed
 The pressurizing speed is pressurized at the speed of about 1mm/s until the flexure reaches a regulated value.

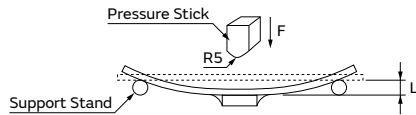

(b) Test State

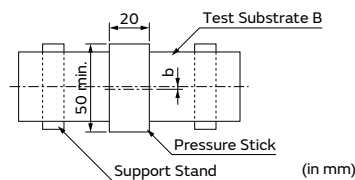

b: ±5 gap between support stand center and test stand center

GRM
 GR3
 GRJ
 GR4
 GR7
 GJM
 GQM
 GA2
 GA3 GB
 GA3 GD
 GA3 GF
 LLL
 LLA
 LLM
 LLR
 NFM
 KPM
 KR3
 GMA
 GMD
 ⚠Caution / Notice

Soft Termination Chip Multilayer Ceramic Capacitors for General Purpose

GRJ Series



Cracking caused by flexing stress after board mounting is minimized due to resin external electrodes!

Features

1 The resin external electrodes suppress cracks by board deflection.

Cracking of the ceramic element is suppressed by the resin of the external electrodes, which releases the stress.

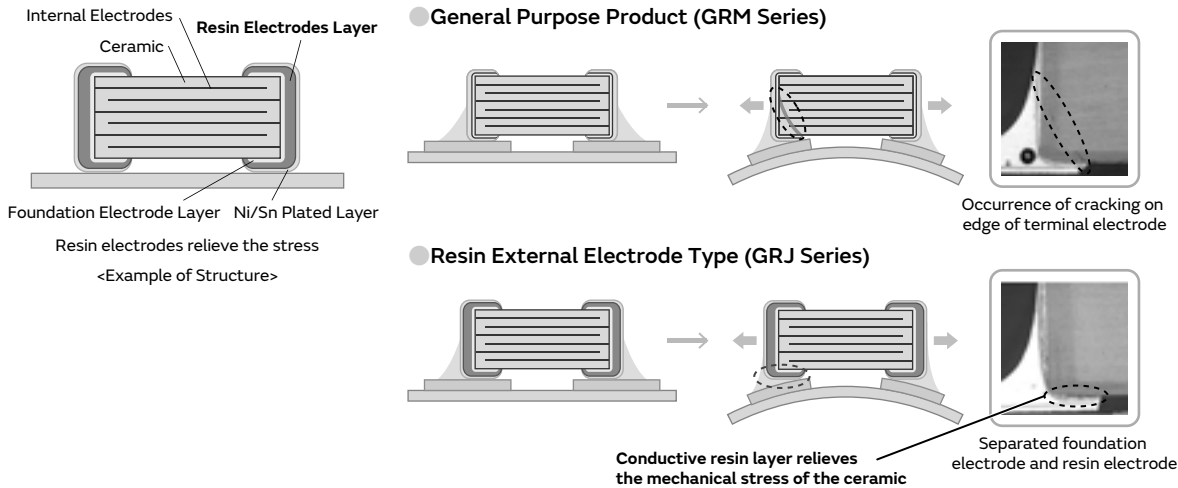

Note: Cracks may occur in the capacitor body if excessive stress beyond the "guaranteed range of board bending strength (*)" provided in the specifications is applied. Capacitors with cracks in them may cause a drop in insulation resistance, which could lead to a short circuit.
 (*) For details on the guaranteed range of board bending strength, check the "Detailed Specification Sheet" on the Product Details Page.

2 Suppresses the occurrence of cracking caused by deflection stress at the time of board mounting, etc.

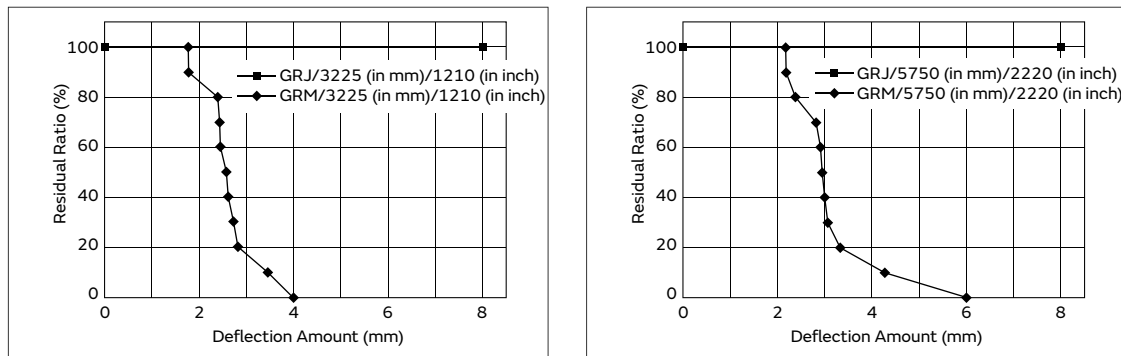

Due to the specification of the measuring instrument, measurements can be performed up to 8mm.

3 Ideal for consumer and industrial electronic equipment, etc. where there heat stress, vibration and impact are applied.

Specifications

| | |
|-------------------|--|
| Size (mm) | 0.6×0.3mm to 5.7×5.0mm |
| Rated Voltage | 6.3Vdc to 1000Vdc |
| Capacitance | 220pF to 47μF |
| Main Applications | Consumer & Industrial Electronic Equipment |

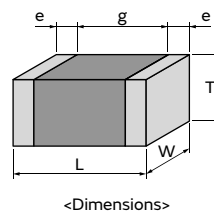

This catalog contains only a portion of the product lineup. Please refer to the capacitor search tool on the Murata Web site for details.

GRJ Series High Dielectric Constant Type Part Number List

1.6×0.8mm

| T max. | Rated Voltage | TC Code | Cap. | Tol. | Part Number |
|--------|---------------|--------------------|---------|--------------------|--------------------|
| 0.9mm | 100Vdc | X7R | 1000pF | ±10% | GRJ188R72A102KE11# |
| | | | | ±20% | GRJ188R72A102ME11# |
| | | | 2200pF | ±10% | GRJ188R72A222KE11# |
| | | | | ±20% | GRJ188R72A222ME11# |
| | | | 4700pF | ±10% | GRJ188R72A472KE11# |
| | | | | ±20% | GRJ188R72A472ME11# |
| | | | 10000pF | ±10% | GRJ188R72A103KE11# |
| | | | | ±20% | GRJ188R72A103ME11# |
| | | | 22000pF | ±10% | GRJ188R72A223KE11# |
| | | | | ±20% | GRJ188R72A223ME11# |
| | | | 0.10μF | ±10% | GRJ188R72A104KE11# |
| | | | | ±20% | GRJ188R72A104ME11# |
| | 50Vdc | X7R | 1000pF | ±10% | GRJ188R71H102KE11# |
| | | | | ±20% | GRJ188R71H102ME11# |
| | | | 2200pF | ±10% | GRJ188R71H222KE11# |
| | | | | ±20% | GRJ188R71H222ME11# |
| | | | 4700pF | ±10% | GRJ188R71H472KE11# |
| | | | | ±20% | GRJ188R71H472ME11# |
| | | | 10000pF | ±10% | GRJ188R71H103KE11# |
| | | | | ±20% | GRJ188R71H103ME11# |
| | | | 22000pF | ±10% | GRJ188R71H223KE11# |
| | | | | ±20% | GRJ188R71H223ME11# |
| | | | 47000pF | ±10% | GRJ188R71H473KE11# |
| | | | | ±20% | GRJ188R71H473ME11# |
| 0.10μF | ±10% | GRJ188R71H104KE11# | | | |
| | ±20% | GRJ188R71H104ME11# | | | |
| 0.22μF | ±10% | GRJ188R71H224KE11# | | | |
| | ±20% | GRJ188R71H224ME11# | | | |
| 35Vdc | X5R | 1.0μF | ±10% | GRJ188R6VA105KE11# | |
| 25Vdc | X7R | 47000pF | ±10% | GRJ188R71E473KE11# | |
| | | | ±20% | GRJ188R71E473ME11# | |
| | | 0.22μF | ±10% | GRJ188R71E224KE11# | |
| | | | ±20% | GRJ188R71E224ME11# | |
| 1.0μF | ±10% | GRJ188R71E105KE11# | | | |
| | ±20% | GRJ188R71E105ME11# | | | |
| 16Vdc | X7R | 0.47μF | ±10% | GRJ188R71C474KE11# | |
| | | | ±20% | GRJ188R71C474ME11# | |
| 6.3Vdc | X7R | 2.2μF | ±10% | GRJ188R70J225KE11# | |
| | | | ±20% | GRJ188R70J225ME11# | |
| 1.0mm | 6.3Vdc | X7S | 4.7μF | ±10% | GRJ188C70J475KE11# |
| | | | | ±20% | GRJ188C70J475ME11# |

2.0×1.25mm

| T max. | Rated Voltage | TC Code | Cap. | Tol. | Part Number |
|--------|---------------|---------|--------|------|--------------------|
| 0.7mm | 100Vdc | X7R | 1000pF | ±10% | GRJ216R72A102KE01# |
| | | | | ±20% | GRJ216R72A102ME01# |
| | | | 2200pF | ±10% | GRJ216R72A222KE01# |
| | | | | ±20% | GRJ216R72A222ME01# |
| | | | 4700pF | ±10% | GRJ216R72A472KE01# |
| | | | | ±20% | GRJ216R72A472ME01# |

| T max. | Rated Voltage | TC Code | Cap. | Tol. | Part Number | | | |
|---------|---------------|--------------------|--------------------|--------------------|--------------------|--------|--------------------|--------------------|
| 0.7mm | 100Vdc | X7R | 10000pF | ±10% | GRJ216R72A103KE01# | | | |
| | | | | ±20% | GRJ216R72A103ME01# | | | |
| | | | 22000pF | ±10% | GRJ216R72A223KE01# | | | |
| | | | | ±20% | GRJ216R72A223ME01# | | | |
| | | | 50Vdc | X7R | 470pF | ±10% | GRJ216R71H471KE01# | |
| | | | | | | ±20% | GRJ216R71H471ME01# | |
| | 1000pF | ±10% | | | GRJ216R71H102KE01# | | | |
| | | ±20% | | | GRJ216R71H102ME01# | | | |
| | 2200pF | ±10% | | | GRJ216R71H222KE01# | | | |
| | | ±20% | | | GRJ216R71H222ME01# | | | |
| | 4700pF | ±10% | GRJ216R71H472KE01# | ±10% | GRJ216R71H472KE01# | | | |
| | | | | ±20% | GRJ216R71H472ME01# | | | |
| 10000pF | | | ±10% | GRJ216R71H103KE01# | | | | |
| | | | ±20% | GRJ216R71H103ME01# | | | | |
| 22000pF | | | ±10% | GRJ216R71H223KE01# | | | | |
| | | | ±20% | GRJ216R71H223ME01# | | | | |
| 0.95mm | 100Vdc | X7R | 220pF | ±10% | GRJ219R72A221KE01# | | | |
| | | | | ±20% | GRJ219R72A221ME01# | | | |
| | | | 470pF | ±10% | GRJ219R72A471KE01# | | | |
| | | | | ±20% | GRJ219R72A471ME01# | | | |
| | | | 1.0mm | 250Vdc | X7R | 1000pF | ±10% | GRJ21AR72E102KWJ1# |
| | | | | | | | ±10% | GRJ21AR72E152KWJ1# |
| 2200pF | ±10% | GRJ21AR72E222KWJ1# | | | | | | |
| | ±10% | GRJ21AR72E332KWJ1# | | | | | | |
| 4700pF | ±10% | GRJ21AR72E472KWJ1# | | | | | | |
| | ±10% | GRJ21AR72E682KWJ1# | | | | | | |
| 1.45mm | 250Vdc | X7R | 10000pF | ±10% | GRJ21BR72E103KWJ3# | | | |
| | | | | ±10% | GRJ21BR72E153KWJ3# | | | |
| | | | 15000pF | ±10% | GRJ21BR72E223KWJ3# | | | |
| | | | | ±10% | GRJ21BR72E223KWJ3# | | | |
| | | | 100Vdc | X7R | 47000pF | ±10% | GRJ21BR72A473KE01# | |
| | | | | | | ±20% | GRJ21BR72A473ME01# | |
| | 0.10μF | ±10% | | | GRJ21BR72A104KE01# | | | |
| | | ±20% | | | GRJ21BR72A104ME01# | | | |
| | 50Vdc | X7R | | | 47000pF | ±10% | GRJ21BR71H473KE01# | |
| | | | | | | ±20% | GRJ21BR71H473ME01# | |
| | | | 0.10μF | ±10% | GRJ21BR71H104KE01# | | | |
| | | | | ±20% | GRJ21BR71H104ME01# | | | |
| 0.22μF | | | ±10% | GRJ21BR71H224KE01# | | | | |
| | | | ±20% | GRJ21BR71H224ME01# | | | | |
| 25Vdc | X7R | 1.0μF | ±10% | GRJ21BR71E105KE11# | | | | |
| | | | ±20% | GRJ21BR71E105ME11# | | | | |
| | | 2.2μF | ±10% | GRJ21BR71E225KE01# | | | | |
| | | | ±20% | GRJ21BR71E225ME01# | | | | |
| | | 4.7μF | ±10% | GRJ21BR71C475KE01# | | | | |
| | | | ±20% | GRJ21BR71C475ME01# | | | | |
| 1.5mm | 100Vdc | X7S | 1.0μF | ±10% | GRJ21BR71A106KE01# | | | |
| | | | | ±20% | GRJ21BR71A106ME01# | | | |
| | | | 1.0μF | ±10% | GRJ21BR71H105KE01# | | | |
| | | | | ±20% | GRJ21BR71H105ME01# | | | |
| | | | 1.0μF | ±10% | GRJ21BR71E105KE11# | | | |
| | | | | ±20% | GRJ21BR71E105ME11# | | | |

Part number # indicates the package specification code.

- GRM
- GR3
- GRJ
- GR4
- GR7
- GJM
- GQM
- GA2
- GA3 GB
- GA3 GD
- GA3 GF
- LLL
- LLA
- LLM
- LLR
- NFM
- KRM
- KR3
- GMA
- GMD
- ⚠Caution /Notice

GRJ Series High Dielectric Constant Type Part Number List

3.2×1.6mm

| T max. | Rated Voltage | TC Code | Cap. | Tol. | Part Number | | | | |
|--------|--------------------|--------------------|---------|--------------------|--------------------|--------------------|--------------------|--------------------|--------|
| 0.95mm | 100Vdc | X7R | 0.10μF | ±10% | GRJ319R72A104KE11# | | | | |
| | | | | ±20% | GRJ319R72A104ME11# | | | | |
| | 50Vdc | | 0.10μF | ±10% | GRJ319R71H104KE11# | | | | |
| | | | | ±20% | GRJ319R71H104ME11# | | | | |
| 1.25mm | 1000Vdc | X7R | 470pF | ±10% | GRJ31BR73A471KWJ1# | | | | |
| | | | | ±10% | GRJ31BR73A681KWJ1# | | | | |
| | | | | ±10% | GRJ31BR73A102KWJ1# | | | | |
| | | | | ±10% | GRJ31BR73A152KWJ1# | | | | |
| | | | | ±10% | GRJ31BR73A222KWJ1# | | | | |
| | | | | ±10% | GRJ31BR73A332KWJ1# | | | | |
| | | | | ±10% | GRJ31BR73A472KWJ1# | | | | |
| | | | | 630Vdc | X7R | 1000pF | ±10% | GRJ31BR72J102KWJ1# | |
| | ±10% | GRJ31BR72J152KWJ1# | | | | | | | |
| | ±10% | GRJ31BR72J222KWJ1# | | | | | | | |
| | ±10% | GRJ31BR72J332KWJ1# | | | | | | | |
| | ±10% | GRJ31BR72J472KWJ1# | | | | | | | |
| | ±10% | GRJ31BR72J682KWJ1# | | | | | | | |
| | 250Vdc | X7R | 15000pF | ±10% | GRJ31BR72E153KWJ1# | | | | |
| ±10% | | | | GRJ31BR72E223KWJ1# | | | | | |
| ±10% | | | | GRJ31BR72E683KWJ1# | | | | | |
| 1.35mm | | | | 100Vdc | X7R | 0.22μF | ±10% | GRJ31MR72A224KE01# | |
| | | | | | | | ±20% | GRJ31MR72A224ME01# | |
| | | | | | | | 50Vdc | X7R | 0.10μF |
| | ±20% | GRJ31MR71H104ME01# | | | | | | | |
| 0.22μF | ±10% | GRJ31MR71H224KE01# | | | | | | | |
| | ±20% | GRJ31MR71H224ME01# | | | | | | | |
| 0.47μF | ±10% | GRJ31MR71H474KE01# | | | | | | | |
| | ±20% | GRJ31MR71H474ME01# | | | | | | | |
| 1.0μF | ±10% | GRJ31MR71H105KE01# | | | | | | | |
| | ±20% | GRJ31MR71H105ME01# | | | | | | | |
| 25Vdc | X7R | 2.2μF | ±10% | GRJ31MR71E225KE11# | | | | | |
| | | | ±20% | GRJ31MR71E225ME11# | | | | | |
| | | | 16Vdc | X7R | 2.2μF | ±10% | GRJ31MR71C225KE11# | | |
| | | | | | | ±20% | GRJ31MR71C225ME11# | | |
| 1.8mm | 1000Vdc | X7R | 6800pF | ±10% | GRJ31CR73A682KWJ3# | | | | |
| | | | | ±10% | GRJ31CR73A103KWJ3# | | | | |
| | 630Vdc | | X7R | 15000pF | ±10% | GRJ31CR72J153KWJ3# | | | |
| | | | | | ±10% | GRJ31CR72J223KWJ3# | | | |
| | 250Vdc | | X7R | 33000pF | ±10% | GRJ31CR72E333KWJ3# | | | |
| | | | | | ±10% | GRJ31CR72E473KWJ3# | | | |
| ±10% | GRJ31CR72E104KWJ3# | | | | | | | | |
| 1.9mm | 100Vdc | X7R | 1.0μF | ±10% | GRJ31CR72A105KE11# | | | | |
| | | | | ±20% | GRJ31CR72A105ME11# | | | | |
| | 50Vdc | | X7R | 1.0μF | ±10% | GRJ31CR71H105KE11# | | | |
| | | | | | ±20% | GRJ31CR71H105ME11# | | | |
| | | | | 2.2μF | ±10% | GRJ31CR71H225KE11# | | | |
| | | | | | ±20% | GRJ31CR71H225ME11# | | | |
| | 4.7μF | | ±10% | GRJ31CR71H475KE11# | | | | | |
| | | | ±20% | GRJ31CR71H475ME11# | | | | | |
| | 35Vdc | | X6S | 10μF | ±10% | GRJ31CC8YA106KE01# | D1 | | |
| | | | | | ±20% | GRJ31CC8YA106ME01# | D1 | | |

| T max. | Rated Voltage | TC Code | Cap. | Tol. | Part Number | |
|--------|---------------|---------|-------|--------------------|--------------------|--|
| 1.9mm | 25Vdc | X7R | 10μF | ±10% | GRJ31CR71E106KE11# | |
| | | | | ±20% | GRJ31CR71E106ME11# | |
| | 16Vdc | X7R | 4.7μF | ±10% | GRJ31CR71C475KE11# | |
| | | | | ±20% | GRJ31CR71C475ME11# | |
| | | | 10μF | ±10% | GRJ31CR71C106KE11# | |
| | | | | ±20% | GRJ31CR71C106ME11# | |
| | 10Vdc | X7R | 10μF | ±10% | GRJ31CR71A106KE11# | |
| | | | | ±20% | GRJ31CR71A106ME11# | |
| | | | 22μF | ±10% | GRJ31CR71A226KE12# | |
| | | | | ±20% | GRJ31CR71A226ME12# | |
| 6.3Vdc | X7R | 22μF | ±10% | GRJ31CR70J226KE12# | | |
| | | | ±20% | GRJ31CR70J226ME12# | | |

3.2×2.5mm

| T max. | Rated Voltage | TC Code | Cap. | Tol. | Part Number | | |
|--------|---------------|--------------------|---------|--------------------|--------------------|--------------------|--|
| 1.5mm | 1000Vdc | X7R | 6800pF | ±10% | GRJ32QR73A682KWJ1# | | |
| | | | | ±10% | GRJ32QR73A103KWJ1# | | |
| | 630Vdc | | X7R | 22000pF | ±10% | GRJ32QR72J223KWJ1# | |
| | | | | | ±10% | GRJ32QR72E154KWJ1# | |
| 250Vdc | X7R | 68000pF | ±10% | GRJ32QR72E683KWJ1# | | | |
| | | | ±10% | GRJ32QR72E154KWJ1# | | | |
| 2.0mm | 1000Vdc | X7R | 15000pF | ±10% | GRJ32DR73A153KWJ1# | | |
| | | | | ±10% | GRJ32DR73A223KWJ1# | | |
| | 630Vdc | | X7R | 33000pF | ±10% | GRJ32DR72J333KWJ1# | |
| | | | | | ±10% | GRJ32DR72J473KWJ1# | |
| | 250Vdc | | X7R | 0.10μF | ±10% | GRJ32DR72E104KWJ1# | |
| | | | | | ±10% | GRJ32DR72E224KWJ1# | |
| 0.22μF | ±10% | GRJ32DR72E224KWJ1# | | | | | |
| | ±20% | GRJ32DR72E224ME11# | | | | | |
| 2.3mm | 100Vdc | X7R | 2.2μF | ±10% | GRJ32DR72A225KE11# | | |
| | | | | ±20% | GRJ32DR72A225ME11# | | |
| | X7S | | 4.7μF | ±10% | GRJ32DC72A475KE11# | | |
| | | | | ±20% | GRJ32DC72A475ME11# | | |
| 2.8mm | 50Vdc | X7R | 4.7μF | ±10% | GRJ32ER71H475KE11# | | |
| | | | | ±20% | GRJ32ER71H475ME11# | | |
| | | | 10μF | ±10% | GRJ32ER71H106KE11# | | |
| | | | | ±20% | GRJ32ER71H106ME11# | | |
| | X7S | | 10μF | ±10% | GRJ32EC71H106KE11# | | |
| | | | | ±20% | GRJ32EC71H106ME11# | | |
| | 25Vdc | | X7R | 10μF | ±10% | GRJ32ER71E106KE11# | |
| | | | | | ±20% | GRJ32ER71E106ME11# | |
| 16Vdc | X7R | 22μF | ±10% | GRJ32ER71C226KE11# | | | |
| | | | ±20% | GRJ32ER71C226ME11# | | | |
| 10Vdc | X7R | 22μF | ±10% | GRJ32ER71A226KE11# | | | |
| | | | ±20% | GRJ32ER71A226ME11# | | | |
| | | 47μF | ±10% | GRJ32ER71A476KE11# | | | |
| | | | ±20% | GRJ32ER71A476ME11# | | | |
| 6.3Vdc | X7R | 47μF | ±10% | GRJ32ER70J476KE11# | | | |
| | | | ±20% | GRJ32ER70J476ME11# | | | |
| 2.85mm | 25Vdc | X7S | 22μF | ±10% | GRJ32EC71E226KE11# | | |

Part number # indicates the package specification code.

GRJ Series High Dielectric Constant Type Part Number List

4.5×3.2mm

| T max. | Rated Voltage | TC Code | Cap. | Tol. | Part Number |
|--------|---------------|---------|---------|------|--------------------|
| 1.5mm | 630Vdc | X7R | 68000pF | ±10% | GRJ43QR72J683KWJ1# |
| | 250Vdc | X7R | 0.15μF | ±10% | GRJ43QR72E154KWJ1# |
| 2.0mm | 1000Vdc | X7R | 33000pF | ±10% | GRJ43DR73A333KWJ1# |
| | | | 47000pF | ±10% | GRJ43DR73A473KWJ1# |
| | 630Vdc | X7R | 0.10μF | ±10% | GRJ43DR72J104KWJ1# |
| | 250Vdc | X7R | 0.22μF | ±10% | GRJ43DR72E224KWJ1# |
| | | | 0.33μF | ±10% | GRJ43DR72E334KWJ1# |
| | | | 0.47μF | ±10% | GRJ43DR72E474KWJ1# |

5.7×5.0mm

| T max. | Rated Voltage | TC Code | Cap. | Tol. | Part Number |
|--------|---------------|---------|---------|------|--------------------|
| 2.0mm | 1000Vdc | X7R | 68000pF | ±10% | GRJ55DR73A683KWJ1# |
| | | | 0.10μF | ±10% | GRJ55DR73A104KWJ1# |
| | 630Vdc | X7R | 0.15μF | ±10% | GRJ55DR72J154KWJ1# |
| | | | 0.22μF | ±10% | GRJ55DR72J224KWJ1# |
| | 250Vdc | X7R | 0.33μF | ±10% | GRJ55DR72E334KWJ1# |
| | | | 0.47μF | ±10% | GRJ55DR72E474KWJ1# |
| | | | 0.68μF | ±10% | GRJ55DR72E684KWJ1# |
| | | | 1.0μF | ±10% | GRJ55DR72E105KWJ1# |

- GRM
- GR3
- GRJ
- GR4
- GR7
- GJM
- GQM
- GA2
- GA3 GB
- GA3 GD
- GA3 GF
- LLL
- LLA
- LLM
- LLR
- NFM
- KRM
- KR3
- GMA
- GMD
- ⚠Caution /Notice

Part number # indicates the package specification code.

GRJ Series Specifications and Test Methods

Specifications and Test Methods, please refer to the search web page.
<https://www.murata.com/en-global/products/capacitor>

GRJ Series High Dielectric Constant Type

1.6×0.8mm

| T max. | Rated Voltage | TC Code | Cap. | Tol. | Part Number |
|--------|---------------|---------|---------|------|--------------------|
| 0.9mm | 100Vdc | X7R | 1000pF | ±10% | GRJ188R72A102KE11# |
| | | | | ±20% | GRJ188R72A102ME11# |
| | | | | ±10% | GRJ188R72A222KE11# |
| | | | | | GRJ188R72A222ME11# |
| | | | | ±20% | GRJ188R72A472KE11# |
| | | | | | GRJ188R72A472ME11# |
| | | | 4700pF | ±10% | GRJ188R72A472KE11# |
| | | | | ±20% | GRJ188R72A472ME11# |
| | | | 10000pF | ±10% | GRJ188R72A103KE11# |
| | | | | ±20% | GRJ188R72A103ME11# |

Links are provided to the product detail pages on the web, and are shown below in the product number table from the PDF version of the catalog which is available on the web.



Detailed Specifications Sheet

- Rated value
- Specifications and Test Methods
- Package
- Caution, Notice

Specifications and Test Methods

| No | Item | Specification | Test Method (Ref. Standard: JIS C 5101, IEC60384) | | | | | | | | | | | | |
|----------------------|--|--|---|-------------|-----------|---------|---------------------|--------------|---------------|----------------------|--------------|----------------|----------|------------|---------------|
| 1 | Rated Voltage | Shown in Rated value. | The rated voltage is defined as the maximum voltage which may be applied continuously to the capacitor. When AC voltage is superimposed on DC voltage, $\sqrt{V^{2P}} + \sqrt{V^{2D}}$, whichever is larger, should be maintained within the rated voltage range. | | | | | | | | | | | | |
| 2 | Appearance | No defects or abnormalities. | Visual inspection. | | | | | | | | | | | | |
| 3 | Dimension | Within the specified dimensions. | Using Measuring instrument of dimension. | | | | | | | | | | | | |
| 4 | Voltage proof | No defects or abnormalities. | Measurement Point : Between the terminations Test Voltage : 250% of the rated voltage Applied Time : 1 to 5 s Charge/discharge current : 50mA max. | | | | | | | | | | | | |
| 5 | Insulation Resistance(I.R.) | More than 2000MΩ or 50Ω · F (Whichever is smaller) | Measurement Point : Between the terminations Measurement Voltage : DC Rated Voltage Charging Time : 1 min Charge/discharge current : 50mA max. Measurement Temperature: Room Temperature | | | | | | | | | | | | |
| 6 | Capacitance | Shown in Rated value. | Measurement Temperature: Room Temperature | | | | | | | | | | | | |
| 7 | Dissipation Factor (D.F.) | B1,R1,B3,R6,R7,C6,C7,C8,D7 : 0.1 max. D8 : 0.15 max | <table border="1"> <thead> <tr> <th>Capacitance</th> <th>Frequency</th> <th>Voltage</th> </tr> </thead> <tbody> <tr> <td>C ≤ 10μF (10V min.)</td> <td>1.0+/-0.1kHz</td> <td>1.0+/-0.2Vrms</td> </tr> <tr> <td>C ≤ 10μF (6.3V max.)</td> <td>1.0+/-0.1kHz</td> <td>0.5+/-0.1Vrms*</td> </tr> <tr> <td>C > 10μF</td> <td>120+/-24Hz</td> <td>0.5+/-0.1Vrms</td> </tr> </tbody> </table> <p>* For item GRJ188C70J475, the capacitance should be measured using a voltage of 1.0+/-0.2Vrms instead of 0.5+/-0.1Vrms.</p> | Capacitance | Frequency | Voltage | C ≤ 10μF (10V min.) | 1.0+/-0.1kHz | 1.0+/-0.2Vrms | C ≤ 10μF (6.3V max.) | 1.0+/-0.1kHz | 0.5+/-0.1Vrms* | C > 10μF | 120+/-24Hz | 0.5+/-0.1Vrms |
| Capacitance | Frequency | Voltage | | | | | | | | | | | | | |
| C ≤ 10μF (10V min.) | 1.0+/-0.1kHz | 1.0+/-0.2Vrms | | | | | | | | | | | | | |
| C ≤ 10μF (6.3V max.) | 1.0+/-0.1kHz | 0.5+/-0.1Vrms* | | | | | | | | | | | | | |
| C > 10μF | 120+/-24Hz | 0.5+/-0.1Vrms | | | | | | | | | | | | | |
| 8 | Temperature Characteristics of Capacitance | No bias B1,B3 : Within +/-10% (-25°C to +85°C) R1,R7 : Within +/-15% (-55°C to +125°C) R6 : Within +/-15% (-55°C to +85°C) C6 : Within +/-22% (-55°C to +85°C) C7 : Within +/-22% (-55°C to +125°C) C8 : Within +/-22% (-55°C to +105°C) D7 : Within +22/-33% (-55°C to +125°C) D8 : Within +22/-33% (-55°C to +105°C) | The capacitance change should be measured after 5 min. at each specified temp. stage. In case of applying voltage, the capacitance change should be measured after 1 min. with applying voltage in equilibration of each temp. stage. Capacitance value as a reference is the value in step 3. Measurement Voltage : 0.20+/-0.05Vrms | | | | | | | | | | | | |

| Step | Temperature(°C) | Applying Voltage(VDC) |
|------|----------------------|-----------------------|
| 1 | Reference Temp. +/-2 | |

Chip Multilayer Ceramic Capacitors for Ethernet LAN and Primary-secondary Coupling of DC-DC Converters

GR4 Series



Size (L*W) : 4.5x2.0mm - 5.7x5.0mm / X7R Char. / DC2kV
Realized large capacity and small size while maintaining high withstand voltages by the multilayer structure.

Features

- 1 For information devices of Ethernet LAN (IEEE802.3.) and primary - secondary couplings of DC-DC converters.

ex) DC-DC Converter

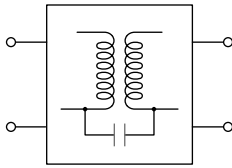

ex) LAN Connector

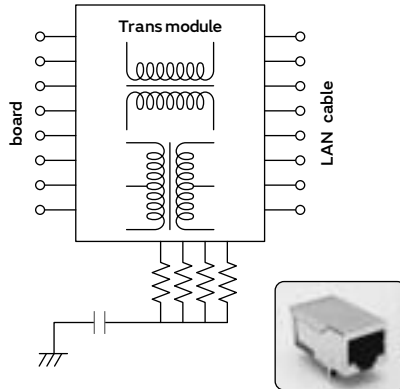

- 2 Realized large capacity and small size while maintaining high withstand voltages by the multilayer structure.

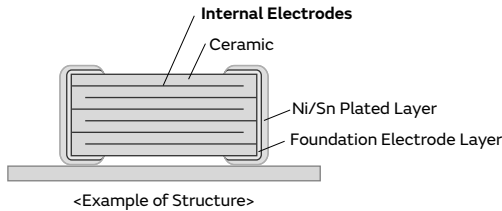

- 3 Dedicated for reflow soldering.

Specifications

| | |
|-------------------|---|
| Size (mm) | 4.5×2.0mm to 5.7×5.0mm |
| Rated Voltage | 2000Vdc |
| Capacitance | 100pF to 10000pF |
| Main Applications | For Ethernet LAN, Primary-secondary coupling for DC-DC converters |

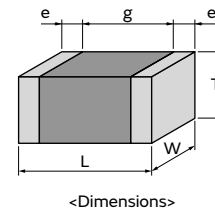

This catalog contains only a portion of the product lineup.
 Please refer to the capacitor search tool on the Murata Web site for details.

GR4 Series High Dielectric Constant Type Part Number List

4.5×2.0mm

| T max. | Rated Voltage | TC Code | Cap. | Tol. | Part Number | p* |
|--------|---------------|--------------------|--------|------|--------------------|------|
| 1.5mm | 2000Vdc | X7R | 100pF | ±10% | GR442QR73D101KW01# | p127 |
| | | | 120pF | ±10% | GR442QR73D121KW01# | p127 |
| | | | 150pF | ±10% | GR442QR73D151KW01# | p127 |
| | | | 180pF | ±10% | GR442QR73D181KW01# | p127 |
| | | | 220pF | ±10% | GR442QR73D221KW01# | p127 |
| | | | 270pF | ±10% | GR442QR73D271KW01# | p127 |
| | | | 330pF | ±10% | GR442QR73D331KW01# | p127 |
| | | | 390pF | ±10% | GR442QR73D391KW01# | p127 |
| | | | 470pF | ±10% | GR442QR73D471KW01# | p127 |
| | | | 560pF | ±10% | GR442QR73D561KW01# | p127 |
| | | | 680pF | ±10% | GR442QR73D681KW01# | p127 |
| | | | 820pF | ±10% | GR442QR73D821KW01# | p127 |
| | | | 1000pF | ±10% | GR442QR73D102KW01# | p127 |
| | | | 1200pF | ±10% | GR442QR73D122KW01# | p127 |
| 1500pF | ±10% | GR442QR73D152KW01# | p127 | | | |

4.5×3.2mm

| T max. | Rated Voltage | TC Code | Cap. | Tol. | Part Number | p* |
|--------|---------------|---------|--------|------|--------------------|------|
| 1.5mm | 2000Vdc | X7R | 1800pF | ±10% | GR443QR73D182KW01# | p127 |
| | | | 2200pF | ±10% | GR443QR73D222KW01# | p127 |
| | | | 2700pF | ±10% | GR443QR73D272KW01# | p127 |
| | | | 3300pF | ±10% | GR443QR73D332KW01# | p127 |
| | | | 3900pF | ±10% | GR443QR73D392KW01# | p127 |
| 2.0mm | 2000Vdc | X7R | 4700pF | ±10% | GR443DR73D472KW01# | p127 |

5.7×5.0mm

| T max. | Rated Voltage | TC Code | Cap. | Tol. | Part Number | p* |
|--------|---------------|---------|---------|------|--------------------|------|
| 2.0mm | 2000Vdc | X7R | 10000pF | ±10% | GR455DR73D103KW01# | p127 |

*: Refers to the page of the "Specifications and Test Methods".

Part number # indicates the package specification code.

GRM
 GR3
 GRJ
GR4
 GR7
 GJM
 GQM
 GA2
 GA3 GB
 GA3 GD
 GA3 GF
 LLL
 LLA
 LLM
 LLR
 NFM
 KRM
 KR3
 GMA
 GMD
 ⚠Caution /Notice

1

GR4 Series Specifications and Test Methods (1)

| No | Item | Specification | Test Method (Ref. Standard: JIS C 5101, IEC60384) | | | | | | | | | | | | |
|-----------------|--|---|---|--------------|------------------|---------|--------------------|-----------------|-------------------------|---|--------------------|---|-------------------------|---|--------------------|
| 1 | Appearance | No defects or abnormalities. | Visual inspection. | | | | | | | | | | | | |
| 2 | Dimension | Within the specified dimensions. | Using calipers and micrometers. | | | | | | | | | | | | |
| 3 | Voltage Proof | No defects or abnormalities. | Measurement Point: Between the terminations <table border="1"> <thead> <tr> <th>Test Voltage</th> <th>Time</th> </tr> </thead> <tbody> <tr> <td>DC2400V</td> <td>60s</td> </tr> <tr> <td>AC1.5kV (r.m.s)</td> <td>60s</td> </tr> </tbody> </table> Charge/discharge current: 50mA max. | Test Voltage | Time | DC2400V | 60s | AC1.5kV (r.m.s) | 60s | | | | | | |
| Test Voltage | Time | | | | | | | | | | | | | | |
| DC2400V | 60s | | | | | | | | | | | | | | |
| AC1.5kV (r.m.s) | 60s | | | | | | | | | | | | | | |
| 4 | Impulse Voltage | No self healing break downs or flash-overs have taken place in the capacitor. | 10 impulse of alternating polarity is subjected. (5 impulse for each polarity) The interval between impulse is 60s. Applied Pulse: 1.2/50µs Applied Voltage: 2.5kVo-p | | | | | | | | | | | | |
| 5 | Insulation Resistance (I.R.) | 6000MΩ or more | Measurement Point: Between the terminations Measurement Voltage: DC500±50V Charging Time: 60±5s Measurement Temperature: Room Temperature | | | | | | | | | | | | |
| 6 | Capacitance | Shown in Rated value. | Measurement Temperature: Room Temperature Measurement Frequency: 1.0±0.1kHz Measurement Voltage: AC1.0±0.2V (r.m.s.) | | | | | | | | | | | | |
| 7 | Dissipation Factor (D.F.) | 0.025 max. | | | | | | | | | | | | | |
| 8 | Temperature Characteristics of Capacitance | R7: Within ±15% (-55 to +125°C) | The capacitance change should be measured after 5 minutes at each specified temp. stage. Capacitance value as a reference is the value in step 3. <table border="1"> <thead> <tr> <th>Step</th> <th>Temperature (°C)</th> </tr> </thead> <tbody> <tr> <td>1</td> <td>Reference Temp. ±2</td> </tr> <tr> <td>2</td> <td>Min. Operating Temp. ±3</td> </tr> <tr> <td>3</td> <td>Reference Temp. ±2</td> </tr> <tr> <td>4</td> <td>Max. Operating Temp. ±3</td> </tr> <tr> <td>5</td> <td>Reference Temp. ±2</td> </tr> </tbody> </table> • Pretreatment Perform a heat treatment at 150+0/-10°C for 1h±5min and then let sit for 24±2h at room condition*. | Step | Temperature (°C) | 1 | Reference Temp. ±2 | 2 | Min. Operating Temp. ±3 | 3 | Reference Temp. ±2 | 4 | Max. Operating Temp. ±3 | 5 | Reference Temp. ±2 |
| Step | Temperature (°C) | | | | | | | | | | | | | | |
| 1 | Reference Temp. ±2 | | | | | | | | | | | | | | |
| 2 | Min. Operating Temp. ±3 | | | | | | | | | | | | | | |
| 3 | Reference Temp. ±2 | | | | | | | | | | | | | | |
| 4 | Max. Operating Temp. ±3 | | | | | | | | | | | | | | |
| 5 | Reference Temp. ±2 | | | | | | | | | | | | | | |
| 9 | Appearance | No defects or abnormalities. | Solder the capacitor on the test substrate A shown in "Complement of Test Method". Kind of Vibration: A simple harmonic motion 10Hz to 55Hz to 10Hz (1min) Total amplitude: 1.5mm This motion should be applied for a period of 2h in each 3 mutually perpendicular directions (total of 6h). | | | | | | | | | | | | |
| | Capacitance | Within the specified initial value. | | | | | | | | | | | | | |
| | D.F. | Within the specified initial value. | | | | | | | | | | | | | |
| 10 | Solderability | 95% of the terminations is to be soldered evenly and continuously. | Test Method: Solder bath method Flux: Solution of rosin ethanol 25 (wt) % Preheat: 80 to 120°C for 10 to 30s Solder: Sn-3.0Ag-0.5Cu (Lead Free Solder) Solder Temp.: 245±5°C Immersion time: 2±0.5s Immersing in speed: 25±2.5mm/s. | | | | | | | | | | | | |
| 11 | Appearance | No defects or abnormalities. | Test Method: Solder bath method Solder: Sn-3.0Ag-0.5Cu (Lead Free Solder) Solder Temp.: 260±5°C Immersion time: 10±1s Immersing in speed: 25±2.5mm/s. Exposure Time: 24±2h. at room condition *. Preheat: GR442 size min.: 100 to 120°C for 1min and 170 to 200°C for 1min • Pretreatment Perform a heat treatment at 150+0/-10°C for 1h±5min and then let sit for 24±2h. at room condition *. | | | | | | | | | | | | |
| | Capacitance Change | Within ±10% | | | | | | | | | | | | | |
| | D.F. | Within the specified initial value. | | | | | | | | | | | | | |
| | I.R. | 1000MΩ or more | | | | | | | | | | | | | |
| | Voltage Proof | No defects. | | | | | | | | | | | | | |

* Room Condition: Temperature: 15 to 35°C, Relative humidity: 45 to 75%, Atmosphere pressure: 86 to 106kPa

Continued on the following page. ↗

GRM
 GR3
 GRJ
 GR4
 GR7
 GJM
 GQM
 GA2
 GA3 GB
 GA3 GD
 GA3 GF
 LLL
 LLA
 LLM
 LLR
 NFM
 KPM
 KR3
 GMA
 GMD
 ⚠Caution /Notice

GR4 Series Specifications and Test Methods (1)

Continued from the preceding page. ↘

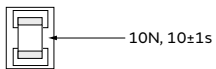
| No | Item | Specification | Test Method (Ref. Standard: JIS C 5101, IEC60384) | | | | | | | | | | | | | | | |
|------|----------------------------------|--|---|------|------------|------------|---|----------------------------|------|---|-----------|--------|---|----------------------------|------|---|-----------|--------|
| 12 | Adhesive Strength of Termination | No removal of the terminations or other defect should occur. | <p>Solder the capacitor on the test substrate A shown in "Complement of Test Method".</p>  <p>Applied Direction: In parallel with the test substrate and vertical with the capacitor side.</p> | | | | | | | | | | | | | | | |
| 13 | Substrate Bending Test | No defects or abnormalities. | <p>Solder the capacitor on the test substrate B shown in "Complement of Test Method". Then apply the force in the direction shown in "Test Method of Substrate Bending Test" of "Complement of Test Method". Flexure: 1mm Holding Time: 5±1s Soldering Method: Reflow soldering</p> | | | | | | | | | | | | | | | |
| 14 | Temperature Sudden Change | Appearance | No defects or abnormalities. | | | | | | | | | | | | | | | |
| | | Capacitance Change | Within ±15% | | | | | | | | | | | | | | | |
| | | D.F. | 0.05 max. | | | | | | | | | | | | | | | |
| | | I.R. | 3000MΩ or more | | | | | | | | | | | | | | | |
| | | Voltage Proof | No defects. | | | | | | | | | | | | | | | |
| | | | <p>Fix the capacitor to the supporting Test substrate A (glass epoxy board) shown in "Complement of Test Method". Perform the 5 cycles according to the four heat treatments shown in the following table.</p> <table border="1"> <thead> <tr> <th>Step</th> <th>Temp. (°C)</th> <th>Time (min)</th> </tr> </thead> <tbody> <tr> <td>1</td> <td>Min. Operating Temp. +0/-3</td> <td>30±3</td> </tr> <tr> <td>2</td> <td>Room Temp</td> <td>2 to 3</td> </tr> <tr> <td>3</td> <td>Max. Operating Temp. +3/-0</td> <td>30±3</td> </tr> <tr> <td>4</td> <td>Room Temp</td> <td>2 to 3</td> </tr> </tbody> </table> <p>Exposure Time: 24±2h at room condition*. • Pretreatment Perform a heat treatment at 150+0/-10°C for 1h±5min and then let sit for 24±2h. at room condition*.</p> | Step | Temp. (°C) | Time (min) | 1 | Min. Operating Temp. +0/-3 | 30±3 | 2 | Room Temp | 2 to 3 | 3 | Max. Operating Temp. +3/-0 | 30±3 | 4 | Room Temp | 2 to 3 |
| Step | Temp. (°C) | Time (min) | | | | | | | | | | | | | | | | |
| 1 | Min. Operating Temp. +0/-3 | 30±3 | | | | | | | | | | | | | | | | |
| 2 | Room Temp | 2 to 3 | | | | | | | | | | | | | | | | |
| 3 | Max. Operating Temp. +3/-0 | 30±3 | | | | | | | | | | | | | | | | |
| 4 | Room Temp | 2 to 3 | | | | | | | | | | | | | | | | |
| 15 | Humidity (Steady State) | Appearance | No defects or abnormalities. | | | | | | | | | | | | | | | |
| | | Capacitance Change | Within ±15% | | | | | | | | | | | | | | | |
| | | D.F. | 0.05 max. | | | | | | | | | | | | | | | |
| | | I.R. | 1000MΩ or more | | | | | | | | | | | | | | | |
| | | Voltage Proof | No defects. | | | | | | | | | | | | | | | |
| | | | <p>Fix the capacitor to the supporting Test substrate A (glass epoxy board) shown in "Complement of Test Method". Test Temperature: 40±2°C Test Humidity: 90 to 95%RH Test Time: 500+24/-0h. Exposure Time: 24±2h. at room condition*. • Pretreatment Perform a heat treatment at 150+0/-10°C for 1h±5min and then let sit for 24±2h at room condition*.</p> | | | | | | | | | | | | | | | |
| 16 | Durability | Appearance | No defects or abnormalities. | | | | | | | | | | | | | | | |
| | | Capacitance Change | Within ±20% | | | | | | | | | | | | | | | |
| | | D.F. | 0.05 max. | | | | | | | | | | | | | | | |
| | | I.R. | 2000MΩ or more | | | | | | | | | | | | | | | |
| | | Voltage Proof | No defects. | | | | | | | | | | | | | | | |
| | | | <p>Fix the capacitor to the supporting Test substrate A (glass epoxy board) shown in "Complement of Test Method". Test Temperature: Max. Operating Temp. ±3°C Test Time: 1000+48/-0h Applied Voltage: DC2.2kV (110% of the rated voltage) Charge/discharge current: 50mA max. Exposure Time: 24±2h at room condition*. • Pretreatment Apply test voltage for 1h±5min at test temperature. Remove and let sit for 24±2h at room condition*.</p> | | | | | | | | | | | | | | | |

* Room Condition: Temperature: 15 to 35°C, Relative humidity: 45 to 75%, Atmosphere pressure: 86 to 106kPa

Continued on the following page. ↗

GRM
 GR3
 GRJ
 GR4
 GR7
 GJM
 GQM
 GA2
 GA3 GB
 GA3 GD
 GA3 GF
 LLL
 LLA
 LLM
 LLR
 NFM
 KRM
 KR3
 GMA
 GMD
 ⚠Caution /Notice

GR4 Series Specifications and Test Methods (1)

Continued from the preceding page. ↘

Complement of Test Method

1. Test Substrate

The test substrate should be Substrate A or Substrate B as described in “Specifications and Test Methods”.
 The specimen should be soldered by the conditions as described below.

Soldering Method: Reflow soldering
 Solder: Sn-3.0Ag-0.5Cu

(1) Test Substrate A

• Land Dimensions



- Material: Glass Epoxy Board
- Thickness: 1.6mm
- Thickness of Copper Foil: 0.035mm

| Part Number | Dimension (mm) | | |
|-------------|----------------|-----|-----|
| | a | b | c |
| GR442 | 3.5 | 7.0 | 2.4 |
| GR443 | 3.5 | 7.0 | 3.7 |
| GR455 | 4.5 | 8.0 | 5.6 |

(2) Test Substrate B

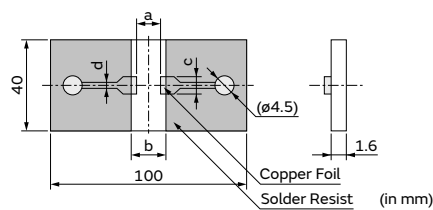

- Material: Glass Epoxy Board
- Thickness of Copper Foil: 0.035mm

| Part Number | Dimension (mm) | | | |
|-------------|----------------|-----|-----|-----|
| | a | b | c | d |
| GR442 | 3.5 | 7.0 | 2.4 | 1.0 |
| GR443 | 3.5 | 7.0 | 3.7 | 1.0 |
| GR455 | 4.5 | 8.0 | 5.6 | 1.0 |

2. Test Method of Substrate Bending Test

(a) Support State

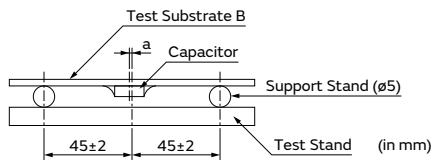

a: ±2 gap between support stand center and test stand

- Material of Test Stand and Pressure Stick
 The material should be a metal where a remarkable transformation and the distortion are not caused even if it is pressurized.
- Pressurizing Speed
 The pressurizing speed is pressurized at the speed of about 1mm/s until the flexure reaches a regulated value.

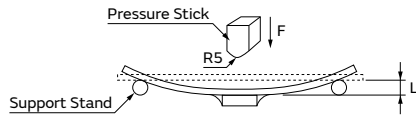

(b) Test State

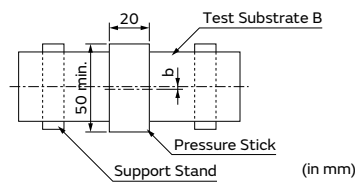

b: ±5 gap between support stand center and test stand center

GRM
 GR3
 GRJ
GR4
 GR7
 GJM
 GQM
 GA2
 GA3 GB
 GA3 GD
 GA3 GF
 LLL
 LLA
 LLM
 LLR
 NFM
 KPM
 KR3
 GMA
 GMD
 ⚠Caution / Notice

Chip Multilayer Ceramic Capacitors for Camera Flash circuit only

GR7 Series



Limited to camera flashes. Ideal for trigger capacitors and voltage doubler capacitors!

Features

- 1 Ideal for the trigger of flash circuits, as a higher capacitance can be acquired compared to conventional products (X7R characteristics) when a DC bias is applied.

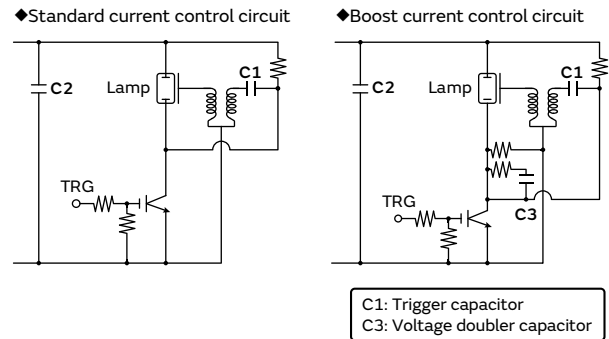
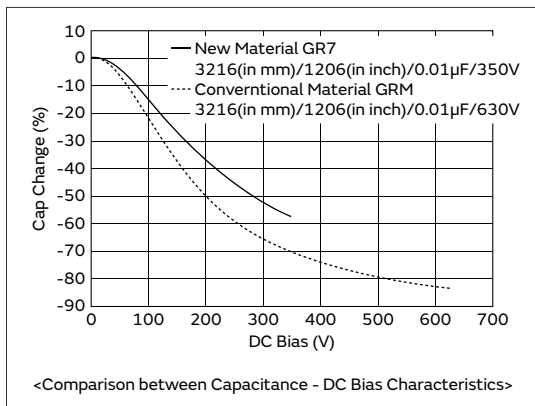

- 2 Contributes to the miniaturization of cameras with the low profile.

Specifications

| | |
|-------------------|-------------------------|
| Size (mm) | 2.0×1.25mm to 3.2×1.6mm |
| Rated Voltage | 350Vdc |
| Capacitance | 10000pF to 47000pF |
| Main Applications | For camera flash |

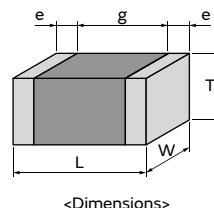

This catalog contains only a portion of the product lineup.
 Please refer to the capacitor search tool on the Murata Web site for details.

GRM
 GR3
 GRJ
 GR4
 GR7
 GJM
 GQM
 GA2
 GA3 GB
 GA3 GD
 GA3 GF
 LLL
 LLA
 LLM
 LLR
 NFM
 KPM
 KR3
 GMA
 GMD
 Caution / Notice

GR7 Series High Dielectric Constant Type Part Number List

2.0×1.25mm

| T max. | Rated Voltage | TC Code | Cap. | Tol. | Part Number | p* |
|--------|---------------|---------|---------|------|---------------------------|------|
| 1.0mm | 350Vdc | X7T | 10000pF | ±10% | GR721AWOBB103KW01# | p132 |
| | | | 15000pF | ±10% | GR721AWOBB153KW01# | p132 |
| 1.45mm | 350Vdc | X7T | 22000pF | ±10% | GR721BWOBB223KW03# | p132 |
| | | | 27000pF | ±10% | GR721BWOBB273KW03# | p132 |

3.2×1.6mm

| T max. | Rated Voltage | TC Code | Cap. | Tol. | Part Number | p* |
|--------|---------------|---------|---------|------|---------------------------|------|
| 1.0mm | 350Vdc | X7T | 10000pF | ±10% | GR731AWOBB103KW01# | p132 |
| | | | 15000pF | ±10% | GR731AWOBB153KW01# | p132 |
| | | | 22000pF | ±10% | GR731AWOBB223KW01# | p132 |
| | | | 27000pF | ±10% | GR731AWOBB273KW01# | p132 |
| | | | 33000pF | ±10% | GR731AWOBB333KW01# | p132 |
| 1.25mm | 350Vdc | X7T | 22000pF | ±10% | GR731BWOBB223KW01# | p132 |
| | | | 33000pF | ±10% | GR731BWOBB333KW01# | p132 |
| 1.8mm | 350Vdc | X7T | 47000pF | ±10% | GR731CWOBB473KW03# | p132 |

*: Refers to the page of the "Specifications and Test Methods".

Part number # indicates the package specification code.

1

GR7 Series Specifications and Test Methods (1)

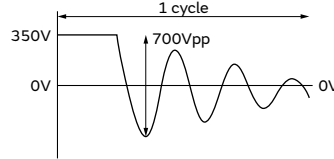
| No | Item | Specification | Test Method (Ref. Standard: JIS C 5101, IEC60384) | | | | | | | | | | | | |
|-------------------|--|--|---|------------------|------------------|---|--------------------|---|-------------------------|---|--------------------|---|-------------------------|---|--------------------|
| 1 | Appearance | No defects or abnormalities. | Visual inspection. | | | | | | | | | | | | |
| 2 | Dimension | Within the specified dimensions. | Using calipers and micrometers. | | | | | | | | | | | | |
| 3 | Voltage Proof | No defects or abnormalities. | Measurement Point: Between the terminations Test Voltage: DC500V Applied Time: 1 to 5s Charge/discharge current: 50mA max. | | | | | | | | | | | | |
| 4 | Charge and Discharge Cycle | Appearance | Test temperature: 25°C Discharge voltage: below figure Discharge cycle: 100k cycle Discharge frequency: 100Hz Exposure Time: 24±2h at room condition*.  | | | | | | | | | | | | |
| | | Capacitance Change | | | | | | | | | | | | | |
| | | D.F. | | | | | | | | | | | | | |
| | | I.R. | | | | | | | | | | | | | |
| | Voltage Proof | No defects. | • Pretreatment Apply test voltage (DC350V) for 1h±5min at test temperature. Remove and let sit for 24±2h at room condition*. | | | | | | | | | | | | |
| 5 | Insulation Resistance (I.R.) | $C \geq 0.01\mu\text{F}$: 100MΩ • μF or more $C < 0.01\mu\text{F}$: 10000MΩ or more | Measurement Point: Between the terminations Measurement Voltage: DC250±25V Charging Time: 60±5s Measurement Temperature: Room Temperature | | | | | | | | | | | | |
| 6 | Capacitance | Shown in Rated value. | Measurement Temperature: Room Temperature Measurement Frequency: 1.0±0.1kHz Measurement Voltage: AC1.0±0.2V (r.m.s.) | | | | | | | | | | | | |
| 7 | Dissipation Factor (D.F.) | 0.025 max. | | | | | | | | | | | | | |
| 8 | Temperature Characteristics of Capacitance | No Bias | The capacitance change should be measured after 5 minutes at each specified temp. stage. Capacitance value as a reference is the value in step 3. <table border="1" data-bbox="925 1142 1244 1288"> <thead> <tr> <th>Step</th> <th>Temperature (°C)</th> </tr> </thead> <tbody> <tr> <td>1</td> <td>Reference Temp. ±2</td> </tr> <tr> <td>2</td> <td>Min. Operating Temp. ±3</td> </tr> <tr> <td>3</td> <td>Reference Temp. ±2</td> </tr> <tr> <td>4</td> <td>Max. Operating Temp. ±3</td> </tr> <tr> <td>5</td> <td>Reference Temp. ±2</td> </tr> </tbody> </table> | Step | Temperature (°C) | 1 | Reference Temp. ±2 | 2 | Min. Operating Temp. ±3 | 3 | Reference Temp. ±2 | 4 | Max. Operating Temp. ±3 | 5 | Reference Temp. ±2 |
| | | Step | | Temperature (°C) | | | | | | | | | | | |
| 1 | Reference Temp. ±2 | | | | | | | | | | | | | | |
| 2 | Min. Operating Temp. ±3 | | | | | | | | | | | | | | |
| 3 | Reference Temp. ±2 | | | | | | | | | | | | | | |
| 4 | Max. Operating Temp. ±3 | | | | | | | | | | | | | | |
| 5 | Reference Temp. ±2 | | | | | | | | | | | | | | |
| Apply DC350V Bias | W0: Within ±10% (-55 to +125°C) | | | | | | | | | | | | | | |
| 9 | Vibration | Appearance | Solder the capacitor on the test substrate A shown in "Complement of Test Method". Kind of Vibration: A simple harmonic motion 10Hz to 55Hz to 10Hz (1min) Total amplitude: 1.5mm This motion should be applied for a period of 2h in each 3 mutually perpendicular directions (total of 6h). | | | | | | | | | | | | |
| | | Capacitance | | | | | | | | | | | | | |
| | | D.F. | | | | | | | | | | | | | |
| 10 | Solderability | 95% of the terminations is to be soldered evenly and continuously. | Test Method: Solder bath method Flux: Solution of rosin ethanol 25 (wt)% Preheat: 80 to 120°C for 10 to 30s Solder: Sn-3.0Ag-0.5Cu (Lead Free Solder) Solder Temp.: 245±5°C Immersion time: 2±0.5s Immersing in speed: 25±2.5mm/s. | | | | | | | | | | | | |
| 11 | Resistance to Soldering Heat | Appearance | Test Method: Solder bath method Solder: Sn-3.0Ag-0.5Cu (Lead Free Solder) Solder Temp.: 260±5°C Immersion time: 10±1s Immersing in speed: 25±2.5mm/s. Exposure Time: 24±2h at room condition*. Preheat: GR731 size max.: 120 to 150°C for 1min • Pretreatment Perform a heat treatment at 150+0/-10°C for 1h±5min and then let sit for 24±2h at room condition*. | | | | | | | | | | | | |
| | | Capacitance Change | | | | | | | | | | | | | |
| | | D.F. | | | | | | | | | | | | | |
| | | I.R. | | | | | | | | | | | | | |
| | | Voltage Proof | | | | | | | | | | | | | |

* Room Condition: Temperature: 15 to 35°C, Relative humidity: 45 to 75%, Atmosphere pressure: 86 to 106kPa

Continued on the following page. ↗

GRM
 GR3
 GRJ
 GR4
 GR7
 GJM
 GQM
 GA2
 GA3 GB
 GA3 GD
 GA3 GF
 LLL
 LLA
 LLM
 LLR
 NFM
 KRM
 KR3
 GMA
 GMD
 ⚠Caution / Notice

GR7 Series Specifications and Test Methods (1)

Continued from the preceding page. ↘

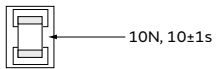
| No | Item | Specification | Test Method (Ref. Standard: JIS C 5101, IEC60384) | | | | | | | | | | | | | | | |
|--------------------|---|--|---|---|------------|------------|---|----------------------------|------|---|------------|--------|---|----------------------------|------|---|------------|--------|
| 12 | Adhesive Strength of Termination | No removal of the terminations or other defect should occur. | <p>Solder the capacitor on the test substrate A shown in "Complement of Test Method".</p>  <p>Applied Direction: In parallel with the test substrate and vertical with the capacitor side.</p> | | | | | | | | | | | | | | | |
| 13 | Substrate Bending Test | No defects or abnormalities. | <p>Solder the capacitor on the test substrate B shown in "Complement of Test Method". Then apply the force in the direction shown in "Test Method of Substrate Bending Test" of "Complement of Test Method". Flexure: 1mm Holding Time: 5±1s Soldering Method: Reflow soldering</p> | | | | | | | | | | | | | | | |
| 14 | Temperature Sudden Change | Appearance | <p>Fix the capacitor to the supporting Test substrate A (glass epoxy board) shown in "Complement of Test Method". Perform the 5 cycles according to the four heat treatments shown in the following table.</p> <table border="1" data-bbox="933 750 1380 873"> <thead> <tr> <th>Step</th> <th>Temp. (°C)</th> <th>Time (min)</th> </tr> </thead> <tbody> <tr> <td>1</td> <td>Min. Operating Temp. +0/-3</td> <td>30±3</td> </tr> <tr> <td>2</td> <td>Room Temp.</td> <td>2 to 3</td> </tr> <tr> <td>3</td> <td>Max. Operating Temp. +3/-0</td> <td>30±3</td> </tr> <tr> <td>4</td> <td>Room Temp.</td> <td>2 to 3</td> </tr> </tbody> </table> <p>Exposure Time: 24±2h at room condition*. • Pretreatment Perform a heat treatment at 150+0/-10°C for 1h±5min and then let sit for 24±2h at room condition*.</p> | Step | Temp. (°C) | Time (min) | 1 | Min. Operating Temp. +0/-3 | 30±3 | 2 | Room Temp. | 2 to 3 | 3 | Max. Operating Temp. +3/-0 | 30±3 | 4 | Room Temp. | 2 to 3 |
| | | Step | | Temp. (°C) | Time (min) | | | | | | | | | | | | | |
| | | 1 | | Min. Operating Temp. +0/-3 | 30±3 | | | | | | | | | | | | | |
| | | 2 | | Room Temp. | 2 to 3 | | | | | | | | | | | | | |
| | | 3 | | Max. Operating Temp. +3/-0 | 30±3 | | | | | | | | | | | | | |
| 4 | Room Temp. | 2 to 3 | | | | | | | | | | | | | | | | |
| Capacitance Change | Within ±7.5% | | | | | | | | | | | | | | | | | |
| D.F. | Within the specified initial value. | | | | | | | | | | | | | | | | | |
| I.R. | Within the specified initial value. | | | | | | | | | | | | | | | | | |
| Voltage Proof | No defects. | | | | | | | | | | | | | | | | | |
| 15 | High Temperature High Humidity (Steady) | Appearance | <p>Fix the capacitor to the supporting Test substrate A (glass epoxy board) shown in "Complement of Test Method". Test Temperature: 40±2°C Test Humidity: 90 to 95%RH Test Time: 500+24/-0h Applied Voltage: DC Rated Voltage Exposure Time: 24±2h at room condition*. • Pretreatment Apply test voltage for 1h±5min at test temperature. Remove and let sit for 24±2h at room condition*.</p> | | | | | | | | | | | | | | | |
| | | Capacitance Change | | Within ±15% | | | | | | | | | | | | | | |
| | | D.F. | | 0.05 max. | | | | | | | | | | | | | | |
| | | I.R. | | C ≥ 0.01μF: 10MΩ • μF or more C < 0.01μF: 1000MΩ or more | | | | | | | | | | | | | | |
| | | Voltage Proof | | No defects. | | | | | | | | | | | | | | |
| 16 | Durability | Appearance | <p>Fix the capacitor to the supporting Test substrate A (glass epoxy board) shown in "Complement of Test Method". Test Temperature: Max. Operating Temp. ±3°C Test Time: 1000+48/-0h Applied Voltage: DC350V Charge/discharge current: 50mA max. Exposure Time: 24±2h at room condition*. • Pretreatment Apply test voltage for 1h±5min at test temperature. Remove and let sit for 24±2h at room condition*.</p> | | | | | | | | | | | | | | | |
| | | Capacitance Change | | Within ±15% | | | | | | | | | | | | | | |
| | | D.F. | | 0.05 max. | | | | | | | | | | | | | | |
| | | I.R. | | C ≥ 0.01μF: 10MΩ • μF or more C < 0.01μF: 1000MΩ or more | | | | | | | | | | | | | | |
| | | Voltage Proof | | No defects. | | | | | | | | | | | | | | |

* Room Condition: Temperature: 15 to 35°C, Relative humidity: 45 to 75%, Atmosphere pressure: 86 to 106kPa

Continued on the following page. ↗

GR7 Series Specifications and Test Methods (1)

Continued from the preceding page. ↘

Complement of Test Method

1. Test Substrate

The test substrate should be Substrate A or Substrate B as described in "Specifications and Test Methods".
 The specimen should be soldered by the conditions as described below.

Soldering Method: Reflow soldering
 Solder: Sn-3.0Ag-0.5Cu

(1) Test Substrate A

• Land Dimensions



- Material: Glass Epoxy Board
- Thickness: 1.6mm
- Thickness of Copper Foil: 0.035mm

| Part Number | Dimension (mm) | | |
|-------------|----------------|-----|------|
| | a | b | c |
| GR721 | 1.2 | 4.0 | 1.65 |
| GR731 | 2.2 | 5.0 | 2.0 |

(2) Test Substrate B



- Material: Glass Epoxy Board
- Thickness of Copper Foil: 0.035mm

| Part Number | Dimension (mm) | | | |
|-------------|----------------|-----|------|-----|
| | a | b | c | d |
| GR721 | 1.2 | 4.0 | 1.65 | 1.0 |
| GR731 | 2.2 | 5.0 | 2.0 | 1.0 |

2. Test Method of Substrate Bending Test

(a) Support State

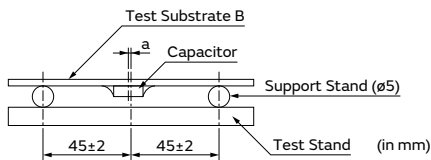

a: ±2 gap between support stand center and test stand

- Material of Test Stand and Pressure Stick
 The material should be a metal where a remarkable transformation and the distortion are not caused even if it is pressurized.
- Pressurizing Speed
 The pressurizing speed is pressurized at the speed of about 1mm/s until the flexure reaches a regulated value.

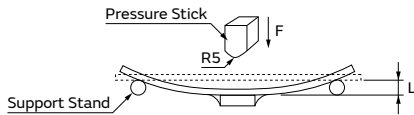

(b) Test State

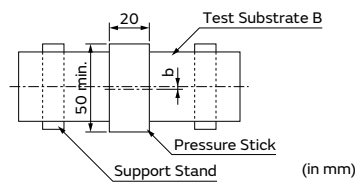

b: ±5 gap between support stand center and test stand center

GRM
 GR3
 GRJ
 GR4
 GR7
 GJM
 GQM
 GA2
 GA3 GB
 GA3 GD
 GA3 GF
 LLL
 LLA
 LLM
 LLR
 NFM
 KRM
 KR3
 GMA
 GMD
 Caution / Notice

High Q Chip Multilayer Ceramic Capacitors for General Purpose

GJM Series  **High Q** 

This product improves the high frequency characteristics and contributes to a reduction of power consumption by the High Q and low ESR.

Features

① **Mainly ideal for mobile communication devices and temperature compensation of related modules.**

This product is ideal for temperature compensation of high frequency circuits, such as resonant circuits, tuning circuits, and impedance matching circuits where the operating characteristics of the device are greatly affected by the capacitance fluctuation.

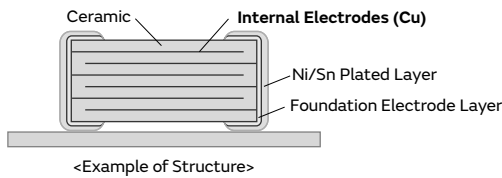

② **High Q and low ESR in VHF, UHF and microwave frequency bands.**

High Q and low ESR were achieved at a high frequency by adopting ceramic material as the dielectric material which enables an extremely low loss at high frequency, and base metal electrodes as the internal electrodes.

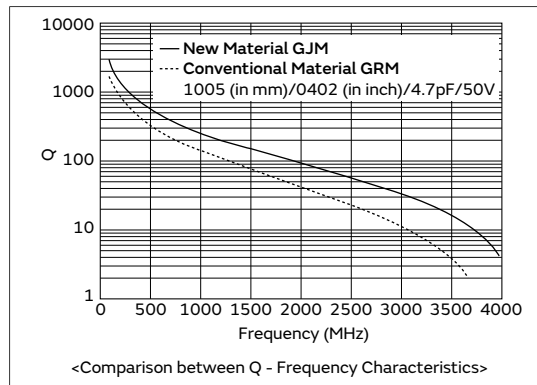
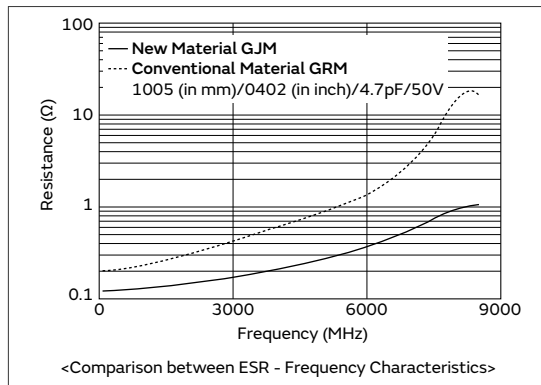

③ **Can be used for tight tolerance.**

In addition to standard tolerance, the allowable range of this product is also suitable for the following tight tolerance.

| Capacitance Range | Standard Capacitance Tolerance (Capacitance Tolerance Symbol) | Narrow Capacitance Tolerance (Capacitance Tolerance Symbol) |
|-------------------|---|---|
| to 0.9pF | ±0.1pF (B) | ±0.05pF (W) |
| 1.0 to 5.0pF | ±0.25pF (C) | ±0.05pF (W), ±0.1pF (B) |
| 5.1 to 9.9pF | ±0.5pF (D) | ±0.05pF (W), ±0.1pF (B), ±0.25pF (C) |
| 10pF to | ±5% (J) | ±2% (G) |

Specifications

| | |
|-------------------|---|
| Size (mm) | 0.4×0.2mm to 1.0×0.5mm |
| Rated Voltage | 6.3Vdc to 50Vdc |
| Capacitance | 0.10pF to 47pF |
| Main Applications | Small communication devices, such as mobile phones and high frequency communication modules |

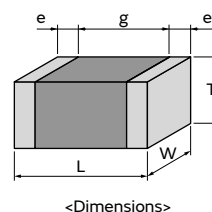

This catalog contains only a portion of the product lineup. Please refer to the capacitor search tool on the Murata Web site for details.

GJM Series Temperature Compensating Type Part Number List

0.4×0.2mm

| T max. | Rated Voltage | TC Code | Cap. | Tol. | Part Number | p* |
|--------|---------------|---------|--------|---------|--------------------|------|
| 0.22mm | 25Vdc | COG | 0.20pF | ±0.05pF | GJM0225C1ER20WB01# | p157 |
| | | | | ±0.1pF | GJM0225C1ER20BB01# | p157 |
| | | | 0.30pF | ±0.05pF | GJM0225C1ER30WB01# | p157 |
| | | | | ±0.1pF | GJM0225C1ER30BB01# | p157 |
| | | | 0.40pF | ±0.05pF | GJM0225C1ER40WB01# | p157 |
| | | | | ±0.1pF | GJM0225C1ER40BB01# | p157 |
| | | | 0.50pF | ±0.05pF | GJM0225C1ER50WB01# | p157 |
| | | | | ±0.1pF | GJM0225C1ER50BB01# | p157 |
| | | | 0.60pF | ±0.05pF | GJM0225C1ER60WB01# | p157 |
| | | | | ±0.1pF | GJM0225C1ER60BB01# | p157 |
| | | | 0.70pF | ±0.05pF | GJM0225C1ER70WB01# | p157 |
| | | | | ±0.1pF | GJM0225C1ER70BB01# | p157 |
| | | | 0.80pF | ±0.05pF | GJM0225C1ER80WB01# | p157 |
| | | | | ±0.1pF | GJM0225C1ER80BB01# | p157 |
| | | | 0.90pF | ±0.05pF | GJM0225C1ER90WB01# | p157 |
| | | | | ±0.1pF | GJM0225C1ER90BB01# | p157 |
| | | | 1.0pF | ±0.05pF | GJM0225C1E1R0WB01# | p157 |
| | | | | ±0.1pF | GJM0225C1E1R0BB01# | p157 |
| | | | | ±0.25pF | GJM0225C1E1R0CB01# | p157 |
| | | | 1.1pF | ±0.05pF | GJM0225C1E1R1WB01# | p157 |
| | | | | ±0.1pF | GJM0225C1E1R1BB01# | p157 |
| | | | | ±0.25pF | GJM0225C1E1R1CB01# | p157 |
| | | | 1.2pF | ±0.05pF | GJM0225C1E1R2WB01# | p157 |
| | | | | ±0.1pF | GJM0225C1E1R2BB01# | p157 |
| | | | | ±0.25pF | GJM0225C1E1R2CB01# | p157 |
| | | | 1.3pF | ±0.05pF | GJM0225C1E1R3WB01# | p157 |
| | | | | ±0.1pF | GJM0225C1E1R3BB01# | p157 |
| | | | | ±0.25pF | GJM0225C1E1R3CB01# | p157 |
| | | | 1.4pF | ±0.05pF | GJM0225C1E1R4WB01# | p157 |
| | | | | ±0.1pF | GJM0225C1E1R4BB01# | p157 |
| | | | | ±0.25pF | GJM0225C1E1R4CB01# | p157 |
| | | | 1.5pF | ±0.05pF | GJM0225C1E1R5WB01# | p157 |
| | | | | ±0.1pF | GJM0225C1E1R5BB01# | p157 |
| | | | | ±0.25pF | GJM0225C1E1R5CB01# | p157 |
| | | | 1.6pF | ±0.05pF | GJM0225C1E1R6WB01# | p157 |
| | | | | ±0.1pF | GJM0225C1E1R6BB01# | p157 |
| | | | | ±0.25pF | GJM0225C1E1R6CB01# | p157 |
| | | | 1.7pF | ±0.05pF | GJM0225C1E1R7WB01# | p157 |
| | | | | ±0.1pF | GJM0225C1E1R7BB01# | p157 |
| | | | | ±0.25pF | GJM0225C1E1R7CB01# | p157 |
| | | | 1.8pF | ±0.05pF | GJM0225C1E1R8WB01# | p157 |
| | | | | ±0.1pF | GJM0225C1E1R8BB01# | p157 |
| | | | | ±0.25pF | GJM0225C1E1R8CB01# | p157 |
| | | | 1.9pF | ±0.05pF | GJM0225C1E1R9WB01# | p157 |
| | | | | ±0.1pF | GJM0225C1E1R9BB01# | p157 |
| | | | | ±0.25pF | GJM0225C1E1R9CB01# | p157 |
| | | | 2.0pF | ±0.05pF | GJM0225C1E2R0WB01# | p157 |
| | | | | ±0.1pF | GJM0225C1E2R0BB01# | p157 |
| | | | | ±0.25pF | GJM0225C1E2R0CB01# | p157 |
| | | | 2.1pF | ±0.05pF | GJM0225C1E2R1WB01# | p157 |
| | | | | ±0.1pF | GJM0225C1E2R1BB01# | p157 |
| | | | | ±0.25pF | GJM0225C1E2R1CB01# | p157 |

| T max. | Rated Voltage | TC Code | Cap. | Tol. | Part Number | p* |
|--------|---------------|---------|-------|---------|--------------------|------|
| 0.22mm | 25Vdc | COG | 2.2pF | ±0.05pF | GJM0225C1E2R2WB01# | p157 |
| | | | | ±0.1pF | GJM0225C1E2R2BB01# | p157 |
| | | | | ±0.25pF | GJM0225C1E2R2CB01# | p157 |
| | | | 2.3pF | ±0.05pF | GJM0225C1E2R3WB01# | p157 |
| | | | | ±0.1pF | GJM0225C1E2R3BB01# | p157 |
| | | | | ±0.25pF | GJM0225C1E2R3CB01# | p157 |
| | | | 2.4pF | ±0.05pF | GJM0225C1E2R4WB01# | p157 |
| | | | | ±0.1pF | GJM0225C1E2R4BB01# | p157 |
| | | | | ±0.25pF | GJM0225C1E2R4CB01# | p157 |
| | | | 2.5pF | ±0.05pF | GJM0225C1E2R5WB01# | p157 |
| | | | | ±0.1pF | GJM0225C1E2R5BB01# | p157 |
| | | | | ±0.25pF | GJM0225C1E2R5CB01# | p157 |
| | | | 2.6pF | ±0.05pF | GJM0225C1E2R6WB01# | p157 |
| | | | | ±0.1pF | GJM0225C1E2R6BB01# | p157 |
| | | | | ±0.25pF | GJM0225C1E2R6CB01# | p157 |
| | | | 2.7pF | ±0.05pF | GJM0225C1E2R7WB01# | p157 |
| | | | | ±0.1pF | GJM0225C1E2R7BB01# | p157 |
| | | | | ±0.25pF | GJM0225C1E2R7CB01# | p157 |
| | | | 2.8pF | ±0.05pF | GJM0225C1E2R8WB01# | p157 |
| | | | | ±0.1pF | GJM0225C1E2R8BB01# | p157 |
| | | | | ±0.25pF | GJM0225C1E2R8CB01# | p157 |
| | | | 2.9pF | ±0.05pF | GJM0225C1E2R9WB01# | p157 |
| | | | | ±0.1pF | GJM0225C1E2R9BB01# | p157 |
| | | | | ±0.25pF | GJM0225C1E2R9CB01# | p157 |
| | | | 3.0pF | ±0.05pF | GJM0225C1E3R0WB01# | p157 |
| | | | | ±0.1pF | GJM0225C1E3R0BB01# | p157 |
| | | | | ±0.25pF | GJM0225C1E3R0CB01# | p157 |
| | | | 3.1pF | ±0.05pF | GJM0225C1E3R1WB01# | p157 |
| | | | | ±0.1pF | GJM0225C1E3R1BB01# | p157 |
| | | | | ±0.25pF | GJM0225C1E3R1CB01# | p157 |
| | | | 3.2pF | ±0.05pF | GJM0225C1E3R2WB01# | p157 |
| | | | | ±0.1pF | GJM0225C1E3R2BB01# | p157 |
| | | | | ±0.25pF | GJM0225C1E3R2CB01# | p157 |
| | | | 3.3pF | ±0.05pF | GJM0225C1E3R3WB01# | p157 |
| | | | | ±0.1pF | GJM0225C1E3R3BB01# | p157 |
| | | | | ±0.25pF | GJM0225C1E3R3CB01# | p157 |
| | | | 3.4pF | ±0.05pF | GJM0225C1E3R4WB01# | p157 |
| | | | | ±0.1pF | GJM0225C1E3R4BB01# | p157 |
| | | | | ±0.25pF | GJM0225C1E3R4CB01# | p157 |
| | | | 3.5pF | ±0.05pF | GJM0225C1E3R5WB01# | p157 |
| | | | | ±0.1pF | GJM0225C1E3R5BB01# | p157 |
| | | | | ±0.25pF | GJM0225C1E3R5CB01# | p157 |
| | | | 3.6pF | ±0.05pF | GJM0225C1E3R6WB01# | p157 |
| | | | | ±0.1pF | GJM0225C1E3R6BB01# | p157 |
| | | | | ±0.25pF | GJM0225C1E3R6CB01# | p157 |
| | | | 3.7pF | ±0.05pF | GJM0225C1E3R7WB01# | p157 |
| | | | | ±0.1pF | GJM0225C1E3R7BB01# | p157 |
| | | | | ±0.25pF | GJM0225C1E3R7CB01# | p157 |
| | | | 3.8pF | ±0.05pF | GJM0225C1E3R8WB01# | p157 |
| | | | | ±0.1pF | GJM0225C1E3R8BB01# | p157 |
| | | | | ±0.25pF | GJM0225C1E3R8CB01# | p157 |
| | | | 3.9pF | ±0.05pF | GJM0225C1E3R9WB01# | p157 |
| | | | | ±0.1pF | GJM0225C1E3R9BB01# | p157 |
| | | | | ±0.25pF | GJM0225C1E3R9CB01# | p157 |

*: Refers to the page of the "Specifications and Test Methods".

Part number # indicates the package specification code.



GJM Series Temperature Compensating Type Part Number List

(→ 0.4×0.2mm)

| T max. | Rated Voltage | TC Code | Cap. | Tol. | Part Number | p* |
|--------|---------------|---------|-------|---------|--------------------|------|
| 0.22mm | 25Vdc | COG | 4.0pF | ±0.05pF | GJM0225C1E4ROWB01# | p157 |
| | | | | ±0.1pF | GJM0225C1E4ROBB01# | p157 |
| | | | | ±0.25pF | GJM0225C1E4ROCB01# | p157 |
| | | | 4.1pF | ±0.05pF | GJM0225C1E4R1WB01# | p157 |
| | | | | ±0.1pF | GJM0225C1E4R1BB01# | p157 |
| | | | | ±0.25pF | GJM0225C1E4R1CB01# | p157 |
| | | | 4.2pF | ±0.05pF | GJM0225C1E4R2WB01# | p157 |
| | | | | ±0.1pF | GJM0225C1E4R2BB01# | p157 |
| | | | | ±0.25pF | GJM0225C1E4R2CB01# | p157 |
| | | | 4.3pF | ±0.05pF | GJM0225C1E4R3WB01# | p157 |
| | | | | ±0.1pF | GJM0225C1E4R3BB01# | p157 |
| | | | | ±0.25pF | GJM0225C1E4R3CB01# | p157 |
| | | | 4.4pF | ±0.05pF | GJM0225C1E4R4WB01# | p157 |
| | | | | ±0.1pF | GJM0225C1E4R4BB01# | p157 |
| | | | | ±0.25pF | GJM0225C1E4R4CB01# | p157 |
| | | | 4.5pF | ±0.05pF | GJM0225C1E4R5WB01# | p157 |
| | | | | ±0.1pF | GJM0225C1E4R5BB01# | p157 |
| | | | | ±0.25pF | GJM0225C1E4R5CB01# | p157 |
| | | | 4.6pF | ±0.05pF | GJM0225C1E4R6WB01# | p157 |
| | | | | ±0.1pF | GJM0225C1E4R6BB01# | p157 |
| | | | | ±0.25pF | GJM0225C1E4R6CB01# | p157 |
| | | | 4.7pF | ±0.05pF | GJM0225C1E4R7WB01# | p157 |
| | | | | ±0.1pF | GJM0225C1E4R7BB01# | p157 |
| | | | | ±0.25pF | GJM0225C1E4R7CB01# | p157 |
| | | | 4.8pF | ±0.05pF | GJM0225C1E4R8WB01# | p157 |
| | | | | ±0.1pF | GJM0225C1E4R8BB01# | p157 |
| | | | | ±0.25pF | GJM0225C1E4R8CB01# | p157 |
| | | | 4.9pF | ±0.05pF | GJM0225C1E4R9WB01# | p157 |
| | | | | ±0.1pF | GJM0225C1E4R9BB01# | p157 |
| | | | | ±0.25pF | GJM0225C1E4R9CB01# | p157 |
| | | | 5.0pF | ±0.05pF | GJM0225C1E5R0WB01# | p157 |
| | | | | ±0.1pF | GJM0225C1E5R0BB01# | p157 |
| | | | | ±0.25pF | GJM0225C1E5R0CB01# | p157 |
| | | | 5.1pF | ±0.05pF | GJM0225C1E5R1WB01# | p157 |
| | | | | ±0.1pF | GJM0225C1E5R1BB01# | p157 |
| | | | | ±0.25pF | GJM0225C1E5R1CB01# | p157 |
| | | | 5.2pF | ±0.05pF | GJM0225C1E5R2WB01# | p157 |
| | | | | ±0.1pF | GJM0225C1E5R2BB01# | p157 |
| | | | | ±0.25pF | GJM0225C1E5R2CB01# | p157 |
| | | | 5.3pF | ±0.05pF | GJM0225C1E5R3WB01# | p157 |
| | | | | ±0.1pF | GJM0225C1E5R3BB01# | p157 |
| | | | | ±0.25pF | GJM0225C1E5R3CB01# | p157 |
| | | | 5.4pF | ±0.05pF | GJM0225C1E5R4WB01# | p157 |
| | | | | ±0.1pF | GJM0225C1E5R4BB01# | p157 |
| | | | | ±0.25pF | GJM0225C1E5R4CB01# | p157 |
| | | | 5.5pF | ±0.05pF | GJM0225C1E5R5WB01# | p157 |
| | | | | ±0.1pF | GJM0225C1E5R5BB01# | p157 |
| | | | | ±0.25pF | GJM0225C1E5R5CB01# | p157 |
| | | | 5.6pF | ±0.05pF | GJM0225C1E5R6WB01# | p157 |
| | | | | ±0.1pF | GJM0225C1E5R6BB01# | p157 |
| | | | | ±0.25pF | GJM0225C1E5R6CB01# | p157 |

| T max. | Rated Voltage | TC Code | Cap. | Tol. | Part Number | p* |
|--------|---------------|---------|-------|---------|--------------------|------|
| 0.22mm | 25Vdc | COG | 5.6pF | ±0.1pF | GJM0225C1E5R6BB01# | p157 |
| | | | | ±0.25pF | GJM0225C1E5R6CB01# | p157 |
| | | | | ±0.5pF | GJM0225C1E5R6DB01# | p157 |
| | | | 5.7pF | ±0.05pF | GJM0225C1E5R7WB01# | p157 |
| | | | | ±0.1pF | GJM0225C1E5R7BB01# | p157 |
| | | | | ±0.25pF | GJM0225C1E5R7CB01# | p157 |
| | | | 5.8pF | ±0.05pF | GJM0225C1E5R8WB01# | p157 |
| | | | | ±0.1pF | GJM0225C1E5R8BB01# | p157 |
| | | | | ±0.25pF | GJM0225C1E5R8CB01# | p157 |
| | | | 5.9pF | ±0.05pF | GJM0225C1E5R9WB01# | p157 |
| | | | | ±0.1pF | GJM0225C1E5R9BB01# | p157 |
| | | | | ±0.25pF | GJM0225C1E5R9CB01# | p157 |
| | | | 6.0pF | ±0.05pF | GJM0225C1E6R0WB01# | p157 |
| | | | | ±0.1pF | GJM0225C1E6R0BB01# | p157 |
| | | | | ±0.25pF | GJM0225C1E6R0CB01# | p157 |
| | | | 6.1pF | ±0.05pF | GJM0225C1E6R1WB01# | p157 |
| | | | | ±0.1pF | GJM0225C1E6R1BB01# | p157 |
| | | | | ±0.25pF | GJM0225C1E6R1CB01# | p157 |
| | | | 6.2pF | ±0.05pF | GJM0225C1E6R2WB01# | p157 |
| | | | | ±0.1pF | GJM0225C1E6R2BB01# | p157 |
| | | | | ±0.25pF | GJM0225C1E6R2CB01# | p157 |
| | | | 6.3pF | ±0.05pF | GJM0225C1E6R3WB01# | p157 |
| | | | | ±0.1pF | GJM0225C1E6R3BB01# | p157 |
| | | | | ±0.25pF | GJM0225C1E6R3CB01# | p157 |
| | | | 6.4pF | ±0.05pF | GJM0225C1E6R4WB01# | p157 |
| | | | | ±0.1pF | GJM0225C1E6R4BB01# | p157 |
| | | | | ±0.25pF | GJM0225C1E6R4CB01# | p157 |
| | | | 6.5pF | ±0.05pF | GJM0225C1E6R5WB01# | p157 |
| | | | | ±0.1pF | GJM0225C1E6R5BB01# | p157 |
| | | | | ±0.25pF | GJM0225C1E6R5CB01# | p157 |
| | | | 6.6pF | ±0.05pF | GJM0225C1E6R6WB01# | p157 |
| | | | | ±0.1pF | GJM0225C1E6R6BB01# | p157 |
| | | | | ±0.25pF | GJM0225C1E6R6CB01# | p157 |
| | | | 6.7pF | ±0.05pF | GJM0225C1E6R7WB01# | p157 |
| | | | | ±0.1pF | GJM0225C1E6R7BB01# | p157 |
| | | | | ±0.25pF | GJM0225C1E6R7CB01# | p157 |
| | | | 6.8pF | ±0.05pF | GJM0225C1E6R8WB01# | p157 |
| | | | | ±0.1pF | GJM0225C1E6R8BB01# | p157 |
| | | | | ±0.25pF | GJM0225C1E6R8CB01# | p157 |
| | | | 6.9pF | ±0.05pF | GJM0225C1E6R9WB01# | p157 |
| | | | | ±0.1pF | GJM0225C1E6R9BB01# | p157 |
| | | | | ±0.25pF | GJM0225C1E6R9CB01# | p157 |

*: Refers to the page of the "Specifications and Test Methods".

Part number # indicates the package specification code.

GJM Series Temperature Compensating Type Part Number List

(→ 0.4×0.2mm)

| T max. | Rated Voltage | TC Code | Cap. | Tol. | Part Number | p* | T max. | Rated Voltage | TC Code | Cap. | Tol. | Part Number | p* |
|--------|---------------|---------|-------|---------|--------------------|------|--------|---------------|---------|--------|---------|--------------------|------|
| 0.22mm | 25Vdc | COG | 6.9pF | ±0.5pF | GJM0225C1E6R9DB01# | p157 | 0.22mm | 25Vdc | COG | 8.3pF | ±0.1pF | GJM0225C1E8R3BB01# | p157 |
| | | | | ±0.05pF | GJM0225C1E7R0WB01# | p157 | | | | | ±0.25pF | GJM0225C1E8R3CB01# | p157 |
| | | | | ±0.1pF | GJM0225C1E7R0BB01# | p157 | | | | | ±0.5pF | GJM0225C1E8R3DB01# | p157 |
| | | | 7.0pF | ±0.25pF | GJM0225C1E7R0CB01# | p157 | | | | 8.4pF | ±0.05pF | GJM0225C1E8R4WB01# | p157 |
| | | | | ±0.5pF | GJM0225C1E7R0DB01# | p157 | | | | | ±0.1pF | GJM0225C1E8R4BB01# | p157 |
| | | | | ±0.05pF | GJM0225C1E7R1WB01# | p157 | | | | | ±0.25pF | GJM0225C1E8R4CB01# | p157 |
| | | | 7.1pF | ±0.1pF | GJM0225C1E7R1BB01# | p157 | | | | 8.5pF | ±0.5pF | GJM0225C1E8R4DB01# | p157 |
| | | | | ±0.25pF | GJM0225C1E7R1CB01# | p157 | | | | | ±0.05pF | GJM0225C1E8R5WB01# | p157 |
| | | | | ±0.5pF | GJM0225C1E7R1DB01# | p157 | | | | | ±0.1pF | GJM0225C1E8R5BB01# | p157 |
| | | | 7.2pF | ±0.05pF | GJM0225C1E7R2WB01# | p157 | | | | 8.6pF | ±0.25pF | GJM0225C1E8R5CB01# | p157 |
| | | | | ±0.1pF | GJM0225C1E7R2BB01# | p157 | | | | | ±0.5pF | GJM0225C1E8R5DB01# | p157 |
| | | | | ±0.25pF | GJM0225C1E7R2CB01# | p157 | | | | | ±0.05pF | GJM0225C1E8R6WB01# | p157 |
| | | | 7.3pF | ±0.5pF | GJM0225C1E7R2DB01# | p157 | | | | 8.7pF | ±0.1pF | GJM0225C1E8R6BB01# | p157 |
| | | | | ±0.05pF | GJM0225C1E7R3WB01# | p157 | | | | | ±0.25pF | GJM0225C1E8R6CB01# | p157 |
| | | | | ±0.1pF | GJM0225C1E7R3BB01# | p157 | | | | | ±0.5pF | GJM0225C1E8R6DB01# | p157 |
| | | | 7.4pF | ±0.25pF | GJM0225C1E7R3CB01# | p157 | | | | 8.8pF | ±0.05pF | GJM0225C1E8R7WB01# | p157 |
| | | | | ±0.5pF | GJM0225C1E7R3DB01# | p157 | | | | | ±0.1pF | GJM0225C1E8R7BB01# | p157 |
| | | | | ±0.05pF | GJM0225C1E7R4WB01# | p157 | | | | | ±0.25pF | GJM0225C1E8R7CB01# | p157 |
| | | | 7.5pF | ±0.1pF | GJM0225C1E7R4BB01# | p157 | | | | 8.9pF | ±0.5pF | GJM0225C1E8R7DB01# | p157 |
| | | | | ±0.25pF | GJM0225C1E7R4CB01# | p157 | | | | | ±0.05pF | GJM0225C1E8R8WB01# | p157 |
| | | | | ±0.5pF | GJM0225C1E7R4DB01# | p157 | | | | | ±0.1pF | GJM0225C1E8R8BB01# | p157 |
| | | | 7.6pF | ±0.05pF | GJM0225C1E7R5WB01# | p157 | | | | 9.0pF | ±0.25pF | GJM0225C1E8R8CB01# | p157 |
| | | | | ±0.1pF | GJM0225C1E7R5BB01# | p157 | | | | | ±0.5pF | GJM0225C1E8R8DB01# | p157 |
| | | | | ±0.25pF | GJM0225C1E7R5CB01# | p157 | | | | | ±0.05pF | GJM0225C1E8R9WB01# | p157 |
| | | | 7.7pF | ±0.5pF | GJM0225C1E7R5DB01# | p157 | | | | 9.1pF | ±0.1pF | GJM0225C1E8R9BB01# | p157 |
| | | | | ±0.05pF | GJM0225C1E7R6WB01# | p157 | | | | | ±0.25pF | GJM0225C1E8R9CB01# | p157 |
| | | | | ±0.1pF | GJM0225C1E7R6BB01# | p157 | | | | | ±0.5pF | GJM0225C1E8R9DB01# | p157 |
| | | | 7.8pF | ±0.25pF | GJM0225C1E7R6CB01# | p157 | | | | 9.2pF | ±0.05pF | GJM0225C1E9R0WB01# | p157 |
| | | | | ±0.5pF | GJM0225C1E7R6DB01# | p157 | | | | | ±0.1pF | GJM0225C1E9R0BB01# | p157 |
| | | | | ±0.05pF | GJM0225C1E7R7WB01# | p157 | | | | | ±0.25pF | GJM0225C1E9R0CB01# | p157 |
| | | | 7.9pF | ±0.1pF | GJM0225C1E7R7BB01# | p157 | | | | 9.3pF | ±0.5pF | GJM0225C1E9R0DB01# | p157 |
| | | | | ±0.25pF | GJM0225C1E7R7CB01# | p157 | | | | | ±0.05pF | GJM0225C1E9R1WB01# | p157 |
| | | | | ±0.5pF | GJM0225C1E7R7DB01# | p157 | | | | | ±0.1pF | GJM0225C1E9R1BB01# | p157 |
| | | | 8.0pF | ±0.05pF | GJM0225C1E7R8WB01# | p157 | | | | 9.4pF | ±0.25pF | GJM0225C1E9R1CB01# | p157 |
| | | | | ±0.1pF | GJM0225C1E7R8BB01# | p157 | | | | | ±0.5pF | GJM0225C1E9R1DB01# | p157 |
| | | | | ±0.25pF | GJM0225C1E7R8CB01# | p157 | | | | | ±0.05pF | GJM0225C1E9R2WB01# | p157 |
| | | | 8.1pF | ±0.5pF | GJM0225C1E7R8DB01# | p157 | | | | 9.5pF | ±0.1pF | GJM0225C1E9R2BB01# | p157 |
| | | | | ±0.05pF | GJM0225C1E7R9WB01# | p157 | | | | | ±0.25pF | GJM0225C1E9R2CB01# | p157 |
| | | | | ±0.1pF | GJM0225C1E7R9BB01# | p157 | | | | | ±0.5pF | GJM0225C1E9R2DB01# | p157 |
| | | | 8.2pF | ±0.25pF | GJM0225C1E7R9CB01# | p157 | | | | 9.6pF | ±0.05pF | GJM0225C1E9R3WB01# | p157 |
| | | | | ±0.5pF | GJM0225C1E7R9DB01# | p157 | | | | | ±0.1pF | GJM0225C1E9R3BB01# | p157 |
| | | | | ±0.05pF | GJM0225C1E8ROWB01# | p157 | | | | | ±0.25pF | GJM0225C1E9R3CB01# | p157 |
| | | | 8.3pF | ±0.1pF | GJM0225C1E8R0BB01# | p157 | | | | 9.7pF | ±0.5pF | GJM0225C1E9R3DB01# | p157 |
| | | | | ±0.25pF | GJM0225C1E8R0CB01# | p157 | | | | | ±0.05pF | GJM0225C1E9R4WB01# | p157 |
| | | | | ±0.5pF | GJM0225C1E8R0DB01# | p157 | | | | | ±0.1pF | GJM0225C1E9R4BB01# | p157 |
| | | | 8.4pF | ±0.05pF | GJM0225C1E8R1WB01# | p157 | | | | 9.8pF | ±0.25pF | GJM0225C1E9R4CB01# | p157 |
| | | | | ±0.1pF | GJM0225C1E8R1BB01# | p157 | | | | | ±0.5pF | GJM0225C1E9R4DB01# | p157 |
| | | | | ±0.25pF | GJM0225C1E8R1CB01# | p157 | | | | | ±0.05pF | GJM0225C1E9R5WB01# | p157 |
| | | | 8.5pF | ±0.5pF | GJM0225C1E8R1DB01# | p157 | | | | 9.9pF | ±0.1pF | GJM0225C1E9R5BB01# | p157 |
| | | | | ±0.05pF | GJM0225C1E8R2WB01# | p157 | | | | | ±0.25pF | GJM0225C1E9R5CB01# | p157 |
| | | | | ±0.1pF | GJM0225C1E8R2BB01# | p157 | | | | | ±0.5pF | GJM0225C1E9R5DB01# | p157 |
| | | | 8.6pF | ±0.25pF | GJM0225C1E8R2CB01# | p157 | | | | 10.0pF | ±0.05pF | GJM0225C1E9R6WB01# | p157 |
| | | | | ±0.5pF | GJM0225C1E8R2DB01# | p157 | | | | | ±0.1pF | GJM0225C1E9R6BB01# | p157 |
| | | | | ±0.05pF | GJM0225C1E8R3WB01# | p157 | | | | | ±0.25pF | GJM0225C1E9R6CB01# | p157 |

*: Refers to the page of the "Specifications and Test Methods".

Part number # indicates the package specification code.



GJM Series Temperature Compensating Type Part Number List

(→ 0.4×0.2mm)

| T max. | Rated Voltage | TC Code | Cap. | Tol. | Part Number | p* | T max. | Rated Voltage | TC Code | Cap. | Tol. | Part Number | p* |
|---------|--------------------|--------------------|---------|--------------------|--------------------|--------------------|--------------------|--------------------|---------|---------|---------|--------------------|--------------------|
| 0.22mm | 25Vdc | COG | 9.6pF | ±0.5pF | GJM0225C1E9R6DB01# | p157 | 0.22mm | 25Vdc | CK | 1.2pF | ±0.1pF | GJM0224C1E1R2BB01# | p157 |
| | | | | ±0.05pF | GJM0225C1E9R7WB01# | p157 | | | | | ±0.25pF | GJM0224C1E1R2CB01# | p157 |
| | | | 9.7pF | ±0.1pF | GJM0225C1E9R7BB01# | p157 | | | | 1.3pF | ±0.05pF | GJM0224C1E1R3WB01# | p157 |
| | | | | ±0.25pF | GJM0225C1E9R7CB01# | p157 | | | | | ±0.1pF | GJM0224C1E1R3BB01# | p157 |
| | | | | ±0.5pF | GJM0225C1E9R7DB01# | p157 | | | | | ±0.25pF | GJM0224C1E1R3CB01# | p157 |
| | | | 9.8pF | ±0.05pF | GJM0225C1E9R8WB01# | p157 | | | | 1.4pF | ±0.05pF | GJM0224C1E1R4WB01# | p157 |
| | | | | ±0.1pF | GJM0225C1E9R8BB01# | p157 | | | | | ±0.1pF | GJM0224C1E1R4BB01# | p157 |
| | | | | ±0.25pF | GJM0225C1E9R8CB01# | p157 | | | | | ±0.25pF | GJM0224C1E1R4CB01# | p157 |
| | | | | ±0.5pF | GJM0225C1E9R8DB01# | p157 | | | | | 1.5pF | ±0.05pF | GJM0224C1E1R5WB01# |
| | | | 9.9pF | ±0.05pF | GJM0225C1E9R9WB01# | p157 | | | | ±0.1pF | | GJM0224C1E1R5BB01# | p157 |
| | | | | ±0.1pF | GJM0225C1E9R9BB01# | p157 | | | | ±0.25pF | | GJM0224C1E1R5CB01# | p157 |
| | | | 10pF | ±0.25pF | GJM0225C1E9R9CB01# | p157 | | | | 1.6pF | ±0.05pF | GJM0224C1E1R6WB01# | p157 |
| | | | | ±0.5pF | GJM0225C1E9R9DB01# | p157 | | | | | ±0.1pF | GJM0224C1E1R6BB01# | p157 |
| | | | | ±2% | GJM0225C1E100GB01# | p157 | | | | | ±0.25pF | GJM0224C1E1R6CB01# | p157 |
| | | | 11pF | ±5% | GJM0225C1E100JB01# | p157 | | | | 1.7pF | ±0.05pF | GJM0224C1E1R7WB01# | p157 |
| | | | | ±2% | GJM0225C1E110GB01# | p157 | | | | | ±0.1pF | GJM0224C1E1R7BB01# | p157 |
| | | | 12pF | ±5% | GJM0225C1E110JB01# | p157 | | | | 1.8pF | ±0.05pF | GJM0224C1E1R8WB01# | p157 |
| | | | | ±2% | GJM0225C1E120GB01# | p157 | | | | | ±0.1pF | GJM0224C1E1R8BB01# | p157 |
| | | | 13pF | ±5% | GJM0225C1E120JB01# | p157 | | | | 1.9pF | ±0.25pF | GJM0224C1E1R8CB01# | p157 |
| | | | | ±2% | GJM0225C1E130GB01# | p157 | | | | | ±0.05pF | GJM0224C1E1R9WB01# | p157 |
| | | | 15pF | ±5% | GJM0225C1E130JB01# | p157 | | | | 2.0pF | ±0.1pF | GJM0224C1E1R9BB01# | p157 |
| | | | | ±2% | GJM0225C1E150GB01# | p157 | | | | | ±0.25pF | GJM0224C1E1R9CB01# | p157 |
| | | | 16pF | ±5% | GJM0225C1E150JB01# | p157 | | | | 2.1pF | ±0.05pF | GJM0224C1E2R0WB01# | p157 |
| | | | | ±2% | GJM0225C1E160GB01# | p157 | | | | | ±0.1pF | GJM0224C1E2R0BB01# | p157 |
| | | | 18pF | ±5% | GJM0225C1E160JB01# | p157 | | | | 2.2pF | ±0.25pF | GJM0224C1E2R0CB01# | p157 |
| | | ±2% | | GJM0225C1E180GB01# | p157 | ±0.05pF | GJM0223C1E2R1WB01# | p157 | | | | | |
| | | 20pF | ±5% | GJM0225C1E180JB01# | p157 | 2.3pF | ±0.1pF | GJM0223C1E2R1BB01# | p157 | | | | |
| | | | ±2% | GJM0225C1E200GB01# | p157 | | ±0.25pF | GJM0223C1E2R1CB01# | p157 | | | | |
| | | 22pF | ±5% | GJM0225C1E200JB01# | p157 | 2.4pF | ±0.05pF | GJM0223C1E2R2WB01# | p157 | | | | |
| | | | ±2% | GJM0225C1E220GB01# | p157 | | ±0.1pF | GJM0223C1E2R2BB01# | p157 | | | | |
| | | 0.20pF | ±5% | GJM0225C1E220JB01# | p157 | 2.5pF | ±0.25pF | GJM0223C1E2R2CB01# | p157 | | | | |
| | | | ±0.05pF | GJM0224C1ER20WB01# | p157 | | ±0.05pF | GJM0223C1E2R3WB01# | p157 | | | | |
| | | 0.30pF | ±0.1pF | GJM0224C1ER20BB01# | p157 | 2.6pF | ±0.1pF | GJM0223C1E2R3BB01# | p157 | | | | |
| | | | ±0.05pF | GJM0224C1ER30WB01# | p157 | | ±0.25pF | GJM0223C1E2R3CB01# | p157 | | | | |
| | | 0.40pF | ±0.1pF | GJM0224C1ER30BB01# | p157 | 2.7pF | ±0.05pF | GJM0223C1E2R4WB01# | p157 | | | | |
| | | | ±0.05pF | GJM0224C1ER40WB01# | p157 | | ±0.1pF | GJM0223C1E2R4BB01# | p157 | | | | |
| | | 0.50pF | ±0.1pF | GJM0224C1ER40BB01# | p157 | 2.8pF | ±0.25pF | GJM0223C1E2R4CB01# | p157 | | | | |
| | | | ±0.05pF | GJM0224C1ER50WB01# | p157 | | ±0.05pF | GJM0223C1E2R5WB01# | p157 | | | | |
| | | 0.60pF | ±0.1pF | GJM0224C1ER50BB01# | p157 | 2.9pF | ±0.1pF | GJM0223C1E2R5BB01# | p157 | | | | |
| | | | ±0.05pF | GJM0224C1ER60WB01# | p157 | | ±0.25pF | GJM0223C1E2R5CB01# | p157 | | | | |
| | | 0.70pF | ±0.1pF | GJM0224C1ER60BB01# | p157 | 3.0pF | ±0.05pF | GJM0223C1E2R6WB01# | p157 | | | | |
| | | | ±0.05pF | GJM0224C1ER70WB01# | p157 | | ±0.1pF | GJM0223C1E2R6BB01# | p157 | | | | |
| | | 0.80pF | ±0.1pF | GJM0224C1ER70BB01# | p157 | 3.1pF | ±0.25pF | GJM0223C1E2R6CB01# | p157 | | | | |
| | | | ±0.05pF | GJM0224C1ER80WB01# | p157 | | ±0.05pF | GJM0223C1E2R7WB01# | p157 | | | | |
| | | 0.90pF | ±0.1pF | GJM0224C1ER80BB01# | p157 | 3.2pF | ±0.1pF | GJM0223C1E2R7BB01# | p157 | | | | |
| | | | ±0.05pF | GJM0224C1ER90WB01# | p157 | | ±0.25pF | GJM0223C1E2R7CB01# | p157 | | | | |
| | | 1.0pF | ±0.1pF | GJM0224C1ER90BB01# | p157 | 3.3pF | ±0.05pF | GJM0223C1E2R8WB01# | p157 | | | | |
| | | | ±0.05pF | GJM0224C1E1R0WB01# | p157 | | ±0.1pF | GJM0223C1E2R8BB01# | p157 | | | | |
| | | | ±0.25pF | GJM0224C1E1R0CB01# | p157 | | ±0.25pF | GJM0223C1E2R8CB01# | p157 | | | | |
| | | 1.1pF | ±0.05pF | GJM0224C1E1R1WB01# | p157 | 3.4pF | ±0.05pF | GJM0223C1E2R9WB01# | p157 | | | | |
| ±0.1pF | GJM0224C1E1R1BB01# | | p157 | ±0.1pF | GJM0223C1E2R9BB01# | | p157 | | | | | | |
| ±0.25pF | GJM0224C1E1R1CB01# | | p157 | ±0.25pF | GJM0223C1E2R9CB01# | | p157 | | | | | | |
| 1.2pF | ±0.05pF | GJM0224C1E1R2WB01# | p157 | 3.5pF | ±0.05pF | GJM0223C1E3R0WB01# | p157 | | | | | | |
| | ±0.05pF | GJM0224C1E1R2WB01# | p157 | | ±0.05pF | GJM0223C1E3R0WB01# | p157 | | | | | | |

*: Refers to the page of the "Specifications and Test Methods".

Part number # indicates the package specification code.

GJM Series Temperature Compensating Type Part Number List

(→ 0.4×0.2mm)

| T max. | Rated Voltage | TC Code | Cap. | Tol. | Part Number | p* | T max. | Rated Voltage | TC Code | Cap. | Tol. | Part Number | p* |
|--------|---------------|---------|---------|--------------------|--------------------|------|--------|---------------|---------|-------|---------|--------------------|------|
| 0.22mm | 25Vdc | CJ | 3.0pF | ±0.1pF | GJM0223C1E3R0BB01# | p157 | 0.22mm | 25Vdc | CH | 4.8pF | ±0.1pF | GJM0222C1E4R8BB01# | p157 |
| | | | | ±0.25pF | GJM0223C1E3R0CB01# | p157 | | | | | ±0.25pF | GJM0222C1E4R8CB01# | p157 |
| | | | 3.1pF | ±0.05pF | GJM0223C1E3R1WB01# | p157 | | | | 4.9pF | ±0.05pF | GJM0222C1E4R9WB01# | p157 |
| | | | | ±0.1pF | GJM0223C1E3R1BB01# | p157 | | | | | ±0.1pF | GJM0222C1E4R9BB01# | p157 |
| | | | | ±0.25pF | GJM0223C1E3R1CB01# | p157 | | | | | ±0.25pF | GJM0222C1E4R9CB01# | p157 |
| | | | 3.2pF | ±0.05pF | GJM0223C1E3R2WB01# | p157 | | | | 5.0pF | ±0.05pF | GJM0222C1E5R0WB01# | p157 |
| | | | | ±0.1pF | GJM0223C1E3R2BB01# | p157 | | | | | ±0.1pF | GJM0222C1E5R0BB01# | p157 |
| | | | | ±0.25pF | GJM0223C1E3R2CB01# | p157 | | | | | ±0.25pF | GJM0222C1E5R0CB01# | p157 |
| | | | 3.3pF | ±0.05pF | GJM0223C1E3R3WB01# | p157 | | | | 5.1pF | ±0.05pF | GJM0222C1E5R1WB01# | p157 |
| | | | | ±0.1pF | GJM0223C1E3R3BB01# | p157 | | | | | ±0.1pF | GJM0222C1E5R1BB01# | p157 |
| | | | | ±0.25pF | GJM0223C1E3R3CB01# | p157 | | | | | ±0.25pF | GJM0222C1E5R1CB01# | p157 |
| | | | 3.4pF | ±0.05pF | GJM0223C1E3R4WB01# | p157 | | | | 5.2pF | ±0.05pF | GJM0222C1E5R2WB01# | p157 |
| | | | | ±0.1pF | GJM0223C1E3R4BB01# | p157 | | | | | ±0.1pF | GJM0222C1E5R2BB01# | p157 |
| | | | | ±0.25pF | GJM0223C1E3R4CB01# | p157 | | | | | ±0.25pF | GJM0222C1E5R2CB01# | p157 |
| | | | 3.5pF | ±0.05pF | GJM0223C1E3R5WB01# | p157 | | | | 5.3pF | ±0.05pF | GJM0222C1E5R3WB01# | p157 |
| | | | | ±0.1pF | GJM0223C1E3R5BB01# | p157 | | | | | ±0.1pF | GJM0222C1E5R3BB01# | p157 |
| | | | | ±0.25pF | GJM0223C1E3R5CB01# | p157 | | | | | ±0.25pF | GJM0222C1E5R3CB01# | p157 |
| | | | 3.6pF | ±0.05pF | GJM0223C1E3R6WB01# | p157 | | | | 5.4pF | ±0.05pF | GJM0222C1E5R4WB01# | p157 |
| | | | | ±0.1pF | GJM0223C1E3R6BB01# | p157 | | | | | ±0.1pF | GJM0222C1E5R4BB01# | p157 |
| | | | | ±0.25pF | GJM0223C1E3R6CB01# | p157 | | | | | ±0.25pF | GJM0222C1E5R4CB01# | p157 |
| | | | 3.7pF | ±0.05pF | GJM0223C1E3R7WB01# | p157 | | | | 5.5pF | ±0.05pF | GJM0222C1E5R5WB01# | p157 |
| | | | | ±0.1pF | GJM0223C1E3R7BB01# | p157 | | | | | ±0.1pF | GJM0222C1E5R5BB01# | p157 |
| | | | | ±0.25pF | GJM0223C1E3R7CB01# | p157 | | | | | ±0.25pF | GJM0222C1E5R5CB01# | p157 |
| | | | 3.8pF | ±0.05pF | GJM0223C1E3R8WB01# | p157 | | | | 5.6pF | ±0.05pF | GJM0222C1E5R6WB01# | p157 |
| | | | | ±0.1pF | GJM0223C1E3R8BB01# | p157 | | | | | ±0.1pF | GJM0222C1E5R6BB01# | p157 |
| | | | | ±0.25pF | GJM0223C1E3R8CB01# | p157 | | | | | ±0.25pF | GJM0222C1E5R6CB01# | p157 |
| | | | 3.9pF | ±0.05pF | GJM0223C1E3R9WB01# | p157 | | | | 5.7pF | ±0.05pF | GJM0222C1E5R7WB01# | p157 |
| | | | | ±0.1pF | GJM0223C1E3R9BB01# | p157 | | | | | ±0.1pF | GJM0222C1E5R7BB01# | p157 |
| | | | | ±0.25pF | GJM0223C1E3R9CB01# | p157 | | | | | ±0.25pF | GJM0222C1E5R7CB01# | p157 |
| | | | 4.0pF | ±0.05pF | GJM0222C1E4R0WB01# | p157 | | | | 5.8pF | ±0.05pF | GJM0222C1E5R8WB01# | p157 |
| | | | | ±0.1pF | GJM0222C1E4R0BB01# | p157 | | | | | ±0.1pF | GJM0222C1E5R8BB01# | p157 |
| | | | | ±0.25pF | GJM0222C1E4R0CB01# | p157 | | | | | ±0.25pF | GJM0222C1E5R8CB01# | p157 |
| | | | 4.1pF | ±0.05pF | GJM0222C1E4R1WB01# | p157 | | | | 5.9pF | ±0.05pF | GJM0222C1E5R9WB01# | p157 |
| | | | | ±0.1pF | GJM0222C1E4R1BB01# | p157 | | | | | ±0.1pF | GJM0222C1E5R9BB01# | p157 |
| | | | | ±0.25pF | GJM0222C1E4R1CB01# | p157 | | | | | ±0.25pF | GJM0222C1E5R9CB01# | p157 |
| | | | 4.2pF | ±0.05pF | GJM0222C1E4R2WB01# | p157 | | | | 6.0pF | ±0.05pF | GJM0222C1E6R0WB01# | p157 |
| | | | | ±0.1pF | GJM0222C1E4R2BB01# | p157 | | | | | ±0.1pF | GJM0222C1E6R0BB01# | p157 |
| | | | | ±0.25pF | GJM0222C1E4R2CB01# | p157 | | | | | ±0.25pF | GJM0222C1E6R0CB01# | p157 |
| | | | 4.3pF | ±0.05pF | GJM0222C1E4R3WB01# | p157 | | | | 6.1pF | ±0.05pF | GJM0222C1E6R1WB01# | p157 |
| | | | | ±0.1pF | GJM0222C1E4R3BB01# | p157 | | | | | ±0.1pF | GJM0222C1E6R1BB01# | p157 |
| | | | | ±0.25pF | GJM0222C1E4R3CB01# | p157 | | | | | ±0.25pF | GJM0222C1E6R1CB01# | p157 |
| | | | 4.4pF | ±0.05pF | GJM0222C1E4R4WB01# | p157 | | | | 6.2pF | ±0.05pF | GJM0222C1E6R2WB01# | p157 |
| | | | | ±0.1pF | GJM0222C1E4R4BB01# | p157 | | | | | ±0.1pF | GJM0222C1E6R2BB01# | p157 |
| | | | | ±0.25pF | GJM0222C1E4R4CB01# | p157 | | | | | ±0.25pF | GJM0222C1E6R2CB01# | p157 |
| | | | 4.5pF | ±0.05pF | GJM0222C1E4R5WB01# | p157 | | | | | | | |
| | | | | ±0.1pF | GJM0222C1E4R5BB01# | p157 | | | | | | | |
| | | | | ±0.25pF | GJM0222C1E4R5CB01# | p157 | | | | | | | |
| | | | 4.6pF | ±0.05pF | GJM0222C1E4R6WB01# | p157 | | | | | | | |
| | | | | ±0.1pF | GJM0222C1E4R6BB01# | p157 | | | | | | | |
| | | | | ±0.25pF | GJM0222C1E4R6CB01# | p157 | | | | | | | |
| | | 4.7pF | ±0.05pF | GJM0222C1E4R7WB01# | p157 | | | | | | | | |
| | | | ±0.1pF | GJM0222C1E4R7BB01# | p157 | | | | | | | | |
| | | | ±0.25pF | GJM0222C1E4R7CB01# | p157 | | | | | | | | |
| | | 4.8pF | ±0.05pF | GJM0222C1E4R8WB01# | p157 | | | | | | | | |
| | | | | | | | | | | | | | |
| | | | | | | | | | | | | | |

*: Refers to the page of the "Specifications and Test Methods".

Part number # indicates the package specification code.



GJM Series Temperature Compensating Type Part Number List

(→ 0.4×0.2mm)

| T max. | Rated Voltage | TC Code | Cap. | Tol. | Part Number | p* |
|--------|---------------|---------|-------|---------|--------------------|------|
| 0.22mm | 25Vdc | CH | 6.2pF | ±0.25pF | GJM0222C1E6R2CB01# | p157 |
| | | | | ±0.5pF | GJM0222C1E6R2DB01# | p157 |
| | | | 6.3pF | ±0.05pF | GJM0222C1E6R3WB01# | p157 |
| | | | | ±0.1pF | GJM0222C1E6R3BB01# | p157 |
| | | | | ±0.25pF | GJM0222C1E6R3CB01# | p157 |
| | | | | ±0.5pF | GJM0222C1E6R3DB01# | p157 |
| | | | 6.4pF | ±0.05pF | GJM0222C1E6R4WB01# | p157 |
| | | | | ±0.1pF | GJM0222C1E6R4BB01# | p157 |
| | | | | ±0.25pF | GJM0222C1E6R4CB01# | p157 |
| | | | | ±0.5pF | GJM0222C1E6R4DB01# | p157 |
| | | | 6.5pF | ±0.05pF | GJM0222C1E6R5WB01# | p157 |
| | | | | ±0.1pF | GJM0222C1E6R5BB01# | p157 |
| | | | | ±0.25pF | GJM0222C1E6R5CB01# | p157 |
| | | | | ±0.5pF | GJM0222C1E6R5DB01# | p157 |
| | | | 6.6pF | ±0.05pF | GJM0222C1E6R6WB01# | p157 |
| | | | | ±0.1pF | GJM0222C1E6R6BB01# | p157 |
| | | | | ±0.25pF | GJM0222C1E6R6CB01# | p157 |
| | | | | ±0.5pF | GJM0222C1E6R6DB01# | p157 |
| | | | 6.7pF | ±0.05pF | GJM0222C1E6R7WB01# | p157 |
| | | | | ±0.1pF | GJM0222C1E6R7BB01# | p157 |
| | | | | ±0.25pF | GJM0222C1E6R7CB01# | p157 |
| | | | | ±0.5pF | GJM0222C1E6R7DB01# | p157 |
| | | | 6.8pF | ±0.05pF | GJM0222C1E6R8WB01# | p157 |
| | | | | ±0.1pF | GJM0222C1E6R8BB01# | p157 |
| | | | | ±0.25pF | GJM0222C1E6R8CB01# | p157 |
| | | | | ±0.5pF | GJM0222C1E6R8DB01# | p157 |
| | | | 6.9pF | ±0.05pF | GJM0222C1E6R9WB01# | p157 |
| | | | | ±0.1pF | GJM0222C1E6R9BB01# | p157 |
| | | | | ±0.25pF | GJM0222C1E6R9CB01# | p157 |
| | | | | ±0.5pF | GJM0222C1E6R9DB01# | p157 |
| | | | 7.0pF | ±0.05pF | GJM0222C1E7R0WB01# | p157 |
| | | | | ±0.1pF | GJM0222C1E7R0BB01# | p157 |
| | | | | ±0.25pF | GJM0222C1E7R0CB01# | p157 |
| | | | | ±0.5pF | GJM0222C1E7R0DB01# | p157 |
| | | | 7.1pF | ±0.05pF | GJM0222C1E7R1WB01# | p157 |
| | | | | ±0.1pF | GJM0222C1E7R1BB01# | p157 |
| | | | | ±0.25pF | GJM0222C1E7R1CB01# | p157 |
| | | | | ±0.5pF | GJM0222C1E7R1DB01# | p157 |
| | | | 7.2pF | ±0.05pF | GJM0222C1E7R2WB01# | p157 |
| | | | | ±0.1pF | GJM0222C1E7R2BB01# | p157 |
| | | | | ±0.25pF | GJM0222C1E7R2CB01# | p157 |
| | | | | ±0.5pF | GJM0222C1E7R2DB01# | p157 |
| | | | 7.3pF | ±0.05pF | GJM0222C1E7R3WB01# | p157 |
| | | | | ±0.1pF | GJM0222C1E7R3BB01# | p157 |
| | | | | ±0.25pF | GJM0222C1E7R3CB01# | p157 |
| | | | | ±0.5pF | GJM0222C1E7R3DB01# | p157 |
| | | | 7.4pF | ±0.05pF | GJM0222C1E7R4WB01# | p157 |
| | | | | ±0.1pF | GJM0222C1E7R4BB01# | p157 |
| | | | | ±0.25pF | GJM0222C1E7R4CB01# | p157 |
| | | | | ±0.5pF | GJM0222C1E7R4DB01# | p157 |
| | | | 7.5pF | ±0.05pF | GJM0222C1E7R5WB01# | p157 |
| | | | | ±0.1pF | GJM0222C1E7R5BB01# | p157 |
| | | | | ±0.25pF | GJM0222C1E7R5CB01# | p157 |
| | | | | ±0.5pF | GJM0222C1E7R5DB01# | p157 |

| T max. | Rated Voltage | TC Code | Cap. | Tol. | Part Number | p* |
|--------|---------------|---------|-------|---------|--------------------|------|
| 0.22mm | 25Vdc | CH | 7.6pF | ±0.05pF | GJM0222C1E7R6WB01# | p157 |
| | | | | ±0.1pF | GJM0222C1E7R6BB01# | p157 |
| | | | | ±0.25pF | GJM0222C1E7R6CB01# | p157 |
| | | | | ±0.5pF | GJM0222C1E7R6DB01# | p157 |
| | | | 7.7pF | ±0.05pF | GJM0222C1E7R7WB01# | p157 |
| | | | | ±0.1pF | GJM0222C1E7R7BB01# | p157 |
| | | | | ±0.25pF | GJM0222C1E7R7CB01# | p157 |
| | | | 7.8pF | ±0.05pF | GJM0222C1E7R8WB01# | p157 |
| | | | | ±0.1pF | GJM0222C1E7R8BB01# | p157 |
| | | | | ±0.25pF | GJM0222C1E7R8CB01# | p157 |
| | | | 7.9pF | ±0.05pF | GJM0222C1E7R9WB01# | p157 |
| | | | | ±0.1pF | GJM0222C1E7R9BB01# | p157 |
| | | | | ±0.25pF | GJM0222C1E7R9CB01# | p157 |
| | | | 8.0pF | ±0.05pF | GJM0222C1E8R0WB01# | p157 |
| | | | | ±0.1pF | GJM0222C1E8R0BB01# | p157 |
| | | | | ±0.25pF | GJM0222C1E8R0CB01# | p157 |
| | | | 8.1pF | ±0.05pF | GJM0222C1E8R1WB01# | p157 |
| | | | | ±0.1pF | GJM0222C1E8R1BB01# | p157 |
| | | | | ±0.25pF | GJM0222C1E8R1CB01# | p157 |
| | | | 8.2pF | ±0.05pF | GJM0222C1E8R2WB01# | p157 |
| | | | | ±0.1pF | GJM0222C1E8R2BB01# | p157 |
| | | | | ±0.25pF | GJM0222C1E8R2CB01# | p157 |
| | | | 8.3pF | ±0.05pF | GJM0222C1E8R3WB01# | p157 |
| | | | | ±0.1pF | GJM0222C1E8R3BB01# | p157 |
| | | | | ±0.25pF | GJM0222C1E8R3CB01# | p157 |
| | | | 8.4pF | ±0.05pF | GJM0222C1E8R4WB01# | p157 |
| | | | | ±0.1pF | GJM0222C1E8R4BB01# | p157 |
| | | | | ±0.25pF | GJM0222C1E8R4CB01# | p157 |
| | | | 8.5pF | ±0.05pF | GJM0222C1E8R5WB01# | p157 |
| | | | | ±0.1pF | GJM0222C1E8R5BB01# | p157 |
| | | | | ±0.25pF | GJM0222C1E8R5CB01# | p157 |
| | | | 8.6pF | ±0.05pF | GJM0222C1E8R6WB01# | p157 |
| | | | | ±0.1pF | GJM0222C1E8R6BB01# | p157 |
| | | | | ±0.25pF | GJM0222C1E8R6CB01# | p157 |
| | | | 8.7pF | ±0.05pF | GJM0222C1E8R7WB01# | p157 |
| | | | | ±0.1pF | GJM0222C1E8R7BB01# | p157 |
| | | | | ±0.25pF | GJM0222C1E8R7CB01# | p157 |
| | | | 8.8pF | ±0.05pF | GJM0222C1E8R8WB01# | p157 |
| | | | | ±0.1pF | GJM0222C1E8R8BB01# | p157 |
| | | | | ±0.25pF | GJM0222C1E8R8CB01# | p157 |
| | | | 8.9pF | ±0.05pF | GJM0222C1E8R9WB01# | p157 |
| | | | | ±0.1pF | GJM0222C1E8R9BB01# | p157 |

*: Refers to the page of the "Specifications and Test Methods".

Part number # indicates the package specification code.



GJM Series Temperature Compensating Type Part Number List

(→ 0.4×0.2mm)

| T max. | Rated Voltage | TC Code | Cap. | Tol. | Part Number | p* |
|--------|---------------|---------|-------|---------|--------------------|------|
| 0.22mm | 25Vdc | CH | 8.9pF | ±0.25pF | GJM0222C1E8R9CB01# | p157 |
| | | | | ±0.5pF | GJM0222C1E8R9DB01# | p157 |
| | | | 9.0pF | ±0.05pF | GJM0222C1E9R0WB01# | p157 |
| | | | | ±0.1pF | GJM0222C1E9R0BB01# | p157 |
| | | | | ±0.25pF | GJM0222C1E9R0CB01# | p157 |
| | | | | ±0.5pF | GJM0222C1E9R0DB01# | p157 |
| | | | 9.1pF | ±0.05pF | GJM0222C1E9R1WB01# | p157 |
| | | | | ±0.1pF | GJM0222C1E9R1BB01# | p157 |
| | | | | ±0.25pF | GJM0222C1E9R1CB01# | p157 |
| | | | | ±0.5pF | GJM0222C1E9R1DB01# | p157 |
| | | | 9.2pF | ±0.05pF | GJM0222C1E9R2WB01# | p157 |
| | | | | ±0.1pF | GJM0222C1E9R2BB01# | p157 |
| | | | | ±0.25pF | GJM0222C1E9R2CB01# | p157 |
| | | | | ±0.5pF | GJM0222C1E9R2DB01# | p157 |
| | | | 9.3pF | ±0.05pF | GJM0222C1E9R3WB01# | p157 |
| | | | | ±0.1pF | GJM0222C1E9R3BB01# | p157 |
| | | | | ±0.25pF | GJM0222C1E9R3CB01# | p157 |
| | | | | ±0.5pF | GJM0222C1E9R3DB01# | p157 |
| | | | 9.4pF | ±0.05pF | GJM0222C1E9R4WB01# | p157 |
| | | | | ±0.1pF | GJM0222C1E9R4BB01# | p157 |
| | | | | ±0.25pF | GJM0222C1E9R4CB01# | p157 |
| | | | | ±0.5pF | GJM0222C1E9R4DB01# | p157 |
| | | | 9.5pF | ±0.05pF | GJM0222C1E9R5WB01# | p157 |
| | | | | ±0.1pF | GJM0222C1E9R5BB01# | p157 |
| | | | | ±0.25pF | GJM0222C1E9R5CB01# | p157 |
| | | | | ±0.5pF | GJM0222C1E9R5DB01# | p157 |
| | | | 9.6pF | ±0.05pF | GJM0222C1E9R6WB01# | p157 |
| | | | | ±0.1pF | GJM0222C1E9R6BB01# | p157 |
| | | | | ±0.25pF | GJM0222C1E9R6CB01# | p157 |
| | | | | ±0.5pF | GJM0222C1E9R6DB01# | p157 |
| | | | 9.7pF | ±0.05pF | GJM0222C1E9R7WB01# | p157 |
| | | | | ±0.1pF | GJM0222C1E9R7BB01# | p157 |
| | | | | ±0.25pF | GJM0222C1E9R7CB01# | p157 |
| | | | | ±0.5pF | GJM0222C1E9R7DB01# | p157 |
| | | | 9.8pF | ±0.05pF | GJM0222C1E9R8WB01# | p157 |
| | | | | ±0.1pF | GJM0222C1E9R8BB01# | p157 |
| | | | | ±0.25pF | GJM0222C1E9R8CB01# | p157 |
| | | | | ±0.5pF | GJM0222C1E9R8DB01# | p157 |
| | | | 9.9pF | ±0.05pF | GJM0222C1E9R9WB01# | p157 |
| | | | | ±0.1pF | GJM0222C1E9R9BB01# | p157 |
| | | | | ±0.25pF | GJM0222C1E9R9CB01# | p157 |
| | | | | ±0.5pF | GJM0222C1E9R9DB01# | p157 |
| | | | 10pF | ±2% | GJM0222C1E100GB01# | p157 |
| | | | | ±5% | GJM0222C1E100JB01# | p157 |
| | | | 11pF | ±2% | GJM0222C1E110GB01# | p157 |
| | | | | ±5% | GJM0222C1E110JB01# | p157 |
| | | | 12pF | ±2% | GJM0222C1E120GB01# | p157 |
| | | | | ±5% | GJM0222C1E120JB01# | p157 |
| | | | 13pF | ±2% | GJM0222C1E130GB01# | p157 |
| | | | | ±5% | GJM0222C1E130JB01# | p157 |
| | | | 15pF | ±2% | GJM0222C1E150GB01# | p157 |
| | | | | ±5% | GJM0222C1E150JB01# | p157 |
| | | | 16pF | ±2% | GJM0222C1E160GB01# | p157 |
| | | | | ±5% | GJM0222C1E160JB01# | p157 |

| T max. | Rated Voltage | TC Code | Cap. | Tol. | Part Number | p* |
|--------|---------------|---------|------|------|--------------------|------|
| 0.22mm | 25Vdc | CH | 18pF | ±2% | GJM0222C1E180GB01# | p157 |
| | | | | ±5% | GJM0222C1E180JB01# | p157 |
| | | | 20pF | ±2% | GJM0222C1E200GB01# | p157 |
| | | | | ±5% | GJM0222C1E200JB01# | p157 |
| | | | 22pF | ±2% | GJM0222C1E220GB01# | p157 |
| | | | | ±5% | GJM0222C1E220JB01# | p157 |

0.6×0.3mm

| T max. | Rated Voltage | TC Code | Cap. | Tol. | Part Number | p* | | | |
|--------|---------------|---------|--------|---------|--------------------|--------------------|---------|--------------------|------|
| 0.33mm | 50Vdc | COG | 0.20pF | ±0.05pF | GJM0335C1HR20WB01# | p160 | | | |
| | | | | ±0.1pF | GJM0335C1HR20BB01# | p160 | | | |
| | | | 0.30pF | ±0.05pF | GJM0335C1HR30WB01# | p160 | | | |
| | | | | ±0.1pF | GJM0335C1HR30BB01# | p160 | | | |
| | | | 0.40pF | ±0.05pF | GJM0335C1HR40WB01# | p160 | | | |
| | | | | ±0.1pF | GJM0335C1HR40BB01# | p160 | | | |
| | | | 0.50pF | ±0.05pF | GJM0335C1HR50WB01# | p160 | | | |
| | | | | ±0.1pF | GJM0335C1HR50BB01# | p160 | | | |
| | | | 0.60pF | ±0.05pF | GJM0335C1HR60WB01# | p160 | | | |
| | | | | ±0.1pF | GJM0335C1HR60BB01# | p160 | | | |
| | | | 0.70pF | ±0.05pF | GJM0335C1HR70WB01# | p160 | | | |
| | | | | ±0.1pF | GJM0335C1HR70BB01# | p160 | | | |
| | | | 0.80pF | ±0.05pF | GJM0335C1HR80WB01# | p160 | | | |
| | | | | ±0.1pF | GJM0335C1HR80BB01# | p160 | | | |
| | | | 0.90pF | ±0.05pF | GJM0335C1HR90WB01# | p160 | | | |
| | | | | ±0.1pF | GJM0335C1HR90BB01# | p160 | | | |
| | | | CK | 0.20pF | ±0.05pF | GJM0334C1HR20WB01# | p160 | | |
| | | | | | ±0.05pF | GJM0334C1HR30WB01# | p160 | | |
| | | | | | ±0.05pF | GJM0334C1HR40WB01# | p160 | | |
| | | | | | ±0.05pF | GJM0334C1HR50WB01# | p160 | | |
| | | | | | ±0.05pF | GJM0334C1HR60WB01# | p160 | | |
| | | | | | ±0.05pF | GJM0334C1HR70WB01# | p160 | | |
| | | | | | ±0.05pF | GJM0334C1HR80WB01# | p160 | | |
| | | | | | ±0.05pF | GJM0334C1HR90WB01# | p160 | | |
| | | | | | ±0.1pF | GJM0334C1H1R0BB01# | p160 | | |
| | | | | | ±0.1pF | GJM0334C1H1R1BB01# | p160 | | |
| | | | CJ | 2.2pF | ±0.1pF | GJM0333C1H2R2BB01# | p160 | | |
| | | | | | ±0.1pF | GJM0333C1H2R4BB01# | p160 | | |
| | | | | | ±0.1pF | GJM0333C1H2R7BB01# | p160 | | |
| | | | | | ±0.1pF | GJM0333C1H3R0BB01# | p160 | | |
| | | | | | ±0.1pF | GJM0333C1H3R3BB01# | p160 | | |
| | | | | | ±0.1pF | GJM0333C1H3R6BB01# | p160 | | |
| | | | | | ±0.1pF | GJM0333C1H3R9BB01# | p160 | | |
| | | | | | CH | 0.20pF | ±0.05pF | GJM0332C1HR20WB01# | p160 |
| | | | | | | | ±0.1pF | GJM0332C1HR20BB01# | p160 |
| | | | | | | | ±0.05pF | GJM0332C1HR30WB01# | p160 |
| | | | 0.30pF | ±0.05pF | GJM0332C1HR30BB01# | p160 | | | |
| | | | | ±0.1pF | GJM0332C1HR30BB01# | p160 | | | |

*: Refers to the page of the "Specifications and Test Methods".

Part number # indicates the package specification code.



GJM Series Temperature Compensating Type Part Number List

(→ 0.6×0.3mm)

| T max. | Rated Voltage | TC Code | Cap. | Tol. | Part Number | p* | | |
|--------|---------------|--------------------|--------|---------|--------------------|---------|--------------------|------|
| 0.33mm | 50Vdc | CH | 0.40pF | ±0.05pF | GJM0332C1HR40WB01# | p160 | | |
| | | | | ±0.1pF | GJM0332C1HR40BB01# | p160 | | |
| | | | 0.50pF | ±0.05pF | GJM0332C1HR50WB01# | p160 | | |
| | | | | ±0.1pF | GJM0332C1HR50BB01# | p160 | | |
| | | | 0.60pF | ±0.05pF | GJM0332C1HR60WB01# | p160 | | |
| | | | | ±0.1pF | GJM0332C1HR60BB01# | p160 | | |
| | | | 0.70pF | ±0.05pF | GJM0332C1HR70WB01# | p160 | | |
| | | | | ±0.1pF | GJM0332C1HR70BB01# | p160 | | |
| | | | 0.80pF | ±0.05pF | GJM0332C1HR80WB01# | p160 | | |
| | | | | ±0.1pF | GJM0332C1HR80BB01# | p160 | | |
| | | | 0.90pF | ±0.05pF | GJM0332C1HR90WB01# | p160 | | |
| | | | | ±0.1pF | GJM0332C1HR90BB01# | p160 | | |
| | | | 25Vdc | COG | 1.0pF | ±0.05pF | GJM0335C1E1R0WB01# | p157 |
| | | | | | | ±0.1pF | GJM0335C1E1R0BB01# | p157 |
| | | | | | | ±0.25pF | GJM0335C1E1R0CB01# | p157 |
| | | | | | 1.1pF | ±0.05pF | GJM0335C1E1R1WB01# | p157 |
| | | | | | | ±0.1pF | GJM0335C1E1R1BB01# | p157 |
| | | | | | | ±0.25pF | GJM0335C1E1R1CB01# | p157 |
| | 1.2pF | ±0.05pF | | | GJM0335C1E1R2WB01# | p157 | | |
| | | ±0.1pF | | | GJM0335C1E1R2BB01# | p157 | | |
| | | ±0.25pF | | | GJM0335C1E1R2CB01# | p157 | | |
| | 1.3pF | ±0.05pF | | | GJM0335C1E1R3WB01# | p157 | | |
| | | ±0.1pF | | | GJM0335C1E1R3BB01# | p157 | | |
| | | ±0.25pF | | | GJM0335C1E1R3CB01# | p157 | | |
| | 1.4pF | ±0.05pF | | | GJM0335C1E1R4WB01# | p157 | | |
| | | ±0.1pF | | | GJM0335C1E1R4BB01# | p157 | | |
| | | ±0.25pF | | | GJM0335C1E1R4CB01# | p157 | | |
| | 1.5pF | ±0.05pF | | | GJM0335C1E1R5WB01# | p157 | | |
| | | ±0.1pF | | | GJM0335C1E1R5BB01# | p157 | | |
| | | ±0.25pF | | | GJM0335C1E1R5CB01# | p157 | | |
| | 1.6pF | ±0.05pF | | | GJM0335C1E1R6WB01# | p157 | | |
| | | ±0.1pF | | | GJM0335C1E1R6BB01# | p157 | | |
| | | ±0.25pF | | | GJM0335C1E1R6CB01# | p157 | | |
| | 1.7pF | ±0.05pF | | | GJM0335C1E1R7WB01# | p157 | | |
| | | ±0.1pF | | | GJM0335C1E1R7BB01# | p157 | | |
| | | ±0.25pF | | | GJM0335C1E1R7CB01# | p157 | | |
| 1.8pF | ±0.05pF | GJM0335C1E1R8WB01# | | | p157 | | | |
| | ±0.1pF | GJM0335C1E1R8BB01# | | | p157 | | | |
| | ±0.25pF | GJM0335C1E1R8CB01# | | | p157 | | | |
| 1.9pF | ±0.05pF | GJM0335C1E1R9WB01# | | | p157 | | | |
| | ±0.1pF | GJM0335C1E1R9BB01# | | | p157 | | | |
| | ±0.25pF | GJM0335C1E1R9CB01# | | | p157 | | | |
| 2.0pF | ±0.05pF | GJM0335C1E2R0WB01# | | | p157 | | | |
| | ±0.1pF | GJM0335C1E2R0BB01# | | | p157 | | | |
| | ±0.25pF | GJM0335C1E2R0CB01# | | | p157 | | | |
| 2.1pF | ±0.05pF | GJM0335C1E2R1WB01# | | | p157 | | | |
| | ±0.1pF | GJM0335C1E2R1BB01# | | | p157 | | | |
| | ±0.25pF | GJM0335C1E2R1CB01# | | | p157 | | | |
| 2.2pF | ±0.05pF | GJM0335C1E2R2WB01# | p157 | | | | | |
| | ±0.1pF | GJM0335C1E2R2BB01# | p157 | | | | | |
| | ±0.25pF | GJM0335C1E2R2CB01# | p157 | | | | | |
| 2.3pF | ±0.05pF | GJM0335C1E2R3WB01# | p157 | | | | | |
| | ±0.1pF | GJM0335C1E2R3BB01# | p157 | | | | | |
| | ±0.25pF | GJM0335C1E2R3CB01# | p157 | | | | | |

| T max. | Rated Voltage | TC Code | Cap. | Tol. | Part Number | p* |
|--------|---------------|--------------------|-------|---------|--------------------|------|
| 0.33mm | 25Vdc | COG | 2.4pF | ±0.05pF | GJM0335C1E2R4WB01# | p157 |
| | | | | ±0.1pF | GJM0335C1E2R4BB01# | p157 |
| | | | | ±0.25pF | GJM0335C1E2R4CB01# | p157 |
| | | | 2.5pF | ±0.05pF | GJM0335C1E2R5WB01# | p157 |
| | | | | ±0.1pF | GJM0335C1E2R5BB01# | p157 |
| | | | | ±0.25pF | GJM0335C1E2R5CB01# | p157 |
| | | | 2.6pF | ±0.05pF | GJM0335C1E2R6WB01# | p157 |
| | | | | ±0.1pF | GJM0335C1E2R6BB01# | p157 |
| | | | | ±0.25pF | GJM0335C1E2R6CB01# | p157 |
| | | | 2.7pF | ±0.05pF | GJM0335C1E2R7WB01# | p157 |
| | | | | ±0.1pF | GJM0335C1E2R7BB01# | p157 |
| | | | | ±0.25pF | GJM0335C1E2R7CB01# | p157 |
| | | | 2.8pF | ±0.05pF | GJM0335C1E2R8WB01# | p157 |
| | | | | ±0.1pF | GJM0335C1E2R8BB01# | p157 |
| | | | | ±0.25pF | GJM0335C1E2R8CB01# | p157 |
| | | | 2.9pF | ±0.05pF | GJM0335C1E2R9WB01# | p157 |
| | | | | ±0.1pF | GJM0335C1E2R9BB01# | p157 |
| | | | | ±0.25pF | GJM0335C1E2R9CB01# | p157 |
| | | | 3.0pF | ±0.05pF | GJM0335C1E3R0WB01# | p157 |
| | | | | ±0.1pF | GJM0335C1E3R0BB01# | p157 |
| | | | | ±0.25pF | GJM0335C1E3R0CB01# | p157 |
| | | | 3.1pF | ±0.05pF | GJM0335C1E3R1WB01# | p157 |
| | | | | ±0.1pF | GJM0335C1E3R1BB01# | p157 |
| | | | | ±0.25pF | GJM0335C1E3R1CB01# | p157 |
| | | | 3.2pF | ±0.05pF | GJM0335C1E3R2WB01# | p157 |
| | | | | ±0.1pF | GJM0335C1E3R2BB01# | p157 |
| | | | | ±0.25pF | GJM0335C1E3R2CB01# | p157 |
| | | | 3.3pF | ±0.05pF | GJM0335C1E3R3WB01# | p157 |
| | | | | ±0.1pF | GJM0335C1E3R3BB01# | p157 |
| | | | | ±0.25pF | GJM0335C1E3R3CB01# | p157 |
| | | | 3.4pF | ±0.05pF | GJM0335C1E3R4WB01# | p157 |
| | | | | ±0.1pF | GJM0335C1E3R4BB01# | p157 |
| | | | | ±0.25pF | GJM0335C1E3R4CB01# | p157 |
| | | | 3.5pF | ±0.05pF | GJM0335C1E3R5WB01# | p157 |
| | | | | ±0.1pF | GJM0335C1E3R5BB01# | p157 |
| | | | | ±0.25pF | GJM0335C1E3R5CB01# | p157 |
| | | | 3.6pF | ±0.05pF | GJM0335C1E3R6WB01# | p157 |
| | | | | ±0.1pF | GJM0335C1E3R6BB01# | p157 |
| | | | | ±0.25pF | GJM0335C1E3R6CB01# | p157 |
| | | | 3.7pF | ±0.05pF | GJM0335C1E3R7WB01# | p157 |
| | | | | ±0.1pF | GJM0335C1E3R7BB01# | p157 |
| | | | | ±0.25pF | GJM0335C1E3R7CB01# | p157 |
| | | | 3.8pF | ±0.05pF | GJM0335C1E3R8WB01# | p157 |
| | | | | ±0.1pF | GJM0335C1E3R8BB01# | p157 |
| | | | | ±0.25pF | GJM0335C1E3R8CB01# | p157 |
| | | | 3.9pF | ±0.05pF | GJM0335C1E3R9WB01# | p157 |
| | | | | ±0.1pF | GJM0335C1E3R9BB01# | p157 |
| | | | | ±0.25pF | GJM0335C1E3R9CB01# | p157 |
| 4.0pF | ±0.05pF | GJM0335C1E4R0WB01# | p157 | | | |
| | ±0.1pF | GJM0335C1E4R0BB01# | p157 | | | |
| | ±0.25pF | GJM0335C1E4R0CB01# | p157 | | | |
| 4.1pF | ±0.05pF | GJM0335C1E4R1WB01# | p157 | | | |
| | ±0.1pF | GJM0335C1E4R1BB01# | p157 | | | |
| | ±0.25pF | GJM0335C1E4R1CB01# | p157 | | | |

*: Refers to the page of the "Specifications and Test Methods".

Part number # indicates the package specification code.

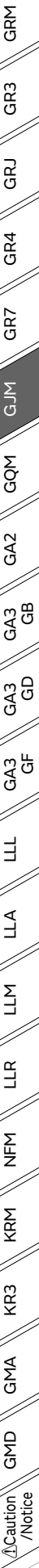

GJM Series Temperature Compensating Type Part Number List

(→ 0.6×0.3mm)

| T max. | Rated Voltage | TC Code | Cap. | Tol. | Part Number | p* |
|--------|---------------|---------|-------|---------|--------------------|------|
| 0.33mm | 25Vdc | COG | 4.2pF | ±0.05pF | GJM0335C1E4R2WB01# | p157 |
| | | | | ±0.1pF | GJM0335C1E4R2BB01# | p157 |
| | | | | ±0.25pF | GJM0335C1E4R2CB01# | p157 |
| | | | 4.3pF | ±0.05pF | GJM0335C1E4R3WB01# | p157 |
| | | | | ±0.1pF | GJM0335C1E4R3BB01# | p157 |
| | | | | ±0.25pF | GJM0335C1E4R3CB01# | p157 |
| | | | 4.4pF | ±0.05pF | GJM0335C1E4R4WB01# | p157 |
| | | | | ±0.1pF | GJM0335C1E4R4BB01# | p157 |
| | | | | ±0.25pF | GJM0335C1E4R4CB01# | p157 |
| | | | 4.5pF | ±0.05pF | GJM0335C1E4R5WB01# | p157 |
| | | | | ±0.1pF | GJM0335C1E4R5BB01# | p157 |
| | | | | ±0.25pF | GJM0335C1E4R5CB01# | p157 |
| | | | 4.6pF | ±0.05pF | GJM0335C1E4R6WB01# | p157 |
| | | | | ±0.1pF | GJM0335C1E4R6BB01# | p157 |
| | | | | ±0.25pF | GJM0335C1E4R6CB01# | p157 |
| | | | 4.7pF | ±0.05pF | GJM0335C1E4R7WB01# | p157 |
| | | | | ±0.1pF | GJM0335C1E4R7BB01# | p157 |
| | | | | ±0.25pF | GJM0335C1E4R7CB01# | p157 |
| | | | 4.8pF | ±0.05pF | GJM0335C1E4R8WB01# | p157 |
| | | | | ±0.1pF | GJM0335C1E4R8BB01# | p157 |
| | | | | ±0.25pF | GJM0335C1E4R8CB01# | p157 |
| | | | 4.9pF | ±0.05pF | GJM0335C1E4R9WB01# | p157 |
| | | | | ±0.1pF | GJM0335C1E4R9BB01# | p157 |
| | | | | ±0.25pF | GJM0335C1E4R9CB01# | p157 |
| | | | 5.0pF | ±0.05pF | GJM0335C1E5R0WB01# | p157 |
| | | | | ±0.1pF | GJM0335C1E5R0BB01# | p157 |
| | | | | ±0.25pF | GJM0335C1E5R0CB01# | p157 |
| | | | 5.1pF | ±0.05pF | GJM0335C1E5R1WB01# | p157 |
| | | | | ±0.1pF | GJM0335C1E5R1BB01# | p157 |
| | | | | ±0.25pF | GJM0335C1E5R1CB01# | p157 |
| | | | 5.2pF | ±0.05pF | GJM0335C1E5R2WB01# | p157 |
| | | | | ±0.1pF | GJM0335C1E5R2BB01# | p157 |
| | | | | ±0.25pF | GJM0335C1E5R2CB01# | p157 |
| | | | 5.3pF | ±0.05pF | GJM0335C1E5R3WB01# | p157 |
| | | | | ±0.1pF | GJM0335C1E5R3BB01# | p157 |
| | | | | ±0.25pF | GJM0335C1E5R3CB01# | p157 |
| | | | 5.4pF | ±0.05pF | GJM0335C1E5R4WB01# | p157 |
| | | | | ±0.1pF | GJM0335C1E5R4BB01# | p157 |
| | | | | ±0.25pF | GJM0335C1E5R4CB01# | p157 |
| | | | 5.5pF | ±0.05pF | GJM0335C1E5R5WB01# | p157 |
| | | | | ±0.1pF | GJM0335C1E5R5BB01# | p157 |
| | | | | ±0.25pF | GJM0335C1E5R5CB01# | p157 |
| | | | 5.6pF | ±0.05pF | GJM0335C1E5R6WB01# | p157 |
| | | | | ±0.1pF | GJM0335C1E5R6BB01# | p157 |
| | | | | ±0.25pF | GJM0335C1E5R6CB01# | p157 |
| | | | 5.7pF | ±0.05pF | GJM0335C1E5R7WB01# | p157 |
| | | | | ±0.1pF | GJM0335C1E5R7BB01# | p157 |
| | | | | ±0.25pF | GJM0335C1E5R7CB01# | p157 |

| T max. | Rated Voltage | TC Code | Cap. | Tol. | Part Number | p* |
|--------|---------------|---------|-------|---------|--------------------|------|
| 0.33mm | 25Vdc | COG | 5.7pF | ±0.5pF | GJM0335C1E5R7DB01# | p157 |
| | | | | ±0.05pF | GJM0335C1E5R8WB01# | p157 |
| | | | | ±0.1pF | GJM0335C1E5R8BB01# | p157 |
| | | | 5.8pF | ±0.05pF | GJM0335C1E5R8WB01# | p157 |
| | | | | ±0.1pF | GJM0335C1E5R8BB01# | p157 |
| | | | | ±0.25pF | GJM0335C1E5R8CB01# | p157 |
| | | | 5.9pF | ±0.05pF | GJM0335C1E5R9WB01# | p157 |
| | | | | ±0.1pF | GJM0335C1E5R9BB01# | p157 |
| | | | | ±0.25pF | GJM0335C1E5R9CB01# | p157 |
| | | | 6.0pF | ±0.05pF | GJM0335C1E6R0WB01# | p157 |
| | | | | ±0.1pF | GJM0335C1E6R0BB01# | p157 |
| | | | | ±0.25pF | GJM0335C1E6R0CB01# | p157 |
| | | | 6.1pF | ±0.05pF | GJM0335C1E6R1WB01# | p157 |
| | | | | ±0.1pF | GJM0335C1E6R1BB01# | p157 |
| | | | | ±0.25pF | GJM0335C1E6R1CB01# | p157 |
| | | | 6.2pF | ±0.05pF | GJM0335C1E6R2WB01# | p157 |
| | | | | ±0.1pF | GJM0335C1E6R2BB01# | p157 |
| | | | | ±0.25pF | GJM0335C1E6R2CB01# | p157 |
| | | | 6.3pF | ±0.05pF | GJM0335C1E6R3WB01# | p157 |
| | | | | ±0.1pF | GJM0335C1E6R3BB01# | p157 |
| | | | | ±0.25pF | GJM0335C1E6R3CB01# | p157 |
| | | | 6.4pF | ±0.05pF | GJM0335C1E6R4WB01# | p157 |
| | | | | ±0.1pF | GJM0335C1E6R4BB01# | p157 |
| | | | | ±0.25pF | GJM0335C1E6R4CB01# | p157 |
| | | | 6.5pF | ±0.05pF | GJM0335C1E6R5WB01# | p157 |
| | | | | ±0.1pF | GJM0335C1E6R5BB01# | p157 |
| | | | | ±0.25pF | GJM0335C1E6R5CB01# | p157 |
| | | | 6.6pF | ±0.05pF | GJM0335C1E6R6WB01# | p157 |
| | | | | ±0.1pF | GJM0335C1E6R6BB01# | p157 |
| | | | | ±0.25pF | GJM0335C1E6R6CB01# | p157 |
| | | | 6.7pF | ±0.05pF | GJM0335C1E6R7WB01# | p157 |
| | | | | ±0.1pF | GJM0335C1E6R7BB01# | p157 |
| | | | | ±0.25pF | GJM0335C1E6R7CB01# | p157 |
| | | | 6.8pF | ±0.05pF | GJM0335C1E6R8WB01# | p157 |
| | | | | ±0.1pF | GJM0335C1E6R8BB01# | p157 |
| | | | | ±0.25pF | GJM0335C1E6R8CB01# | p157 |
| | | | 6.9pF | ±0.05pF | GJM0335C1E6R9WB01# | p157 |
| | | | | ±0.1pF | GJM0335C1E6R9BB01# | p157 |
| | | | | ±0.25pF | GJM0335C1E6R9CB01# | p157 |
| | | | 7.0pF | ±0.05pF | GJM0335C1E7R0WB01# | p157 |
| | | | | ±0.1pF | GJM0335C1E7R0BB01# | p157 |
| | | | | ±0.25pF | GJM0335C1E7R0CB01# | p157 |
| | | | 7.1pF | ±0.05pF | GJM0335C1E7R1WB01# | p157 |
| | | | | ±0.1pF | GJM0335C1E7R1BB01# | p157 |
| | | | | ±0.25pF | GJM0335C1E7R1CB01# | p157 |

*: Refers to the page of the "Specifications and Test Methods".

Part number # indicates the package specification code.



GJM Series Temperature Compensating Type Part Number List

(→ 0.6×0.3mm)

| T max. | Rated Voltage | TC Code | Cap. | Tol. | Part Number | p* |
|--------|---------------|---------|-------|---------|--------------------|------|
| 0.33mm | 25Vdc | COG | 7.1pF | ±0.1pF | GJM0335C1E7R1BB01# | p157 |
| | | | | ±0.25pF | GJM0335C1E7R1CB01# | p157 |
| | | | | ±0.5pF | GJM0335C1E7R1DB01# | p157 |
| | | | 7.2pF | ±0.05pF | GJM0335C1E7R2WB01# | p157 |
| | | | | ±0.1pF | GJM0335C1E7R2BB01# | p157 |
| | | | | ±0.25pF | GJM0335C1E7R2CB01# | p157 |
| | | | 7.3pF | ±0.05pF | GJM0335C1E7R3WB01# | p157 |
| | | | | ±0.1pF | GJM0335C1E7R3BB01# | p157 |
| | | | | ±0.25pF | GJM0335C1E7R3CB01# | p157 |
| | | | 7.4pF | ±0.05pF | GJM0335C1E7R4WB01# | p157 |
| | | | | ±0.1pF | GJM0335C1E7R4BB01# | p157 |
| | | | | ±0.25pF | GJM0335C1E7R4CB01# | p157 |
| | | | 7.5pF | ±0.05pF | GJM0335C1E7R5WB01# | p157 |
| | | | | ±0.1pF | GJM0335C1E7R5BB01# | p157 |
| | | | | ±0.25pF | GJM0335C1E7R5CB01# | p157 |
| | | | 7.6pF | ±0.05pF | GJM0335C1E7R6WB01# | p157 |
| | | | | ±0.1pF | GJM0335C1E7R6BB01# | p157 |
| | | | | ±0.25pF | GJM0335C1E7R6CB01# | p157 |
| | | | 7.7pF | ±0.05pF | GJM0335C1E7R7WB01# | p157 |
| | | | | ±0.1pF | GJM0335C1E7R7BB01# | p157 |
| | | | | ±0.25pF | GJM0335C1E7R7CB01# | p157 |
| | | | 7.8pF | ±0.05pF | GJM0335C1E7R8WB01# | p157 |
| | | | | ±0.1pF | GJM0335C1E7R8BB01# | p157 |
| | | | | ±0.25pF | GJM0335C1E7R8CB01# | p157 |
| | | | 7.9pF | ±0.05pF | GJM0335C1E7R9WB01# | p157 |
| | | | | ±0.1pF | GJM0335C1E7R9BB01# | p157 |
| | | | | ±0.25pF | GJM0335C1E7R9CB01# | p157 |
| | | | 8.0pF | ±0.05pF | GJM0335C1E8R0WB01# | p157 |
| | | | | ±0.1pF | GJM0335C1E8R0BB01# | p157 |
| | | | | ±0.25pF | GJM0335C1E8R0CB01# | p157 |
| | | | 8.1pF | ±0.05pF | GJM0335C1E8R1WB01# | p157 |
| | | | | ±0.1pF | GJM0335C1E8R1BB01# | p157 |
| | | | | ±0.25pF | GJM0335C1E8R1CB01# | p157 |
| | | | 8.2pF | ±0.05pF | GJM0335C1E8R2WB01# | p157 |
| | | | | ±0.1pF | GJM0335C1E8R2BB01# | p157 |
| | | | | ±0.25pF | GJM0335C1E8R2CB01# | p157 |
| | | | 8.3pF | ±0.05pF | GJM0335C1E8R3WB01# | p157 |
| | | | | ±0.1pF | GJM0335C1E8R3BB01# | p157 |
| | | | | ±0.25pF | GJM0335C1E8R3CB01# | p157 |
| | | | 8.4pF | ±0.05pF | GJM0335C1E8R4WB01# | p157 |
| | | | | ±0.1pF | GJM0335C1E8R4BB01# | p157 |
| | | | | ±0.25pF | GJM0335C1E8R4CB01# | p157 |

| T max. | Rated Voltage | TC Code | Cap. | Tol. | Part Number | p* |
|--------|---------------|---------|-------|---------|--------------------|------|
| 0.33mm | 25Vdc | COG | 8.4pF | ±0.5pF | GJM0335C1E8R4DB01# | p157 |
| | | | | ±0.05pF | GJM0335C1E8R5WB01# | p157 |
| | | | | ±0.1pF | GJM0335C1E8R5BB01# | p157 |
| | | | 8.5pF | ±0.25pF | GJM0335C1E8R5CB01# | p157 |
| | | | | ±0.5pF | GJM0335C1E8R5DB01# | p157 |
| | | | | ±0.05pF | GJM0335C1E8R6WB01# | p157 |
| | | | 8.6pF | ±0.1pF | GJM0335C1E8R6BB01# | p157 |
| | | | | ±0.25pF | GJM0335C1E8R6CB01# | p157 |
| | | | | ±0.5pF | GJM0335C1E8R6DB01# | p157 |
| | | | 8.7pF | ±0.05pF | GJM0335C1E8R7WB01# | p157 |
| | | | | ±0.1pF | GJM0335C1E8R7BB01# | p157 |
| | | | | ±0.25pF | GJM0335C1E8R7CB01# | p157 |
| | | | 8.8pF | ±0.05pF | GJM0335C1E8R8WB01# | p157 |
| | | | | ±0.1pF | GJM0335C1E8R8BB01# | p157 |
| | | | | ±0.25pF | GJM0335C1E8R8CB01# | p157 |
| | | | 8.9pF | ±0.05pF | GJM0335C1E8R9WB01# | p157 |
| | | | | ±0.1pF | GJM0335C1E8R9BB01# | p157 |
| | | | | ±0.25pF | GJM0335C1E8R9CB01# | p157 |
| | | | 9.0pF | ±0.05pF | GJM0335C1E9R0WB01# | p157 |
| | | | | ±0.1pF | GJM0335C1E9R0BB01# | p157 |
| | | | | ±0.25pF | GJM0335C1E9R0CB01# | p157 |
| | | | 9.1pF | ±0.05pF | GJM0335C1E9R1WB01# | p157 |
| | | | | ±0.1pF | GJM0335C1E9R1BB01# | p157 |
| | | | | ±0.25pF | GJM0335C1E9R1CB01# | p157 |
| | | | 9.2pF | ±0.05pF | GJM0335C1E9R2WB01# | p157 |
| | | | | ±0.1pF | GJM0335C1E9R2BB01# | p157 |
| | | | | ±0.25pF | GJM0335C1E9R2CB01# | p157 |
| | | | 9.3pF | ±0.05pF | GJM0335C1E9R3WB01# | p157 |
| | | | | ±0.1pF | GJM0335C1E9R3BB01# | p157 |
| | | | | ±0.25pF | GJM0335C1E9R3CB01# | p157 |
| | | | 9.4pF | ±0.05pF | GJM0335C1E9R4WB01# | p157 |
| | | | | ±0.1pF | GJM0335C1E9R4BB01# | p157 |
| | | | | ±0.25pF | GJM0335C1E9R4CB01# | p157 |
| | | | 9.5pF | ±0.05pF | GJM0335C1E9R5WB01# | p157 |
| | | | | ±0.1pF | GJM0335C1E9R5BB01# | p157 |
| | | | | ±0.25pF | GJM0335C1E9R5CB01# | p157 |
| | | | 9.6pF | ±0.05pF | GJM0335C1E9R6WB01# | p157 |
| | | | | ±0.1pF | GJM0335C1E9R6BB01# | p157 |
| | | | | ±0.25pF | GJM0335C1E9R6CB01# | p157 |
| | | | 9.7pF | ±0.05pF | GJM0335C1E9R7WB01# | p157 |
| | | | | ±0.1pF | GJM0335C1E9R7BB01# | p157 |
| | | | | ±0.25pF | GJM0335C1E9R7CB01# | p157 |
| | | | 9.8pF | ±0.05pF | GJM0335C1E9R8WB01# | p157 |
| | | | | ±0.5pF | GJM0335C1E9R8DB01# | p157 |

*: Refers to the page of the "Specifications and Test Methods".

Part number # indicates the package specification code.

GJM Series Temperature Compensating Type Part Number List

(→ 0.6×0.3mm)

| T max. | Rated Voltage | TC Code | Cap. | Tol. | Part Number | p* | T max. | Rated Voltage | TC Code | Cap. | Tol. | Part Number | p* |
|--------|---------------|---------|-------|---------|--------------------|------|--------|---------------|---------|-------|---------|--------------------|------|
| 0.33mm | 25Vdc | COG | 9.8pF | ±0.1pF | GJM0335C1E9R8BB01# | p157 | 0.33mm | 25Vdc | CK | 1.7pF | ±0.05pF | GJM0334C1E1R7WB01# | p157 |
| | | | | ±0.25pF | GJM0335C1E9R8CB01# | p157 | | | | | ±0.1pF | GJM0334C1E1R7BB01# | p157 |
| | | | | ±0.5pF | GJM0335C1E9R8DB01# | p157 | | | | | ±0.25pF | GJM0334C1E1R7CB01# | p157 |
| | | | 9.9pF | ±0.05pF | GJM0335C1E9R9WB01# | p157 | | | | 1.8pF | ±0.05pF | GJM0334C1E1R8WB01# | p157 |
| | | | | ±0.1pF | GJM0335C1E9R9BB01# | p157 | | | | | ±0.1pF | GJM0334C1E1R8BB01# | p157 |
| | | | | ±0.25pF | GJM0335C1E9R9CB01# | p157 | | | | | ±0.25pF | GJM0334C1E1R8CB01# | p157 |
| | | | 10pF | ±2% | GJM0335C1E100GB01# | p157 | | | | 1.9pF | ±0.05pF | GJM0334C1E1R9WB01# | p157 |
| | | | | ±5% | GJM0335C1E100JB01# | p157 | | | | | ±0.1pF | GJM0334C1E1R9BB01# | p157 |
| | | | | ±5% | GJM0335C1E110JB01# | p157 | | | | | ±0.25pF | GJM0334C1E1R9CB01# | p157 |
| | | | 11pF | ±2% | GJM0335C1E110GB01# | p157 | | | | 2.0pF | ±0.05pF | GJM0334C1E2R0WB01# | p157 |
| | | | | ±5% | GJM0335C1E110JB01# | p157 | | | | | ±0.1pF | GJM0334C1E2R0BB01# | p157 |
| | | | 12pF | ±2% | GJM0335C1E120GB01# | p157 | | | | 2.1pF | ±0.05pF | GJM0333C1E2R1WB01# | p157 |
| | | | | ±5% | GJM0335C1E120JB01# | p157 | | | | | ±0.1pF | GJM0333C1E2R1BB01# | p157 |
| | | | 13pF | ±2% | GJM0335C1E130GB01# | p157 | | | | 2.2pF | ±0.05pF | GJM0333C1E2R2WB01# | p157 |
| | | | | ±5% | GJM0335C1E130JB01# | p157 | | | | | ±0.1pF | GJM0333C1E2R2BB01# | p157 |
| | | | 15pF | ±2% | GJM0335C1E150GB01# | p157 | | | | 2.3pF | ±0.05pF | GJM0333C1E2R3WB01# | p157 |
| | | | | ±5% | GJM0335C1E150JB01# | p157 | | | | | ±0.1pF | GJM0333C1E2R3BB01# | p157 |
| | | | 16pF | ±2% | GJM0335C1E160GB01# | p157 | | | | 2.4pF | ±0.05pF | GJM0333C1E2R4WB01# | p157 |
| | | | | ±5% | GJM0335C1E160JB01# | p157 | | | | | ±0.1pF | GJM0333C1E2R4BB01# | p157 |
| | | | 18pF | ±2% | GJM0335C1E180GB01# | p157 | | | | 2.5pF | ±0.05pF | GJM0333C1E2R5WB01# | p157 |
| | | | | ±5% | GJM0335C1E180JB01# | p157 | | | | | ±0.1pF | GJM0333C1E2R5BB01# | p157 |
| | | | 20pF | ±2% | GJM0335C1E200GB01# | p157 | | | | 2.6pF | ±0.05pF | GJM0333C1E2R6WB01# | p157 |
| | | | | ±5% | GJM0335C1E200JB01# | p157 | | | | | ±0.1pF | GJM0333C1E2R6BB01# | p157 |
| | | | 22pF | ±2% | GJM0335C1E220GB01# | p157 | | | | 2.7pF | ±0.05pF | GJM0333C1E2R7WB01# | p157 |
| | | | | ±5% | GJM0335C1E220JB01# | p157 | | | | | ±0.1pF | GJM0333C1E2R7BB01# | p157 |
| | | | 24pF | ±2% | GJM0335C1E240GB01# | p157 | | | | 2.8pF | ±0.05pF | GJM0333C1E2R8WB01# | p157 |
| | | | | ±5% | GJM0335C1E240JB01# | p157 | | | | | ±0.1pF | GJM0333C1E2R8BB01# | p157 |
| | | | 27pF | ±2% | GJM0335C1E270GB01# | p157 | | | | 2.9pF | ±0.05pF | GJM0333C1E2R9WB01# | p157 |
| | | | | ±5% | GJM0335C1E270JB01# | p157 | | | | | ±0.1pF | GJM0333C1E2R9BB01# | p157 |
| | | | 30pF | ±2% | GJM0335C1E300GB01# | p157 | | | | 3.0pF | ±0.05pF | GJM0333C1E3R0WB01# | p157 |
| | | | | ±5% | GJM0335C1E300JB01# | p157 | | | | | ±0.1pF | GJM0333C1E3R0BB01# | p157 |
| | | | 33pF | ±2% | GJM0335C1E330GB01# | p157 | | | | 3.1pF | ±0.05pF | GJM0333C1E3R1WB01# | p157 |
| | | | | ±5% | GJM0335C1E330JB01# | p157 | | | | | ±0.1pF | GJM0333C1E3R1BB01# | p157 |
| | | | 1.0pF | ±0.05pF | GJM0334C1E1R0WB01# | p157 | | | | 3.2pF | ±0.05pF | GJM0333C1E3R2WB01# | p157 |
| | | | | ±0.1pF | GJM0334C1E1R0BB01# | p157 | | | | | ±0.1pF | GJM0333C1E3R2BB01# | p157 |
| | | | | ±0.25pF | GJM0334C1E1R0CB01# | p157 | | | | | ±0.25pF | GJM0333C1E3R2CB01# | p157 |
| | | | 1.1pF | ±0.05pF | GJM0334C1E1R1WB01# | p157 | | | | 3.3pF | ±0.05pF | GJM0333C1E3R3WB01# | p157 |
| | | | | ±0.1pF | GJM0334C1E1R1BB01# | p157 | | | | | ±0.1pF | GJM0333C1E3R3BB01# | p157 |
| | | | | ±0.25pF | GJM0334C1E1R1CB01# | p157 | | | | | ±0.25pF | GJM0333C1E3R3CB01# | p157 |
| | | | 1.2pF | ±0.05pF | GJM0334C1E1R2WB01# | p157 | | | | 3.4pF | ±0.05pF | GJM0333C1E3R4WB01# | p157 |
| | | | | ±0.1pF | GJM0334C1E1R2BB01# | p157 | | | | | ±0.1pF | GJM0333C1E3R4BB01# | p157 |
| | | | | ±0.25pF | GJM0334C1E1R2CB01# | p157 | | | | | ±0.25pF | GJM0333C1E3R4CB01# | p157 |
| | | | 1.3pF | ±0.05pF | GJM0334C1E1R3WB01# | p157 | | | | | | | |
| | | | | ±0.1pF | GJM0334C1E1R3BB01# | p157 | | | | | | | |
| | | | | ±0.25pF | GJM0334C1E1R3CB01# | p157 | | | | | | | |
| | | | 1.4pF | ±0.05pF | GJM0334C1E1R4WB01# | p157 | | | | | | | |
| | | | | ±0.1pF | GJM0334C1E1R4BB01# | p157 | | | | | | | |
| | | | | ±0.25pF | GJM0334C1E1R4CB01# | p157 | | | | | | | |
| | | | 1.5pF | ±0.05pF | GJM0334C1E1R5WB01# | p157 | | | | | | | |
| | | | | ±0.1pF | GJM0334C1E1R5BB01# | p157 | | | | | | | |
| | | | | ±0.25pF | GJM0334C1E1R5CB01# | p157 | | | | | | | |
| | | | 1.6pF | ±0.05pF | GJM0334C1E1R6WB01# | p157 | | | | | | | |
| | | | | ±0.1pF | GJM0334C1E1R6BB01# | p157 | | | | | | | |
| | | | | ±0.25pF | GJM0334C1E1R6CB01# | p157 | | | | | | | |

*: Refers to the page of the "Specifications and Test Methods".

Part number # indicates the package specification code.



GJM Series Temperature Compensating Type Part Number List

(→ 0.6×0.3mm)

| T max. | Rated Voltage | TC Code | Cap. | Tol. | Part Number | p* | T max. | Rated Voltage | TC Code | Cap. | Tol. | Part Number | p* | | | |
|--------|---------------|---------|---------|--------------------|--------------------|---------|--------|---------------|---------|--------------------|--------------------|--------------------|--------------------|--------------------|--------------------|------|
| 0.33mm | 25Vdc | CJ | 3.5pF | ±0.05pF | GJM0333C1E3R5WB01# | p157 | 0.33mm | 25Vdc | CH | 5.2pF | ±0.25pF | GJM0332C1E5R2CB01# | p157 | | | |
| | | | | ±0.1pF | GJM0333C1E3R5BB01# | p157 | | | | | ±0.5pF | GJM0332C1E5R2DB01# | p157 | | | |
| | | | | ±0.25pF | GJM0333C1E3R5CB01# | p157 | | | | | 5.3pF | ±0.05pF | GJM0332C1E5R3WB01# | p157 | | |
| | | | 3.6pF | ±0.05pF | GJM0333C1E3R6WB01# | p157 | | | | ±0.1pF | | GJM0332C1E5R3BB01# | p157 | | | |
| | | | | ±0.1pF | GJM0333C1E3R6BB01# | p157 | | | | ±0.25pF | | GJM0332C1E5R3CB01# | p157 | | | |
| | | | | ±0.25pF | GJM0333C1E3R6CB01# | p157 | | | | 5.4pF | ±0.05pF | GJM0332C1E5R4WB01# | p157 | | | |
| | | | 3.7pF | ±0.05pF | GJM0333C1E3R7WB01# | p157 | | | | | ±0.1pF | GJM0332C1E5R4BB01# | p157 | | | |
| | | | | ±0.1pF | GJM0333C1E3R7BB01# | p157 | | | | | ±0.25pF | GJM0332C1E5R4CB01# | p157 | | | |
| | | | | ±0.25pF | GJM0333C1E3R7CB01# | p157 | | | | 5.5pF | ±0.05pF | GJM0332C1E5R4DB01# | p157 | | | |
| | | | 3.8pF | ±0.05pF | GJM0333C1E3R8WB01# | p157 | | | | | ±0.1pF | GJM0332C1E5R5WB01# | p157 | | | |
| | | | | ±0.1pF | GJM0333C1E3R8BB01# | p157 | | | | | ±0.25pF | GJM0332C1E5R5BB01# | p157 | | | |
| | | | | ±0.25pF | GJM0333C1E3R8CB01# | p157 | | | | 5.6pF | ±0.05pF | GJM0332C1E5R5CB01# | p157 | | | |
| | | | 3.9pF | ±0.05pF | GJM0333C1E3R9WB01# | p157 | | | | | ±0.1pF | GJM0332C1E5R5DB01# | p157 | | | |
| | | | | ±0.1pF | GJM0333C1E3R9BB01# | p157 | | | | | ±0.25pF | GJM0332C1E5R5CB01# | p157 | | | |
| | | | | ±0.25pF | GJM0333C1E3R9CB01# | p157 | | | | 5.7pF | ±0.05pF | GJM0332C1E5R6WB01# | p157 | | | |
| | | | 4.0pF | ±0.05pF | GJM0332C1E4R0WB01# | p157 | | | | | ±0.1pF | GJM0332C1E5R6BB01# | p157 | | | |
| | | | | ±0.1pF | GJM0332C1E4R0BB01# | p157 | | | | | ±0.25pF | GJM0332C1E5R6CB01# | p157 | | | |
| | | | | ±0.25pF | GJM0332C1E4R0CB01# | p157 | | | | ±0.5pF | GJM0332C1E5R6DB01# | p157 | | | | |
| | | | 4.1pF | ±0.05pF | GJM0332C1E4R1WB01# | p157 | | | | 5.8pF | ±0.05pF | GJM0332C1E5R7WB01# | p157 | | | |
| | | | | ±0.1pF | GJM0332C1E4R1BB01# | p157 | | | | | ±0.1pF | GJM0332C1E5R7BB01# | p157 | | | |
| | | | | ±0.25pF | GJM0332C1E4R1CB01# | p157 | | | | | ±0.25pF | GJM0332C1E5R7CB01# | p157 | | | |
| | | | 4.2pF | ±0.05pF | GJM0332C1E4R2WB01# | p157 | | | | ±0.5pF | GJM0332C1E5R7DB01# | p157 | 5.9pF | ±0.05pF | GJM0332C1E5R9WB01# | p157 |
| | | | | ±0.1pF | GJM0332C1E4R2BB01# | p157 | | | | ±0.1pF | GJM0332C1E5R9BB01# | p157 | | | | |
| | | | | ±0.25pF | GJM0332C1E4R2CB01# | p157 | | | | ±0.25pF | GJM0332C1E5R9CB01# | p157 | | | | |
| | | | 4.3pF | ±0.05pF | GJM0332C1E4R3WB01# | p157 | | | | 6.0pF | ±0.05pF | GJM0332C1E6R0WB01# | p157 | ±0.5pF | GJM0332C1E5R9DB01# | p157 |
| | | | | ±0.1pF | GJM0332C1E4R3BB01# | p157 | | | | | ±0.1pF | GJM0332C1E6R0BB01# | p157 | | | |
| | | | | ±0.25pF | GJM0332C1E4R3CB01# | p157 | | | | | ±0.25pF | GJM0332C1E6R0CB01# | p157 | | | |
| | | | 4.4pF | ±0.05pF | GJM0332C1E4R4WB01# | p157 | | | | 6.1pF | ±0.05pF | GJM0332C1E6R1WB01# | p157 | ±0.5pF | GJM0332C1E6R0DB01# | p157 |
| | | | | ±0.1pF | GJM0332C1E4R4BB01# | p157 | | | | | ±0.1pF | GJM0332C1E6R1BB01# | p157 | | | |
| | | | | ±0.25pF | GJM0332C1E4R4CB01# | p157 | | | | | ±0.25pF | GJM0332C1E6R1CB01# | p157 | | | |
| | | 4.5pF | ±0.05pF | GJM0332C1E4R5WB01# | p157 | 6.2pF | | | | ±0.05pF | GJM0332C1E6R2WB01# | p157 | ±0.5pF | GJM0332C1E6R1DB01# | p157 | |
| | | | ±0.1pF | GJM0332C1E4R5BB01# | p157 | | | | | ±0.1pF | GJM0332C1E6R2BB01# | p157 | | | | |
| | | | ±0.25pF | GJM0332C1E4R5CB01# | p157 | | | | | ±0.25pF | GJM0332C1E6R2CB01# | p157 | | | | |
| | | 4.6pF | ±0.05pF | GJM0332C1E4R6WB01# | p157 | ±0.5pF | | | | GJM0332C1E6R2DB01# | p157 | 6.3pF | ±0.05pF | GJM0332C1E6R3WB01# | p157 | |
| | | | ±0.1pF | GJM0332C1E4R6BB01# | p157 | ±0.1pF | | | | GJM0332C1E6R3BB01# | p157 | | | | | |
| | | | ±0.25pF | GJM0332C1E4R6CB01# | p157 | ±0.25pF | | | | GJM0332C1E6R3CB01# | p157 | | | | | |
| | | 4.7pF | ±0.05pF | GJM0332C1E4R7WB01# | p157 | 6.4pF | | | | ±0.05pF | GJM0332C1E6R4WB01# | p157 | ±0.5pF | GJM0332C1E6R3DB01# | p157 | |
| | | | ±0.1pF | GJM0332C1E4R7BB01# | p157 | | | | | ±0.1pF | GJM0332C1E6R4BB01# | p157 | | | | |
| | | | ±0.25pF | GJM0332C1E4R7CB01# | p157 | | | | | ±0.25pF | GJM0332C1E6R4CB01# | p157 | | | | |
| | | 4.8pF | ±0.05pF | GJM0332C1E4R8WB01# | p157 | 6.5pF | | | | ±0.05pF | GJM0332C1E6R5WB01# | p157 | ±0.5pF | GJM0332C1E6R4DB01# | p157 | |
| | | | ±0.1pF | GJM0332C1E4R8BB01# | p157 | | | | | ±0.1pF | GJM0332C1E6R5BB01# | p157 | | | | |
| | | | ±0.25pF | GJM0332C1E4R8CB01# | p157 | | | | | ±0.25pF | GJM0332C1E6R5CB01# | p157 | | | | |
| | | 4.9pF | ±0.05pF | GJM0332C1E4R9WB01# | p157 | 5.2pF | | | | ±0.05pF | GJM0332C1E5R2WB01# | p157 | ±0.5pF | GJM0332C1E6R5DB01# | p157 | |
| | | | ±0.1pF | GJM0332C1E4R9BB01# | p157 | | | | | ±0.1pF | GJM0332C1E5R2BB01# | p157 | | | | |
| | | | ±0.25pF | GJM0332C1E4R9CB01# | p157 | | | | | ±0.25pF | GJM0332C1E5R2CB01# | p157 | | | | |
| | | 5.0pF | ±0.05pF | GJM0332C1E5R0WB01# | p157 | 5.1pF | | | | ±0.05pF | GJM0332C1E5R1WB01# | p157 | 5.2pF | ±0.05pF | GJM0332C1E5R2WB01# | p157 |
| | | | ±0.1pF | GJM0332C1E5R0BB01# | p157 | | | | | ±0.1pF | GJM0332C1E5R1BB01# | p157 | | ±0.1pF | GJM0332C1E5R2BB01# | p157 |
| | | | ±0.25pF | GJM0332C1E5R0CB01# | p157 | | | | | ±0.25pF | GJM0332C1E5R1CB01# | p157 | | ±0.25pF | GJM0332C1E5R2CB01# | p157 |
| | | 5.1pF | ±0.05pF | GJM0332C1E5R1WB01# | p157 | 5.2pF | | | | ±0.05pF | GJM0332C1E5R1WB01# | p157 | 5.2pF | ±0.05pF | GJM0332C1E5R2WB01# | p157 |
| | | | ±0.1pF | GJM0332C1E5R1BB01# | p157 | | | | | ±0.1pF | GJM0332C1E5R1BB01# | p157 | | ±0.1pF | GJM0332C1E5R2BB01# | p157 |
| | | | ±0.25pF | GJM0332C1E5R1CB01# | p157 | | | | | ±0.25pF | GJM0332C1E5R1CB01# | p157 | | ±0.25pF | GJM0332C1E5R2CB01# | p157 |
| | | 5.2pF | ±0.05pF | GJM0332C1E5R2WB01# | p157 | 5.2pF | | | | ±0.05pF | GJM0332C1E5R2WB01# | p157 | 5.2pF | ±0.05pF | GJM0332C1E5R2WB01# | p157 |
| | | | ±0.1pF | GJM0332C1E5R2BB01# | p157 | | | | | ±0.1pF | GJM0332C1E5R2BB01# | p157 | | ±0.1pF | GJM0332C1E5R2BB01# | p157 |
| | | | ±0.25pF | GJM0332C1E5R2CB01# | p157 | | | | | ±0.25pF | GJM0332C1E5R2CB01# | p157 | | ±0.25pF | GJM0332C1E5R2CB01# | p157 |

*: Refers to the page of the "Specifications and Test Methods".

Part number # indicates the package specification code.



GJM Series Temperature Compensating Type Part Number List

(→ 0.6×0.3mm)

| T max. | Rated Voltage | TC Code | Cap. | Tol. | Part Number | p* |
|--------|---------------|---------|-------|---------|--------------------|------|
| 0.33mm | 25Vdc | CH | 6.6pF | ±0.05pF | GJM0332C1E6R6WB01# | p157 |
| | | | | ±0.1pF | GJM0332C1E6R6BB01# | p157 |
| | | | | ±0.25pF | GJM0332C1E6R6CB01# | p157 |
| | | | | ±0.5pF | GJM0332C1E6R6DB01# | p157 |
| | | | 6.7pF | ±0.05pF | GJM0332C1E6R7WB01# | p157 |
| | | | | ±0.1pF | GJM0332C1E6R7BB01# | p157 |
| | | | | ±0.25pF | GJM0332C1E6R7CB01# | p157 |
| | | | | ±0.5pF | GJM0332C1E6R7DB01# | p157 |
| | | | 6.8pF | ±0.05pF | GJM0332C1E6R8WB01# | p157 |
| | | | | ±0.1pF | GJM0332C1E6R8BB01# | p157 |
| | | | | ±0.25pF | GJM0332C1E6R8CB01# | p157 |
| | | | | ±0.5pF | GJM0332C1E6R8DB01# | p157 |
| | | | 6.9pF | ±0.05pF | GJM0332C1E6R9WB01# | p157 |
| | | | | ±0.1pF | GJM0332C1E6R9BB01# | p157 |
| | | | | ±0.25pF | GJM0332C1E6R9CB01# | p157 |
| | | | | ±0.5pF | GJM0332C1E6R9DB01# | p157 |
| | | | 7.0pF | ±0.05pF | GJM0332C1E7ROWB01# | p157 |
| | | | | ±0.1pF | GJM0332C1E7ROBB01# | p157 |
| | | | | ±0.25pF | GJM0332C1E7ROCB01# | p157 |
| | | | | ±0.5pF | GJM0332C1E7RODB01# | p157 |
| | | | 7.1pF | ±0.05pF | GJM0332C1E7R1WB01# | p157 |
| | | | | ±0.1pF | GJM0332C1E7R1BB01# | p157 |
| | | | | ±0.25pF | GJM0332C1E7R1CB01# | p157 |
| | | | | ±0.5pF | GJM0332C1E7R1DB01# | p157 |
| | | | 7.2pF | ±0.05pF | GJM0332C1E7R2WB01# | p157 |
| | | | | ±0.1pF | GJM0332C1E7R2BB01# | p157 |
| | | | | ±0.25pF | GJM0332C1E7R2CB01# | p157 |
| | | | | ±0.5pF | GJM0332C1E7R2DB01# | p157 |
| | | | 7.3pF | ±0.05pF | GJM0332C1E7R3WB01# | p157 |
| | | | | ±0.1pF | GJM0332C1E7R3BB01# | p157 |
| | | | | ±0.25pF | GJM0332C1E7R3CB01# | p157 |
| | | | | ±0.5pF | GJM0332C1E7R3DB01# | p157 |
| | | | 7.4pF | ±0.05pF | GJM0332C1E7R4WB01# | p157 |
| | | | | ±0.1pF | GJM0332C1E7R4BB01# | p157 |
| | | | | ±0.25pF | GJM0332C1E7R4CB01# | p157 |
| | | | | ±0.5pF | GJM0332C1E7R4DB01# | p157 |
| | | | 7.5pF | ±0.05pF | GJM0332C1E7R5WB01# | p157 |
| | | | | ±0.1pF | GJM0332C1E7R5BB01# | p157 |
| | | | | ±0.25pF | GJM0332C1E7R5CB01# | p157 |
| | | | | ±0.5pF | GJM0332C1E7R5DB01# | p157 |
| | | | 7.6pF | ±0.05pF | GJM0332C1E7R6WB01# | p157 |
| | | | | ±0.1pF | GJM0332C1E7R6BB01# | p157 |
| | | | | ±0.25pF | GJM0332C1E7R6CB01# | p157 |
| | | | | ±0.5pF | GJM0332C1E7R6DB01# | p157 |
| | | | 7.7pF | ±0.05pF | GJM0332C1E7R7WB01# | p157 |
| | | | | ±0.1pF | GJM0332C1E7R7BB01# | p157 |
| | | | | ±0.25pF | GJM0332C1E7R7CB01# | p157 |
| | | | | ±0.5pF | GJM0332C1E7R7DB01# | p157 |
| | | | 7.8pF | ±0.05pF | GJM0332C1E7R8WB01# | p157 |
| | | | | ±0.1pF | GJM0332C1E7R8BB01# | p157 |
| | | | | ±0.25pF | GJM0332C1E7R8CB01# | p157 |
| | | | | ±0.5pF | GJM0332C1E7R8DB01# | p157 |
| | | | 7.9pF | ±0.05pF | GJM0332C1E7R9WB01# | p157 |
| | | | | ±0.1pF | GJM0332C1E7R9BB01# | p157 |

| T max. | Rated Voltage | TC Code | Cap. | Tol. | Part Number | p* |
|--------|---------------|---------|-------|---------|--------------------|------|
| 0.33mm | 25Vdc | CH | 7.9pF | ±0.25pF | GJM0332C1E7R9CB01# | p157 |
| | | | | ±0.5pF | GJM0332C1E7R9DB01# | p157 |
| | | | 8.0pF | ±0.05pF | GJM0332C1E8ROWB01# | p157 |
| | | | | ±0.1pF | GJM0332C1E8ROBB01# | p157 |
| | | | | ±0.25pF | GJM0332C1E8ROCB01# | p157 |
| | | | 8.1pF | ±0.05pF | GJM0332C1E8R1WB01# | p157 |
| | | | | ±0.1pF | GJM0332C1E8R1BB01# | p157 |
| | | | | ±0.25pF | GJM0332C1E8R1CB01# | p157 |
| | | | 8.2pF | ±0.05pF | GJM0332C1E8R2WB01# | p157 |
| | | | | ±0.1pF | GJM0332C1E8R2BB01# | p157 |
| | | | | ±0.25pF | GJM0332C1E8R2CB01# | p157 |
| | | | 8.3pF | ±0.05pF | GJM0332C1E8R3WB01# | p157 |
| | | | | ±0.1pF | GJM0332C1E8R3BB01# | p157 |
| | | | | ±0.25pF | GJM0332C1E8R3CB01# | p157 |
| | | | 8.4pF | ±0.05pF | GJM0332C1E8R4WB01# | p157 |
| | | | | ±0.1pF | GJM0332C1E8R4BB01# | p157 |
| | | | | ±0.25pF | GJM0332C1E8R4CB01# | p157 |
| | | | 8.5pF | ±0.05pF | GJM0332C1E8R5WB01# | p157 |
| | | | | ±0.1pF | GJM0332C1E8R5BB01# | p157 |
| | | | | ±0.25pF | GJM0332C1E8R5CB01# | p157 |
| | | | 8.6pF | ±0.05pF | GJM0332C1E8R6WB01# | p157 |
| | | | | ±0.1pF | GJM0332C1E8R6BB01# | p157 |
| | | | | ±0.25pF | GJM0332C1E8R6CB01# | p157 |
| | | | 8.7pF | ±0.05pF | GJM0332C1E8R7WB01# | p157 |
| | | | | ±0.1pF | GJM0332C1E8R7BB01# | p157 |
| | | | | ±0.25pF | GJM0332C1E8R7CB01# | p157 |
| | | | 8.8pF | ±0.05pF | GJM0332C1E8R8WB01# | p157 |
| | | | | ±0.1pF | GJM0332C1E8R8BB01# | p157 |
| | | | | ±0.25pF | GJM0332C1E8R8CB01# | p157 |
| | | | 8.9pF | ±0.05pF | GJM0332C1E8R9WB01# | p157 |
| | | | | ±0.1pF | GJM0332C1E8R9BB01# | p157 |
| | | | | ±0.25pF | GJM0332C1E8R9CB01# | p157 |
| | | | 9.0pF | ±0.05pF | GJM0332C1E9ROWB01# | p157 |
| | | | | ±0.1pF | GJM0332C1E9ROBB01# | p157 |
| | | | | ±0.25pF | GJM0332C1E9ROCB01# | p157 |
| | | | 9.1pF | ±0.05pF | GJM0332C1E9R1WB01# | p157 |
| | | | | ±0.1pF | GJM0332C1E9R1BB01# | p157 |
| | | | | ±0.25pF | GJM0332C1E9R1CB01# | p157 |
| | | | 9.2pF | ±0.05pF | GJM0332C1E9R2WB01# | p157 |
| | | | | ±0.1pF | GJM0332C1E9R2BB01# | p157 |
| | | | | ±0.25pF | GJM0332C1E9R2CB01# | p157 |

*: Refers to the page of the "Specifications and Test Methods".

Part number # indicates the package specification code.



GJM Series Temperature Compensating Type Part Number List

(→ 0.6×0.3mm)

| T max. | Rated Voltage | TC Code | Cap. | Tol. | Part Number | p* |
|--------|---------------|---------|-------|---------|--------------------|------|
| 0.33mm | 25Vdc | CH | 9.3pF | ±0.05pF | GJM0332C1E9R3WB01# | p157 |
| | | | | ±0.1pF | GJM0332C1E9R3BB01# | p157 |
| | | | | ±0.25pF | GJM0332C1E9R3CB01# | p157 |
| | | | | ±0.5pF | GJM0332C1E9R3DB01# | p157 |
| | | | 9.4pF | ±0.05pF | GJM0332C1E9R4WB01# | p157 |
| | | | | ±0.1pF | GJM0332C1E9R4BB01# | p157 |
| | | | | ±0.25pF | GJM0332C1E9R4CB01# | p157 |
| | | | | ±0.5pF | GJM0332C1E9R4DB01# | p157 |
| | | | 9.5pF | ±0.05pF | GJM0332C1E9R5WB01# | p157 |
| | | | | ±0.1pF | GJM0332C1E9R5BB01# | p157 |
| | | | | ±0.25pF | GJM0332C1E9R5CB01# | p157 |
| | | | | ±0.5pF | GJM0332C1E9R5DB01# | p157 |
| | | | 9.6pF | ±0.05pF | GJM0332C1E9R6WB01# | p157 |
| | | | | ±0.1pF | GJM0332C1E9R6BB01# | p157 |
| | | | | ±0.25pF | GJM0332C1E9R6CB01# | p157 |
| | | | | ±0.5pF | GJM0332C1E9R6DB01# | p157 |
| | | | 9.7pF | ±0.05pF | GJM0332C1E9R7WB01# | p157 |
| | | | | ±0.1pF | GJM0332C1E9R7BB01# | p157 |
| | | | | ±0.25pF | GJM0332C1E9R7CB01# | p157 |
| | | | | ±0.5pF | GJM0332C1E9R7DB01# | p157 |
| | | | 9.8pF | ±0.05pF | GJM0332C1E9R8WB01# | p157 |
| | | | | ±0.1pF | GJM0332C1E9R8BB01# | p157 |
| | | | | ±0.25pF | GJM0332C1E9R8CB01# | p157 |
| | | | | ±0.5pF | GJM0332C1E9R8DB01# | p157 |
| | | | 9.9pF | ±0.05pF | GJM0332C1E9R9WB01# | p157 |
| | | | | ±0.1pF | GJM0332C1E9R9BB01# | p157 |
| | | | | ±0.25pF | GJM0332C1E9R9CB01# | p157 |
| | | | | ±0.5pF | GJM0332C1E9R9DB01# | p157 |
| | | | 10pF | ±2% | GJM0332C1E100GB01# | p157 |
| | | | | ±5% | GJM0332C1E100JB01# | p157 |
| | | | 11pF | ±2% | GJM0332C1E110GB01# | p157 |
| | | | | ±5% | GJM0332C1E110JB01# | p157 |
| | | | 12pF | ±2% | GJM0332C1E120GB01# | p157 |
| | | | | ±5% | GJM0332C1E120JB01# | p157 |
| | | | 13pF | ±2% | GJM0332C1E130GB01# | p157 |
| | | | | ±5% | GJM0332C1E130JB01# | p157 |
| | | | 15pF | ±2% | GJM0332C1E150GB01# | p157 |
| | | | | ±5% | GJM0332C1E150JB01# | p157 |
| | | | 16pF | ±2% | GJM0332C1E160GB01# | p157 |
| | | | | ±5% | GJM0332C1E160JB01# | p157 |
| | | | 18pF | ±2% | GJM0332C1E180GB01# | p157 |
| | | | | ±5% | GJM0332C1E180JB01# | p157 |
| | | | 20pF | ±2% | GJM0332C1E200GB01# | p157 |
| | | | | ±5% | GJM0332C1E200JB01# | p157 |
| | | | 22pF | ±2% | GJM0332C1E220GB01# | p157 |
| | | | | ±5% | GJM0332C1E220JB01# | p157 |
| | | | 24pF | ±2% | GJM0332C1E240GB01# | p157 |
| | | | | ±5% | GJM0332C1E240JB01# | p157 |
| | | | 27pF | ±2% | GJM0332C1E270GB01# | p157 |
| | | | | ±5% | GJM0332C1E270JB01# | p157 |
| | | | 30pF | ±2% | GJM0332C1E300GB01# | p157 |
| | | | | ±5% | GJM0332C1E300JB01# | p157 |
| | | | 33pF | ±2% | GJM0332C1E330GB01# | p157 |
| | | | | ±5% | GJM0332C1E330JB01# | p157 |

1.0×0.5mm

| T max. | Rated Voltage | TC Code | Cap. | Tol. | Part Number | p* |
|---------|--------------------|--------------------|--------|---------|--------------------|------|
| 0.55mm | 50Vdc | COG | 0.10pF | ±0.05pF | GJM1555C1HR10WB01# | p157 |
| | | | | ±0.1pF | GJM1555C1HR10BB01# | p157 |
| | | | 0.20pF | ±0.05pF | GJM1555C1HR20WB01# | p157 |
| | | | | ±0.1pF | GJM1555C1HR20BB01# | p157 |
| | | | 0.30pF | ±0.05pF | GJM1555C1HR30WB01# | p157 |
| | | | | ±0.1pF | GJM1555C1HR30BB01# | p157 |
| | | | 0.40pF | ±0.05pF | GJM1555C1HR40WB01# | p157 |
| | | | | ±0.1pF | GJM1555C1HR40BB01# | p157 |
| | | | 0.50pF | ±0.05pF | GJM1555C1HR50WB01# | p157 |
| | | | | ±0.1pF | GJM1555C1HR50BB01# | p157 |
| | | | 0.60pF | ±0.05pF | GJM1555C1HR60WB01# | p157 |
| | | | | ±0.1pF | GJM1555C1HR60BB01# | p157 |
| | | | 0.70pF | ±0.05pF | GJM1555C1HR70WB01# | p157 |
| | | | | ±0.1pF | GJM1555C1HR70BB01# | p157 |
| | | | 0.80pF | ±0.05pF | GJM1555C1HR80WB01# | p157 |
| | | | | ±0.1pF | GJM1555C1HR80BB01# | p157 |
| | | | 0.90pF | ±0.05pF | GJM1555C1HR90WB01# | p157 |
| | | | | ±0.1pF | GJM1555C1HR90BB01# | p157 |
| | | | 1.0pF | ±0.05pF | GJM1555C1H1R0WB01# | p157 |
| | | | | ±0.1pF | GJM1555C1H1R0BB01# | p157 |
| | | | | ±0.25pF | GJM1555C1H1R0CB01# | p157 |
| | | | 1.1pF | ±0.05pF | GJM1555C1H1R1WB01# | p157 |
| | | | | ±0.1pF | GJM1555C1H1R1BB01# | p157 |
| | | | | ±0.25pF | GJM1555C1H1R1CB01# | p157 |
| | | | 1.2pF | ±0.05pF | GJM1555C1H1R2WB01# | p157 |
| | | | | ±0.1pF | GJM1555C1H1R2BB01# | p157 |
| | | | | ±0.25pF | GJM1555C1H1R2CB01# | p157 |
| | | | 1.3pF | ±0.05pF | GJM1555C1H1R3WB01# | p157 |
| | | | | ±0.1pF | GJM1555C1H1R3BB01# | p157 |
| | | | | ±0.25pF | GJM1555C1H1R3CB01# | p157 |
| | | | 1.4pF | ±0.05pF | GJM1555C1H1R4WB01# | p157 |
| | | | | ±0.1pF | GJM1555C1H1R4BB01# | p157 |
| | | | | ±0.25pF | GJM1555C1H1R4CB01# | p157 |
| | | | 1.5pF | ±0.05pF | GJM1555C1H1R5WB01# | p157 |
| | | | | ±0.1pF | GJM1555C1H1R5BB01# | p157 |
| | | | | ±0.25pF | GJM1555C1H1R5CB01# | p157 |
| | | | 1.6pF | ±0.05pF | GJM1555C1H1R6WB01# | p157 |
| | | | | ±0.1pF | GJM1555C1H1R6BB01# | p157 |
| | | | | ±0.25pF | GJM1555C1H1R6CB01# | p157 |
| | | | 1.7pF | ±0.05pF | GJM1555C1H1R7WB01# | p157 |
| ±0.1pF | GJM1555C1H1R7BB01# | p157 | | | | |
| ±0.25pF | GJM1555C1H1R7CB01# | p157 | | | | |
| 1.8pF | ±0.05pF | GJM1555C1H1R8WB01# | p157 | | | |
| | ±0.1pF | GJM1555C1H1R8BB01# | p157 | | | |
| | ±0.25pF | GJM1555C1H1R8CB01# | p157 | | | |
| 1.9pF | ±0.05pF | GJM1555C1H1R9WB01# | p157 | | | |
| | ±0.1pF | GJM1555C1H1R9BB01# | p157 | | | |
| | ±0.25pF | GJM1555C1H1R9CB01# | p157 | | | |
| 2.0pF | ±0.05pF | GJM1555C1H2R0WB01# | p157 | | | |
| | ±0.1pF | GJM1555C1H2R0BB01# | p157 | | | |
| | ±0.25pF | GJM1555C1H2R0CB01# | p157 | | | |
| 2.1pF | ±0.05pF | GJM1555C1H2R1WB01# | p157 | | | |

*: Refers to the page of the "Specifications and Test Methods".

Part number # indicates the package specification code.

GJM Series Temperature Compensating Type Part Number List

(→ 1.0×0.5mm)

| T max. | Rated Voltage | TC Code | Cap. | Tol. | Part Number | p* | T max. | Rated Voltage | TC Code | Cap. | Tol. | Part Number | p* |
|--------|---------------|---------|-------|---------|--------------------|------|--------|---------------|--------------------|-------|---------|--------------------|------|
| 0.55mm | 50Vdc | COG | 2.1pF | ±0.1pF | GJM1555C1H2R1BB01# | p157 | 0.55mm | 50Vdc | COG | 3.9pF | ±0.1pF | GJM1555C1H3R9BB01# | p157 |
| | | | | ±0.25pF | GJM1555C1H2R1CB01# | p157 | | | | | ±0.25pF | GJM1555C1H3R9CB01# | p157 |
| | | | 2.2pF | ±0.05pF | GJM1555C1H2R2WB01# | p157 | | | | 4.0pF | ±0.05pF | GJM1555C1H4ROWB01# | p157 |
| | | | | ±0.1pF | GJM1555C1H2R2BB01# | p157 | | | | | ±0.1pF | GJM1555C1H4R0BB01# | p157 |
| | | | | ±0.25pF | GJM1555C1H2R2CB01# | p157 | | | | | ±0.25pF | GJM1555C1H4R0CB01# | p157 |
| | | | 2.3pF | ±0.05pF | GJM1555C1H2R3WB01# | p157 | | | | 4.1pF | ±0.05pF | GJM1555C1H4R1WB01# | p157 |
| | | | | ±0.1pF | GJM1555C1H2R3BB01# | p157 | | | | | ±0.1pF | GJM1555C1H4R1BB01# | p157 |
| | | | | ±0.25pF | GJM1555C1H2R3CB01# | p157 | | | | | ±0.25pF | GJM1555C1H4R1CB01# | p157 |
| | | | 2.4pF | ±0.05pF | GJM1555C1H2R4WB01# | p157 | | | | 4.2pF | ±0.05pF | GJM1555C1H4R2WB01# | p157 |
| | | | | ±0.1pF | GJM1555C1H2R4BB01# | p157 | | | | | ±0.1pF | GJM1555C1H4R2BB01# | p157 |
| | | | | ±0.25pF | GJM1555C1H2R4CB01# | p157 | | | | | ±0.25pF | GJM1555C1H4R2CB01# | p157 |
| | | | 2.5pF | ±0.05pF | GJM1555C1H2R5WB01# | p157 | | | | 4.3pF | ±0.05pF | GJM1555C1H4R3WB01# | p157 |
| | | | | ±0.1pF | GJM1555C1H2R5BB01# | p157 | | | | | ±0.1pF | GJM1555C1H4R3BB01# | p157 |
| | | | | ±0.25pF | GJM1555C1H2R5CB01# | p157 | | | | | ±0.25pF | GJM1555C1H4R3CB01# | p157 |
| | | | 2.6pF | ±0.05pF | GJM1555C1H2R6WB01# | p157 | | | | 4.4pF | ±0.05pF | GJM1555C1H4R4WB01# | p157 |
| | | | | ±0.1pF | GJM1555C1H2R6BB01# | p157 | | | | | ±0.1pF | GJM1555C1H4R4BB01# | p157 |
| | | | | ±0.25pF | GJM1555C1H2R6CB01# | p157 | | | | | ±0.25pF | GJM1555C1H4R4CB01# | p157 |
| | | | 2.7pF | ±0.05pF | GJM1555C1H2R7WB01# | p157 | | | | 4.5pF | ±0.05pF | GJM1555C1H4R5WB01# | p157 |
| | | | | ±0.1pF | GJM1555C1H2R7BB01# | p157 | | | | | ±0.1pF | GJM1555C1H4R5BB01# | p157 |
| | | | | ±0.25pF | GJM1555C1H2R7CB01# | p157 | | | | | ±0.25pF | GJM1555C1H4R5CB01# | p157 |
| | | | 2.8pF | ±0.05pF | GJM1555C1H2R8WB01# | p157 | 4.6pF | ±0.05pF | GJM1555C1H4R6WB01# | p157 | | | |
| | | | | ±0.1pF | GJM1555C1H2R8BB01# | p157 | | ±0.1pF | GJM1555C1H4R6BB01# | p157 | | | |
| | | | | ±0.25pF | GJM1555C1H2R8CB01# | p157 | | ±0.25pF | GJM1555C1H4R6CB01# | p157 | | | |
| | | | 2.9pF | ±0.05pF | GJM1555C1H2R9WB01# | p157 | 4.7pF | ±0.05pF | GJM1555C1H4R7WB01# | p157 | | | |
| | | | | ±0.1pF | GJM1555C1H2R9BB01# | p157 | | ±0.1pF | GJM1555C1H4R7BB01# | p157 | | | |
| | | | | ±0.25pF | GJM1555C1H2R9CB01# | p157 | | ±0.25pF | GJM1555C1H4R7CB01# | p157 | | | |
| | | | 3.0pF | ±0.05pF | GJM1555C1H3R0WB01# | p157 | 4.8pF | ±0.05pF | GJM1555C1H4R8WB01# | p157 | | | |
| | | | | ±0.1pF | GJM1555C1H3R0BB01# | p157 | | ±0.1pF | GJM1555C1H4R8BB01# | p157 | | | |
| | | | | ±0.25pF | GJM1555C1H3R0CB01# | p157 | | ±0.25pF | GJM1555C1H4R8CB01# | p157 | | | |
| | | | 3.1pF | ±0.05pF | GJM1555C1H3R1WB01# | p157 | 4.9pF | ±0.05pF | GJM1555C1H4R9WB01# | p157 | | | |
| | | | | ±0.1pF | GJM1555C1H3R1BB01# | p157 | | ±0.1pF | GJM1555C1H4R9BB01# | p157 | | | |
| | | | | ±0.25pF | GJM1555C1H3R1CB01# | p157 | | ±0.25pF | GJM1555C1H4R9CB01# | p157 | | | |
| | | | 3.2pF | ±0.05pF | GJM1555C1H3R2WB01# | p157 | 5.0pF | ±0.05pF | GJM1555C1H5R0WB01# | p157 | | | |
| | | | | ±0.1pF | GJM1555C1H3R2BB01# | p157 | | ±0.1pF | GJM1555C1H5R0BB01# | p157 | | | |
| | | | | ±0.25pF | GJM1555C1H3R2CB01# | p157 | | ±0.25pF | GJM1555C1H5R0CB01# | p157 | | | |
| | | | 3.3pF | ±0.05pF | GJM1555C1H3R3WB01# | p157 | 5.1pF | ±0.05pF | GJM1555C1H5R1WB01# | p157 | | | |
| | | | | ±0.1pF | GJM1555C1H3R3BB01# | p157 | | ±0.1pF | GJM1555C1H5R1BB01# | p157 | | | |
| | | | | ±0.25pF | GJM1555C1H3R3CB01# | p157 | | ±0.25pF | GJM1555C1H5R1CB01# | p157 | | | |
| | | | 3.4pF | ±0.05pF | GJM1555C1H3R4WB01# | p157 | 5.2pF | ±0.05pF | GJM1555C1H5R2WB01# | p157 | | | |
| | | | | ±0.1pF | GJM1555C1H3R4BB01# | p157 | | ±0.1pF | GJM1555C1H5R2BB01# | p157 | | | |
| | | | | ±0.25pF | GJM1555C1H3R4CB01# | p157 | | ±0.25pF | GJM1555C1H5R2CB01# | p157 | | | |
| | | | 3.5pF | ±0.05pF | GJM1555C1H3R5WB01# | p157 | 5.3pF | ±0.05pF | GJM1555C1H5R3WB01# | p157 | | | |
| | | | | ±0.1pF | GJM1555C1H3R5BB01# | p157 | | ±0.1pF | GJM1555C1H5R3BB01# | p157 | | | |
| | | | | ±0.25pF | GJM1555C1H3R5CB01# | p157 | | ±0.25pF | GJM1555C1H5R3CB01# | p157 | | | |
| | | | 3.6pF | ±0.05pF | GJM1555C1H3R6WB01# | p157 | 5.4pF | ±0.05pF | GJM1555C1H5R4WB01# | p157 | | | |
| | | | | ±0.1pF | GJM1555C1H3R6BB01# | p157 | | ±0.1pF | GJM1555C1H5R4BB01# | p157 | | | |
| | | | | ±0.25pF | GJM1555C1H3R6CB01# | p157 | | ±0.25pF | GJM1555C1H5R4CB01# | p157 | | | |
| | | | 3.7pF | ±0.05pF | GJM1555C1H3R7WB01# | p157 | 5.5pF | ±0.05pF | GJM1555C1H5R5WB01# | p157 | | | |
| | | | | ±0.1pF | GJM1555C1H3R7BB01# | p157 | | ±0.1pF | GJM1555C1H5R5BB01# | p157 | | | |
| | | | | ±0.25pF | GJM1555C1H3R7CB01# | p157 | | ±0.25pF | GJM1555C1H5R5CB01# | p157 | | | |
| | | | 3.8pF | ±0.05pF | GJM1555C1H3R8WB01# | p157 | 5.5pF | ±0.05pF | GJM1555C1H5R5WB01# | p157 | | | |
| | | | | ±0.1pF | GJM1555C1H3R8BB01# | p157 | | ±0.1pF | GJM1555C1H5R5BB01# | p157 | | | |
| | | | | ±0.25pF | GJM1555C1H3R8CB01# | p157 | | ±0.25pF | GJM1555C1H5R5CB01# | p157 | | | |
| | | | 3.9pF | ±0.05pF | GJM1555C1H3R9WB01# | p157 | 5.5pF | ±0.05pF | GJM1555C1H5R5WB01# | p157 | | | |

*: Refers to the page of the "Specifications and Test Methods".

Part number # indicates the package specification code.



GJM Series Temperature Compensating Type Part Number List

(→ 1.0×0.5mm)

| T max. | Rated Voltage | TC Code | Cap. | Tol. | Part Number | p* |
|--------|---------------|---------|---------|---------|--------------------|--------------------|
| 0.55mm | 50Vdc | COG | 5.5pF | ±0.5pF | GJM1555C1H5R5DB01# | p157 |
| | | | | ±0.05pF | GJM1555C1H5R6WB01# | p157 |
| | | | | | ±0.1pF | GJM1555C1H5R6BB01# |
| | | | ±0.25pF | | GJM1555C1H5R6CB01# | p157 |
| | | | 5.6pF | ±0.5pF | GJM1555C1H5R6DB01# | p157 |
| | | | | ±0.05pF | GJM1555C1H5R7WB01# | p157 |
| | | | | | ±0.1pF | GJM1555C1H5R7BB01# |
| | | | ±0.25pF | | GJM1555C1H5R7CB01# | p157 |
| | | | 5.7pF | ±0.5pF | GJM1555C1H5R7DB01# | p157 |
| | | | | ±0.05pF | GJM1555C1H5R8WB01# | p157 |
| | | | | | ±0.1pF | GJM1555C1H5R8BB01# |
| | | | ±0.25pF | | GJM1555C1H5R8CB01# | p157 |
| | | | 5.8pF | ±0.5pF | GJM1555C1H5R8DB01# | p157 |
| | | | | ±0.05pF | GJM1555C1H5R9WB01# | p157 |
| | | | | | ±0.1pF | GJM1555C1H5R9BB01# |
| | | | ±0.25pF | | GJM1555C1H5R9CB01# | p157 |
| | | | 5.9pF | ±0.5pF | GJM1555C1H5R9DB01# | p157 |
| | | | | ±0.05pF | GJM1555C1H6R0WB01# | p157 |
| | | | | | ±0.1pF | GJM1555C1H6R0BB01# |
| | | | ±0.25pF | | GJM1555C1H6R0CB01# | p157 |
| | | | 6.0pF | ±0.5pF | GJM1555C1H6R0DB01# | p157 |
| | | | | ±0.05pF | GJM1555C1H6R1WB01# | p157 |
| | | | | | ±0.1pF | GJM1555C1H6R1BB01# |
| | | | ±0.25pF | | GJM1555C1H6R1CB01# | p157 |
| | | | 6.1pF | ±0.5pF | GJM1555C1H6R1DB01# | p157 |
| | | | | ±0.05pF | GJM1555C1H6R2WB01# | p157 |
| | | | | | ±0.1pF | GJM1555C1H6R2BB01# |
| | | | ±0.25pF | | GJM1555C1H6R2CB01# | p157 |
| | | | 6.2pF | ±0.5pF | GJM1555C1H6R2DB01# | p157 |
| | | | | ±0.05pF | GJM1555C1H6R3WB01# | p157 |
| | | | | | ±0.1pF | GJM1555C1H6R3BB01# |
| | | | ±0.25pF | | GJM1555C1H6R3CB01# | p157 |
| | | | 6.3pF | ±0.5pF | GJM1555C1H6R3DB01# | p157 |
| | | | | ±0.05pF | GJM1555C1H6R4WB01# | p157 |
| | | | | | ±0.1pF | GJM1555C1H6R4BB01# |
| | | | ±0.25pF | | GJM1555C1H6R4CB01# | p157 |
| | | | 6.4pF | ±0.5pF | GJM1555C1H6R4DB01# | p157 |
| | | | | ±0.05pF | GJM1555C1H6R5WB01# | p157 |
| | | | | | ±0.1pF | GJM1555C1H6R5BB01# |
| | | | ±0.25pF | | GJM1555C1H6R5CB01# | p157 |
| | | | 6.5pF | ±0.5pF | GJM1555C1H6R5DB01# | p157 |
| | | | | ±0.05pF | GJM1555C1H6R6WB01# | p157 |
| | | | | | ±0.1pF | GJM1555C1H6R6BB01# |
| | | | ±0.25pF | | GJM1555C1H6R6CB01# | p157 |
| | | | 6.6pF | ±0.5pF | GJM1555C1H6R6DB01# | p157 |
| | | | | ±0.05pF | GJM1555C1H6R7WB01# | p157 |
| | | | | | ±0.1pF | GJM1555C1H6R7BB01# |
| | | | ±0.25pF | | GJM1555C1H6R7CB01# | p157 |
| | | | 6.7pF | ±0.5pF | GJM1555C1H6R7DB01# | p157 |
| | | | | ±0.05pF | GJM1555C1H6R8WB01# | p157 |
| | | | | | ±0.1pF | GJM1555C1H6R8BB01# |
| | | | ±0.25pF | | GJM1555C1H6R8CB01# | p157 |
| | | | 6.8pF | ±0.5pF | GJM1555C1H6R8DB01# | p157 |
| | | | | ±0.05pF | GJM1555C1H6R9WB01# | p157 |

| T max. | Rated Voltage | TC Code | Cap. | Tol. | Part Number | p* |
|--------|---------------|---------|---------|---------|--------------------|--------------------|
| 0.55mm | 50Vdc | COG | 6.9pF | ±0.1pF | GJM1555C1H6R9BB01# | p157 |
| | | | | ±0.25pF | GJM1555C1H6R9CB01# | p157 |
| | | | | ±0.5pF | GJM1555C1H6R9DB01# | p157 |
| | | | 7.0pF | ±0.05pF | GJM1555C1H7R0WB01# | p157 |
| | | | | ±0.1pF | GJM1555C1H7R0BB01# | p157 |
| | | | | ±0.25pF | GJM1555C1H7R0CB01# | p157 |
| | | | 7.1pF | ±0.5pF | GJM1555C1H7R0DB01# | p157 |
| | | | | ±0.05pF | GJM1555C1H7R1WB01# | p157 |
| | | | | | ±0.1pF | GJM1555C1H7R1BB01# |
| | | | ±0.25pF | | GJM1555C1H7R1CB01# | p157 |
| | | | 7.2pF | ±0.5pF | GJM1555C1H7R1DB01# | p157 |
| | | | | ±0.05pF | GJM1555C1H7R2WB01# | p157 |
| | | | | | ±0.1pF | GJM1555C1H7R2BB01# |
| | | | ±0.25pF | | GJM1555C1H7R2CB01# | p157 |
| | | | 7.3pF | ±0.5pF | GJM1555C1H7R2DB01# | p157 |
| | | | | ±0.05pF | GJM1555C1H7R3WB01# | p157 |
| | | | | | ±0.1pF | GJM1555C1H7R3BB01# |
| | | | ±0.25pF | | GJM1555C1H7R3CB01# | p157 |
| | | | 7.4pF | ±0.5pF | GJM1555C1H7R3DB01# | p157 |
| | | | | ±0.05pF | GJM1555C1H7R4WB01# | p157 |
| | | | | | ±0.1pF | GJM1555C1H7R4BB01# |
| | | | ±0.25pF | | GJM1555C1H7R4CB01# | p157 |
| | | | 7.5pF | ±0.5pF | GJM1555C1H7R4DB01# | p157 |
| | | | | ±0.05pF | GJM1555C1H7R5WB01# | p157 |
| | | | | | ±0.1pF | GJM1555C1H7R5BB01# |
| | | | ±0.25pF | | GJM1555C1H7R5CB01# | p157 |
| | | | 7.6pF | ±0.5pF | GJM1555C1H7R5DB01# | p157 |
| | | | | ±0.05pF | GJM1555C1H7R6WB01# | p157 |
| | | | | | ±0.1pF | GJM1555C1H7R6BB01# |
| | | | ±0.25pF | | GJM1555C1H7R6CB01# | p157 |
| | | | 7.7pF | ±0.5pF | GJM1555C1H7R6DB01# | p157 |
| | | | | ±0.05pF | GJM1555C1H7R7WB01# | p157 |
| | | | | | ±0.1pF | GJM1555C1H7R7BB01# |
| | | | ±0.25pF | | GJM1555C1H7R7CB01# | p157 |
| | | | 7.8pF | ±0.5pF | GJM1555C1H7R7DB01# | p157 |
| | | | | ±0.05pF | GJM1555C1H7R8WB01# | p157 |
| | | | | | ±0.1pF | GJM1555C1H7R8BB01# |
| | | | ±0.25pF | | GJM1555C1H7R8CB01# | p157 |
| | | | 7.9pF | ±0.5pF | GJM1555C1H7R8DB01# | p157 |
| | | | | ±0.05pF | GJM1555C1H7R9WB01# | p157 |
| | | | | | ±0.1pF | GJM1555C1H7R9BB01# |
| | | | ±0.25pF | | GJM1555C1H7R9CB01# | p157 |
| | | | 8.0pF | ±0.5pF | GJM1555C1H7R9DB01# | p157 |
| | | | | ±0.05pF | GJM1555C1H8R0WB01# | p157 |
| | | | | | ±0.1pF | GJM1555C1H8R0BB01# |
| | | | ±0.25pF | | GJM1555C1H8R0CB01# | p157 |
| | | | 8.1pF | ±0.5pF | GJM1555C1H8R0DB01# | p157 |
| | | | | ±0.05pF | GJM1555C1H8R1WB01# | p157 |
| | | | | | ±0.1pF | GJM1555C1H8R1BB01# |
| | | | ±0.25pF | | GJM1555C1H8R1CB01# | p157 |
| | | | 8.2pF | ±0.5pF | GJM1555C1H8R1DB01# | p157 |
| | | | | ±0.05pF | GJM1555C1H8R2WB01# | p157 |
| | | | | | ±0.1pF | GJM1555C1H8R2BB01# |
| | | | ±0.25pF | | GJM1555C1H8R2CB01# | p157 |

*: Refers to the page of the "Specifications and Test Methods".

Part number # indicates the package specification code.

GJM Series Temperature Compensating Type Part Number List

(→ 1.0×0.5mm)

| T max. | Rated Voltage | TC Code | Cap. | Tol. | Part Number | p* | T max. | Rated Voltage | TC Code | Cap. | Tol. | Part Number | p* | |
|--------|---------------|---------|---------|--------------------|--------------------|------|--------|---------------|---------|--------------------|--------------------|--------------------|--------------------|------|
| 0.55mm | 50Vdc | COG | 8.2pF | ±0.5pF | GJM1555C1H8R2DB01# | p157 | 0.55mm | 50Vdc | COG | 9.6pF | ±0.1pF | GJM1555C1H9R6BB01# | p157 | |
| | | | | ±0.05pF | GJM1555C1H8R3WB01# | p157 | | | | | ±0.25pF | GJM1555C1H9R6CB01# | p157 | |
| | | | 8.3pF | ±0.1pF | GJM1555C1H8R3BB01# | p157 | | | | 9.7pF | ±0.05pF | GJM1555C1H9R7WB01# | p157 | |
| | | | | ±0.25pF | GJM1555C1H8R3CB01# | p157 | | | | | ±0.1pF | GJM1555C1H9R7BB01# | p157 | |
| | | | | ±0.5pF | GJM1555C1H8R3DB01# | p157 | | | | | ±0.25pF | GJM1555C1H9R7CB01# | p157 | |
| | | | | ±0.05pF | GJM1555C1H8R4WB01# | p157 | | | | | ±0.5pF | GJM1555C1H9R7DB01# | p157 | |
| | | | 8.4pF | ±0.1pF | GJM1555C1H8R4BB01# | p157 | | | | 9.8pF | ±0.05pF | GJM1555C1H9R8WB01# | p157 | |
| | | | | ±0.25pF | GJM1555C1H8R4CB01# | p157 | | | | | ±0.1pF | GJM1555C1H9R8BB01# | p157 | |
| | | | | ±0.5pF | GJM1555C1H8R4DB01# | p157 | | | | | ±0.25pF | GJM1555C1H9R8CB01# | p157 | |
| | | | | ±0.05pF | GJM1555C1H8R5WB01# | p157 | | | | | ±0.5pF | GJM1555C1H9R8DB01# | p157 | |
| | | | 8.5pF | ±0.1pF | GJM1555C1H8R5BB01# | p157 | | | | 9.9pF | ±0.05pF | GJM1555C1H9R9WB01# | p157 | |
| | | | | ±0.25pF | GJM1555C1H8R5CB01# | p157 | | | | | ±0.1pF | GJM1555C1H9R9BB01# | p157 | |
| | | | | ±0.5pF | GJM1555C1H8R5DB01# | p157 | | | | | ±0.25pF | GJM1555C1H9R9CB01# | p157 | |
| | | | | ±0.05pF | GJM1555C1H8R6WB01# | p157 | | | | | ±0.5pF | GJM1555C1H9R9DB01# | p157 | |
| | | | 8.6pF | ±0.1pF | GJM1555C1H8R6BB01# | p157 | | | | 10pF | ±2% | GJM1555C1H100GB01# | p157 | |
| | | | | ±0.25pF | GJM1555C1H8R6CB01# | p157 | | | | | ±5% | GJM1555C1H100JB01# | p157 | |
| | | | | ±0.5pF | GJM1555C1H8R6DB01# | p157 | | | | | 11pF | ±2% | GJM1555C1H110GB01# | p157 |
| | | | | ±0.05pF | GJM1555C1H8R7WB01# | p157 | | | | | | ±5% | GJM1555C1H110JB01# | p157 |
| | | | ±0.1pF | GJM1555C1H8R7BB01# | p157 | 12pF | | | | ±2% | | GJM1555C1H120GB01# | p157 | |
| | | | ±0.25pF | GJM1555C1H8R7CB01# | p157 | | | | | ±5% | | GJM1555C1H120JB01# | p157 | |
| | | | 8.7pF | ±0.5pF | GJM1555C1H8R7DB01# | p157 | | | | 13pF | ±2% | GJM1555C1H130GB01# | p157 | |
| | | | | ±0.05pF | GJM1555C1H8R8WB01# | p157 | | | | | ±5% | GJM1555C1H130JB01# | p157 | |
| | | | | ±0.1pF | GJM1555C1H8R8BB01# | p157 | | | | | 15pF | ±2% | GJM1555C1H150GB01# | p157 |
| | | | | ±0.25pF | GJM1555C1H8R8CB01# | p157 | | | | | | ±5% | GJM1555C1H150JB01# | p157 |
| | | | ±0.5pF | GJM1555C1H8R8DB01# | p157 | 16pF | | | | ±2% | | GJM1555C1H160GB01# | p157 | |
| | | | ±0.05pF | GJM1555C1H8R9WB01# | p157 | | | | | ±5% | | GJM1555C1H160JB01# | p157 | |
| | | | 8.8pF | ±0.1pF | GJM1555C1H8R9BB01# | p157 | | | | 18pF | ±2% | GJM1555C1H180GB01# | p157 | |
| | | | | ±0.25pF | GJM1555C1H8R9CB01# | p157 | | | | | ±5% | GJM1555C1H180JB01# | p157 | |
| | | | | ±0.5pF | GJM1555C1H8R9DB01# | p157 | | | | | 20pF | ±2% | GJM1555C1H200GB01# | p157 |
| | | | | ±0.05pF | GJM1555C1H8R9WB01# | p157 | | | | | | ±5% | GJM1555C1H200JB01# | p157 |
| | | | ±0.1pF | GJM1555C1H8R0BB01# | p157 | 22pF | | | | ±1% | | GJM1555C1H220FB01# | p157 | |
| | | | ±0.25pF | GJM1555C1H8R0CB01# | p157 | | | | | ±2% | | GJM1555C1H220GB01# | p157 | |
| | | | 8.9pF | ±0.5pF | GJM1555C1H8R0DB01# | p157 | | | | 24pF | ±1% | GJM1555C1H240FB01# | p157 | |
| | | | | ±0.05pF | GJM1555C1H8R1WB01# | p157 | | | | | ±2% | GJM1555C1H240GB01# | p157 | |
| | | | | ±0.1pF | GJM1555C1H8R1BB01# | p157 | | | | | ±5% | GJM1555C1H240JB01# | p157 | |
| | | | | ±0.25pF | GJM1555C1H8R1CB01# | p157 | | | | | 27pF | ±1% | GJM1555C1H270FB01# | p157 |
| | | | ±0.5pF | GJM1555C1H8R1DB01# | p157 | ±2% | | | | GJM1555C1H270GB01# | | p157 | | |
| | | | ±0.05pF | GJM1555C1H8R2WB01# | p157 | ±5% | | | | GJM1555C1H270JB01# | | p157 | | |
| | | | ±0.1pF | GJM1555C1H8R2BB01# | p157 | 30pF | | | | ±1% | | GJM1555C1H300FB01# | p157 | |
| | | | ±0.25pF | GJM1555C1H8R2CB01# | p157 | | | | | ±2% | GJM1555C1H300GB01# | p157 | | |
| | | | ±0.5pF | GJM1555C1H8R2DB01# | p157 | | | | | ±5% | GJM1555C1H300JB01# | p157 | | |
| | | | ±0.05pF | GJM1555C1H8R3WB01# | p157 | | | | | 33pF | ±1% | GJM1555C1H330FB01# | p157 | |
| | | | ±0.1pF | GJM1555C1H8R3BB01# | p157 | ±2% | | | | | GJM1555C1H330GB01# | p157 | | |
| | | | ±0.25pF | GJM1555C1H8R3CB01# | p157 | ±5% | | | | | GJM1555C1H330JB01# | p157 | | |
| | | | ±0.5pF | GJM1555C1H8R3DB01# | p157 | 36pF | | | | | ±1% | GJM1555C1H360FB01# | p157 | |
| | | | ±0.05pF | GJM1555C1H8R4WB01# | p157 | | | | | ±2% | GJM1555C1H360GB01# | p157 | | |
| | | | ±0.1pF | GJM1555C1H8R4BB01# | p157 | | | | | ±5% | GJM1555C1H360JB01# | p157 | | |
| | | | ±0.25pF | GJM1555C1H8R4CB01# | p157 | | | | | 39pF | ±1% | GJM1555C1H390FB01# | p157 | |
| | | | ±0.5pF | GJM1555C1H8R4DB01# | p157 | ±2% | | | | | GJM1555C1H390GB01# | p157 | | |
| | | | ±0.05pF | GJM1555C1H8R5WB01# | p157 | ±5% | | | | | GJM1555C1H390JB01# | p157 | | |
| | | | ±0.1pF | GJM1555C1H8R5BB01# | p157 | 43pF | | | | | ±1% | GJM1555C1H430FB01# | p157 | |
| | | | ±0.25pF | GJM1555C1H8R5CB01# | p157 | | | | | ±2% | GJM1555C1H430GB01# | p157 | | |
| | | | ±0.5pF | GJM1555C1H8R5DB01# | p157 | | | | | | | | | |
| | | | ±0.05pF | GJM1555C1H8R6WB01# | p157 | | | | | | | | | |

*: Refers to the page of the "Specifications and Test Methods".

Part number # indicates the package specification code.



GJM Series Temperature Compensating Type Part Number List

(→ 1.0×0.5mm)

| T max. | Rated Voltage | TC Code | Cap. | Tol. | Part Number | p* |
|--------|---------------|---------|--------|---------|--------------------|------|
| 0.55mm | 50Vdc | COG | 43pF | ±5% | GJM1555C1H430JB01# | p157 |
| | | | | ±1% | GJM1555C1H470FB01# | p157 |
| | | | | | GJM1555C1H470GB01# | p157 |
| | | | | | GJM1555C1H470JB01# | p157 |
| | | CK | 0.10pF | ±0.05pF | GJM1554C1HR10WB01# | p157 |
| | | | | ±0.1pF | GJM1554C1HR10BB01# | p157 |
| | | | 0.20pF | ±0.05pF | GJM1554C1HR20WB01# | p157 |
| | | | | ±0.1pF | GJM1554C1HR20BB01# | p157 |
| | | | 0.30pF | ±0.05pF | GJM1554C1HR30WB01# | p157 |
| | | | | ±0.1pF | GJM1554C1HR30BB01# | p157 |
| | | | 0.40pF | ±0.05pF | GJM1554C1HR40WB01# | p157 |
| | | | | ±0.1pF | GJM1554C1HR40BB01# | p157 |
| | | | 0.50pF | ±0.05pF | GJM1554C1HR50WB01# | p157 |
| | | | | ±0.1pF | GJM1554C1HR50BB01# | p157 |
| | | | 0.60pF | ±0.05pF | GJM1554C1HR60WB01# | p157 |
| | | | | ±0.1pF | GJM1554C1HR60BB01# | p157 |
| | | | 0.70pF | ±0.05pF | GJM1554C1HR70WB01# | p157 |
| | | | | ±0.1pF | GJM1554C1HR70BB01# | p157 |
| | | | 0.80pF | ±0.05pF | GJM1554C1HR80WB01# | p157 |
| | | | | ±0.1pF | GJM1554C1HR80BB01# | p157 |
| | | | 0.90pF | ±0.05pF | GJM1554C1HR90WB01# | p157 |
| | | | | ±0.1pF | GJM1554C1HR90BB01# | p157 |
| | | | 1.0pF | ±0.05pF | GJM1554C1H1R0WB01# | p157 |
| | | | | ±0.1pF | GJM1554C1H1R0BB01# | p157 |
| | | | | ±0.25pF | GJM1554C1H1R0CB01# | p157 |
| | | | 1.1pF | ±0.05pF | GJM1554C1H1R1WB01# | p157 |
| | | | | ±0.1pF | GJM1554C1H1R1BB01# | p157 |
| | | | | ±0.25pF | GJM1554C1H1R1CB01# | p157 |
| | | | 1.2pF | ±0.05pF | GJM1554C1H1R2WB01# | p157 |
| | | | | ±0.1pF | GJM1554C1H1R2BB01# | p157 |
| | | | | ±0.25pF | GJM1554C1H1R2CB01# | p157 |
| | | | 1.3pF | ±0.05pF | GJM1554C1H1R3WB01# | p157 |
| | | | | ±0.1pF | GJM1554C1H1R3BB01# | p157 |
| | | | | ±0.25pF | GJM1554C1H1R3CB01# | p157 |
| | | | 1.4pF | ±0.05pF | GJM1554C1H1R4WB01# | p157 |
| | | | | ±0.1pF | GJM1554C1H1R4BB01# | p157 |
| | | | | ±0.25pF | GJM1554C1H1R4CB01# | p157 |
| | | | 1.5pF | ±0.05pF | GJM1554C1H1R5WB01# | p157 |
| | | | | ±0.1pF | GJM1554C1H1R5BB01# | p157 |
| | | | | ±0.25pF | GJM1554C1H1R5CB01# | p157 |
| | | | 1.6pF | ±0.05pF | GJM1554C1H1R6WB01# | p157 |
| | | | | ±0.1pF | GJM1554C1H1R6BB01# | p157 |
| | | | | ±0.25pF | GJM1554C1H1R6CB01# | p157 |
| | | | 1.7pF | ±0.05pF | GJM1554C1H1R7WB01# | p157 |
| | | | | ±0.1pF | GJM1554C1H1R7BB01# | p157 |
| | | | | ±0.25pF | GJM1554C1H1R7CB01# | p157 |
| | | | 1.8pF | ±0.05pF | GJM1554C1H1R8WB01# | p157 |
| | | | | ±0.1pF | GJM1554C1H1R8BB01# | p157 |
| | | | | ±0.25pF | GJM1554C1H1R8CB01# | p157 |
| | | | 1.9pF | ±0.05pF | GJM1554C1H1R9WB01# | p157 |
| | | | | ±0.1pF | GJM1554C1H1R9BB01# | p157 |
| | | | | ±0.25pF | GJM1554C1H1R9CB01# | p157 |
| | | | 2.0pF | ±0.05pF | GJM1554C1H2R0WB01# | p157 |
| | | | | ±0.1pF | GJM1554C1H2R0BB01# | p157 |

| T max. | Rated Voltage | TC Code | Cap. | Tol. | Part Number | p* |
|--------|---------------|---------|--------------------|--------------------|--------------------|---------|
| 0.55mm | 50Vdc | CK | 2.0pF | ±0.25pF | GJM1554C1H2ROCB01# | p157 |
| | | | | CJ | 2.1pF | ±0.05pF |
| | | ±0.1pF | GJM1553C1H2R1BB01# | p157 | | |
| | | ±0.25pF | GJM1553C1H2R1CB01# | p157 | | |
| | | 2.2pF | ±0.05pF | GJM1553C1H2R2WB01# | p157 | |
| | | | ±0.1pF | GJM1553C1H2R2BB01# | p157 | |
| | | | ±0.25pF | GJM1553C1H2R2CB01# | p157 | |
| | | 2.3pF | ±0.05pF | GJM1553C1H2R3WB01# | p157 | |
| | | | ±0.1pF | GJM1553C1H2R3BB01# | p157 | |
| | | | ±0.25pF | GJM1553C1H2R3CB01# | p157 | |
| | | 2.4pF | ±0.05pF | GJM1553C1H2R4WB01# | p157 | |
| | | | ±0.1pF | GJM1553C1H2R4BB01# | p157 | |
| | | | ±0.25pF | GJM1553C1H2R4CB01# | p157 | |
| | | 2.5pF | ±0.05pF | GJM1553C1H2R5WB01# | p157 | |
| | | | ±0.1pF | GJM1553C1H2R5BB01# | p157 | |
| | | | ±0.25pF | GJM1553C1H2R5CB01# | p157 | |
| | | 2.6pF | ±0.05pF | GJM1553C1H2R6WB01# | p157 | |
| | | | ±0.1pF | GJM1553C1H2R6BB01# | p157 | |
| | | | ±0.25pF | GJM1553C1H2R6CB01# | p157 | |
| | | 2.7pF | ±0.05pF | GJM1553C1H2R7WB01# | p157 | |
| | | | ±0.1pF | GJM1553C1H2R7BB01# | p157 | |
| | | | ±0.25pF | GJM1553C1H2R7CB01# | p157 | |
| | | 2.8pF | ±0.05pF | GJM1553C1H2R8WB01# | p157 | |
| | | | ±0.1pF | GJM1553C1H2R8BB01# | p157 | |
| | | | ±0.25pF | GJM1553C1H2R8CB01# | p157 | |
| | | 2.9pF | ±0.05pF | GJM1553C1H2R9WB01# | p157 | |
| | | | ±0.1pF | GJM1553C1H2R9BB01# | p157 | |
| | | | ±0.25pF | GJM1553C1H2R9CB01# | p157 | |
| | | 3.0pF | ±0.05pF | GJM1553C1H3R0WB01# | p157 | |
| | | | ±0.1pF | GJM1553C1H3R0BB01# | p157 | |
| | | | ±0.25pF | GJM1553C1H3R0CB01# | p157 | |
| | | 3.1pF | ±0.05pF | GJM1553C1H3R1WB01# | p157 | |
| | | | ±0.1pF | GJM1553C1H3R1BB01# | p157 | |
| | | | ±0.25pF | GJM1553C1H3R1CB01# | p157 | |
| | | 3.2pF | ±0.05pF | GJM1553C1H3R2WB01# | p157 | |
| | | | ±0.1pF | GJM1553C1H3R2BB01# | p157 | |
| | | | ±0.25pF | GJM1553C1H3R2CB01# | p157 | |
| | | 3.3pF | ±0.05pF | GJM1553C1H3R3WB01# | p157 | |
| | | | ±0.1pF | GJM1553C1H3R3BB01# | p157 | |
| | | | ±0.25pF | GJM1553C1H3R3CB01# | p157 | |
| | | 3.4pF | ±0.05pF | GJM1553C1H3R4WB01# | p157 | |
| | | | ±0.1pF | GJM1553C1H3R4BB01# | p157 | |
| | | | ±0.25pF | GJM1553C1H3R4CB01# | p157 | |
| | | 3.5pF | ±0.05pF | GJM1553C1H3R5WB01# | p157 | |
| | | | ±0.1pF | GJM1553C1H3R5BB01# | p157 | |
| | | | ±0.25pF | GJM1553C1H3R5CB01# | p157 | |
| | | 3.6pF | ±0.05pF | GJM1553C1H3R6WB01# | p157 | |
| | | | ±0.1pF | GJM1553C1H3R6BB01# | p157 | |
| | | | ±0.25pF | GJM1553C1H3R6CB01# | p157 | |
| | | 3.7pF | ±0.05pF | GJM1553C1H3R7WB01# | p157 | |
| | | | ±0.1pF | GJM1553C1H3R7BB01# | p157 | |
| | | | ±0.25pF | GJM1553C1H3R7CB01# | p157 | |
| | | 3.8pF | ±0.05pF | GJM1553C1H3R8WB01# | p157 | |
| | | | ±0.1pF | GJM1553C1H3R8BB01# | p157 | |

*: Refers to the page of the "Specifications and Test Methods".

Part number # indicates the package specification code.

GJM Series Temperature Compensating Type Part Number List

(→ 1.0×0.5mm)

| T max. | Rated Voltage | TC Code | Cap. | Tol. | Part Number | p* | T max. | Rated Voltage | TC Code | Cap. | Tol. | Part Number | p* |
|--------|---------------|---------|--------------------|--------------------|--------------------|---------|--------|---------------|---------|--------------------|--------------------|--------------------|--------------------|
| 0.55mm | 50Vdc | CJ | 3.8pF | ±0.25pF | GJM1553C1H3R8CB01# | p157 | 0.55mm | 50Vdc | CH | 5.5pF | ±0.1pF | GJM1552C1H5R5BB01# | p157 |
| | | | | ±0.05pF | GJM1553C1H3R9WB01# | p157 | | | | | ±0.25pF | GJM1552C1H5R5CB01# | p157 |
| | | | | ±0.1pF | GJM1553C1H3R9BB01# | p157 | | | | | ±0.5pF | GJM1552C1H5R5DB01# | p157 |
| | | | | ±0.25pF | GJM1553C1H3R9CB01# | p157 | | | | | 5.6pF | ±0.05pF | GJM1552C1H5R6WB01# |
| | | 4.0pF | ±0.05pF | GJM1552C1H4R0WB01# | p157 | ±0.1pF | | | | GJM1552C1H5R6BB01# | | p157 | |
| | | | ±0.1pF | GJM1552C1H4R0BB01# | p157 | ±0.25pF | | | | GJM1552C1H5R6CB01# | | p157 | |
| | | | ±0.25pF | GJM1552C1H4R0CB01# | p157 | ±0.5pF | | | | GJM1552C1H5R6DB01# | | p157 | |
| | | 4.1pF | ±0.05pF | GJM1552C1H4R1WB01# | p157 | 5.7pF | | | | ±0.05pF | GJM1552C1H5R7WB01# | p157 | |
| | | | ±0.1pF | GJM1552C1H4R1BB01# | p157 | | | | | ±0.1pF | GJM1552C1H5R7BB01# | p157 | |
| | | | ±0.25pF | GJM1552C1H4R1CB01# | p157 | | | | | ±0.25pF | GJM1552C1H5R7CB01# | p157 | |
| | | 4.2pF | ±0.05pF | GJM1552C1H4R2WB01# | p157 | | | | | ±0.5pF | GJM1552C1H5R7DB01# | p157 | |
| | | | ±0.1pF | GJM1552C1H4R2BB01# | p157 | 5.8pF | | | | ±0.05pF | GJM1552C1H5R8WB01# | p157 | |
| | | | ±0.25pF | GJM1552C1H4R2CB01# | p157 | | | | | ±0.1pF | GJM1552C1H5R8BB01# | p157 | |
| | | 4.3pF | ±0.05pF | GJM1552C1H4R3WB01# | p157 | | | | | ±0.25pF | GJM1552C1H5R8CB01# | p157 | |
| | | | ±0.1pF | GJM1552C1H4R3BB01# | p157 | | | | | ±0.5pF | GJM1552C1H5R8DB01# | p157 | |
| | | | ±0.25pF | GJM1552C1H4R3CB01# | p157 | 5.9pF | | | | ±0.05pF | GJM1552C1H5R9WB01# | p157 | |
| | | 4.4pF | ±0.05pF | GJM1552C1H4R4WB01# | p157 | | | | | ±0.1pF | GJM1552C1H5R9BB01# | p157 | |
| | | | ±0.1pF | GJM1552C1H4R4BB01# | p157 | | | | | ±0.25pF | GJM1552C1H5R9CB01# | p157 | |
| | | | ±0.25pF | GJM1552C1H4R4CB01# | p157 | | | | | ±0.5pF | GJM1552C1H5R9DB01# | p157 | |
| | | 4.5pF | ±0.05pF | GJM1552C1H4R5WB01# | p157 | 6.0pF | | | | ±0.05pF | GJM1552C1H6R0WB01# | p157 | |
| | | | ±0.1pF | GJM1552C1H4R5BB01# | p157 | | | | | ±0.1pF | GJM1552C1H6R0BB01# | p157 | |
| | | | ±0.25pF | GJM1552C1H4R5CB01# | p157 | | | | | ±0.25pF | GJM1552C1H6R0CB01# | p157 | |
| | | 4.6pF | ±0.05pF | GJM1552C1H4R6WB01# | p157 | | | | | ±0.5pF | GJM1552C1H6R0DB01# | p157 | |
| | | | ±0.1pF | GJM1552C1H4R6BB01# | p157 | 6.1pF | | | | ±0.05pF | GJM1552C1H6R1WB01# | p157 | |
| | | | ±0.25pF | GJM1552C1H4R6CB01# | p157 | | | | | ±0.1pF | GJM1552C1H6R1BB01# | p157 | |
| | | 4.7pF | ±0.05pF | GJM1552C1H4R7WB01# | p157 | | | | | ±0.25pF | GJM1552C1H6R1CB01# | p157 | |
| | | | ±0.1pF | GJM1552C1H4R7BB01# | p157 | | | | | ±0.5pF | GJM1552C1H6R1DB01# | p157 | |
| | | | ±0.25pF | GJM1552C1H4R7CB01# | p157 | 6.2pF | | | | ±0.05pF | GJM1552C1H6R2WB01# | p157 | |
| | | 4.8pF | ±0.05pF | GJM1552C1H4R8WB01# | p157 | | | | | ±0.1pF | GJM1552C1H6R2BB01# | p157 | |
| | | | ±0.1pF | GJM1552C1H4R8BB01# | p157 | | | | | ±0.25pF | GJM1552C1H6R2CB01# | p157 | |
| | | | ±0.25pF | GJM1552C1H4R8CB01# | p157 | | | | | ±0.5pF | GJM1552C1H6R2DB01# | p157 | |
| | | 4.9pF | ±0.05pF | GJM1552C1H4R9WB01# | p157 | 6.3pF | | | | ±0.05pF | GJM1552C1H6R3WB01# | p157 | |
| | | | ±0.1pF | GJM1552C1H4R9BB01# | p157 | | | | | ±0.1pF | GJM1552C1H6R3BB01# | p157 | |
| | | | ±0.25pF | GJM1552C1H4R9CB01# | p157 | | | | | ±0.25pF | GJM1552C1H6R3CB01# | p157 | |
| | | 5.0pF | ±0.05pF | GJM1552C1H5R0WB01# | p157 | | | | | ±0.5pF | GJM1552C1H6R3DB01# | p157 | |
| | | | ±0.1pF | GJM1552C1H5R0BB01# | p157 | 6.4pF | | | | ±0.05pF | GJM1552C1H6R4WB01# | p157 | |
| | | | ±0.25pF | GJM1552C1H5R0CB01# | p157 | | | | | ±0.1pF | GJM1552C1H6R4BB01# | p157 | |
| | | 5.1pF | ±0.05pF | GJM1552C1H5R1WB01# | p157 | | | | | ±0.25pF | GJM1552C1H6R4CB01# | p157 | |
| | | | ±0.1pF | GJM1552C1H5R1BB01# | p157 | | | | | ±0.5pF | GJM1552C1H6R4DB01# | p157 | |
| | | | ±0.25pF | GJM1552C1H5R1CB01# | p157 | 6.5pF | | | | ±0.05pF | GJM1552C1H6R5WB01# | p157 | |
| | | ±0.5pF | GJM1552C1H5R1DB01# | p157 | ±0.1pF | | | | | GJM1552C1H6R5BB01# | p157 | | |
| | | 5.2pF | ±0.05pF | GJM1552C1H5R2WB01# | p157 | | | | | ±0.25pF | GJM1552C1H6R5CB01# | p157 | |
| | | | ±0.1pF | GJM1552C1H5R2BB01# | p157 | | | | | ±0.5pF | GJM1552C1H6R5DB01# | p157 | |
| | | | ±0.25pF | GJM1552C1H5R2CB01# | p157 | 6.6pF | | | | ±0.05pF | GJM1552C1H6R6WB01# | p157 | |
| | | ±0.5pF | GJM1552C1H5R2DB01# | p157 | ±0.1pF | | | | | GJM1552C1H6R6BB01# | p157 | | |
| | | 5.3pF | ±0.05pF | GJM1552C1H5R3WB01# | p157 | | | | | ±0.25pF | GJM1552C1H6R6CB01# | p157 | |
| | | | ±0.1pF | GJM1552C1H5R3BB01# | p157 | | | | | ±0.5pF | GJM1552C1H6R6DB01# | p157 | |
| | | | ±0.25pF | GJM1552C1H5R3CB01# | p157 | 6.7pF | | | | ±0.05pF | GJM1552C1H6R7WB01# | p157 | |
| | | ±0.5pF | GJM1552C1H5R3DB01# | p157 | ±0.1pF | | | | | GJM1552C1H6R7BB01# | p157 | | |
| | | 5.4pF | ±0.05pF | GJM1552C1H5R4WB01# | p157 | | | | | ±0.25pF | GJM1552C1H6R7CB01# | p157 | |
| | | | ±0.1pF | GJM1552C1H5R4BB01# | p157 | | | | | ±0.5pF | GJM1552C1H6R7DB01# | p157 | |
| | | | ±0.25pF | GJM1552C1H5R4CB01# | p157 | 6.8pF | | | | ±0.05pF | GJM1552C1H6R8WB01# | p157 | |
| | | ±0.5pF | GJM1552C1H5R4DB01# | p157 | ±0.1pF | | | | | GJM1552C1H6R8BB01# | p157 | | |
| | | 5.5pF | ±0.05pF | GJM1552C1H5R5WB01# | p157 | | | | | ±0.25pF | GJM1552C1H6R8CB01# | p157 | |

*: Refers to the page of the "Specifications and Test Methods".

Part number # indicates the package specification code.

GJM Series Temperature Compensating Type Part Number List

(→ 1.0×0.5mm)

| T max. | Rated Voltage | TC Code | Cap. | Tol. | Part Number | p* | T max. | Rated Voltage | TC Code | Cap. | Tol. | Part Number | p* |
|--------|---------------|---------|-------|---------|--------------------|------|--------|---------------|--------------------|-------|---------|--------------------|------|
| 0.55mm | 50Vdc | CH | 6.8pF | ±0.5pF | GJM1552C1H6R8DB01# | p157 | 0.55mm | 50Vdc | CH | 8.2pF | ±0.1pF | GJM1552C1H8R2BB01# | p157 |
| | | | | ±0.05pF | GJM1552C1H6R9WB01# | p157 | | | | | ±0.25pF | GJM1552C1H8R2CB01# | p157 |
| | | | 6.9pF | ±0.1pF | GJM1552C1H6R9BB01# | p157 | 8.3pF | ±0.05pF | GJM1552C1H8R3WB01# | p157 | | | |
| | | | | ±0.25pF | GJM1552C1H6R9CB01# | p157 | | ±0.1pF | GJM1552C1H8R3BB01# | p157 | | | |
| | | | | ±0.5pF | GJM1552C1H6R9DB01# | p157 | | ±0.25pF | GJM1552C1H8R3CB01# | p157 | | | |
| | | | | ±0.05pF | GJM1552C1H7R0WB01# | p157 | | ±0.5pF | GJM1552C1H8R3DB01# | p157 | | | |
| | | | 7.0pF | ±0.1pF | GJM1552C1H7R0BB01# | p157 | 8.4pF | ±0.05pF | GJM1552C1H8R4WB01# | p157 | | | |
| | | | | ±0.25pF | GJM1552C1H7R0CB01# | p157 | | ±0.1pF | GJM1552C1H8R4BB01# | p157 | | | |
| | | | | ±0.5pF | GJM1552C1H7R0DB01# | p157 | | ±0.25pF | GJM1552C1H8R4CB01# | p157 | | | |
| | | | | ±0.05pF | GJM1552C1H7R1WB01# | p157 | | ±0.5pF | GJM1552C1H8R4DB01# | p157 | | | |
| | | | 7.1pF | ±0.1pF | GJM1552C1H7R1BB01# | p157 | 8.5pF | ±0.05pF | GJM1552C1H8R5WB01# | p157 | | | |
| | | | | ±0.25pF | GJM1552C1H7R1CB01# | p157 | | ±0.1pF | GJM1552C1H8R5BB01# | p157 | | | |
| | | | | ±0.5pF | GJM1552C1H7R1DB01# | p157 | | ±0.25pF | GJM1552C1H8R5CB01# | p157 | | | |
| | | | | ±0.05pF | GJM1552C1H7R2WB01# | p157 | | ±0.5pF | GJM1552C1H8R5DB01# | p157 | | | |
| | | | 7.2pF | ±0.1pF | GJM1552C1H7R2BB01# | p157 | 8.6pF | ±0.05pF | GJM1552C1H8R6WB01# | p157 | | | |
| | | | | ±0.25pF | GJM1552C1H7R2CB01# | p157 | | ±0.1pF | GJM1552C1H8R6BB01# | p157 | | | |
| | | | | ±0.5pF | GJM1552C1H7R2DB01# | p157 | | ±0.25pF | GJM1552C1H8R6CB01# | p157 | | | |
| | | | | ±0.05pF | GJM1552C1H7R3WB01# | p157 | | ±0.5pF | GJM1552C1H8R6DB01# | p157 | | | |
| | | | 7.3pF | ±0.1pF | GJM1552C1H7R3BB01# | p157 | 8.7pF | ±0.05pF | GJM1552C1H8R7WB01# | p157 | | | |
| | | | | ±0.25pF | GJM1552C1H7R3CB01# | p157 | | ±0.1pF | GJM1552C1H8R7BB01# | p157 | | | |
| | | | | ±0.5pF | GJM1552C1H7R3DB01# | p157 | | ±0.25pF | GJM1552C1H8R7CB01# | p157 | | | |
| | | | | ±0.05pF | GJM1552C1H7R4WB01# | p157 | | ±0.5pF | GJM1552C1H8R7DB01# | p157 | | | |
| | | | 7.4pF | ±0.1pF | GJM1552C1H7R4BB01# | p157 | 8.8pF | ±0.05pF | GJM1552C1H8R8WB01# | p157 | | | |
| | | | | ±0.25pF | GJM1552C1H7R4CB01# | p157 | | ±0.1pF | GJM1552C1H8R8BB01# | p157 | | | |
| | | | | ±0.5pF | GJM1552C1H7R4DB01# | p157 | | ±0.25pF | GJM1552C1H8R8CB01# | p157 | | | |
| | | | | ±0.05pF | GJM1552C1H7R5WB01# | p157 | | ±0.5pF | GJM1552C1H8R8DB01# | p157 | | | |
| | | | 7.5pF | ±0.1pF | GJM1552C1H7R5BB01# | p157 | 8.9pF | ±0.05pF | GJM1552C1H8R9WB01# | p157 | | | |
| | | | | ±0.25pF | GJM1552C1H7R5CB01# | p157 | | ±0.1pF | GJM1552C1H8R9BB01# | p157 | | | |
| | | | | ±0.5pF | GJM1552C1H7R5DB01# | p157 | | ±0.25pF | GJM1552C1H8R9CB01# | p157 | | | |
| | | | | ±0.05pF | GJM1552C1H7R6WB01# | p157 | | ±0.5pF | GJM1552C1H8R9DB01# | p157 | | | |
| | | | 7.6pF | ±0.1pF | GJM1552C1H7R6BB01# | p157 | 9.0pF | ±0.05pF | GJM1552C1H9R0WB01# | p157 | | | |
| | | | | ±0.25pF | GJM1552C1H7R6CB01# | p157 | | ±0.1pF | GJM1552C1H9R0BB01# | p157 | | | |
| | | | | ±0.5pF | GJM1552C1H7R6DB01# | p157 | | ±0.25pF | GJM1552C1H9R0CB01# | p157 | | | |
| | | | | ±0.05pF | GJM1552C1H7R7WB01# | p157 | | ±0.5pF | GJM1552C1H9R0DB01# | p157 | | | |
| | | | 7.7pF | ±0.1pF | GJM1552C1H7R7BB01# | p157 | 9.1pF | ±0.05pF | GJM1552C1H9R1WB01# | p157 | | | |
| | | | | ±0.25pF | GJM1552C1H7R7CB01# | p157 | | ±0.1pF | GJM1552C1H9R1BB01# | p157 | | | |
| | | | | ±0.5pF | GJM1552C1H7R7DB01# | p157 | | ±0.25pF | GJM1552C1H9R1CB01# | p157 | | | |
| | | | | ±0.05pF | GJM1552C1H7R8WB01# | p157 | | ±0.5pF | GJM1552C1H9R1DB01# | p157 | | | |
| | | | 7.8pF | ±0.1pF | GJM1552C1H7R8BB01# | p157 | 9.2pF | ±0.05pF | GJM1552C1H9R2WB01# | p157 | | | |
| | | | | ±0.25pF | GJM1552C1H7R8CB01# | p157 | | ±0.1pF | GJM1552C1H9R2BB01# | p157 | | | |
| | | | | ±0.5pF | GJM1552C1H7R8DB01# | p157 | | ±0.25pF | GJM1552C1H9R2CB01# | p157 | | | |
| | | | | ±0.05pF | GJM1552C1H7R9WB01# | p157 | | ±0.5pF | GJM1552C1H9R2DB01# | p157 | | | |
| | | | 7.9pF | ±0.1pF | GJM1552C1H7R9BB01# | p157 | 9.3pF | ±0.05pF | GJM1552C1H9R3WB01# | p157 | | | |
| | | | | ±0.25pF | GJM1552C1H7R9CB01# | p157 | | ±0.1pF | GJM1552C1H9R3BB01# | p157 | | | |
| | | | | ±0.5pF | GJM1552C1H7R9DB01# | p157 | | ±0.25pF | GJM1552C1H9R3CB01# | p157 | | | |
| | | | | ±0.05pF | GJM1552C1H8R0WB01# | p157 | | ±0.5pF | GJM1552C1H9R3DB01# | p157 | | | |
| | | | 8.0pF | ±0.1pF | GJM1552C1H8R0BB01# | p157 | 9.4pF | ±0.05pF | GJM1552C1H9R4WB01# | p157 | | | |
| | | | | ±0.25pF | GJM1552C1H8R0CB01# | p157 | | ±0.1pF | GJM1552C1H9R4BB01# | p157 | | | |
| | | | | ±0.5pF | GJM1552C1H8R0DB01# | p157 | | ±0.25pF | GJM1552C1H9R4CB01# | p157 | | | |
| | | | | ±0.05pF | GJM1552C1H8R1WB01# | p157 | | ±0.5pF | GJM1552C1H9R4DB01# | p157 | | | |
| | | | 8.1pF | ±0.1pF | GJM1552C1H8R1BB01# | p157 | 9.5pF | ±0.05pF | GJM1552C1H9R5WB01# | p157 | | | |
| | | | | ±0.25pF | GJM1552C1H8R1CB01# | p157 | | ±0.1pF | GJM1552C1H9R5BB01# | p157 | | | |
| | | | | ±0.5pF | GJM1552C1H8R1DB01# | p157 | | ±0.25pF | GJM1552C1H9R5CB01# | p157 | | | |
| | | | | ±0.05pF | GJM1552C1H8R2WB01# | p157 | | | | | | | |

*: Refers to the page of the "Specifications and Test Methods".

Part number # indicates the package specification code.

GJM Series Temperature Compensating Type Part Number List

(→ 1.0×0.5mm)

| T max. | Rated Voltage | TC Code | Cap. | Tol. | Part Number | p* |
|--------|---------------|---------|-------|---------|--------------------|------|
| 0.55mm | 50Vdc | CH | 9.5pF | ±0.5pF | GJM1552C1H9R5DB01# | p157 |
| | | | 9.6pF | ±0.05pF | GJM1552C1H9R6WB01# | p157 |
| | | | | ±0.1pF | GJM1552C1H9R6BB01# | p157 |
| | | | | ±0.25pF | GJM1552C1H9R6CB01# | p157 |
| | | | | ±0.5pF | GJM1552C1H9R6DB01# | p157 |
| | | | 9.7pF | ±0.05pF | GJM1552C1H9R7WB01# | p157 |
| | | | | ±0.1pF | GJM1552C1H9R7BB01# | p157 |
| | | | | ±0.25pF | GJM1552C1H9R7CB01# | p157 |
| | | | 9.8pF | ±0.05pF | GJM1552C1H9R8WB01# | p157 |
| | | | | ±0.1pF | GJM1552C1H9R8BB01# | p157 |
| | | | | ±0.25pF | GJM1552C1H9R8CB01# | p157 |
| | | | 9.9pF | ±0.05pF | GJM1552C1H9R9WB01# | p157 |
| | | | | ±0.1pF | GJM1552C1H9R9BB01# | p157 |
| | | | | ±0.25pF | GJM1552C1H9R9CB01# | p157 |
| | | | | ±0.5pF | GJM1552C1H9R9DB01# | p157 |
| | | | 10pF | ±2% | GJM1552C1H100GB01# | p157 |
| | | | | ±5% | GJM1552C1H100JB01# | p157 |
| | | | 11pF | ±2% | GJM1552C1H110GB01# | p157 |
| | | | | ±5% | GJM1552C1H110JB01# | p157 |
| | | | 12pF | ±2% | GJM1552C1H120GB01# | p157 |
| | | | | ±5% | GJM1552C1H120JB01# | p157 |
| | | | 13pF | ±2% | GJM1552C1H130GB01# | p157 |
| | | | | ±5% | GJM1552C1H130JB01# | p157 |
| | | | 15pF | ±2% | GJM1552C1H150GB01# | p157 |
| | | | | ±5% | GJM1552C1H150JB01# | p157 |
| | | | 16pF | ±2% | GJM1552C1H160GB01# | p157 |
| | | | | ±5% | GJM1552C1H160JB01# | p157 |
| | | | 18pF | ±2% | GJM1552C1H180GB01# | p157 |
| | | | | ±5% | GJM1552C1H180JB01# | p157 |
| | | | 20pF | ±2% | GJM1552C1H200GB01# | p157 |
| | | | | ±5% | GJM1552C1H200JB01# | p157 |
| | | | 22pF | ±1% | GJM1552C1H220FB01# | p157 |
| | | | | ±2% | GJM1552C1H220GB01# | p157 |
| | | | | ±5% | GJM1552C1H220JB01# | p157 |
| | | | 24pF | ±1% | GJM1552C1H240FB01# | p157 |
| | | | | ±2% | GJM1552C1H240GB01# | p157 |
| | | | | ±5% | GJM1552C1H240JB01# | p157 |
| | | | 27pF | ±1% | GJM1552C1H270FB01# | p157 |
| | | | | ±2% | GJM1552C1H270GB01# | p157 |
| | | | | ±5% | GJM1552C1H270JB01# | p157 |
| | | | 30pF | ±1% | GJM1552C1H300FB01# | p157 |
| | | | | ±2% | GJM1552C1H300GB01# | p157 |
| | | | | ±5% | GJM1552C1H300JB01# | p157 |
| | | | 33pF | ±1% | GJM1552C1H330FB01# | p157 |
| | | | | ±2% | GJM1552C1H330GB01# | p157 |
| | | | | ±5% | GJM1552C1H330JB01# | p157 |
| | | | 36pF | ±1% | GJM1552C1H360FB01# | p157 |
| | | | | ±2% | GJM1552C1H360GB01# | p157 |
| | | | | ±5% | GJM1552C1H360JB01# | p157 |
| | | | 39pF | ±1% | GJM1552C1H390FB01# | p157 |
| | | | | ±2% | GJM1552C1H390GB01# | p157 |
| | | | | ±5% | GJM1552C1H390JB01# | p157 |

| T max. | Rated Voltage | TC Code | Cap. | Tol. | Part Number | p* |
|--------|---------------|---------|------|------|--------------------|------|
| 0.55mm | 50Vdc | CH | 43pF | ±1% | GJM1552C1H430FB01# | p157 |
| | | | | ±2% | GJM1552C1H430GB01# | p157 |
| | | | | ±5% | GJM1552C1H430JB01# | p157 |
| | | | 47pF | ±1% | GJM1552C1H470FB01# | p157 |
| | | | | ±2% | GJM1552C1H470GB01# | p157 |
| | | | | ±5% | GJM1552C1H470JB01# | p157 |

*: Refers to the page of the "Specifications and Test Methods".

Part number # indicates the package specification code.



1

GJM Series Specifications and Test Methods (1)

| No | Item | Specification | Test Method (Ref. Standard: JIS C 5101, IEC60384) | | | | | | | | | | | | |
|------------------------|--|---|---|-------------|-------------------|---------|------------------------|------------|-------------------------|-------|--------------------|---|-------------------------|---|--------------------|
| 1 | Rated Voltage | Shown in Rated value. | The rated voltage is defined as the maximum voltage which may be applied continuously to the capacitor. When AC voltage is superimposed on DC voltage, V^P -P or V^O -P, whichever is larger, should be maintained within the rated voltage range. | | | | | | | | | | | | |
| 2 | Appearance | No defects or abnormalities. | Visual inspection. | | | | | | | | | | | | |
| 3 | Dimension | Within the specified dimensions. | Using Measuring instrument of dimension. | | | | | | | | | | | | |
| 4 | Impulse Voltage | No defects or abnormalities. | Measurement Point: Between the terminations Test Voltage: 300% of the rated voltage Applied Time: 1 to 5s Charge/discharge current: 50mA max. | | | | | | | | | | | | |
| 5 | Insulation Resistance (I.R.) | $C \leq 0.047\mu\text{F}$: More than 10000MΩ $C > 0.047\mu\text{F}$: More than $500\Omega \cdot \text{F}$ C: Nominal Capacitance | Measurement Point: Between the terminations Measurement Voltage: DC Rated Voltage Charging Time: 2min Charge/discharge current: 50mA max. Measurement Temperature: Room Temperature | | | | | | | | | | | | |
| 6 | Capacitance | Shown in Rated value. | Measurement Temperature: Room Temperature | | | | | | | | | | | | |
| 7 | Q | 30pF and over: $Q \geq 1000$ 30pF and below: $Q \geq 400+20C$ C: Nominal Capacitance (pF) | <table border="1"> <thead> <tr> <th>Capacitance</th> <th>Frequency</th> <th>Voltage</th> </tr> </thead> <tbody> <tr> <td>$C \leq 1000\text{pF}$</td> <td>1.0±0.1MHz</td> <td>0.5 to 5.0Vrms</td> </tr> </tbody> </table> | Capacitance | Frequency | Voltage | $C \leq 1000\text{pF}$ | 1.0±0.1MHz | 0.5 to 5.0Vrms | | | | | | |
| Capacitance | Frequency | Voltage | | | | | | | | | | | | | |
| $C \leq 1000\text{pF}$ | 1.0±0.1MHz | 0.5 to 5.0Vrms | | | | | | | | | | | | | |
| 8 | Temperature Characteristics of Capacitance | Nominal values of the temperature coefficient is shown in Rated value. But, the Capacitance Change under 20°C is shown in Table A. Capacitance Drift Within ±0.2% or ±0.05pF (Whichever is larger.) | The capacitance change should be measured after 5 minutes at each specified temp. stage. Capacitance value as a reference is the value in step 3. The capacitance drift is calculated by dividing the differences between the maximum and minimum measured values in the step 1, 3 and 5 by the cap. value in step 3. <table border="1"> <thead> <tr> <th>Step</th> <th>Temperature (°C)</th> </tr> </thead> <tbody> <tr> <td>1</td> <td>Reference Temp. ±2</td> </tr> <tr> <td>2</td> <td>Min. Operating Temp. ±3</td> </tr> <tr> <td>3</td> <td>Reference Temp. ±2</td> </tr> <tr> <td>4</td> <td>Max. Operating Temp. ±3</td> </tr> <tr> <td>5</td> <td>Reference Temp. ±2</td> </tr> </tbody> </table> | Step | Temperature (°C) | 1 | Reference Temp. ±2 | 2 | Min. Operating Temp. ±3 | 3 | Reference Temp. ±2 | 4 | Max. Operating Temp. ±3 | 5 | Reference Temp. ±2 |
| Step | Temperature (°C) | | | | | | | | | | | | | | |
| 1 | Reference Temp. ±2 | | | | | | | | | | | | | | |
| 2 | Min. Operating Temp. ±3 | | | | | | | | | | | | | | |
| 3 | Reference Temp. ±2 | | | | | | | | | | | | | | |
| 4 | Max. Operating Temp. ±3 | | | | | | | | | | | | | | |
| 5 | Reference Temp. ±2 | | | | | | | | | | | | | | |
| 9 | Adhesive Strength of Termination | No removal of the terminations or other defect should occur. | Solder the capacitor on the test substrate shown in Fig.3. <table border="1"> <thead> <tr> <th>Type</th> <th>Applied Force (N)</th> </tr> </thead> <tbody> <tr> <td>GJM02</td> <td>1</td> </tr> <tr> <td>GJM03</td> <td>2</td> </tr> <tr> <td>GJM15</td> <td>5</td> </tr> </tbody> </table> Holding Time: 10±1s Applied Direction: In parallel with the test substrate and vertical with the capacitor side. | Type | Applied Force (N) | GJM02 | 1 | GJM03 | 2 | GJM15 | 5 | | | | |
| Type | Applied Force (N) | | | | | | | | | | | | | | |
| GJM02 | 1 | | | | | | | | | | | | | | |
| GJM03 | 2 | | | | | | | | | | | | | | |
| GJM15 | 5 | | | | | | | | | | | | | | |
| 10 | Vibration | Appearance | Solder the capacitor on the test substrate shown in Fig.3. Kind of Vibration: A simple harmonic motion 10Hz to 55Hz to 10Hz (1min) Total amplitude: 1.5mm This motion should be applied for a period of 2h in each 3 mutually perpendicular directions (total of 6h). | | | | | | | | | | | | |
| | | Capacitance | | | | | | | | | | | | | |
| | | Q | | | | | | | | | | | | | |
| 11 | Substrate Bending Test | Appearance | Solder the capacitor on the test substrate shown in Fig.1. Pressurization method: Shown in Fig.2 Flexure: 1mm Holding Time: 5±1s Soldering Method: Reflow soldering | | | | | | | | | | | | |
| | | Capacitance Change | | | | | | | | | | | | | |
| 12 | Solderability | 95% of the terminations is to be soldered evenly and continuously. | Test Method: Solder bath method Flux: Solution of rosin ethanol 25 (mass)% Preheat: 80 to 120°C for 10 to 30s Solder: Sn-3.0Ag-0.5Cu Solder Temp.: 245±5°C Immersion time: 2±0.5s | | | | | | | | | | | | |

Continued on the following page. ↗

GRM
 GR3
 GRJ
 GR4
 GR7
 GJM
 GQM
 GA2
 GA3 GB
 GA3 GD
 GA3 GF
 LLL
 LLA
 LLM
 LLR
 NFM
 KPM
 KR3
 GMA
 GMD
 ⚠Caution / Notice

GJM Series Specifications and Test Methods (1)

Continued from the preceding page. ↘

| No | Item | Specification | Test Method (Ref. Standard: JIS C 5101, IEC60384) | | | | | | | | | | | | | | | |
|------|---|--|---|---|------------|------------|---|----------------------------|------|---|------------|--------|---|----------------------------|------|---|------------|--------|
| 13 | Resistance to Soldering Heat | Appearance | No defects or abnormalities. | | | | | | | | | | | | | | | |
| | | Capacitance Change | Within $\pm 2.5\%$ or $\pm 0.25\text{pF}$ (Whichever is larger) | | | | | | | | | | | | | | | |
| | | Q | Within the specified initial value. | | | | | | | | | | | | | | | |
| | | I.R. | Within the specified initial value. | | | | | | | | | | | | | | | |
| | | Voltage Proof | No defects. | | | | | | | | | | | | | | | |
| 14 | Temperature Sudden Change | Appearance | No defects or abnormalities. | | | | | | | | | | | | | | | |
| | | Capacitance Change | Within $\pm 2.5\%$ or $\pm 0.25\text{pF}$ (Whichever is larger) | | | | | | | | | | | | | | | |
| | | Q | Within the specified initial value. | | | | | | | | | | | | | | | |
| | | I.R. | Within the specified initial value. | | | | | | | | | | | | | | | |
| | | Voltage Proof | No defects. | | | | | | | | | | | | | | | |
| | | | Solder the capacitor on the test substrate shown in Fig.3. Perform the five cycles according to the four heat treatments shown in the following table. <table border="1" style="margin-left: 20px;"> <thead> <tr> <th>Step</th> <th>Temp. (°C)</th> <th>Time (min)</th> </tr> </thead> <tbody> <tr> <td>1</td> <td>Min. Operating Temp. +0/-3</td> <td>30±3</td> </tr> <tr> <td>2</td> <td>Room Temp.</td> <td>2 to 3</td> </tr> <tr> <td>3</td> <td>Max. Operating Temp. +3/-0</td> <td>30±3</td> </tr> <tr> <td>4</td> <td>Room Temp.</td> <td>2 to 3</td> </tr> </tbody> </table> Exposure Time: 24±2h | Step | Temp. (°C) | Time (min) | 1 | Min. Operating Temp. +0/-3 | 30±3 | 2 | Room Temp. | 2 to 3 | 3 | Max. Operating Temp. +3/-0 | 30±3 | 4 | Room Temp. | 2 to 3 |
| Step | Temp. (°C) | Time (min) | | | | | | | | | | | | | | | | |
| 1 | Min. Operating Temp. +0/-3 | 30±3 | | | | | | | | | | | | | | | | |
| 2 | Room Temp. | 2 to 3 | | | | | | | | | | | | | | | | |
| 3 | Max. Operating Temp. +3/-0 | 30±3 | | | | | | | | | | | | | | | | |
| 4 | Room Temp. | 2 to 3 | | | | | | | | | | | | | | | | |
| 15 | High Temperature High Humidity (Steady) | Appearance | No defects or abnormalities. | | | | | | | | | | | | | | | |
| | | Capacitance Change | Within $\pm 7.5\%$ or $\pm 0.75\text{pF}$ (Whichever is larger) | | | | | | | | | | | | | | | |
| | | Q | 30pF and over: $Q \geq 200$ 30pF and below: $Q \geq 100+10C/3$ C: Nominal Capacitance (pF) | | | | | | | | | | | | | | | |
| | | I.R. | More than 500MΩ or 25Ω · F (Whichever is smaller) | | | | | | | | | | | | | | | |
| 16 | Durability | Appearance | No defects or abnormalities. | | | | | | | | | | | | | | | |
| | | Capacitance Change | Within $\pm 3\%$ or $\pm 0.3\text{pF}$ (Whichever is larger) | | | | | | | | | | | | | | | |
| | | Q | 30pF and over: $Q \geq 350$ 10pF and over, 30pF and below: $Q \geq 275+5C/2$ 10pF and below: $Q \geq 200+10C$ C: Nominal Capacitance (pF) | | | | | | | | | | | | | | | |
| | | I.R. | More than 1000MΩ or 50Ω · F (Whichever is smaller) | | | | | | | | | | | | | | | |
| 17 | ESR (GJM02) | 0.2pF \leq C \leq 1pF: 700mΩ/C below 1pF < C \leq 2pF: 600mΩ below 2pF < C \leq 5pF: 500mΩ below 5pF < C \leq 10pF: 300mΩ below 10pF < C \leq 22pF: 350mΩ below C: Nominal Capacitance (pF) | Measurement Frequency: 1.0±0.1GHz Measurement Temperature: Room Temp. Measurement Instrument: Equivalent to E4991A | | | | | | | | | | | | | | | |
| | | ESR (GJM03/GJM15) | 0.1pF \leq C \leq 1pF: 350mΩ/C below 1pF < C \leq 5pF: 300mΩ below 5pF < C \leq 10pF: 250mΩ below C: Nominal Capacitance (pF) | Measurement Frequency: 1.0±0.2GHz Measurement Temperature: Room Temp. Measurement Instrument: Equivalent to BOONTON Model 34A | | | | | | | | | | | | | | |
| | | | 10pF < C \leq 47pF: 400mΩ below Measurement Frequency: 500±50MHz Measurement Temperature: Room Temp. Measurement Instrument: Equivalent to HP8753B | | | | | | | | | | | | | | | |

Continued on the following page. ↗

GRM
 GR3
 GRJ
 GR4
 GR7
GJM
 GQM
 GA2
 GA3 GB
 GA3 GD
 GA3 GF
 LLL
 LLA
 LLM
 LLR
 NFM
 KRM
 KR3
 GMA
 GMD
 ⚠Caution /Notice

GJM Series Specifications and Test Methods (1)

Continued from the preceding page. ↘

Table A

| Char. | Capacitance Change from Value at Reference Temp. (%) | | | | | | | |
|-------|--|-------|-------|-------|-------|-------|-------|-------|
| | -55°C | | -30°C | | -25°C | | -10°C | |
| | Max. | Min. | Max. | Min. | Max. | Min. | Max. | Min. |
| 1C | 0.54 | -0.23 | - | - | 0.33 | -0.14 | 0.22 | -0.09 |
| 2C | 0.82 | -0.45 | - | - | 0.49 | -0.27 | 0.33 | -0.18 |
| 3C | 1.37 | -0.90 | - | - | 0.82 | -0.54 | 0.55 | -0.36 |
| 4C | 2.56 | -1.88 | - | - | 1.54 | -1.13 | 1.02 | -0.75 |
| 5C | 0.58 | -0.24 | 0.40 | -0.17 | - | - | 0.25 | -0.11 |
| 6C | 0.87 | -0.48 | 0.59 | -0.33 | - | - | 0.38 | -0.21 |

Substrate Bending Test

• Test Substrate

Material: Copper-clad laminated sheets for PCBs
 (Glass fabric base, epoxy resin)

Thickness: 0.8mm

☐: Solder resist

(Coat with heat resistant resin for solder)

for GJM02

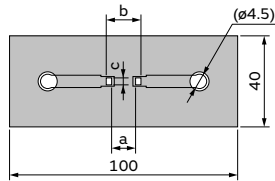

Copper foil thickness: 0.018mm

for GJM03/15

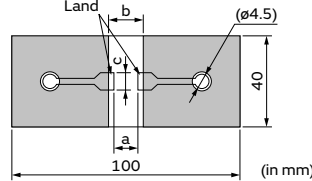

Copper foil thickness: 0.035mm

| Part Number | Dimension (mm) | | |
|-------------|----------------|------|------|
| | a | b | c |
| GJM02 | 0.2 | 0.56 | 0.23 |
| GJM03 | 0.3 | 0.9 | 0.3 |
| GJM15 | 0.4 | 1.5 | 0.5 |

Fig.1

- Kind of Solder: Sn-3.0Ag-0.5Cu
- Pressurization Method

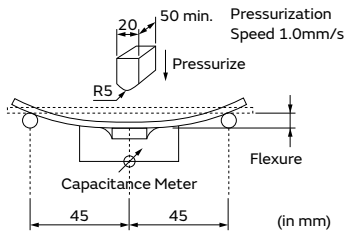

Fig.2

Adhesive Strength of Termination, Vibration, Temperature Sudden Change, Resistance to Soldering Heat (Reflow method) High Temperature High Humidity (Steady), Durability

• Test Substrate

Material: Copper-clad laminated sheets for PCBs
 (Glass fabric base, epoxy resin)

Thickness: 1.6mm or 0.8mm

Copper foil thickness: 0.035mm

- Kind of Solder: Sn-3.0Ag-0.5Cu
- Land Dimensions

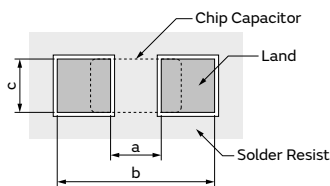

| Part Number | Dimension (mm) | | |
|-------------|----------------|------|------|
| | a | b | c |
| GJM02 | 0.2 | 0.56 | 0.23 |
| GJM03 | 0.3 | 0.9 | 0.3 |
| GJM15 | 0.4 | 1.5 | 0.5 |

Fig.3

2

GJM Series Specifications and Test Methods (2)

| No | Item | Specification | Test Method (Ref. Standard: JIS C 5101, IEC60384) | | | | | | | | | | | | |
|------------------------|---|---|---|------------------------------|--------------------|---|--|-------------------------------------|--|-------|--------------------|---|-------------------------|---|--------------------|
| 1 | Rated Voltage | Shown in Rated value. | The rated voltage is defined as the maximum voltage which may be applied continuously to the capacitor. When AC voltage is superimposed on DC voltage, V^{P-P} or V^{O-P} , whichever is larger, should be maintained within the rated voltage range. | | | | | | | | | | | | |
| 2 | Appearance | No defects or abnormalities. | Visual inspection. | | | | | | | | | | | | |
| 3 | Dimension | Within the specified dimensions. | Using Measuring instrument of dimension. | | | | | | | | | | | | |
| 4 | Voltage Proof | No defects or abnormalities. | Measurement Point: Between the terminations Test Voltage: 300% of the rated voltage Applied Time: 1 to 5s Charge/discharge current: 50mA max. | | | | | | | | | | | | |
| 5 | Insulation Resistance (I.R.) | $C \leq 0.047\mu\text{F}$: More than 10000M Ω $C > 0.047\mu\text{F}$: More than $500\Omega \cdot \text{F}$ C: Nominal Capacitance | Measurement Point: Between the terminations Measurement Voltage: DC Rated Voltage Charging Time: 2min Charge/discharge current: 50mA max. Measurement Temperature: Room Temperature | | | | | | | | | | | | |
| 6 | Capacitance | Shown in Rated value. | Measurement Temperature: Room Temperature | | | | | | | | | | | | |
| 7 | Q | 30pF and over: $Q \geq 1000$ 30pF and below: $Q \geq 400+20C$ C: Nominal Capacitance (pF) | <table border="1"> <thead> <tr> <th>Capacitance</th> <th>Frequency</th> <th>Voltage</th> </tr> </thead> <tbody> <tr> <td>$C \leq 1000\text{pF}$</td> <td>1.0±0.1MHz</td> <td>0.5 to 5.0Vrms</td> </tr> </tbody> </table> | Capacitance | Frequency | Voltage | $C \leq 1000\text{pF}$ | 1.0±0.1MHz | 0.5 to 5.0Vrms | | | | | | |
| Capacitance | Frequency | Voltage | | | | | | | | | | | | | |
| $C \leq 1000\text{pF}$ | 1.0±0.1MHz | 0.5 to 5.0Vrms | | | | | | | | | | | | | |
| 8 | Temperature Characteristics of Capacitance | Nominal values of the temperature coefficient is shown in Rated value. But, the Capacitance Change under 20°C is shown in Table A. Capacitance Drift Within ±0.2% or ±0.05pF (Whichever is larger.) | <p>The capacitance change should be measured after 5 minutes at each specified temp. stage. Capacitance value as a reference is the value in step 3. The capacitance drift is calculated by dividing the differences between the maximum and minimum measured values in the step 1, 3 and 5 by the cap. value in step 3.</p> <table border="1"> <thead> <tr> <th>Step</th> <th>Temperature (°C)</th> </tr> </thead> <tbody> <tr> <td>1</td> <td>Reference Temp. ±2</td> </tr> <tr> <td>2</td> <td>Min. Operating Temp. ±3</td> </tr> <tr> <td>3</td> <td>Reference Temp. ±2</td> </tr> <tr> <td>4</td> <td>Max. Operating Temp. ±3</td> </tr> <tr> <td>5</td> <td>Reference Temp. ±2</td> </tr> </tbody> </table> | Step | Temperature (°C) | 1 | Reference Temp. ±2 | 2 | Min. Operating Temp. ±3 | 3 | Reference Temp. ±2 | 4 | Max. Operating Temp. ±3 | 5 | Reference Temp. ±2 |
| Step | Temperature (°C) | | | | | | | | | | | | | | |
| 1 | Reference Temp. ±2 | | | | | | | | | | | | | | |
| 2 | Min. Operating Temp. ±3 | | | | | | | | | | | | | | |
| 3 | Reference Temp. ±2 | | | | | | | | | | | | | | |
| 4 | Max. Operating Temp. ±3 | | | | | | | | | | | | | | |
| 5 | Reference Temp. ±2 | | | | | | | | | | | | | | |
| 9 | Adhesive Strength of Termination | No removal of the terminations or other defect should occur. | <p>Solder the capacitor on the test substrate shown in Fig.3.</p> <table border="1"> <thead> <tr> <th>Part Number</th> <th>Applied Force (N)</th> </tr> </thead> <tbody> <tr> <td>GJM02</td> <td>1</td> </tr> <tr> <td>GJM03</td> <td>2</td> </tr> <tr> <td>GJM15</td> <td>5</td> </tr> </tbody> </table> <p>Holding Time: 10±1s Applied Direction: In parallel with the test substrate and vertical with the capacitor side.</p> | Part Number | Applied Force (N) | GJM02 | 1 | GJM03 | 2 | GJM15 | 5 | | | | |
| Part Number | Applied Force (N) | | | | | | | | | | | | | | |
| GJM02 | 1 | | | | | | | | | | | | | | |
| GJM03 | 2 | | | | | | | | | | | | | | |
| GJM15 | 5 | | | | | | | | | | | | | | |
| 10 | Vibration | <table border="1"> <tbody> <tr> <td>Appearance</td> <td>No defects or abnormalities.</td> </tr> <tr> <td>Capacitance</td> <td>Within the specified initial value.</td> </tr> <tr> <td>Q</td> <td>Within the specified initial value.</td> </tr> </tbody> </table> | Appearance | No defects or abnormalities. | Capacitance | Within the specified initial value. | Q | Within the specified initial value. | <p>Solder the capacitor on the test substrate shown in Fig.3. Kind of Vibration: A simple harmonic motion 10Hz to 55Hz to 10Hz (1min) Total amplitude: 1.5mm This motion should be applied for a period of 2h in each 3 mutually perpendicular directions (total of 6h).</p> | | | | | | |
| Appearance | No defects or abnormalities. | | | | | | | | | | | | | | |
| Capacitance | Within the specified initial value. | | | | | | | | | | | | | | |
| Q | Within the specified initial value. | | | | | | | | | | | | | | |
| 11 | Substrate Bending Test | <table border="1"> <tbody> <tr> <td>Appearance</td> <td>No defects or abnormalities.</td> </tr> <tr> <td>Capacitance Change</td> <td>Within ±5% or ±0.5pF (Whichever is larger)</td> </tr> </tbody> </table> | Appearance | No defects or abnormalities. | Capacitance Change | Within ±5% or ±0.5pF (Whichever is larger) | <p>Solder the capacitor on the test substrate shown in Fig.1. Pressurization method: Shown in Fig.2 Flexure: 1mm Holding Time: 5±1s Soldering Method: Reflow soldering</p> | | | | | | | | |
| Appearance | No defects or abnormalities. | | | | | | | | | | | | | | |
| Capacitance Change | Within ±5% or ±0.5pF (Whichever is larger) | | | | | | | | | | | | | | |
| 12 | Solderability | 95% of the terminations is to be soldered evenly and continuously. | <p>Test Method: Solder bath method Flux: Solution of rosin ethanol 25 (mass)% Preheat: 80 to 120°C for 10 to 30s Solder: Sn-3.0Ag-0.5Cu Solder Temp.: 245±5°C Immersion time: 2±0.5s</p> | | | | | | | | | | | | |

Continued on the following page. ↗

GRM
GR3
GRJ
GR4
GR7
GJM
GQM
GA2
GA3
GB
GA3
GD
GA3
GF
LLL
LLA
LLM
LLR
NFM
KRM
KR3
GMA
GMD
⚠Caution / Notice

GJM Series Specifications and Test Methods (2)

Continued from the preceding page. ↘

| No | Item | Specification | Test Method (Ref. Standard: JIS C 5101, IEC60384) | | | | | | | | | | | | | | | |
|------|---|---|---|------|----------------------------|------------|---|------------------------------|-----------|---|------------|--------|---|------------------------------|-----------|---|------------|--------|
| 13 | Resistance to Soldering Heat | Appearance | No defects or abnormalities. | | | | | | | | | | | | | | | |
| | | Capacitance Change | Within $\pm 2.5\%$ or $\pm 0.25\text{pF}$ (Whichever is larger) | | | | | | | | | | | | | | | |
| | | Q | Within the specified initial value. | | | | | | | | | | | | | | | |
| | | I.R. | Within the specified initial value. | | | | | | | | | | | | | | | |
| | | Voltage Proof | No defects. | | | | | | | | | | | | | | | |
| | | | <GJM02 size only> Test Method: Reflow soldering (hot plate) Solder: Sn-3.0Ag-0.5Cu Solder Temp.: $270\pm 5^\circ\text{C}$ Reflow Time: $10\pm 0.5\text{s}$ Test Substrate: Glass epoxy PCB Exposure Time: $24\pm 2\text{h}$ Preheat: 120 to 150°C for 1min <GJM03/GJM15 size> Test Method: Solder bath method Solder: Sn-3.0Ag-0.5Cu Solder Temp.: $270\pm 5^\circ\text{C}$ Immersion time: $10\pm 0.5\text{s}$ Exposure Time: $24\pm 2\text{h}$ Preheat: 120 to 150°C for 1min | | | | | | | | | | | | | | | |
| 14 | Temperature Sudden Change | Appearance | No defects or abnormalities. | | | | | | | | | | | | | | | |
| | | Capacitance Change | Within $\pm 2.5\%$ or $\pm 0.25\text{pF}$ (Whichever is larger) | | | | | | | | | | | | | | | |
| | | Q | Within the specified initial value. | | | | | | | | | | | | | | | |
| | | I.R. | Within the specified initial value. | | | | | | | | | | | | | | | |
| | | Voltage Proof | No defects. | | | | | | | | | | | | | | | |
| | | | Solder the capacitor on the test substrate shown in Fig.3. Perform the five cycles according to the four heat treatments shown in the following table. | | | | | | | | | | | | | | | |
| | | | <table border="1"> <thead> <tr> <th>Step</th> <th>Temp. ($^\circ\text{C}$)</th> <th>Time (min)</th> </tr> </thead> <tbody> <tr> <td>1</td> <td>Min. Operating Temp. $+0/-3$</td> <td>30 ± 3</td> </tr> <tr> <td>2</td> <td>Room Temp.</td> <td>2 to 3</td> </tr> <tr> <td>3</td> <td>Max. Operating Temp. $+3/-0$</td> <td>30 ± 3</td> </tr> <tr> <td>4</td> <td>Room Temp.</td> <td>2 to 3</td> </tr> </tbody> </table> | Step | Temp. ($^\circ\text{C}$) | Time (min) | 1 | Min. Operating Temp. $+0/-3$ | 30 ± 3 | 2 | Room Temp. | 2 to 3 | 3 | Max. Operating Temp. $+3/-0$ | 30 ± 3 | 4 | Room Temp. | 2 to 3 |
| Step | Temp. ($^\circ\text{C}$) | Time (min) | | | | | | | | | | | | | | | | |
| 1 | Min. Operating Temp. $+0/-3$ | 30 ± 3 | | | | | | | | | | | | | | | | |
| 2 | Room Temp. | 2 to 3 | | | | | | | | | | | | | | | | |
| 3 | Max. Operating Temp. $+3/-0$ | 30 ± 3 | | | | | | | | | | | | | | | | |
| 4 | Room Temp. | 2 to 3 | | | | | | | | | | | | | | | | |
| | | | Exposure Time: $24\pm 2\text{h}$ | | | | | | | | | | | | | | | |
| 15 | High Temperature High Humidity (Steady) | Appearance | No defects or abnormalities. | | | | | | | | | | | | | | | |
| | | Capacitance Change | Within $\pm 7.5\%$ or $\pm 0.75\text{pF}$ (Whichever is larger) | | | | | | | | | | | | | | | |
| | | Q | 30pF and over: $Q \geq 200$ 30pF and below: $Q \geq 100+10\text{C}/3$ C: Nominal Capacitance (pF) | | | | | | | | | | | | | | | |
| | | I.R. | More than $500\text{M}\Omega$ or $25\Omega \cdot \text{F}$ (Whichever is smaller) | | | | | | | | | | | | | | | |
| | | | Solder the capacitor on the test substrate shown in Fig.3. Test Temperature: $40\pm 2^\circ\text{C}$ Test Humidity: 90 to $95\%\text{RH}$ Test Time: $500\pm 12\text{h}$ Applied Voltage: DC Rated Voltage Charge/discharge current: 50mA max. Exposure Time: $24\pm 2\text{h}$ | | | | | | | | | | | | | | | |
| 16 | Durability | Appearance | No defects or abnormalities. | | | | | | | | | | | | | | | |
| | | Capacitance Change | Within $\pm 3\%$ or $\pm 0.3\text{pF}$ (Whichever is larger) | | | | | | | | | | | | | | | |
| | | Q | 30pF and over: $Q \geq 350$ 10pF and over, 30pF and below: $Q \geq 275+5\text{C}/2$ 10pF and below: $Q \geq 200+10\text{C}$ C: Nominal Capacitance (pF) | | | | | | | | | | | | | | | |
| | | I.R. | More than $1000\text{M}\Omega$ or $50\Omega \cdot \text{F}$ (Whichever is smaller) | | | | | | | | | | | | | | | |
| | | | Solder the capacitor on the test substrate shown in Fig.3. Test Temperature: Max. Operating Temp. $\pm 3^\circ\text{C}$ Test Time: $1000\pm 12\text{h}$ Applied Voltage: 100% of the rated voltage Charge/discharge current: 50mA max. Exposure Time: $24\pm 2\text{h}$ | | | | | | | | | | | | | | | |
| 17 | ESR (GJM02) | $0.2\text{pF} \leq \text{C} \leq 1\text{pF}$: $700\text{m}\Omega/\text{C}$ below $1\text{pF} < \text{C} \leq 2\text{pF}$: $600\text{m}\Omega$ below $2\text{pF} < \text{C} \leq 5\text{pF}$: $500\text{m}\Omega$ below $5\text{pF} < \text{C} \leq 10\text{pF}$: $300\text{m}\Omega$ below $10\text{pF} < \text{C} \leq 22\text{pF}$: $350\text{m}\Omega$ below C: Nominal Capacitance (pF) | Measurement Frequency: $1.0\pm 0.1\text{GHz}$ Measurement Temperature: Room Temp. Measurement Instrument: Equivalent to E4991A | | | | | | | | | | | | | | | |
| | ESR (GJM03/GJM15) | $0.1\text{pF} \leq \text{C} \leq 1\text{pF}$: $350\text{m}\Omega/\text{C}$ below $1\text{pF} < \text{C} \leq 5\text{pF}$: $300\text{m}\Omega$ below $5\text{pF} < \text{C} \leq 10\text{pF}$: $250\text{m}\Omega$ below C: Nominal Capacitance (pF) | Measurement Frequency: $1.0\pm 0.2\text{GHz}$ Measurement Temperature: Room Temp. Measurement Instrument: Equivalent to BOONTON Model 34A | | | | | | | | | | | | | | | |
| | | | $10\text{pF} < \text{C} \leq 47\text{pF}$: $400\text{m}\Omega$ below Measurement Frequency: $500\pm 50\text{MHz}$ Measurement Temperature: Room Temp. Measurement Instrument: Equivalent to HP8753B | | | | | | | | | | | | | | | |

Continued on the following page. ↗

GRM

GR3

GRJ

GR4

GR7

GJM

GQM

GA2

GA3 GB

GA3 GD

GA3 GF

LLL

LLA

LLM

LLR

NFM

KRM

KR3

GMA

GMD

⚠Caution / Notice

GJM Series Specifications and Test Methods (2)

Continued from the preceding page. ↘

Table A

| Char. | Capacitance Change from Value at Reference Temp. (%) | | | | | | | |
|-------|--|-------|-------|-------|-------|-------|-------|-------|
| | -55°C | | -30°C | | -25°C | | -10°C | |
| | Max. | Min. | Max. | Min. | Max. | Min. | Max. | Min. |
| 1C | 0.54 | -0.23 | - | - | 0.33 | -0.14 | 0.22 | -0.09 |
| 2C | 0.82 | -0.45 | - | - | 0.49 | -0.27 | 0.33 | -0.18 |
| 3C | 1.37 | -0.90 | - | - | 0.82 | -0.54 | 0.55 | -0.36 |
| 4C | 2.56 | -1.88 | - | - | 1.54 | -1.13 | 1.02 | -0.75 |
| 5C | 0.58 | -0.24 | 0.40 | -0.17 | - | - | 0.25 | -0.11 |
| 6C | 0.87 | -0.48 | 0.59 | -0.33 | - | - | 0.38 | -0.21 |

Recommended derating conditions on voltage and temperature

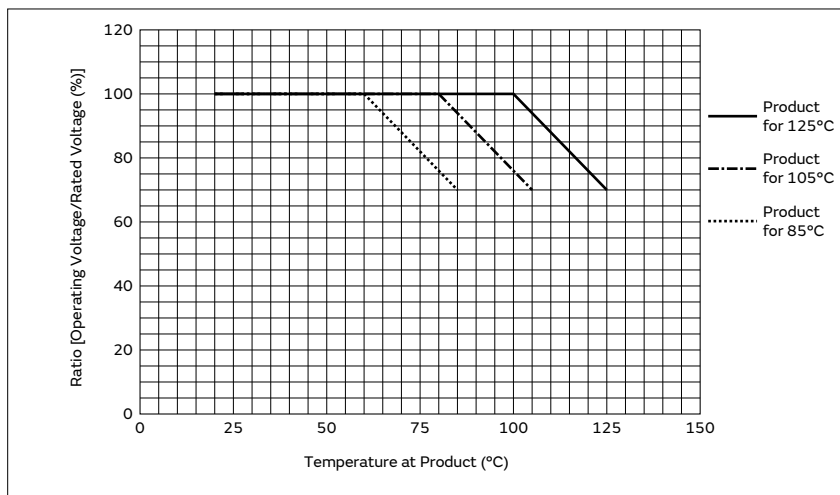

These Part Numbers are designed for use in the circuits where continuous applied voltage to the capacitor is derated than rated voltage, and guarantee Durability Test with 100% × rated voltage as testing voltage at the maximum operating temperature. The voltage and temperature derating conditions on the upside are recommended for use to ensure the same reliability level as normal specification.

Continued on the following page. ↗

GRM
 GR3
 GRJ
 GR4
 GR7
CJM
 GQM
 GA2
 GA3 GB
 GA3 GD
 GA3 GF
 LLL
 LLA
 LLM
 LLR
 NFM
 KRM
 KR3
 GMA
 GMD
 ⚠Caution /Notice

GJM Series Specifications and Test Methods (2)

Continued from the preceding page. ↘

Substrate Bending Test

• Test Substrate

Material: Copper-clad laminated sheets for PCBs
 (Glass fabric base, epoxy resin)

Thickness: 0.8mm

■: Solder resist

(Coat with heat resistant resin for solder)

for GJM02



Copper foil thickness: 0.018mm

for GJM03/15



Copper foil thickness: 0.035mm

Fig.1 (in mm)

| Part Number | Dimension (mm) | | |
|-------------|----------------|------|------|
| | a | b | c |
| GJM02 | 0.2 | 0.56 | 0.23 |
| GJM03 | 0.3 | 0.9 | 0.3 |
| GJM15 | 0.4 | 1.5 | 0.5 |

• Kind of Solder: Sn-3.0Ag-0.5Cu

• Pressurization Method

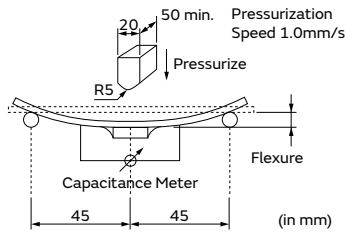

Fig.2

Adhesive Strength of Termination, Vibration, Temperature Sudden Change, Resistance to Soldering Heat (Reflow method) High Temperature High Humidity (Steady), Durability

• Test Substrate

Material: Copper-clad laminated sheets for PCBs
 (Glass fabric base, epoxy resin)

Thickness: 1.6mm or 0.8mm

Copper foil thickness: 0.035mm

• Kind of Solder: Sn-3.0Ag-0.5Cu

• Land Dimensions

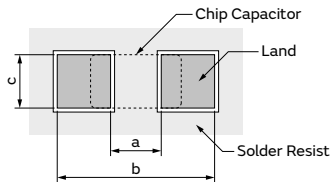

| Part Number | Dimension (mm) | | |
|-------------|----------------|------|------|
| | a | b | c |
| GJM02 | 0.2 | 0.56 | 0.23 |
| GJM03 | 0.3 | 0.9 | 0.3 |
| GJM15 | 0.4 | 1.5 | 0.5 |

Fig.3

GRM
 GR3
 GRJ
 GR4
 GR7
GJM
 GQM
 GA2
 GA3 GB
 GA3 GD
 GA3 GF
 LLL
 LLA
 LLM
 LLR
 NFM
 KPM
 KR3
 GMA
 GMD
 ⚠Caution / Notice

High Q and High Power Chip Multilayer Ceramic Capacitors for General Purpose

GQM Series  **High Q** 

High Frequency Capacitor Ideal for PA Design of Base Stations

Features

① **Mainly ideal for base stations of mobile communication devices and temperature compensation of related modules.**

This product is ideal for temperature compensation of high frequency circuits, such as resonant circuits, tuning circuits, and impedance matching circuits where the operating characteristics of the device are greatly affected by the capacitance fluctuation.

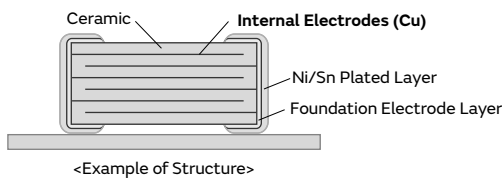

② **High Q and low ESR in VHF, UHF and microwave frequency bands.**

High Q and low ESR were achieved at a high frequency by adopting ceramic material as the dielectric material which enables an extremely low loss at high frequency, and base metal electrodes as the internal electrodes.

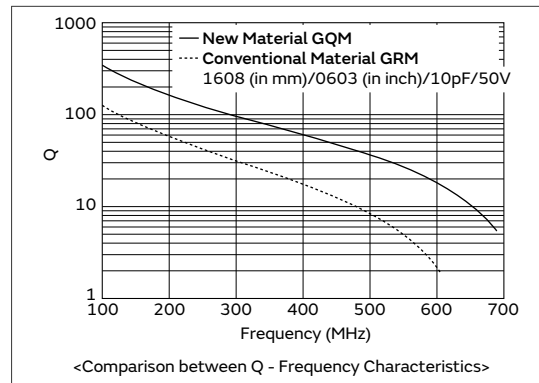
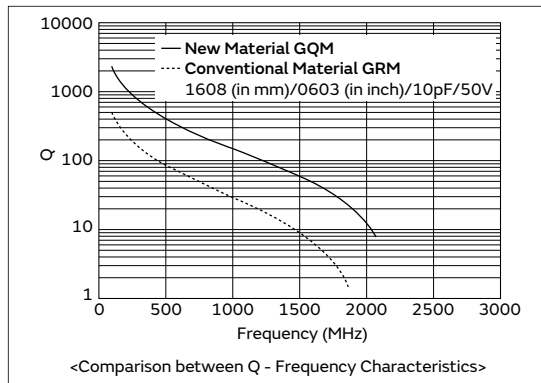

③ **Can be used for tight tolerance.**

In addition to standard tolerance, the allowable range of this product is also suitable for the following narrow tolerance.

| Capacitance Range | Standard Capacitance Tolerance (Capacitance Tolerance Symbol) | Narrow Capacitance Tolerance (Capacitance Tolerance Symbol) |
|-------------------|---|---|
| to 0.9pF | ±0.1pF (B) | ±0.05pF (W) |
| 1.0 to 5.0pF | ±0.25pF (C) | ±0.05pF (W), ±0.1pF (B) |
| 5.1 to 9.9pF | ±0.5pF (D) | ±0.05pF (W), ±0.1pF (B), ±0.25pF (C) |
| 10pF to | ±5% (J) | ±2% (G) |

Specifications

| | |
|-------------------|---|
| Size (mm) | 1.0×0.5mm to 2.8×2.8mm |
| Rated Voltage | 50Vdc to 500Vdc |
| Capacitance | 0.10pF to 510pF |
| Main Applications | Measuring instruments, other ultra compact/thin devices |

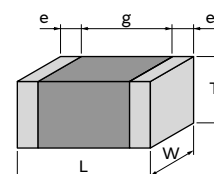

<Dimensions>

This catalog contains only a portion of the product lineup.
 Please refer to the capacitor search tool on the Murata Web site for details.

GQM Series Temperature Compensating Type Part Number List

1.0×0.5mm

| T max. | Rated Voltage | TC Code | Cap. | Tol. | Part Number | p* |
|--------|---------------|--------------------|--------|---------|--------------------|------|
| 0.55mm | 200Vdc | COG | 0.10pF | ±0.1pF | GQM1555C2DR10BB01# | p172 |
| | | | | ±0.25pF | GQM1555C2DR10CB01# | p172 |
| | | | 0.20pF | ±0.1pF | GQM1555C2DR20BB01# | p172 |
| | | | | ±0.25pF | GQM1555C2DR20CB01# | p172 |
| | | | 0.30pF | ±0.1pF | GQM1555C2DR30BB01# | p172 |
| | | | | ±0.25pF | GQM1555C2DR30CB01# | p172 |
| | | | 0.40pF | ±0.1pF | GQM1555C2DR40BB01# | p172 |
| | | | | ±0.25pF | GQM1555C2DR40CB01# | p172 |
| | | | 0.50pF | ±0.1pF | GQM1555C2DR50BB01# | p172 |
| | | | | ±0.25pF | GQM1555C2DR50CB01# | p172 |
| | | | 0.60pF | ±0.1pF | GQM1555C2DR60BB01# | p172 |
| | | | | ±0.25pF | GQM1555C2DR60CB01# | p172 |
| | | | 0.70pF | ±0.1pF | GQM1555C2DR70BB01# | p172 |
| | | | | ±0.25pF | GQM1555C2DR70CB01# | p172 |
| | | | 0.75pF | ±0.1pF | GQM1555C2DR75BB01# | p172 |
| | | | | ±0.25pF | GQM1555C2DR75CB01# | p172 |
| | | | 0.80pF | ±0.1pF | GQM1555C2DR80BB01# | p172 |
| | | | | ±0.25pF | GQM1555C2DR80CB01# | p172 |
| | | | 0.90pF | ±0.1pF | GQM1555C2DR90BB01# | p172 |
| | | | | ±0.25pF | GQM1555C2DR90CB01# | p172 |
| | | | 1.0pF | ±0.1pF | GQM1555C2D1R0BB01# | p172 |
| | | | | ±0.25pF | GQM1555C2D1R0CB01# | p172 |
| | | | 1.1pF | ±0.1pF | GQM1555C2D1R1BB01# | p172 |
| | | | | ±0.25pF | GQM1555C2D1R1CB01# | p172 |
| | | | 1.2pF | ±0.1pF | GQM1555C2D1R2BB01# | p172 |
| | | | | ±0.25pF | GQM1555C2D1R2CB01# | p172 |
| | | | 1.3pF | ±0.1pF | GQM1555C2D1R3BB01# | p172 |
| | | | | ±0.25pF | GQM1555C2D1R3CB01# | p172 |
| | | | 1.5pF | ±0.1pF | GQM1555C2D1R5BB01# | p172 |
| | | | | ±0.25pF | GQM1555C2D1R5CB01# | p172 |
| | | | 1.6pF | ±0.1pF | GQM1555C2D1R6BB01# | p172 |
| | | | | ±0.25pF | GQM1555C2D1R6CB01# | p172 |
| | | | 1.8pF | ±0.1pF | GQM1555C2D1R8BB01# | p172 |
| | | | | ±0.25pF | GQM1555C2D1R8CB01# | p172 |
| | | | 2.0pF | ±0.1pF | GQM1555C2D2R0BB01# | p172 |
| | | | | ±0.25pF | GQM1555C2D2R0CB01# | p172 |
| | | | 2.2pF | ±0.1pF | GQM1555C2D2R2BB01# | p172 |
| | | | | ±0.25pF | GQM1555C2D2R2CB01# | p172 |
| | | | 2.4pF | ±0.1pF | GQM1555C2D2R4BB01# | p172 |
| | | | | ±0.25pF | GQM1555C2D2R4CB01# | p172 |
| | | | 2.7pF | ±0.1pF | GQM1555C2D2R7BB01# | p172 |
| | | | | ±0.25pF | GQM1555C2D2R7CB01# | p172 |
| | | | 3.0pF | ±0.1pF | GQM1555C2D3R0BB01# | p172 |
| | | | | ±0.25pF | GQM1555C2D3R0CB01# | p172 |
| | | | 3.3pF | ±0.1pF | GQM1555C2D3R3BB01# | p172 |
| | | | | ±0.25pF | GQM1555C2D3R3CB01# | p172 |
| | | | 3.6pF | ±0.1pF | GQM1555C2D3R6BB01# | p172 |
| | | | | ±0.25pF | GQM1555C2D3R6CB01# | p172 |
| 3.9pF | ±0.1pF | GQM1555C2D3R9BB01# | p172 | | | |
| | ±0.25pF | GQM1555C2D3R9CB01# | p172 | | | |
| 4.0pF | ±0.1pF | GQM1555C2D4R0BB01# | p172 | | | |
| | ±0.25pF | GQM1555C2D4R0CB01# | p172 | | | |
| 4.3pF | ±0.1pF | GQM1555C2D4R3BB01# | p172 | | | |
| | ±0.25pF | GQM1555C2D4R3CB01# | p172 | | | |

| T max. | Rated Voltage | TC Code | Cap. | Tol. | Part Number | p* |
|--------|---------------|--------------------|-------|---------|--------------------|------|
| 0.55mm | 200Vdc | COG | 4.7pF | ±0.1pF | GQM1555C2D4R7BB01# | p172 |
| | | | | ±0.25pF | GQM1555C2D4R7CB01# | p172 |
| | | | 5.0pF | ±0.1pF | GQM1555C2D5R0BB01# | p172 |
| | | | | ±0.25pF | GQM1555C2D5R0CB01# | p172 |
| | | | 5.1pF | ±0.1pF | GQM1555C2D5R1BB01# | p172 |
| | | | | ±0.25pF | GQM1555C2D5R1CB01# | p172 |
| | | | 5.6pF | ±0.1pF | GQM1555C2D5R6BB01# | p172 |
| | | | | ±0.25pF | GQM1555C2D5R6CB01# | p172 |
| | | | 6.0pF | ±0.1pF | GQM1555C2D6R0BB01# | p172 |
| | | | | ±0.25pF | GQM1555C2D6R0CB01# | p172 |
| | | | 6.2pF | ±0.1pF | GQM1555C2D6R2BB01# | p172 |
| | | | | ±0.25pF | GQM1555C2D6R2CB01# | p172 |
| | | | 6.8pF | ±0.1pF | GQM1555C2D6R8BB01# | p172 |
| | | | | ±0.25pF | GQM1555C2D6R8CB01# | p172 |
| | | | 7.0pF | ±0.1pF | GQM1555C2D7R0BB01# | p172 |
| | | | | ±0.25pF | GQM1555C2D7R0CB01# | p172 |
| | | | 7.5pF | ±0.1pF | GQM1555C2D7R5BB01# | p172 |
| | | | | ±0.25pF | GQM1555C2D7R5CB01# | p172 |
| | | | 8.0pF | ±0.1pF | GQM1555C2D8R0BB01# | p172 |
| | | | | ±0.25pF | GQM1555C2D8R0CB01# | p172 |
| | | | 8.2pF | ±0.1pF | GQM1555C2D8R2BB01# | p172 |
| | | | | ±0.25pF | GQM1555C2D8R2CB01# | p172 |
| | | | 9.0pF | ±0.1pF | GQM1555C2D9R0BB01# | p172 |
| | | | | ±0.25pF | GQM1555C2D9R0CB01# | p172 |
| | | | 9.1pF | ±0.1pF | GQM1555C2D9R1BB01# | p172 |
| | | | | ±0.25pF | GQM1555C2D9R1CB01# | p172 |
| | | | 10pF | ±2% | GQM1555C2D100GB01# | p172 |
| | | | | ±5% | GQM1555C2D100JB01# | p172 |
| | | | 11pF | ±2% | GQM1555C2D110GB01# | p172 |
| | | | | ±5% | GQM1555C2D110JB01# | p172 |
| | | | 12pF | ±2% | GQM1555C2D120GB01# | p172 |
| | | | | ±5% | GQM1555C2D120JB01# | p172 |
| | | | 13pF | ±2% | GQM1555C2D130GB01# | p172 |
| | | | | ±5% | GQM1555C2D130JB01# | p172 |
| | | | 15pF | ±2% | GQM1555C2D150GB01# | p172 |
| | | | | ±5% | GQM1555C2D150JB01# | p172 |
| | | | 16pF | ±2% | GQM1555C2D160GB01# | p172 |
| | | | | ±5% | GQM1555C2D160JB01# | p172 |
| | | | 18pF | ±2% | GQM1555C2D180GB01# | p172 |
| | | | | ±5% | GQM1555C2D180JB01# | p172 |
| | | | 20pF | ±2% | GQM1555C2D200GB01# | p172 |
| | | | | ±5% | GQM1555C2D200JB01# | p172 |
| | | | 22pF | ±2% | GQM1555C2D220GB01# | p172 |
| | | | | ±5% | GQM1555C2D220JB01# | p172 |
| | | | 24pF | ±2% | GQM1555C2D240GB01# | p172 |
| | | | | ±5% | GQM1555C2D240JB01# | p172 |
| | | | 27pF | ±2% | GQM1555C2D270GB01# | p172 |
| | | | | ±5% | GQM1555C2D270JB01# | p172 |
| 30pF | ±2% | GQM1555C2D300GB01# | p172 | | | |
| | ±5% | GQM1555C2D300JB01# | p172 | | | |
| 33pF | ±2% | GQM1555C2D330GB01# | p172 | | | |
| | ±5% | GQM1555C2D330JB01# | p172 | | | |
| | 100Vdc | COG | 36pF | ±2% | GQM1555C2A360GB01# | p172 |
| | | | | ±5% | GQM1555C2A360JB01# | p172 |

*: Refers to the page of the "Specifications and Test Methods".

Part number # indicates the package specification code.

GQM Series Temperature Compensating Type Part Number List

(→ 1.0×0.5mm)

| T max. | Rated Voltage | TC Code | Cap. | Tol. | Part Number | p* |
|--------|---------------|---------|------|------|--------------------|------|
| 0.55mm | 100Vdc | COG | 39pF | ±2% | GQM1555C2A390GB01# | p172 |
| | | | | ±5% | GQM1555C2A390JB01# | p172 |
| | | | 43pF | ±2% | GQM1555C2A430GB01# | p172 |
| | | | | ±5% | GQM1555C2A430JB01# | p172 |
| | | | 47pF | ±2% | GQM1555C2A470GB01# | p172 |
| | | | | ±5% | GQM1555C2A470JB01# | p172 |

| T max. | Rated Voltage | TC Code | Cap. | Tol. | Part Number | p* |
|--------|---------------|--------------------|--------------------|---------|--------------------|------|
| 0.8mm | 250Vdc | COG | 6.0pF | ±0.5pF | GQM1875C2E6R0DB12# | p178 |
| | | | | ±0.25pF | GQM1875C2E6R2CB12# | p178 |
| | | | 6.2pF | ±0.5pF | GQM1875C2E6R2DB12# | p178 |
| | | | | ±0.25pF | GQM1875C2E6R8CB12# | p178 |
| | | | 6.8pF | ±0.25pF | GQM1875C2E6R8DB12# | p178 |
| | | | | ±0.5pF | GQM1875C2E7R0CB12# | p178 |
| | | | 7.0pF | ±0.25pF | GQM1875C2E7R0DB12# | p178 |
| | | | | ±0.5pF | GQM1875C2E7R5CB12# | p178 |
| | | | 7.5pF | ±0.25pF | GQM1875C2E7R5DB12# | p178 |
| | | | | ±0.5pF | GQM1875C2E8R0CB12# | p178 |
| | | | 8.0pF | ±0.25pF | GQM1875C2E8R0DB12# | p178 |
| | | | | ±0.5pF | GQM1875C2E8R2CB12# | p178 |
| | | | 8.2pF | ±0.25pF | GQM1875C2E8R2DB12# | p178 |
| | | | | ±0.5pF | GQM1875C2E9R0CB12# | p178 |
| | | | 9.0pF | ±0.25pF | GQM1875C2E9R0DB12# | p178 |
| | | | | ±0.5pF | GQM1875C2E9R1CB12# | p178 |
| | | | 9.1pF | ±0.25pF | GQM1875C2E9R1DB12# | p178 |
| | | | | ±0.5pF | GQM1875C2E100GB12# | p178 |
| | | | 10pF | ±2% | GQM1875C2E100JB12# | p178 |
| | | | | ±5% | GQM1875C2E110GB12# | p178 |
| | | | 11pF | ±2% | GQM1875C2E110JB12# | p178 |
| | | | | ±5% | GQM1875C2E120GB12# | p178 |
| | | | 12pF | ±2% | GQM1875C2E120JB12# | p178 |
| | | | | ±5% | GQM1875C2E130GB12# | p178 |
| | | | 13pF | ±2% | GQM1875C2E130JB12# | p178 |
| | | | | ±5% | GQM1875C2E150GB12# | p178 |
| | | | 15pF | ±2% | GQM1875C2E150JB12# | p178 |
| | | | | ±5% | GQM1875C2E160GB12# | p178 |
| | | | 16pF | ±2% | GQM1875C2E160JB12# | p178 |
| | | | | ±5% | GQM1875C2E180GB12# | p178 |
| | | | 18pF | ±2% | GQM1875C2E180JB12# | p178 |
| | | | | ±5% | GQM1875C2E200GB12# | p178 |
| | | | 20pF | ±2% | GQM1875C2E200JB12# | p178 |
| | | | | ±5% | GQM1875C2E220GB12# | p178 |
| | | | 22pF | ±2% | GQM1875C2E220JB12# | p178 |
| | | | | ±5% | GQM1875C2E240GB12# | p178 |
| | | | 24pF | ±2% | GQM1875C2E240JB12# | p178 |
| | | | | ±5% | GQM1875C2E270GB12# | p178 |
| | | | 27pF | ±2% | GQM1875C2E270JB12# | p178 |
| | | | | ±5% | GQM1875C2E300GB12# | p178 |
| | | | 30pF | ±2% | GQM1875C2E300JB12# | p178 |
| | | | | ±5% | GQM1875C2E330GB12# | p178 |
| 33pF | ±2% | GQM1875C2E330JB12# | p178 | | | |
| | ±5% | GQM1875C2E360GB12# | p178 | | | |
| 36pF | ±2% | GQM1875C2E360JB12# | p178 | | | |
| | ±5% | GQM1875C2E390GB12# | p178 | | | |
| 39pF | ±2% | GQM1875C2E390JB12# | p178 | | | |
| | ±5% | GQM1875C2E430GB12# | p178 | | | |
| 43pF | ±2% | GQM1875C2E430JB12# | p178 | | | |
| | ±5% | GQM1875C2E470GB12# | p178 | | | |
| 47pF | ±2% | GQM1875C2E470JB12# | p178 | | | |
| | ±5% | GQM1875G2E1R0BB12# | p175 | | | |
| X8G | 1.0pF | ±0.1pF | GQM1875G2E1R0CB12# | p175 | | |
| | | ±0.25pF | GQM1875G2E1R1BB12# | p175 | | |

1.6×0.8mm

| T max. | Rated Voltage | TC Code | Cap. | Tol. | Part Number | p* |
|--------|---------------|---------|-------|---------|--------------------|------|
| 0.8mm | 250Vdc | COG | 1.0pF | ±0.1pF | GQM1875C2E1R0BB12# | p178 |
| | | | | ±0.25pF | GQM1875C2E1R0CB12# | p178 |
| | | | 1.1pF | ±0.1pF | GQM1875C2E1R1BB12# | p178 |
| | | | | ±0.25pF | GQM1875C2E1R1CB12# | p178 |
| | | | 1.2pF | ±0.1pF | GQM1875C2E1R2BB12# | p178 |
| | | | | ±0.25pF | GQM1875C2E1R2CB12# | p178 |
| | | | 1.3pF | ±0.1pF | GQM1875C2E1R3BB12# | p178 |
| | | | | ±0.25pF | GQM1875C2E1R3CB12# | p178 |
| | | | 1.5pF | ±0.1pF | GQM1875C2E1R5BB12# | p178 |
| | | | | ±0.25pF | GQM1875C2E1R5CB12# | p178 |
| | | | 1.6pF | ±0.1pF | GQM1875C2E1R6BB12# | p178 |
| | | | | ±0.25pF | GQM1875C2E1R6CB12# | p178 |
| | | | 1.8pF | ±0.1pF | GQM1875C2E1R8BB12# | p178 |
| | | | | ±0.25pF | GQM1875C2E1R8CB12# | p178 |
| | | | 2.0pF | ±0.1pF | GQM1875C2E2R0BB12# | p178 |
| | | | | ±0.25pF | GQM1875C2E2R0CB12# | p178 |
| | | | 2.2pF | ±0.1pF | GQM1875C2E2R2BB12# | p178 |
| | | | | ±0.25pF | GQM1875C2E2R2CB12# | p178 |
| | | | 2.4pF | ±0.1pF | GQM1875C2E2R4BB12# | p178 |
| | | | | ±0.25pF | GQM1875C2E2R4CB12# | p178 |
| | | | 2.7pF | ±0.1pF | GQM1875C2E2R7BB12# | p178 |
| | | | | ±0.25pF | GQM1875C2E2R7CB12# | p178 |
| | | | 3.0pF | ±0.1pF | GQM1875C2E3R0BB12# | p178 |
| | | | | ±0.25pF | GQM1875C2E3R0CB12# | p178 |
| | | | 3.3pF | ±0.1pF | GQM1875C2E3R3BB12# | p178 |
| | | | | ±0.25pF | GQM1875C2E3R3CB12# | p178 |
| | | | 3.6pF | ±0.1pF | GQM1875C2E3R6BB12# | p178 |
| | | | | ±0.25pF | GQM1875C2E3R6CB12# | p178 |
| | | | 3.9pF | ±0.1pF | GQM1875C2E3R9BB12# | p178 |
| | | | | ±0.25pF | GQM1875C2E3R9CB12# | p178 |
| | | | 4.0pF | ±0.1pF | GQM1875C2E4R0BB12# | p178 |
| | | | | ±0.25pF | GQM1875C2E4R0CB12# | p178 |
| | | | 4.3pF | ±0.1pF | GQM1875C2E4R3BB12# | p178 |
| | | | | ±0.25pF | GQM1875C2E4R3CB12# | p178 |
| | | | 4.7pF | ±0.1pF | GQM1875C2E4R7BB12# | p178 |
| | | | | ±0.25pF | GQM1875C2E4R7CB12# | p178 |
| | | | 5.0pF | ±0.1pF | GQM1875C2E5R0BB12# | p178 |
| | | | | ±0.25pF | GQM1875C2E5R0CB12# | p178 |
| | | | 5.1pF | ±0.25pF | GQM1875C2E5R1CB12# | p178 |
| | | | | ±0.5pF | GQM1875C2E5R1DB12# | p178 |
| | | | 5.6pF | ±0.25pF | GQM1875C2E5R6CB12# | p178 |
| | | | | ±0.5pF | GQM1875C2E5R6DB12# | p178 |
| | | | 6.0pF | ±0.25pF | GQM1875C2E6R0CB12# | p178 |

*: Refers to the page of the "Specifications and Test Methods".

Part number # indicates the package specification code.

GQM Series Temperature Compensating Type Part Number List

(→ 1.6×0.8mm)

| T max. | Rated Voltage | TC Code | Cap. | Tol. | Part Number | p* |
|--------|---------------|---------|-------|---------|--------------------|------|
| 0.8mm | 250Vdc | X8G | 1.1pF | ±0.25pF | GQM1875G2E1R1CB12# | p175 |
| | | | | ±0.1pF | GQM1875G2E1R2BB12# | p175 |
| | | | 1.2pF | ±0.25pF | GQM1875G2E1R2CB12# | p175 |
| | | | | ±0.1pF | GQM1875G2E1R3BB12# | p175 |
| | | | 1.3pF | ±0.25pF | GQM1875G2E1R3CB12# | p175 |
| | | | | ±0.1pF | GQM1875G2E1R5BB12# | p175 |
| | | | 1.5pF | ±0.25pF | GQM1875G2E1R5CB12# | p175 |
| | | | | ±0.1pF | GQM1875G2E1R6BB12# | p175 |
| | | | 1.6pF | ±0.25pF | GQM1875G2E1R6CB12# | p175 |
| | | | | ±0.1pF | GQM1875G2E1R8BB12# | p175 |
| | | | 1.8pF | ±0.25pF | GQM1875G2E1R8CB12# | p175 |
| | | | | ±0.1pF | GQM1875G2E2R0BB12# | p175 |
| | | | 2.0pF | ±0.25pF | GQM1875G2E2R0CB12# | p175 |
| | | | | ±0.1pF | GQM1875G2E2R2BB12# | p175 |
| | | | 2.2pF | ±0.25pF | GQM1875G2E2R2CB12# | p175 |
| | | | | ±0.1pF | GQM1875G2E2R4BB12# | p175 |
| | | | 2.4pF | ±0.25pF | GQM1875G2E2R4CB12# | p175 |
| | | | | ±0.1pF | GQM1875G2E2R7BB12# | p175 |
| | | | 2.7pF | ±0.25pF | GQM1875G2E2R7CB12# | p175 |
| | | | | ±0.1pF | GQM1875G2E3R0BB12# | p175 |
| | | | 3.0pF | ±0.25pF | GQM1875G2E3R0CB12# | p175 |
| | | | | ±0.1pF | GQM1875G2E3R3BB12# | p175 |
| | | | 3.3pF | ±0.25pF | GQM1875G2E3R3CB12# | p175 |
| | | | | ±0.1pF | GQM1875G2E3R6BB12# | p175 |
| | | | 3.6pF | ±0.25pF | GQM1875G2E3R6CB12# | p175 |
| | | | | ±0.1pF | GQM1875G2E3R9BB12# | p175 |
| | | | 3.9pF | ±0.25pF | GQM1875G2E3R9CB12# | p175 |
| | | | | ±0.1pF | GQM1875G2E4R0BB12# | p175 |
| | | | 4.0pF | ±0.25pF | GQM1875G2E4R0CB12# | p175 |
| | | | | ±0.1pF | GQM1875G2E4R3BB12# | p175 |
| | | | 4.3pF | ±0.25pF | GQM1875G2E4R3CB12# | p175 |
| | | | | ±0.1pF | GQM1875G2E4R7BB12# | p175 |
| | | | 4.7pF | ±0.25pF | GQM1875G2E4R7CB12# | p175 |
| | | | | ±0.1pF | GQM1875G2E5R0BB12# | p175 |
| | | | 5.0pF | ±0.25pF | GQM1875G2E5R0CB12# | p175 |
| | | | | ±0.1pF | GQM1875G2E5R1CB12# | p175 |
| | | | 5.1pF | ±0.5pF | GQM1875G2E5R1DB12# | p175 |
| | | | | ±0.25pF | GQM1875G2E5R6CB12# | p175 |
| | | | 5.6pF | ±0.5pF | GQM1875G2E5R6DB12# | p175 |
| | | | | ±0.25pF | GQM1875G2E6R0CB12# | p175 |
| | | | 6.0pF | ±0.5pF | GQM1875G2E6R0DB12# | p175 |
| | | | | ±0.25pF | GQM1875G2E6R2CB12# | p175 |
| | | | 6.2pF | ±0.5pF | GQM1875G2E6R2DB12# | p175 |
| | | | | ±0.25pF | GQM1875G2E6R8CB12# | p175 |
| | | | 6.8pF | ±0.5pF | GQM1875G2E6R8DB12# | p175 |
| | | | | ±0.25pF | GQM1875G2E7R0CB12# | p175 |
| | | | 7.0pF | ±0.5pF | GQM1875G2E7R0DB12# | p175 |
| | | | | ±0.25pF | GQM1875G2E7R5CB12# | p175 |
| | | | 7.5pF | ±0.5pF | GQM1875G2E7R5DB12# | p175 |
| | | | | ±0.25pF | GQM1875G2E8R0CB12# | p175 |
| | | | 8.0pF | ±0.5pF | GQM1875G2E8R0DB12# | p175 |
| | | | | ±0.25pF | GQM1875G2E8R2CB12# | p175 |
| | | | 8.2pF | ±0.5pF | GQM1875G2E8R2DB12# | p175 |
| | | | | ±0.25pF | GQM1875G2E9R0CB12# | p175 |

| T max. | Rated Voltage | TC Code | Cap. | Tol. | Part Number | p* |
|--------|---------------|--------------------|-------|---------|--------------------|------|
| 0.8mm | 250Vdc | X8G | 9.0pF | ±0.5pF | GQM1875G2E9R0DB12# | p175 |
| | | | | ±0.25pF | GQM1875G2E9R1CB12# | p175 |
| | | | 9.1pF | ±0.5pF | GQM1875G2E9R1DB12# | p175 |
| | | | | ±2% | GQM1875G2E100GB12# | p175 |
| | | | 10pF | ±5% | GQM1875G2E100JB12# | p175 |
| | | | | ±2% | GQM1875G2E110GB12# | p175 |
| | | | 11pF | ±5% | GQM1875G2E110JB12# | p175 |
| | | | | ±2% | GQM1875G2E120GB12# | p175 |
| | | | 12pF | ±5% | GQM1875G2E120JB12# | p175 |
| | | | | ±2% | GQM1875G2E130GB12# | p175 |
| | | | 13pF | ±5% | GQM1875G2E130JB12# | p175 |
| | | | | ±2% | GQM1875G2E150GB12# | p175 |
| | | | 15pF | ±5% | GQM1875G2E150JB12# | p175 |
| | | | | ±2% | GQM1875G2E160GB12# | p175 |
| | | | 16pF | ±5% | GQM1875G2E160JB12# | p175 |
| | | | | ±2% | GQM1875G2E180GB12# | p175 |
| | | | 18pF | ±5% | GQM1875G2E180JB12# | p175 |
| | | | | ±2% | GQM1875G2E200GB12# | p175 |
| | | | 20pF | ±5% | GQM1875G2E200JB12# | p175 |
| | | | | ±2% | GQM1875G2E220GB12# | p175 |
| | | | 22pF | ±5% | GQM1875G2E220JB12# | p175 |
| | | | | ±2% | GQM1875G2E240GB12# | p175 |
| | | | 24pF | ±5% | GQM1875G2E240JB12# | p175 |
| | | | | ±2% | GQM1875G2E270GB12# | p175 |
| 27pF | ±5% | GQM1875G2E270JB12# | p175 | | | |
| | ±2% | GQM1875G2E300GB12# | p175 | | | |
| 30pF | ±5% | GQM1875G2E300JB12# | p175 | | | |

2.0×1.25mm

| T max. | Rated Voltage | TC Code | Cap. | Tol. | Part Number | p* |
|--------|---------------|---------|-------|---------|--------------------|------|
| 1.0mm | 500Vdc | X8G | 1.0pF | ±0.1pF | GQM2195G2H1R0BB12# | p175 |
| | | | | ±0.25pF | GQM2195G2H1R0CB12# | p175 |
| | | | 1.1pF | ±0.1pF | GQM2195G2H1R1BB12# | p175 |
| | | | | ±0.25pF | GQM2195G2H1R1CB12# | p175 |
| | | | 1.2pF | ±0.1pF | GQM2195G2H1R2BB12# | p175 |
| | | | | ±0.25pF | GQM2195G2H1R2CB12# | p175 |
| | | | 1.3pF | ±0.1pF | GQM2195G2H1R3BB12# | p175 |
| | | | | ±0.25pF | GQM2195G2H1R3CB12# | p175 |
| | | | 1.5pF | ±0.1pF | GQM2195G2H1R5BB12# | p175 |
| | | | | ±0.25pF | GQM2195G2H1R5CB12# | p175 |
| | | | 1.6pF | ±0.1pF | GQM2195G2H1R6BB12# | p175 |
| | | | | ±0.25pF | GQM2195G2H1R6CB12# | p175 |
| | | | 1.8pF | ±0.1pF | GQM2195G2H1R8BB12# | p175 |
| | | | | ±0.25pF | GQM2195G2H1R8CB12# | p175 |
| | | | 2.0pF | ±0.1pF | GQM2195G2H2R0BB12# | p175 |
| | | | | ±0.25pF | GQM2195G2H2R0CB12# | p175 |
| | | | 2.2pF | ±0.1pF | GQM2195G2H2R2BB12# | p175 |
| | | | | ±0.25pF | GQM2195G2H2R2CB12# | p175 |
| | | | 2.4pF | ±0.1pF | GQM2195G2H2R4BB12# | p175 |
| | | | | ±0.25pF | GQM2195G2H2R4CB12# | p175 |
| | | | 2.7pF | ±0.1pF | GQM2195G2H2R7BB12# | p175 |
| | | | | ±0.25pF | GQM2195G2H2R7CB12# | p175 |

*: Refers to the page of the "Specifications and Test Methods".

Part number # indicates the package specification code.

GRM
 GR3
 GRJ
 GR4
 GR7
 GJM
 GQM
 GA2
 GA3 GB
 GA3 GD
 GA3 GF
 LLL
 LLA
 LLM
 LLR
 NFM
 KRM
 KR3
 GMA
 GMD
 ⚠Caution /Notice

GQM Series Temperature Compensating Type Part Number List

(→ 2.0×1.25mm)

| T max. | Rated Voltage | TC Code | Cap. | Tol. | Part Number | p* |
|--------|---------------|---------------------------|-------|---------|---------------------------|------|
| 1.0mm | 500Vdc | X8G | 3.0pF | ±0.1pF | GQM2195G2H3R0BB12# | p175 |
| | | | | ±0.25pF | GQM2195G2H3R0CB12# | p175 |
| | | | 3.3pF | ±0.1pF | GQM2195G2H3R3BB12# | p175 |
| | | | | ±0.25pF | GQM2195G2H3R3CB12# | p175 |
| | | | 3.6pF | ±0.1pF | GQM2195G2H3R6BB12# | p175 |
| | | | | ±0.25pF | GQM2195G2H3R6CB12# | p175 |
| | | | 3.9pF | ±0.1pF | GQM2195G2H3R9BB12# | p175 |
| | | | | ±0.25pF | GQM2195G2H3R9CB12# | p175 |
| | | | 4.0pF | ±0.1pF | GQM2195G2H4R0BB12# | p175 |
| | | | | ±0.25pF | GQM2195G2H4R0CB12# | p175 |
| | | | 4.3pF | ±0.1pF | GQM2195G2H4R3BB12# | p175 |
| | | | | ±0.25pF | GQM2195G2H4R3CB12# | p175 |
| | | | 4.7pF | ±0.1pF | GQM2195G2H4R7BB12# | p175 |
| | | | | ±0.25pF | GQM2195G2H4R7CB12# | p175 |
| | | | 5.0pF | ±0.1pF | GQM2195G2H5R0BB12# | p175 |
| | | | | ±0.25pF | GQM2195G2H5R0CB12# | p175 |
| | | | 5.1pF | ±0.25pF | GQM2195G2H5R1CB12# | p175 |
| | | | | ±0.5pF | GQM2195G2H5R1DB12# | p175 |
| | | | 5.6pF | ±0.25pF | GQM2195G2H5R6CB12# | p175 |
| | | | | ±0.5pF | GQM2195G2H5R6DB12# | p175 |
| | | | 6.0pF | ±0.25pF | GQM2195G2H6R0CB12# | p175 |
| | | | | ±0.5pF | GQM2195G2H6R0DB12# | p175 |
| | | | 6.2pF | ±0.25pF | GQM2195G2H6R2CB12# | p175 |
| | | | | ±0.5pF | GQM2195G2H6R2DB12# | p175 |
| | | | 6.8pF | ±0.25pF | GQM2195G2H6R8CB12# | p175 |
| | | | | ±0.5pF | GQM2195G2H6R8DB12# | p175 |
| | | | 7.0pF | ±0.25pF | GQM2195G2H7R0CB12# | p175 |
| | | | | ±0.5pF | GQM2195G2H7R0DB12# | p175 |
| | | | 7.5pF | ±0.25pF | GQM2195G2H7R5CB12# | p175 |
| | | | | ±0.5pF | GQM2195G2H7R5DB12# | p175 |
| | | | 8.0pF | ±0.25pF | GQM2195G2H8R0CB12# | p175 |
| | | | | ±0.5pF | GQM2195G2H8R0DB12# | p175 |
| | | | 8.2pF | ±0.25pF | GQM2195G2H8R2CB12# | p175 |
| | | | | ±0.5pF | GQM2195G2H8R2DB12# | p175 |
| | | | 9.0pF | ±0.25pF | GQM2195G2H9R0CB12# | p175 |
| | | | | ±0.5pF | GQM2195G2H9R0DB12# | p175 |
| | | | 9.1pF | ±0.25pF | GQM2195G2H9R1CB12# | p175 |
| | | | | ±0.5pF | GQM2195G2H9R1DB12# | p175 |
| | | | 10pF | ±2% | GQM2195G2H100GB12# | p175 |
| | | | | ±5% | GQM2195G2H100JB12# | p175 |
| | | | 11pF | ±2% | GQM2195G2H110GB12# | p175 |
| | | | | ±5% | GQM2195G2H110JB12# | p175 |
| | | | 12pF | ±2% | GQM2195G2H120GB12# | p175 |
| | | | | ±5% | GQM2195G2H120JB12# | p175 |
| | | | 13pF | ±2% | GQM2195G2H130GB12# | p175 |
| | | | | ±5% | GQM2195G2H130JB12# | p175 |
| | | | 15pF | ±2% | GQM2195G2H150GB12# | p175 |
| | | | | ±5% | GQM2195G2H150JB12# | p175 |
| | | | 16pF | ±2% | GQM2195G2H160GB12# | p175 |
| | | | | ±5% | GQM2195G2H160JB12# | p175 |
| | | | 18pF | ±2% | GQM2195G2H180GB12# | p175 |
| | | | | ±5% | GQM2195G2H180JB12# | p175 |
| 20pF | ±2% | GQM2195G2H200GB12# | p175 | | | |
| | ±5% | GQM2195G2H200JB12# | p175 | | | |

| T max. | Rated Voltage | TC Code | Cap. | Tol. | Part Number | p* | | |
|--------|---------------|---------------------------|---------------------------|---------|---------------------------|---------|---------------------------|------|
| 1.0mm | 500Vdc | X8G | 22pF | ±2% | GQM2195G2H220GB12# | p175 | | |
| | | | | ±5% | GQM2195G2H220JB12# | p175 | | |
| | | | 250Vdc | COG | 1.0pF | ±0.1pF | GQM2195C2E1R0BB12# | p178 |
| | | | | | | ±0.25pF | GQM2195C2E1R0CB12# | p178 |
| | | | 1.1pF | ±0.1pF | GQM2195C2E1R1BB12# | p178 | | |
| | | | | ±0.25pF | GQM2195C2E1R1CB12# | p178 | | |
| | 1.2pF | ±0.1pF | GQM2195C2E1R2BB12# | p178 | | | | |
| | | ±0.25pF | GQM2195C2E1R2CB12# | p178 | | | | |
| | 1.3pF | ±0.1pF | GQM2195C2E1R3BB12# | p178 | | | | |
| | | ±0.25pF | GQM2195C2E1R3CB12# | p178 | | | | |
| | 1.5pF | ±0.1pF | GQM2195C2E1R5BB12# | p178 | | | | |
| | | ±0.25pF | GQM2195C2E1R5CB12# | p178 | | | | |
| | 1.6pF | ±0.1pF | GQM2195C2E1R6BB12# | p178 | | | | |
| | | ±0.25pF | GQM2195C2E1R6CB12# | p178 | | | | |
| | 1.8pF | ±0.1pF | GQM2195C2E1R8BB12# | p178 | | | | |
| | | ±0.25pF | GQM2195C2E1R8CB12# | p178 | | | | |
| | 2.0pF | ±0.1pF | GQM2195C2E2R0BB12# | p178 | | | | |
| | | ±0.25pF | GQM2195C2E2R0CB12# | p178 | | | | |
| | 2.2pF | ±0.1pF | GQM2195C2E2R2BB12# | p178 | | | | |
| | | ±0.25pF | GQM2195C2E2R2CB12# | p178 | | | | |
| | 2.4pF | ±0.1pF | GQM2195C2E2R4BB12# | p178 | | | | |
| | | ±0.25pF | GQM2195C2E2R4CB12# | p178 | | | | |
| | 2.7pF | ±0.1pF | GQM2195C2E2R7BB12# | p178 | | | | |
| | | ±0.25pF | GQM2195C2E2R7CB12# | p178 | | | | |
| | 3.0pF | ±0.1pF | GQM2195C2E3R0BB12# | p178 | | | | |
| | | ±0.25pF | GQM2195C2E3R0CB12# | p178 | | | | |
| | 3.3pF | ±0.1pF | GQM2195C2E3R3BB12# | p178 | | | | |
| | | ±0.25pF | GQM2195C2E3R3CB12# | p178 | | | | |
| | 3.6pF | ±0.1pF | GQM2195C2E3R6BB12# | p178 | | | | |
| | | ±0.25pF | GQM2195C2E3R6CB12# | p178 | | | | |
| | 3.9pF | ±0.1pF | GQM2195C2E3R9BB12# | p178 | | | | |
| | | ±0.25pF | GQM2195C2E3R9CB12# | p178 | | | | |
| | 4.0pF | ±0.1pF | GQM2195C2E4R0BB12# | p178 | | | | |
| | | ±0.25pF | GQM2195C2E4R0CB12# | p178 | | | | |
| | 4.3pF | ±0.1pF | GQM2195C2E4R3BB12# | p178 | | | | |
| | | ±0.25pF | GQM2195C2E4R3CB12# | p178 | | | | |
| | 4.7pF | ±0.1pF | GQM2195C2E4R7BB12# | p178 | | | | |
| | | ±0.25pF | GQM2195C2E4R7CB12# | p178 | | | | |
| | 5.0pF | ±0.1pF | GQM2195C2E5R0BB12# | p178 | | | | |
| | | ±0.25pF | GQM2195C2E5R0CB12# | p178 | | | | |
| | 5.1pF | ±0.25pF | GQM2195C2E5R1CB12# | p178 | | | | |
| | | ±0.5pF | GQM2195C2E5R1DB12# | p178 | | | | |
| 5.6pF | ±0.25pF | GQM2195C2E5R6CB12# | p178 | | | | | |
| | ±0.5pF | GQM2195C2E5R6DB12# | p178 | | | | | |
| 6.0pF | ±0.25pF | GQM2195C2E6R0CB12# | p178 | | | | | |
| | ±0.5pF | GQM2195C2E6R0DB12# | p178 | | | | | |
| 6.2pF | ±0.25pF | GQM2195C2E6R2CB12# | p178 | | | | | |
| | ±0.5pF | GQM2195C2E6R2DB12# | p178 | | | | | |
| 6.8pF | ±0.25pF | GQM2195C2E6R8CB12# | p178 | | | | | |
| | ±0.5pF | GQM2195C2E6R8DB12# | p178 | | | | | |
| 7.0pF | ±0.25pF | GQM2195C2E7R0CB12# | p178 | | | | | |
| | ±0.5pF | GQM2195C2E7R0DB12# | p178 | | | | | |
| 7.5pF | ±0.25pF | GQM2195C2E7R5CB12# | p178 | | | | | |
| | ±0.5pF | GQM2195C2E7R5DB12# | p178 | | | | | |

*: Refers to the page of the "Specifications and Test Methods".

Part number # indicates the package specification code.

GQM Series Temperature Compensating Type Part Number List

(→ 2.0×1.25mm)

| T max. | Rated Voltage | TC Code | Cap. | Tol. | Part Number | p* |
|--------|---------------|--------------------|-------|---------|--------------------|------|
| 1.0mm | 250Vdc | COG | 8.0pF | ±0.25pF | GQM2195C2E8R0CB12# | p178 |
| | | | | ±0.5pF | GQM2195C2E8R0DB12# | p178 |
| | | | 8.2pF | ±0.25pF | GQM2195C2E8R2CB12# | p178 |
| | | | | ±0.5pF | GQM2195C2E8R2DB12# | p178 |
| | | | 9.0pF | ±0.25pF | GQM2195C2E9R0CB12# | p178 |
| | | | | ±0.5pF | GQM2195C2E9R0DB12# | p178 |
| | | | 9.1pF | ±0.25pF | GQM2195C2E9R1CB12# | p178 |
| | | | | ±0.5pF | GQM2195C2E9R1DB12# | p178 |
| | | | 10pF | ±2% | GQM2195C2E100GB12# | p178 |
| | | | | ±5% | GQM2195C2E100JB12# | p178 |
| | | | 11pF | ±2% | GQM2195C2E110GB12# | p178 |
| | | | | ±5% | GQM2195C2E110JB12# | p178 |
| | | | 12pF | ±2% | GQM2195C2E120GB12# | p178 |
| | | | | ±5% | GQM2195C2E120JB12# | p178 |
| | | | 13pF | ±2% | GQM2195C2E130GB12# | p178 |
| | | | | ±5% | GQM2195C2E130JB12# | p178 |
| | | | 15pF | ±2% | GQM2195C2E150GB12# | p178 |
| | | | | ±5% | GQM2195C2E150JB12# | p178 |
| | | | 16pF | ±2% | GQM2195C2E160GB12# | p178 |
| | | | | ±5% | GQM2195C2E160JB12# | p178 |
| | | | 18pF | ±2% | GQM2195C2E180GB12# | p178 |
| | | | | ±5% | GQM2195C2E180JB12# | p178 |
| | | | 20pF | ±2% | GQM2195C2E200GB12# | p178 |
| | | | | ±5% | GQM2195C2E200JB12# | p178 |
| | | | 22pF | ±2% | GQM2195C2E220GB12# | p178 |
| | | | | ±5% | GQM2195C2E220JB12# | p178 |
| | | | 24pF | ±2% | GQM2195C2E240GB12# | p178 |
| | | | | ±5% | GQM2195C2E240JB12# | p178 |
| | | | 27pF | ±2% | GQM2195C2E270GB12# | p178 |
| | | | | ±5% | GQM2195C2E270JB12# | p178 |
| | | | 30pF | ±2% | GQM2195C2E300GB12# | p178 |
| | | | | ±5% | GQM2195C2E300JB12# | p178 |
| | | | 33pF | ±2% | GQM2195C2E330GB12# | p178 |
| | | | | ±5% | GQM2195C2E330JB12# | p178 |
| | | | 36pF | ±2% | GQM2195C2E360GB12# | p178 |
| | | | | ±5% | GQM2195C2E360JB12# | p178 |
| | | | 39pF | ±2% | GQM2195C2E390GB12# | p178 |
| | | | | ±5% | GQM2195C2E390JB12# | p178 |
| | | | 43pF | ±2% | GQM2195C2E430GB12# | p178 |
| | | | | ±5% | GQM2195C2E430JB12# | p178 |
| | | | 47pF | ±2% | GQM2195C2E470GB12# | p178 |
| | | | | ±5% | GQM2195C2E470JB12# | p178 |
| | | | 51pF | ±2% | GQM2195C2E510GB12# | p178 |
| | | | | ±5% | GQM2195C2E510JB12# | p178 |
| | | | 56pF | ±2% | GQM2195C2E560GB12# | p178 |
| | | | | ±5% | GQM2195C2E560JB12# | p178 |
| | | | 62pF | ±2% | GQM2195C2E620GB12# | p178 |
| | | | | ±5% | GQM2195C2E620JB12# | p178 |
| | | | 68pF | ±2% | GQM2195C2E680GB12# | p178 |
| | | | | ±5% | GQM2195C2E680JB12# | p178 |
| | | | 75pF | ±2% | GQM2195C2E750GB12# | p178 |
| | | | | ±5% | GQM2195C2E750JB12# | p178 |
| 82pF | ±2% | GQM2195C2E820GB12# | p178 | | | |
| | ±5% | GQM2195C2E820JB12# | p178 | | | |

| T max. | Rated Voltage | TC Code | Cap. | Tol. | Part Number | p* | |
|--------|---------------|--------------------|---------|--------------------|--------------------|--------------------|------|
| 1.0mm | 250Vdc | COG | 91pF | ±2% | GQM2195C2E910GB12# | p178 | |
| | | | | ±5% | GQM2195C2E910JB12# | p178 | |
| | | | 100pF | ±2% | GQM2195C2E101GB12# | p178 | |
| | | | | ±5% | GQM2195C2E101JB12# | p178 | |
| | | | X8G | 1.0pF | ±0.1pF | GQM2195G2E1R0BB12# | p175 |
| | | | | | ±0.25pF | GQM2195G2E1R0CB12# | p175 |
| | | | | 1.1pF | ±0.1pF | GQM2195G2E1R1BB12# | p175 |
| | | | | | ±0.25pF | GQM2195G2E1R1CB12# | p175 |
| | | | | 1.2pF | ±0.1pF | GQM2195G2E1R2BB12# | p175 |
| | | | | | ±0.25pF | GQM2195G2E1R2CB12# | p175 |
| | | | | 1.3pF | ±0.1pF | GQM2195G2E1R3BB12# | p175 |
| | | | | | ±0.25pF | GQM2195G2E1R3CB12# | p175 |
| | | 1.5pF | | ±0.1pF | GQM2195G2E1R5BB12# | p175 | |
| | | | | ±0.25pF | GQM2195G2E1R5CB12# | p175 | |
| | | 1.6pF | | ±0.1pF | GQM2195G2E1R6BB12# | p175 | |
| | | | | ±0.25pF | GQM2195G2E1R6CB12# | p175 | |
| | | 1.8pF | | ±0.1pF | GQM2195G2E1R8BB12# | p175 | |
| | | | | ±0.25pF | GQM2195G2E1R8CB12# | p175 | |
| | | 2.0pF | | ±0.1pF | GQM2195G2E2R0BB12# | p175 | |
| | | | | ±0.25pF | GQM2195G2E2R0CB12# | p175 | |
| | | 2.2pF | | ±0.1pF | GQM2195G2E2R2BB12# | p175 | |
| | | | | ±0.25pF | GQM2195G2E2R2CB12# | p175 | |
| | | 2.4pF | | ±0.1pF | GQM2195G2E2R4BB12# | p175 | |
| | | | | ±0.25pF | GQM2195G2E2R4CB12# | p175 | |
| | | 2.7pF | | ±0.1pF | GQM2195G2E2R7BB12# | p175 | |
| | | | | ±0.25pF | GQM2195G2E2R7CB12# | p175 | |
| | | 3.0pF | | ±0.1pF | GQM2195G2E3R0BB12# | p175 | |
| | | | | ±0.25pF | GQM2195G2E3R0CB12# | p175 | |
| | | 3.3pF | | ±0.1pF | GQM2195G2E3R3BB12# | p175 | |
| | | | | ±0.25pF | GQM2195G2E3R3CB12# | p175 | |
| | | 3.6pF | | ±0.1pF | GQM2195G2E3R6BB12# | p175 | |
| | | | | ±0.25pF | GQM2195G2E3R6CB12# | p175 | |
| | | 3.9pF | | ±0.1pF | GQM2195G2E3R9BB12# | p175 | |
| | | | | ±0.25pF | GQM2195G2E3R9CB12# | p175 | |
| | | 4.0pF | | ±0.1pF | GQM2195G2E4R0BB12# | p175 | |
| | | | | ±0.25pF | GQM2195G2E4R0CB12# | p175 | |
| | | 4.3pF | | ±0.1pF | GQM2195G2E4R3BB12# | p175 | |
| | | | | ±0.25pF | GQM2195G2E4R3CB12# | p175 | |
| | | 4.7pF | | ±0.1pF | GQM2195G2E4R7BB12# | p175 | |
| | | | | ±0.25pF | GQM2195G2E4R7CB12# | p175 | |
| | | 5.0pF | | ±0.1pF | GQM2195G2E5R0BB12# | p175 | |
| | | | | ±0.25pF | GQM2195G2E5R0CB12# | p175 | |
| | | 5.1pF | | ±0.25pF | GQM2195G2E5R1CB12# | p175 | |
| | | | | ±0.5pF | GQM2195G2E5R1DB12# | p175 | |
| | | 5.6pF | ±0.25pF | GQM2195G2E5R6CB12# | p175 | | |
| | | | ±0.5pF | GQM2195G2E5R6DB12# | p175 | | |
| | | 6.0pF | ±0.25pF | GQM2195G2E6R0CB12# | p175 | | |
| | | | ±0.5pF | GQM2195G2E6R0DB12# | p175 | | |
| | | 6.2pF | ±0.25pF | GQM2195G2E6R2CB12# | p175 | | |
| | | | ±0.5pF | GQM2195G2E6R2DB12# | p175 | | |
| | | 6.8pF | ±0.25pF | GQM2195G2E6R8CB12# | p175 | | |
| | | | ±0.5pF | GQM2195G2E6R8DB12# | p175 | | |
| 7.0pF | ±0.25pF | GQM2195G2E7R0CB12# | p175 | | | | |
| | ±0.5pF | GQM2195G2E7R0DB12# | p175 | | | | |

*: Refers to the page of the "Specifications and Test Methods".

Part number # indicates the package specification code.

GQM Series Temperature Compensating Type Part Number List

(→ 2.0×1.25mm)

| T max. | Rated Voltage | TC Code | Cap. | Tol. | Part Number | p* |
|--------|---------------|---------|-------|---------|--------------------|------|
| 1.0mm | 250Vdc | X8G | 7.5pF | ±0.25pF | GQM2195G2E7R5CB12# | p175 |
| | | | | ±0.5pF | GQM2195G2E7R5DB12# | p175 |
| | | | 8.0pF | ±0.25pF | GQM2195G2E8R0CB12# | p175 |
| | | | | ±0.5pF | GQM2195G2E8R0DB12# | p175 |
| | | | 8.2pF | ±0.25pF | GQM2195G2E8R2CB12# | p175 |
| | | | | ±0.5pF | GQM2195G2E8R2DB12# | p175 |
| | | | 9.0pF | ±0.25pF | GQM2195G2E9R0CB12# | p175 |
| | | | | ±0.5pF | GQM2195G2E9R0DB12# | p175 |
| | | | 9.1pF | ±0.25pF | GQM2195G2E9R1CB12# | p175 |
| | | | | ±0.5pF | GQM2195G2E9R1DB12# | p175 |
| | | | 10pF | ±2% | GQM2195G2E100GB12# | p175 |
| | | | | ±5% | GQM2195G2E100JB12# | p175 |
| | | | 11pF | ±2% | GQM2195G2E110GB12# | p175 |
| | | | | ±5% | GQM2195G2E110JB12# | p175 |
| | | | 12pF | ±2% | GQM2195G2E120GB12# | p175 |
| | | | | ±5% | GQM2195G2E120JB12# | p175 |
| | | | 13pF | ±2% | GQM2195G2E130GB12# | p175 |
| | | | | ±5% | GQM2195G2E130JB12# | p175 |
| | | | 15pF | ±2% | GQM2195G2E150GB12# | p175 |
| | | | | ±5% | GQM2195G2E150JB12# | p175 |
| | | | 16pF | ±2% | GQM2195G2E160GB12# | p175 |
| | | | | ±5% | GQM2195G2E160JB12# | p175 |
| | | | 18pF | ±2% | GQM2195G2E180GB12# | p175 |
| | | | | ±5% | GQM2195G2E180JB12# | p175 |
| | | | 20pF | ±2% | GQM2195G2E200GB12# | p175 |
| | | | | ±5% | GQM2195G2E200JB12# | p175 |
| | | | 22pF | ±2% | GQM2195G2E220GB12# | p175 |
| | | | | ±5% | GQM2195G2E220JB12# | p175 |
| | | | 24pF | ±2% | GQM2195G2E240GB12# | p175 |
| | | | | ±5% | GQM2195G2E240JB12# | p175 |
| | | | 27pF | ±2% | GQM2195G2E270GB12# | p175 |
| | | | | ±5% | GQM2195G2E270JB12# | p175 |
| | | | 30pF | ±2% | GQM2195G2E300GB12# | p175 |
| | | | | ±5% | GQM2195G2E300JB12# | p175 |
| | | | 33pF | ±2% | GQM2195G2E330GB12# | p175 |
| | | | | ±5% | GQM2195G2E330JB12# | p175 |
| | | | 36pF | ±2% | GQM2195G2E360GB12# | p175 |
| | | | | ±5% | GQM2195G2E360JB12# | p175 |
| | | | 39pF | ±2% | GQM2195G2E390GB12# | p175 |
| | | | | ±5% | GQM2195G2E390JB12# | p175 |
| | | | 43pF | ±2% | GQM2195G2E430GB12# | p175 |
| | | | | ±5% | GQM2195G2E430JB12# | p175 |
| | | | 47pF | ±2% | GQM2195G2E470GB12# | p175 |
| | | | | ±5% | GQM2195G2E470JB12# | p175 |
| | | | 51pF | ±2% | GQM2195G2E510GB12# | p175 |
| | | | | ±5% | GQM2195G2E510JB12# | p175 |
| | | | 56pF | ±2% | GQM2195G2E560GB12# | p175 |
| | | | | ±5% | GQM2195G2E560JB12# | p175 |
| | | | 62pF | ±2% | GQM2195G2E620GB12# | p175 |
| | | | | ±5% | GQM2195G2E620JB12# | p175 |
| | | | 68pF | ±2% | GQM2195G2E680GB12# | p175 |
| | | | | ±5% | GQM2195G2E680JB12# | p175 |
| | | | 75pF | ±2% | GQM2195G2E750GB12# | p175 |
| | | | | ±5% | GQM2195G2E750JB12# | p175 |

| T max. | Rated Voltage | TC Code | Cap. | Tol. | Part Number | p* |
|--------|---------------|---------|------|------|--------------------|------|
| 1.0mm | 250Vdc | X8G | 82pF | ±2% | GQM2195G2E820GB12# | p175 |
| | | | | ±5% | GQM2195G2E820JB12# | p175 |

2.8×2.8mm

| T max. | Rated Voltage | TC Code | Cap. | Tol. | Part Number | p* |
|--------|---------------|--------------------|-------|---------|--------------------|------|
| 1.35mm | 500Vdc | COG | 1.0pF | ±0.1pF | GQM22M5C2H1R0BB01# | p181 |
| | | | | ±0.25pF | GQM22M5C2H1R0CB01# | p181 |
| | | | 1.1pF | ±0.1pF | GQM22M5C2H1R1BB01# | p181 |
| | | | | ±0.25pF | GQM22M5C2H1R1CB01# | p181 |
| | | | 1.2pF | ±0.1pF | GQM22M5C2H1R2BB01# | p181 |
| | | | | ±0.25pF | GQM22M5C2H1R2CB01# | p181 |
| | | | 1.3pF | ±0.1pF | GQM22M5C2H1R3BB01# | p181 |
| | | | | ±0.25pF | GQM22M5C2H1R3CB01# | p181 |
| | | | 1.5pF | ±0.1pF | GQM22M5C2H1R5BB01# | p181 |
| | | | | ±0.25pF | GQM22M5C2H1R5CB01# | p181 |
| | | | 1.6pF | ±0.1pF | GQM22M5C2H1R6BB01# | p181 |
| | | | | ±0.25pF | GQM22M5C2H1R6CB01# | p181 |
| | | | 1.8pF | ±0.1pF | GQM22M5C2H1R8BB01# | p181 |
| | | | | ±0.25pF | GQM22M5C2H1R8CB01# | p181 |
| | | | 2.0pF | ±0.1pF | GQM22M5C2H2R0BB01# | p181 |
| | | | | ±0.25pF | GQM22M5C2H2R0CB01# | p181 |
| | | | 2.2pF | ±0.1pF | GQM22M5C2H2R2BB01# | p181 |
| | | | | ±0.25pF | GQM22M5C2H2R2CB01# | p181 |
| | | | 2.4pF | ±0.1pF | GQM22M5C2H2R4BB01# | p181 |
| | | | | ±0.25pF | GQM22M5C2H2R4CB01# | p181 |
| | | | 2.7pF | ±0.1pF | GQM22M5C2H2R7BB01# | p181 |
| | | | | ±0.25pF | GQM22M5C2H2R7CB01# | p181 |
| | | | 3.0pF | ±0.1pF | GQM22M5C2H3R0BB01# | p181 |
| | | | | ±0.25pF | GQM22M5C2H3R0CB01# | p181 |
| | | | 3.3pF | ±0.1pF | GQM22M5C2H3R3BB01# | p181 |
| | | | | ±0.25pF | GQM22M5C2H3R3CB01# | p181 |
| | | | 3.6pF | ±0.1pF | GQM22M5C2H3R6BB01# | p181 |
| | | | | ±0.25pF | GQM22M5C2H3R6CB01# | p181 |
| | | | 3.9pF | ±0.1pF | GQM22M5C2H3R9BB01# | p181 |
| | | | | ±0.25pF | GQM22M5C2H3R9CB01# | p181 |
| | | | 4.0pF | ±0.1pF | GQM22M5C2H4R0BB01# | p181 |
| | | | | ±0.25pF | GQM22M5C2H4R0CB01# | p181 |
| | | | 4.3pF | ±0.1pF | GQM22M5C2H4R3BB01# | p181 |
| | | | | ±0.25pF | GQM22M5C2H4R3CB01# | p181 |
| | | | 4.7pF | ±0.1pF | GQM22M5C2H4R7BB01# | p181 |
| | | | | ±0.25pF | GQM22M5C2H4R7CB01# | p181 |
| | | | 5.0pF | ±0.1pF | GQM22M5C2H5R0BB01# | p181 |
| | | | | ±0.25pF | GQM22M5C2H5R0CB01# | p181 |
| | | | 5.1pF | ±0.25pF | GQM22M5C2H5R1CB01# | p181 |
| | | | | ±0.5pF | GQM22M5C2H5R1DB01# | p181 |
| | | | 5.6pF | ±0.25pF | GQM22M5C2H5R6CB01# | p181 |
| | | | | ±0.5pF | GQM22M5C2H5R6DB01# | p181 |
| 6.0pF | ±0.25pF | GQM22M5C2H6R0CB01# | p181 | | | |
| | ±0.5pF | GQM22M5C2H6R0DB01# | p181 | | | |
| 6.2pF | ±0.25pF | GQM22M5C2H6R2CB01# | p181 | | | |
| | ±0.5pF | GQM22M5C2H6R2DB01# | p181 | | | |
| 6.8pF | ±0.25pF | GQM22M5C2H6R8CB01# | p181 | | | |

*: Refers to the page of the "Specifications and Test Methods".

Part number # indicates the package specification code.

GQM Series Temperature Compensating Type Part Number List

(→ 2.8×2.8mm)

| T max. | Rated Voltage | TC Code | Cap. | Tol. | Part Number | p* |
|--------|---------------|--------------------|-------|---------|--------------------|------|
| 1.35mm | 500Vdc | COG | 6.8pF | ±0.5pF | GQM22M5C2H6R8DB01# | p181 |
| | | | | ±0.25pF | GQM22M5C2H7R0CB01# | p181 |
| | | | 7.0pF | ±0.5pF | GQM22M5C2H7R0DB01# | p181 |
| | | | | ±0.25pF | GQM22M5C2H7R5CB01# | p181 |
| | | | 7.5pF | ±0.25pF | GQM22M5C2H7R5DB01# | p181 |
| | | | | ±0.5pF | GQM22M5C2H8R0CB01# | p181 |
| | | | 8.0pF | ±0.25pF | GQM22M5C2H8R0DB01# | p181 |
| | | | | ±0.5pF | GQM22M5C2H8R2CB01# | p181 |
| | | | 8.2pF | ±0.25pF | GQM22M5C2H8R2DB01# | p181 |
| | | | | ±0.5pF | GQM22M5C2H9R0CB01# | p181 |
| | | | 9.0pF | ±0.25pF | GQM22M5C2H9R0DB01# | p181 |
| | | | | ±0.5pF | GQM22M5C2H9R1CB01# | p181 |
| | | | 9.1pF | ±0.25pF | GQM22M5C2H9R1DB01# | p181 |
| | | | | ±0.5pF | GQM22M5C2H100GB01# | p181 |
| | | | 10pF | ±2% | GQM22M5C2H100JB01# | p181 |
| | | | | ±5% | GQM22M5C2H110GB01# | p181 |
| | | | 11pF | ±2% | GQM22M5C2H110JB01# | p181 |
| | | | | ±5% | GQM22M5C2H120GB01# | p181 |
| | | | 12pF | ±2% | GQM22M5C2H120JB01# | p181 |
| | | | | ±5% | GQM22M5C2H130GB01# | p181 |
| | | | 13pF | ±2% | GQM22M5C2H130JB01# | p181 |
| | | | | ±5% | GQM22M5C2H150GB01# | p181 |
| | | | 15pF | ±2% | GQM22M5C2H150JB01# | p181 |
| | | | | ±5% | GQM22M5C2H160GB01# | p181 |
| | | | 16pF | ±2% | GQM22M5C2H160JB01# | p181 |
| | | | | ±5% | GQM22M5C2H180GB01# | p181 |
| | | | 18pF | ±2% | GQM22M5C2H180JB01# | p181 |
| | | | | ±5% | GQM22M5C2H200GB01# | p181 |
| | | | 20pF | ±2% | GQM22M5C2H200JB01# | p181 |
| | | | | ±5% | GQM22M5C2H220GB01# | p181 |
| | | | 22pF | ±2% | GQM22M5C2H220JB01# | p181 |
| | | | | ±5% | GQM22M5C2H240GB01# | p181 |
| | | | 24pF | ±2% | GQM22M5C2H240JB01# | p181 |
| | | | | ±5% | GQM22M5C2H270GB01# | p181 |
| | | | 27pF | ±2% | GQM22M5C2H270JB01# | p181 |
| | | | | ±5% | GQM22M5C2H300GB01# | p181 |
| | | | 30pF | ±2% | GQM22M5C2H300JB01# | p181 |
| | | | | ±5% | GQM22M5C2H330GB01# | p181 |
| | | | 33pF | ±2% | GQM22M5C2H330JB01# | p181 |
| | | | | ±5% | GQM22M5C2H360GB01# | p181 |
| | | | 36pF | ±2% | GQM22M5C2H360JB01# | p181 |
| | | | | ±5% | GQM22M5C2H390GB01# | p181 |
| | | | 39pF | ±2% | GQM22M5C2H390JB01# | p181 |
| | | | | ±5% | GQM22M5C2H430GB01# | p181 |
| | | | 43pF | ±2% | GQM22M5C2H430JB01# | p181 |
| | | | | ±5% | GQM22M5C2H470GB01# | p181 |
| | | | 47pF | ±2% | GQM22M5C2H470JB01# | p181 |
| | | | | ±5% | GQM22M5C2H510GB01# | p181 |
| | | | 51pF | ±2% | GQM22M5C2H510JB01# | p181 |
| | | | | ±5% | GQM22M5C2H560GB01# | p181 |
| | | | 56pF | ±2% | GQM22M5C2H560JB01# | p181 |
| | | | | ±5% | GQM22M5C2H620GB01# | p181 |
| | | | 62pF | ±2% | GQM22M5C2H620JB01# | p181 |
| | | | | ±5% | GQM22M5C2H680GB01# | p181 |
| 68pF | ±2% | GQM22M5C2H680JB01# | p181 | | | |

| T max. | Rated Voltage | TC Code | Cap. | Tol. | Part Number | p* |
|--------|---------------|---------|-------|------|--------------------|------|
| 1.35mm | 500Vdc | COG | 68pF | ±5% | GQM22M5C2H680JB01# | p181 |
| | | | | ±2% | GQM22M5C2H750GB01# | p181 |
| | | | 75pF | ±2% | GQM22M5C2H750JB01# | p181 |
| | | | | ±5% | GQM22M5C2H820GB01# | p181 |
| | | | 82pF | ±2% | GQM22M5C2H820JB01# | p181 |
| | | | | ±5% | GQM22M5C2H910GB01# | p181 |
| | | | 91pF | ±2% | GQM22M5C2H910JB01# | p181 |
| | | | | ±5% | GQM22M5C2H101GB01# | p181 |
| | | | 100pF | ±2% | GQM22M5C2H101JB01# | p181 |
| | | | | ±5% | GQM22M5C2H101JB01# | p181 |

*: Refers to the page of the "Specifications and Test Methods".

Part number # indicates the package specification code.

GRM
 GR3
 GRJ
 GRU
 GR4
 GR7
 GJM
 GQM
 GA2
 GA3 GB
 GA3 GD
 GA3 GF
 LLL
 LLA
 LLM
 LLR
 NFM
 KRM
 KR3
 GMA
 GMD
 ⚠Caution / Notice

1

GQM Series Specifications and Test Methods (1)

| No | Item | Specification | Test Method (Ref. Standard: JIS C 5101, IEC60384) | | | | | | | | | | | | |
|-----------------|--|---|--|---------------|------------------|---------|-----------------------|------------|-------------------------|---|--------------------|---|-------------------------|---|--------------------|
| 1 | Rated Voltage | Shown in Rated value. | The rated voltage is defined as the maximum voltage which may be applied continuously to the capacitor. When AC voltage is superimposed on DC voltage, V^{P-P} or V^{O-P} , whichever is larger, should be maintained within the rated voltage range. | | | | | | | | | | | | |
| 2 | Appearance | No defects or abnormalities. | Visual inspection. | | | | | | | | | | | | |
| 3 | Dimension | Within the specified dimensions. | Using Measuring instrument of dimension. | | | | | | | | | | | | |
| 4 | Voltage Proof | No defects or abnormalities. | Measurement Point: Between the terminations Applied Time: 1 to 5s Charge/discharge current: 50mA max. Test Voltage: <table border="1" style="margin-left: 20px;"> <thead> <tr> <th>Rated Voltage</th> <th>Test Voltage</th> </tr> </thead> <tbody> <tr> <td>100V</td> <td>300% of Rated Voltage</td> </tr> <tr> <td>200V</td> <td>250% of Rated Voltage</td> </tr> </tbody> </table> | Rated Voltage | Test Voltage | 100V | 300% of Rated Voltage | 200V | 250% of Rated Voltage | | | | | | |
| Rated Voltage | Test Voltage | | | | | | | | | | | | | | |
| 100V | 300% of Rated Voltage | | | | | | | | | | | | | | |
| 200V | 250% of Rated Voltage | | | | | | | | | | | | | | |
| 5 | Insulation Resistance (I.R.) | More than 10000MΩ | Measurement Point: Between the terminations Measurement Voltage: DC Rated Voltage Charging Time: 2min Charge/discharge current: 50mA max. Measurement Temperature: Room Temperature | | | | | | | | | | | | |
| 6 | Capacitance | Shown in Rated value. | Measurement Temperature: Room Temperature | | | | | | | | | | | | |
| 7 | Q | 30pF and over: $Q \geq 1400$ 30pF and below: $Q \geq 800+20C$ C: Nominal Capacitance(pF) | <table border="1" style="margin-left: 20px;"> <thead> <tr> <th>Capacitance</th> <th>Frequency</th> <th>Voltage</th> </tr> </thead> <tbody> <tr> <td>$C \leq 1000pF$</td> <td>1.0±0.1kHz</td> <td>0.5 to 5.0Vrms</td> </tr> </tbody> </table> | Capacitance | Frequency | Voltage | $C \leq 1000pF$ | 1.0±0.1kHz | 0.5 to 5.0Vrms | | | | | | |
| Capacitance | Frequency | Voltage | | | | | | | | | | | | | |
| $C \leq 1000pF$ | 1.0±0.1kHz | 0.5 to 5.0Vrms | | | | | | | | | | | | | |
| 8 | Temperature Characteristics of Capacitance | Nominal values of the temperature coefficient is shown in Rated value. But, the Capacitance Change under 25°C is shown in Table A. Capacitance Drift Within ±0.2% or ±0.05pF (Whichever is larger.) | The capacitance change should be measured after 5 minutes at each specified temp. stage. Capacitance value as a reference is the value in step 3. The capacitance drift is calculated by dividing the differences between the maximum and minimum measured values in the step 1, 3 and 5 by the cap. value in step 3. <table border="1" style="margin-left: 20px;"> <thead> <tr> <th>Step</th> <th>Temperature (°C)</th> </tr> </thead> <tbody> <tr> <td>1</td> <td>Reference Temp. ±2</td> </tr> <tr> <td>2</td> <td>Min. Operating Temp. ±3</td> </tr> <tr> <td>3</td> <td>Reference Temp. ±2</td> </tr> <tr> <td>4</td> <td>Max. Operating Temp. ±3</td> </tr> <tr> <td>5</td> <td>Reference Temp. ±2</td> </tr> </tbody> </table> | Step | Temperature (°C) | 1 | Reference Temp. ±2 | 2 | Min. Operating Temp. ±3 | 3 | Reference Temp. ±2 | 4 | Max. Operating Temp. ±3 | 5 | Reference Temp. ±2 |
| Step | Temperature (°C) | | | | | | | | | | | | | | |
| 1 | Reference Temp. ±2 | | | | | | | | | | | | | | |
| 2 | Min. Operating Temp. ±3 | | | | | | | | | | | | | | |
| 3 | Reference Temp. ±2 | | | | | | | | | | | | | | |
| 4 | Max. Operating Temp. ±3 | | | | | | | | | | | | | | |
| 5 | Reference Temp. ±2 | | | | | | | | | | | | | | |
| 9 | Adhesive Strength of Termination | No removal of the terminations or other defect should occur. | Solder the capacitor on the test substrate shown in Fig.3. Applied Force: 5N Holding Time: 10±1s Applied Direction: In parallel with the test substrate and vertical with the capacitor side. | | | | | | | | | | | | |
| 10 | Vibration | Appearance | No defects or abnormalities. | | | | | | | | | | | | |
| | | Capacitance | Within the specified initial value. | | | | | | | | | | | | |
| | | Q | Within the specified initial value. | | | | | | | | | | | | |
| 11 | Substrate Bending Test | Appearance | No defects or abnormalities. | | | | | | | | | | | | |
| | | Capacitance Change | Within ±5% or ±0.5pF (Whichever is larger) | | | | | | | | | | | | |
| 12 | Solderability | 95% of the terminations is to be soldered evenly and continuously. | Test Method: Solder bath method Flux: Solution of rosin ethanol 25 (mass)% Preheat: 80 to 120°C for 10 to 30s Solder: Sn-3.0Ag-0.5Cu Solder Temp.: 245±5°C Immersion time: 2±0.5s | | | | | | | | | | | | |
| 13 | Resistance to Soldering Heat | Appearance | No defects or abnormalities. | | | | | | | | | | | | |
| | | Capacitance Change | Within ±2.5% or ±0.25pF (Whichever is larger) | | | | | | | | | | | | |
| | | Q | Within the specified initial value. | | | | | | | | | | | | |
| | | I.R. | Within the specified initial value. | | | | | | | | | | | | |
| | | Voltage Proof | No defects. | | | | | | | | | | | | |

Continued on the following page. ↗

GRM GR3 GRJ GR4 GR7 GJM GQM GA2 GA3 GB GA3 GD GA3 GF LLL LLA LLM LLR NFM KRM KR3 GMA GMD
 ⚠Caution /Notice

GQM Series Specifications and Test Methods (1)

Continued from the preceding page. ↘

| No | Item | Specification | Test Method (Ref. Standard: JIS C 5101, IEC60384) | | | | | | | | | | | | | | | |
|--------------------|---|--------------------|--|--|------------|------------|---|----------------------------|------|---|------------|--------|---|----------------------------|------|---|------------|--------|
| 14 | Temperature Sudden Change | Appearance | Solder the capacitor on the test substrate shown in Fig.3. Perform the 5 cycles according to the four heat treatments shown in the following table. <table border="1" style="margin: 5px 0;"><thead> <tr> <th>Step</th> <th>Temp. (°C)</th> <th>Time (min)</th> </tr> </thead> <tbody> <tr> <td>1</td> <td>Min. Operating Temp. +0/-3</td> <td>30±3</td> </tr> <tr> <td>2</td> <td>Room Temp.</td> <td>2 to 3</td> </tr> <tr> <td>3</td> <td>Max. Operating Temp. +3/-0</td> <td>30±3</td> </tr> <tr> <td>4</td> <td>Room Temp.</td> <td>2 to 3</td> </tr> </tbody> </table> Exposure Time: 24±2h | Step | Temp. (°C) | Time (min) | 1 | Min. Operating Temp. +0/-3 | 30±3 | 2 | Room Temp. | 2 to 3 | 3 | Max. Operating Temp. +3/-0 | 30±3 | 4 | Room Temp. | 2 to 3 |
| | | Step | | Temp. (°C) | Time (min) | | | | | | | | | | | | | |
| | | 1 | | Min. Operating Temp. +0/-3 | 30±3 | | | | | | | | | | | | | |
| | | 2 | | Room Temp. | 2 to 3 | | | | | | | | | | | | | |
| | | 3 | | Max. Operating Temp. +3/-0 | 30±3 | | | | | | | | | | | | | |
| 4 | Room Temp. | 2 to 3 | | | | | | | | | | | | | | | | |
| Capacitance Change | Within ±2.5% or ±0.25pF (Whichever is larger) | | | | | | | | | | | | | | | | | |
| Q | Within the specified initial value. | | | | | | | | | | | | | | | | | |
| I.R. | Within the specified initial value. | | | | | | | | | | | | | | | | | |
| Voltage Proof | No defects. | | | | | | | | | | | | | | | | | |
| 15 | High Temperature High Humidity (Steady) | Appearance | Solder the capacitor on the test substrate shown in Fig.3. Test Temperature: 40±2°C Test Humidity: 90 to 95%RH Test Time: 500±12h Applied Voltage: DC Rated Voltage Charge/discharge current: 50mA max. Exposure Time: 24±2h | | | | | | | | | | | | | | | |
| | | Capacitance Change | | Within ±7.5% or ±0.75pF (Whichever is larger) | | | | | | | | | | | | | | |
| | | Q | | 30pF and over: $Q \geq 200$ 30pF and below: $Q \geq 100+10C/3$ C: Nominal Capacitance(pF) | | | | | | | | | | | | | | |
| | | I.R. | | More than 500MΩ | | | | | | | | | | | | | | |
| 16 | Durability | Appearance | Solder the capacitor on the test substrate shown in Fig.3. Test Temperature: Max. Operating Temp. ±3°C Test Time: 1000±12h Applied Voltage: 200% of the rated voltage Charge/discharge current: 50mA max. Exposure Time: 24±2h | | | | | | | | | | | | | | | |
| | | Capacitance Change | | Within ±3% or ±0.3pF (Whichever is larger) | | | | | | | | | | | | | | |
| | | Q | | 30pF and over: $Q \geq 350$ 10pF and over, 30pF and below: $Q \geq 275+5C/2$ 10pF and below: $Q \geq 200+10C$ C: Nominal Capacitance (pF) | | | | | | | | | | | | | | |
| | | I.R. | | More than 1000MΩ | | | | | | | | | | | | | | |

Table A

| Char. | Capacitance Change from 25°C(%) | | | | | |
|-------|---------------------------------|-------|-------|-------|-------|-------|
| | -55°C | | -30°C | | -10°C | |
| | Max. | Min. | Max. | Min. | Max. | Min. |
| 5C | 0.58 | -0.24 | 0.40 | -0.17 | 0.25 | -0.11 |

Continued on the following page. ↗

GRM
 GR3
 GRJ
 GRU
 GR4
 GR7
 GJM
GQM
 GA2
 GA3 GB
 GA3 GD
 GA3 GF
 LLL
 LLA
 LLM
 LLR
 NFM
 KPM
 KR3
 GMA
 GMD
 ⚠Caution / Notice

GQM Series Specifications and Test Methods (1)

Continued from the preceding page. ↘

Substrate Bending Test

• Test Substrate

Material: Copper-clad laminated sheets for PCBs (Glass fabric base, epoxy resin)
 Thickness: 0.8mm
 Copper foil thickness: 0.035mm
 : Solder resist (Coat with heat resistant resin for solder)

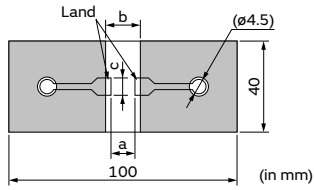

| Part Number | Dimension (mm) | | |
|--------------|----------------|-----|-----|
| | a | b | c |
| GQM15 | 0.4 | 1.5 | 0.5 |

Fig.1

- Kind of Solder: Sn-3.0Ag-0.5Cu
- Pressurization Method



Fig.2

Adhesive Strength of Termination, Vibration, Temperature Sudden Change, High Temperature High Humidity (Steady) , Durability

• Test Substrate

Material: Copper-clad laminated sheets for PCBs (Glass fabric base, epoxy resin)
 Thickness: 1.6mm or 0.8mm
 Copper foil thickness: 0.035mm

- Kind of Solder: Sn-3.0Ag-0.5Cu
- Land Dimensions



| Part Number | Dimension (mm) | | |
|--------------|----------------|-----|-----|
| | a | b | c |
| GQM15 | 0.4 | 1.5 | 0.5 |

Fig.3

GRM
 GR3
 GRJ
 GR4
 GR7
 GJM
GQM
 GA2
 GA3 GB
 GA3 GD
 GA3 GF
 LLL
 LLA
 LLM
 LLR
 NFM
 KRM
 KR3
 GMA
 GMD
 ⚠Caution /Notice

2

GQM Series Specifications and Test Methods (2)

| No | Item | Specification | Test Method (Ref. Standard: JIS C 5101, IEC60384) | | | | | | | | | | | | |
|------------------------|--|--|---|-------------|------------------|---------|-------------------------|-------------------------|------------------------------|---|-------------------------|---|------------------------------|---|-------------------------|
| 1 | Rated Voltage | Shown in Rated value. | The rated voltage is defined as the maximum voltage which may be applied continuously to the capacitor. When AC voltage is superimposed on DC voltage, V^{P-P} or V^{O-P} , whichever is larger, should be maintained within the rated voltage range. | | | | | | | | | | | | |
| 2 | Appearance | No defects or abnormalities. | Visual inspection. | | | | | | | | | | | | |
| 3 | Dimension | Within the specified dimensions. | Using Measuring instrument of dimension. | | | | | | | | | | | | |
| 4 | Voltage Proof | No defects or abnormalities. | Measurement Point: Between the terminations Test Voltage : 250% of the rated voltage Applied Time: 1 to 5s Charge/discharge current: 50mA max. | | | | | | | | | | | | |
| 5 | Insulation Resistance (I.R.) | More than 10000MΩ | Measurement Point: Between the terminations Measurement Voltage: DC Rated Voltage Charging Time: 1min Charge/discharge current: 50mA max. Measurement Temperature: Room Temperature | | | | | | | | | | | | |
| 6 | Capacitance | Shown in Rated value. | Measurement Temperature :Room Temperature <table border="1"> <thead> <tr> <th>Capacitance</th> <th>Frequency</th> <th>Voltage</th> </tr> </thead> <tbody> <tr> <td>$C \leq 1000\text{pF}$</td> <td>$1.0 \pm 0.1\text{MHz}$</td> <td>0.5 to 5.0Vrms</td> </tr> </tbody> </table> | Capacitance | Frequency | Voltage | $C \leq 1000\text{pF}$ | $1.0 \pm 0.1\text{MHz}$ | 0.5 to 5.0Vrms | | | | | | |
| Capacitance | Frequency | Voltage | | | | | | | | | | | | | |
| $C \leq 1000\text{pF}$ | $1.0 \pm 0.1\text{MHz}$ | 0.5 to 5.0Vrms | | | | | | | | | | | | | |
| 7 | Q | 30pF and over: $Q \geq 1400$ 30pF and below: $Q \geq 800+20C$ C: Nominal Capacitance(pF) | | | | | | | | | | | | | |
| 8 | Temperature Characteristics of Capacitance | Nominal values of the temperature coefficient is shown in Rated value. But, the Capacitance Change under 20°C/25°C is shown in Table A. Capacitance Drift Within $\pm 0.2\%$ or $\pm 0.05\text{pF}$ (Whichever is larger.) | The capacitance change should be measured after 5 minutes at each specified temp. stage. Capacitance value as a reference is the value in step 3. The capacitance drift is calculated by dividing the differences between the maximum and minimum measured values in the step 1, 3 and 5 by the cap. value in step 3. <table border="1"> <thead> <tr> <th>Step</th> <th>Temperature (°C)</th> </tr> </thead> <tbody> <tr> <td>1</td> <td>Reference Temp. ± 2</td> </tr> <tr> <td>2</td> <td>Min. Operating Temp. ± 3</td> </tr> <tr> <td>3</td> <td>Reference Temp. ± 2</td> </tr> <tr> <td>4</td> <td>Max. Operating Temp. ± 3</td> </tr> <tr> <td>5</td> <td>Reference Temp. ± 2</td> </tr> </tbody> </table> | Step | Temperature (°C) | 1 | Reference Temp. ± 2 | 2 | Min. Operating Temp. ± 3 | 3 | Reference Temp. ± 2 | 4 | Max. Operating Temp. ± 3 | 5 | Reference Temp. ± 2 |
| Step | Temperature (°C) | | | | | | | | | | | | | | |
| 1 | Reference Temp. ± 2 | | | | | | | | | | | | | | |
| 2 | Min. Operating Temp. ± 3 | | | | | | | | | | | | | | |
| 3 | Reference Temp. ± 2 | | | | | | | | | | | | | | |
| 4 | Max. Operating Temp. ± 3 | | | | | | | | | | | | | | |
| 5 | Reference Temp. ± 2 | | | | | | | | | | | | | | |
| 9 | Adhesive Strength of Termination | No removal of the terminations or other defect should occur. | Solder the capacitor on the test substrate shown in Fig.3. <table border="1"> <thead> <tr> <th>Part Number</th> <th>Applied Force(N)</th> </tr> </thead> <tbody> <tr> <td>GQM18</td> <td>5</td> </tr> <tr> <td>GQM21</td> <td>10</td> </tr> </tbody> </table> Holding Time: 10±1s Applied Direction: In parallel with the test substrate and vertical with the capacitor side. | Part Number | Applied Force(N) | GQM18 | 5 | GQM21 | 10 | | | | | | |
| Part Number | Applied Force(N) | | | | | | | | | | | | | | |
| GQM18 | 5 | | | | | | | | | | | | | | |
| GQM21 | 10 | | | | | | | | | | | | | | |
| 10 | Vibration | Appearance | Solder the capacitor on the test substrate shown in Fig.3. Kind of Vibration: A simple harmonic motion 10Hz to 55Hz to 10Hz (1min) Total amplitude: 1.5mm This motion should be applied for a period of 2h in each 3 mutually perpendicular directions (total of 6h). | | | | | | | | | | | | |
| | | Capacitance | | | | | | | | | | | | | |
| | | Q | | | | | | | | | | | | | |
| 11 | Substrate Bending Test | Appearance | Solder the capacitor on the test substrate shown in Fig.1. Pressurization method: Shown in Fig.2 Flexure: 1mm Holding Time: 5±1s Soldering Method: Reflow soldering | | | | | | | | | | | | |
| | | Capacitance Change | | | | | | | | | | | | | |
| 12 | Solderability | 95% of the terminations is to be soldered evenly and continuously. | Test Method: Solder bath method Flux: Solution of rosin ethanol 25 (mass)% Preheat: 80 to 120°C for 10 to 30s Solder: Sn-3.0Ag-0.5Cu Solder Temp.: 245±5°C Immersion time: 2±0.5s | | | | | | | | | | | | |

Continued on the following page. ↗

GRM
 GR3
 GRJ
 GR4
 GR7
 GJM
GQM
 GA2
 GA3 GB
 GA3 GD
 GA3 GF
 LLL
 LLA
 LLM
 LLR
 NFM
 KPM
 KR3
 GMA
 GMD
 ⚠Caution /Notice

GQM Series Specifications and Test Methods (2)

Continued from the preceding page. ↘

| No | Item | Specification | Test Method (Ref. Standard: JIS C 5101, IEC60384) | | | | | | | | | | | | | | | |
|------|---|--------------------|---|------|------------|------------|---|----------------------------|------|---|------------|--------|---|----------------------------|------|---|------------|--------|
| 13 | Resistance to Soldering Heat | Appearance | No defects or abnormalities. | | | | | | | | | | | | | | | |
| | | Capacitance Change | Within $\pm 2.5\%$ or $\pm 0.25\text{pF}$ (Whichever is larger) | | | | | | | | | | | | | | | |
| | | Q | Within the specified initial value. | | | | | | | | | | | | | | | |
| | | I.R. | Within the specified initial value. | | | | | | | | | | | | | | | |
| | | Voltage Proof | No defects. | | | | | | | | | | | | | | | |
| 14 | Temperature Sudden Change | Appearance | No defects or abnormalities. | | | | | | | | | | | | | | | |
| | | Capacitance Change | Within $\pm 2.5\%$ or $\pm 0.25\text{pF}$ (Whichever is larger) | | | | | | | | | | | | | | | |
| | | Q | Within the specified initial value. | | | | | | | | | | | | | | | |
| | | I.R. | Within the specified initial value. | | | | | | | | | | | | | | | |
| | | Voltage Proof | No defects. | | | | | | | | | | | | | | | |
| | | | Solder the capacitor on the test substrate shown in Fig.3. Perform the 5 cycles according to the four heat treatments shown in the following table. <table border="1" style="margin-top: 10px;"> <thead> <tr> <th>Step</th> <th>Temp. (°C)</th> <th>Time (min)</th> </tr> </thead> <tbody> <tr> <td>1</td> <td>Min. Operating Temp. +0/-3</td> <td>30±3</td> </tr> <tr> <td>2</td> <td>Room Temp.</td> <td>2 to 3</td> </tr> <tr> <td>3</td> <td>Max. Operating Temp. +3/-0</td> <td>30±3</td> </tr> <tr> <td>4</td> <td>Room Temp.</td> <td>2 to 3</td> </tr> </tbody> </table> Exposure Time: 24±2h | Step | Temp. (°C) | Time (min) | 1 | Min. Operating Temp. +0/-3 | 30±3 | 2 | Room Temp. | 2 to 3 | 3 | Max. Operating Temp. +3/-0 | 30±3 | 4 | Room Temp. | 2 to 3 |
| Step | Temp. (°C) | Time (min) | | | | | | | | | | | | | | | | |
| 1 | Min. Operating Temp. +0/-3 | 30±3 | | | | | | | | | | | | | | | | |
| 2 | Room Temp. | 2 to 3 | | | | | | | | | | | | | | | | |
| 3 | Max. Operating Temp. +3/-0 | 30±3 | | | | | | | | | | | | | | | | |
| 4 | Room Temp. | 2 to 3 | | | | | | | | | | | | | | | | |
| 15 | High Temperature High Humidity (Steady) | Appearance | No defects or abnormalities. | | | | | | | | | | | | | | | |
| | | Capacitance Change | Within $\pm 7.5\%$ or $\pm 0.75\text{pF}$ (Whichever is larger) | | | | | | | | | | | | | | | |
| | | Q | 30pF and over: $Q \geq 200$ 30pF and below: $Q \geq 100+10C/3$ C: Nominal Capacitance(pF) | | | | | | | | | | | | | | | |
| | | I.R. | More than 500MΩ | | | | | | | | | | | | | | | |
| | | | Solder the capacitor on the test substrate shown in Fig.3. Test Temperature: 40±2°C Test Humidity: 90 to 95%RH Test Time: 500±12h Applied Voltage: DC Rated Voltage Charge/discharge current: 50mA max. Exposure Time: 24±2h | | | | | | | | | | | | | | | |
| 16 | Durability | Appearance | No defects or abnormalities. | | | | | | | | | | | | | | | |
| | | Capacitance Change | Within $\pm 3\%$ or $\pm 0.3\text{pF}$ (Whichever is larger) | | | | | | | | | | | | | | | |
| | | Q | 30pF and over: $Q \geq 350$ 10pF and over, 30pF and below: $Q \geq 275+5C/2$ 10pF and below: $Q \geq 200+10C$ C: Nominal Capacitance (pF) | | | | | | | | | | | | | | | |
| | | I.R. | More than 1000MΩ | | | | | | | | | | | | | | | |
| | | | Solder the capacitor on the test substrate shown in Fig.3. Test Temperature: Max. Operating Temp. $\pm 3^\circ\text{C}$ Test Time: 1000±12h Applied Voltage: 200% of the rated voltage Charge/discharge current: 50mA max. Exposure Time: 24±2h | | | | | | | | | | | | | | | |

Table A

| Char. | Capacitance Change from 20°C/25°C (%) | | | | | | | |
|-------|---------------------------------------|-------|-------|-------|-------|-------|-------|-------|
| | -55°C | | -30°C | | -25°C | | -10°C | |
| | Max. | Min. | Max. | Min. | Max. | Min. | Max. | Min. |
| 2C | 0.82 | -0.45 | - | - | 0.49 | -0.27 | 0.33 | -0.18 |
| 5C/5G | 0.58 | -0.24 | 0.40 | -0.17 | - | - | 0.25 | -0.11 |

Continued on the following page. ↗

GQM Series Specifications and Test Methods (2)

Continued from the preceding page. ↘

Substrate Bending Test

• Test Substrate

Material: Copper-clad laminated sheets for PCBs (Glass fabric base, epoxy resin)
 Thickness: 1.6mm
 Copper foil thickness: 0.035mm
 [Shaded Area]: Solder resist (Coat with heat resistant resin for solder)

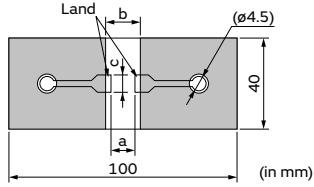

| Part Number | Dimension (mm) | | |
|--------------|----------------|-----|------|
| | a | b | c |
| GQM18 | 1.0 | 3.0 | 1.2 |
| GQM21 | 1.2 | 4.0 | 1.65 |

Fig.1

- Kind of Solder: Sn-3.0Ag-0.5Cu
- Pressurization Method

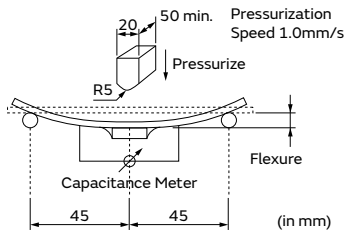

Fig.2

Adhesive Strength of Termination, Vibration, Temperature Sudden Change, High Temperature High Humidity (Steady) , Durability

• Test Substrate

Material: Copper-clad laminated sheets for PCBs (Glass fabric base, epoxy resin)
 Thickness: 1.6mm or 0.8mm
 Copper foil thickness: 0.035mm

- Kind of Solder: Sn-3.0Ag-0.5Cu
- Land Dimensions

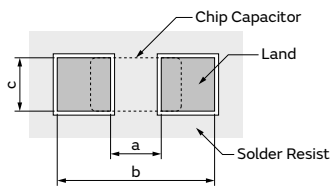

| Part Number | Dimension (mm) | | |
|--------------|----------------|-----|------|
| | a | b | c |
| GQM18 | 1.0 | 3.0 | 1.2 |
| GQM21 | 1.2 | 4.0 | 1.65 |

Fig.3

GRM
 GR3
 GRJ
 GR4
 GR7
 GJM
GQM
 GA2
 GA3 GB
 GA3 GD
 GA3 GF
 LLL
 LLA
 LLM
 LLR
 NFM
 KPM
 KR3
 GMA
 GMD
 ⚠Caution / Notice

3

GQM Series Specifications and Test Methods (3)

| No | Item | Specification | Test Method (Ref. Standard: JIS C 5101, IEC60384) | | | | | | | | | | | | |
|--------------------|---|--|---|------------------------------|--------------------|---|---|-------------------------------------|---|-------------------------------------|--------------------|-------------|---|---|--------------------|
| 1 | Rated Voltage | Shown in Rated value. | The rated voltage is defined as the maximum voltage which may be applied continuously to the capacitor. When AC voltage is superimposed on DC voltage, V^{P-P} or V^{O-P} , whichever is larger, should be maintained within the rated voltage range. | | | | | | | | | | | | |
| 2 | Appearance | No defects or abnormalities. | Visual inspection. | | | | | | | | | | | | |
| 3 | Dimension | Within the specified dimensions. | Using Measuring instrument of dimension. | | | | | | | | | | | | |
| 4 | Voltage Proof | No defects or abnormalities. | Measurement Point: Between the terminations Test Voltage: 250% of the rated voltage Applied Time: 1 to 5s Charge/discharge current: 50mA max. | | | | | | | | | | | | |
| 5 | Insulation Resistance (I.R.) | More than 10000MΩ | Measurement Point: Between the terminations Measurement Voltage: DC Rated Voltage Charging Time: 2min Charge/discharge current: 50mA max. Measurement Temperature: Room Temperature | | | | | | | | | | | | |
| 6 | Capacitance | Shown in Rated value. | Measurement Temperature: Room Temperature | | | | | | | | | | | | |
| 7 | Q | 30pF and over: $Q \geq 1400$ 30pF and below: $Q \geq 800+20C$ C: Nominal Capacitance (pF) | <table border="1"> <thead> <tr> <th>Capacitance</th> <th>Frequency</th> <th>Voltage</th> </tr> </thead> <tbody> <tr> <td>$C \leq 1000pF$</td> <td>1.0±0.1kHz</td> <td>0.5 to 5.0Vrms</td> </tr> </tbody> </table> | Capacitance | Frequency | Voltage | $C \leq 1000pF$ | 1.0±0.1kHz | 0.5 to 5.0Vrms | | | | | | |
| Capacitance | Frequency | Voltage | | | | | | | | | | | | | |
| $C \leq 1000pF$ | 1.0±0.1kHz | 0.5 to 5.0Vrms | | | | | | | | | | | | | |
| 8 | Temperature Characteristics of Capacitance | Nominal values of the temperature coefficient is shown in Rated value. But, the Capacitance Change under 20°C/25°C is shown in Table A. Capacitance Drift Within ±0.2% or ±0.05pF (Whichever is larger.) | The capacitance change should be measured after 5 minutes at each specified temp. stage. Capacitance value as a reference is the value in step 3. The capacitance drift is calculated by dividing the differences between the maximum and minimum measured values in the step 1, 3 and 5 by the cap. value in step 3. <table border="1"> <thead> <tr> <th>Step</th> <th>Temperature (°C)</th> </tr> </thead> <tbody> <tr> <td>1</td> <td>Reference Temp. ±2</td> </tr> <tr> <td>2</td> <td>Min. Operating Temp. ±3</td> </tr> <tr> <td>3</td> <td>Reference Temp. ±2</td> </tr> <tr> <td>4</td> <td>Max. Operating Temp. ±3</td> </tr> <tr> <td>5</td> <td>Reference Temp. ±2</td> </tr> </tbody> </table> | Step | Temperature (°C) | 1 | Reference Temp. ±2 | 2 | Min. Operating Temp. ±3 | 3 | Reference Temp. ±2 | 4 | Max. Operating Temp. ±3 | 5 | Reference Temp. ±2 |
| Step | Temperature (°C) | | | | | | | | | | | | | | |
| 1 | Reference Temp. ±2 | | | | | | | | | | | | | | |
| 2 | Min. Operating Temp. ±3 | | | | | | | | | | | | | | |
| 3 | Reference Temp. ±2 | | | | | | | | | | | | | | |
| 4 | Max. Operating Temp. ±3 | | | | | | | | | | | | | | |
| 5 | Reference Temp. ±2 | | | | | | | | | | | | | | |
| 9 | Adhesive Strength of Termination | No removal of the terminations or other defect should occur. | Solder the capacitor on the test substrate shown in Fig.3. <table border="1"> <thead> <tr> <th>Part Number</th> <th>Applied Force(N)</th> </tr> </thead> <tbody> <tr> <td>GQM18</td> <td>5</td> </tr> <tr> <td>GQM21</td> <td>10</td> </tr> </tbody> </table> Holding Time: 10±1s Applied Direction: In parallel with the test substrate and vertical with the capacitor side. | Part Number | Applied Force(N) | GQM18 | 5 | GQM21 | 10 | | | | | | |
| Part Number | Applied Force(N) | | | | | | | | | | | | | | |
| GQM18 | 5 | | | | | | | | | | | | | | |
| GQM21 | 10 | | | | | | | | | | | | | | |
| 10 | Vibration | <table border="1"> <tr> <td>Appearance</td> <td>No defects or abnormalities.</td> </tr> <tr> <td>Capacitance</td> <td>Within the specified initial value.</td> </tr> <tr> <td>Q</td> <td>Within the specified initial value.</td> </tr> </table> | Appearance | No defects or abnormalities. | Capacitance | Within the specified initial value. | Q | Within the specified initial value. | Solder the capacitor on the test substrate shown in Fig.3. Kind of Vibration: A simple harmonic motion 10Hz to 55Hz to 10Hz (1min) Total amplitude: 1.5mm This motion should be applied for a period of 2h in each 3 mutually perpendicular directions (total of 6h). | | | | | | |
| Appearance | No defects or abnormalities. | | | | | | | | | | | | | | |
| Capacitance | Within the specified initial value. | | | | | | | | | | | | | | |
| Q | Within the specified initial value. | | | | | | | | | | | | | | |
| 11 | Substrate Bending Test | <table border="1"> <tr> <td>Appearance</td> <td>No defects or abnormalities.</td> </tr> <tr> <td>Capacitance Change</td> <td>Within ±5% or ±0.5pF (Whichever is larger)</td> </tr> </table> | Appearance | No defects or abnormalities. | Capacitance Change | Within ±5% or ±0.5pF (Whichever is larger) | Solder the capacitor on the test substrate shown in Fig.1. Pressurization method: Shown in Fig.2 Flexure: 1mm Holding Time: 5±1s Soldering Method: Reflow soldering | | | | | | | | |
| Appearance | No defects or abnormalities. | | | | | | | | | | | | | | |
| Capacitance Change | Within ±5% or ±0.5pF (Whichever is larger) | | | | | | | | | | | | | | |
| 12 | Solderability | 95% of the terminations is to be soldered evenly and continuously. | Test Method: Solder bath method Flux: Solution of rosin ethanol 25 (mass)% Preheat: 80 to 120°C for 10 to 30s Solder: Sn-3.0Ag-0.5Cu Solder Temp.: 245±5°C Immersion time: 2±0.5s | | | | | | | | | | | | |
| 13 | Resistance to Soldering Heat | <table border="1"> <tr> <td>Appearance</td> <td>No defects or abnormalities.</td> </tr> <tr> <td>Capacitance Change</td> <td>Within ±2.5% or ± 0.25pF (Whichever is larger)</td> </tr> <tr> <td>Q</td> <td>Within the specified initial value.</td> </tr> <tr> <td>I.R.</td> <td>Within the specified initial value.</td> </tr> <tr> <td>Voltage Proof</td> <td>No defects.</td> </tr> </table> | Appearance | No defects or abnormalities. | Capacitance Change | Within ±2.5% or ± 0.25pF (Whichever is larger) | Q | Within the specified initial value. | I.R. | Within the specified initial value. | Voltage Proof | No defects. | Test Method: Solder bath method Solder: Sn-3.0Ag-0.5Cu Solder Temp.: 270±5°C Immersion time: 10±0.5s Exposure Time: 24±2h Preheat: 120 to 150°C for 1min | | |
| Appearance | No defects or abnormalities. | | | | | | | | | | | | | | |
| Capacitance Change | Within ±2.5% or ± 0.25pF (Whichever is larger) | | | | | | | | | | | | | | |
| Q | Within the specified initial value. | | | | | | | | | | | | | | |
| I.R. | Within the specified initial value. | | | | | | | | | | | | | | |
| Voltage Proof | No defects. | | | | | | | | | | | | | | |

Continued on the following page. ↗

GRM
 GR3
 GRJ
 GR4
 GR7
 GJM
GQM
 GA2
 GA3
 GB
 GA3
 GD
 GA3
 GF
 LLL
 LLA
 LLM
 LLR
 NFM
 KRM
 KR3
 GMA
 GMD
 ⚠Caution /Notice

GQM Series Specifications and Test Methods (3)

Continued from the preceding page. ↘

| No | Item | Specification | Test Method (Ref. Standard: JIS C 5101, IEC60384) | | | | | | | | | | | | | | | |
|--------------------|---|--------------------|--|--|------------|------------|---|----------------------------|------|---|------------|--------|---|----------------------------|------|---|------------|--------|
| 14 | Temperature Sudden Change | Appearance | Solder the capacitor on the test substrate shown in Fig.3. Perform the 5 cycles according to the four heat treatments shown in the following table. <table border="1" style="margin: 5px 0;"><thead> <tr> <th>Step</th> <th>Temp. (°C)</th> <th>Time (min)</th> </tr> </thead> <tbody> <tr> <td>1</td> <td>Min. Operating Temp. +0/-3</td> <td>30±3</td> </tr> <tr> <td>2</td> <td>Room Temp.</td> <td>2 to 3</td> </tr> <tr> <td>3</td> <td>Max. Operating Temp. +3/-0</td> <td>30±3</td> </tr> <tr> <td>4</td> <td>Room Temp.</td> <td>2 to 3</td> </tr> </tbody> </table> Exposure Time: 24±2h | Step | Temp. (°C) | Time (min) | 1 | Min. Operating Temp. +0/-3 | 30±3 | 2 | Room Temp. | 2 to 3 | 3 | Max. Operating Temp. +3/-0 | 30±3 | 4 | Room Temp. | 2 to 3 |
| | | Step | | Temp. (°C) | Time (min) | | | | | | | | | | | | | |
| | | 1 | | Min. Operating Temp. +0/-3 | 30±3 | | | | | | | | | | | | | |
| | | 2 | | Room Temp. | 2 to 3 | | | | | | | | | | | | | |
| | | 3 | | Max. Operating Temp. +3/-0 | 30±3 | | | | | | | | | | | | | |
| 4 | Room Temp. | 2 to 3 | | | | | | | | | | | | | | | | |
| Capacitance Change | Within ±2.5% or ±0.25pF (Whichever is larger) | | | | | | | | | | | | | | | | | |
| Q | Within the specified initial value. | | | | | | | | | | | | | | | | | |
| I.R. | Within the specified initial value. | | | | | | | | | | | | | | | | | |
| Voltage Proof | No defects. | | | | | | | | | | | | | | | | | |
| 15 | High Temperature High Humidity (Steady) | Appearance | Solder the capacitor on the test substrate shown in Fig.3. Test Temperature: 40±2°C Test Humidity: 90 to 95%RH Test Time: 500±12h Applied Voltage: DC Rated Voltage Charge/discharge current: 50mA max. Exposure Time: 24±2h | | | | | | | | | | | | | | | |
| | | Capacitance Change | | Within ±7.5% or ±0.75pF (Whichever is larger) | | | | | | | | | | | | | | |
| | | Q | | 30pF and over: $Q \geq 200$ 30pF and below: $Q \geq 100+10C/3$ C: Nominal Capacitance(pF) | | | | | | | | | | | | | | |
| | | I.R. | | More than 500MΩ | | | | | | | | | | | | | | |
| 16 | Durability | Appearance | Solder the capacitor on the test substrate shown in Fig.3. Test Temperature: Max. Operating Temp. ±3°C Test Time: 1000±12h Applied Voltage: 200% of the rated voltage Charge/discharge current: 50mA max. Exposure Time: 24±2h | | | | | | | | | | | | | | | |
| | | Capacitance Change | | Within ±3% or ±0.3pF (Whichever is larger) | | | | | | | | | | | | | | |
| | | Q | | 30pF and over: $Q \geq 350$ 10pF and over, 30pF and below: $Q \geq 275+5C/2$ 10pF and below: $Q \geq 200+10C$ C: Nominal Capacitance (pF) | | | | | | | | | | | | | | |
| | | I.R. | | More than 1000MΩ | | | | | | | | | | | | | | |

Table A

| Char. | Capacitance Change from 20°C/25°C (%) | | | | | | | |
|-------|---------------------------------------|-------|-------|-------|-------|-------|-------|-------|
| | -55°C | | -30°C | | -25°C | | -10°C | |
| | Max. | Min. | Max. | Min. | Max. | Min. | Max. | Min. |
| 2C | 0.82 | -0.45 | - | - | 0.49 | -0.27 | 0.33 | -0.18 |
| 5C/5G | 0.58 | -0.24 | 0.40 | -0.17 | - | - | 0.25 | -0.11 |

Continued on the following page. ↗

GRM
GR3
GRJ
GR4
GR7
GJM
GQM
GA2
GA3 GB
GA3 GD
GA3 GF
LLL
LLA
LLM
LLR
NFM
KPM
KR3
GMA
GMD
⚠Caution /Notice

GQM Series Specifications and Test Methods (3)

Continued from the preceding page. ↘

Substrate Bending Test

• Test Substrate

Material: Copper-clad laminated sheets for PCBs (Glass fabric base, epoxy resin)
 Thickness: 1.6mm
 Copper foil thickness: 0.035mm
 : Solder resist (Coat with heat resistant resin for solder)

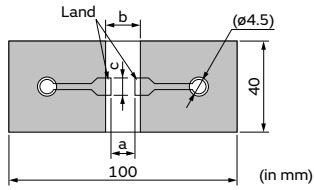

| Part Number | Dimension (mm) | | |
|--------------|----------------|-----|------|
| | a | b | c |
| GQM18 | 1.0 | 3.0 | 1.2 |
| GQM21 | 1.2 | 4.0 | 1.65 |

Fig.1

- Kind of Solder: Sn-3.0Ag-0.5Cu
- Pressurization Method

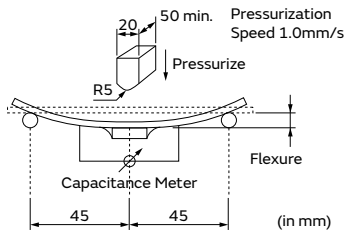

Fig.2

Adhesive Strength of Termination, Vibration, Temperature Sudden Change, High Temperature High Humidity (Steady) , Durability

• Test Substrate

Material: Copper-clad laminated sheets for PCBs (Glass fabric base, epoxy resin)
 Thickness: 1.6mm or 0.8mm
 Copper foil thickness: 0.035mm

- Kind of Solder: Sn-3.0Ag-0.5Cu
- Land Dimensions

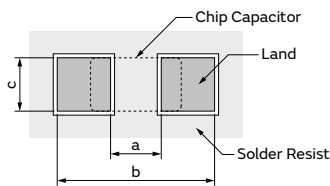

| Part Number | Dimension (mm) | | |
|--------------|----------------|-----|------|
| | a | b | c |
| GQM18 | 1.0 | 3.0 | 1.2 |
| GQM21 | 1.2 | 4.0 | 1.65 |

Fig.3

GRM
GR3
GRJ
GR4
GR7
GJM
GQM
GA2
GA3 GB
GA3 GD
GA3 GF
LLL
LLA
LLM
LLR
NFM
KRM
KR3
GMA
GMD
⚠Caution /Notice

4

GQM Series Specifications and Test Methods (4)

| No | Item | Specification | Test Method (Ref. Standard: JIS C 5101, IEC60384) | | | | | | | | | | | | |
|------------------------|--|---|---|-------------|------------------|---------|------------------------|------------|-------------------------|---|--------------------|---|-------------------------|---|--------------------|
| 1 | Rated Voltage | Shown in Rated value. | The rated voltage is defined as the maximum voltage which may be applied continuously to the capacitor. When AC voltage is superimposed on DC voltage, V^{P-P} or V^{O-P} , whichever is larger, should be maintained within the rated voltage range. | | | | | | | | | | | | |
| 2 | Appearance | No defects or abnormalities. | Visual inspection. | | | | | | | | | | | | |
| 3 | Dimension | Within the specified dimensions. | Using Measuring instrument of dimension. | | | | | | | | | | | | |
| 4 | Voltage Proof | No defects or abnormalities. | Measurement Point: Between the terminations Test Voltage: 250% of the rated voltage Applied Time: 1 to 5s Charge/discharge current: 50mA max. | | | | | | | | | | | | |
| 5 | Insulation Resistance (I.R.) | More than 10000MΩ | Measurement Point: Between the terminations Measurement Voltage: DC Rated Voltage Charging Time: 2min Charge/discharge current: 50mA max. Measurement Temperature: Room Temperature | | | | | | | | | | | | |
| 6 | Capacitance | Shown in Rated value. | Measurement Temperature: Room Temperature <table border="1"> <thead> <tr> <th>Capacitance</th> <th>Frequency</th> <th>Voltage</th> </tr> </thead> <tbody> <tr> <td>$C \leq 1000\text{pF}$</td> <td>1.0±0.1kHz</td> <td>0.5 to 5.0Vrms</td> </tr> </tbody> </table> | Capacitance | Frequency | Voltage | $C \leq 1000\text{pF}$ | 1.0±0.1kHz | 0.5 to 5.0Vrms | | | | | | |
| Capacitance | Frequency | Voltage | | | | | | | | | | | | | |
| $C \leq 1000\text{pF}$ | 1.0±0.1kHz | 0.5 to 5.0Vrms | | | | | | | | | | | | | |
| 7 | Q | 30pF and over: $Q \geq 1400$ 30pF and below: $Q \geq 800+20C$ C: Nominal Capacitance(pF) | | | | | | | | | | | | | |
| 8 | Temperature Characteristics of Capacitance | Nominal values of the temperature coefficient is shown in Rated value. But, the Capacitance Change under 25°C is shown in Table A. Capacitance Drift Within ±0.2% or ±0.05pF (Whichever is larger.) | The capacitance change should be measured after 5 minutes at each specified temp. stage. Capacitance value as a reference is the value in step 3. The capacitance drift is calculated by dividing the differences between the maximum and minimum measured values in the step 1, 3 and 5 by the cap. value in step 3. <table border="1"> <thead> <tr> <th>Step</th> <th>Temperature (°C)</th> </tr> </thead> <tbody> <tr> <td>1</td> <td>Reference Temp. ±2</td> </tr> <tr> <td>2</td> <td>Min. Operating Temp. ±3</td> </tr> <tr> <td>3</td> <td>Reference Temp. ±2</td> </tr> <tr> <td>4</td> <td>Max. Operating Temp. ±3</td> </tr> <tr> <td>5</td> <td>Reference Temp. ±2</td> </tr> </tbody> </table> | Step | Temperature (°C) | 1 | Reference Temp. ±2 | 2 | Min. Operating Temp. ±3 | 3 | Reference Temp. ±2 | 4 | Max. Operating Temp. ±3 | 5 | Reference Temp. ±2 |
| Step | Temperature (°C) | | | | | | | | | | | | | | |
| 1 | Reference Temp. ±2 | | | | | | | | | | | | | | |
| 2 | Min. Operating Temp. ±3 | | | | | | | | | | | | | | |
| 3 | Reference Temp. ±2 | | | | | | | | | | | | | | |
| 4 | Max. Operating Temp. ±3 | | | | | | | | | | | | | | |
| 5 | Reference Temp. ±2 | | | | | | | | | | | | | | |
| 9 | Adhesive Strength of Termination | No removal of the terminations or other defect should occur. | Solder the capacitor on the test substrate shown in Fig.3. Applied Force: 10N Holding Time: 10±1s Applied Direction: In parallel with the test substrate and vertical with the capacitor side. | | | | | | | | | | | | |
| 10 | Vibration | Appearance | Solder the capacitor on the test substrate shown in Fig.3. Kind of Vibration: A simple harmonic motion 10Hz to 55Hz to 10Hz (1min) Total amplitude: 1.5mm This motion should be applied for a period of 2h in each 3 mutually perpendicular directions (total of 6h). | | | | | | | | | | | | |
| | | Capacitance | | | | | | | | | | | | | |
| | | Q | | | | | | | | | | | | | |
| 11 | Substrate Bending Test | Appearance | Solder the capacitor on the test substrate shown in Fig.1. Pressurization method: Shown in Fig.2 Flexure:1mm Holding Time: 5±1s Soldering Method: Reflow soldering | | | | | | | | | | | | |
| | | Capacitance Change | | | | | | | | | | | | | |
| 12 | Solderability | 95% of the terminations is to be soldered evenly and continuously. | Test Method: Solder bath method Flux: Solution of rosin ethanol 25 (mass)% Preheat: 80 to 120°C for 10 to 30s Solder: Sn-3.0Ag-0.5Cu Solder Temp.: 245±5°C Immersion time: 2±0.5s | | | | | | | | | | | | |
| 13 | Resistance to Soldering Heat | Appearance | Test Method: Solder bath method Solder: Sn-3.0Ag-0.5Cu Solder Temp.: 270±5°C Immersion time: 10±0.5s Exposure Time: 24±2h Preheat: 120 to 150°C for 1min | | | | | | | | | | | | |
| | | Capacitance Change | | | | | | | | | | | | | |
| | | Q | | | | | | | | | | | | | |
| | | I.R. | | | | | | | | | | | | | |
| | | Voltage Proof | | | | | | | | | | | | | |

Continued on the following page. ➤

GRM
 GR3
 GRJ
 GR4
 GR7
 GJM
 GQM
 GA2
 GA3 GB
 GA3 GD
 GA3 GF
 LLL
 LLA
 LLM
 LLR
 NFM
 KPM
 KR3
 GMA
 GMD
 ⚠Caution / Notice

GQM Series Specifications and Test Methods (4)

Continued from the preceding page. ↘

| No | Item | Specification | Test Method (Ref. Standard: JIS C 5101, IEC60384) | | | | | | | | | | | | | | | |
|--------------------|---|--|--|------------|------------|------------|---|----------------------------|------|---|------------|--------|---|----------------------------|------|---|------------|--------|
| 14 | Appearance | No defects or abnormalities. | Solder the capacitor on the test substrate shown in Fig.3. Perform the 5 cycles according to the four heat treatments shown in the following table. <table border="1" style="margin: 10px 0;"> <thead> <tr> <th>Step</th> <th>Temp. (°C)</th> <th>Time (min)</th> </tr> </thead> <tbody> <tr> <td>1</td> <td>Min. Operating Temp. +0/-3</td> <td>30±3</td> </tr> <tr> <td>2</td> <td>Room Temp.</td> <td>2 to 3</td> </tr> <tr> <td>3</td> <td>Max. Operating Temp. +3/-0</td> <td>30±3</td> </tr> <tr> <td>4</td> <td>Room Temp.</td> <td>2 to 3</td> </tr> </tbody> </table> Exposure Time: 24±2h | Step | Temp. (°C) | Time (min) | 1 | Min. Operating Temp. +0/-3 | 30±3 | 2 | Room Temp. | 2 to 3 | 3 | Max. Operating Temp. +3/-0 | 30±3 | 4 | Room Temp. | 2 to 3 |
| | Step | Temp. (°C) | | Time (min) | | | | | | | | | | | | | | |
| | 1 | Min. Operating Temp. +0/-3 | | 30±3 | | | | | | | | | | | | | | |
| | 2 | Room Temp. | | 2 to 3 | | | | | | | | | | | | | | |
| | 3 | Max. Operating Temp. +3/-0 | | 30±3 | | | | | | | | | | | | | | |
| 4 | Room Temp. | 2 to 3 | | | | | | | | | | | | | | | | |
| Capacitance Change | Within ±2.5% or ±0.25pF (Whichever is larger) | | | | | | | | | | | | | | | | | |
| Q | Within the specified initial value. | | | | | | | | | | | | | | | | | |
| I.R. | Within the specified initial value. | | | | | | | | | | | | | | | | | |
| Voltage Proof | No defects. | | | | | | | | | | | | | | | | | |
| 15 | Appearance | No defects or abnormalities. | Solder the capacitor on the test substrate shown in Fig.3. Test Temperature: 40±2°C Test Humidity: 90 to 95%RH Test Time: 500±12h Applied Voltage: DC Rated Voltage Charge/discharge current: 50mA max. Exposure Time: 24±2h | | | | | | | | | | | | | | | |
| | Capacitance Change | Within ±7.5% or ±0.75pF (Whichever is larger) | | | | | | | | | | | | | | | | |
| | Q | 30pF and over: $Q \geq 200$ 30pF and below: $Q \geq 100+10C/3$ C: Nominal Capacitance(pF) | | | | | | | | | | | | | | | | |
| | I.R. | More than 500MΩ | | | | | | | | | | | | | | | | |
| 16 | Appearance | No defects or abnormalities. | Solder the capacitor on the test substrate shown in Fig.3. Test Temperature: Max. Operating Temp. ±3°C Test Time: 1000±12h Applied Voltage: 150% of the rated voltage Charge/discharge current: 50mA max. Exposure Time: 24±2h | | | | | | | | | | | | | | | |
| | Capacitance Change | Within ±3% or ±0.3pF (Whichever is larger) | | | | | | | | | | | | | | | | |
| | Q | 30pF and over: $Q \geq 350$ 10pF and over, 30pF and below: $Q \geq 275+5C/2$ 10pF and below: $Q \geq 200+10C$ C: Nominal Capacitance (pF) | | | | | | | | | | | | | | | | |
| | I.R. | More than 1000MΩ | | | | | | | | | | | | | | | | |

Table A

| Char. | Capacitance Change from 25°C(%) | | | | | |
|-------|---------------------------------|-------|-------|-------|-------|-------|
| | -55°C | | -30°C | | -10°C | |
| | Max. | Min. | Max. | Min. | Max. | Min. |
| 5C | 0.58 | -0.24 | 0.40 | -0.17 | 0.25 | -0.11 |

Continued on the following page. ↗

GRM
 GR3
 GRJ
 GR4
 GR7
 GJM
GQM
 GA2
 GA3 GB
 GA3 GD
 GA3 GF
 LLL
 LLA
 LLM
 LLR
 NFM
 KRM
 KR3
 GMA
 GMD
 ⚠Caution /Notice

GQM Series Specifications and Test Methods (4)

Continued from the preceding page. ↘

Substrate Bending Test

• Test Substrate

Material: Copper-clad laminated sheets for PCBs (Glass fabric base, epoxy resin)
 Thickness: 1.6mm
 Copper foil thickness: 0.035mm
 [Grey Box] : Solder resist (Coat with heat resistant resin for solder)

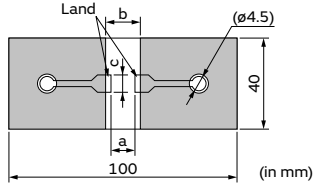

| Part Number | Dimension (mm) | | |
|--------------|----------------|-----|-----|
| | a | b | c |
| GQM22 | 2.2 | 5.0 | 2.9 |

Fig.1

- Kind of Solder: Sn-3.0Ag-0.5Cu
- Pressurization Method

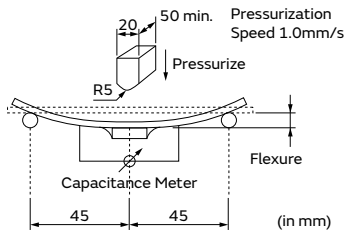

Fig.2

Adhesive Strength of Termination, Vibration, Temperature Sudden Change, High Temperature High Humidity (Steady) , Durability

• Test Substrate

Material: Copper-clad laminated sheets for PCBs (Glass fabric base, epoxy resin)
 Thickness: 1.6mm or 0.8mm
 Copper foil thickness: 0.035mm

- Kind of Solder: Sn-3.0Ag-0.5Cu
- Land Dimensions

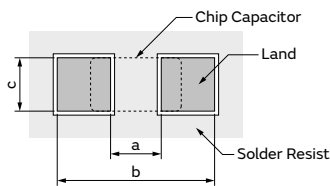

| Part Number | Dimension (mm) | | |
|--------------|----------------|-----|-----|
| | a | b | c |
| GQM22 | 2.2 | 5.0 | 2.9 |

Fig.3

GRM
 GR3
 GRJ
 GR4
 GR7
 GJM
GQM
 GA2
 GA3 GB
 GA3 GD
 GA3 GF
 LLL
 LLA
 LLM
 LLR
 NFM
 KPM
 KR3
 GMA
 GMD
 ⚠Caution / Notice

Based on the Electrical Appliance and Material Safety Law of Japan Chip Multilayer Ceramic Capacitors for General Purpose

GA2 Series



This product is for commercial power supplies, compliant with the Electrical Appliance and Material Safety Law of Japan.

Features

- 1 Sn plating is applied to the external electrodes, providing excellent solderability.

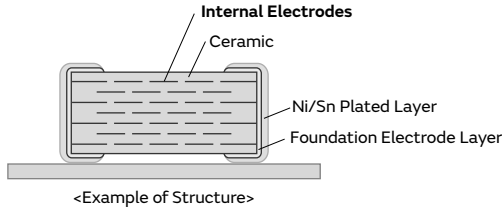

- 2 Realized large capacitance value and small size while maintaining high withstand voltages by the multilayer structure.
- 3 This product is only for reflow soldering.
- 4 There are types for connections between lines and connections between lines and ground.

Specifications

| | |
|-------------------|---------------------------|
| Size (mm) | 4.5×2.0mm to 5.7×5.0mm |
| Rated Voltage | 250Vac |
| Capacitance | 470pF to 0.10μF |
| Main Applications | General purpose for Japan |

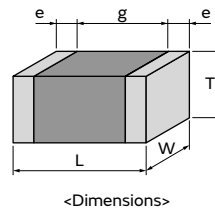

This catalog contains only a portion of the product lineup.
 Please refer to the capacitor search tool on the Murata Web site for details.

GRM
 GR3
 GRJ
 GR4
 GR7
 GJM
 GQM
GA2
 GA3 GB
 GA3 GD
 GA3 GF
 LLL
 LLA
 LLM
 LLR
 NFM
 KRM
 KR3
 GMA
 GMD
 ⚠Caution /Notice

GA2 Series High Dielectric Constant Type Part Number List

4.5×2.0mm

| T max. | Rated Voltage | TC Code | Cap. | Tol. | Part Number | p* |
|--------|---------------|---------|--------|------|---------------------------|------|
| 1.5mm | 250Vac | X7R | 470pF | ±20% | GA242QR7E2471MW01# | p186 |
| | | | 1000pF | ±20% | GA242QR7E2102MW01# | p186 |

4.5×3.2mm

| T max. | Rated Voltage | TC Code | Cap. | Tol. | Part Number | p* |
|--------|---------------|---------|---------|------|---------------------------|------|
| 1.5mm | 250Vac | X7R | 2200pF | ±20% | GA243QR7E2222MW01# | p186 |
| | | | 3300pF | ±20% | GA243QR7E2332MW01# | p186 |
| | | | 10000pF | ±20% | GA243QR7E2103MW01# | p186 |
| | | | 22000pF | ±20% | GA243QR7E2223MW01# | p186 |
| 2.0mm | 250Vac | X7R | 4700pF | ±20% | GA243DR7E2472MW01# | p186 |
| | | | 47000pF | ±20% | GA243DR7E2473MW01# | p186 |

5.7×5.0mm

| T max. | Rated Voltage | TC Code | Cap. | Tol. | Part Number | p* |
|--------|---------------|---------|--------|------|---------------------------|------|
| 2.0mm | 250Vac | X7R | 0.10μF | ±20% | GA255DR7E2104MW01# | p186 |

*: Refers to the page of the "Specifications and Test Methods".

Part number # indicates the package specification code.

1

GA2 Series Specifications and Test Methods (1)

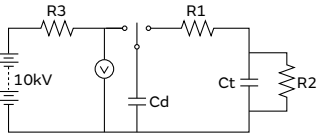
| No | Item | Specification | Test Method (Ref. Standard: JIS C 5101, IEC60384) | | | | | | | | | | | | |
|------|--|--|--|------|------------------|---|--------------------|---|-------------------------|---|--------------------|---|-------------------------|---|--------------------|
| 1 | Appearance | No defects or abnormalities. | Visual inspection. | | | | | | | | | | | | |
| 2 | Dimension | Within the specified dimensions. | Using calipers and micrometers. | | | | | | | | | | | | |
| 3 | Voltage Proof | No defects or abnormalities. | Measurement Point: Between the terminations Test Voltage: 10000pF min.: AC575V (r.m.s.) less than 10000pF: AC1500V (r.m.s.) Applied Time: 60±1s Charge/discharge current: 50mA max. | | | | | | | | | | | | |
| 4 | Insulation Resistance (I.R.) | 2000MΩ or more | Measurement Point: Between the terminations Measurement Voltage: DC500±50V Charging Time: 60±5s Measurement Temperature: Room Temperature | | | | | | | | | | | | |
| 5 | Capacitance | Shown in Rated value. | Measurement Temperature: Room Temperature Measurement Frequency: 1.0±0.1kHz | | | | | | | | | | | | |
| 6 | Dissipation Factor (D.F.) | 0.025 max. | Measurement Voltage: AC1.0±0.2V (r.m.s.) | | | | | | | | | | | | |
| 7 | Temperature Characteristics of Capacitance | R7: Within ±15% (-55 to +125°C) | The capacitance change should be measured after 5 minutes at each specified temp. stage. Capacitance value as a reference is the value in step 3. <table border="1"> <thead> <tr> <th>Step</th> <th>Temperature (°C)</th> </tr> </thead> <tbody> <tr> <td>1</td> <td>Reference Temp. ±2</td> </tr> <tr> <td>2</td> <td>Min. Operating Temp. ±3</td> </tr> <tr> <td>3</td> <td>Reference Temp. ±2</td> </tr> <tr> <td>4</td> <td>Max. Operating Temp. ±3</td> </tr> <tr> <td>5</td> <td>Reference Temp. ±2</td> </tr> </tbody> </table> •Pretreatment Perform a heat treatment at 150+0/-10°C for 1h±5min and then let sit for 24±2h at room condition (*1). | Step | Temperature (°C) | 1 | Reference Temp. ±2 | 2 | Min. Operating Temp. ±3 | 3 | Reference Temp. ±2 | 4 | Max. Operating Temp. ±3 | 5 | Reference Temp. ±2 |
| Step | Temperature (°C) | | | | | | | | | | | | | | |
| 1 | Reference Temp. ±2 | | | | | | | | | | | | | | |
| 2 | Min. Operating Temp. ±3 | | | | | | | | | | | | | | |
| 3 | Reference Temp. ±2 | | | | | | | | | | | | | | |
| 4 | Max. Operating Temp. ±3 | | | | | | | | | | | | | | |
| 5 | Reference Temp. ±2 | | | | | | | | | | | | | | |
| 8 | Discharge Test (Application: C < 10000pF) C: Nominal Capacitance | No defects or abnormalities. | As in below figure, discharge is made 50 times at 5s intervals from the capacitor (Cd) charged at DC voltage of specified.  Ct: Capacitor under test, Cd: 0.001μF R1: 1000Ω, R2: 100MΩ, R3: Surge resistance | | | | | | | | | | | | |
| 9 | Vibration | Appearance | No defects or abnormalities. | | | | | | | | | | | | |
| | | Capacitance | Within the specified initial value. | | | | | | | | | | | | |
| | | D.F. | Within the specified initial value. | | | | | | | | | | | | |
| 10 | Solderability | 95% of the terminations is to be soldered evenly and continuously. | Test Method: Solder bath method Flux: Solution of rosin ethanol 25 (wt) % Preheat: 80 to 120°C for 10 to 30s Solder: Sn-3.0Ag-0.5Cu (Lead Free Solder) Solder Temp.: 245±5°C Immersion time: 2±0.5s Immersing in speed: 25±2.5mm/s. | | | | | | | | | | | | |
| 11 | Resistance to Soldering Heat | Appearance | No defects or abnormalities. | | | | | | | | | | | | |
| | | Capacitance Change | Within ±10% | | | | | | | | | | | | |
| | | D.F. | Within the specified initial value. | | | | | | | | | | | | |
| | | I.R. | Within the specified initial value. | | | | | | | | | | | | |
| | | Voltage Proof | No defects. | | | | | | | | | | | | |
| | | | Test Method: Solder bath method Solder: Sn-3.0Ag-0.5Cu (Lead Free Solder) Solder Temp.: 260±5°C Immersion time: 10±1s Immersing in speed: 25±2.5mm/s. Exposure Time: 24±2h at room condition (*1). Preheat: GA242 size min.: 100 to 120°C for 1min and 170 to 200°C for 1min • Pretreatment Perform a heat treatment at 150+0/-10°C for 1h±5min and then let sit for 24±2h at room condition (*1). | | | | | | | | | | | | |

*1 Room Condition: Temperature: 15 to 35°C, Relative humidity: 45 to 75%, Atmosphere pressure: 86 to 106kPa

Continued on the following page. ↗

⚠Caution /Notice

GRM
 GR3
 GRJ
 GR4
 GR7
 GJM
 GQM
 GA2
 GA3 GB
 GA3 GD
 GA3 GF
 LLL
 LLA
 LLM
 LLR
 NFM
 KRM
 KR3
 GMA
 GMD

GA2 Series Specifications and Test Methods (1)

Continued from the preceding page. ↘

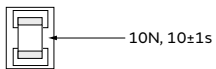
| No | Item | Specification | Test Method (Ref. Standard: JIS C 5101, IEC60384) | | | | | | | | | | | | | | | |
|--------------------|---|--|--|----------------------------|-----------------|--------------|-------------|----------------------------|-----------------|-------------|------------------|-----------------|---|----------------------------|------|---|------------|--------|
| 12 | Adhesive Strength of Termination | No removal of the terminations or other defect should occur. | <p>Solder the capacitor on the test substrate A shown in "Complement of Test Method".</p>  <p>Applied Direction: In parallel with the test substrate and vertical with the capacitor side.</p> | | | | | | | | | | | | | | | |
| 13 | Substrate Bending Test | No defects or abnormalities. | <p>Solder the capacitor on the test substrate B shown in "Complement of Test Method". Then apply the force in the direction shown in "Test Method of Substrate Bending Test" of "Complement of Test Method". Flexure: 1mm Holding Time: 5±1s Soldering Method: Reflow soldering</p> | | | | | | | | | | | | | | | |
| 14 | Temperature Sudden Change | Appearance | <p>Fix the capacitor to the supporting test substrate A (glass epoxy board) shown in "Complement of Test Method". Perform the 5 cycles according to the four heat treatments shown in the following table.</p> <table border="1" data-bbox="933 750 1380 873"> <thead> <tr> <th>Step</th> <th>Temp. (°C)</th> <th>Time (min)</th> </tr> </thead> <tbody> <tr> <td>1</td> <td>Min. Operating Temp. +0/-3</td> <td>30±3</td> </tr> <tr> <td>2</td> <td>Room Temp.</td> <td>2 to 3</td> </tr> <tr> <td>3</td> <td>Max. Operating Temp. +3/-0</td> <td>30±3</td> </tr> <tr> <td>4</td> <td>Room Temp.</td> <td>2 to 3</td> </tr> </tbody> </table> <p>Exposure Time: 24±2h at room condition (*1). • Pretreatment Perform a heat treatment at 150+0/-10°C for 1h±5min and then let sit for 24±2h at room condition (*1).</p> | Step | Temp. (°C) | Time (min) | 1 | Min. Operating Temp. +0/-3 | 30±3 | 2 | Room Temp. | 2 to 3 | 3 | Max. Operating Temp. +3/-0 | 30±3 | 4 | Room Temp. | 2 to 3 |
| | | Step | | Temp. (°C) | Time (min) | | | | | | | | | | | | | |
| | | 1 | | Min. Operating Temp. +0/-3 | 30±3 | | | | | | | | | | | | | |
| | | 2 | | Room Temp. | 2 to 3 | | | | | | | | | | | | | |
| | | 3 | | Max. Operating Temp. +3/-0 | 30±3 | | | | | | | | | | | | | |
| 4 | Room Temp. | 2 to 3 | | | | | | | | | | | | | | | | |
| Capacitance Change | Within ±15% | | | | | | | | | | | | | | | | | |
| D.F. | 0.05 max. | | | | | | | | | | | | | | | | | |
| I.R. | Within the specified initial value. | | | | | | | | | | | | | | | | | |
| Voltage Proof | No defects. | | | | | | | | | | | | | | | | | |
| 15 | Humidity Insulation | Appearance | <p>The capacitor shall be subjected to 40±2°C, relative humidity of 90 to 95% for 8h, and then removed in room condition (*1) for 16h until 5 cycles.</p> | | | | | | | | | | | | | | | |
| | | Capacitance Change | | Within ±15% | | | | | | | | | | | | | | |
| | | D.F. | | 0.05 max. | | | | | | | | | | | | | | |
| | | I.R. | | 1000MΩ or more | | | | | | | | | | | | | | |
| | | Voltage Proof | | No defects. | | | | | | | | | | | | | | |
| 16 | High Temperature High Humidity (Steady) | Appearance | <p>Fix the capacitor to the supporting test substrate A (glass epoxy board) shown in "Complement of Test Method". Test Temperature: 40±2°C Test Humidity: 90 to 95%RH Test Time: 500+24/-0h. Applied Voltage: Rated voltage Exposure Time: 24±2h at room condition (*1). • Pretreatment Apply test voltage for 1h±5min at test temperature. Remove and let sit for 24±2h at room condition (*1).</p> | | | | | | | | | | | | | | | |
| | | Capacitance Change | | Within ±15% | | | | | | | | | | | | | | |
| | | D.F. | | 0.05 max. | | | | | | | | | | | | | | |
| | | I.R. | | 1000MΩ or more | | | | | | | | | | | | | | |
| | | Voltage Proof | | No defects. | | | | | | | | | | | | | | |
| 17 | Durability | Appearance | <p>Fix the capacitor to the supporting test substrate A (glass epoxy board) shown in "Complement of Test Method". Test Temperature: Max. Operating Temp. ±3°C Charge/discharge current: 50mA max.</p> <table border="1" data-bbox="933 1601 1452 1668"> <thead> <tr> <th>Nominal Capacitance</th> <th>Test Time</th> <th>Test Voltage</th> </tr> </thead> <tbody> <tr> <td>C ≥ 10000pF</td> <td>1000+48/-0h</td> <td>AC300V (r.m.s.)</td> </tr> <tr> <td>C < 10000pF</td> <td>1500+48/-0h (*2)</td> <td>AC500V (r.m.s.)</td> </tr> </tbody> </table> <p>*2 Except that once each hour the voltage is increased to AC1000V (r.m.s.) for 0.1s. Exposure Time: 24±2h at room condition (*1). • Pretreatment Apply test voltage for 1h±5min at test temperature. Remove and let sit for 24±2h at room condition (*1).</p> | Nominal Capacitance | Test Time | Test Voltage | C ≥ 10000pF | 1000+48/-0h | AC300V (r.m.s.) | C < 10000pF | 1500+48/-0h (*2) | AC500V (r.m.s.) | | | | | | |
| | | Nominal Capacitance | | Test Time | Test Voltage | | | | | | | | | | | | | |
| | | C ≥ 10000pF | | 1000+48/-0h | AC300V (r.m.s.) | | | | | | | | | | | | | |
| | | C < 10000pF | | 1500+48/-0h (*2) | AC500V (r.m.s.) | | | | | | | | | | | | | |
| | | Capacitance Change | | Within ±20% | | | | | | | | | | | | | | |
| D.F. | 0.05 max. | | | | | | | | | | | | | | | | | |
| I.R. | 1000MΩ or more | | | | | | | | | | | | | | | | | |
| Voltage Proof | No defects. | | | | | | | | | | | | | | | | | |

*1 Room Condition: Temperature: 15 to 35°C, Relative humidity: 45 to 75%, Atmosphere pressure: 86 to 106kPa

Continued on the following page. ↗

GRM
 GR3
 GRJ
 GR4
 GR7
 GJM
 GQM
 GA2
 GA3 GB
 GA3 GD
 GA3 GF
 LLL
 LLA
 LLM
 LLR
 NFM
 KPM
 KR3
 GMA
 GMD
 △Caution / Notice

GA2 Series Specifications and Test Methods (1)

Continued from the preceding page. ↘

Complement of Test Method

1. Test Substrate

The test substrate should be Substrate A or Substrate B as described in "Specifications and Test Methods".
 The specimen should be soldered by the conditions as described below.

Soldering Method: Reflow soldering
 Solder: Sn-3.0Ag-0.5Cu

(1) Test Substrate A

• Land Dimensions

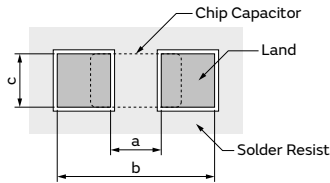

- Material: Glass Epoxy Board
- Thickness: 1.6mm
- Thickness of Copper Foil: 0.035mm

| Part Number | Dimension (mm) | | |
|-------------|----------------|-----|-----|
| | a | b | c |
| GRM42 | 3.5 | 7.0 | 2.4 |
| GRM43 | 3.5 | 7.0 | 3.7 |
| GRM52 | 4.5 | 8.0 | 3.2 |
| GRM55 | 4.5 | 8.0 | 5.6 |

(2) Test Substrate B



- Material: Glass Epoxy Board
- Thickness of Copper Foil: 0.035mm

| Part Number | Dimension of Pattern (mm) | | | |
|-------------|---------------------------|-----|-----|-----|
| | a | b | c | d |
| GRM42 | 3.5 | 7.0 | 2.4 | 1.0 |
| GRM43 | 3.5 | 7.0 | 3.7 | 1.0 |
| GRM52 | 4.5 | 8.0 | 3.2 | 1.0 |
| GRM55 | 4.5 | 8.0 | 5.6 | 1.0 |

2. Test Method of Substrate Bending Test

(a) Support State

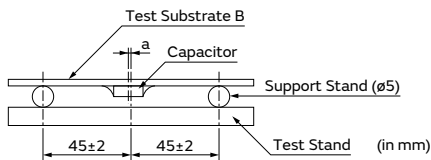

a: ±2 gap between support stand center and test stand

- Material of Test Stand and Pressure Stick
 The material should be a metal where a remarkable transformation and the distortion are not caused even if it is pressurized.
- Pressurizing Speed
 The pressurizing speed is pressurized at the speed of about 1mm/s until the flexure reaches a regulated value.

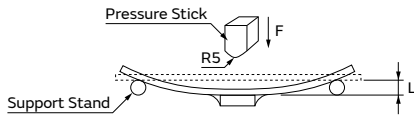

(b) Test State

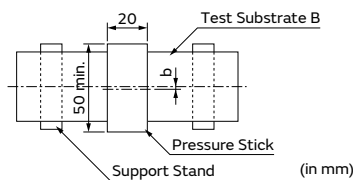

b: ±5 gap between support stand center and test stand center

GRM
 GR3
 GRJ
 GR4
 GR7
 GJM
 GQM
 GA2
 GA3 GB
 GA3 GD
 GA3 GF
 LLL
 LLA
 LLM
 LLR
 NFM
 KRM
 KR3
 GMA
 GMD
 Caution / Notice

Safety Standard Certified Chip Multilayer Ceramic Capacitors for General Purpose / IEC60384-14 Class X2

GA3 Series Type GB



IEC60384-14 X2 Class Certified Product

Features

- 1 International Standard (IEC60384-14) certified product.

Please down load Safety Standard Certification (Type GB: X2) from here.



- 2 Can be used as a Class X2 capacitor.

- Switching Power Supply - Class 1 Equipment

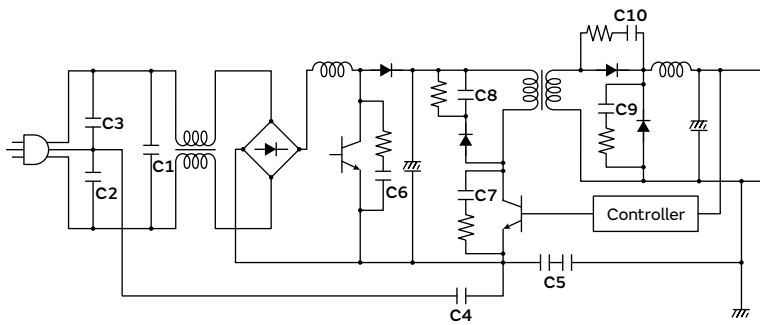

| No. | Application | Recommend MLCC Type |
|-----|------------------------------|---------------------|
| C1 | X Cap | Type: GB |
| C2 | Y Cap | Type: GF |
| C3 | | |
| C4 | | |
| C5 | Primary - Secondary Coupling | Type: GF×2 |

- Switching Power Supply - Class 2 Equipment

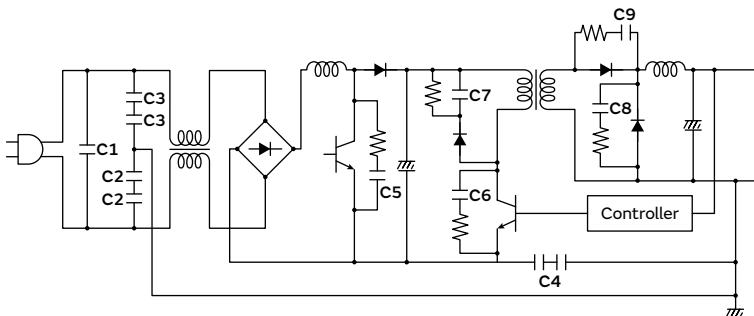

| No. | Application | Recommend MLCC Type |
|-----|------------------------------|---------------------|
| C1 | X Cap | Type: GB |
| C2 | Y Cap | Type: GF×2 |
| C3 | | |
| C4 | Primary - Secondary Coupling | |

- GRM
- GR3
- GRJ
- GR4
- GR7
- GJM
- GQM
- GA2
- GA3 GB
- GA3 GD
- GA3 GF
- LLL
- LLA
- LLM
- LLR
- NFM
- KPM
- KR3
- GMA
- GMD
- △Caution / Notice

GRM
 GR3
 GRJ
 GR4
 GR7
 GJM
 GQM
 GA2
 GA3 GB
 GA3 GD
 GA3 GF
 LLL
 LLA
 LLM
 LLR
 NFM
 KRM
 KR3
 GMA
 GMD
 ⚠Caution /Notice

- 3 Realized large capacitance value and small size while maintaining high withstand voltages by the multilayer structure.

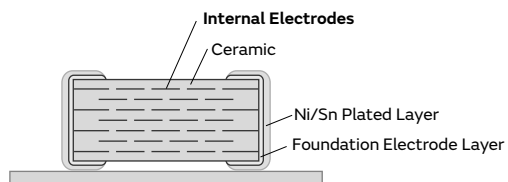

<Example of Structure>

- 4 Compared with conventional lead type capacitors, this product realized great reductions in size and height, with a volume of 1/10 or less, and height of 1/4 or less.
- 5 This product is only for reflow soldering.

Specifications

| | |
|-------------------|--------------------|
| Size (mm) | 5.7×5.0mm |
| Rated Voltage | 250Vac |
| Capacitance | 10000pF to 56000pF |
| Main Applications | AC-DC power supply |

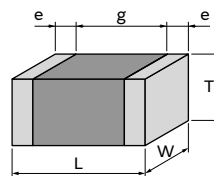

<Dimensions>

This catalog contains only a portion of the product lineup.
 Please refer to the capacitor search tool on the Murata Web site for details.

GA3 Series Type GB High Dielectric Constant Type Part Number List

5.7×5.0mm

| T max. | Rated Voltage | TC Code | Cap. | Tol. | Part Number | p* |
|--------|---------------|---------|---------|------|---------------------------|------|
| 1.5mm | 250Vac | X7R | 10000pF | ±10% | GA355QR7GB103KW01# | p192 |
| | | | 15000pF | ±10% | GA355QR7GB153KW01# | p192 |
| 2.0mm | 250Vac | X7R | 22000pF | ±10% | GA355DR7GB223KW01# | p192 |
| 2.5mm | 250Vac | X7R | 33000pF | ±10% | GA355ER7GB333KW01# | p192 |
| | | | 47000pF | ±10% | GA355ER7GB473KW01# | p192 |
| 2.9mm | 250Vac | X7R | 56000pF | ±10% | GA355XR7GB563KW06# | p192 |

- GRM
- GR3
- GRJ
- GR4
- GR7
- GJM
- GQM
- GA2
- GA3 GB**
- GA3 GD
- GA3 GF
- LLL
- LLA
- LLM
- LLR
- NFM
- KRM
- KR3
- GMA
- GMD
- ⚠Caution /Notice

*: Refers to the page of the "Specifications and Test Methods".

Part number # indicates the package specification code.

1

GA3 Series Type GB Specifications and Test Methods (1)

| No | Item | Specification | Test Method (Ref. Standard: JIS C 5101, IEC60384) | | | | | | | | | | | | |
|------|--|--|---|------|------------------|---|--------------------|---|-------------------------|---|--------------------|---|-------------------------|---|--------------------|
| 1 | Appearance | No defects or abnormalities. | Visual inspection. | | | | | | | | | | | | |
| 2 | Dimension | Within the specified dimensions. | Using calipers and micrometers. | | | | | | | | | | | | |
| 3 | Voltage Proof | No defects or abnormalities. | Measurement Point: Between the terminations Test Voltage: DC1075V Applied Time: 60±1s Charge/discharge current: 50mA max. | | | | | | | | | | | | |
| 4 | Insulation Resistance (I.R.) | 6000MΩ or more | Measurement Point: Between the terminations Measurement Voltage: DC500±50V Charging Time: 60±5s Measurement Temperature: Room Temperature | | | | | | | | | | | | |
| 5 | Capacitance | Shown in Rated value. | Measurement Temperature: Room Temperature | | | | | | | | | | | | |
| 6 | Dissipation Factor (D.F.) | 0.025 max. | Measurement Frequency: 1.0±0.1kHz Measurement Voltage: AC1.0±0.2V (r.m.s.) | | | | | | | | | | | | |
| 7 | Temperature Characteristics of Capacitance | R7: Within ±15% (-55 to +125°C) | The capacitance change should be measured after 5 minutes at each specified temp. stage. Capacitance value as a reference is the value in step 3. <table border="1"> <thead> <tr> <th>Step</th> <th>Temperature (°C)</th> </tr> </thead> <tbody> <tr> <td>1</td> <td>Reference Temp. ±2</td> </tr> <tr> <td>2</td> <td>Min. Operating Temp. ±3</td> </tr> <tr> <td>3</td> <td>Reference Temp. ±2</td> </tr> <tr> <td>4</td> <td>Max. Operating Temp. ±3</td> </tr> <tr> <td>5</td> <td>Reference Temp. ±2</td> </tr> </tbody> </table> <ul style="list-style-type: none"> • Pretreatment Perform a heat treatment at 150+0/-10°C for 1h±5min and then let sit for 24±2h. at room condition*. | Step | Temperature (°C) | 1 | Reference Temp. ±2 | 2 | Min. Operating Temp. ±3 | 3 | Reference Temp. ±2 | 4 | Max. Operating Temp. ±3 | 5 | Reference Temp. ±2 |
| Step | Temperature (°C) | | | | | | | | | | | | | | |
| 1 | Reference Temp. ±2 | | | | | | | | | | | | | | |
| 2 | Min. Operating Temp. ±3 | | | | | | | | | | | | | | |
| 3 | Reference Temp. ±2 | | | | | | | | | | | | | | |
| 4 | Max. Operating Temp. ±3 | | | | | | | | | | | | | | |
| 5 | Reference Temp. ±2 | | | | | | | | | | | | | | |
| 8 | Vibration | Appearance | No defects or abnormalities. | | | | | | | | | | | | |
| | | Capacitance | Within the specified initial value. | | | | | | | | | | | | |
| | | D.F. | Within the specified initial value. | | | | | | | | | | | | |
| 9 | Solderability | 95% of the terminations is to be soldered evenly and continuously. | Test Method: Solder bath method Flux: Solution of rosin ethanol 25 (wt)% Preheat: 80 to 120°C for 10 to 30s Solder: Sn-3.0Ag-0.5Cu (Lead Free Solder) Solder Temp.: 245±5°C Immersion time: 2±0.5s Immersing in speed: 25±2.5mm/s. | | | | | | | | | | | | |
| 10 | Resistance to Soldering Heat | Appearance | No defects or abnormalities. | | | | | | | | | | | | |
| | | Capacitance Change | Within ±10% | | | | | | | | | | | | |
| | | I.R. | 1000MΩ or more | | | | | | | | | | | | |
| | | Voltage Proof | No defects. | | | | | | | | | | | | |
| 11 | Adhesive Strength of Termination | No removal of the terminations or other defect should occur. | Solder the capacitor on the test substrate A shown in "Complement of Test Method".  Applied Direction: In parallel with the test substrate and vertical with the capacitor side. | | | | | | | | | | | | |
| 12 | Substrate Bending Test | No defects or abnormalities. | Solder the capacitor on the test substrate B shown in "Complement of Test Method". Then apply the force in the direction shown in "Test Method of Substrate Bending Test" of "Complement of Test Method". Flexure: 1mm Holding Time: 5±1s Soldering Method: Reflow soldering | | | | | | | | | | | | |

* Room Condition: Temperature: 15 to 35°C, Relative humidity: 45 to 75%, Atmosphere pressure: 86 to 106kPa

Continued on the following page. ↗

GRM
GR3
GRJ
GR4
GR7
GJM
GQM
GA2
GA3 GB
GA3 GD
GA3 GF
LLL
LLA
LLM
LLR
NFM
KRM
KR3
GMA
GMD
⚠Caution /Notice

GA3 Series Type GB Specifications and Test Methods (1)

Continued from the preceding page. ↘

| No | Item | Specification | Test Method (Ref. Standard: JIS C 5101, IEC60384) | | | | | | | | | | | | | | | |
|--------------------|---|--------------------|--|---|------------|--------------------|---|----------------------------|------|---|------------|--------|---|----------------------------|------|---|------------|--------|
| 13 | Temperature Sudden Change | Appearance | Fix the capacitor to the supporting test substrate A (glass epoxy board) shown in "Complement of Test Method". Perform the 5 cycles according to the four heat treatments shown in the following table. <table border="1" style="margin: 10px 0;"> <thead> <tr> <th>Step</th> <th>Temp. (°C)</th> <th>Time (min)</th> </tr> </thead> <tbody> <tr> <td>1</td> <td>Min. Operating Temp. +0/-3</td> <td>30±3</td> </tr> <tr> <td>2</td> <td>Room Temp.</td> <td>2 to 3</td> </tr> <tr> <td>3</td> <td>Max. Operating Temp. +3/-0</td> <td>30±3</td> </tr> <tr> <td>4</td> <td>Room Temp.</td> <td>2 to 3</td> </tr> </tbody> </table> Exposure Time: 24±2h at room condition*. • Pretreatment Perform a heat treatment at 150+0/-10°C for 1h±5min and then let sit for 24±2h at room condition*. | Step | Temp. (°C) | Time (min) | 1 | Min. Operating Temp. +0/-3 | 30±3 | 2 | Room Temp. | 2 to 3 | 3 | Max. Operating Temp. +3/-0 | 30±3 | 4 | Room Temp. | 2 to 3 |
| | | Step | | Temp. (°C) | Time (min) | | | | | | | | | | | | | |
| | | 1 | | Min. Operating Temp. +0/-3 | 30±3 | | | | | | | | | | | | | |
| | | 2 | | Room Temp. | 2 to 3 | | | | | | | | | | | | | |
| | | 3 | | Max. Operating Temp. +3/-0 | 30±3 | | | | | | | | | | | | | |
| 4 | Room Temp. | 2 to 3 | | | | | | | | | | | | | | | | |
| Capacitance Change | Within±15% | | | | | | | | | | | | | | | | | |
| D.F. | 0.05 max. | | | | | | | | | | | | | | | | | |
| I.R. | 3000MΩ or more | | | | | | | | | | | | | | | | | |
| Voltage Proof | No defects. | | | | | | | | | | | | | | | | | |
| 14 | High Temperature High Humidity (Steady) | Appearance | Fix the capacitor to the supporting test substrate B (glass epoxy board) shown in "Complement of Test Method". Before this test, the test shown in the following is performed. • No.11 Adhesive Strength of Termination (apply force: 5N) • No.12 Substrate Bending Test Test Temperature: 40±2°C Test Humidity: 90 to 95%RH Test Time: 500+24/-0h Applied Voltage: Rated voltage Exposure Time: 24±2h at room condition*. • Pretreatment Perform a heat treatment at 150+0/-10°C for 1h±5min and then let sit for 24±2h at room condition*. | | | | | | | | | | | | | | | |
| | | Capacitance Change | | Within±15% | | | | | | | | | | | | | | |
| | | D.F. | | 0.05 max. | | | | | | | | | | | | | | |
| | | I.R. | | 3000MΩ or more | | | | | | | | | | | | | | |
| | | Voltage Proof | | No defects. | | | | | | | | | | | | | | |
| 15 | Durability | Appearance | Fix the capacitor to the supporting test substrate B (glass epoxy board) shown in "Complement of Test Method". Before this test, the test shown in the following is performed. • No.11 Adhesive Strength of Termination (apply force: 5N) • No.12 Substrate Bending Test Next, Impulse Voltage test is performed. Each individual capacitor shall be subjected to a 2.5kV Impulse (the voltage value means zero to peak) for 3 times. Then the capacitors are applied to life test. <div style="text-align: center; margin: 10px 0;"> <p style="margin: 0;">Front time (T1) = 1.2μs=1.67T Time to half-value (T2) = 50μs</p> </div> Apply voltage as Table for 1000h at 125+2/-0°C, relative humidity 50% max. <table border="1" style="margin: 10px 0; width: 100%;"> <thead> <tr> <th colspan="2" style="background-color: #cccccc;">Applied Voltage</th> </tr> </thead> <tbody> <tr> <td style="padding: 2px;">AC312.5V (r.m.s.),</td> <td style="padding: 2px;">except that once each hour the voltage is increased to AC1000V (r.m.s.) for 0.1s.</td> </tr> </tbody> </table> Exposure Time: 24±2h at room condition*. • Pretreatment Perform a heat treatment at 150+0/-10°C for 1h±5min and then let sit for 24±2h at room condition*. | Applied Voltage | | AC312.5V (r.m.s.), | except that once each hour the voltage is increased to AC1000V (r.m.s.) for 0.1s. | | | | | | | | | | | |
| | | Applied Voltage | | | | | | | | | | | | | | | | |
| | | AC312.5V (r.m.s.), | | except that once each hour the voltage is increased to AC1000V (r.m.s.) for 0.1s. | | | | | | | | | | | | | | |
| | | Capacitance Change | | Within ±20% | | | | | | | | | | | | | | |
| | | D.F. | | 0.05 max. | | | | | | | | | | | | | | |
| I.R. | 3000MΩ or more | | | | | | | | | | | | | | | | | |
| Voltage Proof | No defects. | | | | | | | | | | | | | | | | | |

* Room Condition: Temperature: 15 to 35°C, Relative humidity: 45 to 75%, Atmosphere pressure: 86 to 106kPa

Continued on the following page. ↗

GA3 Series Type GB Specifications and Test Methods (1)

Continued from the preceding page. ↘

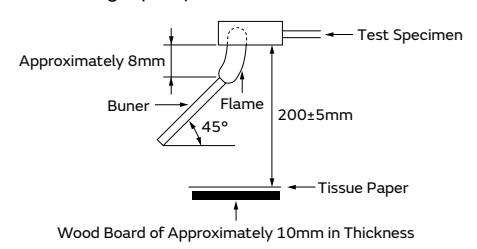
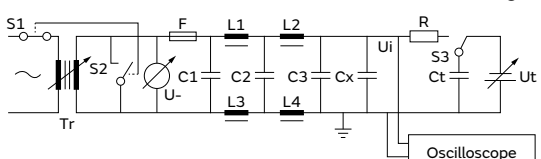
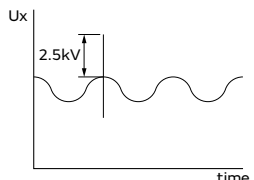
| No | Item | Specification | Test Method (Ref. Standard: JIS C 5101, IEC60384) |
|----|----------------------|--|--|
| 16 | Passive Flammability | The burning time shall not be exceeded the time 30s. The tissue paper shall not ignite. | <p>The capacitor under test shall be held in the flame in the position which best promotes burning. Each specimen shall only be exposed once to the flame. Time of exposure to flame: 30s Length of flame: 12±1mm Gas burner: Length 35mm min. Inside dia: 0.5±0.1mm Outside dia: 0.9mm max. Gas: Butane gas purity 95% min.</p>  |
| 17 | Active Flammability | The cheesecloth shall not be on fire. | <p>The specimens shall be individually wrapped in at least one but more than two complete layers of cheesecloth. The specimens shall be subjected to 20 discharges. The interval between successive discharges shall be 5s. The UAC shall be maintained for 2min after the last discharge.</p>  <p>C1,C2: Filter capacitor 1μF±10% C3: Capacitor 0.033μF±5% L1 to L4: Rod coa choke 1.5mH±20%, 16A R: Resistor 100Ω±2% Cx < 0.068μF Ct: Tank capacitor 3μF±5% 10kV Cx ≤ 1μF U-: UR±5% UR: Rated voltage Cx: Capacitor under test F: Slow-blow fuse, rated 16A Ut: Voltage to which the tank capacitor Ct is charged</p>  |

GA3 Series Type GB Specifications and Test Methods (1)

Continued from the preceding page. ↘

Complement of Test Method

1. Test Substrate

The test substrate should be Substrate A or Substrate B as described in "Specifications and Test Methods".
 The specimen should be soldered by the conditions as described below.

Soldering Method: Reflow soldering
 Solder: Sn-3.0Ag-0.5Cu

(1) Test Substrate A

• Land Dimensions

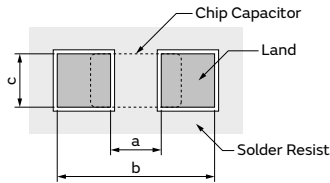

| Part Number | Dimension (mm) | | |
|--------------|----------------|-----|-----|
| | a | b | c |
| GA355 | 4.5 | 8.0 | 5.6 |

- Material: Glass Epoxy Board
- Thickness: 1.6mm
- Thickness of Copper Foil: 0.035mm

(2) Test Substrate B

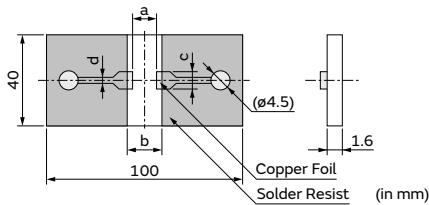

| Part Number | Dimension of Pattern (mm) | | | |
|--------------|---------------------------|-----|-----|-----|
| | a | b | c | d |
| GA355 | 4.5 | 8.0 | 5.6 | 1.0 |

- Material: Glass Epoxy Board
- Thickness of Copper Foil: 0.035mm

2. Test Method of Substrate Bending Test

(a) Support State

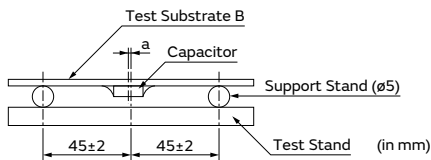

a: ±2 gap between support stand center and test stand

- Material of Test Stand and Pressure Stick
 The material should be a metal where a remarkable transformation and the distortion are not caused even if it is pressurized.
- Pressurizing Speed
 The pressurizing speed is pressurized at the speed of about 1mm/s until the flexure reaches a regulated value.

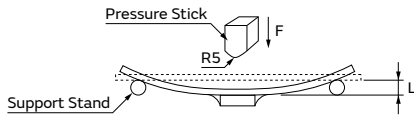

(b) Test State

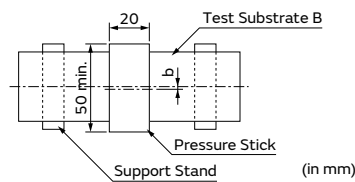

b: ±5 gap between support stand center and test stand center

GRM
 GR3
 GRJ
 GR4
 GR7
 GJM
 GQM
 GA2
 GA3 GB
 GA3 GD
 GA3 GF
 LLL
 LLA
 LLM
 LLR
 NFM
 KPM
 KR3
 GMA
 GMD
 ⚠Caution /Notice

Safety Standard Certified Chip Multilayer Ceramic Capacitors for General Purpose / Acquired certifications of UL60950-1

GA3 Series Type GD



UL60950-1 Certified Product

Features

- 1 International Standard (IEC60384-14) certified product.

Please download Safety Standard Certification (Type GD) from here.



- 2 Can be used for UL60950-1 devices.

● DAA Modem - Transformer Less

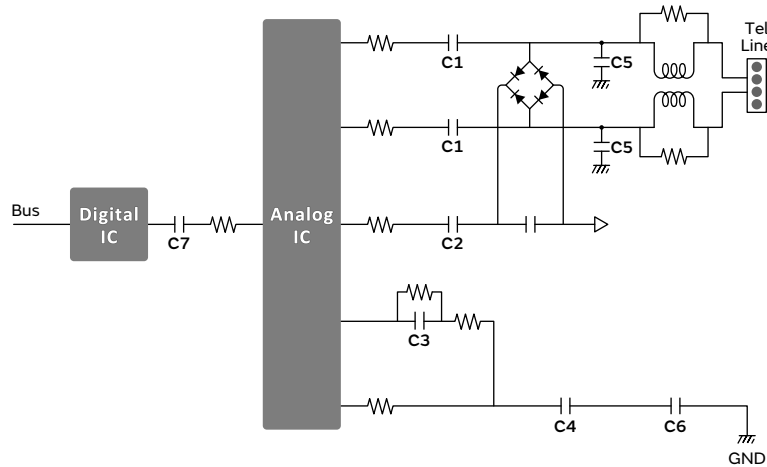

| No. | Application | Recommend MLCC Type |
|-----|---------------------------|---------------------|
| C5 | Lighting Surge Absorption | Type: GD / GF |
| C6 | Noise Immunity | |
| C7 | D/A Isolation Barrier | |

- 3 Realized large capacitance value and small size while maintaining high withstand voltages by the multilayer structure.



- 4 This product is only for reflow soldering.

Specifications

| | |
|-------------------|------------------------|
| Size (mm) | 4.5×2.0mm to 4.5×3.2mm |
| Rated Voltage | 250Vac |
| Capacitance | 10pF to 4700pF |
| Main Applications | Modem |

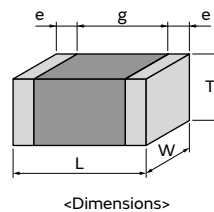

This catalog contains only a portion of the product lineup.
 Please refer to the capacitor search tool on the Murata Web site for details.

GRM
 GR3
 GRJ
 GR4
 GR7
 GJM
 GQM
 GA2
 GA3 GB
 GA3 GD
 GA3 GF
 LLL
 LLA
 LLM
 LLR
 NFM
 KRM
 KR3
 GMA
 GMD
 Caution / Notice

GA3 Series Type GD Temperature Compensating Type Part Number List

4.5×2.0mm

| T max. | Rated Voltage | TC Code | Cap. | Tol. | Part Number | p* |
|--------|---------------|---------|------|------|--------------------|------|
| 1.0mm | 250Vac | SL | 10pF | ±5% | GA342A1XGD100JW31# | p199 |
| | | | 12pF | ±5% | GA342A1XGD120JW31# | p199 |
| | | | 15pF | ±5% | GA342A1XGD150JW31# | p199 |
| | | | 18pF | ±5% | GA342A1XGD180JW31# | p199 |
| | | | 22pF | ±5% | GA342A1XGD220JW31# | p199 |
| | | | 27pF | ±5% | GA342A1XGD270JW31# | p199 |
| | | | 33pF | ±5% | GA342A1XGD330JW31# | p199 |
| | | | 39pF | ±5% | GA342A1XGD390JW31# | p199 |
| | | | 47pF | ±5% | GA342A1XGD470JW31# | p199 |
| | | | 56pF | ±5% | GA342A1XGD560JW31# | p199 |
| | | | 68pF | ±5% | GA342A1XGD680JW31# | p199 |
| | | | 82pF | ±5% | GA342A1XGD820JW31# | p199 |

- GRM
- GR3
- GRJ
- GR4
- GR7
- GJM
- GQM
- GA2
- GA3 GB
- GA3 GD**
- GA3 GF
- LLL
- LLA
- LLM
- LLR
- NFM
- KRM
- KR3
- GMA
- GMD
- ⚠Caution /Notice

*: Refers to the page of the "Specifications and Test Methods".

Part number # indicates the package specification code.

GA3 Series Type GD High Dielectric Constant Type Part Number List

4.5×2.0mm

| T max. | Rated Voltage | TC Code | Cap. | Tol. | Part Number | p* |
|--------|---------------|---------|--------|------|---------------------------|------|
| 1.5mm | 250Vac | X7R | 100pF | ±10% | GA342QR7GD101KW01# | p203 |
| | | | 150pF | ±10% | GA342QR7GD151KW01# | p203 |
| | | | 220pF | ±10% | GA342QR7GD221KW01# | p203 |
| | | | 330pF | ±10% | GA342QR7GD331KW01# | p203 |
| | | | 470pF | ±10% | GA342QR7GD471KW01# | p203 |
| | | | 680pF | ±10% | GA342QR7GD681KW01# | p203 |
| | | | 1000pF | ±10% | GA342QR7GD102KW01# | p203 |
| | | | 1500pF | ±10% | GA342QR7GD152KW01# | p203 |

4.5×3.2mm

| T max. | Rated Voltage | TC Code | Cap. | Tol. | Part Number | p* |
|--------|---------------|---------|--------|------|---------------------------|------|
| 1.5mm | 250Vac | X7R | 1800pF | ±10% | GA343QR7GD182KW01# | p203 |
| | | | 2200pF | ±10% | GA343QR7GD222KW01# | p203 |
| 2.0mm | 250Vac | X7R | 4700pF | ±10% | GA343DR7GD472KW01# | p203 |

- GRM
- GR3
- GRJ
- GR4
- GR7
- GJM
- GQM
- GA2
- GA3 GB
- GA3 GD**
- GA3 GF
- LLL
- LLA
- LLM
- LLR
- NFM
- KRM
- KR3
- GMA
- GMD
- ⚠Caution /Notice

*: Refers to the page of the "Specifications and Test Methods".

Part number # indicates the package specification code.

1

GA3 Series Type GD Specifications and Test Methods (1)

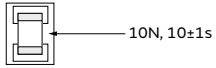
| No | Item | Specification | Test Method (Ref. Standard: JIS C 5101, IEC60384) | | | | | | | | | | | | |
|------|--|--|--|------|------------------|---|--------------------|---|-------------------------|---|--------------------|---|-------------------------|---|--------------------|
| 1 | Appearance | No defects or abnormalities. | Visual inspection. | | | | | | | | | | | | |
| 2 | Dimension | Within the specified dimensions. | Using calipers and micrometers. | | | | | | | | | | | | |
| 3 | Voltage Proof | No defects or abnormalities. | Measurement Point: Between the terminations Test Voltage: AC1500V (r.m.s.) Applied Time: 60±1s Charge/discharge current: 50mA max. | | | | | | | | | | | | |
| 4 | Impulse Voltage | No self healing break downs or flash-overs have taken place in the capacitor. | 10 impulse of alternating polarity is subjected. (5 impulse for each polarity) The interval between impulse is 60s. Applied Voltage: 2.5kVo-p | | | | | | | | | | | | |
| 5 | Insulation Resistance (I.R.) | 6000MΩ or more | Measurement Point: Between the terminations Measurement Voltage: DC500±50V Charging Time: 60±5s Measurement Temperature: Room Temperature | | | | | | | | | | | | |
| 6 | Capacitance | Shown in Rated value. | Measurement Temperature: Room Temperature Measurement Frequency: 1.0±0.1MHz Measurement Voltage: AC1.0±0.2V (r.m.s.) | | | | | | | | | | | | |
| 7 | Q | C ≥ 30pF: 1000 or more C < 30pF: 400+20C or more C: Nominal Capacitance (pF) | | | | | | | | | | | | | |
| 8 | Temperature Characteristics of Capacitance | 1X: +350 to -1000 ppm/°C (Temp.Range:+20 to +85°C) | The capacitance change should be measured after 5 minutes at each specified temp. stage. Capacitance value as a reference is the value in step 3. <table border="1" style="margin-left: auto; margin-right: auto;"> <thead> <tr> <th>Step</th> <th>Temperature (°C)</th> </tr> </thead> <tbody> <tr> <td>1</td> <td>Reference Temp. ±2</td> </tr> <tr> <td>2</td> <td>Min. Operating Temp. ±3</td> </tr> <tr> <td>3</td> <td>Reference Temp. ±2</td> </tr> <tr> <td>4</td> <td>Max. Operating Temp. ±3</td> </tr> <tr> <td>5</td> <td>Reference Temp. ±2</td> </tr> </tbody> </table> However, the capacitance shall be measured at even 85°C between step 3 and step 4. | Step | Temperature (°C) | 1 | Reference Temp. ±2 | 2 | Min. Operating Temp. ±3 | 3 | Reference Temp. ±2 | 4 | Max. Operating Temp. ±3 | 5 | Reference Temp. ±2 |
| Step | Temperature (°C) | | | | | | | | | | | | | | |
| 1 | Reference Temp. ±2 | | | | | | | | | | | | | | |
| 2 | Min. Operating Temp. ±3 | | | | | | | | | | | | | | |
| 3 | Reference Temp. ±2 | | | | | | | | | | | | | | |
| 4 | Max. Operating Temp. ±3 | | | | | | | | | | | | | | |
| 5 | Reference Temp. ±2 | | | | | | | | | | | | | | |
| 9 | Vibration | Appearance | Solder the capacitor on the test substrate A shown in "Complement of Test Method". Kind of Vibration: A simple harmonic motion 10Hz to 55Hz to 10Hz (1min) Total amplitude: 1.5mm This motion should be applied for a period of 2h in each 3 mutually perpendicular directions (total of 6h). | | | | | | | | | | | | |
| | | Capacitance | | | | | | | | | | | | | |
| | | Q | | | | | | | | | | | | | |
| 10 | Solderability | 95% of the terminations is to be soldered evenly and continuously. | Test Method: Solder bath method Flux: Solution of rosin ethanol 25 (wt)% Preheat: 80 to 120°C for 10 to 30s Solder: Sn-3.0Ag-0.5Cu (Lead Free Solder) Solder Temp.: 245±5°C Immersion time: 2±0.5s Immersing in speed: 25±2.5mm/s. | | | | | | | | | | | | |
| 11 | Resistance to Soldering Heat | Appearance | Test Method: Solder bath method Solder: Sn-3.0Ag-0.5Cu (Lead Free Solder) Solder Temp.: 260±5°C Immersion time: 10±1s Immersing in speed: 25±2.5mm/s. Exposure Time: 24±2h at room condition*. Preheat: GA342 size: 100 to 120°C for 1min and 170 to 200°C for 1min | | | | | | | | | | | | |
| | | Capacitance Change | | | | | | | | | | | | | |
| | | I.R. | | | | | | | | | | | | | |
| | | Voltage Proof | | | | | | | | | | | | | |
| 12 | Adhesive Strength of Termination | No removal of the terminations or other defect should occur. | Solder the capacitor on the test substrate A shown in "Complement of Test Method".  Applied Direction: In parallel with the test substrate and vertical with the capacitor side. | | | | | | | | | | | | |
| 13 | Substrate Bending Test | No defects or abnormalities. | Solder the capacitor on the test substrate B shown in "Complement of Test Method". Then apply the force in the direction shown in "Test Method of Substrate Bending Test" of "Complement of Test Method". Flexure: 1mm Holding Time: 5±1s Soldering Method: Reflow soldering | | | | | | | | | | | | |

* Room Condition: Temperature: 15 to 35°C, Relative humidity: 45 to 75%, Atmosphere pressure: 86 to 106kPa

Continued on the following page. ↗

GRM
 GR3
 GRJ
 GR4
 GR7
 GJM
 GQM
 GQW
 GA2
 GA3 GB
 GA3 GD
 GA3 GF
 LLL
 LLA
 LLM
 LLR
 NFM
 KPM
 KR3
 GMA
 GMD
 △Caution /Notice

GA3 Series Type GD Specifications and Test Methods (1)

Continued from the preceding page. ↘

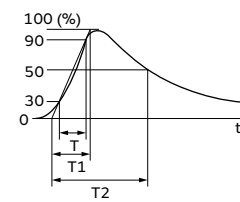
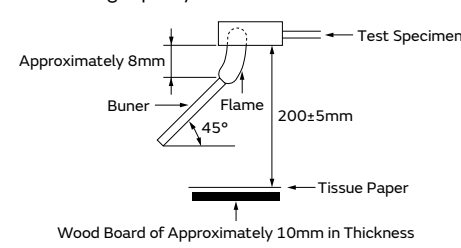
| No | Item | Specification | Test Method (Ref. Standard: JIS C 5101, IEC60384) | | | | | | | | | | | | | | | |
|--|---|---|---|-----------------|------------|--|---|----------------------------|------------|---|------------|--------|---|----------------------------|------------|---|------------|--------|
| 14 | Temperature Sudden Change | Appearance | No defects or abnormalities. | | | | | | | | | | | | | | | |
| | | Capacitance Change | Within $\pm 2.5\%$ or $\pm 0.25\text{pF}$ (Whichever is larger) | | | | | | | | | | | | | | | |
| | | Q | Within the specified initial value. | | | | | | | | | | | | | | | |
| | | I.R. | 3000M Ω or more | | | | | | | | | | | | | | | |
| | | Voltage Proof | No defects. | | | | | | | | | | | | | | | |
| | | | Fix the capacitor to the supporting test substrate A (glass epoxy board) shown in "Complement of Test Method" Perform the 5 cycles according to the four heat treatments shown in the following table. | | | | | | | | | | | | | | | |
| | | | <table border="1"> <thead> <tr> <th>Step</th> <th>Temp. (°C)</th> <th>Time (min)</th> </tr> </thead> <tbody> <tr> <td>1</td> <td>Min. Operating Temp. +0/-3</td> <td>30\pm3</td> </tr> <tr> <td>2</td> <td>Room Temp.</td> <td>2 to 3</td> </tr> <tr> <td>3</td> <td>Max. Operating Temp. +3/-0</td> <td>30\pm3</td> </tr> <tr> <td>4</td> <td>Room Temp.</td> <td>2 to 3</td> </tr> </tbody> </table> | Step | Temp. (°C) | Time (min) | 1 | Min. Operating Temp. +0/-3 | 30 \pm 3 | 2 | Room Temp. | 2 to 3 | 3 | Max. Operating Temp. +3/-0 | 30 \pm 3 | 4 | Room Temp. | 2 to 3 |
| Step | Temp. (°C) | Time (min) | | | | | | | | | | | | | | | | |
| 1 | Min. Operating Temp. +0/-3 | 30 \pm 3 | | | | | | | | | | | | | | | | |
| 2 | Room Temp. | 2 to 3 | | | | | | | | | | | | | | | | |
| 3 | Max. Operating Temp. +3/-0 | 30 \pm 3 | | | | | | | | | | | | | | | | |
| 4 | Room Temp. | 2 to 3 | | | | | | | | | | | | | | | | |
| | | | Exposure Time: 24 \pm 2h at room condition*. | | | | | | | | | | | | | | | |
| 15 | High Temperature High Humidity (Steady) | Appearance | No defects or abnormalities. | | | | | | | | | | | | | | | |
| | | Capacitance Change | Within $\pm 5.0\%$ or $\pm 0.5\text{pF}$ (Whichever is larger) | | | | | | | | | | | | | | | |
| | | Q | C \geq 30pF: 350 or more C < 30pF: 275+5/2C or more C: Nominal Capacitance (pF) | | | | | | | | | | | | | | | |
| | | I.R. | 3000M Ω or more | | | | | | | | | | | | | | | |
| | | Voltage Proof | No defects. | | | | | | | | | | | | | | | |
| | | | Fix the capacitor to the supporting test substrate B (glass epoxy board) shown in "Complement of Test Method". Before this test, the test shown in the following is performed. • No.12 Adhesive Strength of Termination (apply force: 5N) • No.13 Substrate Bending Test Test Temperature: 40 \pm 2°C Test Humidity: 90 to 95%RH Test Time: 500+24/-0h. Applied Voltage: Rated voltage Exposure Time: 24 \pm 2h at room condition*. | | | | | | | | | | | | | | | |
| 16 | Durability | Appearance | No defects or abnormalities. | | | | | | | | | | | | | | | |
| | | Capacitance Change | Within $\pm 3.0\%$ or $\pm 0.3\text{pF}$ (Whichever is larger) | | | | | | | | | | | | | | | |
| | | Q | C \geq 30pF: 350 or more C < 30pF: 275+5/2C or more C: Nominal Capacitance (pF) | | | | | | | | | | | | | | | |
| | | I.R. | 3000M Ω or more | | | | | | | | | | | | | | | |
| | | Voltage Proof | No defects. | | | | | | | | | | | | | | | |
| | | | Fix the capacitor to the supporting test substrate B (glass epoxy board) shown in "Complement of Test Method". Before this test, the test shown in the following is performed. • No.12 Adhesive Strength of Termination (apply force: 5N) • No.13 Substrate Bending Test Next, Impulse Voltage test is performed. Each individual capacitor shall be subjected to a 2.5kV Impulse (the voltage value means zero to peak) for 3 times. Then the capacitors are applied to life test. | | | | | | | | | | | | | | | |
| | | |  <p>Front time (T1) = 1.2μs=1.67T Time to half-value (T2) = 50μs</p> | | | | | | | | | | | | | | | |
| | | | Apply voltage as Table for 1000h at 125+2/-0°C, relative humidity 50% max. | | | | | | | | | | | | | | | |
| | | | <table border="1"> <thead> <tr> <th colspan="2">Applied voltage</th> </tr> </thead> <tbody> <tr> <td>AC425V (r.m.s.), except that once each hour the voltage is increased to AC1000V (r.m.s.) for 0.1s.</td> <td></td> </tr> </tbody> </table> | Applied voltage | | AC425V (r.m.s.), except that once each hour the voltage is increased to AC1000V (r.m.s.) for 0.1s. | | | | | | | | | | | | |
| Applied voltage | | | | | | | | | | | | | | | | | | |
| AC425V (r.m.s.), except that once each hour the voltage is increased to AC1000V (r.m.s.) for 0.1s. | | | | | | | | | | | | | | | | | | |
| | | | Exposure Time: 24 \pm 2h at room condition*. | | | | | | | | | | | | | | | |
| 17 | Passive Flammability | The burning time shall not be exceeded the time 30s. The tissue paper shall not ignite. | The capacitor under test shall be held in the flame in the position which best promotes burning. Each specimen shall only be exposed once to the flame. Time of exposure to flame: 30s Length of flame: 12 \pm 1mm Gas burner: Length 35mm min. Inside dia: 0.5 \pm 0.1mm Outside dia: 0.9mm max. Gas: Butane gas purity 95% min. | | | | | | | | | | | | | | | |
| | | |  | | | | | | | | | | | | | | | |

* Room Condition: Temperature: 15 to 35°C, Relative humidity: 45 to 75%, Atmosphere pressure: 86 to 106kPa

Continued on the following page. ↗

GA3 Series Type GD Specifications and Test Methods (1)

Continued from the preceding page. ↘

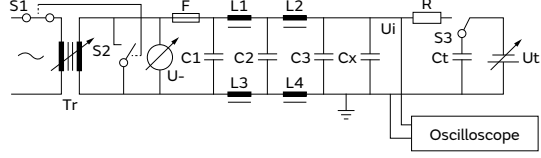
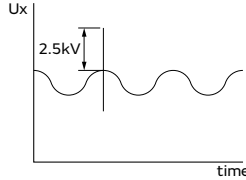
| No | Item | Specification | Test Method (Ref. Standard: JIS C 5101, IEC60384) |
|----|---------------------|---------------------------------------|---|
| 18 | Active Flammability | The cheesecloth shall not be on fire. | <p>The specimens shall be individually wrapped in at least one but more than two complete layers of cheesecloth. The specimens shall be subjected to 20 discharges. The interval between successive discharges shall be 5s. The UAC shall be maintained for 2min after the last discharge.</p>  <p>C1, C2: Filter capacitor $1\mu\text{F}\pm 10\%$ C3: Capacitor $0.033\mu\text{F}\pm 5\%$ L1 to L4: Rod coa choke $1.5\text{mH}\pm 20\%$, 16A R: Resistor $100\Omega\pm 2\%$ $C_x < 0.068\mu\text{F}$ Ct: Tank capacitor $3\mu\text{F}\pm 5\%$ 10kV $C_x \leq 1\mu\text{F}$ U-: $UR\pm 5\%$ UR: Rated voltage Cx: Capacitor under test F: Slow-blow fuse, rated 16A Ut: Voltage to which the tank capacitor Ct is charged</p>  |

GRM
 GR3
 GRJ
 GR4
 GR7
 GJM
 GQM
 GA2
 GA3 GB
 GA3 GD
 GA3 GF
 LLL
 LLA
 LLM
 LLR
 NFM
 KPM
 KR3
 GMA
 GMD
 ⚠Caution / Notice

GA3 Series Type GD Specifications and Test Methods (1)

Continued from the preceding page. ↘

Complement of Test Method

1. Test Substrate

The test substrate should be Substrate A or Substrate B as described in "Specifications and Test Methods".
 The specimen should be soldered by the conditions as described below.

Soldering Method: Reflow soldering
 Solder: Sn-3.0Ag-0.5Cu

(1) Test Substrate A

• Land Dimensions



| Part Number | Dimension (mm) | | |
|--------------|----------------|-----|-----|
| | a | b | c |
| GA342 | 3.5 | 7.0 | 2.4 |

- Material: Glass Epoxy Board
- Thickness: 1.6mm
- Thickness of Copper Foil: 0.035mm

(2) Test Substrate B

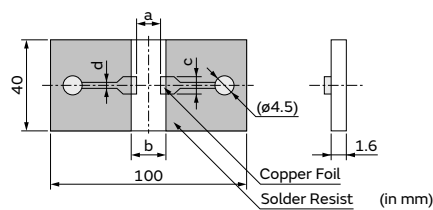

| Part Number | Dimension of Pattern (mm) | | | |
|--------------|---------------------------|-----|-----|-----|
| | a | b | c | d |
| GA342 | 3.5 | 7.0 | 2.4 | 1.0 |

- Material: Glass Epoxy Board
- Thickness of Copper Foil: 0.035mm

2. Test Method of Substrate Bending Test

(a) Support State

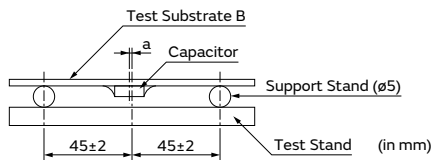

a: ±2 gap between support stand center and test stand

(b) Test State

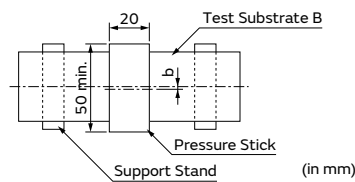

b: ±5 gap between support stand center and test stand center

- Material of Test Stand and Pressure Stick
 The material should be a metal where a remarkable transformation and the distortion are not caused even if it is pressurized.
- Pressurizing Speed
 The pressurizing speed is pressurized at the speed of about 1mm/s until the flexure reaches a regulated value.

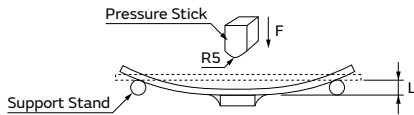

GRM
 GR3
 GRJ
 GR4
 GR7
 GJM
 GQM
 GA2
 GA3 GB
 GA3 GD
 GA3 GF
 LLL
 LLA
 LLM
 LLR
 NFM
 KRM
 KR3
 GMA
 GMD
 Caution / Notice

2

GA3 Series Type GD Specifications and Test Methods (2)

| No | Item | Specification | Test Method (Ref. Standard: JIS C 5101, IEC60384) | | | | | | | | | | | | |
|------|--|---|--|------|------------------|---|--------------------|---|-------------------------|---|--------------------|---|-------------------------|---|--------------------|
| 1 | Appearance | No defects or abnormalities. | Visual inspection. | | | | | | | | | | | | |
| 2 | Dimension | Within the specified dimensions. | Using calipers and micrometers. | | | | | | | | | | | | |
| 3 | Voltage Proof | No defects or abnormalities. | Measurement Point: Between the terminations Test Voltage: AC1500V (r.m.s.) Applied Time: 60±1s Charge/discharge current: 50mA max. | | | | | | | | | | | | |
| 4 | Impulse Voltage | No self healing break downs or flash-overs have taken place in the capacitor. | 10 impulse of alternating polarity is subjected. (5 impulse for each polarity) The interval between impulse is 60s. Applied Voltage: 2.5kVo-p | | | | | | | | | | | | |
| 5 | Insulation Resistance (I.R.) | 6000MΩ or more | Measurement Point: Between the terminations Measurement Voltage: DC500±50V Charging Time: 60±5s Measurement Temperature: Room Temperature | | | | | | | | | | | | |
| 6 | Capacitance | Shown in Rated value. | Measurement Temperature: Room Temperature Measurement Frequency: 1.0±0.1kHz | | | | | | | | | | | | |
| 7 | Dissipation Factor (D.F.) | 0.025 max. | Measurement Voltage: AC1.0±0.2V (r.m.s.) | | | | | | | | | | | | |
| 8 | Temperature Characteristics of Capacitance | R7: Within ±15% (-55 to +125°C) | The capacitance change should be measured after 5 minutes at each specified temp. stage. Capacitance value as a reference is the value in step 3. <table border="1" style="margin: 10px auto;"> <thead> <tr> <th>Step</th> <th>Temperature (°C)</th> </tr> </thead> <tbody> <tr> <td>1</td> <td>Reference Temp. ±2</td> </tr> <tr> <td>2</td> <td>Min. Operating Temp. ±3</td> </tr> <tr> <td>3</td> <td>Reference Temp. ±2</td> </tr> <tr> <td>4</td> <td>Max. Operating Temp. ±3</td> </tr> <tr> <td>5</td> <td>Reference Temp. ±2</td> </tr> </tbody> </table> <ul style="list-style-type: none"> • Pretreatment Perform a heat treatment at 150+0/-10°C for 1h±5min and then let sit for 24±2h at room condition*. | Step | Temperature (°C) | 1 | Reference Temp. ±2 | 2 | Min. Operating Temp. ±3 | 3 | Reference Temp. ±2 | 4 | Max. Operating Temp. ±3 | 5 | Reference Temp. ±2 |
| Step | Temperature (°C) | | | | | | | | | | | | | | |
| 1 | Reference Temp. ±2 | | | | | | | | | | | | | | |
| 2 | Min. Operating Temp. ±3 | | | | | | | | | | | | | | |
| 3 | Reference Temp. ±2 | | | | | | | | | | | | | | |
| 4 | Max. Operating Temp. ±3 | | | | | | | | | | | | | | |
| 5 | Reference Temp. ±2 | | | | | | | | | | | | | | |
| 9 | Vibration | Appearance | Solder the capacitor on the test substrate A shown in "Complement of Test Method". Kind of Vibration: A simple harmonic motion 10Hz to 55Hz to 10Hz (1min) Total amplitude: 1.5mm This motion should be applied for a period of 2h in each 3 mutually perpendicular directions (total of 6h). | | | | | | | | | | | | |
| | | Capacitance | | | | | | | | | | | | | |
| | | D.F. | | | | | | | | | | | | | |
| 10 | Solderability | 95% of the terminations is to be soldered evenly and continuously. | Test Method: Solder bath method Flux: Solution of rosin ethanol 25 (wt)% Preheat: 80 to 120°C for 10 to 30s Solder: Sn-3.0Ag-0.5Cu (Lead Free Solder) Solder Temp.: 245±5°C Immersion time: 2±0.5s Immersing in speed: 25±2.5mm/s. | | | | | | | | | | | | |
| 11 | Resistance to Soldering Heat | Appearance | Test Method: Solder bath method Solder: Sn-3.0Ag-0.5Cu (Lead Free Solder) Solder Temp.: 260±5°C Immersion time: 10±1s Immersing in speed: 25±2.5mm/s. Exposure Time: 24±2h at room condition*. Preheat: GA342/43 size: 100 to 120°C for 1min and 170 to 200°C for 1min <ul style="list-style-type: none"> • Pretreatment Perform a heat treatment at 150+0/-10°C for 1h±5min and then let sit for 24±2h at room condition*. | | | | | | | | | | | | |
| | | Capacitance Change | | | | | | | | | | | | | |
| | | I.R. | | | | | | | | | | | | | |
| | | Voltage Proof | | | | | | | | | | | | | |
| 12 | Adhesive Strength of Termination | No removal of the terminations or other defect should occur. | Solder the capacitor on the test substrate A shown in "Complement of Test Method".  Applied Direction: In parallel with the test substrate and vertical with the capacitor side. | | | | | | | | | | | | |

* Room Condition: Temperature: 15 to 35°C, Relative humidity: 45 to 75%, Atmosphere pressure: 86 to 106kPa

Continued on the following page. ↗

GRM
 GR3
 GRJ
 GR4
 GR7
 GJM
 GQM
 GA2
 GA3 GB
 GA3 GD
 GA3 GF
 LLL
 LLA
 LLM
 LLR
 NFM
 KPM
 KR3
 GMA
 GMD
 ⚠Caution / Notice

GA3 Series Type GD Specifications and Test Methods (2)

Continued from the preceding page. ↘

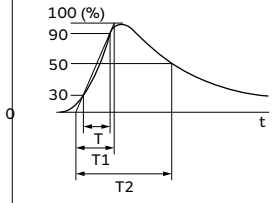
| No | Item | Specification | Test Method (Ref. Standard: JIS C 5101, IEC60384) | | | | | | | | | | | | | | | |
|--------------------|---|--|--|----------------------------|------------|--|---|----------------------------|------|---|------------|--------|---|----------------------------|------|---|------------|--------|
| 13 | Substrate Bending Test | No defects or abnormalities. | Solder the capacitor on the test substrate B shown in "Complement of Test Method". Then apply the force in the direction shown in "Test Method of Substrate Bending Test" of "Complement of Test Method" Flexure: 1mm Holding Time: 5±1s Soldering Method: Reflow soldering | | | | | | | | | | | | | | | |
| 14 | Temperature Sudden Change | Appearance | Fix the capacitor to the supporting test substrate A (glass epoxy board) shown in "Complement of Test Method". Perform the 5 cycles according to the four heat treatments shown in the following table. <table border="1" style="margin: 10px auto;"> <thead> <tr> <th>Step</th> <th>Temp. (°C)</th> <th>Time (min)</th> </tr> </thead> <tbody> <tr> <td>1</td> <td>Min. Operating Temp. +0/-3</td> <td>30±3</td> </tr> <tr> <td>2</td> <td>Room Temp.</td> <td>2 to 3</td> </tr> <tr> <td>3</td> <td>Max. Operating Temp. +3/-0</td> <td>30±3</td> </tr> <tr> <td>4</td> <td>Room Temp.</td> <td>2 to 3</td> </tr> </tbody> </table> Exposure Time: 24±2h at room condition*. • Pretreatment Perform a heat treatment at 150+0/-10°C for 1h±5min and then let sit for 24±2h at room condition*. | Step | Temp. (°C) | Time (min) | 1 | Min. Operating Temp. +0/-3 | 30±3 | 2 | Room Temp. | 2 to 3 | 3 | Max. Operating Temp. +3/-0 | 30±3 | 4 | Room Temp. | 2 to 3 |
| | | Step | | Temp. (°C) | Time (min) | | | | | | | | | | | | | |
| | | 1 | | Min. Operating Temp. +0/-3 | 30±3 | | | | | | | | | | | | | |
| | | 2 | | Room Temp. | 2 to 3 | | | | | | | | | | | | | |
| | | 3 | | Max. Operating Temp. +3/-0 | 30±3 | | | | | | | | | | | | | |
| 4 | Room Temp. | 2 to 3 | | | | | | | | | | | | | | | | |
| Capacitance Change | Within±15% | | | | | | | | | | | | | | | | | |
| D.F. | 0.05 max. | | | | | | | | | | | | | | | | | |
| I.R. | 3000MΩ or more | | | | | | | | | | | | | | | | | |
| Voltage Proof | No defects. | | | | | | | | | | | | | | | | | |
| 15 | High Temperature High Humidity (Steady) | Appearance | Fix the capacitor to the supporting test substrate B (glass epoxy board) shown in "Complement of Test Method". Before this test, the test shown in the following is performed. • No.12 Adhesive Strength of Termination (apply force: 5N) • No.13 Substrate Bending Test Test Temperature: 40±2°C Test Humidity: 90 to 95%RH Test Time: 500+24/-0h Applied Voltage: Rated voltage Exposure Time: 24±2h at room condition*. • Pretreatment Perform a heat treatment at 150+0/-10°C for 1h±5min and then let sit for 24±2h at room condition*. | | | | | | | | | | | | | | | |
| | | Capacitance Change | | Within±15% | | | | | | | | | | | | | | |
| | | D.F. | | 0.05 max. | | | | | | | | | | | | | | |
| | | I.R. | | 3000MΩ or more | | | | | | | | | | | | | | |
| | | Voltage Proof | | No defects. | | | | | | | | | | | | | | |
| 16 | Durability | Appearance | Fix the capacitor to the supporting test substrate B (glass epoxy board) shown in "Complement of Test Method". Before this test, the test shown in the following is performed. • No.12 Adhesive Strength of Termination (apply force: 5N) • No.13 Substrate Bending Test Next, Impulse Voltage test is performed. Each individual capacitor shall be subjected to a 2.5kV Impulse (the voltage value means zero to peak) for 3 times. Then the capacitors are applied to life test.  Front time (T1) = 1.2μs=1.67T Time to half-value (T2) = 50μs Apply voltage as Table for 1000h at 125+2/-0°C, relative humidity 50% max. <table border="1" style="margin: 10px auto;"> <thead> <tr> <th colspan="2">Applied Voltage</th> </tr> </thead> <tbody> <tr> <td>AC425V (r.m.s.), except that once each hour the voltage is increased to AC1000V (r.m.s.) for 0.1s.</td> <td></td> </tr> </tbody> </table> Exposure Time: 24±2h at room condition*. • Pretreatment Perform a heat treatment at 150+0/-10°C for 1h±5min and then let sit for 24±2h at room condition*. | Applied Voltage | | AC425V (r.m.s.), except that once each hour the voltage is increased to AC1000V (r.m.s.) for 0.1s. | | | | | | | | | | | | |
| | | Applied Voltage | | | | | | | | | | | | | | | | |
| | | AC425V (r.m.s.), except that once each hour the voltage is increased to AC1000V (r.m.s.) for 0.1s. | | | | | | | | | | | | | | | | |
| | | Capacitance Change | | Within ±20% | | | | | | | | | | | | | | |
| | | D.F. | | 0.05 max. | | | | | | | | | | | | | | |
| I.R. | 3000MΩ or more | | | | | | | | | | | | | | | | | |
| Voltage Proof | No defects. | | | | | | | | | | | | | | | | | |

* Room Condition: Temperature: 15 to 35°C, Relative humidity: 45 to 75%, Atmosphere pressure: 86 to 106kPa

Continued on the following page. ↗

GRM
GR3
GRJ
GR4
GR7
GJM
GQM
GA2
GA3 GB
GA3 GD
GA3 GF
LLL
LLA
LLM
LLR
NFM
KRM
KR3
GMA
GMD
Caution / Notice

GA3 Series Type GD Specifications and Test Methods (2)

Continued from the preceding page. ↘

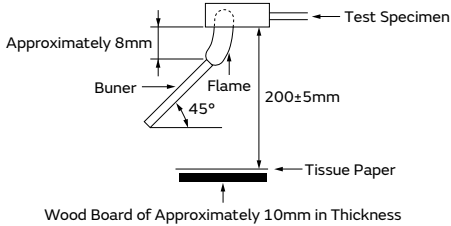
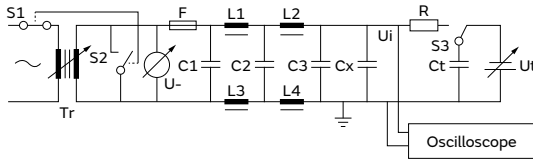
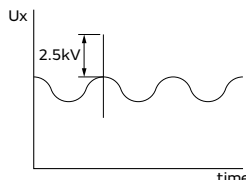
| No | Item | Specification | Test Method (Ref. Standard: JIS C 5101, IEC60384) |
|----|----------------------|--|---|
| 17 | Passive Flammability | The burning time shall not be exceeded the time 30s. The tissue paper shall not ignite. | <p>The capacitor under test shall be held in the flame in the position which best promotes burning. Each specimen shall only be exposed once to the flame. Time of exposure to flame: 30s Length of flame: 12±1mm Gas burner: Length 35mm min. Inside dia: 0.5±0.1mm Outside dia: 0.9mm max. Gas: Butane gas purity 95% min.</p>  |
| 18 | Active Flammability | The cheesecloth shall not be on fire. | <p>The specimens shall be individually wrapped in at least one but more than two complete layers of cheesecloth. The specimens shall be subjected to 20 discharges. The interval between successive discharges shall be 5s. The UAC shall be maintained for 2min after the last discharge.</p>  <p>C1, C2: Filter capacitor 1μF±10% C3: Capacitor 0.033μF±5% L1 to L4: Rod coa choke 1.5mH±20%, 16A R: Resistor 100Ω±2% Cx < 0.068μF Ct: Tank capacitor 3μF±5% 10kV Cx ≤ 1μF U-: UR±5% UR: Rated voltage Cx: Capacitor under test F: Slow-blow fuse, rated 16A Ut: Voltage to which the tank capacitor Ct is charged</p>  |

GRM
 GR3
 GRJ
 GR4
 GR7
 GJM
 GQM
 GA2
 GA3 GB
 GA3 GD
 GA3 GF
 LLL
 LLA
 LLM
 LLR
 NFM
 KPM
 KR3
 GMA
 GMD
 ⚠Caution / Notice

GA3 Series Type GD Specifications and Test Methods (2)

Continued from the preceding page. ↘

Complement of Test Method

1. Test Substrate

The test substrate should be Substrate A or Substrate B as described in "Specifications and Test Methods".
 The specimen should be soldered by the conditions as described below.

Soldering Method: Reflow soldering
 Solder: Sn-3.0Ag-0.5Cu

(1) Test Substrate A

• Land Dimensions

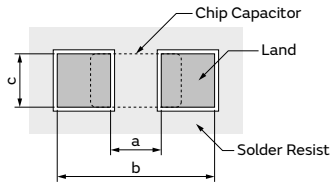

- Material: Glass Epoxy Board
- Thickness: 1.6mm
- Thickness of Copper Foil: 0.035mm

| Part Number | Dimension (mm) | | |
|-------------|----------------|-----|-----|
| | a | b | c |
| GA342 | 3.5 | 7.0 | 2.4 |
| GA343 | 3.5 | 7.0 | 3.7 |

(2) Test Substrate B

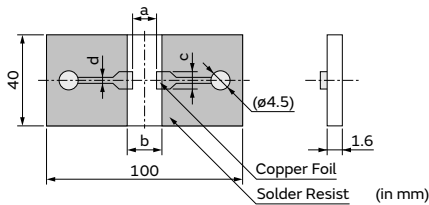

- Material: Glass Epoxy Board
- Thickness of Copper Foil: 0.035mm

| Part Number | Dimension of Pattern (mm) | | | |
|-------------|---------------------------|-----|-----|-----|
| | a | b | c | d |
| GA342 | 3.5 | 7.0 | 2.4 | 1.0 |
| GA343 | 3.5 | 7.0 | 3.7 | 1.0 |

2. Test Method of Substrate Bending Test

(a) Support State

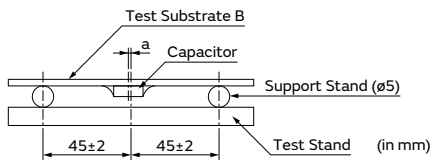

a: ± 2 gap between support stand center and test stand

- Material of Test Stand and Pressure Stick
 The material should be a metal where a remarkable transformation and the distortion are not caused even if it is pressurized.
- Pressurizing Speed
 The pressurizing speed is pressurized at the speed of about 1mm/s until the flexure reaches a regulated value.

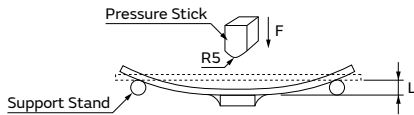

(b) Test State

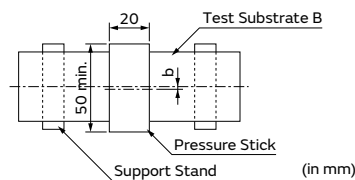

b: ± 5 gap between support stand center and test stand center

GRM
 GR3
 GRJ
 GR4
 GR7
 GJM
 GQM
 GA2
 GA3 GB
 GA3 GD
 GA3 GF
 LLL
 LLA
 LLM
 LLR
 NFM
 KRM
 KR3
 GMA
 GMD
 Caution / Notice

Safety Standard Certified Chip Multilayer Ceramic Capacitors for General Purpose / Acquired certifications of IEC60384-14 Class X1/Y2 and UL60950-1

GA3 Series Type GF



Size 4.5x2.0mm: This product is applicable only for the instruments certified by EN/IEC60950-1
Size 5.7x2.8mm or 5.7x5.0mm: This product is applicable as X or Y capacitor

Features

① **International Standard (IEC60384-14) certified product.**

Please down load Safety Standard Certification (Type GF: X1/Y2) from here.



② **Can be used as a Class Y2 capacitor.**

● **Switching Power Supply - Class 1 Equipment**

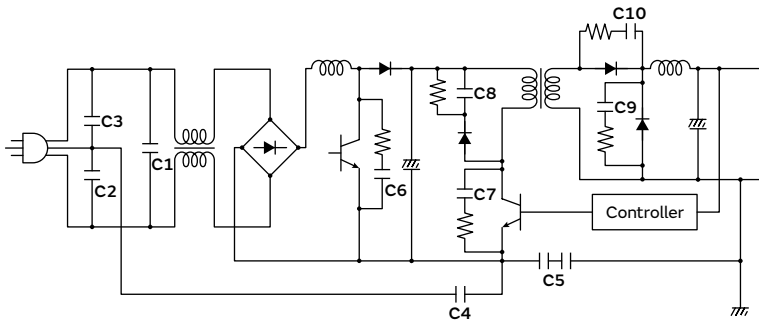

| No. | Application | Recommend MLCC Type |
|-----|------------------------------|---------------------|
| C1 | X Cap | Type: GB |
| C2 | Y Cap | Type: GF |
| C3 | | |
| C4 | | |
| C5 | Primary - Secondary Coupling | Type: GF×2 |

● **Switching Power Supply - Class 2 Equipment**

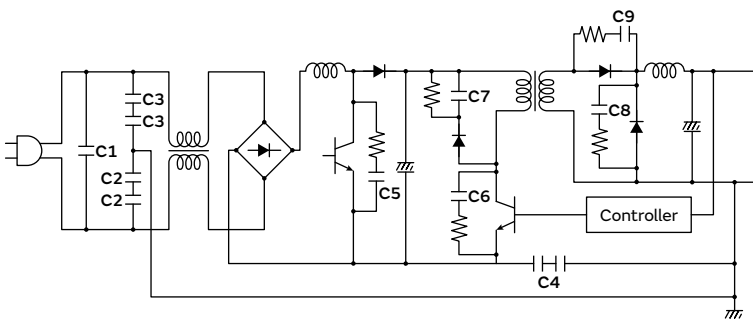

| No. | Application | Recommend MLCC Type |
|-----|------------------------------|---------------------|
| C1 | X Cap | Type: GB |
| C2 | Y Cap | Type: GF×2 |
| C3 | | |
| C4 | Primary - Secondary Coupling | |

- GRM
- GR3
- GRJ
- GR4
- GR7
- GJM
- GQM
- GA2
- GA3 GB
- GA3 GD
- GA3 GF
- LLL
- LLA
- LLM
- LLR
- NFM
- KPM
- KR3
- GMA
- GMD
- ⚠Caution / Notice

GRM
 GR3
 GRJ
 GR4
 GR7
 GJM
 GQM
 GA2
 GA3 GB
 GA3 GD
 GA3 GF
 LLL
 LLA
 LLM
 LLR
 NFM
 KRM
 KR3
 GMA
 GMD
 ⚠Caution /Notice

3 Realized large capacitance value and small size while maintaining high withstand voltages by the multilayer structure.



4 This product is only for reflow soldering.

Specifications

| | |
|-------------------|------------------------|
| Size (mm) | 4.5×2.0mm to 5.7×5.0mm |
| Rated Voltage | 250Vac |
| Capacitance | 10pF to 4700pF |
| Main Applications | AC-DC power supply |

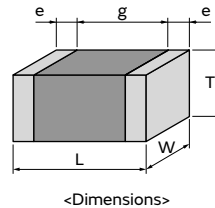

This catalog contains only a portion of the product lineup.
 Please refer to the capacitor search tool on the Murata Web site for details.

GA3 Series Type GF Temperature Compensating Type Part Number List

4.5×2.0mm

| T max. | Rated Voltage | TC Code | Cap. | Tol. | Part Number | p* |
|--------|---------------|---------|------|------|--------------------|------|
| 1.0mm | 250Vac | SL | 10pF | ±5% | GA342A1XGF100JW31# | p211 |
| | | | 12pF | ±5% | GA342A1XGF120JW31# | p211 |
| | | | 15pF | ±5% | GA342A1XGF150JW31# | p211 |
| | | | 18pF | ±5% | GA342A1XGF180JW31# | p211 |
| | | | 22pF | ±5% | GA342A1XGF220JW31# | p211 |
| | | | 27pF | ±5% | GA342A1XGF270JW31# | p211 |
| | | | 33pF | ±5% | GA342A1XGF330JW31# | p211 |
| | | | 39pF | ±5% | GA342A1XGF390JW31# | p211 |
| | | | 47pF | ±5% | GA342A1XGF470JW31# | p211 |
| | | | 56pF | ±5% | GA342A1XGF560JW31# | p211 |
| | | | 68pF | ±5% | GA342A1XGF680JW31# | p211 |
| | | | 82pF | ±5% | GA342A1XGF820JW31# | p211 |

- GRM
- GR3
- GRJ
- GR4
- GR7
- GJM
- GQM
- GA2
- GA3 GB
- GA3 GD
- GA3 GF**
- LLL
- LLA
- LLM
- LLR
- NFM
- KRM
- KR3
- GMA
- GMD
- ⚠Caution /Notice

*: Refers to the page of the "Specifications and Test Methods".

Part number # indicates the package specification code.

GA3 Series Type GF High Dielectric Constant Type Part Number List

4.5×2.0mm

| T max. | Rated Voltage | TC Code | Cap. | Tol. | Part Number | p* |
|--------|---------------|---------|--------|------|---------------------------|------|
| 1.5mm | 250Vac | X7R | 100pF | ±10% | GA342QR7GF101KW01# | p215 |
| | | | 150pF | ±10% | GA342QR7GF151KW01# | p215 |
| | | | 470pF | ±10% | GA342QR7GF471KW01# | p215 |
| | | | 680pF | ±10% | GA342QR7GF681KW01# | p215 |
| 2.2mm | 250Vac | X7R | 220pF | ±10% | GA342DR7GF221KW02# | p215 |
| | | | 330pF | ±10% | GA342DR7GF331KW02# | p215 |
| | | | 1000pF | ±10% | GA342DR7GF102KW02# | p215 |

5.7×2.8mm

| T max. | Rated Voltage | TC Code | Cap. | Tol. | Part Number | p* |
|--------|---------------|---------|--------|------|---------------------------|------|
| 1.5mm | 250Vac | X7R | 100pF | ±10% | GA352QR7GF101KW31# | p215 |
| | | | 150pF | ±10% | GA352QR7GF151KW31# | p215 |
| | | | 220pF | ±10% | GA352QR7GF221KW31# | p215 |
| | | | 330pF | ±10% | GA352QR7GF331KW31# | p215 |
| | | | 470pF | ±10% | GA352QR7GF471KW01# | p215 |
| | | | 680pF | ±10% | GA352QR7GF681KW01# | p215 |
| | | | 1000pF | ±10% | GA352QR7GF102KW01# | p215 |
| | | | 1500pF | ±10% | GA352QR7GF152KW01# | p215 |

5.7×5.0mm

| T max. | Rated Voltage | TC Code | Cap. | Tol. | Part Number | p* |
|--------|---------------|---------|--------|------|---------------------------|------|
| 1.5mm | 250Vac | X7R | 1800pF | ±10% | GA355QR7GF182KW01# | p215 |
| | | | 2200pF | ±10% | GA355QR7GF222KW01# | p215 |
| | | | 3300pF | ±10% | GA355QR7GF332KW01# | p215 |
| 2.0mm | 250Vac | X7R | 4700pF | ±10% | GA355DR7GF472KW01# | p215 |

GRM
 GR3
 GRJ
 GR4
 GR7
 GJM
 GQM
 GA2
 GA3 GB
 GA3 GD
 GA3 GF
 LLL
 LLA
 LLM
 LLR
 NFM
 KRM
 KR3
 GMA
 GMD
 ⚠Caution /Notice

*: Refers to the page of the "Specifications and Test Methods".

Part number # indicates the package specification code.

1

GA3 Series Type GF Specifications and Test Methods (1)

| No | Item | Specification | Test Method (Ref. Standard: JIS C 5101, IEC60384) | | | | | | | | | | | | |
|------|--|--|--|------|------------------|---|--------------------|---|-------------------------|---|--------------------|---|-------------------------|---|--------------------|
| 1 | Appearance | No defects or abnormalities. | Visual inspection. | | | | | | | | | | | | |
| 2 | Dimension | Within the specified dimensions. | Using calipers and micrometers. | | | | | | | | | | | | |
| 3 | Voltage Proof | No defects or abnormalities. | Measurement Point: Between the terminations Test Voltage: AC2000V (r.m.s.) Applied Time: 60±1s Charge/discharge current: 50mA max. | | | | | | | | | | | | |
| 4 | Impulse Voltage | No self healing break downs or flash-overs have taken place in the capacitor. | 10 impulse of alternating polarity is subjected. (5 impulse for each polarity) The interval between impulse is 60s. Applied Voltage: 2.5kVo-p | | | | | | | | | | | | |
| 5 | Insulation Resistance (I.R.) | 6000MΩ or more | Measurement Point: Between the terminations Measurement Voltage: DC500±50V Charging Time: 60±5s Measurement Temperature: Room Temperature | | | | | | | | | | | | |
| 6 | Capacitance | Shown in Rated value. | Measurement Temperature: Room Temperature Measurement Frequency: 1.0±0.1MHz Measurement Voltage: AC1.0±0.2V (r.m.s.) | | | | | | | | | | | | |
| 7 | Q | C ≥ 30pF: 1000 or more C < 30pF: 400+20C or more C: Nominal Capacitance (pF) | | | | | | | | | | | | | |
| 8 | Temperature Characteristics of Capacitance | 1X: +350 to -1000 ppm/°C (Temp.Range:+20 to +85°C) | The capacitance change should be measured after 5 minutes at each specified temp. stage. Capacitance value as a reference is the value in step 3. <table border="1" style="margin-left: auto; margin-right: auto;"> <thead> <tr> <th>Step</th> <th>Temperature (°C)</th> </tr> </thead> <tbody> <tr> <td>1</td> <td>Reference Temp. ±2</td> </tr> <tr> <td>2</td> <td>Min. Operating Temp. ±3</td> </tr> <tr> <td>3</td> <td>Reference Temp. ±2</td> </tr> <tr> <td>4</td> <td>Max. Operating Temp. ±3</td> </tr> <tr> <td>5</td> <td>Reference Temp. ±2</td> </tr> </tbody> </table> However, the capacitance shall be measured at even 85°C between step 3 and step 4. | Step | Temperature (°C) | 1 | Reference Temp. ±2 | 2 | Min. Operating Temp. ±3 | 3 | Reference Temp. ±2 | 4 | Max. Operating Temp. ±3 | 5 | Reference Temp. ±2 |
| Step | Temperature (°C) | | | | | | | | | | | | | | |
| 1 | Reference Temp. ±2 | | | | | | | | | | | | | | |
| 2 | Min. Operating Temp. ±3 | | | | | | | | | | | | | | |
| 3 | Reference Temp. ±2 | | | | | | | | | | | | | | |
| 4 | Max. Operating Temp. ±3 | | | | | | | | | | | | | | |
| 5 | Reference Temp. ±2 | | | | | | | | | | | | | | |
| 9 | Vibration | Appearance | Solder the capacitor on the test substrate A shown in "Complement of Test Method". Kind of Vibration: A simple harmonic motion 10Hz to 55Hz to 10Hz (1min) Total amplitude: 1.5mm This motion should be applied for a period of 2h in each 3 mutually perpendicular directions (total of 6h). | | | | | | | | | | | | |
| | | Capacitance | | | | | | | | | | | | | |
| | | Q | | | | | | | | | | | | | |
| 10 | Solderability | 95% of the terminations is to be soldered evenly and continuously. | Test Method: Solder bath method Flux: Solution of rosin ethanol 25 (wt)% Preheat: 80 to 120°C for 10 to 30s Solder: Sn-3.0Ag-0.5Cu (Lead Free Solder) Solder Temp.: 245±5°C Immersion time: 2±0.5s Immersing in speed: 25±2.5mm/s. | | | | | | | | | | | | |
| 11 | Resistance to Soldering Heat | Appearance | Test Method: Solder bath method Solder: Sn-3.0Ag-0.5Cu (Lead Free Solder) Solder Temp.: 260±5°C Immersion time: 10±1s Immersing in speed: 25±2.5mm/s. Exposure Time: 24±2h at room condition*. Preheat: GA342 size: 100 to 120°C for 1min and 170 to 200°C for 1min | | | | | | | | | | | | |
| | | Capacitance Change | | | | | | | | | | | | | |
| | | I.R. | | | | | | | | | | | | | |
| | | Voltage Proof | | | | | | | | | | | | | |
| 12 | Adhesive Strength of Termination | No removal of the terminations or other defect should occur. | Solder the capacitor on the test substrate A shown in "Complement of Test Method".  Applied Direction: In parallel with the test substrate and vertical with the capacitor side. | | | | | | | | | | | | |
| 13 | Substrate Bending Test | No defects or abnormalities. | Solder the capacitor on the test substrate B shown in "Complement of Test Method". Then apply the force in the direction shown in "Test Method of Substrate Bending Test" of "Complement of Test Method". Flexure: 1mm Holding Time: 5±1s Soldering Method: Reflow soldering | | | | | | | | | | | | |

* Room Condition: Temperature: 15 to 35°C, Relative humidity: 45 to 75%, Atmosphere pressure: 86 to 106kPa

Continued on the following page. ↗

GRM
 GR3
 GRJ
 GR4
 GR7
 GJM
 GQM
 GA2
 GA3 GB
 GA3 GD
 GA3 GF
 LLL
 LLA
 LLM
 LLR
 NFM
 KPM
 KR3
 GMA
 GMD
 ⚠Caution /Notice

GA3 Series Type GF Specifications and Test Methods (1)

Continued from the preceding page. ↘

| No | Item | Specification | Test Method (Ref. Standard: JIS C 5101, IEC60384) | | | | | | | | | | | | | | | |
|------|---|--|--|------|------------|------------|---|----------------------------|------------|---|------------|--------|---|----------------------------|------------|---|------------|--------|
| 14 | Temperature Sudden Change | Appearance | No defects or abnormalities. | | | | | | | | | | | | | | | |
| | | Capacitance Change | Within $\pm 2.5\%$ or $\pm 0.25\text{pF}$ (Whichever is larger) | | | | | | | | | | | | | | | |
| | | Q | Within the specified initial value. | | | | | | | | | | | | | | | |
| | | I.R. | 3000M Ω or more | | | | | | | | | | | | | | | |
| | | Voltage Proof | No defects. | | | | | | | | | | | | | | | |
| | | | Fix the capacitor to the supporting test substrate A (glass epoxy board) shown in "Complement of Test Method". Perform the 5 cycles according to the four heat treatments shown in the following table. <table border="1" style="margin-left: 20px;"> <thead> <tr> <th>Step</th> <th>Temp. (°C)</th> <th>Time (min)</th> </tr> </thead> <tbody> <tr> <td>1</td> <td>Min. Operating Temp. +0/-3</td> <td>30\pm3</td> </tr> <tr> <td>2</td> <td>Room Temp.</td> <td>2 to 3</td> </tr> <tr> <td>3</td> <td>Max. Operating Temp. +3/-0</td> <td>30\pm3</td> </tr> <tr> <td>4</td> <td>Room Temp.</td> <td>2 to 3</td> </tr> </tbody> </table> Exposure Time: 24 \pm 2h at room condition*. | Step | Temp. (°C) | Time (min) | 1 | Min. Operating Temp. +0/-3 | 30 \pm 3 | 2 | Room Temp. | 2 to 3 | 3 | Max. Operating Temp. +3/-0 | 30 \pm 3 | 4 | Room Temp. | 2 to 3 |
| Step | Temp. (°C) | Time (min) | | | | | | | | | | | | | | | | |
| 1 | Min. Operating Temp. +0/-3 | 30 \pm 3 | | | | | | | | | | | | | | | | |
| 2 | Room Temp. | 2 to 3 | | | | | | | | | | | | | | | | |
| 3 | Max. Operating Temp. +3/-0 | 30 \pm 3 | | | | | | | | | | | | | | | | |
| 4 | Room Temp. | 2 to 3 | | | | | | | | | | | | | | | | |
| 15 | High Temperature High Humidity (Steady) | Appearance | No defects or abnormalities. | | | | | | | | | | | | | | | |
| | | Capacitance Change | Within $\pm 5.0\%$ or $\pm 0.5\text{pF}$ (Whichever is larger) | | | | | | | | | | | | | | | |
| | | Q | C \geq 30pF: 350 or more C < 30pF: 275+5/2C or more C: Nominal Capacitance (pF) | | | | | | | | | | | | | | | |
| | | I.R. | 3000M Ω or more | | | | | | | | | | | | | | | |
| | | Voltage Proof | No defects. | | | | | | | | | | | | | | | |
| | | | Fix the capacitor to the supporting test substrate B (glass epoxy board) shown in "Complement of Test Method". Before this test, the test shown in the following is performed. • No.12 Adhesive Strength of Termination (apply force: 5N) • No.13 Substrate Bending test Test Temperature: 40 \pm 2°C Test Humidity: 90 to 95%RH Test Time: 500+24/-0h Applied Voltage: Rated voltage Exposure Time: 24 \pm 2h at room condition*. | | | | | | | | | | | | | | | |
| 16 | Durability | Appearance | No defects or abnormalities. | | | | | | | | | | | | | | | |
| | | Capacitance Change | Within $\pm 3.0\%$ or $\pm 0.3\text{pF}$ (Whichever is larger) | | | | | | | | | | | | | | | |
| | | Q | C \geq 30pF: 350 or more C < 30pF: 275+5/2C or more C: Nominal Capacitance (pF) | | | | | | | | | | | | | | | |
| | | I.R. | 3000M Ω or more | | | | | | | | | | | | | | | |
| | | Voltage Proof | No defects. | | | | | | | | | | | | | | | |
| | | | Fix the capacitor to the supporting test substrate B (glass epoxy board) shown in "Complement of Test Method". Before this test, the test shown in the following is performed. • No.12 Adhesive Strength of Termination (apply force: 5N) • No.13 Substrate Bending test Next, Impulse Voltage test is performed. Each individual capacitor shall be subjected to a 5kV Impulse (the voltage value means zero to peak) for 3 times. Then the capacitors are applied to life test. <div style="text-align: center;"> <p>Front time (T1) = 1.2μs=1.67T Time to half-value (T2) = 50μs</p> </div> Apply voltage as Table for 1000h at 125+2/-0°C, relative humidity 50% max. <div style="border: 1px solid black; padding: 5px; margin: 10px 0;"> Applied voltage AC425V (r.m.s.), except that once each hour the voltage is increased to AC1000V (r.m.s.) for 0.1s. </div> Exposure Time: 24 \pm 2h at room condition*. | | | | | | | | | | | | | | | |
| 17 | Passive Flammability | The burning time shall not be exceeded the time 30s. The tissue paper shall not ignite. | The capacitor under test shall be held in the flame in the position which best promotes burning. Each specimen shall only be exposed once to the flame. Time of exposure to flame: 30s Length of flame: 12 \pm 1mm Gas burner: Length 35mm min. Inside dia: 0.5 \pm 0.1mm Outside dia: 0.9mm max. Gas: Butane gas purity 95% min. <div style="text-align: center;"> </div> | | | | | | | | | | | | | | | |
| | | | | | | | | | | | | | | | | | | |

* Room Condition: Temperature: 15 to 35°C, Relative humidity: 45 to 75%, Atmosphere pressure: 86 to 106kPa

Continued on the following page. ↗

GRM
 GR3
 GRJ
 GR4
 GR7
 GJM
 GQM
 GA2
 GA3 GB
 GA3 GD
 GA3 GF
 LLL
 LLA
 LLM
 LLR
 NFM
 KRM
 KR3
 GMA
 GMD
 Caution / Notice

GA3 Series Type GF Specifications and Test Methods (1)

Continued from the preceding page. ↘

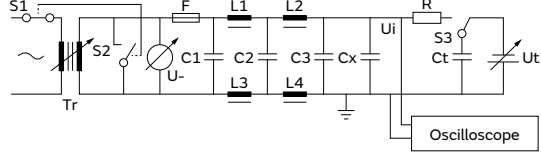
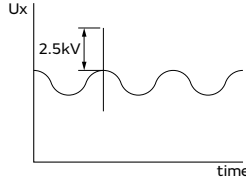
| No | Item | Specification | Test Method (Ref. Standard: JIS C 5101, IEC60384) |
|----|---------------------|---------------------------------------|---|
| 18 | Active Flammability | The cheesecloth shall not be on fire. | <p>The specimens shall be individually wrapped in at least one but more than two complete layers of cheesecloth. The specimens shall be subjected to 20 discharges. The interval between successive discharges shall be 5s. The UAC shall be maintained for 2min after the last discharge.</p>  <p>C1, C2: Filter capacitor $1\mu\text{F}\pm 10\%$ C3: Capacitor $0.033\mu\text{F}\pm 5\%$ L1 to L4: Rod coa choke $1.5\text{mH}\pm 20\%$, 16A R: Resistor $100\Omega\pm 2\%$ $C_x < 0.068\mu\text{F}$ Ct: Tank capacitor $3\mu\text{F}\pm 5\%$ 10kV $C_x \leq 1\mu\text{F}$ U-: $UR\pm 5\%$ UR: Rated voltage Cx: Capacitor under test F: Slow-blow fuse, rated 16A Ut: Voltage to which the tank capacitor Ct is charged</p>  |

GRM
 GR3
 GRJ
 GR4
 GR7
 GJM
 GQM
 GA2
 GA3 GB
 GA3 GD
 GA3 GF
 LLL
 LLA
 LLM
 LLR
 NFM
 KPM
 KR3
 GMA
 GMD
 ⚠Caution / Notice

GA3 Series Type GF Specifications and Test Methods (1)

Continued from the preceding page. ↘

Complement of Test Method

1. Test Substrate

The test substrate should be Substrate A or Substrate B as described in "Specifications and Test Methods".
 The specimen should be soldered by the conditions as described below.

Soldering Method: Reflow soldering
 Solder: Sn-3.0Ag-0.5Cu

(1) Test Substrate A

• Land Dimensions



| Part Number | Dimension (mm) | | |
|--------------|----------------|-----|-----|
| | a | b | c |
| GA342 | 3.5 | 7.0 | 2.4 |

- Material: Glass Epoxy Board
- Thickness: 1.6mm
- Thickness of Copper Foil: 0.035mm

(2) Test Substrate B

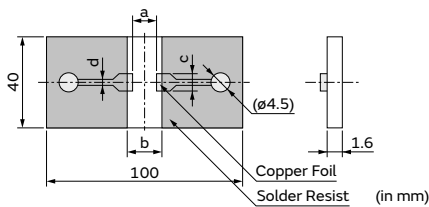

| Part Number | Dimension of Pattern (mm) | | | |
|--------------|---------------------------|-----|-----|-----|
| | a | b | c | d |
| GA342 | 3.5 | 7.0 | 2.4 | 1.0 |

- Material: Glass Epoxy Board
- Thickness of Copper Foil: 0.035mm

2. Test Method of Substrate Bending Test

(a) Support State

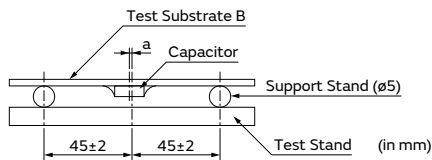

a: ±2 gap between support stand center and test stand

(b) Test State

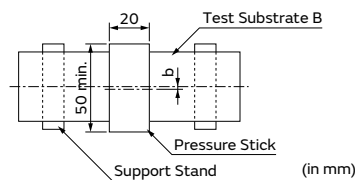

b: ±5 gap between support stand center and test stand center

- Material of Test Stand and Pressure Stick
 The material should be a metal where a remarkable transformation and the distortion are not caused even if it is pressurized.
- Pressurizing Speed
 The pressurizing speed is pressurized at the speed of about 1mm/s until the flexure reaches a regulated value.

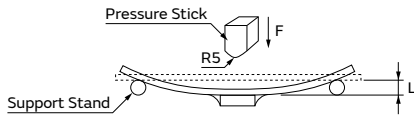

GRM
 GR3
 GRJ
 GR4
 GR7
 GJM
 GQM
 GA2
 GA3 GB
 GA3 GD
 GA3 GF
 LLL
 LLA
 LLM
 LLR
 NFM
 KRM
 KR3
 GMA
 GMD
 Caution / Notice

2

GA3 Series Type GF Specifications and Test Methods (2)

| No | Item | Specification | Test Method (Ref. Standard: JIS C 5101, IEC60384) | | | | | | | | | | | | |
|------|--|---|--|------|------------------|---|--------------------|---|-------------------------|---|--------------------|---|-------------------------|---|--------------------|
| 1 | Appearance | No defects or abnormalities. | Visual inspection. | | | | | | | | | | | | |
| 2 | Dimension | Within the specified dimensions. | Using calipers and micrometers. | | | | | | | | | | | | |
| 3 | Voltage Proof | No defects or abnormalities. | Measurement Point: Between the terminations Test Voltage: AC2000V (r.m.s.) Applied Time: 60±1s Charge/discharge current: 50mA max. | | | | | | | | | | | | |
| 4 | Impulse Voltage | No self healing break downs or flash-overs have taken place in the capacitor. | 10 impulse of alternating polarity is subjected. (5 impulse for each polarity) The interval between impulse is 60s. Applied Voltage: 2.5kVo-p | | | | | | | | | | | | |
| 5 | Insulation Resistance (I.R.) | 6000MΩ or more | Measurement Point: Between the terminations Measurement Voltage: DC500±50V Charging Time: 60±5s Charge/discharge current: 50mA max. Measurement Temperature: Room Temperature | | | | | | | | | | | | |
| 6 | Capacitance | Shown in Rated value. | Measurement Temperature: Room Temperature Measurement Frequency: 1.0±0.1kHz Measurement Voltage: AC1.0±0.2V (r.m.s.) | | | | | | | | | | | | |
| 7 | Dissipation Factor (D.F.) | 0.025 max. | | | | | | | | | | | | | |
| 8 | Temperature Characteristics of Capacitance | R7: Within ±15% (-55 to +125°C) | The capacitance change should be measured after 5 minutes at each specified temp. stage. Capacitance value as a reference is the value in step 3. <table border="1" style="margin-left: auto; margin-right: auto;"> <thead> <tr> <th>Step</th> <th>Temperature (°C)</th> </tr> </thead> <tbody> <tr> <td>1</td> <td>Reference Temp. ±2</td> </tr> <tr> <td>2</td> <td>Min. Operating Temp. ±3</td> </tr> <tr> <td>3</td> <td>Reference Temp. ±2</td> </tr> <tr> <td>4</td> <td>Max. Operating Temp. ±3</td> </tr> <tr> <td>5</td> <td>Reference Temp. ±2</td> </tr> </tbody> </table> <ul style="list-style-type: none"> • Pretreatment Perform a heat treatment at 150+0/-10°C for 1h±5min and then let sit for 24±2h at room condition*. | Step | Temperature (°C) | 1 | Reference Temp. ±2 | 2 | Min. Operating Temp. ±3 | 3 | Reference Temp. ±2 | 4 | Max. Operating Temp. ±3 | 5 | Reference Temp. ±2 |
| Step | Temperature (°C) | | | | | | | | | | | | | | |
| 1 | Reference Temp. ±2 | | | | | | | | | | | | | | |
| 2 | Min. Operating Temp. ±3 | | | | | | | | | | | | | | |
| 3 | Reference Temp. ±2 | | | | | | | | | | | | | | |
| 4 | Max. Operating Temp. ±3 | | | | | | | | | | | | | | |
| 5 | Reference Temp. ±2 | | | | | | | | | | | | | | |
| 9 | Vibration | Appearance | No defects or abnormalities. | | | | | | | | | | | | |
| | | Capacitance | Within the specified initial value. | | | | | | | | | | | | |
| | | D.F. | Within the specified initial value. | | | | | | | | | | | | |
| 10 | Solderability | 95% of the terminations is to be soldered evenly and continuously. | Test Method: Solder bath method Flux: Solution of rosin ethanol 25 (wt)% Preheat: 80 to 120°C for 10 to 30s Solder: Sn-3.0Ag-0.5Cu (Lead Free Solder) Solder Temp.: 245±5°C Immersion time: 2±0.5s Immersing in speed: 25±2.5mm/s. | | | | | | | | | | | | |
| 11 | Resistance to Soldering Heat | Appearance | No defects or abnormalities. | | | | | | | | | | | | |
| | | Capacitance Change | Within ±10% | | | | | | | | | | | | |
| | | I.R. | 1000MΩ or more | | | | | | | | | | | | |
| | | Voltage Proof | No defects. | | | | | | | | | | | | |
| 12 | Adhesive Strength of Termination | No removal of the terminations or other defect should occur. | Solder the capacitor on the test substrate A shown in "Complement of Test Method".  Applied Direction: In parallel with the test substrate and vertical with the capacitor side. | | | | | | | | | | | | |

* Room Condition: Temperature: 15 to 35°C, Relative humidity: 45 to 75%, Atmosphere pressure: 86 to 106kPa

Continued on the following page. ↗

GRM
 GR3
 GRJ
 GR4
 GR7
 GJM
 GQM
 GA2
 GA3 GB
 GA3 GD
 GA3 GF
 LLL
 LLA
 LLM
 LLR
 NFM
 KFM
 KR3
 GMA
 GMD
 ⚠Caution / Notice

GA3 Series Type GF Specifications and Test Methods (2)

Continued from the preceding page. ↘

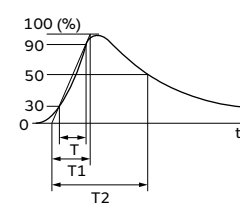
| No | Item | Specification | Test Method (Ref. Standard: JIS C 5101, IEC60384) | | | | | | | | | | | | | | | |
|--------------------|---|------------------------------|--|----------------------------|------------|------------|---|----------------------------|------|---|------------|--------|---|----------------------------|------|---|------------|--------|
| 13 | Substrate Bending Test | No defects or abnormalities. | Solder the capacitor on the test substrate B shown in "Complement of Test Method". Then apply the force in the direction shown in "Test Method of Substrate Bending Test" of "Complement of Test Method". Flexure: 1mm Holding Time: 5±1s Soldering Method: Reflow soldering | | | | | | | | | | | | | | | |
| 14 | Temperature Sudden Change | Appearance | Fix the capacitor to the supporting test substrate A (glass epoxy board) shown in "Complement of Test Method". Perform the 5 cycles according to the four heat treatments shown in the following table. <table border="1" style="margin: 10px auto;"> <thead> <tr> <th>Step</th> <th>Temp. (°C)</th> <th>Time (min)</th> </tr> </thead> <tbody> <tr> <td>1</td> <td>Min. Operating Temp. +0/-3</td> <td>30±3</td> </tr> <tr> <td>2</td> <td>Room Temp.</td> <td>2 to 3</td> </tr> <tr> <td>3</td> <td>Max. Operating Temp. +3/-0</td> <td>30±3</td> </tr> <tr> <td>4</td> <td>Room Temp.</td> <td>2 to 3</td> </tr> </tbody> </table> Exposure Time: 24±2h at room condition*. • Pretreatment Perform a heat treatment at 150+0/-10°C for 1h±5min and then let sit for 24±2h at room condition*. | Step | Temp. (°C) | Time (min) | 1 | Min. Operating Temp. +0/-3 | 30±3 | 2 | Room Temp. | 2 to 3 | 3 | Max. Operating Temp. +3/-0 | 30±3 | 4 | Room Temp. | 2 to 3 |
| | | Step | | Temp. (°C) | Time (min) | | | | | | | | | | | | | |
| | | 1 | | Min. Operating Temp. +0/-3 | 30±3 | | | | | | | | | | | | | |
| | | 2 | | Room Temp. | 2 to 3 | | | | | | | | | | | | | |
| | | 3 | | Max. Operating Temp. +3/-0 | 30±3 | | | | | | | | | | | | | |
| 4 | Room Temp. | 2 to 3 | | | | | | | | | | | | | | | | |
| Capacitance Change | Within±15% | | | | | | | | | | | | | | | | | |
| D.F. | 0.05 max. | | | | | | | | | | | | | | | | | |
| I.R. | 3000MΩ or more | | | | | | | | | | | | | | | | | |
| Voltage Proof | No defects. | | | | | | | | | | | | | | | | | |
| 15 | High Temperature High Humidity (Steady) | Appearance | Fix the capacitor to the supporting test substrate B (glass epoxy board) shown in "Complement of Test Method". Before this test, the test shown in the following is performed. • No.12 Adhesive Strength of Termination (apply force: 5N) • No.13 Substrate Bending Test Test Temperature: 40±2°C Test Humidity: 90 to 95%RH Test Time: 500+24/-0h Applied Voltage: Rated voltage Exposure Time: 24±2h at room condition*. • Pretreatment Perform a heat treatment at 150+0/-10°C for 1h±5min and then let sit for 24±2h at room condition*. | | | | | | | | | | | | | | | |
| | | Capacitance Change | | Within±15% | | | | | | | | | | | | | | |
| | | D.F. | | 0.05 max. | | | | | | | | | | | | | | |
| | | I.R. | | 3000MΩ or more | | | | | | | | | | | | | | |
| | | Voltage Proof | | No defects. | | | | | | | | | | | | | | |
| 16 | Durability | Appearance | Fix the capacitor to the supporting test substrate B (glass epoxy board) shown in "Complement of Test Method". Before this test, the test shown in the following is performed. • No.12 Adhesive Strength of Termination (apply force: 5N) • No.13 Substrate Bending Test Next, Impulse Voltage test is performed. Each individual capacitor shall be subjected to a 5kV Impulse (the voltage value means zero to peak) for 3 times. Then the capacitors are applied to life test.  Front time (T1) = 1.2μs=1.67T Time to half-value (T2) = 50μs | | | | | | | | | | | | | | | |
| | | Capacitance Change | | Within ±20% | | | | | | | | | | | | | | |
| | | D.F. | | 0.05 max. | | | | | | | | | | | | | | |
| | | I.R. | | 3000MΩ or more | | | | | | | | | | | | | | |
| | | Voltage Proof | | No defects. | | | | | | | | | | | | | | |

* Room Condition: Temperature: 15 to 35°C, Relative humidity: 45 to 75%, Atmosphere pressure: 86 to 106kPa

Continued on the following page. ↗

GRM
GR3
GRJ
GR4
GR7
GJM
GQM
GA2
GA3 GB
GA3 GD
GA3 GF
LLL
LLA
LLM
LLR
NFM
KRM
KR3
GMA
GMD
Caution / Notice

GA3 Series Type GF Specifications and Test Methods (2)

Continued from the preceding page. ↘

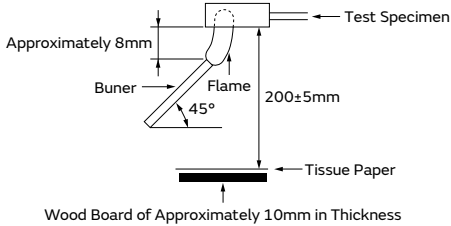
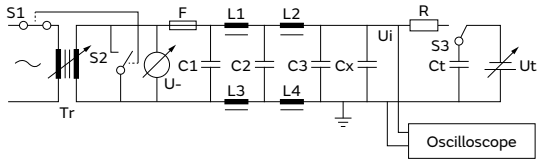
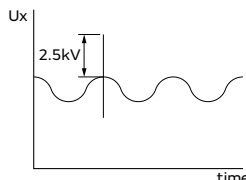
| No | Item | Specification | Test Method (Ref. Standard: JIS C 5101, IEC60384) |
|----|----------------------|--|---|
| 17 | Passive Flammability | The burning time shall not be exceeded the time 30s. The tissue paper shall not ignite. | <p>The capacitor under test shall be held in the flame in the position which best promotes burning. Each specimen shall only be exposed once to the flame. Time of exposure to flame: 30s Length of flame: 12±1mm Gas burner: Length 35mm min. Inside dia: 0.5±0.1mm Outside dia: 0.9mm max. Gas: Butane gas purity 95% min.</p>  |
| 18 | Active Flammability | The cheesecloth shall not be on fire. | <p>The specimens shall be individually wrapped in at least one but more than two complete layers of cheesecloth. The specimens shall be subjected to 20 discharges. The interval between successive discharges shall be 5s. The UAC shall be maintained for 2min after the last discharge.</p>  <p>C1, C2: Filter capacitor 1μF±10% C3: Capacitor 0.033μF±5% L1 to L4: Rod coa choke 1.5mH±20%, 16A R: Resistor 100Ω±2% Cx < 0.068μF Ct: Tank capacitor 3μF±5% 10kV Cx ≤ 1μF U-: UR±5% UR: Rated voltage Cx: Capacitor under test F: Slow-blow fuse, rated 16A Ut: Voltage to which the tank capacitor Ct is charged</p>  |

GRM
 GR3
 GRJ
 GR4
 GR7
 GJM
 GQM
 GA2
 GA3 GB
 GA3 GD
 GA3 GF
 LLL
 LLA
 LLM
 LLR
 NFM
 KPM
 KR3
 GMA
 GMD
 ⚠Caution / Notice

GA3 Series Type GF Specifications and Test Methods (2)

Continued from the preceding page. ↘

Complement of Test Method

1. Test Substrate

The test substrate should be Substrate A or Substrate B as described in "Specifications and Test Methods".
 The specimen should be soldered by the conditions as described below.

Soldering Method: Reflow soldering
 Solder: Sn-3.0Ag-0.5Cu

(1) Test Substrate A

- Land Dimensions

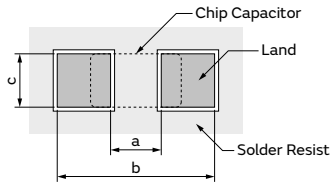

- Material: Glass Epoxy Board
- Thickness: 1.6mm
- Thickness of Copper Foil: 0.035mm

| Part Number | Dimension (mm) | | |
|-------------|----------------|-----|-----|
| | a | b | c |
| GA342 | 3.5 | 7.0 | 2.4 |
| GA352 | 4.5 | 8.0 | 3.2 |
| GA355 | 4.5 | 8.0 | 5.6 |

(2) Test Substrate B

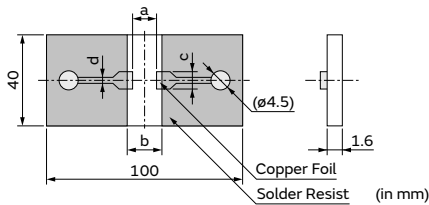

- Material: Glass Epoxy Board
- Thickness of Copper Foil: 0.035mm

| Part Number | Dimension of Pattern (mm) | | | |
|-------------|---------------------------|-----|-----|-----|
| | a | b | c | d |
| GA342 | 3.5 | 7.0 | 2.4 | 1.0 |
| GA352 | 4.5 | 8.0 | 3.2 | 1.0 |
| GA355 | 4.5 | 8.0 | 5.6 | 1.0 |

2. Test Method of Substrate Bending Test

(a) Support State

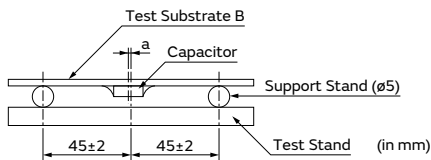

a: ±2 gap between support stand center and test stand

- Material of Test Stand and Pressure Stick
 The material should be a metal where a remarkable transformation and the distortion are not caused even if it is pressurized.
- Pressurizing Speed
 The pressurizing speed is pressurized at the speed of about 1mm/s until the flexure reaches a regulated value.

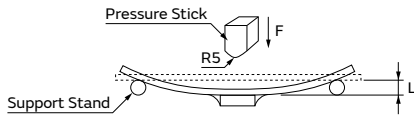

(b) Test State

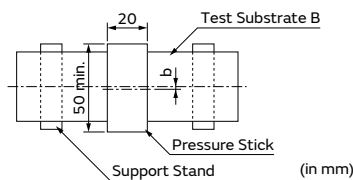

b: ±5 gap between support stand center and test stand center

GRM
 GR3
 GRJ
 GR4
 GR7
 GJM
 GQM
 GA2
 GA3 GB
 GA3 GD
 GA3 GF
 LLL
 LLA
 LLM
 LLR
 NFM
 KRM
 KR3
 GMA
 GMD
 Caution / Notice

LW Reversed Low ESL Chip Multilayer Ceramic Capacitors for General Purpose

LLL Series



This low ESL capacitor is ideal for power supply decoupling of high-speed operation electronic equipment.

Features

1 Low ESL

Since the equivalent series inductance (ESL) is low and excellent in high frequency characteristics, this capacitor is suitable for power supply decoupling of high-speed operation electronic equipment.

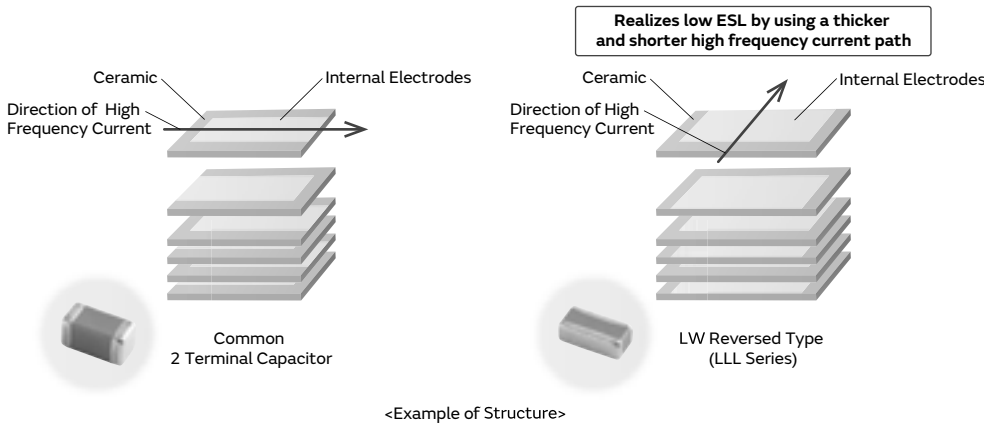

2 Contributes to a reduction in the number of components.

The number of components can be reduced by using low ESL capacitors, while maintaining functions equivalent to general purpose capacitors (GRM Series).

Murata proposes the use of the LLL series to reduce the number of components and high costs. Simulation is also possible.

Proposal for Cost Reductions

WEB

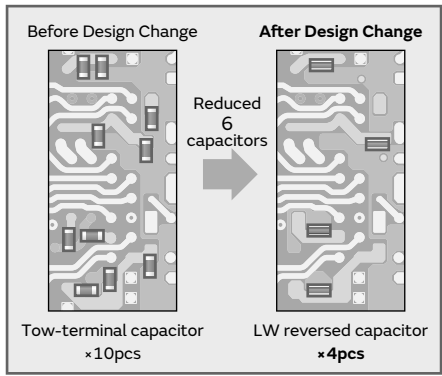

3 A maximum operating temperature up to 125°C

We also offer an abundant lineup of X7* characteristics that can be used in high temperature locations, such as IC packages.

Specifications

| | |
|-------------------|-------------------------------|
| Size (mm) | 0.5×1.0mm to 1.6×3.2mm |
| Rated Voltage | 2.5Vdc to 50Vdc |
| Capacitance | 2200pF to 10μF |
| Main Applications | Application processor/CPU/GPU |

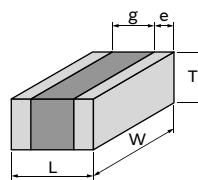

This catalog contains only a portion of the product lineup. Please refer to the capacitor search tool on the Murata Web site for details.

- GRM
- GR3
- GRJ
- GR4
- GR7
- GJM
- GQM
- GA2
- GA3 GB
- GA3 GD
- GA3 GF
- LLL
- LLA
- LLM
- LLR
- NFM
- KRM
- KR3
- GMA
- GMD
- △Caution /Notice

LLL Series High Dielectric Constant Type Part Number List

0.5×1.0mm

| T max. | Rated Voltage | TC Code | Cap. | Tol. | Part Number |
|--------|---------------|---------|--------|------|--------------------|
| 0.35mm | 6.3Vdc | X6S | 0.10μF | ±20% | LLL153C80J104ME01# |
| | | | 0.22μF | ±20% | LLL153C80J224ME14# |
| | 4Vdc | X7S | 0.47μF | ±20% | LLL153C70G474ME17# |
| | | X6S | 1.0μF | ±20% | LLL153C80G105ME21# |

0.6×1.0mm

| T max. | Rated Voltage | TC Code | Cap. | Tol. | Part Number |
|--------|---------------|---------|-------|------|------------------------------|
| 0.45mm | 4Vdc | X5R | 4.3μF | ±20% | LLL1U4R60G435ME22# D1 |

0.8×1.6mm

| T max. | Rated Voltage | TC Code | Cap. | Tol. | Part Number |
|--------|---------------|---------|--------------------|--------|--------------------|
| 0.5mm | 25Vdc | X7R | 10000pF | ±20% | LLL185R71E103MA11# |
| | | | 22000pF | ±20% | LLL185R71C223MA11# |
| | | | | ±20% | LLL185R71C473MA11# |
| | 10Vdc | X7R | 0.10μF | ±20% | LLL185R71A104MA11# |
| | | | X7S | 0.22μF | ±20% |
| 0.55mm | 4Vdc | X7S | 2.2μF | ±20% | LLL185C70G225ME01# |
| 0.6mm | 50Vdc | X7R | 2200pF | ±20% | LLL185R71H222MA01# |
| | | | 4700pF | ±20% | LLL185R71H472MA01# |
| | 25Vdc | X7R | 10000pF | ±20% | LLL185R71E103MA01# |
| | | | 22000pF | ±20% | LLL185R71E223MA01# |
| | 16Vdc | X7R | 47000pF | ±20% | LLL185R71C473MA01# |
| | | | 10Vdc | X7R | 0.10μF |
| | 0.22μF | ±20% | LLL185R71A224MA01# | | |
| | | 4Vdc | X7S | 0.47μF | ±20% |

1.25×2.0mm

| T max. | Rated Voltage | TC Code | Cap. | Tol. | Part Number |
|---------|---------------|--------------------|--------------------|--------------------|--------------------|
| 0.5mm | 50Vdc | X7R | 10000pF | ±20% | LLL215R71H103MA11# |
| | | | 22000pF | ±20% | LLL215R71E223MA11# |
| | 16Vdc | X7R | 47000pF | ±20% | LLL215R71C473MA11# |
| | | | 0.10μF | ±20% | LLL215R71C104MA11# |
| | 10Vdc | X7R | 0.22μF | ±20% | LLL215R71A224MA11# |
| | 6.3Vdc | X7R | 0.47μF | ±20% | LLL215R70J474MA11# |
| | 4Vdc | X7S | 1.0μF | ±20% | LLL215C70G105MA11# |
| 10Vdc | | | X7R | 10000pF | ±20% |
| 22000pF | ±20% | LLL216R71H223MA01# | | | |
| | 25Vdc | X7R | 47000pF | ±20% | LLL216R71E473MA01# |
| 0.10μF | | | ±20% | LLL216R71E104MA01# | |
| 10Vdc | X7R | 0.22μF | ±20% | LLL216R71A224MA01# | |
| 0.95mm | 16Vdc | X7R | 0.22μF | ±20% | LLL219R71C224MA01# |
| | | | 10Vdc | X7R | 0.47μF |
| | 1.0μF | ±20% | LLL219R71A105MA01# | | |
| | | 4Vdc | X7S | 2.2μF | ±20% |

1.6×3.2mm

| T max. | Rated Voltage | TC Code | Cap. | Tol. | Part Number | | |
|---------|---------------|---------|--------------------|--------------------|--------------------|--------------------|--------------------|
| 0.5mm | 50Vdc | X7R | 10000pF | ±20% | LLL315R71H103MA11# | | |
| | | | 22000pF | ±20% | LLL315R71H223MA11# | | |
| | | | 47000pF | ±20% | LLL315R71E473MA11# | | |
| | 25Vdc | X7R | 0.10μF | ±20% | LLL315R71E104MA11# | | |
| | | | 16Vdc | X7R | 0.22μF | ±20% | LLL315R71C224MA11# |
| | | | 10Vdc | X7R | 0.47μF | ±20% | LLL315R71A474MA11# |
| 0.8mm | 50Vdc | X7R | 10000pF | ±20% | LLL317R71H103MA01# | | |
| | | | 22000pF | ±20% | LLL317R71H223MA01# | | |
| | | | 47000pF | ±20% | LLL317R71H473MA01# | | |
| | 25Vdc | X7R | 0.10μF | ±20% | LLL317R71E104MA01# | | |
| | | | 16Vdc | X7R | 0.22μF | ±20% | LLL317R71C224MA01# |
| | | | | | 0.47μF | ±20% | LLL317R71C474MA01# |
| | 10Vdc | X7R | 1.0μF | ±20% | LLL317R71A105MA01# | | |
| | 1.25mm | 6.3Vdc | X7R | 2.2μF | ±20% | LLL317R70J225MA01# | |
| | | | | 50Vdc | X7R | 0.10μF | ±20% |
| 22000pF | | | | | | ±20% | LLL31MR71E224MA01# |
| 0.47μF | | ±20% | LLL31MR71E474MA01# | | | | |
| | | 16Vdc | X7R | 1.0μF | ±20% | LLL31MR71C105MA01# | |
| 10Vdc | | X7R | 2.2μF | ±20% | LLL31MR71A225MA01# | | |
| 6.3Vdc | X7R | 4.7μF | ±20% | LLL31MR70J475MA01# | | | |
| | | X5R | 10μF | ±20% | LLL31MR60J106ME01# | | |

Part number # indicates the package specification code.

GRM
GR3
GRJ
GR4
GR7
GJM
GQM
GA2
GA3 GB
GA3 GD
GA3 GF
LLL
LLA
LLM
LLR
NFM
KRM
KR3
GMA
GMD
⚠Caution /Notice

LLL Series Specifications and Test Methods

Specifications and Test Methods, please refer to the search web page.
<https://www.murata.com/en-global/products/capacitor>

LLL Series High Dielectric Constant Typ

0.5×1.0mm

| T max. | Rated Voltage | TC Code | Cap. | Tol. | Part Number |
|--------|---------------|---------|--------|-------|--------------------|
| 0.35mm | 6.3Vdc | X6S | 0.10μF | ±20% | LLL153C70G104ME01# |
| | | | 0.22μF | ±20% | LLL153C70J224ME14# |
| | 4Vdc | X7S | 0.47μF | ±20% | LLL153C70E047ME17# |
| | | | X6S | 1.0μF | ±20% |

0.6×1.0mm

| T max. | Rated Voltage | TC Code | Cap. | Tol. | Part Number |
|--------|---------------|---------|------|------|-------------|
|--------|---------------|---------|------|------|-------------|

Links are provided to the product detail pages on the web, and are shown below in the product number table from the PDF version of the catalog which is available on the web.

Detailed Specifications Sheet

- Rated value
- Specifications and Test Methods
- Package
- Caution, Notice

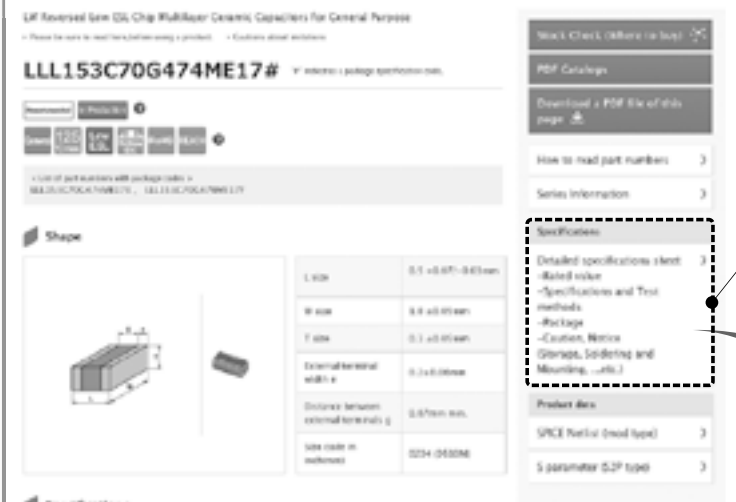

Specifications and Test Methods

| No | Item | Specification | Test Method (Ref. Standard: JIS C 5101, IEC60384) | | | | | | | | | | | | |
|----------------------|--|--|--|-------------|-----------------|-----------------------|---------------------|----------------------|---------------|----------------------|---------------------------|---------------|----------------------|------------|---------------|
| 1 | Rated Voltage | Shown in Rated value. | The rated voltage is defined as the maximum voltage which may be applied continuously to the capacitor. When AC voltage is superimposed on DC voltage, V^{AC-P} or V^{AC-N} , whichever is larger, should be maintained within the rated voltage range. | | | | | | | | | | | | |
| 2 | Appearance | No defects or abnormalities. | Visual inspection. | | | | | | | | | | | | |
| 3 | Dimension | Within the specified dimensions. | Using Measuring instrument of dimension. | | | | | | | | | | | | |
| 4 | Voltage proof | No defects or abnormalities. | Measurement Point : Between the terminations Test Voltage : 250% of the rated voltage Applied Time : 1 to 5 s Charge/discharge current : 50mA max. | | | | | | | | | | | | |
| 5 | Insulation Resistance(I.R.) | More than 2000MΩ or 50Ω · F (Whichever is smaller) | Measurement Point : Between the terminations Measurement Voltage : DC Rated Voltage Charging Time : 1 min (LLL153C70E474M only 2 min) Charge/discharge current : 50mA max. Measurement Temperature : Room Temperature | | | | | | | | | | | | |
| 6 | Capacitance | Shown in Rated value. | Measurement Temperature : Room Temperature <table border="1"> <thead> <tr> <th>Capacitance</th> <th>Frequency</th> <th>Voltage</th> </tr> </thead> <tbody> <tr> <td>C ≤ 10μF (10V min.)</td> <td>1.0+/-0.1kHz</td> <td>1.0+/-0.2Vrms</td> </tr> <tr> <td>C ≤ 10μF (6.3V max.)</td> <td>1.0+/-0.1kHz</td> <td>0.5+/-0.1Vrms</td> </tr> <tr> <td>C > 10μF</td> <td>120+/-24Hz</td> <td>0.5+/-0.1Vrms</td> </tr> </tbody> </table> | Capacitance | Frequency | Voltage | C ≤ 10μF (10V min.) | 1.0+/-0.1kHz | 1.0+/-0.2Vrms | C ≤ 10μF (6.3V max.) | 1.0+/-0.1kHz | 0.5+/-0.1Vrms | C > 10μF | 120+/-24Hz | 0.5+/-0.1Vrms |
| Capacitance | Frequency | Voltage | | | | | | | | | | | | | |
| C ≤ 10μF (10V min.) | 1.0+/-0.1kHz | 1.0+/-0.2Vrms | | | | | | | | | | | | | |
| C ≤ 10μF (6.3V max.) | 1.0+/-0.1kHz | 0.5+/-0.1Vrms | | | | | | | | | | | | | |
| C > 10μF | 120+/-24Hz | 0.5+/-0.1Vrms | | | | | | | | | | | | | |
| 7 | Dissipation Factor (D.F.) | 0.120 max. | | | | | | | | | | | | | |
| 8 | Temperature Characteristics of Capacitance | No bias R6 : Within +/-15% (-55°C to +85°C) C7 : Within +/-22% (-55°C to +125°C) C8 : Within +/-22% (-55°C to +105°C) D7 : Within +/-22/-33% (-55°C to +125°C) D8 : Within +/-22/-33% (-55°C to +105°C) | The capacitance change should be measured after 5 min. at each specified temp. stage. Capacitance value as a reference is the value in step 3. - Measurement Voltage : LLL153 D7 0E/0G 224M only : 0.25+/-0.05Vrms LLL153 C7 0E/0G 104M only : 0.30+/-0.05Vrms LLL152R60G105M , LLL152D80E105M only : 0.10+/-0.03Vrms <table border="1"> <thead> <tr> <th>Step</th> <th>Temperature(°C)</th> <th>Applying Voltage(VDC)</th> </tr> </thead> <tbody> <tr> <td>1</td> <td>Reference Temp. +/-2</td> <td rowspan="3">No bias</td> </tr> <tr> <td>2</td> <td>Min. Operating Temp. +/-3</td> </tr> <tr> <td>3</td> <td>Reference Temp. +/-2</td> </tr> </tbody> </table> | Step | Temperature(°C) | Applying Voltage(VDC) | 1 | Reference Temp. +/-2 | No bias | 2 | Min. Operating Temp. +/-3 | 3 | Reference Temp. +/-2 | | |
| Step | Temperature(°C) | Applying Voltage(VDC) | | | | | | | | | | | | | |
| 1 | Reference Temp. +/-2 | No bias | | | | | | | | | | | | | |
| 2 | Min. Operating Temp. +/-3 | | | | | | | | | | | | | | |
| 3 | Reference Temp. +/-2 | | | | | | | | | | | | | | |

Specifications

Capacitance: 0.47μF ±20%

Rated voltage: 4Vdc

Temperature characteristics (room temp. standard): K250(A)

Capacitance change rate: ±1.0%

Temperature range of temperature characteristics: -55 to 125

Operating temperature range: -55 to 125

References

Package: SMD (Chip)

Material: Paper (Ceramic)

Chart of characteristic data

- GRM
- GR3
- GRJ
- GR4
- GR7
- GJM
- GQM
- GA2
- GA3 GB
- GA3 GD
- GA3 GF
- LLL
- LLA
- LLM
- LLR
- NFM
- KRM
- KR3
- GMA
- GMD
- ⚠Caution / Notice

8 Terminals Low ESL Chip Multilayer Ceramic Capacitors for General Purpose

LLA Series



8-Terminal Type Low ESL Capacitor Ideal for Power Supply Decoupling of High-speed Operation IC

Features

① Ultra-low ESL

Since the equivalent series inductance (ESL) is very low with excellent high frequency characteristics due to the design structure, this capacitor is ideal for power supply decoupling of high-speed operation IC.

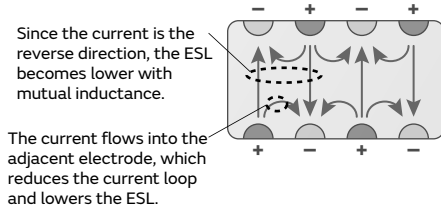
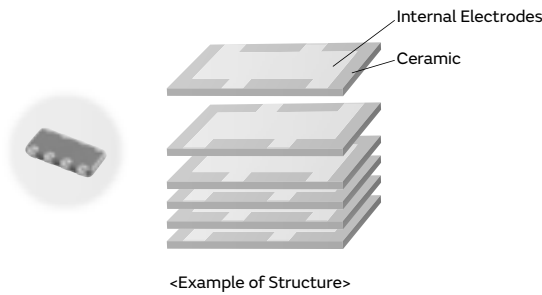

<Effectiveness of Cancelling Out Inductance by Mutual Inductance>

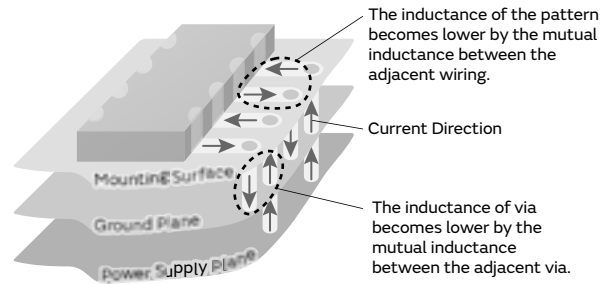

<Effectiveness of Suppressing Inductance when Mounting a Multi-terminal Capacitor>

The inductance for the boards also becomes lower, not only the capacitor.

② A maximum operating temperature up to 125°C

This product is applicable to high temperatures (X7* characteristics); however, Murata also offers numerous thin type products, which are ideal as decoupling capacitors on IC package.

Specifications

| | |
|-------------------|-------------------------------|
| Size (mm) | 1.6×0.8mm to 2.0×1.25mm |
| Rated Voltage | 4Vdc to 25Vdc |
| Capacitance | 10000pF to 4.7μF |
| Main Applications | Application processor/CPU/GPU |

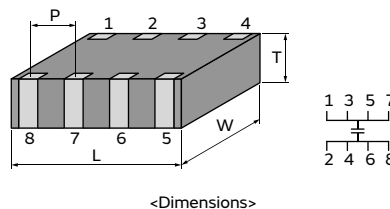

This catalog contains only a portion of the product lineup. Please refer to the capacitor search tool on the Murata Web site for details.

GRM
 GR3
 GRJ
 GR4
 GR7
 GJM
 GQM
 GA2
 GA3 GB
 GA3 GD
 GA3 GF
 LLL
 LLA
 LLM
 LLR
 NFM
 KRM
 KR3
 GMA
 GMD
 Caution /Notice

LLA Series High Dielectric Constant Type Part Number List

1.6×0.8mm

| T max. | Rated Voltage | TC Code | Cap. | Tol. | Part Number | p* |
|--------|---------------|---------|--------|------|--------------------|------|
| 0.55mm | 4Vdc | X7S | 0.10μF | ±20% | LLA185C70G104MA01# | p224 |
| | | | 0.22μF | ±20% | LLA185C70G224MA01# | p224 |
| | | | 0.47μF | ±20% | LLA185C70G474MA01# | p224 |
| | | | 2.2μF | ±20% | LLA185C70G225ME16# | p226 |

2.0×1.25mm

| T max. | Rated Voltage | TC Code | Cap. | Tol. | Part Number | p* |
|--------|---------------|---------|---------|------|--------------------|------|
| 0.55mm | 25Vdc | X7R | 10000pF | ±20% | LLA215R71E103MA14# | p224 |
| | | | 22000pF | ±20% | LLA215R71E223MA14# | p224 |
| | 16Vdc | X7R | 47000pF | ±20% | LLA215R71C473MA14# | p224 |
| | | | 0.10μF | ±20% | LLA215R71C104MA14# | p224 |
| | 10Vdc | X7R | 0.22μF | ±20% | LLA215R71A224MA14# | p224 |
| | 6.3Vdc | X7R | 0.47μF | ±20% | LLA215R70J474MA14# | p224 |
| | 4Vdc | X7S | 1.0μF | ±20% | LLA215C70G105MA14# | p224 |
| | | | 4.7μF | ±20% | LLA215C70G475ME19# | p226 |
| 0.95mm | 25Vdc | X7R | 10000pF | ±20% | LLA219R71E103MA01# | p224 |
| | | | 22000pF | ±20% | LLA219R71E223MA01# | p224 |
| | | | 47000pF | ±20% | LLA219R71E473MA01# | p224 |
| | 16Vdc | X7R | 0.10μF | ±20% | LLA219R71C104MA01# | p224 |
| | | | 0.22μF | ±20% | LLA219R71C224MA01# | p224 |
| | 10Vdc | X7R | 0.47μF | ±20% | LLA219R71A474MA01# | p224 |
| | 6.3Vdc | X7R | 1.0μF | ±20% | LLA219R70J105MA01# | p224 |
| | 4Vdc | X7S | 2.2μF | ±20% | LLA219C70G225MA01# | p224 |

*: Refers to the page of the "Specifications and Test Methods".

Part number # indicates the package specification code.

- GRM
- GR3
- GRJ
- GR4
- GR7
- GJM
- GQM
- GA2
- GA3 GB
- GA3 GD
- GA3 GF
- LLL
- LLA
- LLM
- LLR
- NFM
- KRM
- KR3
- GMA
- GMD
- ⚠Caution /Notice

1

LLA Series Specifications and Test Methods (1)

| No | Item | Specification | Test Method (Ref. Standard: JIS C 5101, IEC60384) | | | | | | | | | | | | | | | |
|---|--|---|---|-------------|------------------------------------|-----------------------|------------------------|----------------------------|---------------------|---|------------------------------|--------|-------------------------|----------------------------|------------------------------|---|-------------------------|--------|
| 1 | Rated Voltage | Shown in Rated value. | The rated voltage is defined as the maximum voltage which may be applied continuously to the capacitor. When AC voltage is superimposed on DC voltage, V^{P-P} or V^{O-P} , whichever is larger, should be maintained within the rated voltage range. | | | | | | | | | | | | | | | |
| 2 | Appearance | No defects or abnormalities. | Visual inspection. | | | | | | | | | | | | | | | |
| 3 | Dimension | Within the specified dimensions. | Using Measuring instrument of dimension. | | | | | | | | | | | | | | | |
| 4 | Voltage Proof | No defects or abnormalities. | Measurement Point: Between the terminations Test Voltage: 250% of the rated voltage Applied Time: 1 to 5s Charge/discharge current: 50mA max. | | | | | | | | | | | | | | | |
| 5 | Insulation Resistance (I.R.) | $C \leq 0.047\mu\text{F}$: More than 10000M Ω $C > 0.047\mu\text{F}$: More than 500 $\Omega \cdot \text{F}$ C: Nominal Capacitance | Measurement Point: Between the terminations Measurement Voltage: DC Rated Voltage Charging Time: 2min Charge/discharge current: 50mA max. Measurement Temperature: Room Temperature | | | | | | | | | | | | | | | |
| 6 | Capacitance | Shown in Rated value. | Measurement Temperature: Room Temperature | | | | | | | | | | | | | | | |
| 7 | Dissipation Factor (D.F.) | W.V.:25Vdc min.: 0.025max. W.V.:16/10Vdc: 0.035max. W.V.:6.3Vdc max.: 0.05max. | <table border="1"> <thead> <tr> <th>Capacitance</th> <th>Frequency</th> <th>Voltage</th> </tr> </thead> <tbody> <tr> <td>$C \leq 10\mu\text{F}$</td> <td>1.0\pm0.1kHz</td> <td>1.0\pm0.2Vrms *</td> </tr> </tbody> </table> | Capacitance | Frequency | Voltage | $C \leq 10\mu\text{F}$ | 1.0 \pm 0.1kHz | 1.0 \pm 0.2Vrms * | | | | | | | | | |
| | | | Capacitance | Frequency | Voltage | | | | | | | | | | | | | |
| $C \leq 10\mu\text{F}$ | 1.0 \pm 0.1kHz | 1.0 \pm 0.2Vrms * | | | | | | | | | | | | | | | | |
| * For item LLA185 C7 0G 274 to 474, the capacitance should be measured using a voltage of 0.5 \pm 0.1Vrms. For item LLA185/215 C7 0G 473, the capacitance should be measured using a voltage of 0.5 \pm 0.2Vrms. | | | | | | | | | | | | | | | | | | |
| 8 | Temperature Characteristics of Capacitance | No Bias R7: Within $\pm 15\%$ (-55 to +125 $^{\circ}\text{C}$) R6: Within $\pm 15\%$ (-55 to +85 $^{\circ}\text{C}$) C7: Within $\pm 22\%$ (-55 to +125 $^{\circ}\text{C}$) | The capacitance change should be measured after 5 minutes at each specified temp. stage. Capacitance value as a reference is the value in step 3. | | | | | | | | | | | | | | | |
| | | | <table border="1"> <thead> <tr> <th>Step</th> <th>Temperature ($^{\circ}\text{C}$)</th> <th>Applying Voltage(VDC)</th> </tr> </thead> <tbody> <tr> <td>1</td> <td>Reference Temp. ± 2</td> <td rowspan="5">No bias</td> </tr> <tr> <td>2</td> <td>Min. Operating Temp. ± 3</td> </tr> <tr> <td>3</td> <td>Reference Temp. ± 2</td> </tr> <tr> <td>4</td> <td>Max. Operating Temp. ± 3</td> </tr> <tr> <td>5</td> <td>Reference Temp. ± 2</td> </tr> </tbody> </table> | Step | Temperature ($^{\circ}\text{C}$) | Applying Voltage(VDC) | 1 | Reference Temp. ± 2 | No bias | 2 | Min. Operating Temp. ± 3 | 3 | Reference Temp. ± 2 | 4 | Max. Operating Temp. ± 3 | 5 | Reference Temp. ± 2 | |
| Step | Temperature ($^{\circ}\text{C}$) | Applying Voltage(VDC) | | | | | | | | | | | | | | | | |
| 1 | Reference Temp. ± 2 | No bias | | | | | | | | | | | | | | | | |
| 2 | Min. Operating Temp. ± 3 | | | | | | | | | | | | | | | | | |
| 3 | Reference Temp. ± 2 | | | | | | | | | | | | | | | | | |
| 4 | Max. Operating Temp. ± 3 | | | | | | | | | | | | | | | | | |
| 5 | Reference Temp. ± 2 | | | | | | | | | | | | | | | | | |
| 9 | Adhesive Strength of Termination | No removal of the terminations or other defect should occur. | Solder the capacitor on the test substrate (glass epoxy board). Applied Force: 5N Holding Time: 10 \pm 1s Applied Direction: In parallel with the test substrate and vertical with the capacitor side. | | | | | | | | | | | | | | | |
| 10 | Vibration | Appearance | No defects or abnormalities. | | | | | | | | | | | | | | | |
| | | Capacitance | Within the specified initial value. | | | | | | | | | | | | | | | |
| | | D.F. | Within the specified initial value. | | | | | | | | | | | | | | | |
| 11 | Solderability | 75% of the terminations is to be soldered evenly and continuously. | Test Method: Solder bath method Flux: Solution of rosin ethanol 25 (mass)% Preheat: 80 to 120 $^{\circ}\text{C}$ for 10 to 30s Solder: Sn-3.0Ag-0.5Cu Solder Temp.: 245 \pm 5 $^{\circ}\text{C}$ Immersion time: 2 \pm 0.5s | | | | | | | | | | | | | | | |
| 12 | Temperature Sudden Change | Appearance | No defects or abnormalities. | | | | | | | | | | | | | | | |
| | | Capacitance Change | Within $\pm 7.5\%$ | | | | | | | | | | | | | | | |
| | | D.F. | Within the specified initial value. | | | | | | | | | | | | | | | |
| | | I.R. | Within the specified initial value. | | | | | | | | | | | | | | | |
| | | Voltage Proof | No defects. | | | | | | | | | | | | | | | |
| | | | Solder the capacitor on the test substrate (glass epoxy board). Perform the 5 cycles according to the four heat treatments shown in the following table. | | | | | | | | | | | | | | | |
| | | | <table border="1"> <thead> <tr> <th>Step</th> <th>Temp. ($^{\circ}\text{C}$)</th> <th>Time (min)</th> </tr> </thead> <tbody> <tr> <td>1</td> <td>Min. Operating Temp. +0/-3</td> <td>30\pm3</td> </tr> <tr> <td>2</td> <td>Room Temp.</td> <td>2 to 3</td> </tr> <tr> <td>3</td> <td>Max. Operating Temp. +3/-0</td> <td>30\pm3</td> </tr> <tr> <td>4</td> <td>Room Temp.</td> <td>2 to 3</td> </tr> </tbody> </table> | Step | Temp. ($^{\circ}\text{C}$) | Time (min) | 1 | Min. Operating Temp. +0/-3 | 30 \pm 3 | 2 | Room Temp. | 2 to 3 | 3 | Max. Operating Temp. +3/-0 | 30 \pm 3 | 4 | Room Temp. | 2 to 3 |
| Step | Temp. ($^{\circ}\text{C}$) | Time (min) | | | | | | | | | | | | | | | | |
| 1 | Min. Operating Temp. +0/-3 | 30 \pm 3 | | | | | | | | | | | | | | | | |
| 2 | Room Temp. | 2 to 3 | | | | | | | | | | | | | | | | |
| 3 | Max. Operating Temp. +3/-0 | 30 \pm 3 | | | | | | | | | | | | | | | | |
| 4 | Room Temp. | 2 to 3 | | | | | | | | | | | | | | | | |
| | | | Exposure Time: 24 \pm 2h • Initial measurement Perform a heat treatment at 150+0/-10 $^{\circ}\text{C}$ for 1h and then let sit for 24 \pm 2h at room temperature, then measure. | | | | | | | | | | | | | | | |

Continued on the following page. ↗

GRM
 GR3
 GRJ
 GR4
 GR7
 GJM
 GQM
 GA2
 GA3 GB
 GA3 GD
 GA3 GF
 LLL
 LLA
 LLM
 LLR
 NFM
 KRM
 KR3
 GMA
 GMD
 ⚠Caution /Notice

LLA Series Specifications and Test Methods (1)

Continued from the preceding page. ↘

| No | Item | Specification | Test Method (Ref. Standard: JIS C 5101, IEC60384) |
|----|---|--------------------|--|
| 13 | High Temperature High Humidity (Steady) | Appearance | No defects or abnormalities. |
| | | Capacitance Change | Within $\pm 12.5\%$ |
| | | D.F. | W.V.: 10Vdc min.: 0.05max. W.V.: 6.3Vdc max.: 0.075max. |
| | | I.R. | More than 500M Ω or 25 Ω • F (Whichever is smaller) |
| 14 | Durability | Appearance | No defects or abnormalities. |
| | | Capacitance Change | Within $\pm 12.5\%$ |
| | | D.F. | W.V.:10Vdc min.: 0.05max. W.V.:6.3Vdc max.: 0.075max. |
| | | I.R. | More than 1000M Ω or 50 Ω • F (Whichever is smaller) |
| | | | Solder the capacitor on the test substrate (glass epoxy board). Test Temperature: 40 $\pm 2^{\circ}\text{C}$ Test Humidity: 90 to 95%RH Test Time: 500 ± 12 h Applied Voltage: DC Rated Voltage Charge/discharge current: 50mA max. Exposure Time: 24 ± 2 h |
| | | | Solder the capacitor on the test substrate (glass epoxy board). Test Temperature: Max. Operating Temp. $\pm 3^{\circ}\text{C}$ Test Time: 1000 ± 12 h Applied Voltage: 200% of the rated voltage Charge/discharge current: 50mA max. Exposure Time: 24 ± 2 h • Initial measurement Apply 200% of the rated DC voltage at the max. operating temp. $\pm 3^{\circ}\text{C}$ for 1h. Remove and set for 24 ± 2 h at room temperature. Perform initial measurement. |

GRM

GR3

GRJ

GR4

GR7

GJM

GQM

GA2

GA3
GB

GA3
GD

GA3
GF

LLL

LLA

LLM

LLR

NFM

KPM

KR3

GMA

GMD

⚠Caution
/Notice

2

LLA Series Specifications and Test Methods (2)

| No | Item | Specification | Test Method (Ref. Standard: JIS C 5101, IEC60384) | | | | | | | | | | | | | | | |
|---------------------------------------|--|--|---|--|-------------|------------------|--------------------------------------|----------------------------|--------------------|---------------------------------------|------------|-------------------------|---------------------|----------------------------|-------------|-------------------------|------------|--------------------|
| 1 | Rated Voltage | Shown in Rated value. | The rated voltage is defined as the maximum voltage which may be applied continuously to the capacitor. When AC voltage is superimposed on DC voltage, V^{P-P} or V^{O-P} , whichever is larger, should be maintained within the rated voltage range. | | | | | | | | | | | | | | | |
| 2 | Appearance | No defects or abnormalities. | Visual inspection. | | | | | | | | | | | | | | | |
| 3 | Dimension | Within the specified dimensions. | Using Measuring instrument of dimension. | | | | | | | | | | | | | | | |
| 4 | Voltage Proof | No defects or abnormalities. | Measurement Point: Between the terminations Test Voltage: 250% of the rated voltage Applied Time: 1 to 5s Charge/discharge current: 50mA max. | | | | | | | | | | | | | | | |
| 5 | Insulation Resistance (I.R.) | More than 2000MΩ or 50Ω · F (Whichever is smaller) | Measurement Point: Between the terminations Measurement Voltage: DC Rated Voltage Charging Time: 1min Charge/discharge current: 50mA max. Measurement Temperature: Room Temperature | | | | | | | | | | | | | | | |
| 6 | Capacitance | Shown in Rated value. | Measurement Temperature: Room Temperature | | | | | | | | | | | | | | | |
| 7 | Dissipation Factor (D.F.) | 0.120max. | <table border="1"> <thead> <tr> <th>Capacitance</th> <th>Frequency</th> <th>Voltage</th> </tr> </thead> <tbody> <tr> <td>$C \leq 10\mu\text{F}$ (10V min.)</td> <td>1.0±0.1kHz</td> <td>1.0±0.2Vrms</td> </tr> <tr> <td>$C \leq 10\mu\text{F}$ (6.3V max.)</td> <td>1.0±0.1kHz</td> <td>0.5±0.1Vrms</td> </tr> <tr> <td>$C > 10\mu\text{F}$</td> <td>120±24Hz</td> <td>0.5±0.1Vrms</td> </tr> </tbody> </table> | Capacitance | Frequency | Voltage | $C \leq 10\mu\text{F}$ (10V min.) | 1.0±0.1kHz | 1.0±0.2Vrms | $C \leq 10\mu\text{F}$ (6.3V max.) | 1.0±0.1kHz | 0.5±0.1Vrms | $C > 10\mu\text{F}$ | 120±24Hz | 0.5±0.1Vrms | | | |
| | | | Capacitance | Frequency | Voltage | | | | | | | | | | | | | |
| | | | $C \leq 10\mu\text{F}$ (10V min.) | 1.0±0.1kHz | 1.0±0.2Vrms | | | | | | | | | | | | | |
| $C \leq 10\mu\text{F}$ (6.3V max.) | 1.0±0.1kHz | 0.5±0.1Vrms | | | | | | | | | | | | | | | | |
| $C > 10\mu\text{F}$ | 120±24Hz | 0.5±0.1Vrms | | | | | | | | | | | | | | | | |
| 8 | Temperature Characteristics of Capacitance | No Bias | C7: Within ±22% (-55 to +125°C) | | | | | | | | | | | | | | | |
| | | | | <table border="1"> <thead> <tr> <th>Step</th> <th>Temperature (°C)</th> <th>Applying Voltage(VDC)</th> </tr> </thead> <tbody> <tr> <td>1</td> <td>Reference Temp. ±2</td> <td rowspan="5">No bias</td> </tr> <tr> <td>2</td> <td>Min. Operating Temp. ±3</td> </tr> <tr> <td>3</td> <td>Reference Temp. ±2</td> </tr> <tr> <td>4</td> <td>Max. Operating Temp. ±3</td> </tr> <tr> <td>5</td> <td>Reference Temp. ±2</td> </tr> </tbody> </table> | Step | Temperature (°C) | Applying Voltage(VDC) | 1 | Reference Temp. ±2 | No bias | 2 | Min. Operating Temp. ±3 | 3 | Reference Temp. ±2 | 4 | Max. Operating Temp. ±3 | 5 | Reference Temp. ±2 |
| Step | Temperature (°C) | Applying Voltage(VDC) | | | | | | | | | | | | | | | | |
| 1 | Reference Temp. ±2 | No bias | | | | | | | | | | | | | | | | |
| 2 | Min. Operating Temp. ±3 | | | | | | | | | | | | | | | | | |
| 3 | Reference Temp. ±2 | | | | | | | | | | | | | | | | | |
| 4 | Max. Operating Temp. ±3 | | | | | | | | | | | | | | | | | |
| 5 | Reference Temp. ±2 | | | | | | | | | | | | | | | | | |
| 9 | Adhesive Strength of Termination | No removal of the terminations or other defect should occur. | The capacitance change should be measured after 5 minutes at each specified temp. stage. Capacitance value as a reference is the value in step 3. • Initial measurement Perform a heat treatment at 150+0/-10°C for 1h and then let sit for 24±2h at room temperature, then measure. | | | | | | | | | | | | | | | |
| 10 | Vibration | Appearance | No defects or abnormalities. | | | | | | | | | | | | | | | |
| | | Capacitance | Within the specified initial value. | | | | | | | | | | | | | | | |
| | | D.F. | Within the specified initial value. | | | | | | | | | | | | | | | |
| 11 | Solderability | 75% of the terminations is to be soldered evenly and continuously. | Solder the capacitor on the test substrate (glass epoxy board). Applied Force: 5N Holding Time: 10±1s Applied Direction: In parallel with the test substrate and vertical with the capacitor side. Test Method: Solder bath method Flux: Solution of rosin ethanol 25 (mass)% Preheat: 80 to 120°C for 10 to 30s Solder: Sn-3.0Ag-0.5Cu Solder Temp.: 245±5°C Immersion time: 2±0.5s | | | | | | | | | | | | | | | |
| 12 | Temperature Sudden Change | Appearance | No defects or abnormalities. | | | | | | | | | | | | | | | |
| | | Capacitance Change | Within ±12.5% | | | | | | | | | | | | | | | |
| | | D.F. | Within the specified initial value. | | | | | | | | | | | | | | | |
| | | I.R. | Within the specified initial value. | | | | | | | | | | | | | | | |
| | | Voltage Proof | No defects. | | | | | | | | | | | | | | | |
| | | | <table border="1"> <thead> <tr> <th>Step</th> <th>Temp. (°C)</th> <th>Time (min)</th> </tr> </thead> <tbody> <tr> <td>1</td> <td>Min. Operating Temp. +0/-3</td> <td>30±3</td> </tr> <tr> <td>2</td> <td>Room Temp.</td> <td>2 to 3</td> </tr> <tr> <td>3</td> <td>Max. Operating Temp. +3/-0</td> <td>30±3</td> </tr> <tr> <td>4</td> <td>Room Temp.</td> <td>2 to 3</td> </tr> </tbody> </table> EExposure Time: 24±2h • Initial measurement Perform a heat treatment at 150+0/-10°C for 1h and then let sit for 24±2h at room temperature, then measure. | Step | Temp. (°C) | Time (min) | 1 | Min. Operating Temp. +0/-3 | 30±3 | 2 | Room Temp. | 2 to 3 | 3 | Max. Operating Temp. +3/-0 | 30±3 | 4 | Room Temp. | 2 to 3 |
| Step | Temp. (°C) | Time (min) | | | | | | | | | | | | | | | | |
| 1 | Min. Operating Temp. +0/-3 | 30±3 | | | | | | | | | | | | | | | | |
| 2 | Room Temp. | 2 to 3 | | | | | | | | | | | | | | | | |
| 3 | Max. Operating Temp. +3/-0 | 30±3 | | | | | | | | | | | | | | | | |
| 4 | Room Temp. | 2 to 3 | | | | | | | | | | | | | | | | |

Continued on the following page. ↗

GRM
 GR3
 GRJ
 GR4
 GR7
 GJM
 GQM
 GA2
 GA3 GB
 GA3 GD
 GA3 GF
 LLL
 LLA
 LLM
 LLR
 NFM
 KRM
 KR3
 GMA
 GMD
 ⚠Caution /Notice

LLA Series Specifications and Test Methods (2)

Continued from the preceding page. ↘

| No | Item | Specification | Test Method (Ref. Standard: JIS C 5101, IEC60384) |
|----|---|---|---|
| 13 | High Temperature High Humidity (Steady) | Appearance | No defects or abnormalities. |
| | Capacitance Change | Within $\pm 12.5\%$ | Solder the capacitor on the test substrate (glass epoxy board). Test Temperature: $40 \pm 2^\circ\text{C}$ Test Humidity: 90 to 95%RH Test Time: $500 \pm 12\text{h}$ |
| | D.F. | 0.2 max. | Applied Voltage: DC Rated Voltage Charge/discharge current: 50mA max. |
| | I.R. | More than $500\text{M}\Omega$ or $12.5\Omega \cdot \text{F}$ (Whichever is smaller) | • Initial measurement Perform a heat treatment at $150+0/-10^\circ\text{C}$ for 1h and then let sit for $24 \pm 2\text{h}$ at room temperature, then measure. • Measurement after test Perform a heat treatment at $150+0/-10^\circ\text{C}$ for 1h and then let sit for $24 \pm 2\text{h}$ at room temperature, then measure. |
| 14 | Durability | Appearance | No defects or abnormalities. |
| | | Capacitance Change | Within $\pm 12.5\%$ |
| | | D.F. | 0.2 max. |
| | | I.R. | More than $1000\text{M}\Omega$ or $25\Omega \cdot \text{F}$ (Whichever is smaller) |
| | | | Solder the capacitor on the test substrate (glass epoxy board). Test Temperature: Max. Operating Temp. $\pm 3^\circ\text{C}$ Test Time: $1000 \pm 12\text{h}$ Applied Voltage: 150% of the rated voltage Charge/discharge current: 50mA max. • Initial measurement Perform a heat treatment at $150+0/-10^\circ\text{C}$ for 1h and then let sit for $24 \pm 2\text{h}$ at room temperature, then measure. • Measurement after test Perform a heat treatment at $150+0/-10^\circ\text{C}$ for 1h and then let sit for $24 \pm 2\text{h}$ at room temperature, then measure. |

GRM

GR3

GRJ

GR4

GR7

GJM

GQM

GA2

GA3 GB

GA3 GD

GA3 GF

LLL

LLA

LLM

LLR

NFM

KPM

KR3

GMA

GMD

⚠Caution / Notice

227

10 Terminals Low ESL Chip Multilayer Ceramic Capacitors for General Purpose

LLM Series



10-Terminal Type Low ESL Capacitor Ideal for Power Supply Decoupling of High-speed Operation IC

Features

① This is the lowest ESL LW reversed type capacitor.

Since the equivalent series inductance (ESL) of this product is even lower than the LLA series (8-terminal product) with excellent high frequency characteristics, this capacitor is ideal for power supply decoupling of high-speed operation IC.

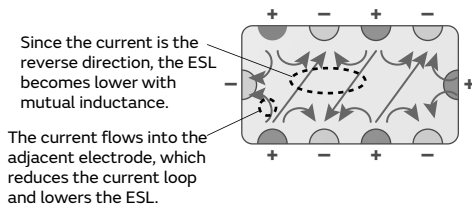
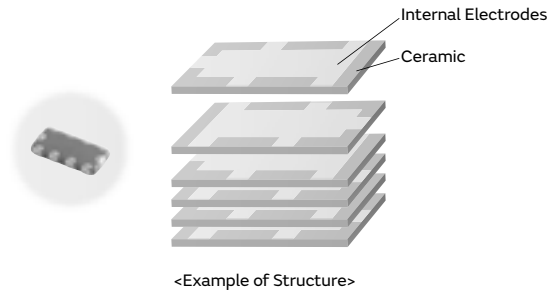

<Effectiveness of Cancelling Out Inductance by Mutual Inductance>

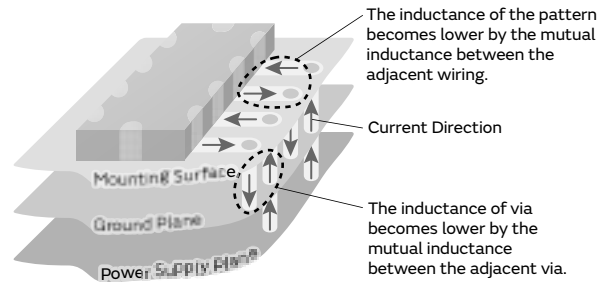

<Effectiveness of Suppressing Inductance when Mounting a Multi-terminal Capacitor>

The inductance for the boards also becomes lower, not only the capacitor.

② A maximum operating temperature up to 125°C

This product is applicable to high temperatures (X7* characteristics); however, Murata also offers numerous thin type products, which are ideal as decoupling capacitors on IC package.

Specifications

| | |
|-------------------|-------------------------------|
| Size (mm) | 2.0×1.25mm |
| Rated Voltage | 4Vdc to 25Vdc |
| Capacitance | 0.22μF to 1.0μF |
| Main Applications | Application processor/CPU/GPU |

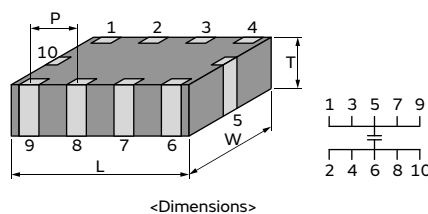

This catalog contains only a portion of the product lineup. Please refer to the capacitor search tool on the Murata Web site for details.

GRM
 GR3
 GRJ
 GR4
 GR7
 GJM
 GQM
 GA2
 GA3 GB
 GA3 GD
 GA3 GF
 LLL
 LLA
 LLM
 LLR
 NFM
 KRM
 KR3
 GMA
 GMD
 ⚠Caution /Notice

LLM Series High Dielectric Constant Type Part Number List

2.0×1.25mm

| T max. | Rated Voltage | TC Code | Cap. | Tol. | Part Number | p* |
|--------|---------------|---------|--------|------|--------------------|------|
| 0.55mm | 6.3Vdc | X7R | 0.22μF | ±20% | LLM215R70J224MA11# | p230 |
| | | | 0.47μF | ±20% | LLM215R70J474MA11# | p230 |
| | 4Vdc | X7S | 1.0μF | ±20% | LLM215C70G105MA11# | p230 |

GRM

GR3

GRJ

GR4

GR7

GJM

GQM

GA2

GA3
GB

GA3
GD

GA3
GF

LLL

LLA

LLM

LLR

NFM

KRM

KR3

GMA

GMD

⚠Caution / Notice

*: Refers to the page of the "Specifications and Test Methods".

Part number # indicates the package specification code.

1

LLM Series Specifications and Test Methods (1)

| No | Item | Specification | Test Method (Ref. Standard: JIS C 5101, IEC60384) | | | | | | | | | | | | | | | |
|--|---|--|---|-------------|--------------------|------------|----------|----------------------------|---------------|--------------------|------------|-------------------------|---|----------------------------|------|---|------------|--------|
| 1 | Rated Voltage | Shown in Rated value. | The rated voltage is defined as the maximum voltage which may be applied continuously to the capacitor. When AC voltage is superimposed on DC voltage, V ^{P-P} or V ^{O-P} , whichever is larger, should be maintained within the rated voltage range. | | | | | | | | | | | | | | | |
| 2 | Appearance | No defects or abnormalities. | Visual inspection. | | | | | | | | | | | | | | | |
| 3 | Dimension | Within the specified dimensions. | Using Measuring instrument of dimension. | | | | | | | | | | | | | | | |
| 4 | Voltage Proof | No defects or abnormalities. | Measurement Point: Between the terminations Test Voltage: 250% of the rated voltage Applied Time: 1 to 5s Charge/discharge current: 50mA max. | | | | | | | | | | | | | | | |
| 5 | Insulation Resistance (I.R.) | C ≤ 0.047μF: More than 10000MΩ C > 0.047μF: More than 500Ω · F C: Nominal Capacitance | Measurement Point: Between the terminations Measurement Voltage: DC Rated Voltage Charging Time: 2min Charge/discharge current: 50mA max. Measurement Temperature: Room Temperature | | | | | | | | | | | | | | | |
| 6 | Capacitance | Shown in Rated value. | Measurement Temperature: Room Temperature | | | | | | | | | | | | | | | |
| 7 | Dissipation Factor (D.F.) | W.V.:25Vdc min.: 0.025max. W.V.:16/10Vdc: 0.035max. W.V.:6.3Vdc max.: 0.05max. | <table border="1"> <thead> <tr> <th>Capacitance</th> <th>Frequency</th> <th>Voltage</th> </tr> </thead> <tbody> <tr> <td>C ≤ 10μF</td> <td>1.0±0.1kHz</td> <td>1.0±0.2Vrms *</td> </tr> </tbody> </table> <p>* For item LLA185 C7 0G 274 to 474, the capacitance should be measured using a voltage of 0.5±0.1Vrms. For item LLA185/215 C7 0G 473, the capacitance should be measured using a voltage of 0.5±0.2Vrms.</p> | Capacitance | Frequency | Voltage | C ≤ 10μF | 1.0±0.1kHz | 1.0±0.2Vrms * | | | | | | | | | |
| | | | Capacitance | Frequency | Voltage | | | | | | | | | | | | | |
| C ≤ 10μF | 1.0±0.1kHz | 1.0±0.2Vrms * | | | | | | | | | | | | | | | | |
| <table border="1"> <thead> <tr> <th>Step</th> <th>Temperature (°C)</th> <th>Applying Voltage(VDC)</th> </tr> </thead> <tbody> <tr> <td>1</td> <td>Reference Temp. ±2</td> <td rowspan="5">No bias</td> </tr> <tr> <td>2</td> <td>Min. Operating Temp. ±3</td> </tr> <tr> <td>3</td> <td>Reference Temp. ±2</td> </tr> <tr> <td>4</td> <td>Max. Operating Temp. ±3</td> </tr> <tr> <td>5</td> <td>Reference Temp. ±2</td> </tr> </tbody> </table> <p>• Initial measurement Perform a heat treatment at 150+0/-10°C for 1h and then let sit for 24±2h at room temperature, then measure.</p> | Step | Temperature (°C) | Applying Voltage(VDC) | 1 | Reference Temp. ±2 | No bias | 2 | Min. Operating Temp. ±3 | 3 | Reference Temp. ±2 | 4 | Max. Operating Temp. ±3 | 5 | Reference Temp. ±2 | | | | |
| Step | Temperature (°C) | Applying Voltage(VDC) | | | | | | | | | | | | | | | | |
| 1 | Reference Temp. ±2 | No bias | | | | | | | | | | | | | | | | |
| 2 | Min. Operating Temp. ±3 | | | | | | | | | | | | | | | | | |
| 3 | Reference Temp. ±2 | | | | | | | | | | | | | | | | | |
| 4 | Max. Operating Temp. ±3 | | | | | | | | | | | | | | | | | |
| 5 | Reference Temp. ±2 | | | | | | | | | | | | | | | | | |
| 8 | Temperature Characteristics of Capacitance No Bias | R7: Within ±15% (-55 to +125°C) R6: Within ±15% (-55 to +85°C) C7: Within ±22% (-55 to +125°C) | The capacitance change should be measured after 5 minutes at each specified temp. stage. Capacitance value as a reference is the value in step 3. | | | | | | | | | | | | | | | |
| 9 | Adhesive Strength of Termination | No removal of the terminations or other defect should occur. | Solder the capacitor on the test substrate (glass epoxy board). Applied Force: 5N Holding Time: 10±1s Applied Direction: In parallel with the test substrate and vertical with the capacitor side. | | | | | | | | | | | | | | | |
| 10 | Vibration | Appearance | No defects or abnormalities. | | | | | | | | | | | | | | | |
| | | Capacitance | Within the specified initial value. | | | | | | | | | | | | | | | |
| | | D.F. | Within the specified initial value. | | | | | | | | | | | | | | | |
| 11 | Solderability | 75% of the terminations is to be soldered evenly and continuously. | Test Method: Solder bath method Flux: Solution of rosin ethanol 25 (mass)% Preheat: 80 to 120°C for 10 to 30s Solder: Sn-3.0Ag-0.5Cu Solder Temp.: 245±5°C Immersion time: 2±0.5s | | | | | | | | | | | | | | | |
| 12 | Temperature Sudden Change | Appearance | No defects or abnormalities. | | | | | | | | | | | | | | | |
| | | Capacitance Change | Within ±7.5% | | | | | | | | | | | | | | | |
| | | D.F. | Within the specified initial value. | | | | | | | | | | | | | | | |
| | | I.R. | Within the specified initial value. | | | | | | | | | | | | | | | |
| | | Voltage Proof | No defects. | | | | | | | | | | | | | | | |
| | | | <table border="1"> <thead> <tr> <th>Step</th> <th>Temp. (°C)</th> <th>Time (min)</th> </tr> </thead> <tbody> <tr> <td>1</td> <td>Min. Operating Temp. +0/-3</td> <td>30±3</td> </tr> <tr> <td>2</td> <td>Room Temp.</td> <td>2 to 3</td> </tr> <tr> <td>3</td> <td>Max. Operating Temp. +3/-0</td> <td>30±3</td> </tr> <tr> <td>4</td> <td>Room Temp.</td> <td>2 to 3</td> </tr> </tbody> </table> <p>Exposure Time: 24±2h • Initial measurement Perform a heat treatment at 150+0/-10°C for 1h and then let sit for 24±2h at room temperature, then measure.</p> | Step | Temp. (°C) | Time (min) | 1 | Min. Operating Temp. +0/-3 | 30±3 | 2 | Room Temp. | 2 to 3 | 3 | Max. Operating Temp. +3/-0 | 30±3 | 4 | Room Temp. | 2 to 3 |
| Step | Temp. (°C) | Time (min) | | | | | | | | | | | | | | | | |
| 1 | Min. Operating Temp. +0/-3 | 30±3 | | | | | | | | | | | | | | | | |
| 2 | Room Temp. | 2 to 3 | | | | | | | | | | | | | | | | |
| 3 | Max. Operating Temp. +3/-0 | 30±3 | | | | | | | | | | | | | | | | |
| 4 | Room Temp. | 2 to 3 | | | | | | | | | | | | | | | | |

Continued on the following page. ↗

GRM
GR3
GRJ
GR4
GR7
GJM
GQM
GA2
GA3 GB
GA3 GD
GA3 GF
LLL
LLA
LLM
LLR
NFM
KRM
KR3
GMA
GMD
Caution / Notice

LLM Series Specifications and Test Methods (1)

Continued from the preceding page. ↘

| No | Item | Specification | Test Method (Ref. Standard: JIS C 5101, IEC60384) |
|----|---|--------------------|--|
| 13 | High Temperature High Humidity (Steady) | Appearance | No defects or abnormalities. |
| | | Capacitance Change | Within $\pm 12.5\%$ |
| | | D.F. | W.V.: 10Vdc min.: 0.05max. W.V.: 6.3Vdc max.: 0.075max. |
| | | I.R. | More than 500M Ω or 25 Ω • F (Whichever is smaller) |
| 14 | Durability | Appearance | No defects or abnormalities. |
| | | Capacitance Change | Within $\pm 12.5\%$ |
| | | D.F. | W.V.:10Vdc min.: 0.05max. W.V.:6.3Vdc max.: 0.075max. |
| | | I.R. | More than 1000M Ω or 50 Ω • F (Whichever is smaller) |
| | | | Solder the capacitor on the test substrate (glass epoxy board). Test Temperature: 40 $\pm 2^{\circ}\text{C}$ Test Humidity: 90 to 95%RH Test Time: 500 ± 12 h Applied Voltage: DC Rated Voltage Charge/discharge current: 50mA max. Exposure Time: 24 ± 2 h |
| | | | Solder the capacitor on the test substrate (glass epoxy board). Test Temperature: Max. Operating Temp. $\pm 3^{\circ}\text{C}$ Test Time: 1000 ± 12 h Applied Voltage: 200% of the rated voltage Charge/discharge current: 50mA max. Exposure Time: 24 ± 2 h • Initial measurement Apply 200% of the rated DC voltage at the max. operating temp. $\pm 3^{\circ}\text{C}$ for 1h. Remove and set for 24 ± 2 h at room temperature. Perform initial measurement. |

GRM

GR3

GRJ

GR4

GR7

GJM

GQM

GA2

GA3

GA3

GA3

LLL

LLA

LLM

LLR

NFM

KPM

KR3

GMA

GMD

⚠Caution / Notice

LW Reversed Controlled ESR Low ESL Chip Multilayer Ceramic Capacitors for General Purpose

LLR Series



ESR Controlled Type Low ESL Capacitors Equipped with Anti-resonance Control Function

Features

① Reduces Anti-resonance

This capacitor is controlled so that the equivalent series resistance (ESR) becomes slightly higher, and is effective in reducing the anti-resonance that occurs when capacitor arrays are used.

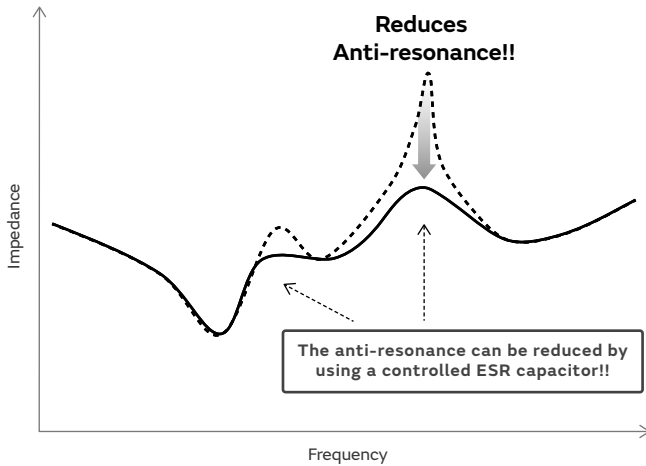

② Lineup of capacitors with ESR values from 100-1,000mΩ.

According to the conditions of the anti-resonance, the most suitable ESR value can be selected from 4 types.

③ Low ESL

This ESR controlled type capacitor has excellent high frequency characteristics, with low equivalent series inductance (ESL). This is also ideal as a decoupling component.

Specifications

| | |
|-------------------|-----------------------------|
| Size (mm) | 0.8×1.6mm |
| Rated Voltage | 4Vdc |
| Capacitance | 1.0μF |
| Main Applications | Network processor/ASIC/PMIC |

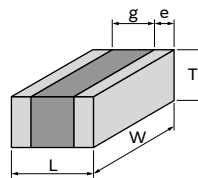

<Dimensions>

This catalog contains only a portion of the product lineup.
 Please refer to the capacitor search tool on the Murata Web site for details.

GRM
 GR3
 GRJ
 GR4
 GR7
 GJM
 GQM
 GA2
 GA3 GB
 GA3 GD
 GA3 GF
 LLL
 LLA
 LLM
LLR
 NFM
 KRM
 KR3
 GMA
 GMD
 ⚠️Caution /Notice

LLR Series High Dielectric Constant Type Part Number List

0.8×1.6mm

| T max. | Rated Voltage | TC Code | Cap. | Tol. | Part Number | p* |
|--------|---------------|---------|-------|------|--------------------|------|
| 0.55mm | 4Vdc | X7S | 1.0μF | ±20% | LLR185C70G105ME01# | p234 |
| | | | | ±20% | LLR185C70G105ME03# | p234 |
| | | | | ±20% | LLR185C70G105ME05# | p234 |
| | | | | ±20% | LLR185C70G105ME07# | p234 |

GRM

GR3

GRJ

GR4

GR7

GJM

GQM

GA2

GA3
GB

GA3
GD

GA3
GF

LLL

LLA

LLM

LLR

NFM

KRM

KR3

GMA

GMD

⚠Caution / Notice

*: Refers to the page of the "Specifications and Test Methods".

Part number # indicates the package specification code.

1

LLR Series Specifications and Test Methods (1)

| No | Item | Specification | Test Method (Ref. Standard: JIS C 5101, IEC60384) | | | | | | | | | | | | | | |
|---------------------------------------|--|--|---|------------------|-----------------------|-----------------------|--------------------------------------|--------------------|-------------|---------------------------------------|-------------------------|-------------|--------------------|-----|-------------------------|---|--------------------|
| 1 | Rated Voltage | Shown in Rated value. | The rated voltage is defined as the maximum voltage which may be applied continuously to the capacitor. When AC voltage is superimposed on DC voltage, V^{P-P} or V^{O-P} , whichever is larger, should be maintained within the rated voltage range. | | | | | | | | | | | | | | |
| 2 | Appearance | No defects or abnormalities. | Visual inspection. | | | | | | | | | | | | | | |
| 3 | Dimension | Within the specified dimensions. | Using Measuring instrument of dimension. | | | | | | | | | | | | | | |
| 4 | Voltage Proof | No defects or abnormalities. | Measurement Point: Between the terminations Test Voltage: 250% of the rated voltage Applied Time: 1 to 5s Charge/discharge current: 50mA max. | | | | | | | | | | | | | | |
| 5 | Insulation Resistance (I.R.) | More than 2000MΩ or 50Ω · F (Whichever is smaller) | Measurement Point: Between the terminations Measurement Voltage: DC Rated Voltage Charging Time: 1min Charge/discharge current: 50mA max. Measurement Temperature: Room Temperature | | | | | | | | | | | | | | |
| 6 | Capacitance | Shown in Rated value. | Measurement Temperature: Room Temperature | | | | | | | | | | | | | | |
| 7 | Dissipation Factor (D.F.) | 0.120 max. | <table border="1"> <thead> <tr> <th>Capacitance</th> <th>Frequency</th> <th>Voltage</th> </tr> </thead> <tbody> <tr> <td>$C \leq 10\mu\text{F}$ (10V min.)</td> <td>1.0±0.1kHz</td> <td>1.0±0.2Vrms</td> </tr> <tr> <td>$C \leq 10\mu\text{F}$ (6.3V max.)</td> <td>1.0±0.1kHz</td> <td>0.5±0.1Vrms</td> </tr> </tbody> </table> | Capacitance | Frequency | Voltage | $C \leq 10\mu\text{F}$ (10V min.) | 1.0±0.1kHz | 1.0±0.2Vrms | $C \leq 10\mu\text{F}$ (6.3V max.) | 1.0±0.1kHz | 0.5±0.1Vrms | | | | | |
| | | | Capacitance | Frequency | Voltage | | | | | | | | | | | | |
| $C \leq 10\mu\text{F}$ (10V min.) | 1.0±0.1kHz | 1.0±0.2Vrms | | | | | | | | | | | | | | | |
| $C \leq 10\mu\text{F}$ (6.3V max.) | 1.0±0.1kHz | 0.5±0.1Vrms | | | | | | | | | | | | | | | |
| 8 | Temperature Characteristics of Capacitance | No Bias C7: Within ±22% (-55 to +125°C) | <p>The capacitance change should be measured after 5 minutes at each specified temp. stage. Capacitance value as a reference is the value in step 3.</p> <table border="1"> <thead> <tr> <th>Step</th> <th>Temperature (°C)</th> <th>Applying Voltage(VDC)</th> </tr> </thead> <tbody> <tr> <td>1</td> <td>Reference Temp. ±2</td> <td rowspan="5">No bias</td> </tr> <tr> <td>2</td> <td>Min. Operating Temp. ±3</td> </tr> <tr> <td>3</td> <td>Reference Temp. ±2</td> </tr> <tr> <td>4</td> <td>Max. Operating Temp. ±3</td> </tr> <tr> <td>5</td> <td>Reference Temp. ±2</td> </tr> </tbody> </table> <p>• Initial measurement Perform a heat treatment at 150+0/-10°C for 1h and then let sit for 24±2h at room temperature, then measure.</p> | Step | Temperature (°C) | Applying Voltage(VDC) | 1 | Reference Temp. ±2 | No bias | 2 | Min. Operating Temp. ±3 | 3 | Reference Temp. ±2 | 4 | Max. Operating Temp. ±3 | 5 | Reference Temp. ±2 |
| | | | Step | Temperature (°C) | Applying Voltage(VDC) | | | | | | | | | | | | |
| 1 | Reference Temp. ±2 | No bias | | | | | | | | | | | | | | | |
| 2 | Min. Operating Temp. ±3 | | | | | | | | | | | | | | | | |
| 3 | Reference Temp. ±2 | | | | | | | | | | | | | | | | |
| 4 | Max. Operating Temp. ±3 | | | | | | | | | | | | | | | | |
| 5 | Reference Temp. ±2 | | | | | | | | | | | | | | | | |
| 9 | Adhesive Strength of Termination | No removal of the terminations or other defect should occur. | <p>Solder the capacitor on the test substrate (glass epoxy board). Applied Force: 5N Holding Time: 10±1s Applied Direction: In parallel with the test substrate and vertical with the capacitor side.</p> <table border="1"> <thead> <tr> <th rowspan="2">Part Number</th> <th colspan="3">Dimension (mm)</th> </tr> <tr> <th>a</th> <th>b</th> <th>c</th> </tr> </thead> <tbody> <tr> <td>LLR18</td> <td>0.3</td> <td>1.2</td> <td>2.0</td> </tr> </tbody> </table> | Part Number | Dimension (mm) | | | a | b | c | LLR18 | 0.3 | 1.2 | 2.0 | | | |
| | | Part Number | | | Dimension (mm) | | | | | | | | | | | | |
| a | b | | c | | | | | | | | | | | | | | |
| LLR18 | 0.3 | 1.2 | 2.0 | | | | | | | | | | | | | | |
| | | <p>Land Dimensions</p> <p>Fig.1</p> | | | | | | | | | | | | | | | |
| 10 | Vibration | Appearance | <p>Solder the capacitor on the test substrate (glass epoxy board). (Refer to No.9) Kind of Vibration: A simple harmonic motion 10Hz to 55Hz to 10Hz (1min) Total amplitude: 1.5mm This motion should be applied for a period of 2h in each 3 mutually perpendicular directions (total of 6h).</p> | | | | | | | | | | | | | | |
| | | Capacitance | | | | | | | | | | | | | | | |
| | | D.F. | | | | | | | | | | | | | | | |
| 11 | Solderability | 75% of the terminations is to be soldered evenly and continuously. | <p>Test Method: Solder bath method Flux: Solution of rosin ethanol 25 (mass)% Preheat: 80 to 120°C for 10 to 30s Solder: Sn-3.0Ag-0.5Cu Solder Temp.: 245±5°C Immersion time: 2±0.5s</p> | | | | | | | | | | | | | | |
| 12 | Resistance to Soldering Heat | Appearance | <p>Test Method: Solder bath Method Solder: Sn-3.0Ag-0.5Cu Solder Temp.: 270±5°C Immersion time: 10±0.5s Exposure Time: 24±2h Preheat: 120 to 150°C for 1min • Initial measurement Perform a heat treatment at 150+0/-10°C for 1h and then let sit for 24±2h at room temperature, then measure.</p> | | | | | | | | | | | | | | |
| | | Capacitance Change | | | | | | | | | | | | | | | |
| | | D.F. | | | | | | | | | | | | | | | |
| | | I.R. | | | | | | | | | | | | | | | |
| | | Voltage Proof | | | | | | | | | | | | | | | |

Continued on the following page. ↗

GRM
GR3
GRJ
GR4
GR7
GJM
GQM
GA2
GA3 GB
GA3 GD
GA3 GF
LLL
LLA
LLM
LLR
NFM
KRM
KR3
GMA
GMD
⚠Caution /Notice

LLR Series Specifications and Test Methods (1)

Continued from the preceding page. ↘

| No | Item | Specification | Test Method (Ref. Standard: JIS C 5101, IEC60384) |
|----|---|--------------------|---|
| 13 | Temperature Sudden Change | Appearance | No defects or abnormalities. |
| | | Capacitance Change | Within $\pm 12.5\%$ |
| | | D.F. | Within the specified initial value. |
| | | I.R. | Within the specified initial value. |
| | | Voltage Proof | No defects. |
| 14 | High Temperature High Humidity (Steady) | Appearance | No defects or abnormalities. |
| | | Capacitance Change | Within $\pm 12.5\%$ |
| | | D.F. | 0.2 max. |
| | | I.R. | More than 500M Ω or 12.5 $\Omega \cdot F$ (Whichever is smaller) |
| | | | |
| 15 | Durability | Appearance | No defects or abnormalities. |
| | | Capacitance Change | Within $\pm 12.5\%$ |
| | | D.F. | 0.2 max. |
| | | I.R. | More than 1000M Ω or 25 $\Omega \cdot F$ (Whichever is smaller) |
| | | | |
| 16 | ESR | | |
| | | | |
| | | | |
| | | | |
| | | | |

| Murata's Control Code | | Specification |
|-----------------------|--|-------------------------|
| E01 | | 100m $\Omega \pm 30\%$ |
| E03 | | 220m $\Omega \pm 30\%$ |
| E05 | | 470m $\Omega \pm 30\%$ |
| E07 | | 1000m $\Omega \pm 30\%$ |

| Step | Temp. (°C) | Time (min) |
|------|----------------------------|------------|
| 1 | Min. Operating Temp. +0/-3 | 30 \pm 3 |
| 2 | Room Temp. | 2 to 3 |
| 3 | Max. Operating Temp. +3/-0 | 30 \pm 3 |
| 4 | Room Temp. | 2 to 3 |

GRM

GR3

GRJ

GR4

GR7

GJM

GQM

GA2

GA3 GB

GA3 GD

GA3 GF

LLL

LLA

LLM

LLR

NFM

KPM

KR3

GMA

GMD

△Caution /Notice

3 Terminals Low ESL Chip Multilayer Ceramic Capacitors for General Purpose

NFM Series  **Low ESL** **EMI FIL®** [WEB](#) 

This is the most suitable Low ESL capacitors for noise measurement and power decoupling of highspeed electrical devices.

Features

① **Low ESL**

Since the equivalent series inductance (ESL) is low and excellent in high frequency characteristics, this capacitor is suitable for power supply decoupling of high-speed operation electronic equipment.

• 2-terminal Capacitor

Realizes Ultra low ESL by using a extremely shorter high frequency current path

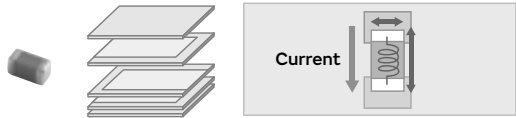

HOT × long current distance
 GND × Narrow wiring width

• 3-terminal capacitor

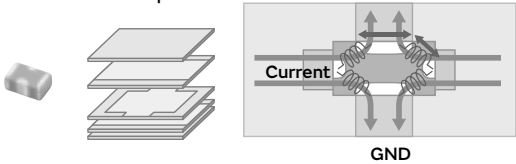

HOT ○ Short current distance
 ○ Wide wiring width
 GND ○ Four routes formed in parallel

② **Contributes to a reduction in the number of components.**

The number of components can be reduced by using low ESL capacitors, while maintaining functions equivalent to 2-terminal capacitor.

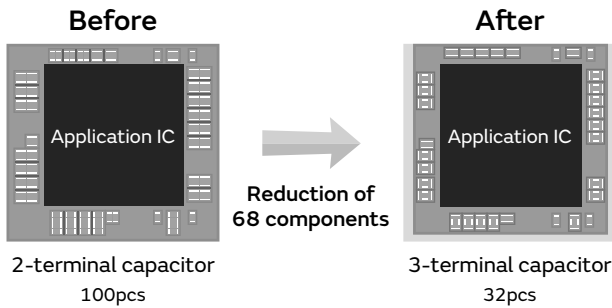

③ **Contributes to noise suppression**

Example of noise suppression effect [WEB](#) 

Specifications

| | |
|-------------------|--|
| Size (mm) | 1.0×0.5mm to 4.5×1.6mm |
| Rated Voltage | 2.5Vdc to 100Vdc |
| Capacitance | 100pF to 27μF |
| Main Applications | For decoupling and smoothing circuits, For noise suppression |

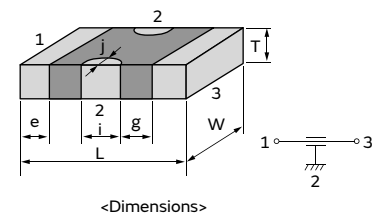

GRM GR3 GRJ GR4 GR7 GJM GQM GA2 GA3 GB GA3 GD GA3 GF LLL LLA LLM LLR NFM KRM KR3 GMA GMD Caution /Notice

NFM Series Part Number List

1.0×0.5mm

| T max. | Rated Voltage | Cap. | Tol. | Part Number |
|--------|---------------|---------|-----------------|-----------------|
| 0.35mm | 6.3Vdc | 0.47µF | ±20% | NFM15PC474R0J3# |
| | 4Vdc | 0.47µF | ±20% | NFM15PC474D0G3# |
| | | 1.0µF | ±20% | NFM15PC105R0G3# |
| 0.5mm | 16Vdc | 2200pF | ±20% | NFM15CC222D1C3# |
| | | 22000pF | ±20% | NFM15CC223C1C3# |
| | | 47000pF | ±20% | NFM15PC473C1C3# |
| | 10Vdc | 2200pF | ±20% | NFM15CC222D1A3# |
| | | 22000pF | ±20% | NFM15CC223C1A3# |
| | | 47000pF | ±20% | NFM15PC473C1A3# |
| | | 0.10µF | ±20% | NFM15PC104R1A3# |
| | | 0.22µF | ±20% | NFM15PC224R1A3# |
| | 6.3Vdc | 0.10µF | ±20% | NFM15PC104D0J3# |
| 0.22µF | | ±20% | NFM15PC224D0J3# | |
| 2.5Vdc | 4.3µF | ±20% | NFM15PC435R0E3# | |
| 0.65mm | 2.5Vdc | 7.5µF | ±20% | NFM15PC755R0E3# |
| 0.7mm | 2.5Vdc | 9.1µF | ±20% | NFM15PC915R0E3# |

1.6×0.8mm

| T max. | Rated Voltage | Cap. | Tol. | Part Number |
|--------|---------------|-----------------|-----------------|-----------------|
| 0.7mm | 16Vdc | 100pF | ±20% | NFM18CC101R1C3# |
| | | 220pF | ±20% | NFM18CC221R1C3# |
| | | 470pF | ±20% | NFM18CC471R1C3# |
| | | 1000pF | ±20% | NFM18CC102R1C3# |
| | | 2200pF | ±20% | NFM18CC222R1C3# |
| | | 22000pF | ±20% | NFM18CC223R1C3# |
| | | 0.10µF | ±20% | NFM18PC104R1C3# |
| | 6.3Vdc | 0.22µF | ±20% | NFM18PC224R0J3# |
| | | 0.47µF | ±20% | NFM18PC474R0J3# |
| | | | ±20% | NFM18PS474R0J3# |
| 1.0µF | ±20% | NFM18PS105D0J3# | | |
| | | ±20% | NFM18PS105R0J3# | |
| 0.9mm | 10Vdc | 2.2µF | ±20% | NFM18PC225B1A3# |
| | 6.3Vdc | 1.0µF | ±20% | NFM18PC105R0J3# |

2.0×1.25mm

| T max. | Rated Voltage | Cap. | Tol. | Part Number |
|--------|---------------|---------|------|-----------------|
| 0.95mm | 50Vdc | 220pF | ±20% | NFM21CC221R1H3# |
| | | 470pF | ±20% | NFM21CC471R1H3# |
| | | 1000pF | ±20% | NFM21CC102R1H3# |
| | | 2200pF | ±20% | NFM21CC222R1H3# |
| | | 22000pF | ±20% | NFM21CC223R1H3# |
| | 25Vdc | 0.10µF | ±20% | NFM21PC104R1E3# |
| | 16Vdc | 0.22µF | ±20% | NFM21PC224R1C3# |
| | | 0.47µF | ±20% | NFM21PC474R1C3# |
| | | 1.0µF | ±20% | NFM21PC105B1C3# |
| | 10Vdc | 1.0µF | ±20% | NFM21PC105B1A3# |
| | | 4.7µF | ±20% | NFM21PC475B1A3# |

| T max. | Rated Voltage | Cap. | Tol. | Part Number |
|--------|---------------|-------|------|-----------------|
| 0.95mm | 6.3Vdc | 2.2µF | ±20% | NFM21PC225B0J3# |
| | | 10µF | ±20% | NFM21PS106B0J3# |

3.2×1.25mm

| T max. | Rated Voltage | Cap. | Tol. | Part Number |
|--------|---------------|---------|----------|-----------------|
| 0.9mm | 50Vdc | 220pF | +50/-20% | NFM3DCC221R1H3# |
| | | 470pF | +50/-20% | NFM3DCC471R1H3# |
| | | 1000pF | +50/-20% | NFM3DCC102R1H3# |
| | | 2200pF | +50/-20% | NFM3DCC222R1H3# |
| | | 22000pF | +50/-20% | NFM3DCC223R1H3# |
| | | | ±20% | NFM3DPC223R1H3# |
| | | | | |

3.2×1.6mm

| T max. | Rated Voltage | Cap. | Tol. | Part Number | |
|--------|---------------|---------|------|-----------------|-----------|
| 1.5mm | 100Vdc | 10000pF | ±20% | NFM31KC103R2A3# | |
| | | 15000pF | ±20% | NFM31KC153R2A3# | |
| | | 22000pF | ±20% | NFM31KC223R2A3# | |
| | | 0.10µF | ±20% | NFM31KC104R2A3# | |
| | 50Vdc | 10000pF | ±20% | NFM31KC103R1H3# | |
| | | 15000pF | ±20% | NFM31KC153R1H3# | |
| | | 22000pF | ±20% | NFM31KC223R1H3# | |
| | | 0.10µF | ±20% | NFM31KC104R1H3# | |
| | 6.3Vdc | 27µF | ±20% | NFM31PC276B0J3# | D3 |

4.5×1.6mm

| T max. | Rated Voltage | Cap. | Tol. | Part Number | |
|--------|---------------|---------|----------|-----------------|-------|
| 1.2mm | 100Vdc | 470pF | +50/-20% | NFM41CC471R2A3# | |
| | | 1000pF | +50/-20% | NFM41CC102R2A3# | |
| | | 2200pF | +50/-20% | NFM41CC222R2A3# | |
| | | 22000pF | +50/-20% | NFM41CC223R2A3# | |
| | 50Vdc | 1.5µF | ±20% | NFM41PC155B1H3# | |
| | | | | | 25Vdc |

Part number # indicates the package specification code.

GRM
 GR3
 GRJ
 GR4
 GR7
 GJM
 GQM
 GA2
 GA3 GB
 GA3 GD
 GA3 GF
 LLL
 LLA
 LLM
 LLR
 NFM
 KRM
 KR3
 GMA
 GMD
 ⚠Caution / Notice

NFM Series Specifications and Test Methods

Specifications and Test Methods, please refer to the search web page.
<https://www.murata.com/en-global/products/capacitor>

NFM Series Low ESR EMI Filter Part Number List

1.0×0.5mm

| T max. | Rated Voltage | Cap. | Tol. | Part Number |
|--------|---------------|---------|------|-----------------|
| 0.35mm | 6.3Vdc | 0.47µF | ±20% | NFM15PC474RQJ3# |
| | 4Vdc | 0.47µF | ±20% | NFM15P74DOG3# |
| | | 1.0µF | ±20% | NFM15P74DOG3# |
| 0.5mm | 16Vdc | 2200pF | ±20% | NFM15C222D1A3# |
| | | 2200pF | ±20% | NFM15C222C1A3# |
| | | 47000pF | ±20% | NFM15PC473C1A3# |
| | 10Vdc | 2200pF | ±20% | NFM15C222D1A3# |
| | | 2200pF | ±20% | NFM15C222C1A3# |

Links are provided to the product detail pages on the web, and are shown below in the product number table from the PDF version of the catalog which is available on the web.

The screenshot shows the product page for NFM15C222D1A3#. It includes a 'Shape' section with a 3D model and dimensions: L=1.0mm, W=0.5mm, T=0.4mm. It also shows 'Specifications' and 'References' sections.

Detailed Specifications Sheet

- Rated value
- Specifications and Test Methods
- Package
- Caution, Notice

| SPECIFICATIONS AND TEST METHODS | | | | | | | | | | | |
|---------------------------------|-------------------------------|--|--|------------|-------------|--------------|---------------|-------------------------------|--|------------|--|
| Mechanical Performance | | | | | | | | | | | |
| No | Item | Specification | Test Method | | | | | | | | |
| 1 | Appearance and Dimensions | Appearance: No defects or abnormalities. Dimensions: Within the specified dimensions. | Appearance: Visual inspection. Dimensions: Using calipers. | | | | | | | | |
| 2 | Solderability | Electrodes shall be at least 90% covered with new solder coating. | Flux : Ethanol solution of rosin, 25(wt)% Pre-heat : 150±10°C, 60 to 90s Solder : Sn-3.0Ag-0.5Cu Solder Temperature : 240 ± 3°C Immersion Time : 3±1 s Immersion and emersion rates : 25mm / s | | | | | | | | |
| 3 | Resistance to soldering heat | Meet Table 1. Table 1 <table border="1"> <tr><td>Appearance</td><td>No damaged</td></tr> <tr><td>Cap. Change</td><td>Within ±7.5%</td></tr> <tr><td>I.R.</td><td>Meet the initial rated value.</td></tr> <tr><td>DC Resistance</td><td>0.05Ω max.</td></tr> </table> | Appearance | No damaged | Cap. Change | Within ±7.5% | I.R. | Meet the initial rated value. | DC Resistance | 0.05Ω max. | Flux : Ethanol solution of rosin, 25(wt)% Pre-heat : 150±10°C, 60 to 90s Solder : Sn-3.0Ag-0.5Cu Solder Temperature : 270 ± 5°C Immersion Time : 10 ± 1 s Immersion and emersion rates : 25mm / s Initial values : measured after heat treatment (150+0 / -10 °C, 1hour) and exposure in the room condition for 48±4 hours. Then measured after exposure in the room condition for 48±4 hours. |
| Appearance | No damaged | | | | | | | | | | |
| Cap. Change | Within ±7.5% | | | | | | | | | | |
| I.R. | Meet the initial rated value. | | | | | | | | | | |
| DC Resistance | 0.05Ω max. | | | | | | | | | | |
| 4 | Bending Strength | Meet Table 2. Table 2 <table border="1"> <tr><td>Appearance</td><td>No damaged</td></tr> <tr><td>Cap. Change</td><td>Within ±7.5%</td></tr> <tr><td>DC Resistance</td><td>0.05Ω max.</td></tr> </table> | Appearance | No damaged | Cap. Change | Within ±7.5% | DC Resistance | 0.05Ω max. | It shall be soldered on the glass-epoxy substrate (100 × 40 × 0.8mm). Deflection : 1.0 mm Keeping Time : 5 s | | |
| Appearance | No damaged | | | | | | | | | | |
| Cap. Change | Within ±7.5% | | | | | | | | | | |
| DC Resistance | 0.05Ω max. | | | | | | | | | | |
| 5 | Drop | Products shall be no failure after tested. | It shall be dropped on concrete or steel board. Height : 1m Method : Free fall Attitude from which the product is dropped : 3 directions The Number of Time : 3 times for each direction (Total 9 times) | | | | | | | | |

Metal Terminal Type Multilayer Ceramic Capacitors for General Purpose

KRM Series



Anti-noise

Deflecting crack

Soldering crack

WEB

Bonding the metal terminals to external electrodes solves design issues by mounting large size MLCC!

Features

① **Bond metal terminals to the external electrodes of chips.**

The stress applied to the chip is relieved by the elastic action of the metal terminal.



② **Substantially reduces noise, board deflection cracks and soldering cracks.**

This product is not damaged even with a board deflection of 6 mm.
 Solder cracks do not occur even with 2,000 cycles of heat stress.

● **Acoustic Noise is Reduced with Metal Terminals**

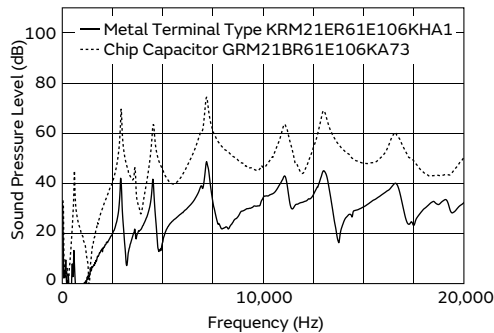

● **Reduces Stress Caused by Board Deflection**

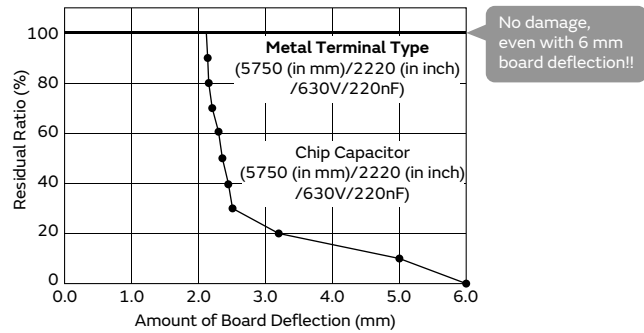

● **Suppresses Solder Cracks Caused by Heat Stress**

| Chip Size | Chip Only (5750 (in mm)/2220 (in inch) size) | Metal Terminal Type (5750 (in mm)/2220 (in inch) size) |
|------------|---|---|
| 1000 Cycle | ↑Solder Crack | |
| 2000 Cycle | ↑Solder Crack | |

Compared with chips only, this product is excellent in solder cracking resistance.

Test Condition: -55 to +125°C, 5min.,(Liquid Phase)
 Board Used: Glass Epoxy Board (FR-4)

Demonstrates replacement value of low noise capacitors Experience the effectiveness of the KRM Series.

Examples of Noise Countermeasures

WEB

GRM
 GR3
 GRJ
 GR4
 GR7
 GJM
 GQM
 GA2
 GA3 GB
 GA3 GD
 GA3 GF
 LLL
 LLA
 LLM
 LLR
 NFM
 KRM
 KR3
 GMA
 GMD
 ⚠Caution / Notice

- GRM
- GR3
- GRJ
- GR4
- GR7
- GJM
- GQM
- GA2
- GA3 GB
- GA3 GD
- GA3 GF
- LLL
- LLA
- LLM
- LLR
- NFM
- KRM
- KR3
- GMA
- GMD
- ⚠Caution /Notice

③ **2 chips can be stacked.**

Realize large capacity by stacking 2 capacitors.

Specifications

| | |
|-------------------|---|
| Size (mm) | 2.2×1.25mm to 6.1×5.3mm |
| Rated Voltage | 16Vdc to 1000Vdc |
| Capacitance | 68000pF to 100μF |
| Main Applications | For smoothing and noise suppression of DC-DC converters |

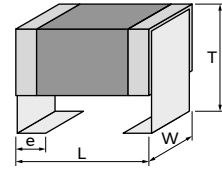

<Dimensions>

This catalog contains only a portion of the product lineup.
 Please refer to the capacitor search tool on the Murata Web site for details.

KRM Series High Dielectric Constant Type Anti-noise Deflecting crack Soldering crack Part Number List

2.2×1.25mm

| T max. | Rated Voltage | TC Code | Cap. | Tol. | Part Number |
|--------|---------------|---------|------|------|------------------------------|
| 1.9mm | 25Vdc | X5R | 10μF | ±10% | KRM21ER61E106KFA1# |
| | 16Vdc | X5R | 10μF | ±10% | KRM21ER61C106KFA1# |
| 2.0mm | 25Vdc | X7S | 10μF | ±10% | KRM21FC71E106KFA1# D1 |
| | | X6S | 10μF | ±10% | KRM21FC81E106KFA1# D1 |
| | | X5R | 22μF | ±20% | KRM21FR61E226MFA1# |

3.5×1.7mm

| T max. | Rated Voltage | TC Code | Cap. | Tol. | Part Number |
|--------|---------------|---------|-------|------|--------------------|
| 2.0mm | 25Vdc | X5R | 10μF | ±10% | KRM31FR61E106KH01# |
| 2.9mm | 100Vdc | X7R | 1.0μF | ±10% | KRM31KR72A105KH01# |
| | 50Vdc | X7R | 4.7μF | ±10% | KRM31KR71H475KH01# |
| | 35Vdc | X6S | 10μF | ±10% | KRM31KC8YA106KH01# |
| | 25Vdc | X6S | 10μF | ±10% | KRM31KC81E106KH01# |

3.6×1.7mm

| T max. | Rated Voltage | TC Code | Cap. | Tol. | Part Number |
|--------|---------------|---------|-------|------|--------------------|
| 2.9mm | 50Vdc | X7R | 2.2μF | ±10% | KRM31KR71H225KH01# |

3.7×1.85mm

| T max. | Rated Voltage | TC Code | Cap. | Tol. | Part Number |
|--------|---------------|---------|-------|------|--------------------|
| 2.9mm | 100Vdc | X7R | 2.2μF | ±10% | KRM31KR72A225KH01# |

6.1×5.3mm

| T max. | Rated Voltage | TC Code | Cap. | Tol. | Part Number |
|--------|---------------|---------|---------|--------------------|--------------------|
| 3.0mm | 1000Vdc | X7R | 68000pF | ±10% | KRM55LR73A683KH01# |
| | | | 0.10μF | ±10% | KRM55LR73A104KH01# |
| | 630Vdc | X7R | 0.15μF | ±10% | KRM55LR72J154KH01# |
| | | | 0.22μF | ±10% | KRM55LR72J224KH01# |
| | 450Vdc | X7R | 0.33μF | ±10% | KRM55LR72W334KH01# |
| | | | 0.47μF | ±10% | KRM55LR72W474KH01# |
| | 250Vdc | X7R | 0.68μF | ±10% | KRM55LR72E684KH01# |
| | | | 1.0μF | ±10% | KRM55LR72E105KH01# |
| | 100Vdc | X7R | 4.7μF | ±10% | KRM55LR72A475KH01# |
| | 63Vdc | X7R | 4.7μF | ±10% | KRM55LR71J475KH01# |
| | | | 10μF | ±10% | KRM55LR71H106KH01# |
| | 50Vdc | X7R | 4.7μF | ±10% | KRM55LR71H475KH01# |
| | | | 10μF | ±10% | KRM55LR71H106KH01# |
| | 35Vdc | X7R | 10μF | ±10% | KRM55LR7YA106KH01# |
| 15μF | | | ±10% | KRM55LR7YA156KH01# | |
| 25Vdc | X7R | 15μF | ±10% | KRM55LR71E156KH01# | |
| 3.9mm | 100Vdc | X7R | 6.8μF | ±10% | KRM55QR72A685KH01# |
| | | | 10μF | ±10% | KRM55QR72A106KH01# |
| | 63Vdc | X7R | 10μF | ±10% | KRM55QR71J106KH01# |
| | 50Vdc | X7R | 17μF | ±10% | KRM55QR71H176KH01# |
| | 35Vdc | X7R | 17μF | ±10% | KRM55QR7YA176KH01# |

| T max. | Rated Voltage | TC Code | Cap. | Tol. | Part Number | |
|--------|---------------|---------|--------|------|--------------------|--------------------|
| 3.9mm | 35Vdc | X7R | 22μF | ±10% | KRM55QR7YA226KH01# | |
| | | | 22μF | ±10% | KRM55QR71E226KH01# | |
| | 25Vdc | X7R | 33μF | ±10% | KRM55QR71E336KH01# | |
| | | | X7S | 47μF | ±10% | KRM55QC71E476KH13# |
| 5.0mm | 1000Vdc | X7R | 0.15μF | ±20% | KRM55TR73A154MH01# | |
| | | | 0.22μF | ±20% | KRM55TR73A224MH01# | |
| | 630Vdc | X7R | 0.33μF | ±20% | KRM55TR72J334MH01# | |
| | | | 0.47μF | ±20% | KRM55TR72J474MH01# | |
| | | | 450Vdc | X7R | 0.68μF | ±20% |
| | 1μF | ±20% | | | KRM55TR72W105MH01# | |
| | 250Vdc | X7R | 1.5μF | ±20% | KRM55TR72E155MH01# | |
| | | | 2.2μF | ±20% | KRM55TR72E225MH01# | |
| | 100Vdc | X7R | 10μF | ±20% | KRM55TR72A106MH01# | |
| | 50Vdc | X7R | 22μF | ±20% | KRM55TR71H226MH01# | |
| | 6.7mm | 100Vdc | X7R | 15μF | ±20% | KRM55WR72A156MH01# |
| | | | | 22μF | ±20% | KRM55WR72A226MH01# |
| | | 63Vdc | X7R | 22μF | ±20% | KRM55WR71J226MH01# |
| | | 50Vdc | X7R | 33μF | ±20% | KRM55WR71H336MH01# |
| 35Vdc | | X7R | 47μF | ±20% | KRM55WR7YA476MH01# | |
| | | | 25Vdc | X7R | 47μF | ±20% |
| | | 68μF | ±20% | | KRM55WR71E686MH01# | |
| | | X7S | 100μF | ±20% | KRM55WC71E107MH13# | |

Part number # indicates the package specification code.

GRM
 GR3
 GRJ
 GR4
 GR7
 GJM
 GQM
 GA2
 GA3 GB
 GA3 GD
 GA3 GF
 LLL
 LLA
 LLM
 LLR
 NFM
 KRM
 KR3
 GMA
 GMD
 ⚠Caution / Notice

KRM Series Specifications and Test Methods

Specifications and Test Methods, please refer to the search web page.
<https://www.murata.com/en-global/products/capacitor>

KRM Series High Dielectric Constant Type

2.2×1.25mm

| T max. | Rated Voltage | TC Code | Cap. | Tol. | Part Number |
|--------|---------------|---------|------|--------------------|--------------------|
| 1.9mm | 25Vdc | X5R | 10μF | ±10% | KRM215R61E106KFA1# |
| | 16Vdc | X5R | 10μF | ±10% | KRM215R61E106KFA1# |
| 2.0mm | 25Vdc | X7S | 10μF | ±10% | KRM215R61E106KFA1# |
| | X6S | 10μF | ±10% | KRM215R61E106KFA1# | |
| | X5R | 22μF | ±20% | KRM215R61E226MFA1# | |

3.5×1.7mm

Links are provided to the product detail pages on the web, and are shown below in the product number table from the PDF version of the catalog which is available on the web.

The screenshot shows the product page for KRM31FR61E106KH01#. It includes a 'Specifications' section with a table of parameters, a 'Shape' section with a 3D model and dimensions, and a 'References' section with a chart of characteristic data. A dashed box highlights the 'Specifications' section, which is linked to the 'Detailed Specifications Sheet'.

Detailed Specifications Sheet

- Rated value
- Specifications and Test Methods
- Package
- Caution, Notice

Reference only

| 4. Specifications and test methods | | | | | | | | | | | | | | | | | | | | |
|------------------------------------|---|---|---|--|--------------|---------------------|---------------------------|------------------|--|-----------|--|-------------------------|---------------------|-------------------------|-----------|----------|---------------------|-----------|----------|---------------------|
| No. | Item | Specifications | Test method | | | | | | | | | | | | | | | | | |
| 1 | Operating temperature range | Char. X5R : -55 to +85°C Char. X6S : -55 to +105°C Char. X7R : -55 to +125°C | | | | | | | | | | | | | | | | | | |
| 2 | Appearance | No defects or abnormalities. | Visual inspection. | | | | | | | | | | | | | | | | | |
| 3 | Dimensions | Within the specified dimension. | Using calipers and micrometers. | | | | | | | | | | | | | | | | | |
| 4 | Dielectric strength | No defects or abnormalities. | No failure should be observed when voltage in the table is applied between the terminations for 1 to 5 s, provided the charge/discharge current is less than 50mA. <table border="1"> <thead> <tr> <th>Rated Voltage</th> <th>Test Voltage</th> </tr> </thead> <tbody> <tr> <td>DC25V, DC35V, DC50V</td> <td>250% of the rated voltage</td> </tr> <tr> <td>DC100V</td> <td>200% of the rated voltage</td> </tr> </tbody> </table> | Rated Voltage | Test Voltage | DC25V, DC35V, DC50V | 250% of the rated voltage | DC100V | 200% of the rated voltage | | | | | | | | | | | |
| Rated Voltage | Test Voltage | | | | | | | | | | | | | | | | | | | |
| DC25V, DC35V, DC50V | 250% of the rated voltage | | | | | | | | | | | | | | | | | | | |
| DC100V | 200% of the rated voltage | | | | | | | | | | | | | | | | | | | |
| 5 | Insulation resistance (I.R.) | <table border="1"> <thead> <tr> <th>Rated Voltage</th> <th>I.R.</th> </tr> </thead> <tbody> <tr> <td>DC25V, DC35V</td> <td>50MΩ·μF or more</td> </tr> <tr> <td>DC50V, DC100V</td> <td>500MΩ·μF or more</td> </tr> </tbody> </table> | Rated Voltage | I.R. | DC25V, DC35V | 50MΩ·μF or more | DC50V, DC100V | 500MΩ·μF or more | The insulation resistance should be measured with rated voltage and within 60±5 s of charging. | | | | | | | | | | | |
| Rated Voltage | I.R. | | | | | | | | | | | | | | | | | | | |
| DC25V, DC35V | 50MΩ·μF or more | | | | | | | | | | | | | | | | | | | |
| DC50V, DC100V | 500MΩ·μF or more | | | | | | | | | | | | | | | | | | | |
| 6 | Capacitance | Within the specified tolerance. | The capacitance/D.F. should be measured at reference temperature at the meaning frequency and voltage shown in the table. | | | | | | | | | | | | | | | | | |
| 7 | Dissipation Factor (D.F.) | <table border="1"> <thead> <tr> <th>Rated Voltage</th> <th>D.F.</th> </tr> </thead> <tbody> <tr> <td>DC25V, DC35V</td> <td>0.15 max.</td> </tr> <tr> <td>DC50V</td> <td>0.025 max.</td> </tr> <tr> <td>DC100V</td> <td>0.05 max.</td> </tr> </tbody> </table> | Rated Voltage | D.F. | DC25V, DC35V | 0.15 max. | DC50V | 0.025 max. | DC100V | 0.05 max. | <table border="1"> <thead> <tr> <th>Nominal capacitance</th> <th>Measuring frequency</th> <th>Measuring voltage</th> </tr> </thead> <tbody> <tr> <td>C > 10 μF</td> <td>120±24Hz</td> <td>AC0.5±0.1V (r.m.s.)</td> </tr> <tr> <td>C ≤ 10 μF</td> <td>1±0.2kHz</td> <td>AC1.0±0.2V (r.m.s.)</td> </tr> </tbody> </table> | Nominal capacitance | Measuring frequency | Measuring voltage | C > 10 μF | 120±24Hz | AC0.5±0.1V (r.m.s.) | C ≤ 10 μF | 1±0.2kHz | AC1.0±0.2V (r.m.s.) |
| Rated Voltage | D.F. | | | | | | | | | | | | | | | | | | | |
| DC25V, DC35V | 0.15 max. | | | | | | | | | | | | | | | | | | | |
| DC50V | 0.025 max. | | | | | | | | | | | | | | | | | | | |
| DC100V | 0.05 max. | | | | | | | | | | | | | | | | | | | |
| Nominal capacitance | Measuring frequency | Measuring voltage | | | | | | | | | | | | | | | | | | |
| C > 10 μF | 120±24Hz | AC0.5±0.1V (r.m.s.) | | | | | | | | | | | | | | | | | | |
| C ≤ 10 μF | 1±0.2kHz | AC1.0±0.2V (r.m.s.) | | | | | | | | | | | | | | | | | | |
| 8 | Capacitance Temperature Characteristics | Char. X5R : within ±15% (Temp.Range:-55 to +85°C) Char. X6S : within ±22% (Temp.Range:-55 to +105°C) Char. X7R : within ±15% (Temp.Range:-55 to +125°C) | The capacitance measurement should be made at each step specified in the table. •Pretreatment Perform the heat treatment at 150+0/-10°C for 60±5 min and then let sit for 24±2 h at room condition*. <table border="1"> <thead> <tr> <th>Step</th> <th>1</th> <th>2</th> <th>3</th> <th>4</th> <th>5</th> </tr> </thead> <tbody> <tr> <td>Temp.(°C)</td> <td>25±2</td> <td>Min. Operating Temp. ±3</td> <td>25±2</td> <td>Max. Operating Temp. ±2</td> <td>25±2</td> </tr> </tbody> </table> | Step | 1 | 2 | 3 | 4 | 5 | Temp.(°C) | 25±2 | Min. Operating Temp. ±3 | 25±2 | Max. Operating Temp. ±2 | 25±2 | | | | | |
| Step | 1 | 2 | 3 | 4 | 5 | | | | | | | | | | | | | | | |
| Temp.(°C) | 25±2 | Min. Operating Temp. ±3 | 25±2 | Max. Operating Temp. ±2 | 25±2 | | | | | | | | | | | | | | | |
| 9 | Vibration resistance | Appearance Capacitance | No defects or abnormalities. Within the specified tolerance | Solder the capacitor to the Test Jig A (glass epoxy board) shown in "Complement of test" | | | | | | | | | | | | | | | | |

High Effective Capacitance & High Allowable Ripple Current Metal Terminal Type Multilayer Ceramic Capacitors for General Purpose

KR3 Series



Anti-noise

Deflecting crack

Soldering crack

WEB

Bonding the metal terminals to external electrodes solves design issues by mounting large size MLCC!

Features

1 Bond Metal Terminals to External Electrodes of Chips

This product has high resistance to heat and mechanical impact and greatly reduces acoustic noise of boards by ceramics.

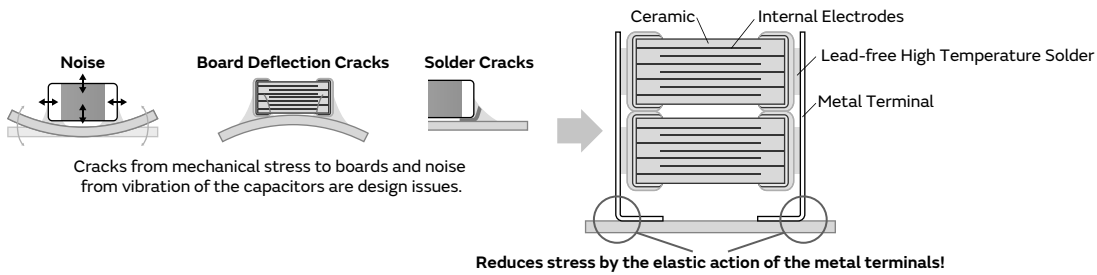

2 Stacking of Chips

Achieve high capacity by stacking 2 capacitors.

● Comparison of Noise Reduction Effects

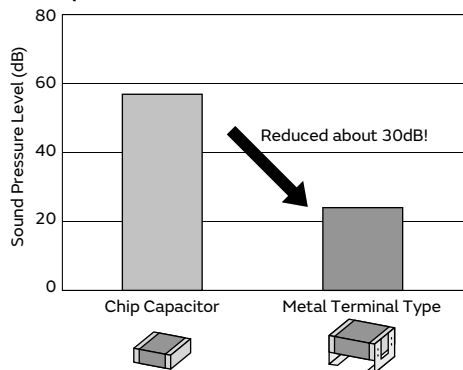

Evaluation Items: 5750 (in mm)/2220 (in inch) size/DC630V/220nF
 Test Method: DC50V, AC10Vp-p/3kHz
 Test Board: Glass Epoxy Board (T=1.6mm)
 Test Quantity: 3pc
 Distance Between Microphone and Board: 3mm

Note: Results Using Murata's Evaluation Board

● Reduces Stress Caused by Board Deflection

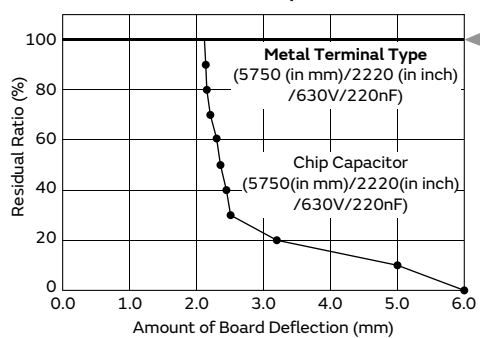

No damage, even with 6 mm board deflection!!

● Suppresses Solder Cracks Caused by Heat Stress

| Chip Size | Chip Only (5750 (in mm)/2220 (in inch) size) | Metal Terminal Type (5750 (in mm)/2220 (in inch) size) |
|------------|--|--|
| 1000 Cycle | ↑ Solder Crack | |
| 2000 Cycle | ↑ Solder Crack | |

Compared with chips only, this product is excellent in solder cracking resistance.

Test Condition: -55 to +125°C, 5min., (Liquid Phase)
 Board Used: Glass Epoxy Board (FR-4)

GRM
 GR3
 GRJ
 GR4
 GR7
 GJM
 GQM
 GA2
 GA3 GB
 GA3 GD
 GA3 GF
 LLL
 LLA
 LLM
 LLR
 NFM
 KRM
 KR3
 GMA
 GMD
 ⚠Caution /Notice

3 Adopted Low Dielectric Constant Materials

Improved effective capacity and ripple resistant performance, compared to conventional products (X7R characteristics).

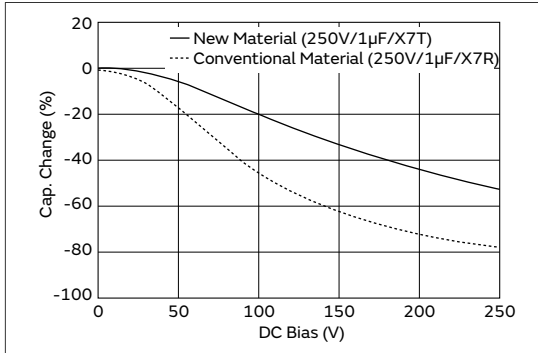

Specifications

| | |
|-------------------|--|
| Size (mm) | 6.1×5.3mm |
| Rated Voltage | 250Vdc to 630Vdc |
| Capacitance | 0.10µF to 2.2µF |
| Main Applications | For DC-DC converters of general electronic equipment |

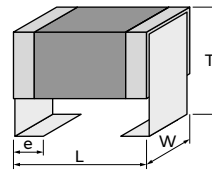

<Dimensions>

This catalog contains only a portion of the product lineup.
 Please refer to the capacitor search tool on the Murata Web site for details.

KR3 Series High Dielectric Constant Type Anti-noise Deflecting crack Soldering crack Part Number List

6.1×5.3mm

| T max. | Rated Voltage | TC Code | Cap. | Tol. | Part Number | p* |
|--------|---------------|---------|--------|---------------------------|---------------------------|------|
| 3.0mm | 630Vdc | X7T | 0.10μF | ±10% | KR355LD72J104KH01# | p246 |
| | | | 0.15μF | ±10% | KR355LD72J154KH01# | p246 |
| | 450Vdc | X7T | 0.22μF | ±10% | KR355LD72W224KH01# | p246 |
| | | | 0.33μF | ±10% | KR355LD72W334KH01# | p246 |
| | | | 0.47μF | ±10% | KR355LD72W474KH01# | p246 |
| | 250Vdc | X7T | 0.47μF | ±10% | KR355LD72E474KH01# | p246 |
| 0.68μF | | | ±10% | KR355LD72E684KH01# | p246 | |
| 3.9mm | 630Vdc | X7T | 0.22μF | ±10% | KR355QD72J224KH01# | p246 |
| | | | 0.27μF | ±10% | KR355QD72J274KH01# | p246 |
| | 450Vdc | X7T | 0.56μF | ±10% | KR355QD72W564KH01# | p246 |
| 5.0mm | 450Vdc | X7T | 0.68μF | ±20% | KR355TD72W684MH01# | p246 |
| | | | 1.0μF | ±20% | KR355TD72W105MH01# | p246 |
| | 250Vdc | X7T | 1.5μF | ±20% | KR355TD72E155MH01# | p246 |
| 6.7mm | 630Vdc | X7T | 0.47μF | ±20% | KR355WD72J474MH01# | p246 |
| | | | 0.56μF | ±20% | KR355WD72J564MH01# | p246 |
| | 450Vdc | X7T | 1.2μF | ±20% | KR355WD72W125MH01# | p246 |
| | 250Vdc | X7T | 2.2μF | ±20% | KR355WD72E225MH01# | p246 |

*: Refers to the page of the "Specifications and Test Methods".

Part number # indicates the package specification code.

1

KR3 Series Specifications and Test Methods (1)

| No | Item | Specification | Test Method (Ref. Standard: JIS C 5101, IEC60384) | | | | | | | | | | | | |
|---------------|---|---|---|---------------|------------------|--------|---------------------------|--------|---------------------------|--------|---------------------------|---|-------------------------|---|------|
| 1 | Operating Temperature | -55 to +125°C | | | | | | | | | | | | | |
| 2 | Appearance | No defects or abnormalities | Visual inspection. | | | | | | | | | | | | |
| 3 | Dimension | Within the specified dimension. | Using calipers and micrometers. | | | | | | | | | | | | |
| 4 | Dielectric Strength | No defects or abnormalities. | No failure should be observed when voltage in the table is applied between the terminations for 1 to 5s, provided the charge/discharge current is less than 50mA. <table border="1"> <thead> <tr> <th>Rated Voltage</th> <th>Test Voltage</th> </tr> </thead> <tbody> <tr> <td>DC250V</td> <td>200% of the rated voltage</td> </tr> <tr> <td>DC450V</td> <td>150% of the rated voltage</td> </tr> <tr> <td>DC630V</td> <td>120% of the rated voltage</td> </tr> </tbody> </table> | Rated Voltage | Test Voltage | DC250V | 200% of the rated voltage | DC450V | 150% of the rated voltage | DC630V | 120% of the rated voltage | | | | |
| Rated Voltage | Test Voltage | | | | | | | | | | | | | | |
| DC250V | 200% of the rated voltage | | | | | | | | | | | | | | |
| DC450V | 150% of the rated voltage | | | | | | | | | | | | | | |
| DC630V | 120% of the rated voltage | | | | | | | | | | | | | | |
| 5 | Insulation Resistance (I.R.) | More than 10000MΩ or 100MΩ • μF (Whichever is smaller) | The insulation resistance should be measured with DC500±50V (DC250±25V in case of rated voltage: DC250V, DC450V) and within 60±5s of charging. | | | | | | | | | | | | |
| 6 | Capacitance | Within the specified tolerance. | Capacitance should be measured at the frequency of 1±0.2kHz and a voltage of AC1.0±0.2V (r.m.s.). | | | | | | | | | | | | |
| 7 | Dissipation Factor (D.F.) | 0.01 max. | D.F. should be measured at the frequency of 1±0.2kHz and a voltage of AC1.0±0.2V (r.m.s.). | | | | | | | | | | | | |
| 8 | Capacitance Temperature Characteristics | Cap. change within +22/-33% (Temp.Range: -55 to +125°C) | The capacitance measurement should be made at each step specified in the table. • Pretreatment Perform the heat treatment at 150+0/-10°C for 60±5min and then let sit for 24±2h at room condition*. <table border="1"> <thead> <tr> <th>Step</th> <th>Temperature (°C)</th> </tr> </thead> <tbody> <tr> <td>1</td> <td>25±2</td> </tr> <tr> <td>2</td> <td>Min. Operating Temp. ±3</td> </tr> <tr> <td>3</td> <td>25±2</td> </tr> <tr> <td>4</td> <td>Max. Operating Temp. ±3</td> </tr> <tr> <td>5</td> <td>25±2</td> </tr> </tbody> </table> | Step | Temperature (°C) | 1 | 25±2 | 2 | Min. Operating Temp. ±3 | 3 | 25±2 | 4 | Max. Operating Temp. ±3 | 5 | 25±2 |
| Step | Temperature (°C) | | | | | | | | | | | | | | |
| 1 | 25±2 | | | | | | | | | | | | | | |
| 2 | Min. Operating Temp. ±3 | | | | | | | | | | | | | | |
| 3 | 25±2 | | | | | | | | | | | | | | |
| 4 | Max. Operating Temp. ±3 | | | | | | | | | | | | | | |
| 5 | 25±2 | | | | | | | | | | | | | | |
| 9 | Appearance | No defects or abnormalities. | Solder the capacitor to the Test Jig A (glass epoxy board) shown in "Complement of Test Method". The capacitor should be subjected to a simple harmonic motion having a total amplitude of 1.5mm, the frequency being varied uniformly between the approximate limits of 10 and 55Hz. The frequency range, from 10 to 55Hz and return to 10Hz, should be traversed in approximately 1min. This motion should be applied for a period of 2h in each of 3 mutually perpendicular directions (total of 6h). | | | | | | | | | | | | |
| | Capacitance | Within the specified tolerance. | | | | | | | | | | | | | |
| | D.F. | Pass the item No.7. | | | | | | | | | | | | | |
| 10 | Solderability of Termination | The metal surface is soldered well. | Reflow Soldering: Peak 260+0/-5°C The area of soldering 230°C min., 20 to 40s Let sit for 24±2h at room condition*, then measure. • Pretreatment Perform the heat treatment at 150+0/-10°C for 60±5min and then let sit for 24±2h at room condition*. | | | | | | | | | | | | |
| 11 | Appearance | No marking defects. | Reflow Soldering • See Item 10 Solderability of termination In a soldering iron case Temp. of solder: 350±10°C Solder time: 4+1/-0 s Let sit for 24±2h at room condition*, then measure. Please refer to "⚠Caution 4-3. Correction of Soldered Portion" | | | | | | | | | | | | |
| | Resistance to Soldering Heat | | | | | | | | | | | | | | |
| | Capacitance Change | Within ±10% | | | | | | | | | | | | | |
| | D.F. | Pass the item No.7. | | | | | | | | | | | | | |
| | I.R. | Pass the item No.5. | | | | | | | | | | | | | |
| | Dielectric Strength | Pass the item No.4. | | | | | | | | | | | | | |

* Room Condition: Temperature: 15 to 35°C, Relative humidity: 45 to 75%, Atmosphere pressure: 86 to 106kPa

Continued on the following page. ↗

GRM
 GR3
 GRJ
 GR4
 GR7
 GJM
 GQM
 GA2
 GA3 GB
 GA3 GD
 GA3 GF
 LLL
 LLA
 LLM
 LLR
 NFM
 KRM
 KR3
 GMA
 GMD
 ⚠Caution /Notice

KR3 Series Specifications and Test Methods (1)

Continued from the preceding page. ↘

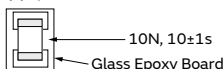
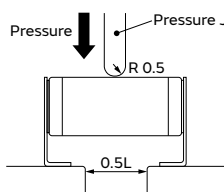
| No | Item | Specification | Test Method (Ref. Standard: JIS C 5101, IEC60384) | | | | | | | | | | | | | | | |
|---------------|----------------------------------|---|--|---------------|-----------------|------------|---------------------------|------------------------------|---------------------------|--------|---------------------------|--------|---|------------------------------|------------|---|------------|--------|
| 12 | Adhesive Strength of Termination | No removal of the terminations or other defects should occur. | Solder the capacitor to the Test Jig A (glass epoxy board) shown in "Complement of Test Method". Then apply 10N force in the direction of the arrow.  | | | | | | | | | | | | | | | |
| 13 | Deflection | No marking defects. | Solder the capacitor to the Test Jig B (glass epoxy board) shown in "Complement of Test Method". Then apply the force in the direction shown in "Test Method of Deflection" of "Complement of Test Method". • Flexure: 5mm • Hold time: 5s | | | | | | | | | | | | | | | |
| 14 | Strength of metal Terminal | Termination not to be broken or loosened. | A static load of 10N using a pressure jig should be applied to the center in the direction of the arrow and held for 10s  | | | | | | | | | | | | | | | |
| 15 | Temperature Cycle | Appearance Capacitance Change D.F. I.R. Dielectric Strength | No marking defects. Within $\pm 7.5\%$ Pass the item No.7. Pass the item No.5. Pass the item No.4. | | | | | | | | | | | | | | | |
| | | | Fix the capacitor to the supporting Test Jig A (glass epoxy board) shown in "Complement of Test Method". Perform the 100 cycles according to the 4 heat treatments listed the following table. <table border="1" data-bbox="933 952 1380 1086"> <thead> <tr> <th>Step</th> <th>Temp. (°C)</th> <th>Time (min)</th> </tr> </thead> <tbody> <tr> <td>1</td> <td>Min. Operating Temp. ± 3</td> <td>30\pm3</td> </tr> <tr> <td>2</td> <td>Room Temp.</td> <td>2 to 3</td> </tr> <tr> <td>3</td> <td>Max. Operating Temp. ± 2</td> <td>30\pm3</td> </tr> <tr> <td>4</td> <td>Room Temp.</td> <td>2 to 3</td> </tr> </tbody> </table> Let sit for 24 \pm 2h at room condition*, then measure. • Pretreatment Perform the heat treatment at 150+0/-10°C for 60 \pm 5min and then let sit for 24 \pm 2h at room condition*. | Step | Temp. (°C) | Time (min) | 1 | Min. Operating Temp. ± 3 | 30 \pm 3 | 2 | Room Temp. | 2 to 3 | 3 | Max. Operating Temp. ± 2 | 30 \pm 3 | 4 | Room Temp. | 2 to 3 |
| | Step | Temp. (°C) | Time (min) | | | | | | | | | | | | | | | |
| | 1 | Min. Operating Temp. ± 3 | 30 \pm 3 | | | | | | | | | | | | | | | |
| | 2 | Room Temp. | 2 to 3 | | | | | | | | | | | | | | | |
| 3 | Max. Operating Temp. ± 2 | 30 \pm 3 | | | | | | | | | | | | | | | | |
| 4 | Room Temp. | 2 to 3 | | | | | | | | | | | | | | | | |
| | | Appearance Capacitance Change D.F. I.R. Dielectric Strength | No marking defects. Within $\pm 12.5\%$ 0.02 max. More than 1000 M Ω or 10 M Ω \cdot μ F (Whichever is smaller) Pass the item No.4. | | | | | | | | | | | | | | | |
| | | Appearance Capacitance Change D.F. I.R. Dielectric Strength | Apply voltage as in the table for 1000+48/-0h at maximum operating temperature $\pm 3^\circ$ C. Remove and let sit for 24 \pm 2h at room condition*, then measure. • Pretreatment Perform the heat treatment at 150+0/-10°C for 60 \pm 5min and then let sit for 24 \pm 2h at room condition*. <table border="1" data-bbox="933 1534 1452 1646"> <thead> <tr> <th>Rated Voltage</th> <th>Applied Voltage</th> </tr> </thead> <tbody> <tr> <td>DC250V</td> <td>150% of the rated voltage</td> </tr> <tr> <td>DC450V</td> <td>130% of the rated voltage</td> </tr> <tr> <td>DC630V</td> <td>120% of the rated voltage</td> </tr> </tbody> </table> The charge/discharge current is less than 50mA. • Pretreatment Apply test voltage for 60 \pm 5min at test temperature. | Rated Voltage | Applied Voltage | DC250V | 150% of the rated voltage | DC450V | 130% of the rated voltage | DC630V | 120% of the rated voltage | | | | | | | |
| Rated Voltage | Applied Voltage | | | | | | | | | | | | | | | | | |
| DC250V | 150% of the rated voltage | | | | | | | | | | | | | | | | | |
| DC450V | 130% of the rated voltage | | | | | | | | | | | | | | | | | |
| DC630V | 120% of the rated voltage | | | | | | | | | | | | | | | | | |
| | | Appearance Capacitance Change D.F. I.R. Dielectric Strength | No marking defects. Within $\pm 12.5\%$ 0.02 max. More than 1000 M Ω or 10 M Ω \cdot μ F (Whichever is smaller) Pass the item No.4. | | | | | | | | | | | | | | | |

* Room Condition: Temperature: 15 to 35°C, Relative humidity: 45 to 75%, Atmosphere pressure: 86 to 106kPa

Continued on the following page. ↗

GRM
GR3
GRJ
GR4
GR7
GJM
GQM
GA2
GA3 GB
GA3 GD
GA3 GF
LLL
LLA
LLM
LLR
NFM
KPM
KR3
GMA
GMD
△Caution / Notice

KR3 Series Specifications and Test Methods (1)

Continued from the preceding page. ↘

Complement of Test Method

Test Jig

The test jig should be Jig A or Jig B as described in "Specifications and Test Methods".
 The specimen should be soldered by the conditions as described below.

Soldering Method: Reflow soldering
 Thickness of Metal-mask: 200μm
 Solder: Sn-3.0Ag-0.5Cu

(1) Test Jig A

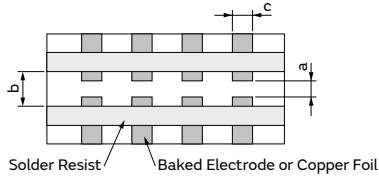

| Dimension (mm) | | |
|----------------|-----|-----|
| a | b | c |
| 4.5 | 8.0 | 5.6 |

- Material: Glass Epoxy Board
- Thickness: 1.6mm
- Thickness of copper foil: 0.035mm

(2) Test Jig B

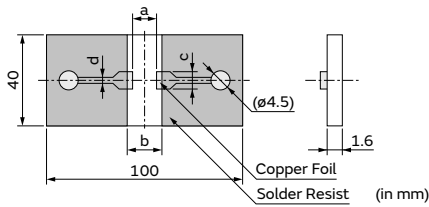

| Dimension (mm) | | | |
|----------------|-----|-----|-----|
| a | b | c | d |
| 4.5 | 8.0 | 5.6 | 1.0 |

- Material: Glass Epoxy Board
- Thickness of copper foil: 0.035mm

GRM
 GR3
 GRJ
 GR4
 GR7
 GJM
 GQM
 GA2
 GA3 GB
 GA3 GD
 GA3 GF
 LLL
 LLA
 LLM
 LLR
 NFM
 KRM
 KR3
 GMA
 GMD
 ⚠Caution /Notice

Wire Bonding Mount Multilayer Microchip Capacitors for General Purpose

GMA Series



These capacitors have gold-plated electrodes and are designed specifically for wire bonding.

Features

① Allows for high density mounting.

Noise can be reduced by eliminating the routing of the wire, and high efficiency can be achieved with a built-in capacitor in a package, such as IC. Miniaturization of the set is also possible.

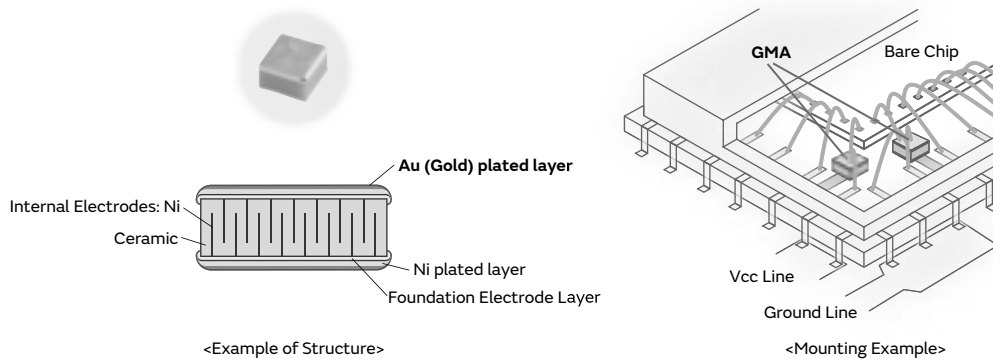

② Achieved small size and high capacitance with a multilayer structure.

| | |
|------------------------------|---|
| Small size, high capacitance | Minimum 0.38mm×0.38mm Achieved 0.1μF in 0.5mm×0.5mm size |
|------------------------------|---|

Lineup comparison table with competitor's is provided in my Murata Capacitor Site (need to sign in & approval from the site)



③ Ideal for bypass applications

Especially for optical communication related devices such as TOSA/ROSA.

④ Excellent in high frequency characteristics.

Since the capacitor consists of an upper/lower electrode structure, the current path becomes shorter and lowers the ESL. Compared with the general purpose GRM series of the same capacity, the impedance of this product becomes lower at high frequencies.

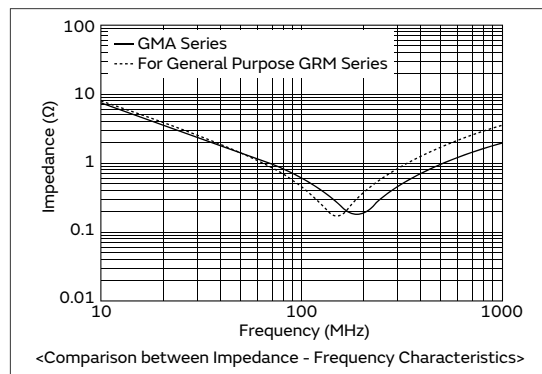

- GRM
- GR3
- GRJ
- GR4
- GR7
- GJM
- GQM
- GA2
- GA3 GB
- GA3 GD
- GA3 GF
- LLL
- LLA
- LLM
- LLR
- NFM
- KRM
- KR3
- GMA
- GMD
- ⚠Caution / Notice

- GRM
- GR3
- GRJ
- GR4
- GR7
- GJM
- GQM
- GA2
- GA3
GB
- GA3
GD
- GA3
GF
- LLL
- LLA
- LLM
- LLR
- NFM
- KRM
- KR3
- GMA
- GMD
- ⚠Caution
/Notice

Specifications

| | |
|-------------------|---|
| Size (mm) | 0.38×0.38mm to 0.8×0.8mm |
| Rated Voltage | 6.3Vdc to 100Vdc |
| Capacitance | 100pF to 0.47μF |
| Main Applications | <ol style="list-style-type: none"> 1. Optical communication related devices such as TOSA/ROSA. 2. Various device related, such as GaAsIC (mounted in IC packages) 3. Measuring instruments, other ultra compact/thin devices |

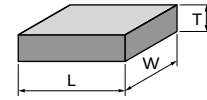

<Dimensions>

This catalog contains only a portion of the product lineup.
 Please refer to the capacitor search tool on the Murata Web site for details.

GMA Series High Dielectric Constant Type Part Number List

0.38×0.38mm

| T max. | Rated Voltage | TC Code | Cap. | Tol. | Part Number | p* | |
|--------|---------------|---------|---------|--------|--------------------|--------------------|------|
| 0.35mm | 10Vdc | X7R | 1000pF | ±20% | GMA0D3R71A102MA01# | p254 | |
| | | | 1500pF | ±20% | GMA0D3R71A152MA01# | p254 | |
| | | | 1800pF | ±20% | GMA0D3R71A182MA01# | p254 | |
| | | | 10000pF | ±20% | GMA0D3R71A103MA01# | p254 | |
| | | | R | 1000pF | ±20% | GMA0D3R11A102MA01# | p254 |
| | | | | 1500pF | ±20% | GMA0D3R11A152MA01# | p254 |
| | | 1800pF | | ±20% | GMA0D3R11A182MA01# | p254 | |
| | | 10000pF | | ±20% | GMA0D3R11A103MA01# | p254 | |
| | | B | 1000pF | ±20% | GMA0D3B11A102MA01# | p254 | |
| | | | 1500pF | ±20% | GMA0D3B11A152MA01# | p254 | |
| | | | 1800pF | ±20% | GMA0D3B11A182MA01# | p254 | |
| | | | 1800pF | ±20% | GMA0D3B11A182MA01# | p254 | |

0.5×0.5mm

| T max. | Rated Voltage | TC Code | Cap. | Tol. | Part Number | p* | |
|--------|---------------|---------|---------|---------|--------------------|--------------------|--------------------|
| 0.4mm | 100Vdc | X7R | 100pF | ±20% | GMA05XR72A101MA01# | p254 | |
| | | | 150pF | ±20% | GMA05XR72A151MA01# | p254 | |
| | | | 220pF | ±20% | GMA05XR72A221MA01# | p254 | |
| | | | 330pF | ±20% | GMA05XR72A331MA01# | p254 | |
| | | | 470pF | ±20% | GMA05XR72A471MA01# | p254 | |
| | | | 680pF | ±20% | GMA05XR72A681MA01# | p254 | |
| | | | 1000pF | ±20% | GMA05XR72A102MA01# | p254 | |
| | | | X7R | 1500pF | ±20% | GMA05XR71E152MA11# | p254 |
| | | 2200pF | | ±20% | GMA05XR71E222MA11# | p254 | |
| | | 3300pF | | ±20% | GMA05XR71E332MA11# | p254 | |
| | | 4700pF | | ±20% | GMA05XR71E472MA11# | p254 | |
| | | B | | 1500pF | ±20% | GMA05XB31E152MA11# | p254 |
| | | | | 2200pF | ±20% | GMA05XB31E222MA11# | p254 |
| | | | | 3300pF | ±20% | GMA05XB31E332MA11# | p254 |
| | | | | 4700pF | ±20% | GMA05XB31E472MA11# | p254 |
| | | 10Vdc | X7R | 6800pF | ±20% | GMA05XR71A682MA01# | p254 |
| | 10000pF | | | ±20% | GMA05XR71A103MA01# | p254 | |
| | 15000pF | | | ±20% | GMA05XR71A153MA01# | p254 | |
| | 22000pF | | | ±20% | GMA05XR71A223MA01# | p254 | |
| | R | | | 6800pF | ±20% | GMA05XR11A682MA01# | p254 |
| | | | | 10000pF | ±20% | GMA05XR11A103MA01# | p254 |
| | | | | 15000pF | ±20% | GMA05XR11A153MA01# | p254 |
| | | | | 22000pF | ±20% | GMA05XR11A223MA01# | p254 |
| | B | | 6800pF | ±20% | GMA05XB11A682MA01# | p254 | |
| | | | 10000pF | ±20% | GMA05XB11A103MA01# | p254 | |
| | | | 15000pF | ±20% | GMA05XB11A153MA01# | p254 | |
| | | | 22000pF | ±20% | GMA05XB11A223MA01# | p254 | |
| | 6.3Vdc | | X5R | 0.10μF | ±20% | GMA05XR60J104ME12# | p252 |
| | | | | B | 0.10μF | ±20% | GMA05XB30J104ME12# |

0.8×0.8mm

| T max. | Rated Voltage | TC Code | Cap. | Tol. | Part Number | p* |
|--------|---------------|---------|--------|------|--------------------|------|
| 0.6mm | 100Vdc | X7R | 1500pF | ±20% | GMA085R72A152MA01# | p254 |
| | | | 2200pF | ±20% | GMA085R72A222MA01# | p254 |

| T max. | Rated Voltage | TC Code | Cap. | Tol. | Part Number | p* | |
|--------|---------------|---------|---------|--------------------|--------------------|--------------------|------|
| 0.6mm | 100Vdc | X7R | 3300pF | ±20% | GMA085R72A332MA01# | p254 | |
| | | | 4700pF | ±20% | GMA085R72A472MA01# | p254 | |
| | | | 6800pF | ±20% | GMA085R72A682MA01# | p254 | |
| | | X7R | 10000pF | ±20% | GMA085R71E103MA11# | p254 | |
| | | | 15000pF | ±20% | GMA085R71E153MA11# | p254 | |
| | | | 22000pF | ±20% | GMA085R71E223MA11# | p254 | |
| | B | 10000pF | ±20% | GMA085B31E103MA11# | p254 | | |
| | | 15000pF | ±20% | GMA085B31E153MA11# | p254 | | |
| | | 22000pF | ±20% | GMA085B31E223MA11# | p254 | | |
| | | 10Vdc | X7R | 33000pF | ±20% | GMA085R71A333MA01# | p254 |
| | | | | 47000pF | ±20% | GMA085R71A473MA01# | p254 |
| | | | | 68000pF | ±20% | GMA085R71A683MA01# | p254 |
| | R | | 0.10μF | ±20% | GMA085R71A104MA01# | p254 | |
| | | | 33000pF | ±20% | GMA085R11A333MA01# | p254 | |
| | | | 47000pF | ±20% | GMA085R11A473MA01# | p254 | |
| | B | 68000pF | ±20% | GMA085R11A683MA01# | p254 | | |
| | | 0.10μF | ±20% | GMA085R11A104MA01# | p254 | | |
| | | 33000pF | ±20% | GMA085B11A333MA01# | p254 | | |
| | | 47000pF | ±20% | GMA085B11A473MA01# | p254 | | |
| | | 68000pF | ±20% | GMA085B11A683MA01# | p254 | | |
| | | 0.10μF | ±20% | GMA085B11A104MA01# | p254 | | |
| | 6.3Vdc | X5R | 0.47μF | ±20% | GMA085R60J474ME12# | p252 | |
| | | | B | 0.47μF | ±20% | GMA085B30J474ME12# | p252 |

*: Refers to the page of the "Specifications and Test Methods".

Part number # indicates the package specification code.

1

GMA Series Specifications and Test Methods (1)

| No | Item | Specification | Test Method (Ref. Standard: JIS C 5101, IEC60384) | | | | | | | | | | | | | | |
|-------------------------|--|--|--|-------------|------------------|------------------------|-------------------------|--------------------|-------------|---|-------------------------|---|--------------------|---|-------------------------|---|--------------------|
| 1 | Rated Voltage | Shown in Rated value. | The rated voltage is defined as the maximum voltage which may be applied continuously to the capacitor. When AC voltage is superimposed on DC voltage, V^P -P or V^O -P, whichever is larger, should be maintained within the rated voltage range. | | | | | | | | | | | | | | |
| 2 | Appearance | No defects or abnormalities. | Visual inspection. | | | | | | | | | | | | | | |
| 3 | Dimension | Within the specified dimensions. | Using Measuring instrument of dimension. | | | | | | | | | | | | | | |
| 4 | Voltage Proof | No defects or abnormalities. | Measurement Point: Between the terminations Test Voltage: 250% of the rated voltage Applied Time: 1 to 5s Charge/discharge current: 50mA max. | | | | | | | | | | | | | | |
| 5 | Insulation Resistance (I.R.) | More than 2000MΩ or 50Ω · F (Whichever is smaller) | Measurement Point: Between the terminations Measurement Voltage: DC Rated Voltage Charging Time: 1min Charge/discharge current: 50mA max. Measurement Temperature: Room Temperature | | | | | | | | | | | | | | |
| 6 | Capacitance | Shown in Rated value. | Measurement Temperature: Room Temperature | | | | | | | | | | | | | | |
| 7 | Dissipation Factor (D.F.) | 0.1 max. | <table border="1"> <thead> <tr> <th>Capacitance</th> <th>Frequency</th> <th>Voltage</th> </tr> </thead> <tbody> <tr> <td>C ≤ 10μF (6.3V max.)</td> <td>1.0±0.1kHz</td> <td>0.5±0.1Vrms</td> </tr> </tbody> </table> | Capacitance | Frequency | Voltage | C ≤ 10μF (6.3V max.) | 1.0±0.1kHz | 0.5±0.1Vrms | | | | | | | | |
| Capacitance | Frequency | Voltage | | | | | | | | | | | | | | | |
| C ≤ 10μF (6.3V max.) | 1.0±0.1kHz | 0.5±0.1Vrms | | | | | | | | | | | | | | | |
| 8 | Temperature Characteristics of Capacitance | No Bias B3: Within ±10% (-25 to +85°C) R6: Within ±15% (-55 to +85°C) C8: Within ±22% (-55 to +105°C) | <p>The capacitance change should be measured after 5 minutes at each specified temp. stage. Capacitance value as a reference is the value in step 3.</p> <table border="1"> <thead> <tr> <th>Step</th> <th>Temperature (°C)</th> <th>Applying Voltage (VDC)</th> </tr> </thead> <tbody> <tr> <td>1</td> <td>Reference Temp. ±2</td> <td rowspan="5">No bias</td> </tr> <tr> <td>2</td> <td>Min. Operating Temp. ±3</td> </tr> <tr> <td>3</td> <td>Reference Temp. ±2</td> </tr> <tr> <td>4</td> <td>Max. Operating Temp. ±3</td> </tr> <tr> <td>5</td> <td>Reference Temp. ±2</td> </tr> </tbody> </table> <p>• Initial measurement Perform a heat treatment at 150+0/-10°C for 1h and then let sit for 24±2h at room temperature, then measure.</p> | Step | Temperature (°C) | Applying Voltage (VDC) | 1 | Reference Temp. ±2 | No bias | 2 | Min. Operating Temp. ±3 | 3 | Reference Temp. ±2 | 4 | Max. Operating Temp. ±3 | 5 | Reference Temp. ±2 |
| Step | Temperature (°C) | Applying Voltage (VDC) | | | | | | | | | | | | | | | |
| 1 | Reference Temp. ±2 | No bias | | | | | | | | | | | | | | | |
| 2 | Min. Operating Temp. ±3 | | | | | | | | | | | | | | | | |
| 3 | Reference Temp. ±2 | | | | | | | | | | | | | | | | |
| 4 | Max. Operating Temp. ±3 | | | | | | | | | | | | | | | | |
| 5 | Reference Temp. ±2 | | | | | | | | | | | | | | | | |
| 9 | Adhesive Strength of Termination | Bond Strength | Pull force: 0.03N min. | | | | | | | | | | | | | | |
| | | Die Shear Strength | Die Shear force: 2N min. | | | | | | | | | | | | | | |
| 10 | Vibration * | Appearance | No defects or abnormalities. | | | | | | | | | | | | | | |
| | | Capacitance | Within the specified initial value. | | | | | | | | | | | | | | |
| | | D.F. | Within the specified initial value. | | | | | | | | | | | | | | |
| 11 | Temperature Sudden Change * | Appearance | No defects or abnormalities. | | | | | | | | | | | | | | |
| | | Capacitance Change | Within ±7.5% | | | | | | | | | | | | | | |
| | | D.F. | Within the specified initial value. | | | | | | | | | | | | | | |
| | | I.R. | Within the specified initial value. | | | | | | | | | | | | | | |
| | | Voltage Proof | No defects. | | | | | | | | | | | | | | |

Continued on the following page. ↗

GRM
GR3
GRJ
GR4
GR7
GJM
GQM
GA2
GA3
GB
GA3
GD
GA3
GF
LLL
LLA
LLM
LLR
NFM
KRM
KR3
GMA
GMD
⚠️Caution / Notice

GMA Series Specifications and Test Methods (1)

Continued from the preceding page. ↘

| No | Item | Specification | Test Method (Ref. Standard: JIS C 5101, IEC60384) | |
|----|---|---|--|--|
| 12 | High Temperature High Humidity (Steady) * | Appearance | No defects or abnormalities. | |
| | Capacitance Change | Within $\pm 12.5\%$ | Test Temperature: $40\pm 2^\circ\text{C}$ Test Humidity: 90 to 95%RH Test Time: $500\pm 12\text{h}$ Applied Voltage: DC Rated Voltage Charge/discharge current: 50mA max. | |
| | D.F. | 0.2 max. | • Initial measurement | |
| | I.R. | More than $500\text{M}\Omega$ or $12.5\Omega \cdot \text{F}$ (Whichever is smaller) | Perform a heat treatment at $150+0/-10^\circ\text{C}$ for 1h and then let sit for $24\pm 2\text{h}$ at room temperature, then measure. • Measurement after test Perform a heat treatment at $150+0/-10^\circ\text{C}$ for 1h and then let sit for $24\pm 2\text{h}$ at room temperature, then measure. | |
| 13 | Durability * | Appearance | No defects or abnormalities. | |
| | | Capacitance Change | Within $\pm 12.5\%$ | Test Temperature: Max. Operating Temp. $\pm 3^\circ\text{C}$ Test Time: $1000\pm 12\text{h}$ Applied Voltage: 150% of the rated voltage Charge/discharge current: 50mA max. |
| | | D.F. | 0.2 max. | • Initial measurement |
| | | I.R. | More than $1000\text{M}\Omega$ or $25\Omega \cdot \text{F}$ (Whichever is smaller) | Perform a heat treatment at $150+0/-10^\circ\text{C}$ for 1h and then let sit for $24\pm 2\text{h}$ at room temperature, then measure. • Measurement after test Perform a heat treatment at $150+0/-10^\circ\text{C}$ for 1h and then let sit for $24\pm 2\text{h}$ at room temperature, then measure. |

* Mounting for testing: The capacitors should be mounted on the substrate as shown below using die bonding and wire bonding when tests No.10 to 13 are performed.

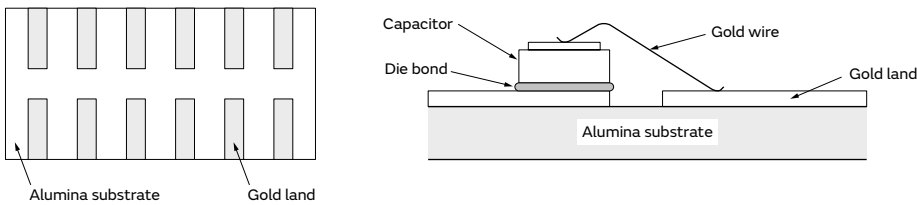

GRM
 GR3
 GRJ
 GR4
 GR7
 GJM
 GQM
 GA2
 GA3 GB
 GA3 GD
 GA3 GF
 LLL
 LLA
 LLM
 LLR
 NFM
 KPM
 KR3
 GMA
 GMD
 ⚠Caution / Notice

2

GMA Series Specifications and Test Methods (2)

| No | Item | Specification | Test Method (Ref. Standard: JIS C 5101, IEC60384) | | | | | | | | | | | | | | | | | | | | | |
|------|--|--|--|------|------------------|------------------------|---|----------------------------|------------|---|-----------------------------|--------|-------------------------|----------------------------|-----------------------------|---|-------------------------|---------------------------------------|---|-----------------------------|---|-------------------------|---|-----------------------------|
| 1 | Rated Voltage | Shown in Rated value. | The rated voltage is defined as the maximum voltage which may be applied continuously to the capacitor. When AC voltage is superimposed on DC voltage, V^P -P or V^O -P, whichever is larger, should be maintained within the rated voltage range. | | | | | | | | | | | | | | | | | | | | | |
| 2 | Appearance | No defects or abnormalities. | Visual inspection. | | | | | | | | | | | | | | | | | | | | | |
| 3 | Dimension | Within the specified dimensions. | Using Measuring instrument of dimension. | | | | | | | | | | | | | | | | | | | | | |
| 4 | Voltage Proof | No defects or abnormalities. | Measurement Point: Between the terminations Test Voltage: 250% of the rated voltage Applied Time: 1 to 5s Charge/discharge current: 50mA max. | | | | | | | | | | | | | | | | | | | | | |
| 5 | Insulation Resistance (I.R.) | $C \leq 0.047\mu\text{F}$: More than 10000MΩ $C > 0.047\mu\text{F}$: More than $500\Omega \cdot \text{F}$ C: Nominal Capacitance | Measurement Point: Between the terminations Measurement Voltage: DC Rated Voltage Charging Time: 2min Charge/discharge current: 50mA max. Measurement Temperature: Room Temperature | | | | | | | | | | | | | | | | | | | | | |
| 6 | Capacitance | Shown in Rated value. | Measurement Temperature: Room Temperature Measurement Frequency: $1.0 \pm 0.1\text{kHz}$ Measurement Voltage: $1.0 \pm 0.2\text{Vrms}$ | | | | | | | | | | | | | | | | | | | | | |
| 7 | Dissipation Factor (D.F.) | W.V.: 25Vdc min.: 0.025max. W.V.: 16/10Vdc: 0.035max. W.V.: 6.3Vdc: 0.05max. | | | | | | | | | | | | | | | | | | | | | | |
| 8 | Temperature Characteristics of Capacitance | No Bias | The capacitance change should be measured after 5 minutes at each specified temp. stage. In case of applying voltage, the capacitance change should be measured after 1min with applying voltage in equilibration of each temp. stage. Capacitance value as a reference is the value in step 3. | | | | | | | | | | | | | | | | | | | | | |
| | | 50% of the Rated Voltage | | | | | | | | | | | | | | | | | | | | | | |
| | | B1, B3: Within $\pm 10\%$ (-25 to +85°C) R1, R7: Within $\pm 15\%$ (-55 to +125°C) | <table border="1"> <thead> <tr> <th>Step</th> <th>Temperature (°C)</th> <th>Applying Voltage (VDC)</th> </tr> </thead> <tbody> <tr> <td>1</td> <td>Reference Temp. ± 2</td> <td rowspan="4">No bias</td> </tr> <tr> <td>2</td> <td>Min.Operating Temp. ± 3</td> </tr> <tr> <td>3</td> <td>Reference Temp. ± 2</td> </tr> <tr> <td>4</td> <td>Max.Operating Temp. ± 3</td> </tr> <tr> <td>5</td> <td>Reference Temp. ± 2</td> <td rowspan="4">50% of the rated voltage (For B1, R1)</td> </tr> <tr> <td>6</td> <td>Min.Operating Temp. ± 3</td> </tr> <tr> <td>7</td> <td>Reference Temp. ± 2</td> </tr> <tr> <td>8</td> <td>Max.Operating Temp. ± 3</td> </tr> </tbody> </table> | Step | Temperature (°C) | Applying Voltage (VDC) | 1 | Reference Temp. ± 2 | No bias | 2 | Min.Operating Temp. ± 3 | 3 | Reference Temp. ± 2 | 4 | Max.Operating Temp. ± 3 | 5 | Reference Temp. ± 2 | 50% of the rated voltage (For B1, R1) | 6 | Min.Operating Temp. ± 3 | 7 | Reference Temp. ± 2 | 8 | Max.Operating Temp. ± 3 |
| Step | Temperature (°C) | Applying Voltage (VDC) | | | | | | | | | | | | | | | | | | | | | | |
| 1 | Reference Temp. ± 2 | No bias | | | | | | | | | | | | | | | | | | | | | | |
| 2 | Min.Operating Temp. ± 3 | | | | | | | | | | | | | | | | | | | | | | | |
| 3 | Reference Temp. ± 2 | | | | | | | | | | | | | | | | | | | | | | | |
| 4 | Max.Operating Temp. ± 3 | | | | | | | | | | | | | | | | | | | | | | | |
| 5 | Reference Temp. ± 2 | 50% of the rated voltage (For B1, R1) | | | | | | | | | | | | | | | | | | | | | | |
| 6 | Min.Operating Temp. ± 3 | | | | | | | | | | | | | | | | | | | | | | | |
| 7 | Reference Temp. ± 2 | | | | | | | | | | | | | | | | | | | | | | | |
| 8 | Max.Operating Temp. ± 3 | | | | | | | | | | | | | | | | | | | | | | | |
| | | B1: Within +10/-30% R1: Within +15/-40% | <ul style="list-style-type: none"> Initial measurement Perform a heat treatment at $150 \pm 0/-10^\circ\text{C}$ for 1h and then let sit for $24 \pm 2\text{h}$ at room temperature, then measure. | | | | | | | | | | | | | | | | | | | | | |
| 9 | Adhesive Strength of Termination | Bond Strength | Pull force: 0.03N min. | | | | | | | | | | | | | | | | | | | | | |
| | | Die Shear Strength | Die Shear force: 2N min. | | | | | | | | | | | | | | | | | | | | | |
| 10 | Vibration * | Appearance | No defects or abnormalities. | | | | | | | | | | | | | | | | | | | | | |
| | | Capacitance | Within the specified initial value. | | | | | | | | | | | | | | | | | | | | | |
| | | D.F. | Within the specified initial value. | | | | | | | | | | | | | | | | | | | | | |
| | | | Kind of Vibration: A simple harmonic motion 10Hz to 55Hz to 10Hz (1min) Total amplitude: 1.5mm This motion should be applied for a period of 2h in each 3 mutually perpendicular directions (total of 6h). | | | | | | | | | | | | | | | | | | | | | |
| 11 | Temperature Sudden Change * | Appearance | No defects or abnormalities. | | | | | | | | | | | | | | | | | | | | | |
| | | Capacitance Change | Within $\pm 7.5\%$ | | | | | | | | | | | | | | | | | | | | | |
| | | D.F. | Within the specified initial value. | | | | | | | | | | | | | | | | | | | | | |
| | | I.R. | Within the specified initial value. | | | | | | | | | | | | | | | | | | | | | |
| | | Voltage Proof | No defects. | | | | | | | | | | | | | | | | | | | | | |
| | | | Perform the five cycles according to the four heat treatments shown in the following table. <table border="1"> <thead> <tr> <th>Step</th> <th>Temp. (°C)</th> <th>Time (min)</th> </tr> </thead> <tbody> <tr> <td>1</td> <td>Min. Operating Temp. +0/-3</td> <td>30\pm3</td> </tr> <tr> <td>2</td> <td>Room Temp.</td> <td>2 to 3</td> </tr> <tr> <td>3</td> <td>Max. Operating Temp. +3/-0</td> <td>30\pm3</td> </tr> <tr> <td>4</td> <td>Room Temp.</td> <td>2 to 3</td> </tr> </tbody> </table> Exposure Time: $24 \pm 2\text{h}$ <ul style="list-style-type: none"> Initial measurement Perform a heat treatment at $150 \pm 0/-10^\circ\text{C}$ for 1h and then let sit for $24 \pm 2\text{h}$ at room temperature, then measure. | Step | Temp. (°C) | Time (min) | 1 | Min. Operating Temp. +0/-3 | 30 \pm 3 | 2 | Room Temp. | 2 to 3 | 3 | Max. Operating Temp. +3/-0 | 30 \pm 3 | 4 | Room Temp. | 2 to 3 | | | | | | |
| Step | Temp. (°C) | Time (min) | | | | | | | | | | | | | | | | | | | | | | |
| 1 | Min. Operating Temp. +0/-3 | 30 \pm 3 | | | | | | | | | | | | | | | | | | | | | | |
| 2 | Room Temp. | 2 to 3 | | | | | | | | | | | | | | | | | | | | | | |
| 3 | Max. Operating Temp. +3/-0 | 30 \pm 3 | | | | | | | | | | | | | | | | | | | | | | |
| 4 | Room Temp. | 2 to 3 | | | | | | | | | | | | | | | | | | | | | | |

Continued on the following page. ↗

⚠Caution /Notice

GRM
GR3
GRJ
GR4
GR7
GJM
GQM
GA2
GA3 GB
GA3 GD
GA3 GF
LLL
LLA
LLM
LLR
NFM
KRM
KR3
GMA
GMD

GMA Series Specifications and Test Methods (2)

Continued from the preceding page. ↘

| No | Item | Specification | Test Method (Ref. Standard: JIS C 5101, IEC60384) | |
|----|---|---|--|---|
| 12 | High Temperature High Humidity (Steady) * | Appearance | Test Temperature: 40±2°C Test Humidity: 90 to 95%RH Test Time: 500±12h Applied Voltage: DC Rated Voltage Charge/discharge current: 50mA max. Exposure Time: 24±2h | |
| | Capacitance Change | Within ±12.5% | | |
| | D.F. | W.V.: 25Vdc min.: 0.05max. W.V.: 16/10Vdc: 0.05max. W.V.: 6.3Vdc: 0.075max. | | |
| | I.R. | More than 500MΩ or 25Ω • F (Whichever is smaller) | | |
| 13 | Durability * | Appearance | Test Temperature: Max. Operating Temp. ±3°C Test Time: 1000±12h Applied Voltage: 200% of the rated voltage Charge/discharge current: 50mA max. Exposure Time: 24±2h • Initial measurement Apply 200% of the rated DC voltage at the max. operating temp. ±3°C for 1h. Remove and set for 24±2h at room temperature. Perform initial measurement. | |
| | | Capacitance Change | | Within ±12.5% |
| | | D.F. | | W.V.: 25Vdc min.: 0.05max. W.V.: 16/10Vdc: 0.05max. W.V.: 6.3Vdc: 0.075max. |
| | | I.R. | | More than 1000MΩ or 50Ω • F (Whichever is smaller) |

* Mounting for testing: The capacitors should be mounted on the substrate as shown below using die bonding and wire bonding when tests No.10 to 13 are performed.

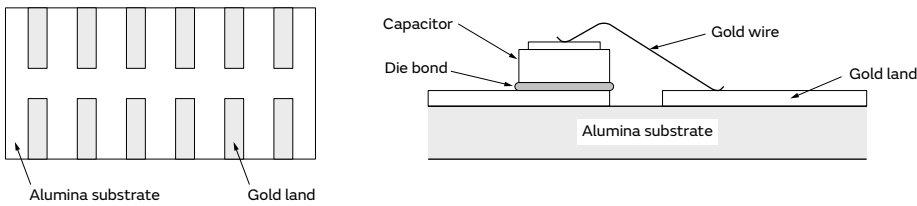

GRM
 GR3
 GRJ
 GR4
 GR7
 GJM
 GQM
 GA2
 GA3 GB
 GA3 GD
 GA3 GF
 LLL
 LLA
 LLM
 LLR
 NFM
 KPM
 KR3
 GMA
 GMD
 ⚠Caution / Notice

Wire Bonding/AuSn Soldering Mount Chip Multilayer Ceramic Capacitors for General Purpose

GMD Series   

These capacitors have gold-plated electrodes and are designed specifically for wire bonding and use of gold-tin (AuSn) solder.

Features

① Designed specifically for wire bonding and use of gold-tin (AuSn) solder.

The gold-plated external electrodes make these devices suitable for wire bonding or use of gold tin (AuSn) solder.

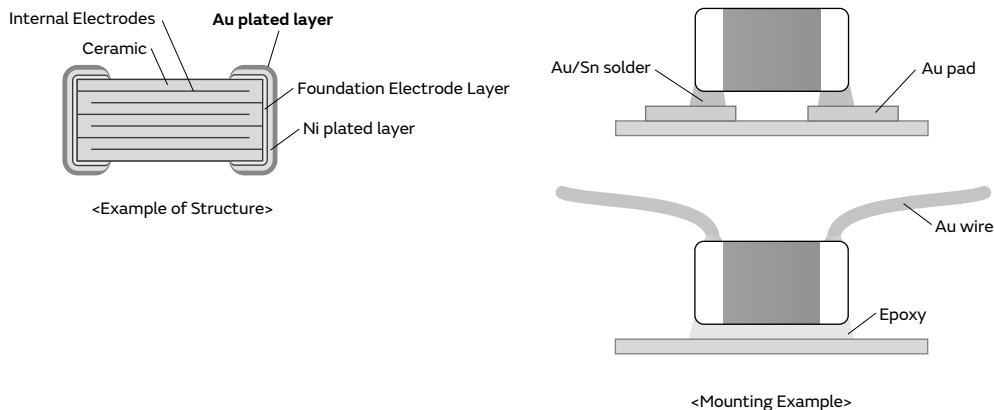

*This product is suitable only for wire bonding or use of gold-tin (AuSn) solder. Other mounting methods should not be used.

② Ideal for mounting in packages, such as optical communication related devices, IC and etc.

Noise can be reduced by eliminating the routing of the wire, and high efficiency can be achieved with a built-in capacitor in the package, such as TO-CAN, IC and etc. by wire bonding mounting.

③ Contributes to the miniaturization of the set.

Murata offers a lineup of small size products, such as the 0603 (0201) and 1005 (0402) in mm (inch).

Specifications

| | |
|-------------------|---|
| Size (mm) | 0.6×0.3mm to 1.0×0.5mm |
| Rated Voltage | 6.3Vdc to 50Vdc |
| Capacitance | 100pF to 1.0μF |
| Main Applications | Various device related, such as GaAsIC (mounted in IC packages) |

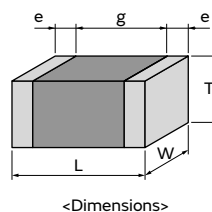

This catalog contains only a portion of the product lineup. Please refer to the capacitor search tool on the Murata Web site for details.

GRM
 GR3
 GRJ
 GR4
 GR7
 GJM
 GQM
 GA2
 GA3 GB
 GA3 GD
 GA3 GF
 LLL
 LLA
 LLM
 LLR
 NFM
 KRM
 KR3
 GMA
GMD
 ⚠Caution /Notice

GMD Series High Dielectric Constant Type Part Number List

0.6×0.3mm

| T max. | Rated Voltage | TC Code | Cap. | Tol. | Part Number | p* | | | |
|--------|---------------|---------|--------|-------|--------------------|--------------------|--------------------|--------------------|------|
| 0.33mm | 25Vdc | X7R | 100pF | ±10% | GMD033R71E101KA01# | p259 | | | |
| | | | 120pF | ±10% | GMD033R71E121KA01# | p259 | | | |
| | | | 150pF | ±10% | GMD033R71E151KA01# | p259 | | | |
| | | | 180pF | ±10% | GMD033R71E181KA01# | p259 | | | |
| | | | 220pF | ±10% | GMD033R71E221KA01# | p259 | | | |
| | | | 270pF | ±10% | GMD033R71E271KA01# | p259 | | | |
| | | | 330pF | ±10% | GMD033R71E331KA01# | p259 | | | |
| | | | 390pF | ±10% | GMD033R71E391KA01# | p259 | | | |
| | | | 470pF | ±10% | GMD033R71E471KA01# | p259 | | | |
| | | | 560pF | ±10% | GMD033R71E561KA01# | p259 | | | |
| | | | 680pF | ±10% | GMD033R71E681KA01# | p259 | | | |
| | | | 820pF | ±10% | GMD033R71E821KA01# | p259 | | | |
| | | | 1000pF | ±10% | GMD033R71E102KA01# | p259 | | | |
| | | | 1200pF | ±10% | GMD033R71E122KA01# | p259 | | | |
| | | | 1500pF | ±10% | GMD033R71E152KA01# | p259 | | | |
| | | | R | 100pF | ±10% | GMD033R11E101KA01# | p259 | | |
| | | | | 120pF | ±10% | GMD033R11E121KA01# | p259 | | |
| | | | | 150pF | ±10% | GMD033R11E151KA01# | p259 | | |
| | | | | 180pF | ±10% | GMD033R11E181KA01# | p259 | | |
| | | | | 220pF | ±10% | GMD033R11E221KA01# | p259 | | |
| | | | | 270pF | ±10% | GMD033R11E271KA01# | p259 | | |
| | | | | 330pF | ±10% | GMD033R11E331KA01# | p259 | | |
| | | | | 390pF | ±10% | GMD033R11E391KA01# | p259 | | |
| | | | | 470pF | ±10% | GMD033R11E471KA01# | p259 | | |
| | | | | 560pF | ±10% | GMD033R11E561KA01# | p259 | | |
| | | | | 680pF | ±10% | GMD033R11E681KA01# | p259 | | |
| | | | | 820pF | ±10% | GMD033R11E821KA01# | p259 | | |
| | | 1000pF | | ±10% | GMD033R11E102KA01# | p259 | | | |
| | | 1200pF | | ±10% | GMD033R11E122KA01# | p259 | | | |
| | | 1500pF | | ±10% | GMD033R11E152KA01# | p259 | | | |
| | | B | | 100pF | ±10% | GMD033B11E101KA01# | p259 | | |
| | | | | 120pF | ±10% | GMD033B11E121KA01# | p259 | | |
| | | | | 150pF | ±10% | GMD033B11E151KA01# | p259 | | |
| | | | | 180pF | ±10% | GMD033B11E181KA01# | p259 | | |
| | | | | 220pF | ±10% | GMD033B11E221KA01# | p259 | | |
| | | | | 270pF | ±10% | GMD033B11E271KA01# | p259 | | |
| | | | | 330pF | ±10% | GMD033B11E331KA01# | p259 | | |
| | | | | 390pF | ±10% | GMD033B11E391KA01# | p259 | | |
| | | | | 470pF | ±10% | GMD033B11E471KA01# | p259 | | |
| | | | | 560pF | ±10% | GMD033B11E561KA01# | p259 | | |
| | | | | 680pF | ±10% | GMD033B11E681KA01# | p259 | | |
| | | | | 820pF | ±10% | GMD033B11E821KA01# | p259 | | |
| | | | 1000pF | ±10% | GMD033B11E102KA01# | p259 | | | |
| | | | 1200pF | ±10% | GMD033B11E122KA01# | p259 | | | |
| | | | 1500pF | ±10% | GMD033B11E152KA01# | p259 | | | |
| | | | 16Vdc | X7R | 1800pF | ±10% | GMD033R71C182KA11# | p259 | |
| | | | | | 2200pF | ±10% | GMD033R71C222KA11# | p259 | |
| | | | | | 2700pF | ±10% | GMD033R71C272KA11# | p259 | |
| | | | | | 3300pF | ±10% | GMD033R71C332KA11# | p259 | |
| | | | | | R | 1800pF | ±10% | GMD033R11C182KA11# | p259 |
| | | | | | | 2200pF | ±10% | GMD033R11C222KA11# | p259 |
| | | | | | | 2700pF | ±10% | GMD033R11C272KA11# | p259 |
| | | | | | | 3300pF | ±10% | GMD033R11C332KA11# | p259 |

| T max. | Rated Voltage | TC Code | Cap. | Tol. | Part Number | p* | | |
|--------|---------------|---------|---------|--------------------|--------------------|--------------------|--------------------|------|
| 0.33mm | 16Vdc | R | 3300pF | ±10% | GMD033R11C332KA11# | p259 | | |
| | | | B | 1800pF | ±10% | GMD033B31C182KA11# | p259 | |
| | | | | 2200pF | ±10% | GMD033B31C222KA11# | p259 | |
| | | | | 2700pF | ±10% | GMD033B31C272KA11# | p259 | |
| | | 3300pF | ±10% | GMD033B31C332KA11# | p259 | | | |
| | | 10Vdc | X7R | 3900pF | ±10% | GMD033R71A392KA01# | p259 | |
| | | | | 4700pF | ±10% | GMD033R71A472KA01# | p259 | |
| | | | | 5600pF | ±10% | GMD033R71A562KA01# | p259 | |
| | | | | 6800pF | ±10% | GMD033R71A682KA01# | p259 | |
| | | | | 8200pF | ±10% | GMD033R71A822KA01# | p259 | |
| | | | | 10000pF | ±10% | GMD033R71A103KA01# | p259 | |
| | | | | R | 3900pF | ±10% | GMD033R11A392KA01# | p259 |
| | | | | | 4700pF | ±10% | GMD033R11A472KA01# | p259 |
| | | | | | 5600pF | ±10% | GMD033R11A562KA01# | p259 |
| | | | | | 6800pF | ±10% | GMD033R11A682KA01# | p259 |
| | 8200pF | | ±10% | | GMD033R11A822KA01# | p259 | | |
| | B | | 3900pF | ±10% | GMD033B11A392KA01# | p259 | | |
| | | | 4700pF | ±10% | GMD033B11A472KA01# | p259 | | |
| | | | 5600pF | ±10% | GMD033B11A562KA01# | p259 | | |
| | | | 6800pF | ±10% | GMD033B11A682KA01# | p259 | | |
| | | 8200pF | ±10% | GMD033B11A822KA01# | p259 | | | |
| | | 10000pF | ±10% | GMD033B11A103KA01# | p259 | | | |
| | | 6.3Vdc | X5R | 56000pF | ±10% | GMD033R60J563KE11# | p261 | |
| | | | | 68000pF | ±10% | GMD033R60J683KE11# | p261 | |
| | | | | 82000pF | ±10% | GMD033R60J823KE11# | p261 | |
| | | | | 0.10μF | ±10% | GMD033R60J104KE11# | p261 | |
| | B | | | 56000pF | ±10% | GMD033B30J563KE11# | p261 | |
| | | | | 68000pF | ±10% | GMD033B30J683KE11# | p261 | |
| | | | 82000pF | ±10% | GMD033B30J823KE11# | p261 | | |
| | | | 0.10μF | ±10% | GMD033B30J104KE11# | p261 | | |

1.0×0.5mm

| T max. | Rated Voltage | TC Code | Cap. | Tol. | Part Number | p* | |
|--------|---------------|---------|--------|-------|--------------------|--------------------|------|
| 0.55mm | 50Vdc | X7R | 220pF | ±10% | GMD155R71H221KA01# | p259 | |
| | | | 270pF | ±10% | GMD155R71H271KA01# | p259 | |
| | | | 330pF | ±10% | GMD155R71H331KA01# | p259 | |
| | | | 390pF | ±10% | GMD155R71H391KA01# | p259 | |
| | | | 470pF | ±10% | GMD155R71H471KA01# | p259 | |
| | | | 560pF | ±10% | GMD155R71H561KA01# | p259 | |
| | | | 680pF | ±10% | GMD155R71H681KA01# | p259 | |
| | | | 820pF | ±10% | GMD155R71H821KA01# | p259 | |
| | | | 1000pF | ±10% | GMD155R71H102KA01# | p259 | |
| | | | 1200pF | ±10% | GMD155R71H122KA01# | p259 | |
| | | | 1500pF | ±10% | GMD155R71H152KA01# | p259 | |
| | | | 1800pF | ±10% | GMD155R71H182KA01# | p259 | |
| | | | 2200pF | ±10% | GMD155R71H222KA01# | p259 | |
| | | | 2700pF | ±10% | GMD155R71H272KA01# | p259 | |
| | | | 3300pF | ±10% | GMD155R71H332KA01# | p259 | |
| | | | 3900pF | ±10% | GMD155R71H392KA01# | p259 | |
| | | | 4700pF | ±10% | GMD155R71H472KA01# | p259 | |
| | | | R | 220pF | ±10% | GMD155R11H221KA01# | p259 |

*: Refers to the page of the "Specifications and Test Methods".

Part number # indicates the package specification code.

GMD Series High Dielectric Constant Type Part Number List

(→ 1.0×0.5mm)

| T max. | Rated Voltage | TC Code | Cap. | Tol. | Part Number | p* | | |
|--------|--------------------|---------|--------|-------|--------------------|--------------------|--------------------|------|
| 0.55mm | 50Vdc | R | 270pF | ±10% | GMD155R11H271KA01# | p259 | | |
| | | | 330pF | ±10% | GMD155R11H331KA01# | p259 | | |
| | | | 390pF | ±10% | GMD155R11H391KA01# | p259 | | |
| | | | 470pF | ±10% | GMD155R11H471KA01# | p259 | | |
| | | | 560pF | ±10% | GMD155R11H561KA01# | p259 | | |
| | | | 680pF | ±10% | GMD155R11H681KA01# | p259 | | |
| | | | 820pF | ±10% | GMD155R11H821KA01# | p259 | | |
| | | | 1000pF | ±10% | GMD155R11H102KA01# | p259 | | |
| | | | 1200pF | ±10% | GMD155R11H122KA01# | p259 | | |
| | | | 1500pF | ±10% | GMD155R11H152KA01# | p259 | | |
| | | | 1800pF | ±10% | GMD155R11H182KA01# | p259 | | |
| | | | 2200pF | ±10% | GMD155R11H222KA01# | p259 | | |
| | | | 2700pF | ±10% | GMD155R11H272KA01# | p259 | | |
| | | | 3300pF | ±10% | GMD155R11H332KA01# | p259 | | |
| | | | 3900pF | ±10% | GMD155R11H392KA01# | p259 | | |
| | | | 4700pF | ±10% | GMD155R11H472KA01# | p259 | | |
| | | | B | 220pF | ±10% | GMD155B11H221KA01# | p259 | |
| | | | | 270pF | ±10% | GMD155B11H271KA01# | p259 | |
| | | | | 330pF | ±10% | GMD155B11H331KA01# | p259 | |
| | | | | 390pF | ±10% | GMD155B11H391KA01# | p259 | |
| | | | | 470pF | ±10% | GMD155B11H471KA01# | p259 | |
| | | 560pF | | ±10% | GMD155B11H561KA01# | p259 | | |
| | | 680pF | | ±10% | GMD155B11H681KA01# | p259 | | |
| | | 820pF | | ±10% | GMD155B11H821KA01# | p259 | | |
| | | 1000pF | | ±10% | GMD155B11H102KA01# | p259 | | |
| | | 1200pF | | ±10% | GMD155B11H122KA01# | p259 | | |
| | | 1500pF | | ±10% | GMD155B11H152KA01# | p259 | | |
| | | 1800pF | | ±10% | GMD155B11H182KA01# | p259 | | |
| | | 2200pF | | ±10% | GMD155B11H222KA01# | p259 | | |
| | | 2700pF | | ±10% | GMD155B11H272KA01# | p259 | | |
| | | 3300pF | | ±10% | GMD155B11H332KA01# | p259 | | |
| | | 3900pF | | ±10% | GMD155B11H392KA01# | p259 | | |
| | | 4700pF | | ±10% | GMD155B11H472KA01# | p259 | | |
| | | X7R | | 25Vdc | 5600pF | ±10% | GMD155R71E562KA01# | p259 |
| | | | | | | ±10% | GMD155R71E682KA01# | p259 |
| | | | | | | ±10% | GMD155R71E822KA01# | p259 |
| | | | | | | ±10% | GMD155R71E103KA01# | p259 |
| | | | | | | ±10% | GMD155R71E123KA01# | p259 |
| | | | | | | ±10% | GMD155R71E153KA01# | p259 |
| | | | | | | ±10% | GMD155R71E183KA01# | p259 |
| | | | | | | ±10% | GMD155R71E223KA01# | p259 |
| | | | | | | ±10% | GMD155R71E273KA11# | p259 |
| | | | ±10% | | | GMD155R71E333KA11# | p259 | |
| | | | ±10% | | | GMD155R71E393KA11# | p259 | |
| | | | ±10% | | | GMD155R71E473KA11# | p259 | |
| | | | 5600pF | | | ±10% | GMD155R11E562KA01# | p259 |
| | | | | | ±10% | GMD155R11E682KA01# | p259 | |
| ±10% | GMD155R11E822KA01# | | | | p259 | | | |
| ±10% | GMD155R11E103KA01# | | | | p259 | | | |
| ±10% | GMD155R11E123KA01# | | | | p259 | | | |
| ±10% | GMD155R11E153KA01# | | | | p259 | | | |
| ±10% | GMD155R11E183KA01# | | | | p259 | | | |
| ±10% | GMD155R11E223KA01# | | | | p259 | | | |
| ±10% | GMD155R11E273KA11# | | | | p259 | | | |
| ±10% | GMD155R11E333KA11# | | | | p259 | | | |
| ±10% | GMD155R11E393KA11# | | | | p259 | | | |
| ±10% | GMD155R11E473KA11# | | | | p259 | | | |

| T max. | Rated Voltage | TC Code | Cap. | Tol. | Part Number | p* | | | |
|--------|---------------|---------|--------------------|--------------------|--------------------|--------------------|--------------------|--------------------|--------------------|
| 0.55mm | 25Vdc | R | 3300pF | ±10% | GMD155R11E333KA11# | p259 | | | |
| | | | 3900pF | ±10% | GMD155R11E393KA11# | p259 | | | |
| | | | 4700pF | ±10% | GMD155R11E473KA11# | p259 | | | |
| | | | B | 5600pF | ±10% | GMD155B11E562KA01# | p259 | | |
| | | | | 6800pF | ±10% | GMD155B11E682KA01# | p259 | | |
| | | | | 8200pF | ±10% | GMD155B11E822KA01# | p259 | | |
| | | | | 10000pF | ±10% | GMD155B11E103KA01# | p259 | | |
| | | | | 12000pF | ±10% | GMD155B11E123KA01# | p259 | | |
| | | | | 15000pF | ±10% | GMD155B11E153KA01# | p259 | | |
| | | | | 18000pF | ±10% | GMD155B11E183KA01# | p259 | | |
| | | | | 22000pF | ±10% | GMD155B11E223KA01# | p259 | | |
| | | | | 27000pF | ±10% | GMD155B31E273KA11# | p259 | | |
| | | | | 33000pF | ±10% | GMD155B31E333KA11# | p259 | | |
| | | | | 39000pF | ±10% | GMD155B31E393KA11# | p259 | | |
| | | | | 47000pF | ±10% | GMD155B31E473KA11# | p259 | | |
| | | | | X7R | 16Vdc | 5600pF | ±10% | GMD155R71C563KA11# | p259 |
| | | | | | | | ±10% | GMD155R71C683KA11# | p259 |
| | | | | | | | ±10% | GMD155R71C823KA11# | p259 |
| | | | | | | | 0.10μF | ±10% | GMD155R71C104KA11# |
| | | | 56000pF | | | | ±10% | GMD155R11C563KA11# | p259 |
| | | | 68000pF | | | ±10% | GMD155R11C683KA11# | p259 | |
| | | ±10% | | | | GMD155R11C823KA11# | p259 | | |
| | | 0.10μF | | | | ±10% | GMD155R11C104KA11# | p259 | |
| | | B | | | | 5600pF | ±10% | GMD155B31C563KA11# | p259 |
| | | | | | | | ±10% | GMD155B31C683KA11# | p259 |
| | | | ±10% | GMD155B31C823KA11# | p259 | | | | |
| | | | 0.10μF | ±10% | GMD155B31C104KA11# | | p259 | | |
| | | | X5R | 10Vdc | 0.12μF | | ±10% | GMD155R61A124KE12# | p261 |
| | | ±10% | | | | GMD155R61A154KE12# | p261 | | |
| | | ±10% | | | | GMD155R61A184KE12# | p261 | | |
| | | ±10% | | | | GMD155R61A224KE12# | p261 | | |
| | | ±10% | | | | GMD155R61A274KE11# | p263 | | |
| | | 0.15μF | | | ±10% | GMD155R61A274KE11# | p263 | | |
| | | | | | ±10% | GMD155R61A334KE11# | p263 | | |
| | | | | | ±10% | GMD155R61A394KE11# | p263 | | |
| | | | | | ±10% | GMD155R61A474KE11# | p263 | | |
| | | | | | B | 0.12μF | ±10% | GMD155B31A124KE12# | p261 |
| | | ±10% | GMD155B31A154KE12# | p261 | | | | | |
| | | ±10% | GMD155B31A184KE12# | p261 | | | | | |
| | | ±10% | GMD155B31A224KE12# | p261 | | | | | |
| | | ±10% | GMD155B31A274KE11# | p263 | | | | | |
| | | 0.15μF | ±10% | GMD155B31A274KE11# | p263 | | | | |
| | | | ±10% | GMD155B31A334KE11# | p263 | | | | |
| | | | ±10% | GMD155B31A394KE11# | p263 | | | | |
| | | | ±10% | GMD155B31A474KE11# | p263 | | | | |
| | | | ±10% | GMD155B31A474KE11# | p263 | | | | |

*: Refers to the page of the "Specifications and Test Methods".

Part number # indicates the package specification code.

1

GMD Series Specifications and Test Methods (1)

| No | Item | Specification | Test Method (Ref. Standard: JIS C 5101, IEC60384) | | | | | | | | | | | | | | | | | | | | | |
|------|--|--|--|------|------------------|------------------------|---|------------------------------|------------|---|------------------------------|--------|-------------------------|------------------------------|------------------------------|---|-------------------------|---------------------------------------|---|------------------------------|---|-------------------------|---|------------------------------|
| 1 | Rated Voltage | Shown in Rated value. | The rated voltage is defined as the maximum voltage which may be applied continuously to the capacitor. When AC voltage is superimposed on DC voltage, V^P -P or V^O -P, whichever is larger, should be maintained within the rated voltage range. | | | | | | | | | | | | | | | | | | | | | |
| 2 | Appearance | No defects or abnormalities. | Visual inspection. | | | | | | | | | | | | | | | | | | | | | |
| 3 | Dimension | Within the specified dimensions. | Using Measuring instrument of dimension. | | | | | | | | | | | | | | | | | | | | | |
| 4 | Voltage Proof | No defects or abnormalities. | Measurement Point: Between the terminations Test Voltage: 250% of the rated voltage Applied Time: 1 to 5s Charge/discharge current: 50mA max. | | | | | | | | | | | | | | | | | | | | | |
| 5 | Insulation Resistance (I.R.) | $C \leq 0.047\mu\text{F}$: More than 10000MΩ $C > 0.047\mu\text{F}$: More than $500\Omega \cdot \text{F}$ C: Nominal Capacitance | Measurement Point: Between the terminations Measurement Voltage: DC Rated Voltage Charging Time: 2min Charge/discharge current: 50mA max. Measurement Temperature: Room Temperature | | | | | | | | | | | | | | | | | | | | | |
| 6 | Capacitance | Shown in Rated value. | Measurement Temperature: Room Temperature Measurement Frequency: $1.0 \pm 0.1\text{kHz}$ Measurement Voltage: $1.0 \pm 0.2\text{Vrms}$ | | | | | | | | | | | | | | | | | | | | | |
| 7 | Dissipation Factor (D.F.) | W.V.: 25Vdc min.: 0.025max. W.V.: 16/10Vdc: 0.035max. | | | | | | | | | | | | | | | | | | | | | | |
| 8 | Temperature Characteristics of Capacitance | No Bias | The capacitance change should be measured after 5 minutes at each specified temp. stage. In case of applying voltage, the capacitance change should be measured after 1 minute with applying voltage in equilibration of each temp. stage. Capacitance value as a reference is the value in step 3. | | | | | | | | | | | | | | | | | | | | | |
| | | 50% of the Rated Voltage | | | | | | | | | | | | | | | | | | | | | | |
| | | | <table border="1"> <thead> <tr> <th>Step</th> <th>Temperature (°C)</th> <th>Applying Voltage (VDC)</th> </tr> </thead> <tbody> <tr> <td>1</td> <td>Reference Temp. ± 2</td> <td rowspan="4">No bias</td> </tr> <tr> <td>2</td> <td>Min. Operating Temp. ± 3</td> </tr> <tr> <td>3</td> <td>Reference Temp. ± 2</td> </tr> <tr> <td>4</td> <td>Max. Operating Temp. ± 3</td> </tr> <tr> <td>5</td> <td>Reference Temp. ± 2</td> <td rowspan="4">50% of the rated voltage (For B1, R1)</td> </tr> <tr> <td>6</td> <td>Min. Operating Temp. ± 3</td> </tr> <tr> <td>7</td> <td>Reference Temp. ± 2</td> </tr> <tr> <td>8</td> <td>Max. Operating Temp. ± 3</td> </tr> </tbody> </table> | Step | Temperature (°C) | Applying Voltage (VDC) | 1 | Reference Temp. ± 2 | No bias | 2 | Min. Operating Temp. ± 3 | 3 | Reference Temp. ± 2 | 4 | Max. Operating Temp. ± 3 | 5 | Reference Temp. ± 2 | 50% of the rated voltage (For B1, R1) | 6 | Min. Operating Temp. ± 3 | 7 | Reference Temp. ± 2 | 8 | Max. Operating Temp. ± 3 |
| Step | Temperature (°C) | Applying Voltage (VDC) | | | | | | | | | | | | | | | | | | | | | | |
| 1 | Reference Temp. ± 2 | No bias | | | | | | | | | | | | | | | | | | | | | | |
| 2 | Min. Operating Temp. ± 3 | | | | | | | | | | | | | | | | | | | | | | | |
| 3 | Reference Temp. ± 2 | | | | | | | | | | | | | | | | | | | | | | | |
| 4 | Max. Operating Temp. ± 3 | | | | | | | | | | | | | | | | | | | | | | | |
| 5 | Reference Temp. ± 2 | 50% of the rated voltage (For B1, R1) | | | | | | | | | | | | | | | | | | | | | | |
| 6 | Min. Operating Temp. ± 3 | | | | | | | | | | | | | | | | | | | | | | | |
| 7 | Reference Temp. ± 2 | | | | | | | | | | | | | | | | | | | | | | | |
| 8 | Max. Operating Temp. ± 3 | | | | | | | | | | | | | | | | | | | | | | | |
| | | | <ul style="list-style-type: none"> Initial measurement Perform a heat treatment at $150 \pm 0/-10^\circ\text{C}$ for 1h and then let sit for $24 \pm 2\text{h}$ at room temperature, then measure. | | | | | | | | | | | | | | | | | | | | | |
| 9 | Adhesive Strength of Termination | Bond Strength | MIL-STD-883 Method 2011 Condition D Mount the capacitor on a gold metalized alumina substrate with Au-20Sn and bond a $\phi 25\mu\text{m}$ ($\phi 0.001$ inch) gold wire to the capacitor terminal using an ultrasonic ball bond. Then, pull wire. | | | | | | | | | | | | | | | | | | | | | |
| | | Die Shear Strength | MIL-STD-883 Method 2019 Mount the capacitor on a gold metalized alumina substrate with Au-20Sn. Apply the force parallel to the substrate. | | | | | | | | | | | | | | | | | | | | | |
| 10 | Vibration * | Appearance | Kind of Vibration: A simple harmonic motion 10Hz to 55Hz to 10Hz (1min) Total amplitude: 1.5mm This motion should be applied for a period of 2h in each 3 mutually perpendicular directions (total of 6h). | | | | | | | | | | | | | | | | | | | | | |
| | | Capacitance | | | | | | | | | | | | | | | | | | | | | | |
| | | D.F. | | | | | | | | | | | | | | | | | | | | | | |
| 11 | Temperature Sudden Change * | Appearance | Perform the five cycles according to the four heat treatments shown in the following table. | | | | | | | | | | | | | | | | | | | | | |
| | | Capacitance Change | | | | | | | | | | | | | | | | | | | | | | |
| | | D.F. | | | | | | | | | | | | | | | | | | | | | | |
| | | I.R. | | | | | | | | | | | | | | | | | | | | | | |
| | | Voltage Proof | No defects. | | | | | | | | | | | | | | | | | | | | | |
| | | | <table border="1"> <thead> <tr> <th>Step</th> <th>Temp. (°C)</th> <th>Time (min)</th> </tr> </thead> <tbody> <tr> <td>1</td> <td>Min. Operating Temp. $+0/-3$</td> <td>30 ± 3</td> </tr> <tr> <td>2</td> <td>Room Temp.</td> <td>2 to 3</td> </tr> <tr> <td>3</td> <td>Max. Operating Temp. $+3/-0$</td> <td>30 ± 3</td> </tr> <tr> <td>4</td> <td>Room Temp.</td> <td>2 to 3</td> </tr> </tbody> </table> | Step | Temp. (°C) | Time (min) | 1 | Min. Operating Temp. $+0/-3$ | 30 ± 3 | 2 | Room Temp. | 2 to 3 | 3 | Max. Operating Temp. $+3/-0$ | 30 ± 3 | 4 | Room Temp. | 2 to 3 | | | | | | |
| Step | Temp. (°C) | Time (min) | | | | | | | | | | | | | | | | | | | | | | |
| 1 | Min. Operating Temp. $+0/-3$ | 30 ± 3 | | | | | | | | | | | | | | | | | | | | | | |
| 2 | Room Temp. | 2 to 3 | | | | | | | | | | | | | | | | | | | | | | |
| 3 | Max. Operating Temp. $+3/-0$ | 30 ± 3 | | | | | | | | | | | | | | | | | | | | | | |
| 4 | Room Temp. | 2 to 3 | | | | | | | | | | | | | | | | | | | | | | |
| | | | Exposure Time: $24 \pm 2\text{h}$ <ul style="list-style-type: none"> Initial measurement Perform a heat treatment at $150 \pm 0/-10^\circ\text{C}$ for 1h and then let sit for $24 \pm 2\text{h}$ at room temperature, then measure. | | | | | | | | | | | | | | | | | | | | | |

Continued on the following page. ↗

GRM
GR3
GRJ
GR4
GR7
GJM
GQM
GA2
GA3 GB
GA3 GD
GA3 GF
LLL
LLA
LLM
LLR
NFM
KPM
KR3
GMA
GMD
⚠Caution / Notice

GMD Series Specifications and Test Methods (1)

Continued from the preceding page. ↘

| No | Item | Specification | Test Method (Ref. Standard: JIS C 5101, IEC60384) |
|----|---|--------------------|---|
| 12 | High Temperature High Humidity (Steady) * | Appearance | No defects or abnormalities. |
| | | Capacitance Change | Within $\pm 12.5\%$ |
| | | D.F. | 0.05max. |
| | | I.R. | More than $500M\Omega$ or $25\Omega \cdot F$ (Whichever is smaller) |
| 13 | Durability * | Appearance | No defects or abnormalities. |
| | | Capacitance Change | Within $\pm 12.5\%$ |
| | | D.F. | 0.05max. |
| | | I.R. | More than $1000M\Omega$ or $50\Omega \cdot F$ (Whichever is smaller) |
| | | | Test Temperature: $40\pm 2^\circ C$ Test Humidity: 90 to 95%RH Test Time: $500\pm 12h$ Applied Voltage: DC Rated Voltage Charge/discharge current: 50mA max. Exposure Time: $24\pm 2h$ |
| | | | Test Temperature: Max. Operating Temp. $\pm 3^\circ C$ Test Time: $1000\pm 12h$ Applied Voltage: 200% of the rated voltage Charge/discharge current: 50mA max. Exposure Time: $24\pm 2h$ • Initial measurement Apply 200% of the rated DC voltage at the max. operating temp. $\pm 3^\circ C$ for 1h. Remove and set for $24\pm 2h$ at room temperature. Perform initial measurement. |

* Mounting for testing: The capacitors should be mounted on the substrate as shown below using die bonding and wire bonding when tests No.10 to 13 are performed.

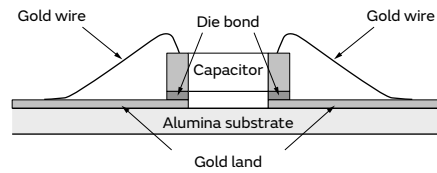

GRM
 GR3
 GRJ
 GR4
 GR7
 GJM
 GQM
 GA2
 GA3 GB
 GA3 GD
 GA3 GF
 LLL
 LLA
 LLM
 LLR
 NFM
 KRM
 KR3
 GMA
GMD
 ⚠Caution /Notice

2

GMD Series Specifications and Test Methods (2)

| No | Item | Specification | Test Method (Ref. Standard: JIS C 5101, IEC60384) | | | | | | | | | | | |
|------------------------|--|---|---|-------------|------------------|------------------------|------------------------|--------------------|-------------|----------------------|-------------------------|-------------|--------------------|---|
| 1 | Rated Voltage | Shown in Rated value. | The rated voltage is defined as the maximum voltage which may be applied continuously to the capacitor. When AC voltage is superimposed on DC voltage, V^P -P or V^O -P, whichever is larger, should be maintained within the rated voltage range. | | | | | | | | | | | |
| 2 | Appearance | No defects or abnormalities. | Visual inspection. | | | | | | | | | | | |
| 3 | Dimension | Within the specified dimensions. | Using Measuring instrument of dimension. | | | | | | | | | | | |
| 4 | Voltage Proof | No defects or abnormalities. | Measurement Point: Between the terminations Test Voltage: 250% of the rated voltage Applied Time: 1 to 5s Charge/discharge current: 50mA max. | | | | | | | | | | | |
| 5 | Insulation Resistance (I.R.) | More than 2000MΩ or 50Ω · F (Whichever is smaller) | Measurement Point: Between the terminations Measurement Voltage: DC Rated Voltage Charging Time: 1min Charge/discharge current: 50mA max. Measurement Temperature: Room Temperature | | | | | | | | | | | |
| 6 | Capacitance | Shown in Rated value. | Measurement Temperature: Room Temperature | | | | | | | | | | | |
| 7 | Dissipation Factor (D.F.) | 0.1 max. | <table border="1"> <thead> <tr> <th>Capacitance</th> <th>Frequency</th> <th>Voltage</th> </tr> </thead> <tbody> <tr> <td>*1 C ≤ 10μF (10V min.)</td> <td>1.0±0.1kHz</td> <td>1.0±0.2Vrms</td> </tr> <tr> <td>C ≤ 10μF (6.3V max.)</td> <td>1.0±0.1kHz</td> <td>0.5±0.1Vrms</td> </tr> </tbody> </table> | Capacitance | Frequency | Voltage | *1 C ≤ 10μF (10V min.) | 1.0±0.1kHz | 1.0±0.2Vrms | C ≤ 10μF (6.3V max.) | 1.0±0.1kHz | 0.5±0.1Vrms | | |
| | | | Capacitance | Frequency | Voltage | | | | | | | | | |
| *1 C ≤ 10μF (10V min.) | 1.0±0.1kHz | 1.0±0.2Vrms | | | | | | | | | | | | |
| C ≤ 10μF (6.3V max.) | 1.0±0.1kHz | 0.5±0.1Vrms | | | | | | | | | | | | |
| | | | *1 GMD155 B3/R6 1A 124 to 224 are applied to 0.5±0.1Vrms | | | | | | | | | | | |
| 8 | Temperature Characteristics of Capacitance | No Bias B3: Within ±10% (-25 to +85°C) R6: Within ±15% (-55 to +85°C) | The capacitance change should be measured after 5 minutes at each specified temp. stage. Capacitance value as a reference is the value in step 3. | | | | | | | | | | | |
| | | | <table border="1"> <thead> <tr> <th>Step</th> <th>Temperature (°C)</th> <th>Applying Voltage (VDC)</th> </tr> </thead> <tbody> <tr> <td>1</td> <td>Reference Temp. ±2</td> <td rowspan="5">No bias</td> </tr> <tr> <td>2</td> <td>Min. Operating Temp. ±3</td> </tr> <tr> <td>3</td> <td>Reference Temp. ±2</td> </tr> <tr> <td>4</td> <td>Max. Operating Temp. ±3</td> </tr> <tr> <td>5</td> <td>Reference Temp. ±2</td> </tr> </tbody> </table> | Step | Temperature (°C) | Applying Voltage (VDC) | 1 | Reference Temp. ±2 | No bias | 2 | Min. Operating Temp. ±3 | 3 | Reference Temp. ±2 | 4 |
| Step | Temperature (°C) | Applying Voltage (VDC) | | | | | | | | | | | | |
| 1 | Reference Temp. ±2 | No bias | | | | | | | | | | | | |
| 2 | Min. Operating Temp. ±3 | | | | | | | | | | | | | |
| 3 | Reference Temp. ±2 | | | | | | | | | | | | | |
| 4 | Max. Operating Temp. ±3 | | | | | | | | | | | | | |
| 5 | Reference Temp. ±2 | | | | | | | | | | | | | |
| 9 | Adhesive Strength of Termination | Bond Strength | MIL-STD-883 Method 2011 Condition D Mount the capacitor on a gold metalized alumina substrate with Au-20Sn and bond a ø25μm (ø0.001 inch) gold wire to the capacitor terminal using an ultrasonic ball bond. Then, pull wire. | | | | | | | | | | | |
| | | Die Shear Strength | MIL-STD-883 Method 2019 Mount the capacitor on a gold metalized alumina substrate with Au-20Sn. Apply the force parallel to the substrate. | | | | | | | | | | | |
| 10 | Vibration *2 | Appearance | Kind of Vibration: A simple harmonic motion 10Hz to 55Hz to 10Hz (1min) Total amplitude: 1.5mm This motion should be applied for a period of 2h in each 3 mutually perpendicular directions (total of 6h). | | | | | | | | | | | |
| | | Capacitance | | | | | | | | | | | | |
| | | D.F. | | | | | | | | | | | | |
| 11 | Temperature Sudden Change *2 | Appearance | Perform the five cycles according to the four heat treatments shown in the following table. | | | | | | | | | | | |
| | | Capacitance Change | | | | | | | | | | | | |
| | | D.F. | | | | | | | | | | | | |
| | | I.R. | | | | | | | | | | | | |
| | | Voltage Proof | No defects. | | | | | | | | | | | |

Continued on the following page. ↗

GRM
GR3
GRJ
GR4
GR7
GJM
GQM
GA2
GA3 GB
GA3 GD
GA3 GF
LLL
LLA
LLM
LLR
NFM
KPM
KR3
GMA
GMD
△Caution / Notice

GMD Series Specifications and Test Methods (2)

Continued from the preceding page. ↘

| No | Item | Specification | Test Method (Ref. Standard: JIS C 5101, IEC60384) | |
|----|---|---|---|--|
| 12 | High Temperature High Humidity (Steady) *2 | Appearance | Test Temperature: 40±2°C Test Humidity: 90 to 95%RH Test Time: 500±12h Applied Voltage: DC Rated Voltage Charge/discharge current: 50mA max. • Initial measurement Perform a heat treatment at 150+0/-10°C for 1h and then let sit for 24±2h at room temperature, then measure. • Measurement after test Perform a heat treatment at 150+0/-10°C for 1h and then let sit for 24±2h at room temperature, then measure. | |
| | Capacitance Change | Within ±12.5% | | |
| | D.F. | 0.2 max. | | |
| | I.R. | More than 500MΩ or 12.5Ω • F (Whichever is smaller) | | |
| 13 | Durability *2 | Appearance | Test Temperature: Max. Operating Temp. ±3°C Test Time: 1000±12h Applied Voltage: 150% of the rated voltage Charge/discharge current: 50mA max. • Initial measurement Perform a heat treatment at 150+0/-10°C for 1h and then let sit for 24±2h at room temperature, then measure. • Measurement after test Perform a heat treatment at 150+0/-10°C for 1h and then let sit for 24±2h at room temperature, then measure. | |
| | | Capacitance Change | | Within ±12.5% |
| | | D.F. | | 0.2 max. |
| | | I.R. | | More than 1000MΩ or 25Ω • F (Whichever is smaller) |

*2 Mounting for testing: The capacitors should be mounted on the substrate as shown below using die bonding and wire bonding when tests No.10 to 13 are performed.

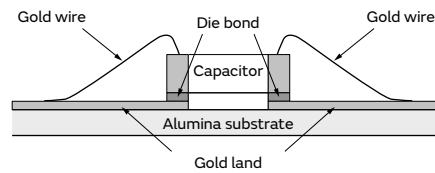
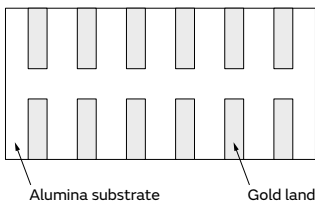

GRM
GR3
GRJ
GR4
GR7
GJM
GQM
GA2
GA3 GB
GA3 GD
GA3 GF
LLL
LLA
LLM
LLR
NFM
KRM
KR3
GMA
GMD
⚠Caution /Notice

3

GMD Series Specifications and Test Methods (3)

| No | Item | Specification | Test Method (Ref. Standard: JIS C 5101, IEC60384) | | | | | | | | | | | |
|------------------------|--|---|---|-------------|------------------|------------------------|------------------------|--------------------|-------------|----------------------|-------------------------|-------------|--------------------|---|
| 1 | Rated Voltage | Shown in Rated value. | The rated voltage is defined as the maximum voltage which may be applied continuously to the capacitor. When AC voltage is superimposed on DC voltage, V^{P-P} or V^{O-P} , whichever is larger, should be maintained within the rated voltage range. | | | | | | | | | | | |
| 2 | Appearance | No defects or abnormalities. | Visual inspection. | | | | | | | | | | | |
| 3 | Dimension | Within the specified dimensions. | Using Measuring instrument of dimension. | | | | | | | | | | | |
| 4 | Voltage Proof | No defects or abnormalities. | Measurement Point: Between the terminations Test Voltage: 250% of the rated voltage Applied Time: 1 to 5s Charge/discharge current: 50mA max. | | | | | | | | | | | |
| 5 | Insulation Resistance (I.R.) | More than 2000MΩ or 50Ω • F (Whichever is smaller) | Measurement Point: Between the terminations Measurement Voltage: DC Rated Voltage Charging Time: 1min Charge/discharge current: 50mA max. Measurement Temperature: Room Temperature | | | | | | | | | | | |
| 6 | Capacitance | Shown in Rated value. | Measurement Temperature: Room Temperature | | | | | | | | | | | |
| 7 | Dissipation Factor (D.F.) | 0.1 max. | <table border="1"> <thead> <tr> <th>Capacitance</th> <th>Frequency</th> <th>Voltage</th> </tr> </thead> <tbody> <tr> <td>*1 C ≤ 10μF (10V min.)</td> <td>1.0±0.1kHz</td> <td>1.0±0.2Vrms</td> </tr> <tr> <td>C ≤ 10μF (6.3V max.)</td> <td>1.0±0.1kHz</td> <td>0.5±0.1Vrms</td> </tr> </tbody> </table> | Capacitance | Frequency | Voltage | *1 C ≤ 10μF (10V min.) | 1.0±0.1kHz | 1.0±0.2Vrms | C ≤ 10μF (6.3V max.) | 1.0±0.1kHz | 0.5±0.1Vrms | | |
| | | | Capacitance | Frequency | Voltage | | | | | | | | | |
| *1 C ≤ 10μF (10V min.) | 1.0±0.1kHz | 1.0±0.2Vrms | | | | | | | | | | | | |
| C ≤ 10μF (6.3V max.) | 1.0±0.1kHz | 0.5±0.1Vrms | | | | | | | | | | | | |
| | | | *1 GMD155 B3/R6 1A 124 to 224 are applied to 0.5±0.1Vrms | | | | | | | | | | | |
| 8 | Temperature Characteristics of Capacitance | No Bias B3: Within ±10% (-25 to +85°C) R6: Within ±15% (-55 to +85°C) | The capacitance change should be measured after 5 minutes at each specified temp. stage. Capacitance value as a reference is the value in step 3. | | | | | | | | | | | |
| | | | <table border="1"> <thead> <tr> <th>Step</th> <th>Temperature (°C)</th> <th>Applying Voltage (VDC)</th> </tr> </thead> <tbody> <tr> <td>1</td> <td>Reference Temp. ±2</td> <td rowspan="5">No bias</td> </tr> <tr> <td>2</td> <td>Min. Operating Temp. ±3</td> </tr> <tr> <td>3</td> <td>Reference Temp. ±2</td> </tr> <tr> <td>4</td> <td>Max. Operating Temp. ±3</td> </tr> <tr> <td>5</td> <td>Reference Temp. ±2</td> </tr> </tbody> </table> | Step | Temperature (°C) | Applying Voltage (VDC) | 1 | Reference Temp. ±2 | No bias | 2 | Min. Operating Temp. ±3 | 3 | Reference Temp. ±2 | 4 |
| Step | Temperature (°C) | Applying Voltage (VDC) | | | | | | | | | | | | |
| 1 | Reference Temp. ±2 | No bias | | | | | | | | | | | | |
| 2 | Min. Operating Temp. ±3 | | | | | | | | | | | | | |
| 3 | Reference Temp. ±2 | | | | | | | | | | | | | |
| 4 | Max. Operating Temp. ±3 | | | | | | | | | | | | | |
| 5 | Reference Temp. ±2 | | | | | | | | | | | | | |
| 9 | Adhesive Strength of Termination | Bond Strength | MIL-STD-883 Method 2011 Condition D Mount the capacitor on a gold metalized alumina substrate with Au-20Sn and bond a ø25μm (ø0.001 inch) gold wire to the capacitor terminal using an ultrasonic ball bond. Then, pull wire. | | | | | | | | | | | |
| | | Die Shear Strength | MIL-STD-883 Method 2019 Mount the capacitor on a gold metalized alumina substrate with Au-20Sn. Apply the force parallel to the substrate. | | | | | | | | | | | |
| 10 | Vibration *2 | Appearance | Kind of Vibration: A simple harmonic motion 10Hz to 55Hz to 10Hz (1min) Total amplitude: 1.5mm This motion should be applied for a period of 2h in each 3 mutually perpendicular directions (total of 6h). | | | | | | | | | | | |
| | | Capacitance | | | | | | | | | | | | |
| | | D.F. | | | | | | | | | | | | |
| 11 | Temperature Sudden Change *2 | Appearance | Perform the five cycles according to the four heat treatments shown in the following table. | | | | | | | | | | | |
| | | Capacitance Change | | | | | | | | | | | | |
| | | D.F. | | | | | | | | | | | | |
| | | I.R. | | | | | | | | | | | | |
| | | Voltage Proof | No defects. | | | | | | | | | | | |

Continued on the following page. ↗

GRM
GR3
GRJ
GR4
GR7
GJM
GQM
GA2
GA3 GB
GA3 GD
GA3 GF
LLL
LLA
LLM
LLR
NFM
KPM
KR3
GMA
GMD
△Caution / Notice

GMD Series Specifications and Test Methods (3)

Continued from the preceding page. ↘

| No | Item | Specification | Test Method (Ref. Standard: JIS C 5101, IEC60384) |
|----|--|--------------------|--|
| 12 | High Temperature High Humidity (Steady) *2 | Appearance | No defects or abnormalities. |
| | | Capacitance Change | Within $\pm 12.5\%$ |
| | | D.F. | 0.2 max. |
| | | I.R. | More than 500M Ω or 12.5 Ω · F (Whichever is smaller) |
| 13 | Durability *2 | Appearance | No defects or abnormalities. |
| | | Capacitance Change | Within $\pm 12.5\%$ |
| | | D.F. | 0.2 max. |
| | | I.R. | More than 1000M Ω or 25 Ω · F (Whichever is smaller) |
| | | | Test Temperature: 40 $\pm 2^\circ\text{C}$ Test Humidity: 90 to 95%RH Test Time: 500 ± 12 h Applied Voltage: DC Rated Voltage Charge/discharge current: 50mA max. • Initial measurement Perform a heat treatment at 150+0/-10 $^\circ\text{C}$ for 1h and then let sit for 24 ± 2 h at room temperature, then measure. • Measurement after test Perform a heat treatment at 150+0/-10 $^\circ\text{C}$ for 1h and then let sit for 24 ± 2 h at room temperature, then measure. |
| | | | Test Temperature: Max. Operating Temp. $\pm 3^\circ\text{C}$ Test Time: 1000 ± 12 h Applied Voltage: 120% of the rated voltage Charge/discharge current: 50mA max. • Initial measurement Perform a heat treatment at 150+0/-10 $^\circ\text{C}$ for 1h and then let sit for 24 ± 2 h at room temperature, then measure. • Measurement after test Perform a heat treatment at 150+0/-10 $^\circ\text{C}$ for 1h and then let sit for 24 ± 2 h at room temperature, then measure. |

*2 Mounting for testing: The capacitors should be mounted on the substrate as shown below using die bonding and wire bonding when tests No.10 to 13 are performed.

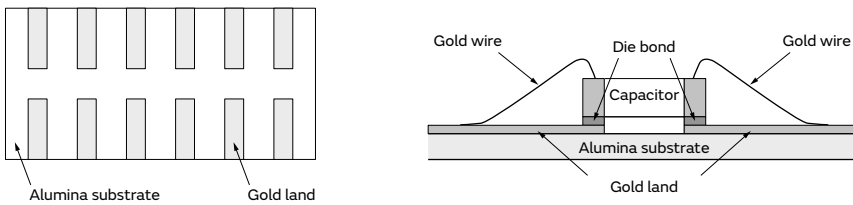

Recommended derating conditions on voltage and temperature

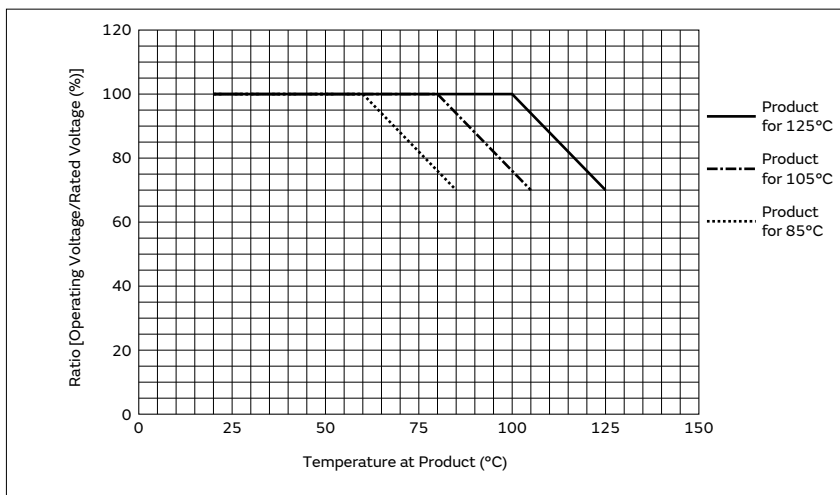

These Part Numbers are designed for use in the circuits where continuous applied voltage to the capacitor is derated than rated voltage, and guarantee Durability Test with 120% × rated voltage as testing voltage at the maximum operating temperature. The voltage and temperature derating conditions on the upside are recommended for use to ensure the same reliability level as normal specification.

GRM
 GR3
 GRJ
 GR4
 GR7
 GJM
 GQM
 GA2
 GA3 GB
 GA3 GD
 GA3 GF
 LLL
 LLA
 LLM
 LLR
 NFM
 KRM
 KR3
 GMA
 GMD
 ⚠Caution /Notice

**GRM, GR3, GRJ, GR4, GR7, GJM,
 GQM, GA2, GA3, LLL, LLA, LLM,
 LLR, NFM, KRM, KR3, GMA, GMD**

⚠️ Caution/Notice



⚠️ Caution

Notice

Storage and Operation Conditions 266

Rating 266

1. Temperature Dependent Characteristics 266
2. Measurement of Capacitance 266
3. Applied Voltage and Applied Current 267
4. Type of Applied Voltage and Self-heating Temperature 267
5. DC Voltage and AC Voltage Characteristics 270
6. Capacitance Aging 270
7. Vibration and Shock 271

Soldering and Mounting 271

1. Mounting Position 271
2. Information before Mounting 272
3. Maintenance of the Mounting (pick and place) Machine 272
- 4-1. Reflow Soldering 273
- 4-2. Flow Soldering 275
- 4-3. Correction of Soldered Portion 276
5. Washing 277
6. Electrical Test on Printed Circuit Board 277
7. Printed Circuit Board Cropping 277
8. Assembly 280
9. Die Bonding/Wire Bonding 281

Other 281

1. Under Operation of Equipment 281
2. Other 282

Rating 283

1. Operating Temperature 283
2. Atmosphere Surroundings (gaseous and liquid) 283
3. Piezo-electric Phenomenon 283

Soldering and Mounting 283

1. PCB Design 283
1. Notice for Pattern Forms 283
2. Land Dimensions 284
3. Board Design 288
2. Adhesive Application 288
3. Adhesive Curing 289
4. Flux for Flow Soldering 289
5. Flow Soldering 289
6. Reflow Soldering 289
7. Washing 290
8. Coating 290

Other 290

1. Transportation 290
2. Characteristics Evaluation in the Actual System 290

- GRM
- GR3
- GRJ
- GR4
- GR7
- GJM
- GQM
- GA2
- GA3 GB
- GA3 GD
- GA3 GF
- LLL
- LLA
- LLM
- LLR
- NFM
- KRM
- KR3
- GMA
- GMD



Caution

Storage and Operation Conditions

1. The performance of chip multilayer ceramic capacitors and chip EMIFIL NFM series (henceforth just “capacitors”) may be affected by the storage conditions.

Please use them promptly after delivery.

1-1. Maintain appropriate storage for the capacitors using the following conditions: Room Temperature of +5 to +40°C and a Relative Humidity of 20 to 70%.

High temperature and humidity conditions and/or prolonged storage may cause deterioration of the packaging materials. If more than six months have elapsed since delivery, check packaging, mounting, etc. before use.

In addition, this may cause oxidation of the electrodes. If more than one year has elapsed since delivery, also check the solderability before use.

1-2. Corrosive gas can react with the termination (external) electrodes or lead wires of capacitors, and result in poor solderability. Do not store the capacitors in an atmosphere consisting of corrosive gas (e.g., hydrogen sulfide, sulfur dioxide, chlorine, ammonia gas, etc.).

1-3. Due to moisture condensation caused by rapid humidity changes, or the photochemical change caused by direct sunlight on the terminal electrodes and/or the resin/epoxy coatings, the solderability and electrical performance may deteriorate. Do not store capacitors under direct sunlight or in high humidity conditions.

Rating

1. Temperature Dependent Characteristics

1. The electrical characteristics of a capacitor can change with temperature.

1-1. For capacitors having larger temperature dependency, the capacitance may change with temperature changes.

The following actions are recommended in order to ensure suitable capacitance values.

(1) Select a suitable capacitance for the operating temperature range.

(2) The capacitance may change within the rated temperature.

When you use a high dielectric constant type capacitor in a circuit that needs a tight (narrow) capacitance tolerance (e.g., a time-constant circuit), please carefully consider the temperature characteristics, and carefully confirm the various characteristics in actual use conditions and the actual system.

[Example of Temperature Characteristics X7R (R7)]
 Sample: 0.1μF, Rated Voltage 50VDC

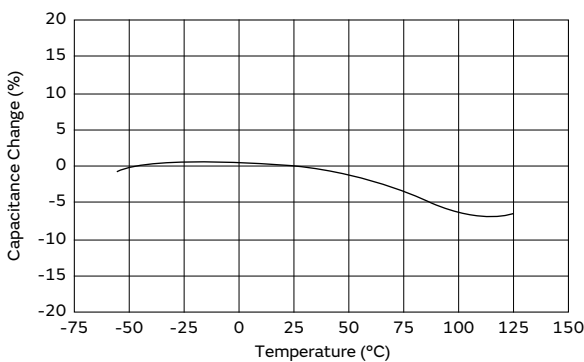

[Example of Temperature Characteristics X5R (R6)]
 Sample: 22μF, Rated Voltage 4VDC

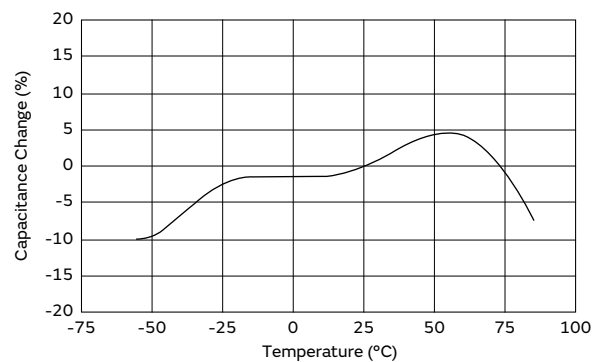

2. Measurement of Capacitance

1. Measure capacitance with the voltage and frequency specified in the product specifications.

1-1. The output voltage of the measuring equipment may decrease occasionally when capacitance is high. Please confirm whether a prescribed measured voltage is impressed to the capacitor.

1-2. The capacitance values of high dielectric constant type capacitors change depending on the AC voltage applied. Please consider the AC voltage characteristics when selecting a capacitor to be used in an AC circuit.

Continued on the following page. ↗

⚠Caution

Continued from the preceding page. ↘

3. Applied Voltage and Applied Current

1. Do not apply a voltage to the capacitor that exceeds the rated voltage as called out in the specifications.
 - 1-1. Applied voltage between the terminals of a capacitor shall be less than or equal to the rated voltage.
 - (1) When AC voltage is superimposed on DC voltage, the zero-to-peak voltage shall not exceed the rated DC voltage.
 When AC voltage or pulse voltage is applied, the peak-to-peak voltage shall not exceed the rated DC voltage.
 - (2) Abnormal voltages (surge voltage, static electricity, pulse voltage, etc.) shall not exceed the rated DC voltage.

Typical Voltage Applied to the DC Capacitor



(E: Maximum possible applied voltage.)

- 1-2. Influence of over voltage
 Over voltage that is applied to the capacitor may result in an electrical short circuit caused by the breakdown of the internal dielectric layers. The time duration until breakdown depends on the applied voltage and the ambient temperature.
2. Use a safety standard certified capacitor in a power supply input circuit (AC filter), as it is also necessary to consider the withstand voltage and impulse withstand voltage defined for each device.

4. Type of Applied Voltage and Self-heating Temperature

1. Confirm the operating conditions to make sure that no large current is flowing into the capacitor due to the continuous application of an AC voltage or pulse voltage.
 When a DC rated voltage product is used in an AC voltage circuit or a pulse voltage circuit, the AC current or pulse current will flow into the capacitor; therefore check the self-heating condition.
 Please confirm the surface temperature of the capacitor so that the temperature remains within the upper limits of the operating temperature, including the rise in temperature due to self-heating. When the capacitor is used with a high-frequency voltage or pulse voltage, heat may be generated by dielectric loss.
<Applicable to Rated Voltage of less than 100VDC>
 - 1-1. The load should be contained so that the self-heating of the capacitor body remains below 20°C, when measuring at an ambient temperature of 25°C.

<Applicable to NFM Series>

3. The capacitors also have rated currents.
 The current flowing between the terminals of a capacitor shall be less than or equal to the rated current. Using the capacitor beyond this range could lead to excessive heat.



Continued on the following page. ↗

⚠Caution

Continued from the preceding page. ↘

<Applicable to Temperature Characteristics X7R (R7), X7T (D7), X7T (W0) beyond Rated Voltage of 200VDC>

1-2. The load should be contained so that the self-heating of the capacitor body remains below 20°C, when measuring at an ambient temperature of 25°C. In addition, use a K thermocouple of $\phi 0.1\text{mm}$ with less heat capacity when measuring, and measure in a condition where there is no effect from the radiant heat of other components or air flow caused by convection. Excessive generation of heat may cause deterioration of the characteristics and reliability of the capacitor. (Absolutely do not perform measurements while the cooling fan is operating, as an accurate measurement may not be performed.)

<Applicable to Temperature Characteristics U2J (7U), COG (5C) beyond Rated Voltage of 200VDC>

1-3. Since the self-heating is low in the low loss series, the allowable power becomes extremely high compared to the common X7R (R7) characteristics. However, when a load with self-heating of 20°C is applied at the rated voltage, the allowable power may be exceeded. When the capacitor is used in a high-frequency voltage circuit of 1kHz or more, the frequency of the applied voltage should be less than 500kHz sine wave (less than 100kHz for a product with rated voltage of DC3.15kV), to limit the voltage load so that the load remains within the derating shown in the following figure. In the case of non-sine wave, high-frequency components exceeding the fundamental frequency may be included. In such a case, please contact Murata. The excessive generation of heat may cause deterioration of the characteristics and reliability of the capacitor. (Absolutely do not perform measurements while the cooling fan is operating, as an accurate measurement may not be performed.)

[The sine-wave frequency VS allowable voltage]

The surface temperature of the capacitor: 125°C or less (including self-heating)

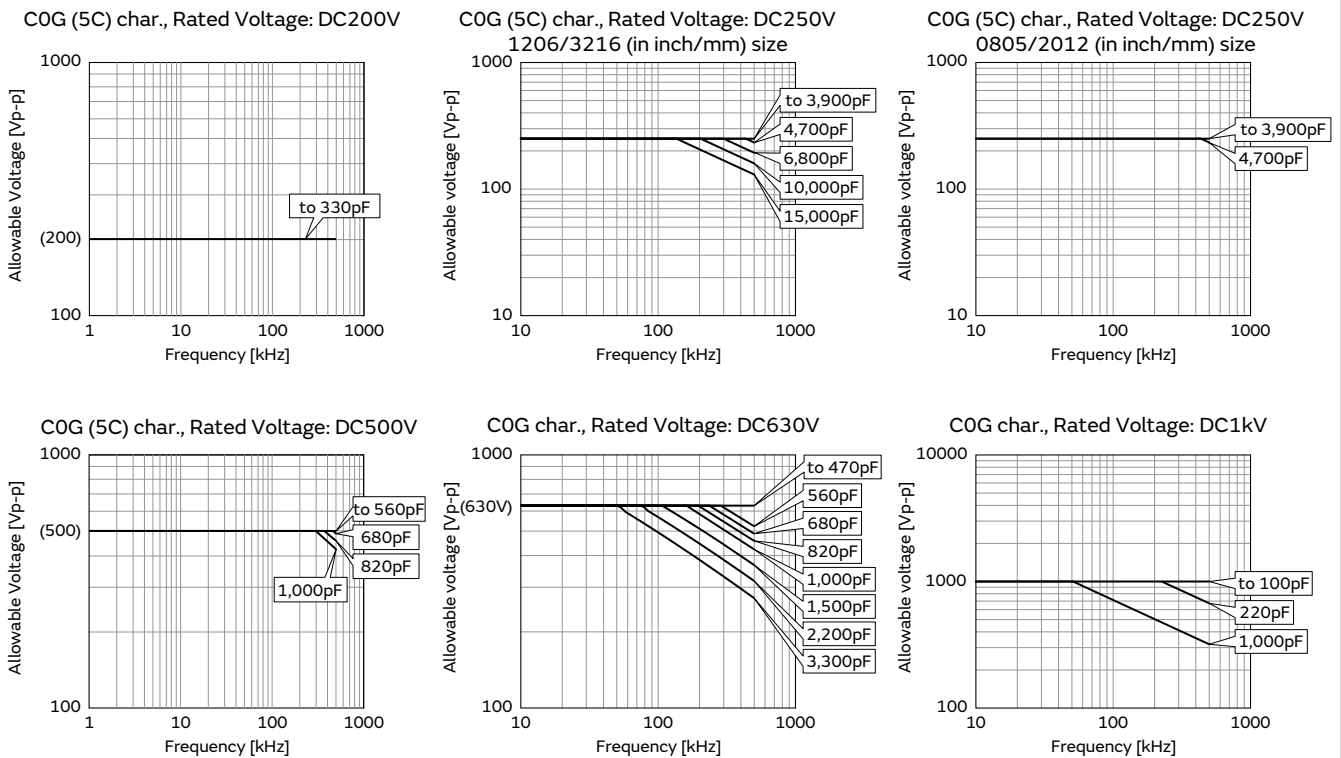

Continued on the following page. ↗

GRM
 GR3
 GRJ
 GR4
 GR7
 GJM
 GQM
 GA2
 GA3 GB
 GA3 GD
 GA3 GF
 LLL
 LLA
 LLM
 LLR
 NFM
 KRM
 KR3
 GMA
 GMD
 ⚠Caution

⚠Caution

Continued from the preceding page. ↘

[The sine-wave frequency VS allowable voltage]

The surface temperature of the capacitor: 125°C or less
 (including self-heating)



Continued on the following page. ↗

- GRM
- GR3
- GRJ
- GR4
- GR7
- GJM
- GQM
- GA2
- GA3 GB
- GA3 GD
- GA3 GF
- LLL
- LLA
- LLM
- LLR
- NFM
- KRM
- KR3
- GMA
- GMD
- ⚠Caution

⚠Caution

Continued from the preceding page. ↘

5. DC Voltage and AC Voltage Characteristics

1. The capacitance value of a high dielectric constant type capacitor changes depending on the DC voltage applied. Please consider the DC voltage characteristics when a capacitor is selected for use in a DC circuit.

1-1. The capacitance of ceramic capacitors may change sharply depending on the applied voltage (see figure). Please confirm the following in order to secure the capacitance.

- (1) Determine whether the capacitance change caused by the applied voltage is within the allowed range.
- (2) In the DC voltage characteristics, the rate of capacitance change becomes larger as voltage increases, even if the applied voltage is below the rated voltage. When a high dielectric constant type capacitor is used in a circuit that requires a tight (narrow) capacitance tolerance (e.g., a time constant circuit), please carefully consider the voltage characteristics, and confirm the various characteristics in the actual operating conditions of the system.

2. The capacitance values of high dielectric constant type capacitors changes depending on the AC voltage applied. Please consider the AC voltage characteristics when selecting a capacitor to be used in an AC circuit.

6. Capacitance Aging

1. The high dielectric constant type capacitors have an Aging characteristic in which the capacitance value decreases with the passage of time. When you use high dielectric constant type capacitors in a circuit that needs a tight (narrow) capacitance tolerance (e.g., a time-constant circuit), please carefully consider the characteristics of these capacitors, such as their aging, voltage, and temperature characteristics. In addition, check capacitors using your actual appliances at the intended environment and operating conditions.

[Example of DC Voltage Characteristics]
 Sample: X7R (R7) Characteristics 0.1μF,
 Rated Voltage 50VDC

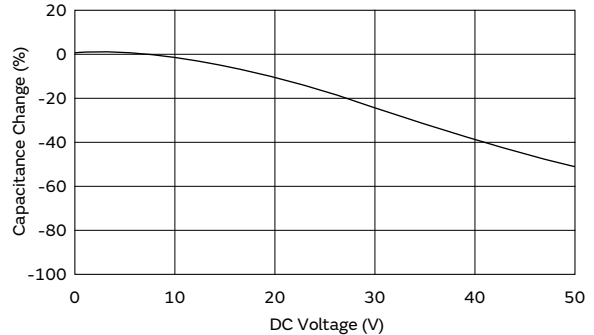

[Example of AC Voltage Characteristics]
 Sample: X7R (R7) Characteristics 10μF,
 Rated Voltage 6.3VDC

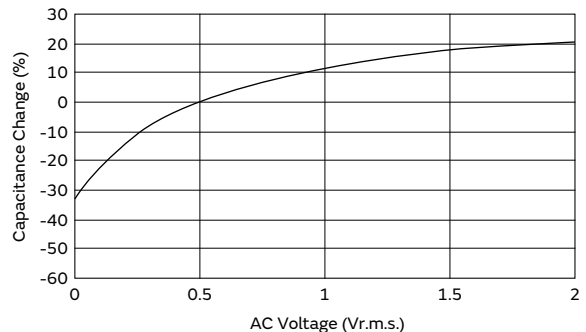

[Example of Change Over Time (Aging Characteristics)]

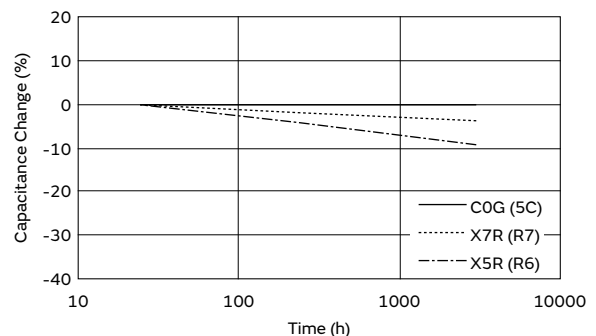

Continued on the following page. ↗

GRM

GR3

GRJ

GR4

GR7

GJM

GQM

GA2

GA3
GB

GA3
GD

GA3
GF

LLL

LLA

LLM

LLR

NFM

KRM

KR3

GMA

GMD

⚠Caution

⚠Caution

Continued from the preceding page. ↘

7. Vibration and Shock

1. Please confirm the kind of vibration and/or shock, its condition, and any generation of resonance.
 Please mount the capacitor so as not to generate resonance, and do not allow any impact on the terminals.
2. Mechanical shock due to being dropped may cause damage or a crack in the dielectric material of the capacitor.
 Do not use a dropped capacitor because the quality and reliability may be deteriorated.
3. When printed circuit boards are piled up or handled, the corner of another printed circuit board should not be allowed to hit the capacitor, in order to avoid a crack or other damage to the capacitor.

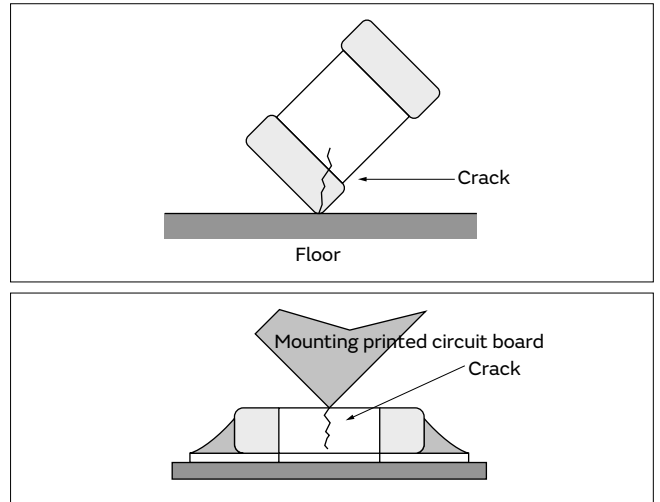

Soldering and Mounting

1. Mounting Position

1. Confirm the best mounting position and direction that minimizes the stress imposed on the capacitor during flexing or bending the printed circuit board.
 - 1-1. Choose a mounting position that minimizes the stress imposed on the chip during flexing or bending of the board.

<Applicable to NFM Series>

2. If you mount the capacitor near components that generate heat, take note of the heat from the other components and carefully check the self-heating of the capacitor before using.
 If there is significant heat radiation from other components, it could lower the insulation resistance of the capacitor or produce excessive heat.

[Component Direction]

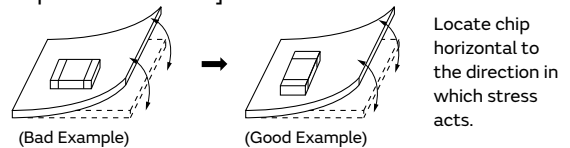

[Chip Mounting Close to Board Separation Point]

It is effective to implement the following measures, to reduce stress in separating the board.

It is best to implement all of the following three measures; however, implement as many measures as possible to reduce stress.

| Contents of Measures | Stress Level |
|--|--------------|
| (1) Turn the mounting direction of the component parallel to the board separation surface. | A > D *1 |
| (2) Add slits in the board separation part. | A > B |
| (3) Keep the mounting position of the component away from the board separation surface. | A > C |

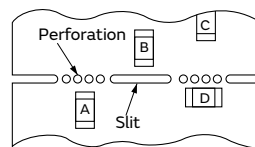

*1 A > D is valid when stress is added vertically to the perforation as with Hand Separation.
 If a Cutting Disc is used, stress will be diagonal to the PCB, therefore A > D is invalid.

[Mounting Capacitors Near Screw Holes]

When a capacitor is mounted near a screw hole, it may be affected by the board deflection that occurs during the tightening of the screw. Mount the capacitor in a position as far away from the screw holes as possible.

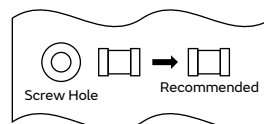

Continued on the following page. ↗

GRM
 GR3
 GRJ
 GR4
 GR7
 GJM
 GQM
 GA2
 GA3 GB
 GA3 GD
 GA3 GF
 LLL
 LLA
 LLM
 LLR
 NFM
 KPM
 KR3
 GMA
 GMD
 ⚠Caution

⚠Caution

Continued from the preceding page. ↘

2. Information before Mounting

1. Do not re-use capacitors that were removed from the equipment.
2. Confirm capacitance characteristics under actual applied voltage.
3. Confirm the mechanical stress under actual process and equipment use.
4. Confirm the rated capacitance, rated voltage and other electrical characteristics before assembly.
5. Prior to use, confirm the solderability of capacitors that were in long-term storage.
6. Prior to measuring capacitance, carry out a heat treatment for capacitors that were in long-term storage.
7. The use of Sn-Zn based solder will deteriorate the reliability of the MLCC.
Please contact our sales representative or product engineers on the use of Sn-Zn based solder in advance.
8. We have also produced a DVD which shows a summary of our recommendations, regarding the precautions for mounting. Please contact our sales representative to request the DVD.

3. Maintenance of the Mounting (pick and place) Machine

1. Make sure that the following excessive forces are not applied to the capacitors. Check the mounting in the actual device under actual use conditions ahead of time.
 - 1-1. In mounting the capacitors on the printed circuit board, any bending force against them shall be kept to a minimum to prevent them from any damage or cracking. Please take into account the following precautions and recommendations for use in your process.
 - (1) Adjust the lowest position of the pickup nozzle so as not to bend the printed circuit board.
2. Dirt particles and dust accumulated in the suction nozzle and suction mechanism prevent the nozzle from moving smoothly. This creates excessive force on the capacitor during mounting, causing cracked chips. Also, the locating claw, when worn out, imposes uneven forces on the chip when positioning, causing cracked chips. The suction nozzle and the locating claw must be maintained, checked, and replaced periodically.

<Applicable to ZRB Series>

3. To adjust the inspection tolerance for automated appearance sorting machine of mounting position, because ZRB series are easier to shift the mounting position than standard MLCC.
4. To check the overturn and reverse of chip.
5. To control mounting speed carefully, because ZRB series is heavier than standard MLCC.



Continued on the following page. ↗

⚠Caution

Continued from the preceding page. ↘

4-1. Reflow Soldering

1. When sudden heat is applied to the components, the mechanical strength of the components will decrease because a sudden temperature change causes deformation inside the components. In order to prevent mechanical damage to the components, preheating is required for both the components and the PCB. Preheating conditions are shown in table 1. It is required to keep the temperature differential between the solder and the components surface (ΔT) as small as possible.
2. When components are immersed in solvent after mounting, be sure to maintain the temperature difference (ΔT) between the component and the solvent within the range shown in table 1.

Table 1

| Series | Chip Dimension Code (L/W) | Temperature Differential |
|-------------------------------------|---------------------------|-----------------------------------|
| GRM/GJM/GQM/GR3/GRJ/KRM/LLR/NFM/GR7 | 02/03/15/18/21/31 | $\Delta T \leq 190^\circ\text{C}$ |
| LLL | 02/03/15/18/1U/21/31 | |
| ZRB | 15/18 | |
| GR3/GRJ/GRM/KR3/KRM GA2/GA3/GR4 | 32/42/43/52/55 | $\Delta T \leq 130^\circ\text{C}$ |
| LLA/LLM | 18/21/31 | |
| GQM | 22 | |

Recommended Conditions

| | Pb-Sn Solder | Lead Free Solder |
|------------------|--------------|-----------------------|
| Peak Temperature | 230 to 250°C | 240 to 260°C |
| Atmosphere | Air | Air or N ₂ |

Pb-Sn Solder: Sn-37Pb
 Lead Free Solder: Sn-3.0Ag-0.5Cu

3. When a capacitor is mounted at a temperature lower than the peak reflow temperature recommended by the solder manufacturer, the following quality problems can occur. Consider factors such as the placement of peripheral components and the reflow temperature setting to prevent the capacitor's reflow temperature from dropping below the peak temperature specified. Be sure to evaluate the mounting situation beforehand and verify that none of the following problems occur.
 - Drop in solder wettability
 - Solder voids
 - Possible occurrence of whiskering
 - Drop in bonding strength
 - Drop in self-alignment properties
 - Possible occurrence of tombstones and/or shifting on the land patterns of the circuit board

[Example of Temperature Conditions for Reflow Soldering]

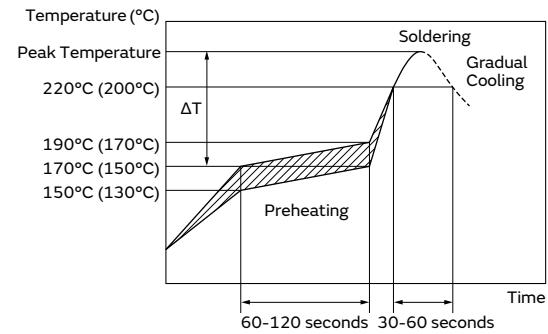

[Allowable Reflow Soldering Temperature and Time]

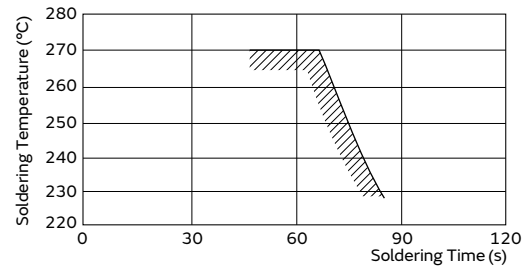

In the case of repeated soldering, the accumulated soldering time must be within the range shown above.

Continued on the following page. ↗

GRM
 GR3
 GRJ
 GR4
 GR7
 GJM
 GQM
 GA2
 GA3 GB
 GA3 GD
 GA3 GF
 LLL
 LLA
 LLM
 LLR
 NFM
 KRM
 KR3
 GMA
 GMD
 ⚠Caution

Caution

Continued from the preceding page. ↘

4. Optimum Solder Amount for Reflow Soldering

- 4-1. Overly thick application of solder paste results in a excessive solder fillet height.
 This makes the chip more susceptible to mechanical and thermal stress on the board and may cause the chips to crack.
- 4-2. Too little solder paste results in a lack of adhesive strength on the termination, which may result in chips breaking loose from the PCB.
- 4-3. Please confirm that solder has been applied smoothly to the termination.

<Applicable to NFM Series>

[Guideline of solder paste thickness]
 100-150μm: NFM15/18/21/3D/31
 100-200μm: NFM41

NFM15CC/15PC



NFM18CC/18PC



NFM18PS

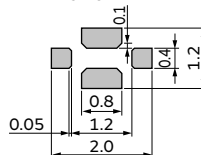

NFM21CC/21PC

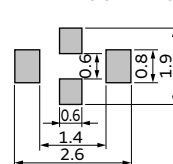

NFM21PS

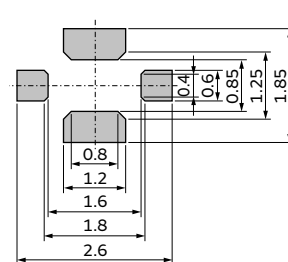

NFM3DCC/3DPC

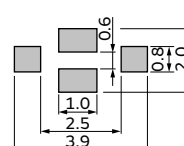

NFM31PC/31KC

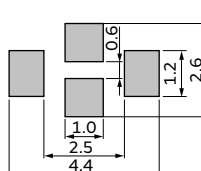

NFM41CC/41PC

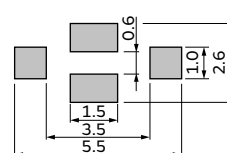

Inverting the PCB

Make sure not to impose any abnormal mechanical shocks to the PCB.

Continued on the following page. ↗

- GRM
- GR3
- GRJ
- GR4
- GR7
- GJM
- GQM
- GA2
- GA3 GB
- GA3 GD
- GA3 GF
- LLL
- LLA
- LLM
- LLR
- NFM
- KRM
- KR3
- GMA
- GMD
- Caution

Caution

Continued from the preceding page. ↘

4-2. Flow Soldering

1. Do not apply flow soldering to chips not listed in table 2.

Table 2

| Series | Chip Dimension Code (L/W) | Temperature Differential |
|---------|---------------------------|-----------------------------------|
| GR3/GRM | 18/21/31 | $\Delta T \leq 150^\circ\text{C}$ |
| GQM | 18/21 | |
| LLL | 21/31 | |
| GRJ | 18/21/31 | |
| NFM | 3D/31/41 | |

- When sudden heat is applied to the components, the mechanical strength of the components will decrease because a sudden temperature change causes deformation inside the components. In order to prevent mechanical damage to the components, preheating is required for both of the components and the PCB. Preheating conditions are shown in table 2. It is required to keep the temperature differential between the solder and the components surface (ΔT) as low as possible.
- Excessively long soldering time or high soldering temperature can result in leaching of the terminations, causing poor adhesion or a reduction in capacitance value due to loss of contact between the inner electrodes and terminations.
- When components are immersed in solvent after mounting, be sure to maintain the temperature differential (ΔT) between the component and solvent within the range shown in the table 2.

Recommended Conditions

| | Pb-Sn Solder | Lead Free Solder |
|-----------------------------|--------------|------------------------------------|
| Preheating Peak Temperature | 90 to 110°C | 100 to 120°C 140 to 160°C (NFM) |
| Soldering Peak Temperature | 240 to 250°C | 250 to 260°C |
| Atmosphere | Air | Air or N ₂ |

Pb-Sn Solder: Sn-37Pb

Lead Free Solder: Sn-3.0Ag-0.5Cu

5. Optimum Solder Amount for Flow Soldering

- The top of the solder fillet should be lower than the thickness of the components. If the solder amount is excessive, the risk of cracking is higher during board bending or any other stressful condition.

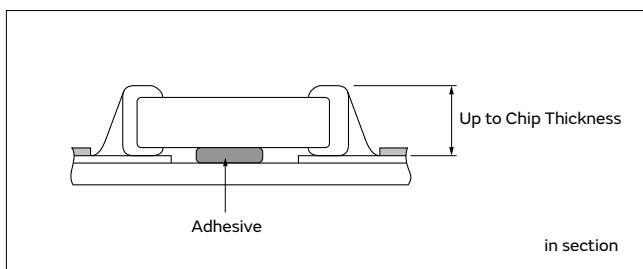

[Example of Temperature Conditions for Flow Soldering]

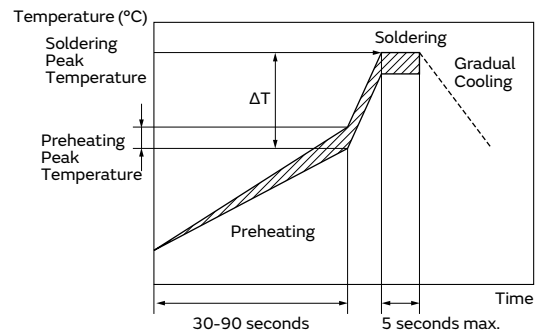

[Allowable Flow Soldering Temperature and Time]

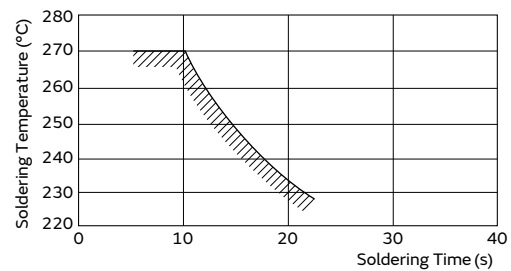

In the case of repeated soldering, the accumulated soldering time must be within the range shown above.

Continued on the following page. ↗

GRM
 GR3
 GRJ
 GR4
 GR7
 GJM
 GQM
 GA2
 GA3 GB
 GA3 GD
 GA3 GF
 LLL
 LLA
 LLM
 LLR
 NFM
 KRM
 KR3
 GMA
 GMD
 △Caution

⚠Caution

Continued from the preceding page. ↘

4-3. Correction of Soldered Portion

When sudden heat is applied to the capacitor, distortion caused by the large temperature difference occurs internally, and can be the cause of cracks. Capacitors also tend to be affected by mechanical and thermal stress depending on the board preheating temperature or the soldering fillet shape, and can be the cause of cracks. Please refer to "1. PCB Design" or "3. Optimum solder amount" for the solder amount and the fillet shapes.

Do not correct with a soldering iron for ZRB series.
 Correction with a soldering iron for ZRB series may cause loss suppress acoustic noise, because the solder amount become excessive.

1. Correction with a Soldering Iron

- 1-1. In order to reduce damage to the capacitor, be sure to preheat the capacitor and the mounting board. Preheat to the temperature range shown in Table 3. A hot plate, hot air type preheater, etc. can be used for preheating.
- 1-2. After soldering, do not allow the component/PCB to cool down rapidly.
- 1-3. Perform the corrections with a soldering iron as quickly as possible. If the soldering iron is applied too long, there is a possibility of causing solder leaching on the terminal electrodes, which will cause deterioration of the adhesive strength and other problems.

Table 3

| Series | Chip Dimension Code (L/W) | Temperature of Soldering Iron Tip | Preheating Temperature | Temperature Differential (ΔT) | Atmosphere |
|-------------------------|---------------------------|-----------------------------------|------------------------|---|------------|
| GJM/GQM/GR3/GRJ/GRM/GR7 | 03/15/18/21/31 | 350°C max. | 150°C min. | $\Delta T \leq 190^\circ\text{C}$ | Air |
| GRJ/GRM/GR4/GA2/GA3 | 32/42/43/52/55 | 280°C max. | 150°C min. | $\Delta T \leq 130^\circ\text{C}$ | Air |
| GQM | 22 | | | | |
| NFM | 3D/41 | 350°C max. | 150°C min. | $\Delta T \leq 190^\circ\text{C}$ | Air |
| | 15 | 340°C max. | | | |

*Applicable for both Pb-Sn and Lead Free Solder.
 Pb-Sn Solder: Sn-37Pb
 Lead Free Solder: Sn-3.0Ag-0.5Cu
 *Please manage ΔT in the temperature of soldering iron and the preheating temperature.

2. Correction with Spot Heater

Compared to local heating with a soldering iron, hot air heating by a spot heater heats the overall component and board, therefore, it tends to lessen the thermal shock. In the case of a high density mounted board, a spot heater can also prevent concerns of the soldering iron making direct contact with the component.

2-1. If the distance from the hot air outlet of the spot heater to the component is too close, cracks may occur due to thermal shock. To prevent this problem, follow the conditions shown in Table 4.

2-2. In order to create an appropriate solder fillet shape, it is recommended that hot air be applied at the angle shown in Figure 1.

Table 4

| | |
|-----------------------------------|--|
| Distance | 5mm or more |
| Hot Air Application Angle | 45° *Figure 1 |
| Hot Air Temperature Nozzle Outlet | 400°C max. |
| Application Time | Less than 10 seconds (1206 (3216M) size or smaller) |
| | Less than 30 seconds (1210 (3225M) size or larger) |

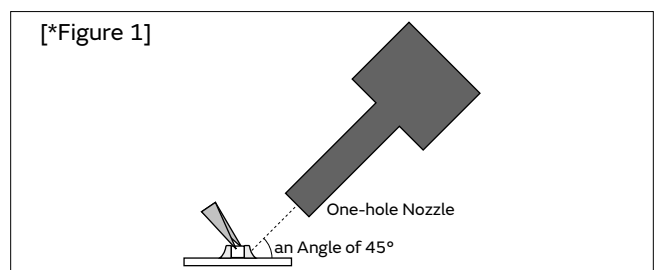

3. Optimum solder amount when re-working with a soldering iron

3-1. If the solder amount is excessive, the risk of cracking is higher during board bending or any other stressful condition.
 Too little solder amount results in a lack of adhesive strength on the termination, which may result in chips breaking loose from the PCB.
 Please confirm that solder has been applied smoothly and rising to the end surface of the chip.

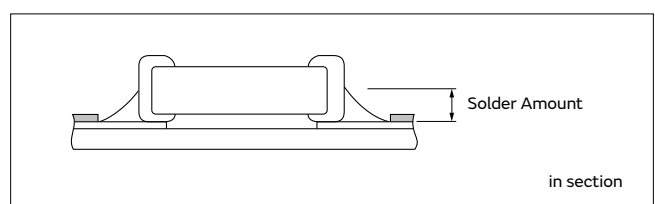

Continued on the following page. ↗

Caution

Continued from the preceding page. ↘

- 3-2. A soldering iron with a tip of $\phi 3\text{mm}$ or smaller should be used. It is also necessary to keep the soldering iron from touching the components during the re-work.
- 3-3. Solder wire with $\phi 0.5\text{mm}$ or smaller is required for soldering.

<Applicable to KR3/KRM Series>

4. For the shape of the soldering iron tip, refer to the figure on the right.

Regarding the type of solder, use a wire diameter of $\phi 0.5\text{mm}$ or less (rosin core wire solder).

4-1. How to Apply the Soldering Iron

Apply the tip of the soldering iron against the lower end of the metal terminal.

- 1) In order to prevent cracking caused by sudden heating of the ceramic device, do not touch the ceramic base directly.
- 2) In order to prevent deviations and dislocating of the chip, do not touch the junction of the chip and the metal terminal, and the metal portion on the outside directly.

4-2. Appropriate Amount of Solder

The amount of solder for corrections by soldering iron, should be lower than the height of the lower side of the chip.



5. Washing

Excessive ultrasonic oscillation during cleaning can cause the PCBs to resonate, resulting in cracked chips or broken solder joints. Before starting your production process, test your cleaning equipment/process to insure it does not degrade the capacitors.

6. Electrical Test on Printed Circuit Board

1. Confirm position of the support pin or specific jig, when inspecting the electrical performance of a capacitor after mounting on the printed circuit board.

1-1. Avoid bending the printed circuit board by the pressure of a test-probe, etc.

The thrusting force of the test probe can flex the PCB, resulting in cracked chips or open solder joints. Provide support pins on the back side of the PCB to prevent warping or flexing. Install support pins as close to the test-probe as possible.

1-2. Avoid vibration of the board by shock when a test-probe contacts a printed circuit board.

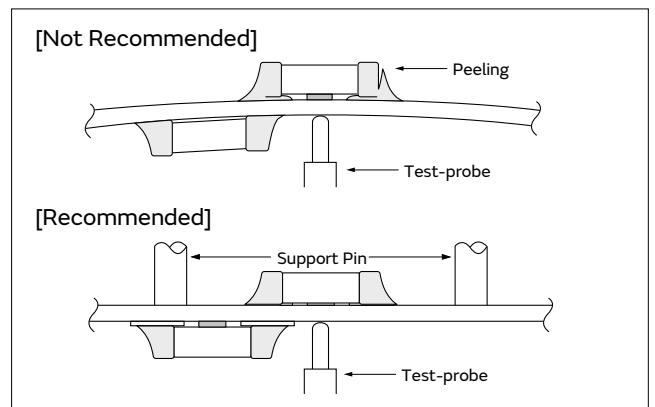

7. Printed Circuit Board Cropping

1. After mounting a capacitor on a printed circuit board, do not apply any stress to the capacitor that causes bending or twisting the board.

- 1-1. In cropping the board, the stress as shown at right may cause the capacitor to crack. Cracked capacitors may cause deterioration of the insulation resistance, and result in a short. Avoid this type of stress to a capacitor.

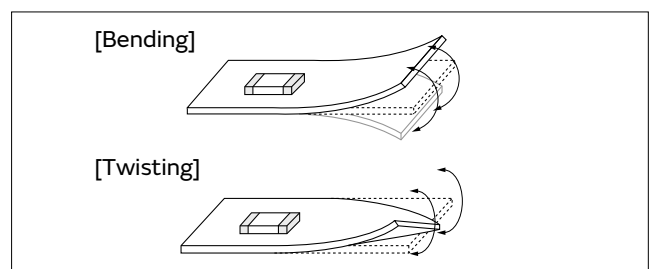

Continued on the following page. ↗

Caution

Continued from the preceding page. ↘

2. Check the cropping method for the printed circuit board in advance.

2-1. Printed circuit board cropping shall be carried out by using a jig or an apparatus (Disc separator, router type separator, etc.) to prevent the mechanical stress that can occur to the board.

| Board Separation Method | Hand Separation Nipper Separation | (1) Board Separation Jig | Board Separation Apparatus | |
|--------------------------|--|---|--|---------------------------|
| | | | (2) Disc Separator | (3) Router Type Separator |
| Level of stress on board | High | Medium | Medium | Low |
| Recommended | × | △* | △* | ○ |
| Notes | Hand and nipper separation apply a high level of stress. Use another method. | <ul style="list-style-type: none"> · Board handling · Board bending direction · Layout of capacitors | <ul style="list-style-type: none"> · Board handling · Layout of slits · Design of V groove · Arrangement of blades · Controlling blade life | Board handling |

* When a board separation jig or disc separator is used, if the following precautions are not observed, a large board deflection stress will occur and the capacitors may crack. Use router type separator if at all possible.

(1) Example of a suitable jig

[In the case of Single-side Mounting]

An outline of the board separation jig is shown as follows. Recommended example: Stress on the component mounting position can be minimized by holding the portion close to the jig, and bend in the direction towards the side where the capacitors are mounted. Not recommended example: The risk of cracks occurring in the capacitors increases due to large stress being applied to the component mounting position, if the portion away from the jig is held and bent in the direction opposite the side where the capacitors are mounted.

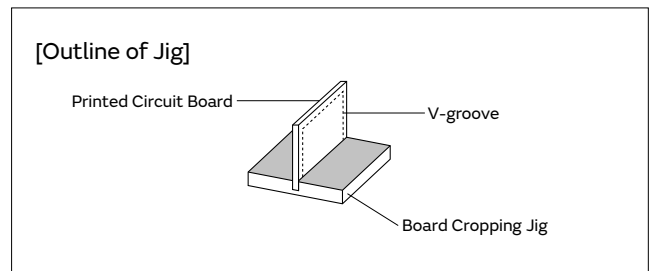

Hand Separation

| Recommended | Not Recommended |
|-------------|-----------------|
| | |

[In the case of Double-sided Mounting]

Since components are mounted on both sides of the board, the risk of cracks occurring can not be avoided with the above method. Therefore, implement the following measures to prevent stress from being applied to the components.

(Measures)

- (1) Consider introducing a router type separator. If it is difficult to introduce a router type separator, implement the following measures. (Refer to item 1. Mounting Position)
- (2) Mount the components parallel to the board separation surface.
- (3) When mounting components near the board separation point, add slits in the separation position near the component.
- (4) Keep the mounting position of the components away from the board separation point.

Continued on the following page. ↗

GRM
GR3
GRJ
GR4
GR7
GJM
GQM
GA2
GA3 GB
GA3 GD
GA3 GF
LLL
LLA
LLM
LLR
NFM
KRM
KR3
GMA
GMD
Caution

⚠Caution

Continued from the preceding page. ↘

(2) Example of a Disc Separator

An outline of a disc separator is shown as follows. As shown in the Principle of Operation, the top blade and bottom blade are aligned with the V-grooves on the printed circuit board to separate the board.

In the following case, board deflection stress will be applied and cause cracks in the capacitors.

- (1) When the adjustment of the top and bottom blades are misaligned, such as deviating in the top-bottom, left-right or front-rear directions
- (2) The angle of the V groove is too low, depth of the V groove is too shallow, or the V groove is misaligned top-bottom

IF V groove is too deep, it is possible to brake when you handle and carry it. Carefully design depth of the V groove with consideration about strength of material of the printed circuit board.

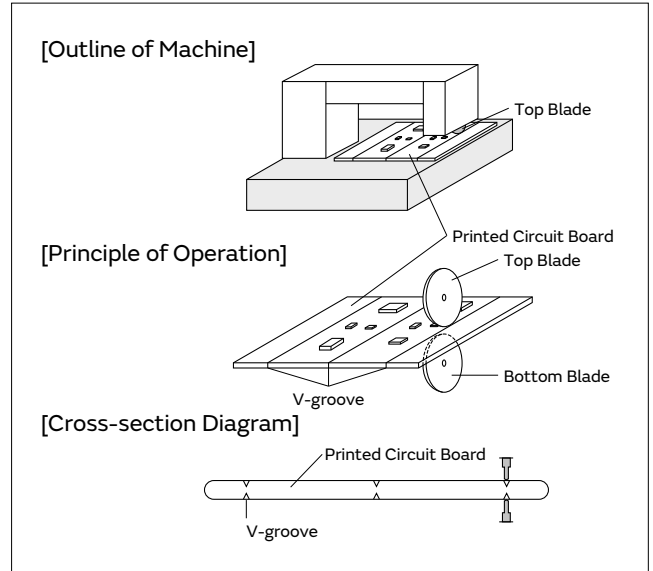

Disc Separator

| Recommended | Not Recommended | | |
|--------------------------------------|--------------------------------------|--------------------------------------|--------------------------------------|
| | Top-bottom Misalignment | Left-right Misalignment | Front-rear Misalignment |
| <p>Top Blade</p> <p>Bottom Blade</p> | <p>Top Blade</p> <p>Bottom Blade</p> | <p>Top Blade</p> <p>Bottom Blade</p> | <p>Top Blade</p> <p>Bottom Blade</p> |

V-groove Design

| Example of Recommended V-groove Design | Not Recommended | | | |
|--|-------------------------|-----------|-------------------|----------------|
| | Left-right Misalignment | Low-Angle | Depth too Shallow | Depth too Deep |
| | | | | |

(3) Example of Router Type Separator

The router type separator performs cutting by a router rotating at a high speed. Since the board does not bend in the cutting process, stress on the board can be suppressed during board separation.

When attaching or removing boards to/from the router type separator, carefully handle the boards to prevent bending.

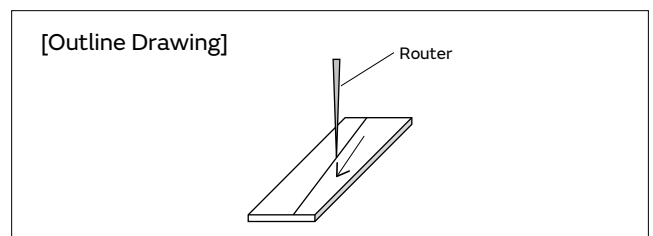

Continued on the following page. ↗

GRM
 GR3
 GRJ
 GR4
 GR7
 GJM
 GQM
 GA2
 GA3 GB
 GA3 GD
 GA3 GF
 LLL
 LLA
 LLM
 LLR
 NFM
 KRM
 KR3
 GMA
 GMD
 ⚠Caution

GRM
GR3
GRJ
GR4
GR7
GJM
GQM
GA2
GA3 GB
GA3 GD
GA3 GF
LLL
LLA
LLM
LLR
NFM
KRM
KR3
GMA
GMD
Caution

⚠Caution

Continued from the preceding page. ↘

8. Assembly

1. Handling

If a board mounted with capacitors is held with one hand, the board may bend. Firmly hold the edges of the board with both hands when handling.

If a board mounted with capacitors is dropped, cracks may occur in the capacitors.

Do not use dropped boards, as there is a possibility that the quality of the capacitors may be impaired.

2. Attachment of Other Components

2-1. Mounting of Other Components

Pay attention to the following items, when mounting other components on the back side of the board after capacitors have been mounted on the opposite side.

When the bottom dead point of the suction nozzle is set too low, board deflection stress may be applied to the capacitors on the back side (bottom side), and cracks may occur in the capacitors.

- After the board is straightened, set the bottom dead point of the nozzle on the upper surface of the board.
- Periodically check and adjust the bottom dead point.

2-2. Inserting Components with Leads into Boards

When inserting components (transformers, IC, etc.) into boards, bending the board may cause cracks in the capacitors or cracks in the solder.

Pay attention to the following.

- Increase the size of the holes to insert the leads, to reduce the stress on the board during insertion.
- Fix the board with support pins or a dedicated jig before insertion.
- Support below the board so that the board does not bend. When using support pins on the board, periodically confirm that there is no difference in the height of each support pin.

2-3. Attaching/Removing Sockets and/or Connectors

Insertion and removal of sockets and connectors, etc., might cause the board to bend. Please insure that the board does not warp during insertion and removal of sockets and connectors, etc., or the bending may damage mounted components on the board.

2-4. Tightening Screws

The board may be bent, when tightening screws, etc. during the attachment of the board to a shield or chassis.

Pay attention to the following items before performing the work.

- Plan the work to prevent the board from bending.
- Use a torque screwdriver, to prevent over-tightening of the screws.
- The board may bend after mounting by reflow soldering, etc. Please note, as stress may be applied to the chips by forcibly flattening the board when tightening the screws.

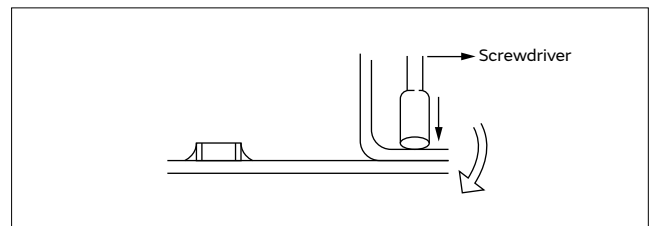
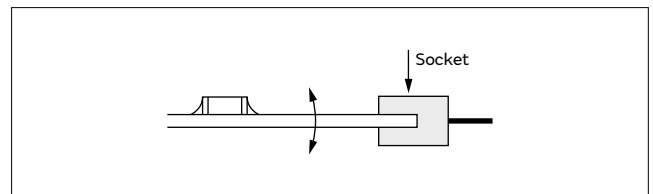
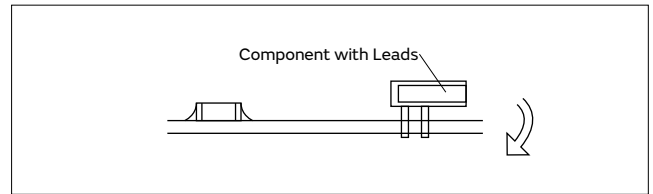
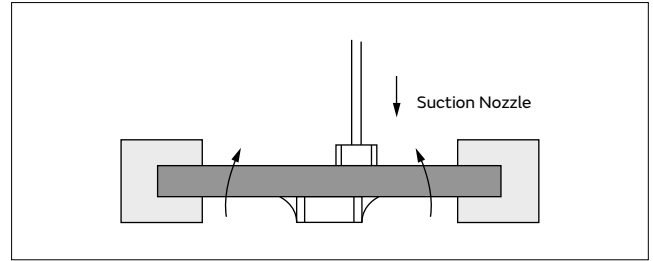

⚠Caution

Continued from the preceding page. ↘

<Applicable to GMA or GMD Series>

9. Die Bonding/Wire Bonding

1. Die Bonding of Capacitors

1-1. Use the following materials for the Brazing alloys:

Au-Sn (80/20) 300 to 320 °C in N₂ atmosphere

1-2. Mounting

- (1) Control the temperature of the substrate so it matches the temperature of the brazing alloy.
- (2) Place the brazing alloy on the substrate and place the capacitor on the alloy. Hold the capacitor and gently apply the load. Be sure to complete the operation within 1 minute.

2. Wire Bonding

2-1. Wire

Gold wire: 25 micro m (0.001 inch) diameter

2-2. Bonding

- (1) Thermo compression, ultrasonic ball bonding.
- (2) Required stage temperature: 150 to 200 °C
- (3) Required wedge or capillary weight: 0.2N to 0.5N
- (4) Bond the capacitor and base substrate or other devices with gold wire.

Other

1. Under Operation of Equipment

- 1-1. Do not touch a capacitor directly with bare hands during operation in order to avoid the danger of an electric shock.
- 1-2. Do not allow the terminals of a capacitor to come in contact with any conductive objects (short-circuit). Do not expose a capacitor to a conductive liquid, including any acid or alkali solutions.
- 1-3. Confirm the environment in which the equipment will operate is under the specified conditions. Do not use the equipment under the following environments.
 - (1) Being splattered with water or oil.
 - (2) Being exposed to direct sunlight.
 - (3) Being exposed to ozone, ultraviolet rays, or radiation.
 - (4) Being exposed to toxic gas (e.g., hydrogen sulfide, sulfur dioxide, chlorine, ammonia gas, etc.)
 - (5) Any vibrations or mechanical shocks exceeding the specified limits.
 - (6) Moisture condensing environments.
- 1-4. Use damp proof countermeasures if using under any conditions that can cause condensation.

Continued on the following page. ↗

GRM

GR3

GRJ

GR4

GR7

GJM

GQM

GA2

GA3
GB

GA3
GD

GA3
GF

LLL

LLA

LLM

LLR

NFM

KRM

KR3

GMA

GMD

⚠Caution

⚠Caution

Continued from the preceding page. ↘

2. Other

2-1. In an Emergency

- (1) If the equipment should generate smoke, fire, or smell, immediately turn off or unplug the equipment.

If the equipment is not turned off or unplugged, the hazards may be worsened by supplying continuous power.

- (2) In this type of situation, do not allow face and hands to come in contact with the capacitor or burns may be caused by the capacitor's high temperature.

2-2. Disposal of Waste

When capacitors are disposed of, they must be burned or buried by an industrial waste vendor with the appropriate licenses.

2-3. Circuit Design

(1) Addition of Fail Safe Function

Capacitors that are cracked by dropping or bending of the board may cause deterioration of the insulation resistance, and result in a short.

If the circuit being used may cause an electrical shock, smoke or fire when a capacitor is shorted, be sure to install fail-safe functions, such as a fuse, to prevent secondary accidents.

- (2) Capacitors used to prevent electromagnetic interference in the primary AC side circuit, or as a connection/insulation, must be a safety standard certified product, or satisfy the contents stipulated in the Electrical Appliance and Material Safety Law. Install a fuse for each line in case of a short.

- (3) The GJM, GMA, GMD, GQM, GR3, GRJ, GRM, KR3, KRM, LLA, LLL, LLM, LLR, NFM and ZRB series are not safety standard certified products.

2-4. Test Condition for AC Withstanding Voltage

(1) Test Equipment

Test equipment for AC withstanding voltage should be made with equipment capable of creating a wave similar to a 50/60Hz sine wave.

(2) Voltage Applied Method

The capacitor's lead or terminal should be firmly connected to the output of the withstanding voltage test equipment, and then the voltage should be raised from near zero to the test voltage.

If the test voltage is applied directly to the capacitor without raising it from near zero, it should be applied with the zero cross. *At the end of the test time, the test voltage should be reduced to near zero, and then capacitor's lead or terminals should be taken off the output of the withstanding voltage test equipment.

If the test voltage applied directly to the capacitor without raising it from near zero, surge voltage may occur and cause a defect.

*ZERO CROSS is the point where voltage sine wave passes 0V. - See the figure at right -

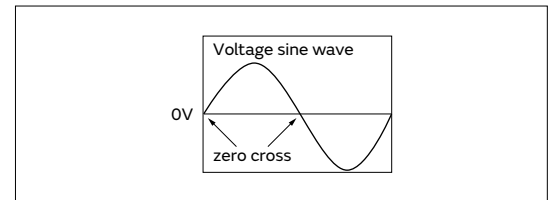

2-5. Remarks

Failure to follow the cautions may result, worst case, in a short circuit and smoking when the product is used.

The above notices are for standard applications and conditions. Contact us when the products are used in special mounting conditions.

Select optimum conditions for operation as they determine the reliability of the product after assembly.

The data herein are given in typical values, not guaranteed ratings.

GRM

GR3

GRJ

GR4

GR7

GJM

GQM

GA2

GA3
GB

GA3
GD

GA3
GF

LLL

LLA

LLM

LLR

NFM

KRM

KR3

GMA

GMD

⚠Caution

Notice

Rating

1. Operating Temperature

1. The operating temperature limit depends on the capacitor.
 - 1-1. Do not apply temperatures exceeding the maximum operating temperature.
It is necessary to select a capacitor with a suitable rated temperature that will cover the operating temperature range.
It is also necessary to consider the temperature distribution in equipment and the seasonal temperature variable factor.
 - 1-2. Consider the self-heating factor of the capacitor.
The surface temperature of the capacitor shall not exceed the maximum operating temperature including self-heating.

2. Atmosphere Surroundings (gaseous and liquid)

1. Restriction on the operating environment of capacitors.
 - 1-1. Capacitors, when used in the above, unsuitable, operating environments may deteriorate due to the corrosion of the terminations and the penetration of moisture into the capacitor.
 - 1-2. The same phenomenon as the above may occur when the electrodes or terminals of the capacitor are subject to moisture condensation.
 - 1-3. The deterioration of characteristics and insulation resistance due to the oxidization or corrosion of terminal electrodes may result in breakdown when the capacitor is exposed to corrosive or volatile gases or solvents for long periods of time.

Soldering and Mounting

1. PCB Design

1. Notice for Pattern Forms
 - 1-1. Unlike leaded components, chip components are susceptible to flexing stresses since they are mounted directly on the substrate.
They are also more sensitive to mechanical and thermal stresses than leaded components.
Excess solder fillet height can multiply these stresses and cause chip cracking. When designing substrates, take land patterns and dimensions into consideration to eliminate the possibility of excess solder fillet height.
 - 1-2. There is a possibility of chip cracking caused by PCB expansion/contraction with heat, because stress on a chip is different depending on PCB material and structure. When the thermal expansion coefficient greatly differs between the board used for mounting and the chip, it will cause cracking of the chip due to the thermal expansion and contraction.
When capacitors are mounted on a fluorine resin printed circuit board or on a single-layered glass epoxy board, it may also cause cracking of the chip for the same reason.

3. Piezo-electric Phenomenon

1. When using high dielectric constant type capacitors in AC or pulse circuits, the capacitor itself vibrates at specific frequencies and noise may be generated.
Moreover, when the mechanical vibration or shock is added to the capacitor, noise may occur.

<Applicable to NFM Series>

- 1-3. Because noise is suppressed by shunting unwanted high-frequency components to the ground, when designing a land for the NFM series, design the ground pattern to be as large as possible in order to better bring out this characteristic.
As shown in the figure below, noise countermeasures can be made more effective by using a via to connect the ground pattern on the chip mounting surface to a larger ground pattern on the inner layer.

Continued on the following page. ↗

Notice

Continued from the preceding page. ↘

Pattern Forms

| | Prohibited | Correct |
|---|--|--|
| Placing Close to Chassis | <p>Chassis Solder (ground) Electrode Pattern</p> <p>in section</p> | <p>Solder Resist</p> <p>in section</p> |
| Placing of Chip Components and Leaded Components | <p>Lead Wire</p> <p>in section</p> | <p>Solder Resist</p> <p>in section</p> |
| Placing of Leaded Components after Chip Component | <p>Soldering Iron Lead Wire</p> <p>in section</p> | <p>Solder Resist</p> <p>in section</p> |
| Lateral Mounting | | <p>Solder Resist</p> |

2. Land Dimensions

2-1. Please refer to the land dimensions in table 1 for flow soldering, table 2 for reflow soldering, table 3 for reflow soldering for ZRB Series, table 4 for reflow soldering for LLA Series, table 5 for reflow soldering for LLM Series.

Please confirm the suitable land dimension by evaluating of the actual SET / PCB.

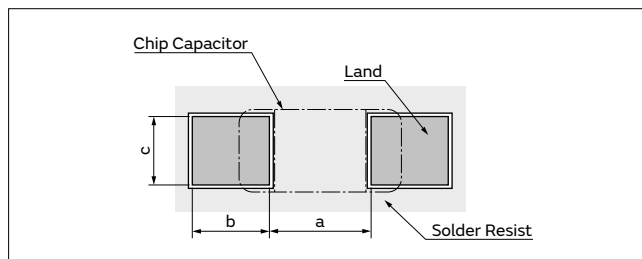

Table 1 Flow Soldering Method

| Series | Chip Dimension Code (L/W) | Chip (L×W) | a | b | c |
|-----------------|---------------------------|------------|------------|------------|------------|
| GQM/GR3/GRJ/GRM | 18 | 1.6×0.8 | 0.6 to 1.0 | 0.8 to 0.9 | 0.6 to 0.8 |
| GQM/GR3/GRJ/GRM | 21 | 2.0×1.25 | 1.0 to 1.2 | 0.9 to 1.0 | 0.8 to 1.1 |
| GR3/GRJ/GRM | 31 | 3.2×1.6 | 2.2 to 2.6 | 1.0 to 1.1 | 1.0 to 1.4 |
| LLL | 21 | 1.25×2.0 | 0.4 to 0.7 | 0.5 to 0.7 | 1.4 to 1.8 |
| LLL | 31 | 1.6×3.2 | 0.6 to 1.0 | 0.8 to 0.9 | 2.6 to 2.8 |

Flow soldering can only be used for products with a chip size from 1.6x0.8mm to 3.2x1.6mm.

(in mm)

Continued on the following page. ↗

Notice

Continued from the preceding page. ↘

Table 2 Reflow Soldering Method

| Series | Chip Dimension Code (L/W) | Chip (L×W) | a | b | c |
|-------------------------|---------------------------|-------------------------|--------------|--------------|--------------|
| GJM/GRM | 02 | 0.4×0.2 | 0.16 to 0.2 | 0.12 to 0.18 | 0.2 to 0.23 |
| GJM/GRM | 03 | 0.6×0.3 (±0.03) | 0.2 to 0.25 | 0.2 to 0.3 | 0.25 to 0.35 |
| | | 0.6×0.3 (±0.05) | 0.2 to 0.25 | 0.25 to 0.35 | 0.3 to 0.4 |
| | | 0.6×0.3 (±0.09) | 0.23 to 0.3 | 0.25 to 0.35 | 0.3 to 0.4 |
| GJM/GRM | 15 | 1.0×0.5 (within ±0.10) | 0.3 to 0.5 | 0.35 to 0.45 | 0.4 to 0.6 |
| | | 1.0×0.5 (±0.15/±0.20) | 0.4 to 0.6 | 0.4 to 0.5 | 0.5 to 0.7 |
| GQM/GR3/GRJ/GRM | 18 | 1.6×0.8 (within ±0.10) | 0.6 to 0.8 | 0.6 to 0.7 | 0.6 to 0.8 |
| | | 1.6×0.8 (±0.15/±0.20) | 0.7 to 0.9 | 0.7 to 0.8 | 0.8 to 1.0 |
| GQM | 21 | 2.0×1.25 | 1.0 to 1.2 | 0.6 to 0.7 | 0.8 to 1.1 |
| GR3/GRJ/GRM/GR7 | 21 | 2.0×1.25 (within ±0.10) | 1.2 | 0.6 | 1.25 |
| | | 2.0×1.25 (±0.15) | 1.2 | 0.6 to 0.8 | 1.2 to 1.4 |
| | | 2.0×1.25 (±0.20) | 1.0 to 1.4 | 0.6 to 0.8 | 1.2 to 1.4 |
| GQM | 22 | 2.8×2.8 | 2.2 to 2.5 | 0.8 to 1.0 | 1.9 to 2.3 |
| GR3/GRJ/GRM/GR7 | 31 | 3.2×1.6 (within ±0.20) | 1.8 to 2.0 | 0.9 to 1.2 | 1.5 to 1.7 |
| | | 3.2×1.6 (±0.30) | 1.9 to 2.1 | 1.0 to 1.3 | 1.7 to 1.9 |
| GR3/GRJ/GRM | 32 | 3.2×2.5 | 2.0 to 2.4 | 1.0 to 1.2 | 1.8 to 2.3 |
| GA2/GA3/GR4 | 42 | 4.5×2.0 | 2.8 to 3.4 | 1.2 to 1.4 | 1.4 to 1.8 |
| GR3/GRJ/GRM/GA2/GA3/GR4 | 43 | 4.5×3.2 | 3.0 to 3.5 | 1.2 to 1.4 | 2.3 to 3.0 |
| GA2/GA3 | 52 | 5.7×2.8 | 4.0 to 4.6 | 1.4 to 1.6 | 2.1 to 2.6 |
| GR3/GRJ/GRM/GA2/GA3/GR4 | 55 | 5.7×5.0 | 4.0 to 4.6 | 1.4 to 1.6 | 3.5 to 4.8 |
| LLL | 15 | 0.5×1.0 | 0.15 to 0.2 | 0.2 to 0.25 | 0.7 to 1.0 |
| LLL | 1U | 0.6×1.0 | 0.20 to 0.25 | 0.25 to 0.35 | 0.7 to 1.0 |
| LLL/LLR | 18 | 0.8×1.6 | 0.2 to 0.3 | 0.3 to 0.4 | 1.4 to 1.6 |
| LLL | 21 | 1.25×2.0 | 0.4 to 0.5 | 0.4 to 0.5 | 1.4 to 1.8 |
| LLL | 31 | 1.6×3.2 | 0.6 to 0.8 | 0.6 to 0.7 | 2.6 to 2.8 |

(in mm)

<Applicable to Part Number KR3/KRM>

| Series | Chip Dimension Code (L/W) | Chip (L×W) | a | b | c |
|---------|---------------------------|------------|------------|------------|------------|
| KRM | 21 | 2.0×1.25 | 1.0 to 1.2 | 0.6 to 0.7 | 0.8 to 1.1 |
| KRM | 31 | 3.2×1.6 | 2.2 to 2.4 | 0.8 to 0.9 | 1.0 to 1.4 |
| KR3/KRM | 55 | 5.7×5.0 | 2.6 | 2.7 | 5.6 |

(in mm)

Table 3 ZRB Series Reflow Soldering Method

| Series | Chip Dimension Code (L/W) | Chip (L×W) | a | b | c |
|--------|---------------------------|------------|------------|------------|------------|
| ZRB | 15 | 1.0×0.5 | 0.4 to 0.6 | 0.4 to 0.5 | 0.5 to 0.7 |
| ZRB | 18* | 1.6×0.8 | 0.7 to 0.9 | 0.7 to 0.8 | 0.8 to 1.0 |

*If distance between parts is too short, there is risk to cause electrical short. Please confirm the mounting pitch (distance between centers of parts) has 1.275mm or more. (ZRB18 only)

[Land for ZRB Series]

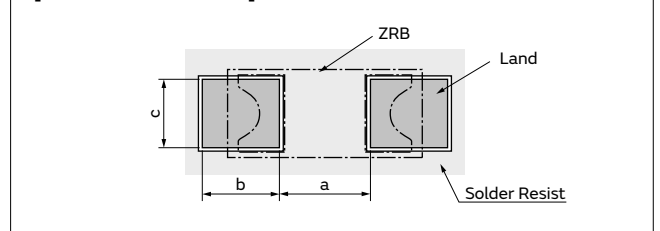

Table 4 LLA Series Reflow Soldering Method

| Series | Chip Dimension Code (L/W) | Chip (L×W) | a | b | c | p |
|--------|---------------------------|------------|------------|--------------|--------------|-----|
| LLA | 18 | 1.6×0.8 | 0.3 to 0.4 | 0.25 to 0.35 | 0.15 to 0.25 | 0.4 |
| LLA | 21 | 2.0×1.25 | 0.5 to 0.7 | 0.35 to 0.6 | 0.2 to 0.3 | 0.5 |

(in mm)

Continued on the following page. ↗

Notice

Continued from the preceding page. ↘

Table 5 LLM Series Reflow Soldering Method

| Series | Chip Dimension Code (L/W) | Chip (L×W) | a | b, b' | c, c' | d | e | f | p |
|--------|---------------------------|------------|------------|--------------|-------|------------|------------|------------|-----|
| LLM | 21 | 2.0×1.25 | 0.6 to 0.8 | (0.3 to 0.5) | 0.3 | 2.0 to 2.6 | 1.3 to 1.8 | 1.4 to 1.6 | 0.5 |

$b=(c-e)/2, b'=(d-f)/2$ (in mm)

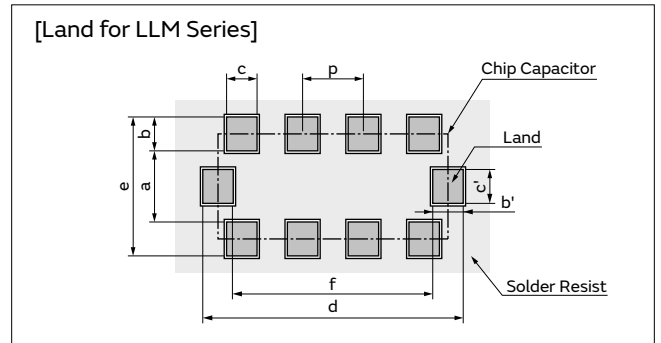
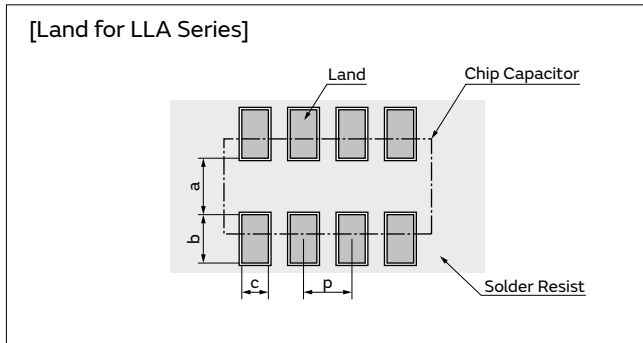

<Applicable to beyond Rated Voltage of 200VDC>

2-2. Dimensions of Slit (Example)

Preparing the slit helps flux cleaning and resin coating on the back of the capacitor.

However, the length of the slit design should be as short as possible to prevent mechanical damage in the capacitor.

A longer slit design might receive more severe mechanical stress from the PCB.

Recommended slit design is shown in the Table.

The diagram shows a side view of a chip capacitor with a slit. The slit is a narrow opening in the top surface. Dimensions are labeled: 'd' is the width of the slit; 'e' is the depth of the slit; 'L' is the length of the capacitor; 'W' is the width of the capacitor. Labels include 'Chip Capacitor', 'Slit', 'Solder Resist', and 'Land'.

| L×W | d | e |
|----------|------------|------------|
| 1.6×0.8 | - | - |
| 2.0×1.25 | - | - |
| 3.2×1.6 | 1.0 to 2.0 | 3.2 to 3.7 |
| 3.2×2.5 | 1.0 to 2.0 | 4.1 to 4.6 |
| 4.5×2.0 | 1.0 to 2.8 | 3.6 to 4.1 |
| 4.5×3.2 | 1.0 to 2.8 | 4.8 to 5.3 |
| 5.7×2.8 | 1.0 to 4.0 | 4.4 to 4.9 |
| 5.7×5.0 | 1.0 to 4.0 | 6.6 to 7.1 |

(in mm)

Continued on the following page. ↗

Notice

Continued from the preceding page. ↘

<Applicable to NFM Series>

■ Land Pattern + Solder Resist ■ Land Pattern □ Solder Resist (in mm)

| Series | Land Dimensions | | | | | | | | | | | | | | | | | | | | | | | | | | | | | | | | | | | | | | | | | |
|---|---|---|--|-------------|-----------|-----|-----|---|--|--|--|---|---|---|---|---|---|---|--------------------|-----|-----|-----|-----|-----|-----|-----|---------|-----|-----|-----|-----|-----|-----|-----|--------------------|-----|-----|-----|-----|-----|-----|-----|
| NFM15CC NFM15PC NFM18CC NFM18PC NFM18PS NFM21CC NFM21PC NFM21PS | ● Reflow Soldering | | | | | | | | | | | | | | | | | | | | | | | | | | | | | | | | | | | | | | | | | |
| | NFM15CC/NFM15PC | NFM18CC/NFM18PC Small diameter thru hole $\phi 0.2-\phi 0.3$ | NFM18PS Small diameter thru hole $\phi 0.2$ | | | | | | | | | | | | | | | | | | | | | | | | | | | | | | | | | | | | | | | |
| | NFM21CC/NFM21PC Small diameter thru hole $\phi 0.4$ | NFM21PS Small diameter thru hole $\phi 0.2-\phi 0.3$ | | | | | | | | | | | | | | | | | | | | | | | | | | | | | | | | | | | | | | | | |
| | ● Reflow Soldering Chip mounting side NFM3DCC/NFM3DPC/NFM31PC/NFM41CC/NFM41PC Small diameter thru hole $\phi 0.4$ <table border="1"> <thead> <tr> <th rowspan="2">Part Number</th> <th colspan="7">Size (mm)</th> </tr> <tr> <th>a</th> <th>b</th> <th>c</th> <th>d</th> <th>e</th> <th>f</th> <th>g</th> </tr> </thead> <tbody> <tr> <td>NFM3DCC NFM3DPC</td> <td>1.0</td> <td>1.4</td> <td>2.5</td> <td>4.4</td> <td>1.0</td> <td>2.0</td> <td>2.4</td> </tr> <tr> <td>NFM31PC</td> <td>1.0</td> <td>1.4</td> <td>2.5</td> <td>4.4</td> <td>1.2</td> <td>2.6</td> <td>3.0</td> </tr> <tr> <td>NFM41CC NFM41PC</td> <td>1.5</td> <td>2.0</td> <td>3.5</td> <td>6.0</td> <td>1.2</td> <td>2.6</td> <td>3.0</td> </tr> </tbody> </table> | | | Part Number | Size (mm) | | | | | | | a | b | c | d | e | f | g | NFM3DCC NFM3DPC | 1.0 | 1.4 | 2.5 | 4.4 | 1.0 | 2.0 | 2.4 | NFM31PC | 1.0 | 1.4 | 2.5 | 4.4 | 1.2 | 2.6 | 3.0 | NFM41CC NFM41PC | 1.5 | 2.0 | 3.5 | 6.0 | 1.2 | 2.6 | 3.0 |
| | Part Number | Size (mm) | | | | | | | | | | | | | | | | | | | | | | | | | | | | | | | | | | | | | | | | |
| | | a | b | c | d | e | f | g | | | | | | | | | | | | | | | | | | | | | | | | | | | | | | | | | | |
| NFM3DCC NFM3DPC | 1.0 | 1.4 | 2.5 | 4.4 | 1.0 | 2.0 | 2.4 | | | | | | | | | | | | | | | | | | | | | | | | | | | | | | | | | | | |
| NFM31PC | 1.0 | 1.4 | 2.5 | 4.4 | 1.2 | 2.6 | 3.0 | | | | | | | | | | | | | | | | | | | | | | | | | | | | | | | | | | | |
| NFM41CC NFM41PC | 1.5 | 2.0 | 3.5 | 6.0 | 1.2 | 2.6 | 3.0 | | | | | | | | | | | | | | | | | | | | | | | | | | | | | | | | | | | |
| NFM31KC*1 Small diameter thru hole $\phi 0.4$ 10mm or more (in case of 10A) <p>*1 For large current design, width of signal land pattern should be wider not less than 1mm per 1A (1mm/A). For example, in case of 10A, signal land pattern width should be 10mm or more. (1mm/A*10A=10mm)</p> | | | | | | | | | | | | | | | | | | | | | | | | | | | | | | | | | | | | | | | | | | |
| ● Flow Soldering Chip mounting side NFM31KC*1 Small diameter thru hole $\phi 0.4$ 10mm or more (in case of 10A) <p>*1 For large current design, width of signal land pattern should be wider not less than 1mm per 1A (1mm/A). For example, in case of 10A, signal land pattern width should be 10mm or more. (1mm/A*10A=10mm)</p> | | | | | | | | | | | | | | | | | | | | | | | | | | | | | | | | | | | | | | | | | | |

Continued on the following page. ↗

GRM
 GR3
 GRJ
 GRU
 GR4
 GR7
 GJM
 GQM
 GA2
 GA3 GB
 GA3 GD
 GA3 GF
 LLL
 LLA
 LLM
 LLR
 NFM
 KRM
 KR3
 GMA
 GMD
 Notice
 287

Notice

Continued from the preceding page. ↘

3. Board Design

When designing the board, keep in mind that the amount of strain which occurs will increase depending on the size and material of the board.

[Relationship with amount of strain to the board thickness, length, width, etc.]

$$\epsilon = \frac{3PL}{2Ewh^2} \quad \text{Relationship between load and strain}$$

ϵ : Strain on center of board (μst)
 L : Distance between supporting points (mm)
 w : Board width (mm)
 h : Board thickness (mm)
 E : Elastic modulus of board ($\text{N}/\text{m}^2=\text{Pa}$)
 Y : Deflection (mm)
 P : Load (N)



When the load is constant, the following relationship can be established.

- As the distance between the supporting points (L) increases, the amount of strain also increases.
→Reduce the distance between the supporting points.
 - As the elastic modulus (E) decreases, the amount of strain increases.
→Increase the elastic modulus.
 - As the board width (w) decreases, the amount of strain increases.
→Increase the width of the board.
 - As the board thickness (h) decreases, the amount of strain increases.
→Increase the thickness of the board.
- Since the board thickness is squared, the effect on the amount of strain becomes even greater.

2. Adhesive Application

If you want to temporarily attach the capacitor to the board using an adhesive agent before soldering the capacitor, first be sure that the conditions are appropriate for affixing the capacitor. If the dimensions of the land, the type of adhesive, the amount of coating, the contact surface area, the curing temperature, or other conditions are inappropriate, the characteristics of the capacitor may deteriorate.

1. Selection of Adhesive

- 1-1. Depending on the type of adhesive, there may be a decrease in insulation resistance. In addition, there is a chance that the capacitor might crack from contractile stress due to the difference in the contraction rate of the capacitor and the adhesive.
- 1-2. If there is not enough adhesive, the contact surface area is too small, or the curing temperature or curing time are inadequate, the adhesive strength will be insufficient and the capacitor may loosen or become disconnected during transportation or soldering. If there is too much adhesive, for example if it overflows onto the land, the result could be soldering defects, loss of electrical connection, insufficient curing, or slippage after the capacitor is mounted. Furthermore, if the curing temperature is too high or the curing time is too long, not only will the adhesive

strength be reduced, but solderability may also suffer due to the effects of oxidation on the terminations (outer electrodes) of the capacitor and the land surface on the board.

(1) Selection of Adhesive

Epoxy resins are a typical class of adhesive.

To select the proper adhesive, consider the following points.

- 1) There must be enough adhesive strength to prevent the component from loosening or slipping during the mounting process.
- 2) The adhesive strength must not decrease when exposed to moisture during soldering.
- 3) The adhesive must have good coatability and shape retention properties.
- 4) The adhesive must have a long pot life.
- 5) The curing time must be short.
- 6) The adhesive must not be corrosive to the exterior of the capacitor or the board.
- 7) The adhesive must have good insulation properties.
- 8) The adhesive must not emit toxic gases or otherwise be harmful to health.
- 9) The adhesive must be free of halogenated compounds.

Continued on the following page. ↗

Notice

Continued from the preceding page. ↘

(2) Use the following illustration as a guide to the amount of adhesive to apply.



<Applicable to NFM Series>

[Sizes: 1205(3212M) / 1206(3216M) / 1806(4516M)]

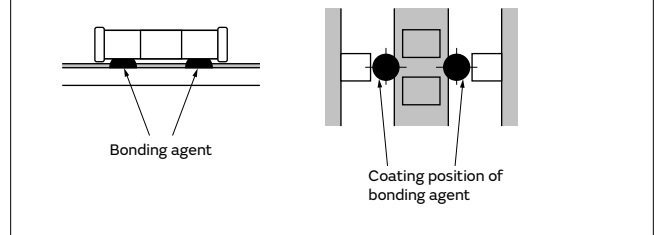

3. Adhesive Curing

1. Insufficient curing of the adhesive can cause chips to disconnect during flow soldering and causes deterioration in the insulation resistance between the terminations due to moisture absorption.

Control curing temperature and time in order to prevent insufficient hardening.

4. Flux for Flow Soldering

1. An excessive amount of flux generates a large quantity of flux gas, which can cause a deterioration of solderability, so apply flux thinly and evenly throughout. (A foaming system is generally used for flow soldering.)

2. Flux containing too high a percentage of halide may cause corrosion of the terminations unless there is sufficient cleaning. Use flux with a halide content of 0.1% max.
 3. Strong acidic flux can corrode the capacitor and degrade its performance.
 Please check the quality of capacitor after mounting.

5. Flow Soldering

● Set temperature and time to ensure that leaching of the terminations does not exceed 25% of the chip end area as a single chip (full length of the edge A-B-C-D shown at right) and 25% of the length A-B shown as mounted on substrate.

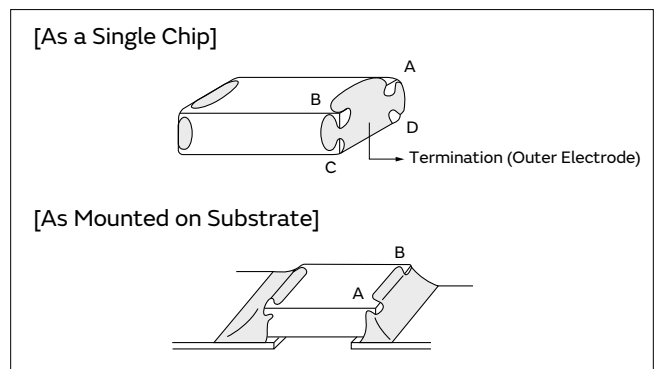

6. Reflow Soldering

The flux in the solder paste contains halogen-based substances and organic acids as activators. Strong acidic flux can corrode the capacitor and degrade its performance.

Please check the quality after mounting, please use.

Continued on the following page. ↗

Notice

Continued from the preceding page. ↘

7. Washing

1. Please evaluate the capacitor using actual cleaning equipment and conditions to confirm the quality, and select the solvent for cleaning.

8. Coating

1. A crack may be caused in the capacitor due to the stress of the thermal contraction of the resin during curing process.
The stress is affected by the amount of resin and curing contraction.
Select a resin with low curing contraction.
The difference in the thermal expansion coefficient between a coating resin or a molding resin and the capacitor may cause the destruction and deterioration of the capacitor such as a crack or peeling, and lead to the deterioration of insulation resistance or dielectric breakdown.
Select a resin for which the thermal expansion coefficient is as close to that of the capacitor as possible.
A silicone resin can be used as an under-coating to buffer against the stress.

2. Unsuitable cleaning may leave residual flux or other foreign substances, causing deterioration of electrical characteristics and the reliability of the capacitors.

2. Select a resin that is less hygroscopic.
Using hygroscopic resins under high humidity conditions may cause the deterioration of the insulation resistance of a capacitor.
An epoxy resin can be used as a less hygroscopic resin.
3. The halogen system substance and organic acid are included in coating material, and a chip corrodes by the kind of Coating material.
Do not use strong acid type.

<Applicable to ZRB Series>

4. Loss suppress acoustic noise may be caused in ZRB series due to the resin during curing process. Please contact our sales representative or product engineers on the apply to resin during curing process.

Other

1. Transportation

1. The performance of a capacitor may be affected by the conditions during transportation.
 - 1-1. The capacitors shall be protected against excessive temperature, humidity, and mechanical force during transportation.
 - (1) Climatic condition
 - low air temperature: -40°C
 - change of temperature air/air: -25°C/+25°C
 - low air pressure: 30 kPa
 - change of air pressure: 6 kPa/min.
 - (2) Mechanical condition
Transportation shall be done in such a way that the boxes are not deformed and forces are not directly passed on to the inner packaging.
 - 1-2. Do not apply excessive vibration, shock, or pressure to the capacitor.
 - (1) When excessive mechanical shock or pressure is applied to a capacitor, chipping or cracking may occur in the ceramic body of the capacitor.
 - (2) When the sharp edge of an air driver, a soldering iron, tweezers, a chassis, etc. impacts strongly on the surface of the capacitor, the capacitor may crack and short-circuit.
 - 1-3. Do not use a capacitor to which excessive shock was applied by dropping, etc.
A capacitor dropped accidentally during processing may be damaged.

2. Characteristics Evaluation in the Actual System

1. Evaluate the capacitor in the actual system, to confirm that there is no problem with the performance and specification values in a finished product before using.
2. Since a voltage dependency and temperature dependency exists in the capacitance of high dielectric type ceramic capacitors, the capacitance may change depending on the operating conditions in the actual system. Therefore, be sure to evaluate the various characteristics, such as the leakage current and noise absorptivity, which will affect the capacitance value of the capacitor.
3. In addition, voltages exceeding the predetermined surge may be applied to the capacitor by the inductance in the actual system. Evaluate the surge resistance in the actual system as required.

<Applicable to NFM Series>

4. The effects of noise suppression can vary depending on the usage conditions, including differences in the circuit or IC to be used, the type of noise, the shape of the pattern to be mounted, and the mounting location. Be sure to verify the effect on the actual device in advance.

GRM

GR3

GRJ

GR4

GR7

GJM

GQM

GA2

GA3
GB

GA3
GD

GA3
GF

LLL

LLA

LLM

LLR

NFM

KRM

KR3

GMA

GMD

Notice

Design Support Tool "SimSurfing"

<https://www.murata.com/simsurfing/>

This is the latest tool to get the electrical characteristics for Capacitors, Inductors, and EMI Suppression Filters, and to simulate Thermistors' behavior !



■ Characteristics viewer
 You can easily search and download the following data for Multilayer Ceramic Capacitors, Polymer Capacitors, EMI Suppression Filters (Three-terminal Capacitors, Ferrite Beads) and Power/RF Inductors.

■ Components performance simulator
 You can search by the simulation on simple circuits for Thermistors.

■ Selection tool
 You can select Medium voltage Capacitors and Power Inductors according to conditions of use.
 * Medium voltage: Rated Voltage 250V and over

■ Search tool
 You can search the Murata timing device (CERALOCK® and crystal units) that is most suitable for your IC and access information about the recommended circuit constant setting.

If you register as a "my Murata" user (<https://my.murata.com/en/web/mymurata/>), you can use Enhanced SimSurfing.

■ Usage example of "Multilayer Ceramic Capacitors"

1 Select the products

- (1) By performance/type
- (2) By part number

2 Show graph

Click each button on each tab of [Basic], [S-parameter] and [Detailed].

3 Data download

- Click each purple button in this area.
- Click "CSV output" button.

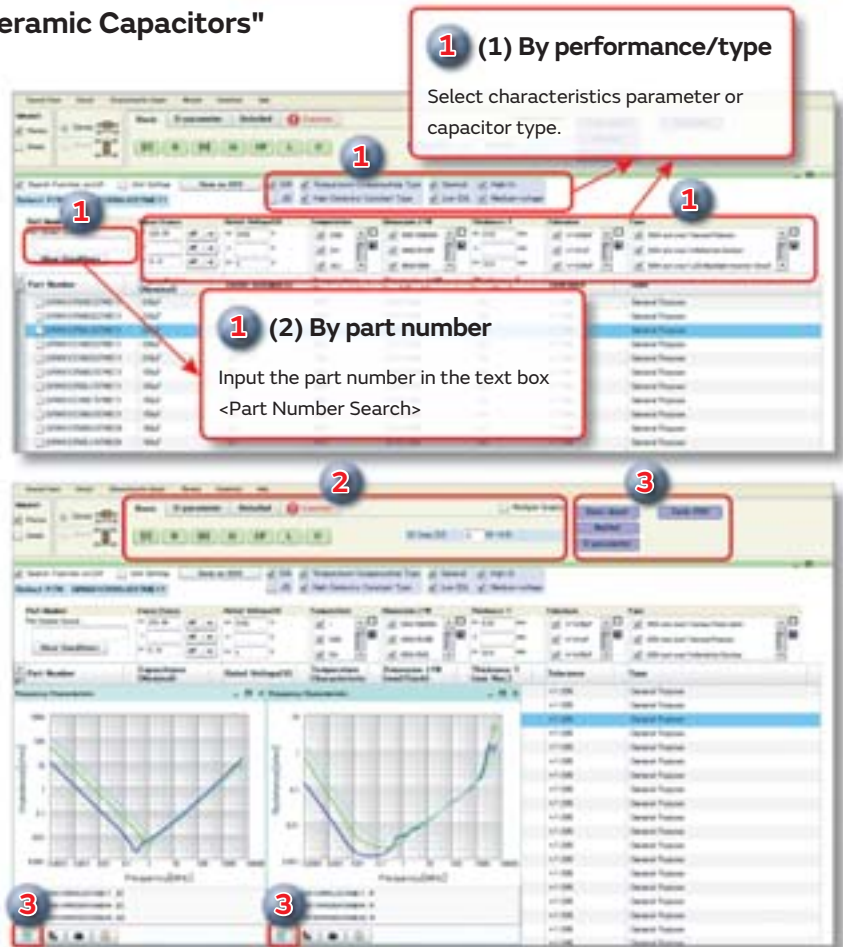

1 (1) By performance/type
 Select characteristics parameter or capacitor type.

1 (2) By part number
 Input the part number in the text box <Part Number Search>

2
 Click each button on each tab of [Basic], [S-parameter] and [Detailed].

3
 Click each purple button in this area. Click "CSV output" button.

* Images are as of October 2015. Be assured that this software will be updated frequently.

<https://www.murata.com/simsurfing/>

Web page Introduction

muRata Product Search



1 Search by Part Number <http://psearch.en.murata.com/capacitor/partnumber/>



You can search for capacitors by specifying the alphanumeric characters in the part number. The packing codes shown contain the substitute character "#". If you enter the official packing code, part numbers that contain that packing code will be matched.

2 Search by Specifications <http://psearch.en.murata.com/capacitor/spec/smd/>



You can search for SMD, lead type, or screw termination type capacitors by indicating specifications such as application, capacitance, rated voltage, or temperature characteristics.

You can narrow your search by entering values of ranges, and by specifying product characteristics.

The items for narrowing searches are linked, so specifying one condition causes selectable options for the other items to allow input only of conditions that match the relevant part numbers.



Search in the Lineups <http://psearch.en.murata.com/capacitor/lineup/>

You can search for capacitors by specifying the series lineup.

You can also confirm items such as characteristics and applications on each series page.



Capacitance chart in Series page.

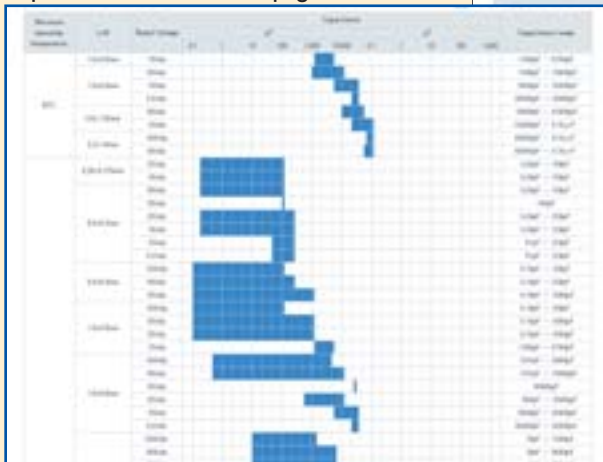

[Search result]

Compares the characteristics of the checked part numbers.

Displays the number of hits for the current search conditions in real time.

Clicking on each search condition button brings up a menu, allowing you to narrow the search results to match the selected condition in real time.

Click "Current search terms" to display a menu, from which you can confirm the current conditions for narrowing the search results.

Click the ▲ mark for each item to switch between ascending and descending display.

Click a product name to display a details page listing more in-depth information (→ P39).

You can download detailed spec sheets.

Icons enable you to check the status and characteristics of products at a glance.

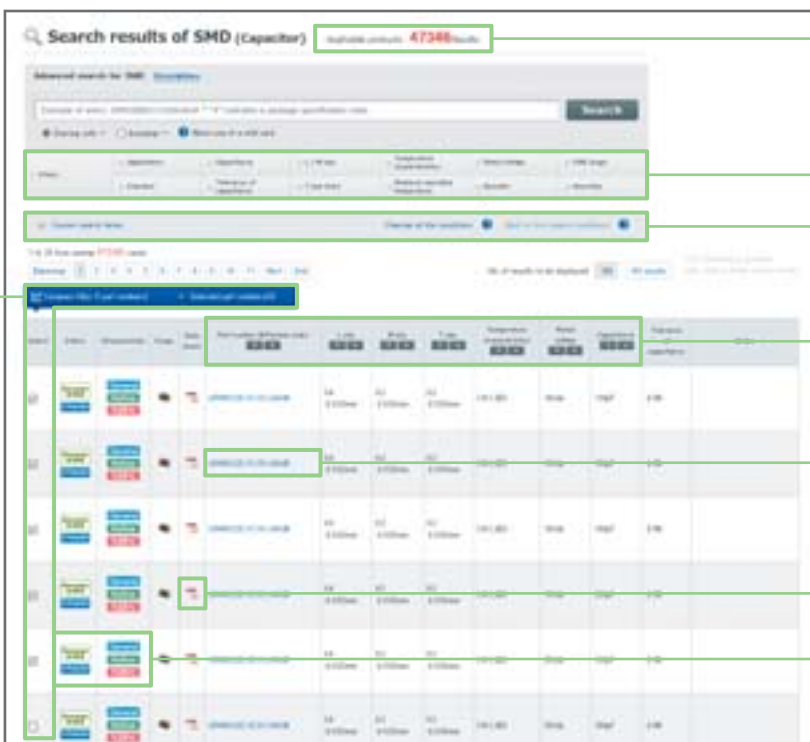

Global Locations

For details please visit www.murata.com



⚠ Note

1 Export Control

For customers outside Japan:

No Murata products should be used or sold, through any channels, for use in the design, development, production, utilization, maintenance or operation of, or otherwise contribution to (1) any weapons (Weapons of Mass Destruction [nuclear, chemical or biological weapons or missiles] or conventional weapons) or (2) goods or systems specially designed or intended for military end-use or utilization by military end-users.

For customers in Japan:

For products which are controlled items subject to the "Foreign Exchange and Foreign Trade Law" of Japan, the export license specified by the law is required for export.

2 Please contact our sales representatives or product engineers before using the products in this catalog for the applications listed below, which require especially high reliability for the prevention of defects which might directly damage a third party's life, body or property, or when one of our products is intended for use in applications other than those specified in this catalog.

- ① Aircraft equipment
- ② Aerospace equipment
- ③ Undersea equipment
- ④ Power plant equipment
- ⑤ Medical equipment
- ⑥ Transportation equipment (vehicles, trains, ships, etc.)
- ⑦ Traffic signal equipment
- ⑧ Disaster prevention / crime prevention equipment
- ⑨ Data-processing equipment
- ⑩ Application of similar complexity and/or reliability requirements to the applications listed above

3 Product specifications in this catalog are as of September 2017. They are subject to change or our products in it may be discontinued without advance notice. Please check with our sales representatives or product engineers before ordering. If there are any questions, please contact our sales representatives or product engineers.

4 Please read rating and ⚠CAUTION (for storage, operating, rating, soldering, mounting and handling) in this catalog to prevent smoking and/or burning, etc.

5 This catalog has only typical specifications. Therefore, please approve our product specifications or transact the approval sheet for product specifications before ordering.

6 Please note that unless otherwise specified, we shall assume no responsibility whatsoever for any conflict or dispute that may occur in connection with the effect of our and/or a third party's intellectual property rights and other related rights in consideration of your use of our products and/or information described or contained in our catalogs. In this connection, no representation shall be made to the effect that any third parties are authorized to use the rights mentioned above under licenses without our consent.

7 No ozone depleting substances (ODS) under the Montreal Protocol are used in our manufacturing process.

Murata Manufacturing Co., Ltd.

www.murata.com

muRata
INNOVATOR IN ELECTRONICS

X-ON Electronics

Largest Supplier of Electrical and Electronic Components

Click to view similar products for [murata](#) manufacturer:

Other Similar products are found below :

[786028C](#) [MGJ1D121905MPC-R7](#) [MGJ2D051515SC](#) [82103C](#) [82224C](#) [82473C](#) [GCM32EC71H106MA03L](#) [GRM2165C1H101FA01D](#)
[PTGL09AS2R2K3B51B0](#) [11R683C](#) [DD1274AS-H-220M=P3](#) [DFE252012P-1R0M=P2](#) [BPM15-120-Q12P-C](#) [NMK1212SC](#) [NMV1212DAC](#)
[LQH43MN330J03L](#) [GJM0335C1E220GB01D](#) [GRM1885C1H150FA01J](#) [GRM21BR71C475KE51L](#) [GRM3195C2A471JD01D](#)
[GRM31CR61A475KA01L](#) [RF1211C](#) [MGJ2D121509SC](#) [MGJ6D122005LMC-R7](#) [#B953AS-330M=P3](#) [BLM18AG601SN1J](#) [HN-214](#) [HN-214X](#) [TZ03P450](#) [UEE-12/12.5-D48NB-C](#) [LBWB1ZZYDZ-DTEMP-SNIC-UART-A](#) [LLM315R70J225MA11L](#) [46334C](#) [DR4103](#) [SCA830-D07-PCB](#) [NKE1212DC](#) [NMA1215SC](#) [UVQ-48/2.5-D24PB-C](#) [RDE5C1H472J1M1H03A](#) [IML-0642](#) [HPR105C](#) [HPQ-12/25-D48PB-C](#) [UWS-5/10-Q48N-C](#) [UWR-5/2000-D24E-C](#) [19R683C](#) [UHE-152000-D24-C](#) [782485/35C](#) [UEI-3.3/15-Q12PR-C](#) [MGJ2D122005SC](#) [MEV1S0505SC](#)