

# LQG15WZ91NJ02#

# indicates a package specification code.



< List of part numbers with package codes >  
 LQG15WZ91NJ02D , LQG15WZ91NJ02J , LQG15WZ91NJ02B

## Shape

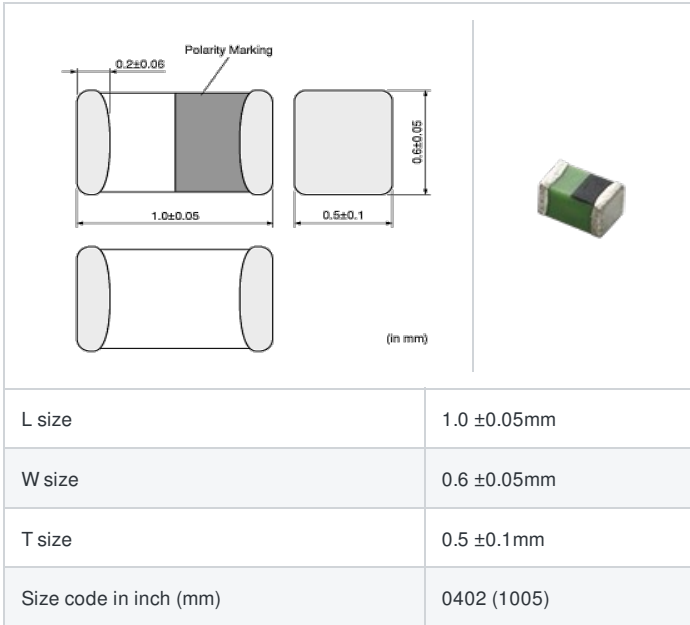

## References

Packaging code	Specifications	Minimum quantity
D	φ180mm Paper taping	10000
J	φ330mm Paper taping	40000
B	Packing in bulk	100

Mass (Typ.)	
1 piece	0.001g

## Specifications

Inductance	91nH ±5%
Inductance test frequency	100MHz
Rated current (Itemp) (Based on Temperature rise)	160mA
Max. of DC resistance	2.3Ω
Q (min.)	23
Q test frequency	250MHz
Self resonance frequency (min.)	900MHz
Operating temperature range (Self-temperature rise is not included)	-55~125°C
Series	LQG15WZ_02

### Attention

- 1.This datasheet is downloaded from the website of Murata Manufacturing Co., Ltd. Therefore, it's specifications are subject to change or our products in it may be discontinued without advance notice. Please check with our sales representatives or product engineers before ordering.
- 2.This datasheet has only typical specifications because there is no space for detailed specifications. Therefore, please review our product specifications or consult the approval sheet for product specifications before ordering.

**Chart of characteristic data (The charts below may show another part number which shares its characteristics.)**

▪ Inductance-Frequency characteristics (Typ.)

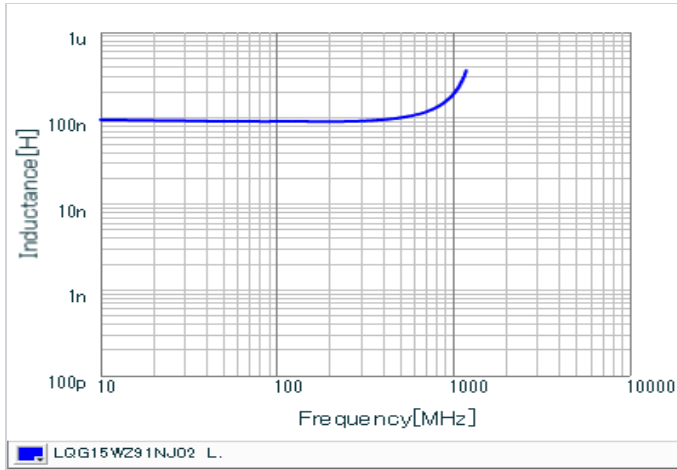

▪ Q-Frequency characteristics (Typ.)

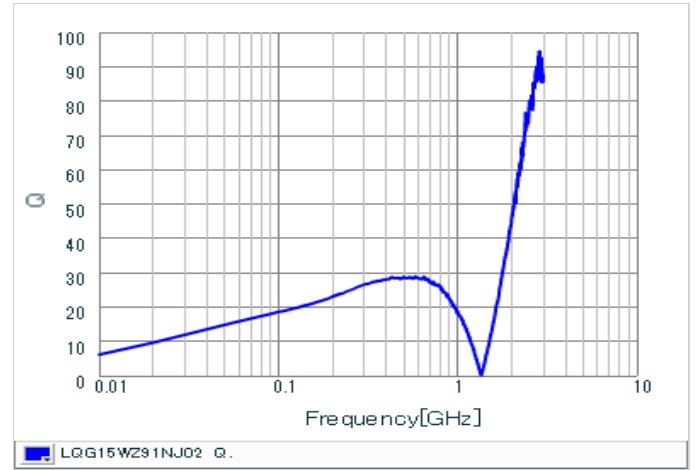

**⚠ Attention**

- 1.This datasheet is downloaded from the website of Murata Manufacturing Co., Ltd. Therefore, it's specifications are subject to change or our products in it may be discontinued without advance notice. Please check with our sales representatives or product engineers before ordering.
- 2.This datasheet has only typical specifications because there is no space for detailed specifications. Therefore, please review our product specifications or consult the approval sheet for product specifications before ordering.

## X-ON Electronics

Largest Supplier of Electrical and Electronic Components

*Click to view similar products for [Fixed Inductors](#) category:*

*Click to view products by [Murata](#) manufacturer:*

Other Similar products are found below :

[CR43NP-680KC](#) [CR54NP-820KC](#) [CR54NP-8R5MC](#) [CTX32CT-100](#) [70F224AI](#) [MGDQ4-00004-P](#) [MHL1ECTTP18NJ](#) [MHL1JCTTD12NJ](#)  
[PE-51506NL](#) [PE-53601NL](#) [PE-53602NL](#) [PE-53630NL](#) [PE-53824SNLT](#) [PE-62892NL](#) [PE-92100NL](#) [PG0434.801NLT](#) [PG0936.113NLT](#)  
[9310-16](#) [PM06-2N7](#) [PM06-39NJ](#) [A01TK](#) [1206CS-471XJ](#) [HC2-2R2TR](#) [HC2LP-R47-R](#) [HC3-2R2-R](#) [HCF1305-3R3-R](#) [1206CS-151XG](#)  
[RCH664NP-140L](#) [RCH664NP-4R7M](#) [RCH8011NP-221L](#) [RCP1317NP-332L](#) [RCP1317NP-391L](#) [RCR1010NP-470M](#) [RCR110DNP-331L](#)  
[DH2280-4R7M](#) [DS1608C-106](#) [ASPI-4020HI-R10M-T](#) [B10TJ](#) [B82477P4333M](#) [B82498B3101J000](#) [B82498B3680J000](#) [ELJ-RE27NJF2](#)  
[1812CS-153XJ](#) [1812CS-183XJ](#) [1812CS-223XJ](#) [1812LS-104XJ](#) [1812LS-105XJ](#) [1812LS-124XJ](#) [1812LS-154XJ](#) [1812LS-223XJ](#)