

CHIP COILS (CHIP INDUCTORS) LQM21PN□□□□EH□ REFERENCE SPECIFICATION

1. Scope

This reference specification applies to chip coils (chip inductors) LQM21PN_EH series for general electronic equipment.

2. Part Numbering

(Ex.)

LQ	M	21	P	N	2R2	M	E	H	D
Product ID	Structure	Dimension (L × W)	Application and characteristic	Category	Inductance	Tolerance	Dimension (T)	Other	Packaging D: taping *B: bulk

*B: Bulk packing is also available.

3. Part Number and Rating

Operating temperature range	-40°C to +85°C
Storage temperature range	-40°C to +85°C

Customer Part number	Murata Part number	Inductance		DC resistance (mΩ)		Self-resonant frequency (MHz min.)	Rated current (A) ^{*3}			
		Nominal value (μH)	Tolerance (%)				Based on inductance change ^{*1}		Based on temperature rise ^{*2}	
				Typ.	Max.		Typ.	Max.	Typ.	Max.
	LQM21PNR24MEHD	0.24	±20	40	50	130	3.1	2.8	2.9	2.4
	LQM21PNR47MEHD	0.47	±20	60	75	80	1.8	1.5	2.4	1.9
	LQM21PN1R0MEHD	1.0	±20	85	107	50	1	0.8	2	1.6
	LQM21PN1R5MEHD	1.5	±20	100	125	40	0.55	0.4	1.8	1.5
	LQM21PN2R2MEHD	2.2	±20	175	219	30	0.45	0.3	1.4	1.1

*1 When rated current is applied to the products, inductance will be within ±30% of initial inductance value range.

*2 When rated current is applied to the products, temperature rise caused by self-generated heat shall be limited to 40°C max.

*3 Keep the temperature (ambient temperature plus self-generation of heat) under 125°C.

4. Testing Conditions

Unless otherwise specified	Temperature: ordinary temperature (15°C to 35°C) Humidity: ordinary humidity [25% to 85% (RH)]
In case of doubt	Temperature: 20°C±2°C Humidity: 60% to 70% (RH) Atmospheric pressure: 86 kPa to 106 kPa

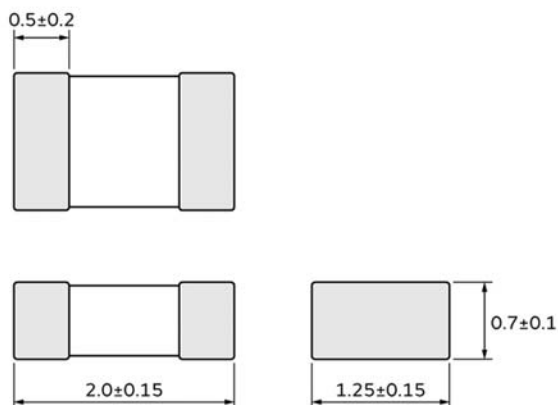
5. Appearance and Dimensions

(in mm)

Unit mass (typical value): 0.010 g

6. Marking

No marking.

7. Electrical Performance

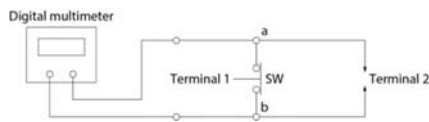
No.	Item	Specification	Test method
7.1	Inductance	Meet chapter 3 ratings.	Measuring equipment: Keysight 4294A or the equivalent (1 mA) Measuring frequency: 1 MHz
7.2	DC resistance	Meet chapter 3 ratings.	Measuring equipment: digital multimeter Measuring circuit:  Measure with the product set to terminal 2 and the switch pressed (open between a and b). When setting or removing the product, press the switch to short between a and b.
7.3	Self-resonant frequency	Meet chapter 3 ratings.	Measuring equipment: Keysight 4294A or the equivalent

8. Mechanical Performance

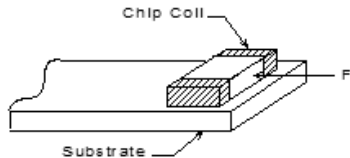
No.	Item	Specification	Test method
8.1	Shear test	No significant mechanical damage or no sign of electrode peeling off shall be observed.	Force application direction:  Applying force: 10 N Holding time: 5 s±1 s

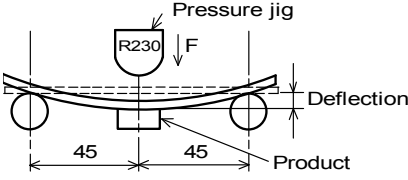
No.	Item	Specification	Test method
8.2	Bending test	No significant mechanical damage or no sign of electrode peeling off shall be observed.	<p>Test substrate: glass-epoxy substrate (100 mm × 40 mm × 1.0 mm) Pressurizing speed: 0.5 mm/s Deflection: 2 mm Holding time: 30 s</p>  <p style="text-align: right;">(in mm)</p>
8.3	Vibration	Appearance shall have no significant mechanical damage.	<p>Oscillation frequency: 10 Hz to 2000 Hz to 10 Hz, for approx. 20 min Total amplitude: total amplitude of 3.0 mm or acceleration amplitude of 245 m/s², whichever is smaller Test time: 3 directions perpendicular to each other, 4 h for each direction (12 h in total)</p>
8.4	Drop	Appearance shall have no significant mechanical damage.	<p>The product shall be dropped so that it falls freely onto concrete or a steel board. Height: 1 m Number of falls: 10 times</p>
8.5	Solderability	90% or more of the outer electrode shall be covered with new solder seamlessly.	<p>Flux: immersed in ethanol solution with a rosin content of 25(wt)% for 5 s to 10 s Solder: Sn-3.0Ag-0.5Cu solder Pre-heating: 150°C±10°C/60 s to 90 s Solder temperature: 240°C±5°C Immersion time: 3 s±1 s</p>
8.6	Resistance to soldering heat	Appearance: No significant mechanical damage shall be observed. Inductance change rate: within ±30%	<p>Flux: immersed in ethanol solution with a rosin content of 25(wt)% for 5 s to 10 s Solder: Sn-3.0Ag-0.5Cu solder Pre-heating: 150°C±10°C/60 s to 90 s Solder temperature: 270°C±5°C Immersion time: 10 s±1 s Post-treatment: left at a room temperature for 24 h±2 h</p>

9. Environmental Performance

The product is soldered on a substrate for test.

No.	Item	Specification	Test method
9.1	Heat resistance	Appearance: No significant mechanical damage shall be observed. Inductance change rate: within ±30%	<p>Temperature: 85°C±2°C Test time: 1000 h (+48 h, -0 h) Post-treatment: left at a room temperature for 24 h±2 h</p>
9.2	Cold resistance	Appearance: No significant mechanical damage shall be observed. Inductance change rate: within ±30%	<p>Temperature: -40°C±2°C Test time: 1000 h (+48 h, -0 h) Post-treatment: left at a room temperature for 24 h±2 h</p>
9.3	Humidity	Appearance: No significant mechanical damage shall be observed. Inductance change rate: within ±30%	<p>Temperature: 40°C±2°C Humidity: 90% (RH) to 95% (RH) Test time: 1000 h (+48 h, -0 h) Post-treatment: left at a room temperature for 24 h±2 h</p>
9.4	Temperature cycle	Appearance: No significant mechanical damage shall be observed. Inductance change rate: within ±30%	<p>Single cycle conditions: Step 1: -40°C±2°C/30 min±3 min Step 2: ordinary temperature/10 min to 15 min Step 3: +85°C±2°C/30 min±3 min Step 4: ordinary temperature/10 min to 15 min Number of testing: 100 cycles Post-treatment: left at a room temperature for 24 h±2 h</p>

10. Specification of Packaging

10.1 Appearance and dimensions of tape (8 mm width/paper tape)

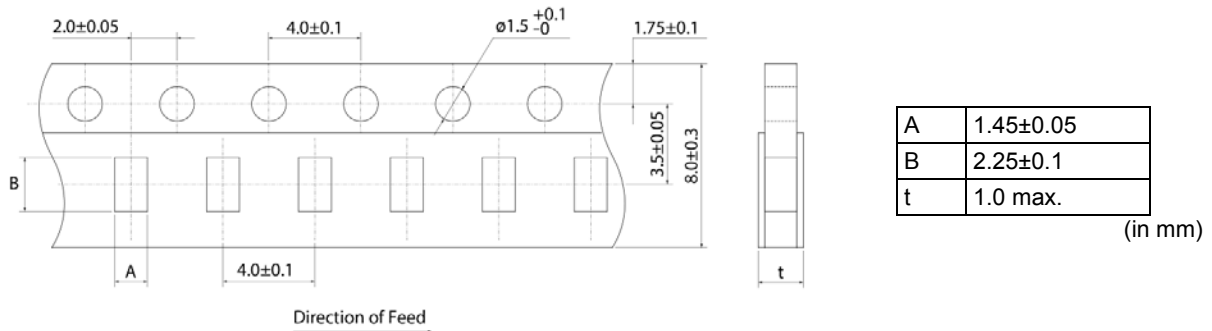

10.2 Taping specifications

Packing quantity (Standard quantity)	3000 pcs/reel
Packing method	The products are placed in embossed cavities of a base tape and sealed by a top tape and a bottom tape.
Feed hole position	The feed holes on the base tape are on the right side when the top tape is pulled toward the user.
Joint	The base tape and the top tape are seamless.
Number of missing products	Number of missing products within 0.1% of the number per reel or 1 pc., whichever is greater, and are not continuous. The specified quantity per reel is kept.

10.3 Break down force of tape

Break down force of top tape	5 N min.
Break down force of bottom tape	5 N min.

10.4 Peeling off force of top tape

Speed of peeling off	300 mm/min
Peeling off force	0.1 N to 0.6 N (The lower limit is for typical value.)

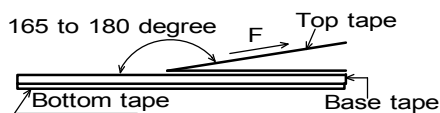

10.5 Dimensions of leader section, trailer section and reel

A vacant section is provided in the leader (start) section and trailer (end) section of the tape for the product. The leader section is further provided with an area consisting only of the top tape. (See the diagram below.)

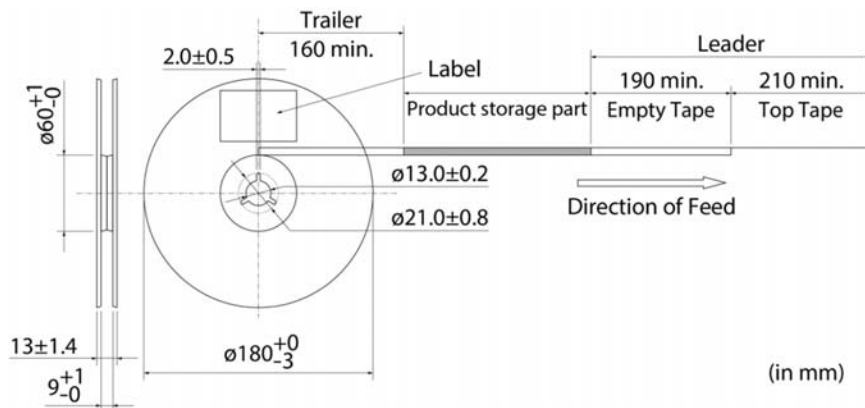

10.6 Marking for reel

Customer part number, Murata part number, inspection number (*1), RoHS marking (*2), quantity, etc.

<p>*1 Expression of inspection No.:</p> <table style="width: 100%; text-align: center; border-collapse: collapse;"> <tr> <td style="border: 1px solid black; width: 33%; padding: 2px;">□□</td> <td style="border: 1px solid black; width: 33%; padding: 2px;">○○○○</td> <td style="border: 1px solid black; width: 33%; padding: 2px;">◇◇◇◇</td> </tr> <tr> <td style="border: none;">(1)</td> <td style="border: none;">(2)</td> <td style="border: none;">(3)</td> </tr> </table>	□□	○○○○	◇◇◇◇	(1)	(2)	(3)	<p>(1) Factory code (2) Date First digit: year/last digit of year Second digit: month/Jan. to Sep.→1 to 9, Oct. to Dec.→O, N, D Third, Fourth digit: day (3) Serial No.</p>
□□	○○○○	◇◇◇◇					
(1)	(2)	(3)					
<p>*2 Expression of RoHS marking:</p> <p>ROHS- $\frac{Y}{(1)}$ $\frac{(\Delta)}{(2)}$</p>	<p>(1) RoHS regulation conformity (2) Murata classification number</p>						

10.7 Marking on outer box (corrugated box)

Customer name, purchasing order number, customer part number, Murata part number, RoHS marking (*2), quantity, etc.

10.8 Specification of outer box

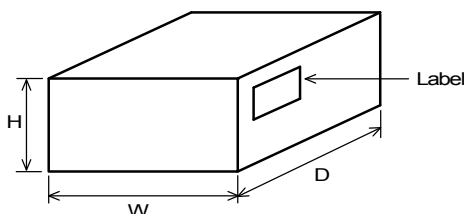

Dimensions of outer box (mm)			Standard reel quantity in outer box (reel)
W	D	H	
186	186	93	5
* Above outer box size is typical. It depends on a quantity of an order.			

11. ⚠Caution

Restricted applications	<p>Please contact us before using our products for the applications listed below which require especially high reliability for the prevention of defects which might directly cause damage to the third party's life, body or property.</p> <table style="width: 100%; border: none;"> <tr> <td style="width: 50%; border: none;"> (1) Aircraft equipment (2) Aerospace equipment (3) Undersea equipment (4) Power plant control equipment (5) Medical equipment </td> <td style="width: 50%; border: none;"> (6) Transportation equipment (vehicles, trains, ships, etc.) (7) Traffic signal equipment (8) Disaster/crime prevention equipment (9) Data-processing equipment (10) Applications of similar complexity and/or reliability requirements to the applications listed in the above </td> </tr> </table>	(1) Aircraft equipment (2) Aerospace equipment (3) Undersea equipment (4) Power plant control equipment (5) Medical equipment	(6) Transportation equipment (vehicles, trains, ships, etc.) (7) Traffic signal equipment (8) Disaster/crime prevention equipment (9) Data-processing equipment (10) Applications of similar complexity and/or reliability requirements to the applications listed in the above
(1) Aircraft equipment (2) Aerospace equipment (3) Undersea equipment (4) Power plant control equipment (5) Medical equipment	(6) Transportation equipment (vehicles, trains, ships, etc.) (7) Traffic signal equipment (8) Disaster/crime prevention equipment (9) Data-processing equipment (10) Applications of similar complexity and/or reliability requirements to the applications listed in the above		

12. Precautions for Use

This product is for use only with reflow soldering. It is designed to be mounted by soldering. If you want to use other mounting method, for example, using a conductive adhesive, please consult us beforehand.

12.1 Land dimensions

The following diagram shows the recommended land dimensions for reflow soldering:

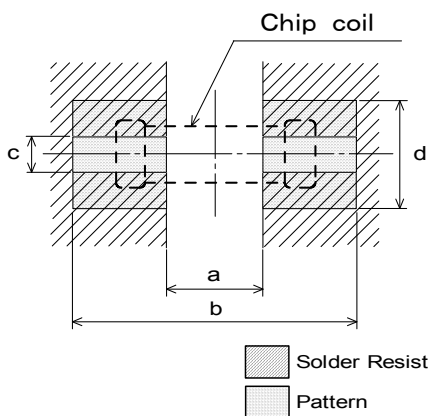

Applied current (A)	a	b	c	Pattern thickness and dimension d		
				18 μm	35 μm	70 μm
0 to 1.0	1.2	3.0 to 4.0	1.0	1.0	1.0	1.0
1.0 to 1.5	1.2	3.0 to 4.0	1.0	1.5	1.0	1.0
1.5 to 3.1	1.2	3.0 to 4.0	1.0	3.0	1.5	1.0

(in mm)

12.2 Flux and solder used

Flux	<ul style="list-style-type: none"> • Use a rosin-based flux. • Do not use a highly acidic flux with a halide content exceeding 0.2(wt)% (chlorine conversion value). • Do not use a water-soluble flux.
Solder	<ul style="list-style-type: none"> • Use Sn-3.0Ag-0.5Cu solder. • Standard thickness of solder paste: 100 μm to 150 μm

If you want to use a flux other than the above, please consult our technical department.

12.3 Soldering conditions (reflow)

- Pre-heating should be in such a way that the temperature difference between solder and product surface is limited to 150°C max.
Cooling into solvent after soldering also should be in such a way that the temperature difference is limited to 100°C max. Insufficient pre-heating may cause cracks on the product, resulting in the deterioration of product quality.
- Standard soldering profile and the limit soldering profile is as follows.
The excessive limit soldering conditions may cause leaching of the electrode and/or resulting in the deterioration of product quality.



	Standard profile	Limit profile
Pre-heating	150°C to 180°C/90 s ± 30 s	150°C to 180°C/90 s ± 30 s
Heating	Above 220°C/30 s to 60 s	Above 230°C/60 s max.
Peak temperature	245°C ± 3°C	260°C/10 s
Number of reflow cycles	2 times	2 times

12.4 Reworking with soldering iron

The following requirements must be met to rework a soldered product using a soldering iron.

Item	Requirement
Pre-heating	150°C/approx. 1 min
Tip temperature of soldering iron	350°C max.
Power consumption of soldering iron	80 W max.
Tip diameter of soldering iron	ø3 mm max.
Soldering time	3 s (+1 s, -0 s)
Number of reworking operations	2 times max.

* Avoid a direct contact of the tip of the soldering iron with the product. Such a direction contact may cause cracks in the ceramic body due to thermal shock.

12.5 Solder volume

Solder shall be used not to be exceeded the upper limits as shown below.

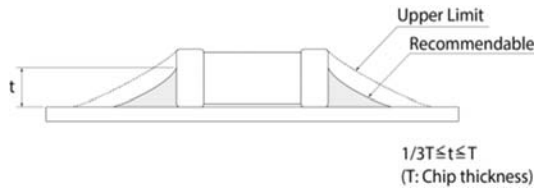

An increased solder volume increases mechanical stress on the product. Exceeding solder volume may cause the failure of mechanical or electrical performance.

12.6 Product's location

The following shall be considered when designing and laying out PCBs.

(1) PCB shall be designed so that products are not subject to mechanical stress due to warping the board.

[Products direction]

Products shall be located in the sideways direction (length: $a < b$) to the mechanical stress.

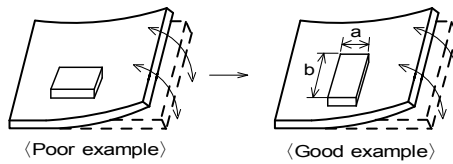

(2) Components location on PCB separation

It is effective to implement the following measures, to reduce stress in separating the board.

It is best to implement all of the following three measures; however, implement as many measures as possible to reduce stress.

Contents of measures	Stress level
(1) Turn the mounting direction of the component parallel to the board separation surface.	$A > D^*1$
(2) Add slits in the board separation part.	$A > B$
(3) Keep the mounting position of the component away from the board separation surface.	$A > C$
*1 $A > D$ is valid when stress is added vertically to the perforation as with hand separation. If a cutting disc is used, stress will be diagonal to the PCB, therefore $A > D$ is invalid.	

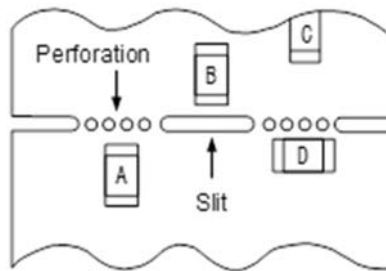

(3) Mounting components near screw holes

When a component is mounted near a screw hole, it may be affected by the board deflection that occurs during the tightening of the screw.

Mount the component in a position as far away from the screw holes as possible.

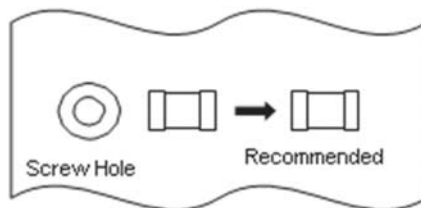

12.7 Handling of substrate

After mounting products on a substrate, do not apply any stress to the product caused by bending or twisting to the substrate when cropping the substrate, inserting and removing a connector from the substrate or tightening screw to the substrate. Excessive mechanical stress may cause cracking in the product.

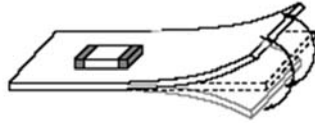

Bending

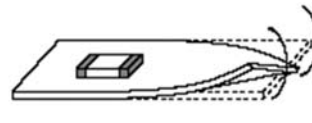

Twisting

12.8 Cleaning

The product shall be cleaned under the following conditions.

- (1) The cleaning temperature shall be 60°C max. If isopropyl alcohol (IPA) is used, the cleaning temperature shall be 40°C max.
- (2) Perform ultrasonic cleaning under the following conditions. Exercise caution to prevent resonance phenomenon in mounted products and the PCB.

Item	Requirement
Power	20 W/L max.
Time	5 min max.
Frequency	28 kHz to 40 kHz

- (3) Cleaner

Alcohol-based cleaner: IPA
Aqueous agent: PINE ALPHA ST-100S

- (4) There shall be no residual flux or residual cleaner. When using aqueous agent, rinse the product with deionized water adequately and completely dry it so that no cleaner is left.

* For other cleaning, consult our technical department.

12.9 Storage and transportation

Storage period	Use the product within 6 months after delivery. If you do not use the product for more than 6 months, check solderability before using it.
Storage conditions	<ul style="list-style-type: none"> • The products shall be stored in a room not subject to rapid changes in temperature and humidity. The recommended temperature range is -10°C to +40°C. The recommended relative humidity range is 15% to 85%. • Keeping the product in corrosive gases, such as sulfur, chlorine gas or acid may cause the poor solderability. • Do not place the products directly on the floor; they should be placed on a palette so that they are not affected by humidity or dust. • Avoid keeping the products in a place exposed to direct sunlight, heat or vibration. • Avoid storing the product by itself bare (i.e. exposed directly to air).
Transportation	Excessive vibration and impact reduces the reliability of the products. Exercise caution when handling the products.

12.10 Resin coating

The inductance value may change and/or it may affect on the product's performance due to high cure-stress of resin to be used for coating/molding products. So please pay your careful attention when you select resin. In prior to use, please make the reliability evaluation with the product mounted in your application set.

12.11 Handling of product

Inductance could change due to the effect of magnetism. Do not use magnetized tweezers, magnets, or other similar tools when handling the product (instead, use tweezers with resin or ceramic tips).

12.12 Magnetic saturation

A current exceeding the rated current could cause the inductance value to drop due to magnetic saturation.

15. ⚠Note

- (1) Please make sure that your product has been evaluated in view of your specifications with our product being mounted to your product.
- (2) You are requested not to use our product deviating from the reference specifications.
- (3) The contents of this reference specification are subject to change without advance notice. Please approve our product specifications or transact the approval sheet for product specifications before ordering.

X-ON Electronics

Largest Supplier of Electrical and Electronic Components

Click to view similar products for [Fixed Inductors](#) category:

Click to view products by [Murata](#) manufacturer:

Other Similar products are found below :

[CR43NP-680KC](#) [CR54NP-820KC](#) [CR54NP-8R5MC](#) [CTX32CT-100](#) [70F224AI](#) [MGDQ4-00004-P](#) [MHL1ECTTP18NJ](#) [MHL1JCTTD12NJ](#)
[PE-51506NL](#) [PE-53601NL](#) [PE-53602NL](#) [PE-53630NL](#) [PE-53824SNLT](#) [PE-62892NL](#) [PE-92100NL](#) [PG0434.801NLT](#) [PG0936.113NLT](#)
[9310-16](#) [PM06-2N7](#) [PM06-39NJ](#) [A01TK](#) [1206CS-471XJ](#) [HC2-2R2TR](#) [HC2LP-R47-R](#) [HC3-2R2-R](#) [HCF1305-3R3-R](#) [1206CS-151XG](#)
[RCH664NP-140L](#) [RCH664NP-4R7M](#) [RCH8011NP-221L](#) [RCP1317NP-332L](#) [RCP1317NP-391L](#) [RCR1010NP-470M](#) [RCR110DNP-331L](#)
[DH2280-4R7M](#) [DS1608C-106](#) [ASPI-4020HI-R10M-T](#) [B10TJ](#) [B82477P4333M](#) [B82498B3101J000](#) [B82498B3680J000](#) [ELJ-RE27NJF2](#)
[1812CS-153XJ](#) [1812CS-183XJ](#) [1812CS-223XJ](#) [1812LS-104XJ](#) [1812LS-105XJ](#) [1812LS-124XJ](#) [1812LS-154XJ](#) [1812LS-223XJ](#)