

**1. Application**

- ESD Protection

**2. Features**

- Bi-directional device
- IEC61000-4-2(ESD)  $\pm 15\text{kV}$ (air),  $\pm 8\text{kV}$ (contact)
- Fast Turn on and Low Clamping voltage
- Ultra-low capacitance 0.5pF typical
- RoHS regulation conformity parts
- 

**3. Dimensions (Unit :mm)**

TOP VIEW

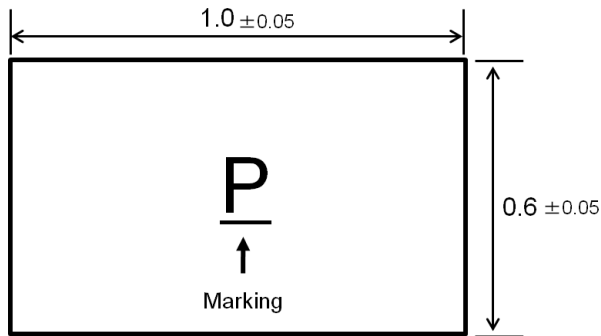

BOTTOM VIEW

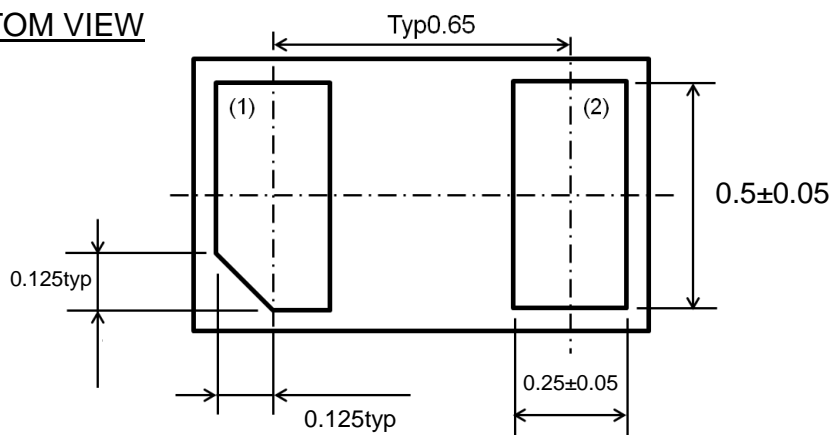

SIDE VIEW



4. Schematic

BOTTOM VIEW

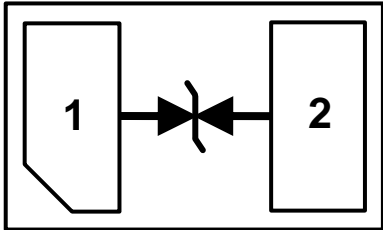

5. Maximum Ratings

Rating	Symbol	Value	Unit
Operating Voltage	$V_{DC}$	$\pm 6$	V
ESD per IEC 61000-4-2 (air)	$V_{ESD}$	$\pm 15$	kV
ESD per IEC 61000-4-2 (contact)		$\pm 8$	
Lead Soldering Temperature	$T_{SOL}$	260 (10 sec.)	$^{\circ}C$
Operating Temperature	$T_{OP}$	-40 to +85	$^{\circ}C$
Storage Temperature	$T_{STO}$	-40 to +125	$^{\circ}C$

6. Electrical Characteristics (T=25  $^{\circ}C$ )

Parameter	Symbol	Conditions	MIN	TYP	MAX	Units
Leakage Current	$I_{Leak}$	$V_{RWM} = \pm 5V$			1	$\mu A$
Breakdown Voltage	$V_{BV}$	$I_{BV} = 1mA$	7			V
Capacitance (I/O - GND)	$C_{IN}$	$V_R = 0V, f = 1MHz$		0.5		pF

**7. Typical Characteristic**

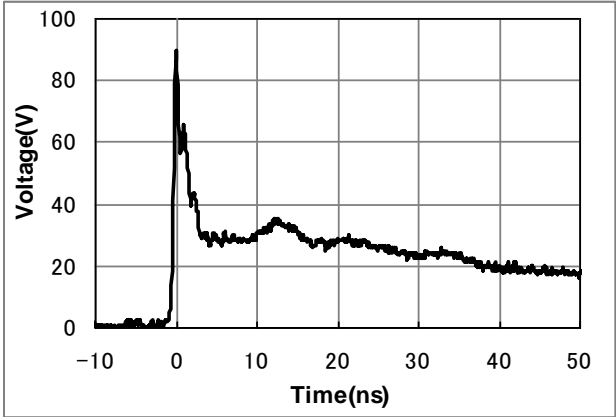

ESD Waveform (IEC61000-4-2:8kV Contact)

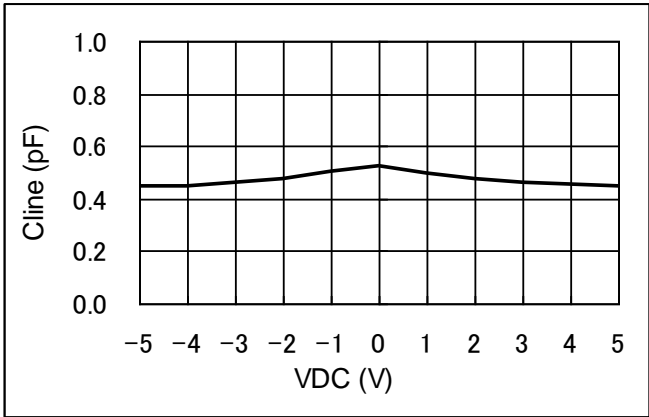

Voltage vs. Capacitance

**8. Soldering Footprint (Unit :mm)**

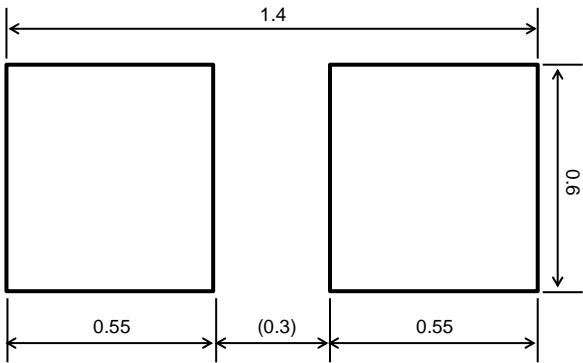

Note: This footprint is for reference purpose only.

9. Taping Specification

1) Dimensions of Tape (Plastic tape)

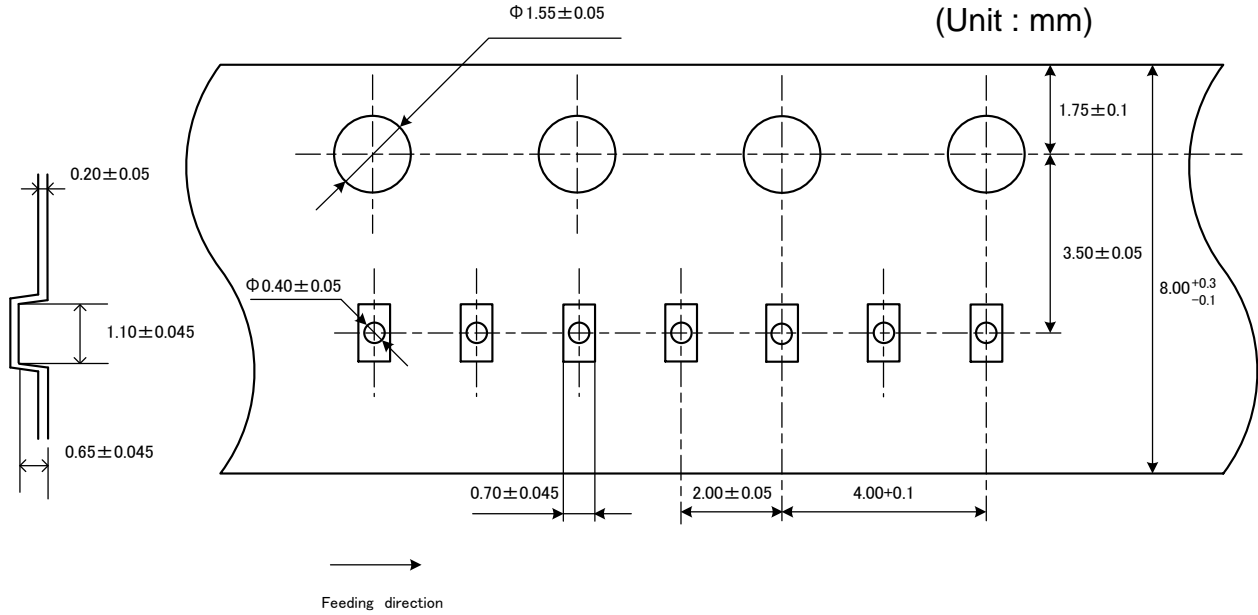

2) Dimensions of Reel

(Unit : mm)

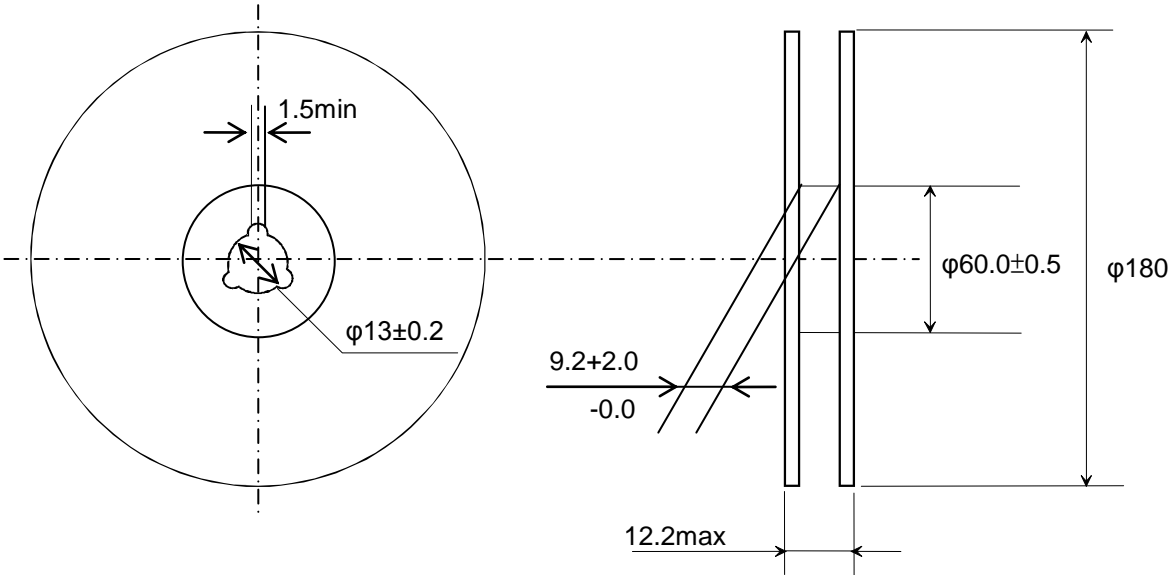

3) Packaging unit: 3,000 pcs / reel

**Note:**

1. This datasheet's specifications are subject to change or our products in it may be discontinued without advance notice. Please check with our sales representatives or product engineers before ordering.
2. This datasheet has only typical specifications because there is no space for detailed specifications. Therefore, please approve our product specifications or transact the approval sheet for product specifications before ordering.

## X-ON Electronics

Largest Supplier of Electrical and Electronic Components

*Click to view similar products for [ESD Suppressors / TVS Diodes](#) category:*

*Click to view products by [Murata](#) manufacturer:*

Other Similar products are found below :

[NTE4902](#) [P4SMAJ15A](#) [P4SMAJ26A](#) [SMAJ400CA-TP](#) [TGL34-47CA](#) [ESDAULC45-1BF4](#) [SM1605E3/TR13](#) [SMF20A-TP](#) [P4SMAJ12A](#)  
[CPDUR24V-HF](#) [CPDQC5V0USP-HF](#) [CPDQC5V0-HF](#) [MPLAD30KP45CAE3](#) [MMBZ27VCLQ-7-F](#) [MMAD1108/TR13](#) [MPLAD30KP24A](#)  
[ACPDQC5V0R-HF](#) [DFLT170A-7](#) [NTE4900](#) [NTE4926](#) [NTE4938](#) [SMF22A-TP](#) [SMF12A-TP](#) [SLVU2.8-TP](#) [SMLJ6.5CA-TP](#) [SMAJ6.5CA-](#)  
[TP](#) [MMAD1108E3/TR13](#) [D5V0M1U2LP3-7](#) [SMAJ400A-TP](#) [AOZ8811DT-03](#) [AOZ8831DI-05](#) [AOZ8831DT-03](#) [SMAJ188CA](#) [3SMC33CA](#)  
[BK](#) [CPDQC3V3C-HF](#) [CPDQC12VE-HF](#) [MPLAD30KP170CA](#) [82357120100](#) [5.0SMLJ15CA-TP](#) [5KP18A-TP](#) [P6KE8.2A-TP](#)  
[MPLAD30KP43CAE3](#) [SMAJ43A-TP](#) [D5V0F6U8LP33-7](#) [TVS5501V10MUT5G](#) [5.0SMLJ24CA-TP](#) [SMAJ110CA-TP](#) [MPLAD15KP75CAE3](#)  
[MMAD1103e3/TR13](#) [DFLT40AQ-7](#)