



FEATURES

- ITE (2nd) and Medical 3rd ed. 1MOPP (primary-secondary) safety approved
- 120W compact high density
- 2" x 4" standard footprint
- High efficiency up to 91%
- Universal AC input with active PFC
- Low profile - 1U package
- Convection-cooled operation up to 75W
- RoHS compliant
- UL Class I and II approved (for IT equipment)

DESCRIPTION

The MVAB120 series switching power supplies utilize advanced component and circuit technologies to deliver high efficiency. Designed for Medical, Telecom, and Industrial applications to satisfy 1U height design considerations, the MVAB120 Series measures only 2.0" x 4.0" x 1.35". All models offer universal AC input with active power factor correction (PFC) and compliance to worldwide safety and EMC standards.



Available now at www.murata-ps.com/en/3d/acdc.html

ORDERING GUIDE

Model Number	Medical Approval ¹	Natural Convection Cooling	Forced Air Cooling	Main Output (V1)
MVAB120-12	No	75W	120W @ 250LFM	12V
MVAB120-12-01	Yes			
MVAB120-24	No			24V
MVAB120-24-01	Yes			
MVAB120-28	No			28V
MVAB120-28-01	Yes			
MVAB120-48	No			48V
MVAB120-48-01	Yes			

INPUT CHARACTERISTICS

Parameter	Conditions	Min.	Typ.	Max.	Units
Input Voltage Operating Range	Single phase	90	120/230	264	Vac
	DC ¹	120		300	Vdc
Input Frequency		47	50/60	63	Hz
Turn-on Input Voltage	Input rising at 75W	76		85	Vac
Turn-off Input Voltage	Input falling at 75W	50			
Input Current	90Vac input, full load			1.9	A
Inrush Current	At 264Vac, at 25°C cold start			75	Apk

OUTPUT CHARACTERISTICS

Model Number	Main Output Voltage (V1)	Load Current	Load Capacitance	Line, Load, Cross Regulation	Typical Efficiency @230Vac full load
MVAB120-12	12V	0 to 10.0A	0 to 3300µF	± 2%	88%
MVAB120-12-01					
MVAB120-24	24V	0 to 5.0A	0 to 1000µF	± 2%	90%
MVAB120-24-01					
MVAB120-28	28V	0 to 4.29A	0 to 1000µF	± 2%	90%
MVAB120-28-01					
MVAB120-48	48V	0 to 2.5A	0 to 1000µF	± 2%	91%
MVAB120-48-01					

MAIN OUTPUT CHARACTERISTICS (ALL MODELS)

Parameter	Conditions	Min.	Max.	Units
Transient Response	50% load step, 1A/µsec slew rate		± 5	%
Settling Time to 1% of Nominal	MVAB120-12		750	µsec
	MVAB120-24, MVAB120-28, MVAB120-48		500	µsec
Turn On Delay	After application of input power		1	sec
Output Voltage Rise	Monotonic, 0 to 75W		50	msec
Setpoint Accuracy	120Vac, 75W, 25°C		± 0.5	%
Output Holdup	Full load	14		msec
Temperature Coefficient			0.02	%/°C
Ripple Voltage & Noise ²			1	%

- 1 Medical versions not designed for DC input voltage.
- 2 Ripple and noise are measured with 0.1 µF of ceramic capacitance and 47 µF of electrolytic capacitance on each of the power supply outputs. The output noise requirements apply over a 0 Hz to 20 MHz bandwidth. A short coaxial cable with 50Ω scope termination is used.
- 3 Unless otherwise specified, all readings are taken at 120Vac input and 25°C ambient temperature.



ENVIRONMENTAL CHARACTERISTICS					
Parameter	Conditions	Min.	Typ.	Max.	Units
Storage Temperature Range		-40		85	°C
Operating Temperature Range	Full load	-10		50	
	50% load	-10		70	
	Start up	-20			
Operating Humidity	Non-condensing	10		95	%
Operating Altitude	Without derating	-200		3000	m
MTBF	Telcordia SR-332 M1C3 25°C	1M			Hours
Shock	Operating, IEC60068-2-27, half-sine 5G, 6ms, 3 times per face, 6 faces	Complies			
	Non-operating, IEC60068-2-27, half-sine, 30G, 18ms, 3 times per face, 6 faces	Complies			
Vibration	Operating, IEC60068-2-6, 1.0G, 10-150Hz, 10minutes per axis, on all 3 axes	Complies			
	Non-operating, IEC60068-2-6, 2.0G, 10-150Hz, 10minutes per axis, on all 3 axes	Complies			
Safety	IEC60950-1:2005 (2nd Edition); Am1:2009 UL60950-1 2nd Edition,2011-12-19, CSA C22.2 No. 60950-1-07, 2nd Edition,2011-12 EN60950-1:2006 + A11:2009 + A1:2010 + A12:2011 IEC60601-1:2005 + CORR.1(2006) + CORR.2(2007) ANSI/AAMI ES60601-1 (2005+C1:09 + A2:10), CSA-C22.2 No. 60601-1(2008), MOPP CE Marking per LVD				
Warranty	2 years				
Outside Dimensions	2.0" x 4.0" x 1.35" (50.8mm x 101.6mm x 34.3mm); 2.0" x 4.0" x 1.41" (50.8mm x 101.6mm x 35.8mm) for medical version				
Weight	MVAB120-12/-01	0.34lbs (155g) typical			
	MVAB120-24/-01, MVAB120-28/-01, MVAB120-48/-01	0.36lbs (162g) typical			

PROTECTION CHARACTERISTICS					
Parameter	Conditions	Min.	Typ.	Max.	Units
Overvoltage Protection	Latching	110		160	%V1
Overcurrent Protection	Hiccup mode	105		150	%Amax
Overtemperature Protection	Auto recovery		Complies		

ISOLATION CHARACTERISTICS					
Parameter	Conditions	Min.	Typ.	Max.	Units
Isolation	Primary to Earth Ground (1MOOP)	1500			Vac
	Primary to Secondary (2MOOP or 1 MOPP)	3000			
	Secondary to Earth Ground	500			Vdc
Leakage Current (under normal conditions)	264Vac, 60Hz, 25°C		500		µA

EMISSIONS AND IMMUNITY		
Characteristic	Standard	Compliance
Input Current Harmonics	IEC/EN 61000-3-2	Class A
Voltage Fluctuation and Flicker	IEC/EN 61000-3-3	Complies
Conducted Emissions	EN 55022	Class B, Class A (at class II equipment)
	FCC Part 15	Class B, Class A (at class II equipment)
ESD Immunity	IEC/EN 61000-4-2	Level 4, Criterion A
Radiated Field Immunity	IEC/EN 61000-4-3	Level 2, Criterion A
Electrical Fast Transient Immunity	IEC/EN 61000-4-4	Level 3, Criterion A
Surge Immunity	IEC/EN 61000-4-5	Level 3, Criterion A
RF Conducted Immunity	IEC/EN 61000-4-6	Level 2, Criterion A
Magnetic Field Immunity	IEC/EN 61000-4-8	Level 1, Criterion A
Voltage dips,interruptions	IEC/EN 61000-4-11	Level 3, Criterion B

PERFORMANCE DATA

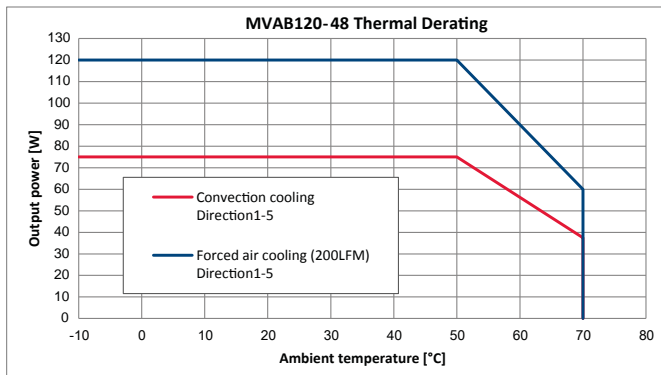
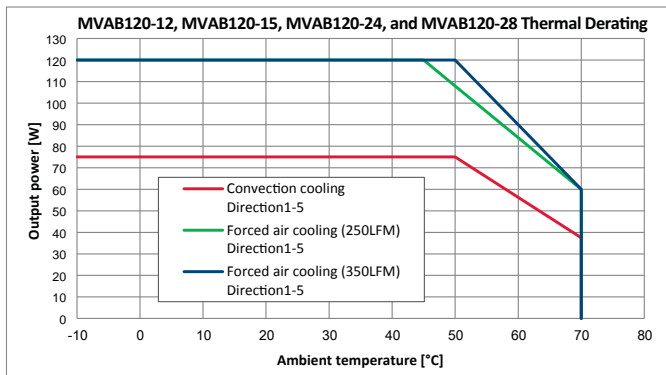
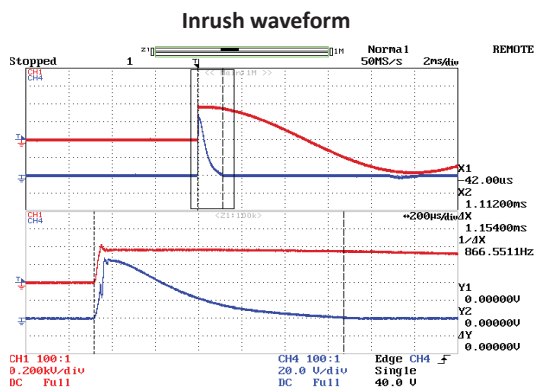
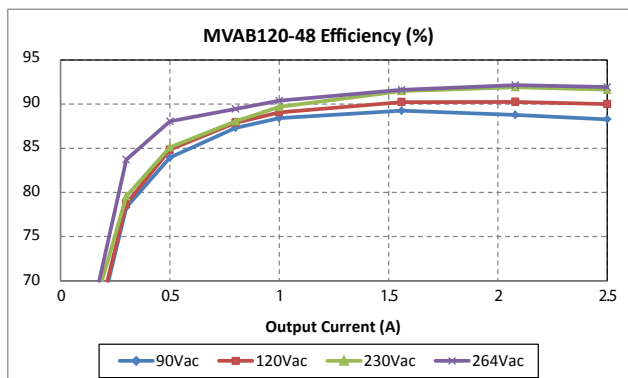
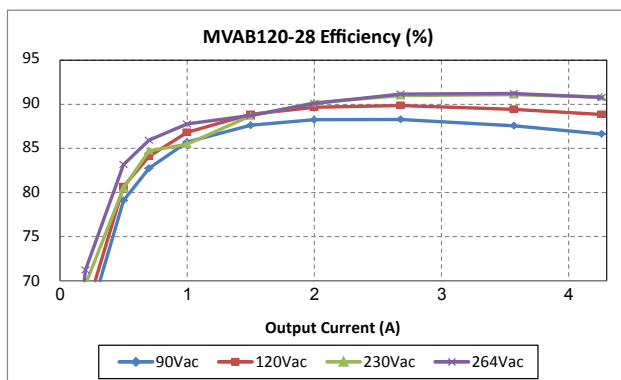
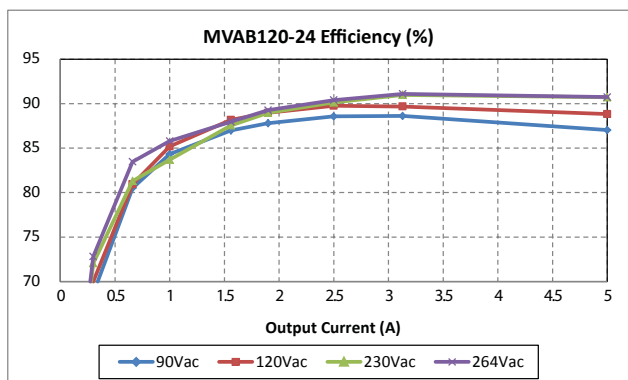
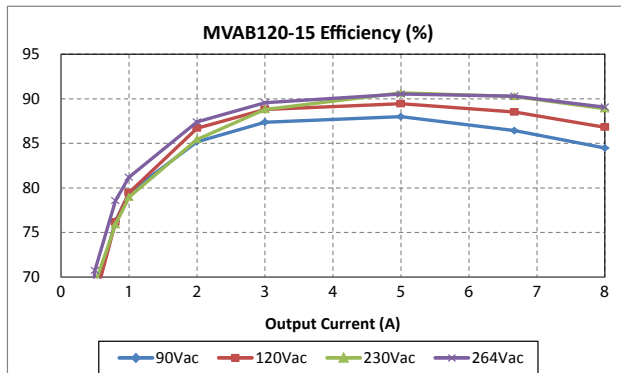
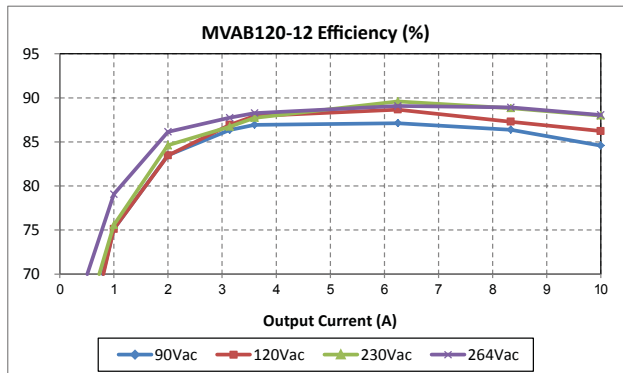

EMI CONSIDERATIONS

For optimum EMI performance, the power supply should be mounted to a metal plate grounded to all 4 mounting holes of the power supply. To comply with safety standards, this plate must be properly grounded to protective earth (see mechanical dimension notes). Pre-compliance testing has shown the stand-alone power supply to comply with EN55022 class A radiated emissions. Radiated emission results vary with system enclosure and cable routing paths.

SAFETY CONSIDERATIONS



1. This power supply is a component level power supply intended for use in class I or class II applications. Secondary ground traces need to be suitably isolated from primary ground traces when used in class II applications.
2. When the power supply is used in class II equipment, all ground traces and components connected to the primary side are considered primary for spacing and insulation considerations.
3. Double pole/neutral fusing (-01 medical versions only).

MECHANICAL DIMENSIONS – MVAB120-12

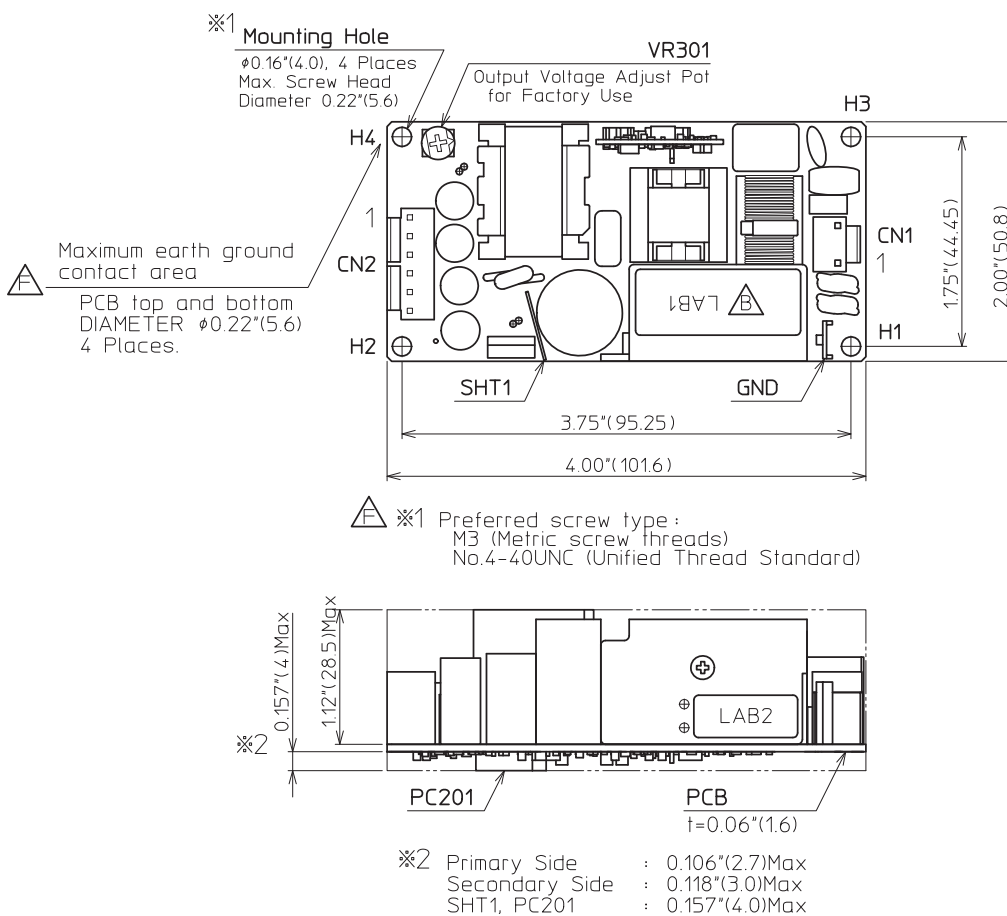

- All dimensions in inches (mm), tolerance is +/-0.02" (0.5mm)
- Mounting holes H1 and H4 should be grounded for EMI purpose
- Mounting hole H1 is safety ground connection
- This power supply requires mounting on standoffs minimum 0.20"(5.0mm) in height

Dimensions: 2.0" x 4.0" x 1.35" (50.8mm x 101.6mm x 34.3mm)

MECHANICAL DIMENSIONS – MVAB120-12-01 (MEDICAL VERSION)

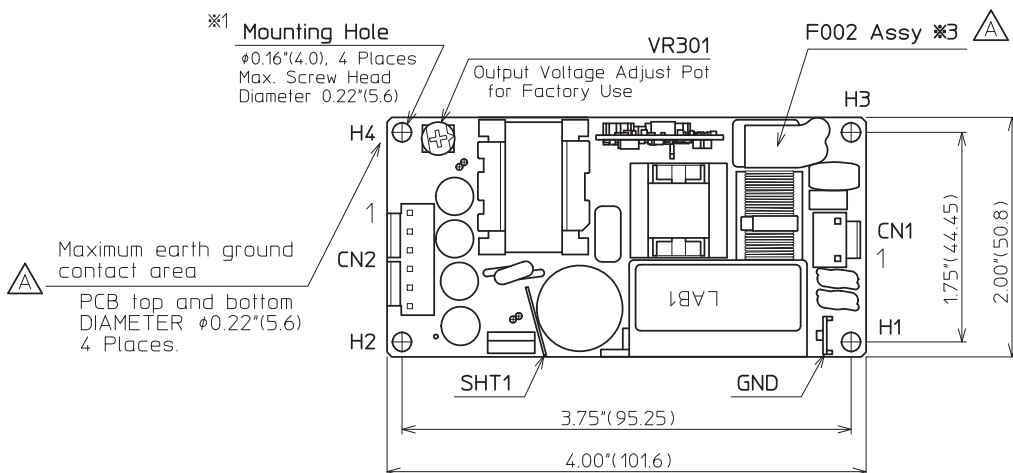

※1 Preferred screw type:
M3 (Metric screw threads)
No.4-40UNC (Unified Thread Standard)

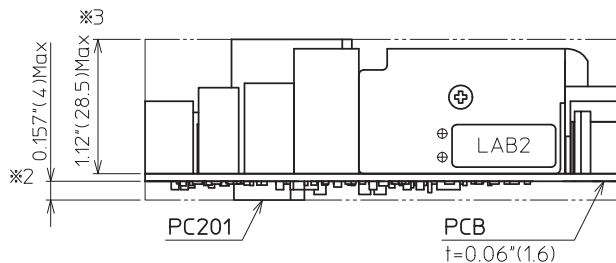

※2 Primary Side : 0.106"(2.7)Max
Secondary Side : 0.118"(3.0)Max
SHT1, PC201 : 0.157"(4.0)Max

⚠ ※3 F002 Assy : 1.18"(30.0)Max

- All dimensions in inches (mm), tolerance is +/-0.02" (0.5mm)
- Mounting holes H1 and H4 should be grounded for EMI purpose
- Mounting hole H1 is safety ground connection
- This power supply requires mounting on standoffs minimum 0.20"(5.0mm) in height

Dimensions: 2.0" x 4.0" x 1.41" (50.8mm x 101.6mm x 35.8mm)

MECHANICAL DIMENSIONS – MVAB120-24, MVAB120-28, and MVAB120-48

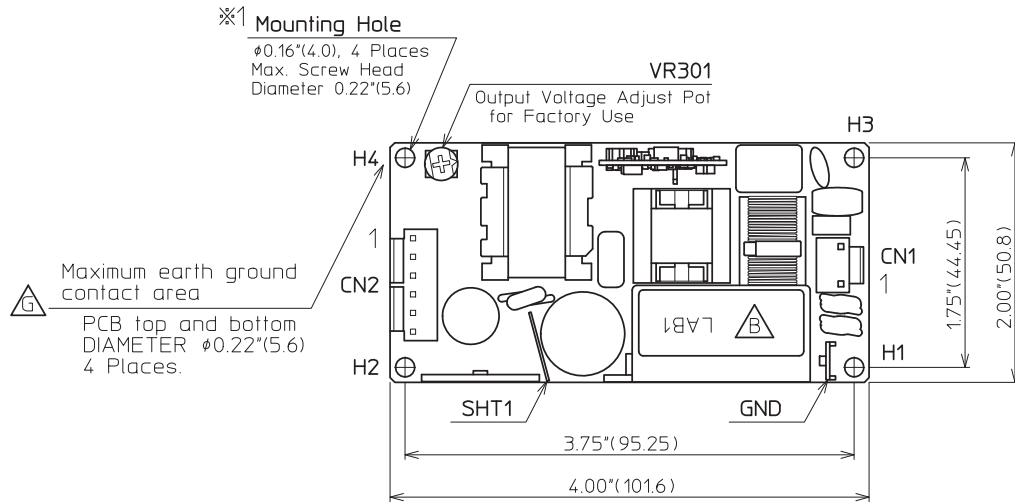

※1 Preferred screw type:
 M3 (Metric screw threads)
 No.4-40UNC (Unified Thread Standard)

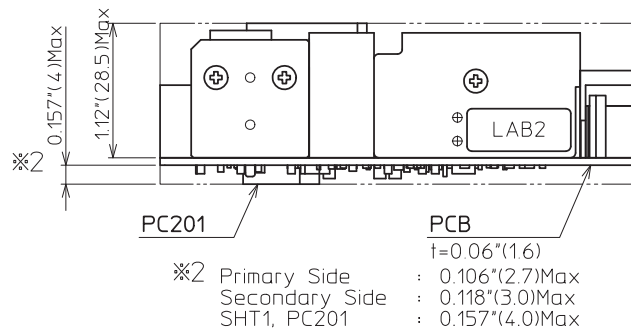

- All dimensions in inches (mm), tolerance is +/-0.02" (0.5mm)
- Mounting holes H1 and H4 should be grounded for EMI purpose
- Mounting hole H1 is safely ground connection
- This power supply requires mounting on standoffs minimum 0.20"(5.0mm) in height

Dimensions: 2.0" x 4.0" x 1.35" (50.8mm x 101.6mm x 34.3mm)

MECHANICAL DIMENSIONS – MVAB120-24-01, MVAB120-28-01, and MVAB120-48-01 (MEDICAL VERSION)

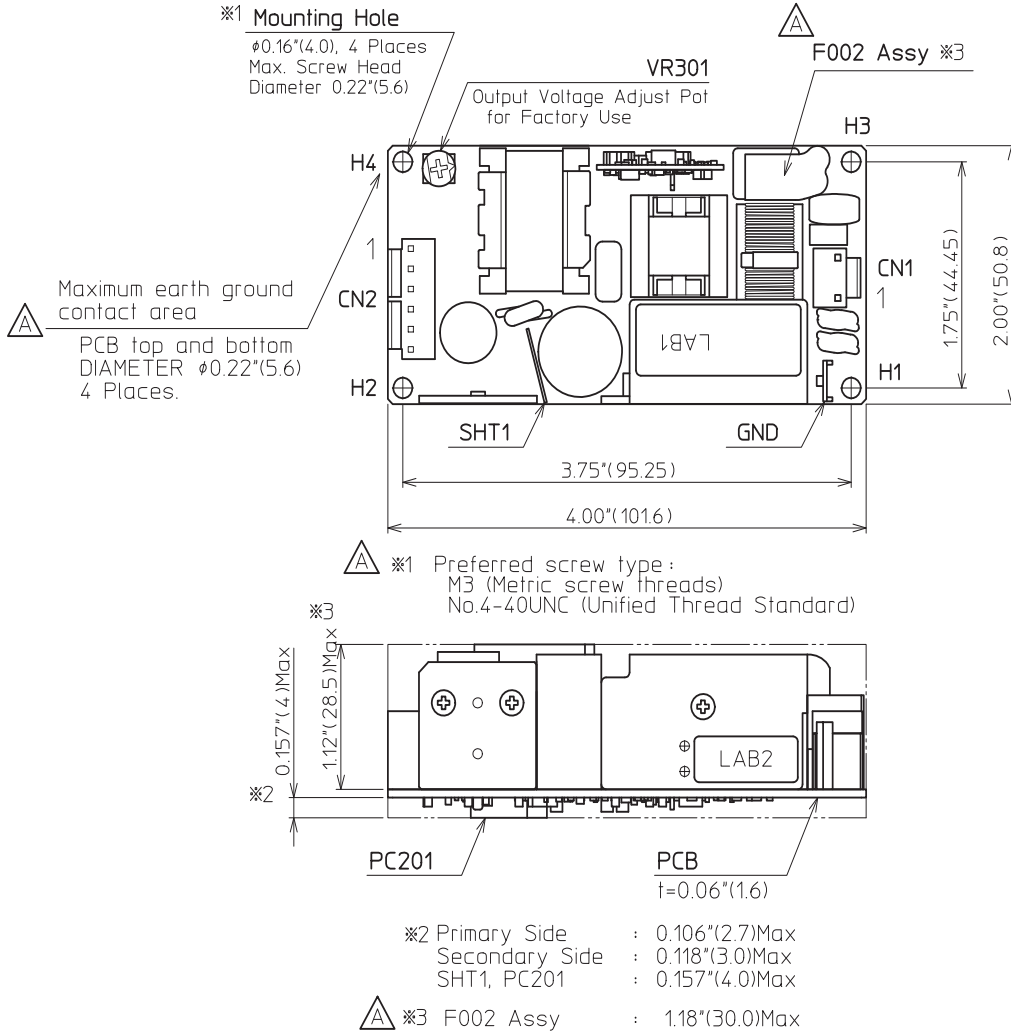

-All dimensions in inches (mm), tolerance is +/-0.02" (0.5mm)
 -Mounting holes H1 and H4 should be grounded for EMI purpose
 -Mounting hole H1 is safety ground connection
 -This power supply requires mounting on standoffs minimum 0.20"(5.0mm) in height

Dimensions: 2.0" x 4.0" x 1.41" (50.8mm x 101.6mm x 35.8mm)

INPUT/OUTPUT CONNECTOR AND SIGNAL SPECIFICATION AND MATING CONNECTORS

PIN	Description	Mating Housing	Crimp terminal/pins
Input Connector CN1 : Molex 26-62-4030			
1	AC Neutral	Molex 09-50-8031 with locking ramp	Molex 6838 Series
3	AC Line		
Spade Connector: #250			
GND	Earth Ground		
Output Connector CN2 : Molex 26-60-4060			
1, 2, 3	DC Return	Molex 09-50-8061 with locking ramp	Molex 6838 Series
4, 5, 6	V1		

Murata Power Solutions, Inc.
 11 Cabot Boulevard, Mansfield, MA 02048-1151 U.S.A.
 ISO 9001 and 14001 REGISTERED



This product is subject to the following operating requirements and the Life and Safety Critical Application Sales Policy. Refer to: <http://www.murata-ps.com/requirements/>

Murata Power Solutions, Inc. ("Murata") makes no representation that the use of its products in the circuits described herein, or the use of other technical information contained herein, will not infringe upon existing or future patent rights. The descriptions contained herein do not imply the granting of licenses to make, use, or sell equipment constructed in accordance therewith. Buyer represents and agrees that it has all the necessary expertise to create and implement safeguards that anticipate dangerous consequences of failures, monitor failures and their consequences, lessen the likelihood of failures that might cause harm, and take appropriate remedial actions. Buyer will fully indemnify Murata, its affiliated companies, and its representatives against any damages arising out of the use of any Murata products in safety-critical applications. Specifications are subject to change without notice.

© 2014 Murata Power Solutions, Inc.

X-ON Electronics

Largest Supplier of Electrical and Electronic Components

Click to view similar products for [Switching Power Supplies](#) category:

Click to view products by [Murata](#) manufacturer:

Other Similar products are found below :

[70841011](#) [73-551-0005](#) [73-551-0048](#) [PS3E-B12F](#) [PS3E-E12F](#) [AAD600S-4-OP](#) [R22095](#) [KD0204](#) [9021](#) [LDIN100150](#) [LPM000-BBAR-01](#)
[LPX17S-C](#) [EVS57-10R6/R](#) [FP80](#) [FRV7000G](#) [22929](#) [PS3E-F12F](#) [CQM1IA121](#) [40370121900](#) [VI-PU22-EXX](#) [40370121910](#) [LDIN5075](#)
[LPM615-CHAS](#) [LPX140-C](#) [09-160CFG](#) [70841025](#) [VPX3000-CBL-DC](#) [LPM000-BBAR-05](#) [LPM000-BBAR-08](#) [LPM124-OUTA1-48](#)
[LPM000-BBAR-07](#) [LPM109-OUTA1-10](#) [LPM616-CHAS](#) [08-30466-1055G](#) [08-30466-2175G](#) [08-30466-2125G](#) [DMB-EWG](#) [TVQF-1219-](#)
[18S](#) [6504-226-2101](#) [CQM1IPS01](#) [SP-300-5](#) [CQM1-IPS02](#) [VI-MUL-ES](#) [22829](#) [08-30466-0065G](#) [VI-RU031-EWWX](#) [08-30466-0028G](#) [VI-](#)
[LUL-EU](#) [EP3000AC48INZ](#) [VP-C2104853](#)