

MURATA PRODUCTS

Lineup 2021



2021 MURATA PRODUCTS Lineup

p2

Capacitors

Ceramic Capacitors, Polymer Aluminum Electrolytic Capacitors	4
Single-Layer Microchip Capacitors, Thin Film Circuit Substrates (RUSUB)	32
Variable Capacitors	36
Silicon Capacitors	36
Film Capacitors	42

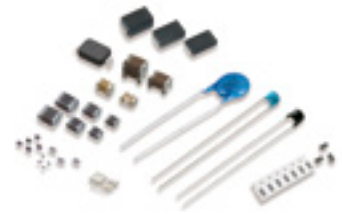

p43

Noise Suppression Products/EMI Suppression Filters

Chip Ferrite Bead	43
Application Specified Noise Filter	45
LC Combined Filter	46
Common Mode Choke Coil/Common Mode Noise Filter	47
Block Type EMIFIL	48
Noise Suppression Filters (Lead Type), Others	49
ESD Protection Devices	49

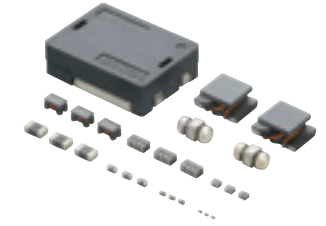

p50

Inductors (Coils)

Inductors for Power Lines	51
RF Inductors	58
General Circuit Inductors	61
Variable Inductors	62



p64

Resistors

High Voltage Resistors	64
------------------------	----

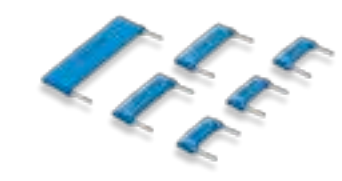

p65

Timing Devices

MEMS Resonator	66
Crystal Units	66
Ceramic Resonators CERALOCK	67



p69

Filters

Crystal Filters	69
SAW Filters for Mobile Communications	69
Dielectric Filters GIGAFIL	70
Chip Multilayer LC Filters	71



p72

RF Components

Antennas	72	Chip Multilayer Hybrid Dividers	73
Baluns	72	Chip Multilayer Diplexers	74
Couplers	73	Microwave Connectors	74



p76

Sensors

Pyroelectric Infrared Sensors	78	Accelerometers	78
Ultrasonic Sensors	78	Inclinometers	78
AMR Sensors (Magnetic Sensors)	78	Gyro Sensors	78
TMR Sensors (Magnetic Sensors)	78	Temperature Sensors (Thermistors)	78





Thermistors

NTC Thermistors for Temperature Sensor/Temperature Compensation	80
PTC Thermistors POSISTOR for Overheat Sensing	82
PTC Thermistors POSISTOR for Overcurrent Protection	82



Power Devices

DC-DC Converters	83
Ballast Power Supplies	85
Power supplies for LED lighting	85



Batteries

Laminated Type Lithium Ion		FORTELION 24V Battery Module	90
Secondary Batteries	86	FORTELION Battery System	91
Cylindrical Type Lithium Ion		Coin Manganese Dioxide	
Secondary Batteries	89	Lithium Batteries	93
Small Lithium ion		Silver Oxide Batteries &	
Secondary Batteries	89	Alkaline Manganese Batteries	96



Sound Components (Buzzer)

SMD Piezoelectric Sounders	98
Pin Type Piezoelectric Sounders	99
Piezoelectric Buzzers	99
Piezoelectric Diaphragms	99



Others

Wireless Communication Modules	100	Ozonizer Modules: Ionissimo	103
Micromechatronics	101	RFID Devices	104
Ionizer Modules: Ionissimo	102	Femtet, CAE Software	105



p2
p43
p50
p64
p65
p69
p72
p76
p80
p83

p86
p98
p100
p107

Application Guides

Communications equipment	108	Healthcare & medical	142
<ul style="list-style-type: none"> ● Baseband unit (BBU) DU / CU [p108] ● Remote radio unit (RRU) mmWave band [p110] ● Remote radio unit (RRU) less than sub-6GHz band [p112] ● CPE (FWA device) [p114] ● OLT (Optical line terminal) [p116] ● ONU (Optical network units) [p117] ● Core router [p118] ● Home router [p119] ● Switch [p120] 		<ul style="list-style-type: none"> ● Blood pressure monitor [p142] ● Thermometer [p144] ● Hearing aid [p145] ● Blood glucose meter [p146] ● Insulin pump [p147] ● Skin patch [p148] ● Diagnostic imaging apparatus [p149] 	
Enterprise system	121	Personal electronics	150
<ul style="list-style-type: none"> ● Server [p121] ● Network switch [p122] ● DCIM (Data center infrastructure management) [p123] ● Hardware accelerator [p124] ● Storage system [p125] 		<ul style="list-style-type: none"> ● Smart phone [p150] ● Smart watch / health tracker [p152] ● AR / VR [p154] ● True wireless stereo (non-medical use) [p156] ● PC [p158] ● Tablet PC [p160] ● AI speaker [p162] ● Vacuum cleaner [p163] ● Air conditioner [p164] ● Washing machine [p166] ● Refrigerator [p167] ● Air purifier [p168] ● Microwave oven [p170] ● IH rice cooker [p171] 	
Industrial	126	Mobility	172
<ul style="list-style-type: none"> ● PLC (Programmable logic controller) [p126] ● AGV (Automatic guided vehicle) [p128] ● Lighting [p129] ● Thermostat [p130] ● Security camera [p132] ● HEMS (Home energy management system) [p134] ● Entrance and exit management system [p136] ● Human detection [p138] ● Smart meter [p140] 		<ul style="list-style-type: none"> ● Inverter [p172] ● BMS (Battery management system) [p173] ● OBC (On board charger) [p174] ● DC-DC converter [p175] ● Engine ECU [p176] ● TCU (Telematics control unit) [p177] ● IVI (In vehicle infotainment) [p178] ● ADAS (Advanced driver assist system) [p180] ● IPA (Intelligent parking assist) [p182] ● Lidar [p183] ● Radar [p184] ● Front camera [p185] ● Automotive lighting [p186] ● EPS (Electric power steering) [p187] ● PKE / TPMS [p188] ● Gateway / in-vehicle LAN [p189] ● Motorcycle [p190] ● General Purpose [p192] 	
Design Support Tool SimSurfing	194		
Index	195		

Capacitors

The most comprehensive product lineup in the industry, providing ideal solutions, responding to all possible requirements.

Summary

Using Murata's unique ceramic material technology, we offer a wide lineup of products. Murata also offers technical support that includes design kits and a comprehensive set of software tools to simulate virtually any circuit condition, satisfying the demands of many applications. We are also expanding our lineup of products that use non-ceramic dielectric materials, such as silicon capacitors, to support various applications.

Lineup

- Ceramic Capacitors (SMD, lead type)
- Polymer Aluminum Electrolytic Capacitors
- Single-Layer Microchip Capacitors
- Thin Film Circuit Substrates (RUSUB) ●Variable Capacitors
- Silicon Capacitors ●Film Capacitors



<https://www.murata.com/en-global/products/capacitor>



Ceramic Capacitors

p4

Murata offers the No. 1 most abundant lineup in the industry, responding to all possible needs, and proposing ideal solutions.

Polymer Aluminum Electrolytic Capacitors

These are high-capacity capacitors that are characterized by a low profile and low ESR. They handle the stabilization of voltage in circuits where serious voltage control is demanded, and contribute to the advanced features in customer products.

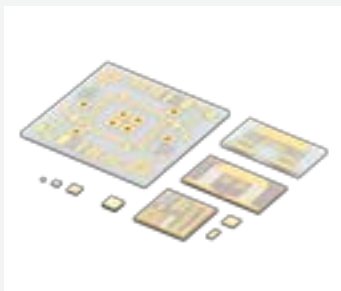

Single-Layer Microchip Capacitors

p32

Simple single-layer structure provides very reliable performance and excellent frequency characteristics. A wide selection of sizes from 0.25mm square enables the miniaturization of the circuit and higher density.

Thin Film Circuit Substrates (RUSUB)

RUSUB technology combines capacitor and thin film resistor in one chip. Custom specifications (dimensions, capacitance values, etc.) are also available upon request.

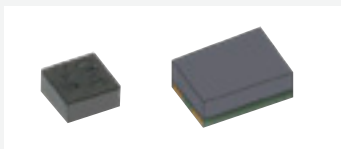

Variable Capacitors

p36

Variable capacitors can carry out the variable of the capacitor by adjusting the tuning voltage. They are designed for frequency matching use for HF band (13.56MHz).

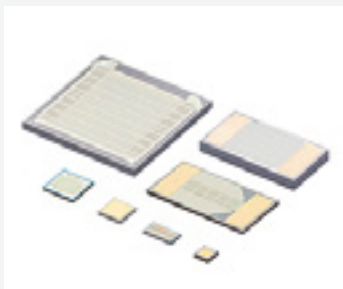

Silicon Capacitors

p36

Murata High-Density Silicon Capacitors are based on a MOS Semiconductor technology and utilize a 3D structure that substantially increases their performance and enables compact design. Silicon Capacitors offer small size and low thickness, superior reliability, and stability over high temperatures and high frequencies. They are the ideal choice for all demanding markets, such as Networking (RF Power and Broadband), Medical (Implantable devices), Automotive, or High-Reliability applications. Murata can provide customized Silicon Capacitors or Integrated Passive Devices (IPDs) to optimize your design.



Film Capacitors

p42

The FH series uses materials with high heat resistance. Therefore, it has a higher allowable ripple current under a higher temperature environment than conventional PP film capacitors.

This feature is more prominent in the high-frequency range. For example, when the ambient temperature is at 105°C, the PP film capacitors would be already at its limit for allowable ripple current, but because of the higher heat resistance of the FH series, the allowable ripple current can be increased drastically.

WEB Product Search Engine

<https://www.murata.com/search/productsearch?cate=cgsubCeramicCapacitors>

You can search for products in a variety of ways, including part number, specifications, and lineup.

1 Search by Part Number

You can search for capacitors by specifying the alphanumeric characters in the part number. The packing codes shown contain the substitute character "#". If you enter the official packing code, part numbers that contain that packing code will be matched.



3 Search in the Lineups

You can search for capacitors by specifying the series lineup. You can also confirm items such as characteristics and applications on each series page.

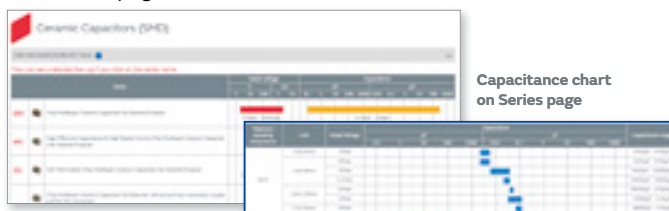

2 Search by Specifications

You can search for SMD or lead type capacitors by indicating specifications such as application, capacitance, rated voltage, or temperature characteristics. You can narrow your search by entering values of ranges, and by specifying product characteristics. The items for narrowing searches are linked, so specifying one condition causes selectable options for the other items to allow input only of conditions that match the relevant part numbers.



Search results

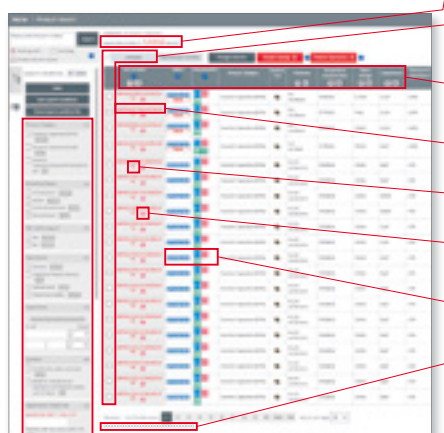

- Displays the number of hits for the current search conditions in real time.
- Compares the characteristics of the checked part numbers.
- Click the ▲ mark for each item to switch between ascending and descending display.
- Click a product name to display a details page listing more in-depth information.
- You can download detailed spec sheets.
- For some products it is possible to request a free sample.
- Icons enable you to check the status and characteristics of products at a glance.
- You can confirm the current conditions for narrowing the search results.
- You narrow the search results to match the selected condition in real time.

Ceramic Capacitors, Polymer Aluminum Electrolytic Capacitors

Ceramic Capacitors, Polymer Aluminum Electrolytic Capacitors

Icons

	For applications that do not require a particular reliability, such as general equipment.
	Infotainment for Automotive Products for entertainment equipment like car navigation, car audio, and body control equipment like wipers and power windows.
	Powertrain/Safety for Automotive Products used for applications (running, turning, stopping, and safety devices) that particularly concern human life, such as in devices for automotive.
	Medical-grade products for Implanted Medical Devices These products are intended for use in implanted medical devices such as cardiac pacemakers, cochlear implants, insulin pumps, and gastric electrostimulators. They are suitable for use in non-critical circuits.*1 *1 Non-critical circuits This term refers to circuits in implanted medical devices that are not directly linked to life support, i.e., circuits that will not directly endanger the life of the patient should the functionality of the device be reduced or halted by failure of the circuit.
	AEC-Q200 compliant product
	Products that acquired safety standard certification IEC60384-14.
	Products that are based on the Electrical Appliance and Material Safety Law of Japan.
	Low dissipation for high frequency By devising ceramic materials and electrode materials, low dissipation is achieved in frequency bands of VHF, UHF, and microwave or beyond.
	Low inductance This capacitor is designed so that the parasitic inductance component (ESL) that the capacitor has on the high frequency side becomes lower.
	Product resistant to deflection cracking This capacitor is designed to prevent failures as much as possible by short mode caused by cracking when there is board deflection.
	Product with solder cracking suppression This capacitor is configured with metal terminals and leads connected to the chip. The metal terminals and leads relieve the stress from expansion and contraction of the solder, to suppress solder cracking.
	Product suitable for acoustic noise reduction and low distortion This product suppresses acoustic noise, which occurs when a ceramic capacitor is used, by devising the materials and configuration.
	No DC bias characteristics Polymer capacitor is no capacitance change with DC bias due to aluminum oxidized film for dielectric.
	Low-inductance product suitable for noise suppression This product has extremely low ESL and is suitable for suppression of noise, including high frequencies.
	Product for bonding Since gold is used for the external electrodes, the capacitor can be mounted by die bonding/wire bonding.
	Limited to Conductive Glue Mounting Since silver palladium is used for the external electrodes, the capacitor can be mounted by conductive adhesive.

Ceramic Capacitors, Polymer Aluminum Electrolytic Capacitors

Product Lineup

For general			
General	SMD		
Solder mounting			
Chip type			
	GRM		p6
	GR3	Low acoustic noise	High effective capacitance & high ripple current p8
	GRJ	Deflecting crack	Soft termination p8
	GR4		For information devices only p9
	GJM	High Q	p9
	GQM	High Q	p10
	GA2	Japanese Safety Law	Based on the Electrical Appliance and Material Safety Law of Japan p10
	GA3	Safety standard	p10
	LLL	Low ESL	LW reversed p11
	LLA	Low ESL	8 terminals p12
	LLM	Low ESL	10 terminals p12
	LLR	Low ESL	LW reversed controlled ESR p12
	NFM	Low ESL EMI Filter	3 terminals p12
	GJ4	Low acoustic noise	Low distortion p13
On interposer board			
	ZRA	Low acoustic noise	p13
	ZRB	Low acoustic noise	p13
Metal terminal type			
	KRM	Low acoustic noise Deflecting crack Soldering crack	p14
	KR3	Low acoustic noise Deflecting crack Soldering crack	High effective capacitance & high ripple current p14
Resin molding SMD type			
	DK1	Safety standard	p30
Polymer Aluminum Electrolytic Capacitors			
	ECAS	Low acoustic noise Deflecting crack Effective Cap	p31
Wire bonding mounting			
Bonding	Chip type		
	GMA		Microchip p14
	GMD		p15
Lead type			
Solder mounting			
	RDE	Low acoustic noise Deflecting crack Soldering crack	p24
	DE1	Safety standard	X1/Y1 Class certified product p26
	DE2	Safety standard	X1/Y2 Class certified product p27

Infotainment for automotive			
Infotainment	SMD		
AEC-Q200	Solder mounting		
Chip type			
	GRT		p15
	NFM	Low ESL EMI Filter	3 terminals p17

Powertrain/Safety for automotive			
Powertrain	SMD		
AEC-Q200	Solder mounting		
Chip type			
	GCM		p17
	GC3	Low acoustic noise	High effective capacitance & high ripple current p18
	GCJ	Deflecting crack	Soft termination p19
	GCQ	High Q	p20
	GCD	Deflecting crack	MLSC design p20
	GCE	Deflecting crack	Soft termination MLSC design p20
	LLC	Low ESL	LW reversed WEB p20
	NFM	Low ESL EMI Filter	3 terminals p20
Metal terminal type			
	KCM	Low acoustic noise Deflecting crack Soldering crack	p21
	KC3	Low acoustic noise Deflecting crack Soldering crack	High effective capacitance & high ripple current p21
	KCA	Safety standard Low acoustic noise Deflecting crack Soldering crack	p21
Limited to Conductive Glue Mounting			
Limited to automotive	Chip type		
	GCB	Deflecting crack Soldering crack	Ni plating + Pd plating termination conductive glue mounting p22
	GCG	Deflecting crack Soldering crack	AgPd termination conductive glue mounting p22
Lead type			
Solder mounting			
	RCE	Low acoustic noise Deflecting crack Soldering crack	p28
	RHE	Low acoustic noise Deflecting crack Soldering crack	150°C operation leaded p29
	RHS	Low acoustic noise Deflecting crack Soldering crack	200°C operation leaded p30
	DE6	Safety standard	p30

Medical-grade products for implanted medical devices			
Medical Device	SMD		
Solder mounting			
Chip type			
	GCH		p23

Ceramic capacitors SMD type For General Purpose

Chip Multilayer Ceramic Capacitors for General Purpose



GRM

Temperature Compensating Type

General

Series	LXW (mm) <Size Code (inch)>	Rated Voltage (Vdc)	Capacitance Range (F)																		
			0.1p	1p	10p	100p	1000p	10000p	0.1μ	1μ	10μ	100μ	1000μ								
GRM01	0.25X0.125 <008004>	25	0.20pF				100pF														
		16	0.20pF				100pF														
GRM02	0.4X0.2 <01005>	50	0.20pF				100pF														
		35					100pF														
		25	0.20pF					220pF													
		16	0.20pF					220pF													
		10					51pF		220pF												
		6.3					51pF		220pF												
GRM03	0.6X0.3 <0201>	100	0.10pF				100pF														
		50	0.10pF					1000pF													
		25	0.10pF					1000pF													
GRM15	1.0X0.5 <0402>	100					120pF		1000pF												
		50					270pF		8200pF												
		35							10000pF												
		25							10000pF												
		10							2400pF		4700pF										
GRM18	1.6X0.8 <0603>	250			10pF		47pF														
		100						1000pF		3900pF											
		50						1000pF		10000pF											
		10							5600pF		33000pF										
		6.3							24000pF		33000pF										
GRM21	2.0X1.25 <0805>	630			10pF			2200pF													
		250			10pF				10000pF												
		200			10pF				5600pF												
		100							1000pF		22000pF										
		50							2400pF		47000pF										
		10									33000pF		0.10μF								
GRM31	3.2X1.6 <1206>	2000			10pF		68pF														
		1000			10pF			1000pF													
		630			10pF				10000pF												
		500			10pF				4700pF												
		250							6800pF		22000pF										
		200							6800pF		10000pF										
		100							4300pF		0.10μF										
		50							11000pF		0.22μF										
		25								0.15μF	0.22μF										
GRM32	3.2X2.5 <1210>	2000			82pF		220pF														
		1000					1200pF		2200pF												
		630					1200pF		33000pF												
		500					1200pF		10000pF												
GRM42	4.5X2.0 <1808>	3150			10pF		100pF														
GRM43	4.5X3.2 <1812>	1000						2700pF		4700pF											
		630							12000pF		22000pF										
		500							12000pF		22000pF										
GRM55	5.7X5.0 <2220>	1000						5600pF		10000pF											
		630							27000pF		47000pF										
		500							27000pF		47000pF										

Continued on the following page. ↗

Ceramic Capacitor, Polymer Aluminum Electrolytic Capacitors

High Dielectric Constant Type

Series	LXW (mm) <Size Code (inch)>	Rated Voltage (Vdc)	Capacitance Range (F)												
			0.1p	1p	10p	100p	1000p	10000p	0.1μ	1μ	10μ	100μ	1000μ		
GRM01	0.25X0.125 <008004>	10				100pF	680pF								
		6.3					1000pF	10000pF							
		4					3300pF	10000pF							
GRM02	0.4X0.2 <01005>	16				56pF	10000pF								
		10				56pF	0.10μF								
		6.3					680pF	0.47μF							
		4					15000pF	0.47μF							
GRM03	0.6X0.3 <0201>	2.5						0.10μF	0.47μF						
		50				100pF	1500pF								
		35							0.10μF						
		25				100pF	0.22μF								
		16				100pF	2.2μF								
GRM15	1.0X0.5 <0402>	10					1000pF	2.2μF							
		6.3					1200pF	4.7μF							
		4					12000pF	4.7μF							
		2.5						0.22μF	4.7μF						
		100				220pF	0.10μF								
		50					2200pF	1.0μF							
		35						0.22μF	2.2μF						
GRM18	1.6X0.8 <0603>	25					22000pF	2.2μF							
		16					22000pF	2.2μF							
		10					47000pF	22μF							
		6.3					22000pF	22μF							
		4						0.47μF	22μF						
		2.5							2.2μF	22μF					
		100					10000pF	0.10μF							
GRM21	2.0X1.25 <0805>	50						0.22μF	2.2μF						
		35						0.47μF	10μF						
		25						0.22μF	10μF						
		16						0.47μF	10μF						
		10							2.2μF	22μF					
		6.3							2.2μF	47μF					
		4							2.2μF	47μF					
GRM31	3.2X1.6 <1206>	2.5							10μF	47μF					
		100					47000pF	1.0μF							
		50						0.47μF	10μF						
		35						1.0μF	10μF						
		25							2.2μF	22μF					
		16							4.7μF	22μF					
		10							4.7μF	47μF					
GRM32	3.2X2.5 <1210>	6.3							10μF	100μF					
		4							22μF	100μF					
		2.5								47μF	100μF				
		100								4.7μF					
		50							4.7μF	10μF					
		35								10μF					
		25								10μF	22μF				
GRM33	3.2X2.5 <1210>	16								22μF	47μF				
		25								22μF					
		100									10μF				

Continued on the following page. ↗

Ceramic Capacitor, Polymer Aluminum Electrolytic Capacitors

Series	LXW (mm) <Size Code (inch)>	Rated Voltage (Vdc)	Capacitance Range (F)											
			0.1p	1p	10p	100p	1000p	10000p	0.1μ	1μ	10μ	100μ	1000μ	
GRM32	3.2X2.5 <1210>	10										47μF	100μF	
		6.3										47μF	220μF	
		4										100μF	330μF	
		2.5										220μF	330μF	
GRM43	4.5X3.2 <1812>	1250						33000pF	47000pF					
		1000						33000pF	0.10μF					
		630						68000pF	0.10μF					
		500							0.15μF	0.22μF				
		250							0.15μF	0.47μF				
GRM55	5.7X5.0 <2220>	1250						68000pF	0.10μF					
		1000						68000pF	0.22μF					
		630							0.15μF	0.22μF				
		500							0.33μF	0.47μF				
		250							0.33μF	1.0μF				
		200							0.33μF	1.0μF				
GRMJN	1.8X1.0 <0704>	16										20μF	22μF	
		6.3										43μF		
GRMMD	0.5X0.25 <015008>	6.3											1.0μF	

High Effective Capacitance & High Ripple Current Chip Multilayer Ceramic Capacitors for General Purpose



General
Low acoustic noise

Series	LXW (mm) <Size Code (inch)>	Rated Voltage (Vdc)	Capacitance Range (F)											
			0.1p	1p	10p	100p	1000p	10000p	0.1μ	1μ	10μ	100μ	1000μ	
GR321	2.0X1.25 <0805>	250						10000pF	22000pF					
GR331	3.2X1.6 <1206>	630						10000pF	15000pF					
		450						10000pF	47000pF					
		250						33000pF	68000pF					
GR332	3.2X2.5 <1210>	630						22000pF	47000pF					
		450						68000pF	0.10μF					
		250							0.10μF	0.15μF				
GR343	4.5X3.2 <1812>	630							68000pF					
		450								0.15μF				
		250								0.22μF	0.33μF			
GR355	5.7X5.0 <2220>	630							0.10μF	0.22μF				
		450								0.22μF	0.47μF			
		250								0.47μF	1.0μF			

Chip Multilayer Ceramic Capacitors with Soft Termination for General Purpose



General
Deflecting crack

Series	LXW (mm) <Size Code (inch)>	Rated Voltage (Vdc)	Capacitance Range (F)											
			0.1p	1p	10p	100p	1000p	10000p	0.1μ	1μ	10μ	100μ	1000μ	
GRJ03	0.6X0.3 <0201>	10											1.0μF	
		6.3											1.0μF	
GRJ15	1.0X0.5 <0402>	6.3											10μF	
GRJ18	1.6X0.8 <0603>	10											10μF	
		6.3											4.7μF	10μF
GRJ21	2.0X1.25 <0805>	100											1.0μF	

Continued on the following page. ↗

Ceramic Capacitor, Polymer Aluminum Electrolytic Capacitors

Series	LXW (mm) <Size Code (inch)>	Rated Voltage (Vdc)	Capacitance Range (F)													
			0.1p	1p	10p	100p	1000p	10000p	0.1μ	1μ	10μ	100μ	1000μ			
GRJ21	2.0X1.25 <0805>	25												10μF		
GRJ31	3.2X1.6 <1206>	100												4.7μF		
		50												4.7μF		
GRJ32	3.2X2.5 <1210>	25												22μF		
		10												47μF		
GRJ43	4.5X3.2 <1812>	1000							33000pF	47000pF						
		630							68000pF	0.10μF						
		250								0.15μF	0.47μF					
GRJ55	5.7X5.0 <2220>	1000							68000pF	0.10μF						
		630							0.15μF	0.22μF						
		250								0.33μF	1.0μF					

Chip Multilayer Ceramic Capacitors for Ethernet LAN and primary-secondary coupling of DC-DC converters

Series	LXW (mm) <Size Code (inch)>	Rated Voltage (Vdc)	Capacitance Range (F)													
			0.1p	1p	10p	100p	1000p	10000p	0.1μ	1μ	10μ	100μ	1000μ			
GR4																
GR442	4.5X2.0 <1808>	2000					100pF	1500pF								
GR443	4.5X3.2 <1812>	2000						1800pF	4700pF							
GR455	5.7X5.0 <2220>	2000														10000pF

Chip Multilayer Ceramic Capacitors for Splitter Circuit of G-Fast, xDSL

Series	LXW (mm) <Size Code (inch)>	Rated Voltage (Vdc)	Capacitance Range (F)													
			0.1p	1p	10p	100p	1000p	10000p	0.1μ	1μ	10μ	100μ	1000μ			
GR4																
GR431	3.2X1.6 <1206>	630						1000pF	4700pF							
GR432	3.2X2.5 <1210>	630							5600pF	15000pF						

High Q Chip Multilayer Ceramic Capacitors for General Purpose ($\leq 100Vdc$)

Series	LXW (mm) <Size Code (inch)>	Rated Voltage (Vdc)	Capacitance Range (F)														
			0.1p	1p	10p	100p	1000p	10000p	0.1μ	1μ	10μ	100μ	1000μ				
GJM02	0.4X0.2 <01005>	25	0.20pF														
		16	0.20pF														
GJM03	0.6X0.3 <0201>	100		0.30pF													
		50		0.20pF													
		25		0.20pF													
		6.3				22pF	33pF										
GJM15	1.0X0.5 <0402>	50	0.10pF													47pF	

Continued on the following page. ↗

Ceramic Capacitor, Polymer Aluminum Electrolytic Capacitors

High Q Chip Multilayer Ceramic Capacitors for General Purpose (>100Vdc)



GQM

General High Q

Series	LXW (mm) <Size Code (inch)>	Rated Voltage (Vdc)	Capacitance Range (F)											
			0.1p	1p	10p	100p	1000p	10000p	0.1μ	1μ	10μ	100μ	1000μ	
GQM15	1.0X0.5 <0402>	200	0.10pF			33pF								
GQM18	1.6X0.8 <0603>	250	0.10pF			100pF								
GQM21	2.0X1.25 <0805>	500	0.20pF			22pF								
		250	0.20pF			150pF								
GQM22	2.8X2.8 <1111>	500	0.30pF			100pF								

Based on the Electrical Appliance and Material Safety Law of Japan Chip Multilayer Ceramic Capacitors for General Purpose



GA2

General Japanese Safety Law

Series	LXW (mm) <Size Code (inch)>	Rated Voltage (Vac (r.m.s.))	Capacitance Range (F)											
			0.1p	1p	10p	100p	1000p	10000p	0.1μ	1μ	10μ	100μ	1000μ	
GA242	4.5X2.0 <1808>	250					470pF	1000pF						
GA243	4.5X3.2 <1812>	250					2200pF	47000pF						
GA255	5.7X5.0 <2220>	250								0.10μF				

Safety Standard Certified Chip Multilayer Ceramic Capacitors for General Purpose Type GB / IEC60384-14 Class X2



GA3 Type GB

General Safety standard

Series	LXW (mm) <Size Code (inch)>	Rated Voltage (Vac (r.m.s.))	Capacitance Range (F)											
			0.1p	1p	10p	100p	1000p	10000p	0.1μ	1μ	10μ	100μ	1000μ	
GA355	5.7X5.0 <2220>	250						10000pF	56000pF					

Safety Standard Certified Chip Multilayer Ceramic Capacitors for General Purpose Type GD / UL60950-1



GA3 Type GD

General Safety standard

Temperature Compensating Type

Series	LXW (mm) <Size Code (inch)>	Rated Voltage (Vac (r.m.s.))	Capacitance Range (F)											
			0.1p	1p	10p	100p	1000p	10000p	0.1μ	1μ	10μ	100μ	1000μ	
GA342	4.5X2.0 <1808>	250			10pF	82pF								

High Dielectric Constant Type

Series	LXW (mm) <Size Code (inch)>	Rated Voltage (Vac (r.m.s.))	Capacitance Range (F)											
			0.1p	1p	10p	100p	1000p	10000p	0.1μ	1μ	10μ	100μ	1000μ	
GA342	4.5X2.0 <1808>	250				100pF	1500pF							
GA343	4.5X3.2 <1812>	250					1800pF	4700pF						

Continued on the following page. ↗

Ceramic Capacitor, Polymer Aluminum Electrolytic Capacitors

Safety Standard Certified Chip Multilayer Ceramic Capacitors for General Purpose Type GF / IEC60384-14 Class X1/Y2 and UL60950-1



GA3 Type GF

Temperature Compensating Type

General Safety standard

Series	LXW (mm) <Size Code (inch)>	Rated Voltage (V _{ac} (r.m.s.))	Capacitance Range (F)											
			0.1p	1p	10p	100p	1000p	10000p	0.1μ	1μ	10μ	100μ	1000μ	
GA342	4.5X2.0 <1808>	250			10pF	82pF								

High Dielectric Constant Type

Series	LXW (mm) <Size Code (inch)>	Rated Voltage (V _{ac} (r.m.s.))	Capacitance Range (F)											
			0.1p	1p	10p	100p	1000p	10000p	0.1μ	1μ	10μ	100μ	1000μ	
GA342	4.5X2.0 <1808>	250				100pF	1000pF							
GA352	5.7X2.8 <2211>	250				100pF	1500pF							
GA355	5.7X5.0 <2220>	250					1800pF	4700pF						

LW Reversed Low ESL Chip Multilayer Ceramic Capacitors for General Purpose



LLL

General Low ESL

Series	LXW (mm) <Size Code (inch)>	Rated Voltage (V _{dc})	Capacitance Range (F)											
			0.1p	1p	10p	100p	1000p	10000p	0.1μ	1μ	10μ	100μ	1000μ	
LLL15	0.5X1.0 <0204>	10								0.10μF				
		6.3							0.10μF	0.22μF				
		4							0.10μF	1.0μF				
		2.5							0.10μF	1.0μF				
LLL1U	0.6X1.0 <02404>	4									4.3μF			
		2.5									4.3μF			
LLL18	0.8X1.6 <0306>	50					2200pF	4700pF						
		25					10000pF	22000pF						
		16					10000pF	47000pF						
		10						0.10μF	0.22μF					
		6.3							0.22μF	2.2μF				
LLL21	1.25X2.0 <0508>	50					10000pF	22000pF						
		25					10000pF	0.10μF						
		16					22000pF	0.22μF						
		10						0.22μF	1.0μF					
		6.3							0.47μF	1.0μF				
LLL31	1.6X3.2 <0612>	50					10000pF	0.10μF						
		25					22000pF	0.47μF						
		16					22000pF	1.0μF						
		10						0.47μF	2.2μF					
		6.3							2.2μF	10μF				

Continued on the following page. ↗

Ceramic Capacitor, Polymer Aluminum Electrolytic Capacitors

8 Terminals Low ESL Chip Multilayer Ceramic Capacitors for General Purpose



LLA

General Low ESL

Series	LXW (mm) <Size Code (inch)>	Rated Voltage (Vdc)	Capacitance Range (F)														
			0.1p	1p	10p	100p	1000p	10000p	0.1μ	1μ	10μ	100μ	1000μ				
LLA18	1.6X0.8 <0603>	4								0.10μF							2.2μF
LLA21	2.0X1.25 <0805>	25							10000pF		47000pF						
		16								47000pF		0.22μF					
		10								47000pF		0.47μF					
		6.3									0.22μF		1.0μF				
		4								22000pF							4.7μF

10 Terminals Low ESL Chip Multilayer Ceramic Capacitors for General Purpose



LLM

General Low ESL

Series	LXW (mm) <Size Code (inch)>	Rated Voltage (Vdc)	Capacitance Range (F)														
			0.1p	1p	10p	100p	1000p	10000p	0.1μ	1μ	10μ	100μ	1000μ				
LLM21	2.0X1.25 <0805>	25							10000pF		22000pF						
		16								47000pF		0.10μF					
		6.3									0.22μF		0.47μF				
		4											1.0μF				

LW Reversed Controlled ESR Low ESL Chip Multilayer Ceramic Capacitors for General Purpose



LLR

General Low ESL

Series	LXW (mm) <Size Code (inch)>	Rated Voltage (Vdc)	ESR (mΩ)				Capacitance Range
			100	220	470	1000	
LLR18	0.8X1.6 <0306>	4					1.0μF

3 Terminals Low ESL Chip Multilayer Ceramic Capacitors for General Purpose



NFM

General Low ESL EMI Filter

Series	LXW (mm) <Size Code (inch)>	Rated Voltage (Vdc)	Capacitance Range (F)													
			0.1p	1p	10p	100p	1000p	10000p	0.1μ	1μ	10μ	100μ	1000μ			
NFM15	1.0X0.5 <0402>	16						2200pF		47000pF						
		10						2200pF		0.22μF						
		6.3								0.10μF		1.0μF				
		4									0.47μF		14μF			
		2.5										4.3μF		9.1μF		
NFM18	1.6X0.8 <0603>	16				100pF				0.10μF						
		10									2.2μF					
		6.3								0.22μF		10μF				
NFM21	2.0X1.25 <0805>	50				220pF				22000pF						
		25									0.10μF					
		16									0.22μF		1.0μF			
		10										1.0μF		4.7μF		
		6.3											2.2μF		10μF	



Continued on the following page. ↗

Ceramic Capacitor, Polymer Aluminum Electrolytic Capacitors

Series	LXW (mm) <Size Code (inch)>	Rated Voltage (Vdc)	Capacitance Range (F)												
			0.1p	1p	10p	100p	1000p	10000p	0.1μ	1μ	10μ	100μ	1000μ		
NFM3D	3.2X1.25 <1205>	50				220pF			22000pF						
NFM31	3.2X1.6 <1206>	100						10000pF		0.10μF					
		50						10000pF		0.10μF					
NFM41	4.5X1.6 <1806>	6.3											27μF		
		100				470pF			22000pF						
		50									1.5μF				
NFMJM	1.2X0.9 <05035>	25									1.5μF				
		4										15μF	22μF		
		2.5												22μF	

Low Distortion Chip Multilayer Ceramic Capacitors for General Purpose





Series	LXW (mm) <Size Code (inch)>	Rated Voltage (Vdc)	Capacitance Range (F)												
			0.1p	1p	10p	100p	1000p	10000p	0.1μ	1μ	10μ	100μ	1000μ		
GJ421	2.0X1.25 <0805>	25								0.10μF	0.33μF				
GJ431	3.2X1.6 <1206>	100								0.10μF					
		25								0.47μF	1.0μF				

Low Acoustic Noise Chip Multilayer Ceramic Capacitors on Interposer Board for General Purpose





Series	LXW (mm) <Size Code (inch)>	Rated Voltage (Vdc)	Capacitance Range (F)													
			0.1p	1p	10p	100p	1000p	10000p	0.1μ	1μ	10μ	100μ	1000μ			
ZRA21	2.4X1.65	25											22μF			
		16											22μF			
		6.3												47μF		
		4												47μF		

Low Acoustic Noise Chip Multilayer Ceramic Capacitors on Interposer Board for General Purpose



Series	LXW (mm) <Size Code (inch)>	Rated Voltage (Vdc)	Capacitance Range (F)													
			0.1p	1p	10p	100p	1000p	10000p	0.1μ	1μ	10μ	100μ	1000μ			
ZRB15	1.0X0.5 <0402>	25											2.2μF			
		16											2.2μF			
		10									2.2μF	10μF				
		6.3									4.7μF	10μF				
ZRB18	1.6X0.8 <0603>	35										4.7μF				
		25									4.7μF	10μF				
		16										10μF				
		10									10μF	22μF				
		6.3									10μF	47μF				
		4												22μF		

Continued on the following page. ↗

Ceramic Capacitor, Polymer Aluminum Electrolytic Capacitors

Metal Terminal Type Multilayer Ceramic Capacitors for General Purpose



KRM

Temperature Compensating Type

General Deflecting crack Soldering crack Low acoustic noise

Series	LXW (mm)	Rated Voltage (Vdc)	Capacitance Range (F)													
			0.1p	1p	10p	100p	1000p	10000p	0.1μ	1μ	10μ	100μ	1000μ			
KRM55	6.1X5.1	1250							8200pF	10000pF						
		1000							8200pF	20000pF						
		630							15000pF	94000pF						

High Dielectric Constant Type

Series	LXW (mm)	Rated Voltage (Vdc)	Capacitance Range (F)													
			0.1p	1p	10p	100p	1000p	10000p	0.1μ	1μ	10μ	100μ	1000μ			
KRM21	2.2X1.25	25										10μF	22μF			
		16											10μF			
KRM31	3.5X1.7	100										1.0μF				
		50										4.7μF				
		35											10μF			
		25											10μF			
KRM55	6.1X5.3	1000								68000pF	0.22μF					
		630								0.15μF	0.47μF					
KRM55	6.1X5.3	450									0.33μF	1.0μF				
		250										0.68μF	2.2μF			
		100											4.7μF	22μF		
		63											4.7μF	22μF		
		50											4.7μF	33μF		
		35											10μF	47μF		
		25											15μF	100μF		

High Effective Capacitance & High Allowable Ripple Current Metal Terminal Type Multilayer Ceramic Capacitors for General Purpose

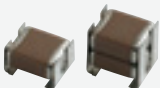

KR3

General Deflecting crack Soldering crack Low acoustic noise

Series	LXW (mm)	Rated Voltage (Vdc)	Capacitance Range (F)												
			0.1p	1p	10p	100p	1000p	10000p	0.1μ	1μ	10μ	100μ	1000μ		
KR355	6.1X5.3	630									0.10μF	0.56μF			
		450										0.22μF	1.2μF		
		250											0.47μF	2.2μF	

Wire Bonding Mount Multilayer Microchip Capacitors for General Purpose



GMA

General Bonding

Series	LXW (mm) <Size Code (inch)>	Rated Voltage (Vdc)	Capacitance Range (F)												
			0.1p	1p	10p	100p	1000p	10000p	0.1μ	1μ	10μ	100μ	1000μ		
GMA0D	0.38X0.38 <015015>	6.3													
		10							820pF	10000pF					

Continued on the following page.

Ceramic Capacitor, Polymer Aluminum Electrolytic Capacitors

Series	LXW (mm) <Size Code (inch)>	Rated Voltage (Vdc)	Capacitance Range (F)										
			0.1p	1p	10p	100p	1000p	10000p	0.1μ	1μ	10μ	100μ	1000μ
GMA05	0.5X0.5 <0202>	100				100pF	1000pF						
		50				100pF	1000pF						
		25					1500pF	4700pF					
		16				430pF	4700pF						
		10						6800pF	22000pF				
		6.3						6800pF	0.10μF				
GMA08	0.8X0.8 <0303>	100				330pF	6800pF						
		50				330pF	6800pF						
		25					10000pF	22000pF					
		16				1000pF	22000pF						
		10						33000pF	0.10μF				
		6.3						33000pF	0.47μF				

Wire Bonding/AuSn Soldering Mount Chip Multilayer Ceramic Capacitors for General Purpose







Series	LXW (mm) <Size Code (inch)>	Rated Voltage (Vdc)	Capacitance Range (F)										
			0.1p	1p	10p	100p	1000p	10000p	0.1μ	1μ	10μ	100μ	1000μ
GMD03	0.6X0.3 <0201>	25				100pF	1500pF						
		16					1800pF	3300pF					
		10					3900pF	10000pF					
		6.3						56000pF	0.10μF				
GMD15	1.0X0.5 <0402>	50				220pF	4700pF						
		25					5600pF	47000pF					
		16						56000pF	0.10μF				
		10							0.12μF	0.47μF			
	6.3								1.0μF				

Ceramic capacitors SMD type For Automotive

AEC-Q200 Compliant Chip Multilayer Ceramic Capacitors for Infotainment





Temperature Compensating Type

Series	LXW (mm) <Size Code (inch)>	Rated Voltage (Vdc)	Capacitance Range (F)										
			0.1p	1p	10p	100p	1000p	10000p	0.1μ	1μ	10μ	100μ	1000μ
GRT03	0.6X0.3 <0201>	100	0.10pF			100pF							
		50	0.10pF			220pF							
		25	0.10pF				1000pF						
GRT15	1.0X0.5 <0402>	100	0.20pF			100pF							
		50	0.11pF				1000pF						
		25			10pF		1000pF						
GRT18	1.6X0.8 <0603>	100				120pF	1500pF						
		50					1200pF	10000pF					
		25					1200pF	10000pF					
GRT21	2.0X1.25 <0805>	100					1800pF	3300pF					
		50						18000pF	22000pF				

Continued on the following page. ↗

Ceramic Capacitor, Polymer Aluminum Electrolytic Capacitors

Series	LXW (mm) <Size Code (inch)>	Rated Voltage (Vdc)	Capacitance Range (F)												
			0.1p	1p	10p	100p	1000p	10000p	0.1μ	1μ	10μ	100μ	1000μ		
GRT21	2.0X1.25 <0805>	25					1800pF	2200pF							
GRT31	3.2X1.6 <1206>	100						3900pF		0.10μF					
		50							56000pF	0.10μF					
		25								0.10μF	0.12μF				
		16									0.12μF				



High Dielectric Constant Type

Series	LXW (mm) <Size Code (inch)>	Rated Voltage (Vdc)	Capacitance Range (F)												
			0.1p	1p	10p	100p	1000p	10000p	0.1μ	1μ	10μ	100μ	1000μ		
GRT03	0.6X0.3 <0201>	35								0.10μF					
		25				100pF				0.10μF					
		16						10000pF		0.10μF					
		10					1500pF			1.0μF					
		6.3						2200pF		1.0μF					
		4							68000pF	1.0μF					
		2.5								1.0μF					
GRT15	1.0X0.5 <0402>	50				220pF			0.10μF						
		35							0.22μF	1.0μF					
		25						5600pF		2.2μF					
		16						10000pF		2.2μF					
		10							0.22μF	4.7μF					
		6.3							22000pF	4.7μF					
		4							0.22μF	4.7μF					
		2.5									10μF				
GRT18	1.6X0.8 <0603>	100					3300pF	10000pF							
		50							1.0μF	2.2μF					
		35							1.0μF	4.7μF					
		25							0.15μF	10μF					
		16							0.33μF	10μF					
		10								10μF	22μF				
		6.3								10μF	22μF				
		4								1.0μF	22μF				
		2.5									22μF				
GRT21	2.0X1.25 <0805>	100							47000pF						
		50							0.47μF	4.7μF					
		35								4.7μF					
		25								2.2μF	22μF				
		16								2.2μF	22μF				
		10								3.3μF	22μF				
		6.3								3.3μF	47μF				
		4									47μF				
		2.5									47μF				
GRT31	3.2X1.6 <1206>	50							1.0μF	10μF					
		35								10μF					
		25								1.5μF	10μF				
		16								1.5μF	22μF				
		10									47μF				
		6.3									15μF	47μF			
GRT32	3.2X2.5 <1210>	50							3.3μF	4.7μF					
		25								6.8μF					
		16									47μF				
		10									47μF				
		6.3									33μF	100μF			
4										100μF					

Continued on the following page. ↗

AEC-Q200 Compliant 3 Terminals Low ESL Chip Multilayer Ceramic Capacitors for Infotainment





Series	LXW (mm) <Size Code (inch)>	Rated Voltage (Vdc)	Capacitance Range (F)											
			0.1p	1p	10p	100p	1000p	10000p	0.1μ	1μ	10μ	100μ	1000μ	
NFM15	1.0X0.5 <0402>	4									10μF			
NFM18	1.6X0.8 <0603>	4									10μF			

Chip Multilayer Ceramic Capacitors for Automotive



Temperature Compensating Type

Series	LXW (mm) <Size Code (inch)>	Rated Voltage (Vdc)	Capacitance Range (F)											
			0.1p	1p	10p	100p	1000p	10000p	0.1μ	1μ	10μ	100μ	1000μ	
GCM03	0.6X0.3 <0201>	50	0.10pF				100pF							
		25	0.10pF				100pF							
GCM15	1.0X0.5 <0402>	50	0.10pF					1000pF						
GCM18	1.6X0.8 <0603>	100	0.47pF						10000pF					
		80					1600pF		3900pF					
		63					1600pF		3900pF					
		50					1000pF		10000pF					
GCM21	2.0X1.25 <0805>	630			10pF				2200pF					
		250			10pF					10000pF				
		100					1000pF		3300pF					
		80					4300pF		22000pF					
GCM31	3.2X1.6 <1206>	1000			10pF				1000pF					
		630			10pF					10000pF				
		250					6800pF		22000pF					
		100					1600pF		0.10μF					
GCM32	3.2X2.5 <1210>	1000						1200pF		2200pF				
		630						1200pF		33000pF				
		1000						2700pF		4700pF				
		630						12000pF		22000pF				
GCM43	4.5X3.2 <1812>	1000						5600pF		10000pF				
		630						27000pF		47000pF				
GCM55	5.7X5.0 <2220>	1000						5600pF		10000pF				
		630						27000pF		47000pF				

High Dielectric Constant Type

Series	LXW (mm) <Size Code (inch)>	Rated Voltage (Vdc)	Capacitance Range (F)											
			0.1p	1p	10p	100p	1000p	10000p	0.1μ	1μ	10μ	100μ	1000μ	
GCM03	0.6X0.3 <0201>	25				100pF				3300pF				
		16				330pF				3300pF				
		10					1200pF				10000pF			
GCM15	1.0X0.5 <0402>	100				220pF				4700pF				
		50				220pF				0.10μF				
		25					4700pF				0.10μF			
		16							15000pF		0.22μF			
		10							0.10μF		1.0μF			
GCM18	1.6X0.8 <0603>	100					1000pF				22000pF			
		50					1000pF				0.22μF			



Continued on the following page. ↗

Ceramic Capacitor, Polymer Aluminum Electrolytic Capacitors

Series	LXW (mm) <Size Code (inch)>	Rated Voltage (Vdc)	Capacitance Range (F)											
			0.1p	1p	10p	100p	1000p	10000p	0.1μ	1μ	10μ	100μ	1000μ	
GCM18	1.6X0.8 <0603>	25							68000pF		1.0μF			
		16							0.12μF		1.0μF			
		6.3									2.2μF		10μF	
		4											10μF	
GCM21	2.0X1.25 <0805>	100						10000pF		1.0μF				
		50						10000pF		1.0μF				
		35								0.68μF		4.7μF		
		25								0.15μF		4.7μF		
		16								0.27μF		10μF		
		10									2.2μF		10μF	
		6.3											10μF	
		GCM31	3.2X1.6 <1206>	100							0.22μF		2.2μF	
50									0.22μF		4.7μF			
35											10μF			
25									0.47μF		10μF			
16										4.7μF	10μF			
10												22μF		
6.3												22μF		
GCM32	3.2X2.5 <1210>	100										4.7μF		
		50									4.7μF	10μF		
		35											10μF	
		25									10μF	22μF		
		16											22μF	
		10									10μF	47μF		
		6.3											47μF	
		2.5												100μF

High Effective Capacitance & High Ripple Current Chip Multilayer Ceramic Capacitors for Automotive



Series	LXW (mm) <Size Code (inch)>	Rated Voltage (Vdc)	Capacitance Range (F)											
			0.1p	1p	10p	100p	1000p	10000p	0.1μ	1μ	10μ	100μ	1000μ	
GC321	2.0X1.25 <0805>	250						10000pF		22000pF				
GC331	3.2X1.6 <1206>	630						10000pF		15000pF				
		450						10000pF		47000pF				
GC332	3.2X2.5 <1210>	250						33000pF		68000pF				
		630						22000pF		47000pF				
		450							68000pF		0.10μF			
GC343	4.5X3.2 <1812>	250								0.10μF		0.15μF		
		630									68000pF			
		450										0.15μF		
GC355	5.7X5.0 <2220>	250								0.22μF		0.33μF		
		630								0.10μF		0.22μF		
		450									0.22μF		0.47μF	
		250								0.47μF		1.0μF		

Continued on the following page. ↗

Soft Termination Chip Multilayer Ceramic Capacitors for Automotive







Series	LXW (mm) <Size Code (inch)>	Rated Voltage (Vdc)	Capacitance Range (F)															
			0.1p	1p	10p	100p	1000p	10000p	0.1μ	1μ	10μ	100μ	1000μ					
GCJ18	1.6X0.8 <0603>	100					1000pF							0.10μF				
		50					1000pF							0.22μF				
		35							33000pF						68000pF			
		25					1000pF								1.0μF			
		16													27000pF			0.47μF
		10																0.22μF
		6.3																2.2μF
GCJ21	2.0X1.25 <0805>	250					1000pF							22000pF				
		100												27000pF			1.0μF	
		50												82000pF			1.0μF	
		35												0.12μF			0.47μF	
		25												0.12μF			2.2μF	
		16													0.27μF			4.7μF
		10															2.2μF	10μF
GCJ31	3.2X1.6 <1206>	1000					1000pF							10000pF				
		630					1000pF							22000pF				
		250												15000pF			0.10μF	
		100													0.15μF		2.2μF	
		50													0.47μF		4.7μF	
		35													0.47μF		10μF	
		25													2.2μF		10μF	
		16													1.5μF		10μF	
		10															6.8μF	22μF
6.3																22μF		
GCJ32	3.2X2.5 <1210>	1000												15000pF			22000pF	
		630												6800pF			47000pF	
		250													68000pF		0.22μF	
		100														2.2μF	4.7μF	
		50														4.7μF	10μF	
		25														4.7μF	22μF	
		16														6.8μF	22μF	
6.3																47μF		
GCJ43	4.5X3.2 <1812>	1000												33000pF			47000pF	
		630												33000pF		0.10μF		
		250													0.15μF		0.47μF	
GCJ55	5.7X5.0 <2220>	1000												68000pF		0.10μF		
		630													0.10μF		0.22μF	
		250														0.33μF	1.0μF	

Continued on the following page. ↗





Ceramic Capacitor, Polymer Aluminum Electrolytic Capacitors

High Q Chip Multilayer Ceramic Capacitors for Automotive

 **GCQ** Power-train  AEC-Q200  High Q 





Series	LXW (mm) <Size Code (inch)>	Rated Voltage (Vdc)	Capacitance Range (F)												
			0.1p	1p	10p	100p	1000p	10000p	0.1μ	1μ	10μ	100μ	1000μ		
GCQ15	1.0X0.5 <0402>	50	0.10pF							47pF					

MLSC Design Chip Multilayer Ceramic Capacitors for Automotive

 **GCD** Power-train  AEC-Q200  Deflecting crack 





Series	LXW (mm) <Size Code (inch)>	Rated Voltage (Vdc)	Capacitance Range (F)											
			0.1p	1p	10p	100p	1000p	10000p	0.1μ	1μ	10μ	100μ	1000μ	
GCD18	1.6X0.8 <0603>	100				1000pF	22000pF							
		50				1000pF	22000pF							
		25				27000pF		47000pF						
GCD21	2.0X1.25 <0805>	100				27000pF		0.10μF						
		50				27000pF		0.10μF						
		16									0.47μF			

Soft Termination MLSC Design Chip Multilayer Ceramic Capacitors for Automotive

 **GCE** Power-train  AEC-Q200  Deflecting crack 

Series	LXW (mm) <Size Code (inch)>	Rated Voltage (Vdc)	Capacitance Range (F)											
			0.1p	1p	10p	100p	1000p	10000p	0.1μ	1μ	10μ	100μ	1000μ	
GCE18	1.6X0.8 <0603>	100				1000pF	22000pF							
		50				1000pF	22000pF							
		25				27000pF		47000pF						
GCE21	2.0X1.25 <0805>	100				27000pF		0.10μF						
		50				27000pF		0.10μF						

3 Terminals Low ESL Chip Multilayer Ceramic Capacitors for Automotive

 **NFM** Power-train  AEC-Q200  Low ESL  EMI Filter 

Series	LXW (mm) <Size Code (inch)>	Rated Voltage (Vdc)	Capacitance Range (F)											
			0.1p	1p	10p	100p	1000p	10000p	0.1μ	1μ	10μ	100μ	1000μ	
NFM15	1.0X0.5 <0402>	4									1.0μF			
NFM18	1.6X0.8 <0603>	16									1.0μF			
		6.3									1.0μF			
		4									10μF			
NFM21	2.0X1.25 <0805>	50				220pF	22000pF							
		16									1.0μF			
		10									0.10μF	0.47μF		
NFM31	3.2X1.6 <1206>	100						10000pF						
		50						10000pF	0.10μF					

Continued on the following page. ↗

Metal Terminal Type Multilayer Ceramic Capacitors for Automotive



KCM

Temperature Compensating Type



Series	LXW (mm)	Rated Voltage (Vdc)	Capacitance Range (F)												
			0.1p	1p	10p	100p	1000p	10000p	0.1μ	1μ	10μ	100μ	1000μ		
KCM55	6.1X5.1	1000							8200pF	20000pF					
		630							15000pF	94000pF					

High Dielectric Constant Type

Series	LXW (mm)	Rated Voltage (Vdc)	Capacitance Range (F)												
			0.1p	1p	10p	100p	1000p	10000p	0.1μ	1μ	10μ	100μ	1000μ		
KCM55	6.1X5.3	100										4.7μF	22μF		
		63										4.7μF	22μF		
		50										4.7μF	33μF		
		35										10μF	47μF		
		25										15μF	100μF		

High Effective Capacitance & High Allowable Ripple Current Metal Terminal Type Multilayer Ceramic Capacitors for Automotive



KC3



Series	LXW (mm)	Rated Voltage (Vdc)	Capacitance Range (F)												
			0.1p	1p	10p	100p	1000p	10000p	0.1μ	1μ	10μ	100μ	1000μ		
KC355	6.1X5.3	630									0.10μF	1.2μF			
		450									0.22μF	2.2μF			
		250									0.47μF	2.2μF			

Safety Standard Certified Metal Terminal Type Multilayer Ceramic Capacitors for Automotive



KCA



Series	LXW (mm)	Rated Voltage (Vac (r.m.s.))	Capacitance Range (F)												
			0.1p	1p	10p	100p	1000p	10000p	0.1μ	1μ	10μ	100μ	1000μ		
KCA55	6.1X5.1	250				100pF			10000pF						





Continued on the following page. ↗

Ceramic Capacitor, Polymer Aluminum Electrolytic Capacitors

Ni Plating + Pd Plating termination Conductive Glue Mounting Chip Multilayer Ceramic Capacitors for Automotive

GCB















Series	LXW (mm) <Size Code (inch)>	Rated Voltage (Vdc)	Capacitance Range (F)											
			0.1p	1p	10p	100p	1000p	10000p	0.1μ	1μ	10μ	100μ	1000μ	
GCB15	1.0X0.5 <0402>	100					1000pF	10000pF						
		50					1000pF	47000pF						
		25						6800pF	0.10μF					
		16						15000pF	0.10μF					

AgPd Termination Conductive Glue Mounting Chip Multilayer Ceramic Capacitors for Automotive

GCG



Temperature Compensating Type

Series	LXW (mm) <Size Code (inch)>	Rated Voltage (Vdc)	Capacitance Range (F)											
			0.1p	1p	10p	100p	1000p	10000p	0.1μ	1μ	10μ	100μ	1000μ	
GCG15	1.0X0.5 <0402>	50		10pF				470pF						
GCG18	1.6X0.8 <0603>	100			10pF				10000pF					
		50			10pF				2200pF					
GCG21	2.0X1.25 <0805>	50					1000pF		10000pF					

High Dielectric Constant Type

Series	LXW (mm) <Size Code (inch)>	Rated Voltage (Vdc)	Capacitance Range (F)											
			0.1p	1p	10p	100p	1000p	10000p	0.1μ	1μ	10μ	100μ	1000μ	
GCG15	1.0X0.5 <0402>	50					220pF	4700pF						
		25						5600pF	10000pF					
		16							15000pF	0.10μF				
GCG18	1.6X0.8 <0603>	100					1000pF		0.10μF					
		50					1000pF		0.22μF					
		25							0.12μF	0.47μF				
		16							0.15μF	1.0μF				
		10									2.2μF			
GCG21	2.0X1.25 <0805>	50							0.15μF	1.0μF				
		35							0.68μF	1.0μF				
		25							0.27μF	1.0μF				
		16							0.33μF	4.7μF				
		10									10μF			
GCG31	3.2X1.6 <1206>	50							0.22μF	0.33μF				
		25							1.0μF	4.7μF				
		16							0.68μF	4.7μF				
		6.3									22μF			
GCG32	3.2X2.5 <1210>	50									10μF			
		35									10μF			
		25									10μF	22μF		
		16									6.8μF	10μF		
		6.3											47μF	

Continued on the following page. ↗

Ceramic capacitors SMD type For Medical Devices

Chip Multilayer Ceramic Capacitors for Implantable Medical devices
(Non Life support circuit)



GCH

Medical Device

Temperature Compensating Type

Series	LXW (mm) <Size Code (inch)>	Rated Voltage (Vdc)	Capacitance Range (F)											
			0.1p	1p	10p	100p	1000p	10000p	0.1μ	1μ	10μ	100μ	1000μ	
GCH15	1.0X0.5 <0402>	50		1.0pF				1000pF						
GCH18	1.6X0.8 <0603>	100		1.0pF				1500pF						
		50					1500pF	3300pF						
GCH21	2.0X1.25 <0805>	630		10pF				2200pF						
		100					2200pF	3300pF						
		50					4700pF	22000pF						
GCH31	3.2X1.6 <1206>	100					4700pF	10000pF						
		50					33000pF	0.10μF						

High Dielectric Constant Type

Series	LXW (mm) <Size Code (inch)>	Rated Voltage (Vdc)	Capacitance Range (F)											
			0.1p	1p	10p	100p	1000p	10000p	0.1μ	1μ	10μ	100μ	1000μ	
GCH03	0.6X0.3 <0201>	25					1000pF							
GCH15	1.0X0.5 <0402>	100				220pF	4700pF							
		50				220pF	0.10μF							
		25					10000pF	47000pF						
		16						47000pF	0.22μF					
		10							0.10μF	1.0μF				
GCH18	1.6X0.8 <0603>	100					10000pF	22000pF						
		50					3300pF	0.22μF						
		25						0.10μF	1.0μF					
		16							0.47μF	4.7μF				
		10								2.2μF				
GCH21	2.0X1.25 <0805>	100					47000pF	1.0μF						
		50						0.47μF	1.0μF					
		35							1.0μF	4.7μF				
		25							2.2μF	4.7μF				
		16							2.2μF	4.7μF				
		10								4.7μF	10μF			
GCH31	3.2X1.6 <1206>	100							0.22μF					
		50								2.2μF				
		16									10μF			
GCH32	3.2X2.5 <1210>	50									4.7μF			
		10										22μF		
		6.3											47μF	

Continued on the following page. ↗

Ceramic capacitors lead type For General Purpose

Leaded MLCC for General Purpose

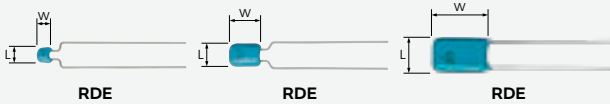

General Deflecting crack Soldering crack Low acoustic noise

Temperature Compensating Type

Series	LXW (mm)	Rated Voltage (Vdc)	Capacitance Range (F)													
			0.1p	1p	10p	100p	1000p	10000p	0.1μ	1μ	10μ	100μ	1000μ			
RDE5C	4.0X3.5	100		1.0pF						1500pF						
		50		1.0pF						3900pF						
	4.5X3.5	630			10pF					2200pF						
		250			10pF					10000pF						
		100							1800pF	3300pF						
	5.0X3.5	50							4700pF	22000pF						
		100		1.0pF						3300pF						
	5.5X4.0	1000			10pF					1000pF						
					10pF					4700pF						
		630			10pF					22000pF						
250				10pF					22000pF							
5.5X4.0	1000							3900pF	22000pF							
	100															
RDE7U	4.5X3.5	250							100pF	4700pF						
	5.5X4.0	1000			10pF					1000pF						
		630			10pF					4700pF						
		250								6800pF	22000pF					
	5.5X5.0	1000							1500pF	2200pF						
		630								6800pF	10000pF					
		250								33000pF	47000pF					
	7.5X5.5	1000							3300pF	4700pF						
		630								15000pF	22000pF					
7.5X8.0	1000							6800pF	10000pF							
	630								33000pF	47000pF						
7.7X13.0	1000															
	630															

High Dielectric Constant Type

Series	LXW (mm)	Rated Voltage (Vdc)	Capacitance Range (F)												
			0.1p	1p	10p	100p	1000p	10000p	0.1μ	1μ	10μ	100μ	1000μ		
RDEC7	4.0X3.5	25								0.22μF	1.0μF				
	4.5X3.5	50									1.0μF				
		25										2.2μF			
	5.0X3.5	50									1.0μF				
		25								0.22μF	2.2μF				
	5.5X4.0	50										4.7μF			
		25									4.7μF	10μF			
	5.5X5.0	100									1.5μF	2.2μF			
		50											10μF		
25												22μF			
5.5X7.5	100										4.7μF				
	50											22μF			
	25												47μF		
RDED7	5.5X4.0	630						10000pF	15000pF						
		450						10000pF	47000pF						

Continued on the following page. ↗

Ceramic Capacitor, Polymer Aluminum Electrolytic Capacitors

Series	LXW (mm)	Rated Voltage (Vdc)	Capacitance Range (F)											
			0.1p	1p	10p	100p	1000p	10000p	0.1μ	1μ	10μ	100μ	1000μ	
RDED7	5.5X4.0	250							33000pF	68000pF				
		630							22000pF	47000pF				
	5.5X5.0	450							68000pF	0.10μF				
		250							0.10μF	0.15μF				
		630							68000pF					
	7.5X5.5	450								0.15μF				
		250								0.22μF	0.33μF			
	7.5X7.5	450								0.22μF	0.56μF			
		250								0.47μF	1.0μF			
	7.5X8.0	630							0.10μF	0.27μF				
7.7X12.5	450									1.0μF	1.2μF			
	250										2.2μF			
7.7X13.0	630								0.47μF	0.56μF				
RDER7	4.0X3.5	100				220pF				22000pF				
		50				220pF				0.10μF				
		25								0.10μF				
	4.5X3.5	500					1000pF			10000pF				
		250					1000pF			22000pF				
		100								33000pF	0.47μF			
		50								0.15μF	0.47μF			
	5.0X3.5	100					220pF				0.47μF			
		50					220pF				0.47μF			
		25									0.10μF			
	5.5X4.0	1000					470pF			10000pF				
		630					1000pF			22000pF				
		500								15000pF	47000pF			
		250								33000pF	0.10μF			
		100									0.15μF	1.0μF		
		50									0.68μF	2.2μF		
	5.5X5.0	1000								15000pF	22000pF			
		630								33000pF	47000pF			
		500								68000pF	0.10μF			
		250									0.15μF	0.22μF		
		50										3.3μF		
	7.5X5.5	1000								33000pF	47000pF			
		630								68000pF	0.10μF			
		500									0.15μF	0.22μF		
		250									0.33μF	0.47μF		
	7.5X7.5	500								0.33μF	0.47μF			
		250									0.68μF	1.0μF		
	7.5X8.0	1000								68000pF	0.10μF			
		630									0.15μF	0.22μF		
	7.7X12.5	500									0.68μF	1.0μF		
250											2.2μF			
7.7X13.0	1000									0.22μF				
	630									0.47μF				

Continued on the following page. ↗

Ceramic Capacitor, Polymer Aluminum Electrolytic Capacitors

Safety Standard Certified Lead Type Disc Ceramic Capacitors for General Purpose Type RA [500Vac (r.m.s.) product] / IEC60384-14 Class X1/Y1



DE1 Type RA

Temperature Compensating Type

General Safety standard

Series	Rated Voltage	D (mm)	Capacitance Range (F)														
			0.1p	1p	10p	100p	1000p	10000p	0.1μ	1μ	10μ	100μ	1000μ				
DE11X	X1: 500Vac (r.m.s.), Y1: 500Vac (r.m.s.)	6.0 to 9.0			10pF	68pF											

High Dielectric Constant Type

Series	Rated Voltage	D (mm)	Capacitance Range (F)														
			0.1p	1p	10p	100p	1000p	10000p	0.1μ	1μ	10μ	100μ	1000μ				
DE1B3	X1: 500Vac (r.m.s.), Y1: 500Vac (r.m.s.)	6.0 to 9.0				100pF	680pF										
DE1E3	X1: 500Vac (r.m.s.), Y1: 500Vac (r.m.s.)	8.0 to 14.0					1000pF	4700pF									

Safety Standard Certified Lead Type Disc Ceramic Capacitors for General Purpose Type RA [250Vac, 300Vac rated] / IEC60384-14 Class X1/Y1



DE1 Type RA

Temperature Compensating Type

General Safety standard

Series	Rated Voltage	D (mm)	Capacitance Range (F)														
			0.1p	1p	10p	100p	1000p	10000p	0.1μ	1μ	10μ	100μ	1000μ				
DE11X	X1: 440Vac (r.m.s.), Y1: 300Vac (r.m.s.)	6.0 to 8.0			10pF	68pF											
	X1: 440Vac (r.m.s.), Y1: 250Vac (r.m.s.)	6.0 to 8.0			10pF	68pF											

High Dielectric Constant Type

Series	Rated Voltage	D (mm)	Capacitance Range (F)														
			0.1p	1p	10p	100p	1000p	10000p	0.1μ	1μ	10μ	100μ	1000μ				
DE1B3	X1: 440Vac (r.m.s.), Y1: 300Vac (r.m.s.)	6.0 to 8.0				100pF	680pF										
	X1: 440Vac (r.m.s.), Y1: 250Vac (r.m.s.)	6.0 to 8.0				100pF	680pF										
DE1E3	X1: 440Vac (r.m.s.), Y1: 300Vac (r.m.s.)	7.0 to 12.0					1000pF	4700pF									
	X1: 440Vac (r.m.s.), Y1: 250Vac (r.m.s.)	7.0 to 12.0					1000pF	4700pF									

Safety Standard Certified Lead Type Disc Ceramic Capacitors for General Purpose Type RB [X1:760Vac(r.m.s.)product] / IEC60384-14 Class X1/Y1



DE1 Type RB

Temperature Compensating Type

General Safety standard

Series	Rated Voltage	D (mm)	Capacitance Range (F)														
			0.1p	1p	10p	100p	1000p	10000p	0.1μ	1μ	10μ	100μ	1000μ				
DE11X	X1: 760Vac (r.m.s.), Y1: 500Vac (r.m.s.)	6.0 to 9.0			10pF	68pF											

Continued on the following page. ↗

Ceramic Capacitor, Polymer Aluminum Electrolytic Capacitors

High Dielectric Constant Type

Series	Rated Voltage	D (mm)	Capacitance Range (F)											
			0.1p	1p	10p	100p	1000p	10000p	0.1μ	1μ	10μ	100μ	1000μ	
DE1B3	X1: 760Vac (r.m.s.), Y1: 500Vac (r.m.s.)	6.0 to 9.0				100pF	680pF							
DE1E3	X1: 760Vac (r.m.s.), Y1: 500Vac (r.m.s.)	8.0 to 14.0				1000pF	4700pF							

Safety Standard Certified Lead Type Disc Ceramic Capacitors for General Purpose Type SA [400Vac (r.m.s.) product] / IEC60384-14 Class X1/Y2



DE2 Type SA

General Safety standard

Temperature Compensating Type

Series	Rated Voltage	D (mm)	Capacitance Range (F)											
			0.1p	1p	10p	100p	1000p	10000p	0.1μ	1μ	10μ	100μ	1000μ	
DE21X	X1: 440Vac (r.m.s.), Y2: 400Vac (r.m.s.)	6.0 to 9.0			10pF	68pF								

High Dielectric Constant Type

Series	Rated Voltage	D (mm)	Capacitance Range (F)											
			0.1p	1p	10p	100p	1000p	10000p	0.1μ	1μ	10μ	100μ	1000μ	
DE2B3	X1: 440Vac (r.m.s.), Y2: 400Vac (r.m.s.)	6.0 to 8.0				100pF	680pF							
DE2E3	X1: 440Vac (r.m.s.), Y2: 400Vac (r.m.s.)	7.0 to 17.0				1000pF	10000pF							

Safety Standard Certified Lead Type Disc Ceramic Capacitors for General Purpose Type SA [250Vac, 300Vac rated] / IEC60384-14 Class X1/Y2



DE2 Type SA

General Safety standard

Temperature Compensating Type

Series	Rated Voltage	D (mm)	Capacitance Range (F)											
			0.1p	1p	10p	100p	1000p	10000p	0.1μ	1μ	10μ	100μ	1000μ	
DE21X	X1: 300Vac (r.m.s.), Y2: 300Vac (r.m.s.)	6.0 to 8.0			10pF	68pF								
	X1: 300Vac (r.m.s.), Y2: 250Vac (r.m.s.)	6.0 to 8.0			10pF	68pF								

High Dielectric Constant Type

Series	Rated Voltage	D (mm)	Capacitance Range (F)											
			0.1p	1p	10p	100p	1000p	10000p	0.1μ	1μ	10μ	100μ	1000μ	
DE2B3	X1: 300Vac (r.m.s.), Y2: 300Vac (r.m.s.)	6.0 to 7.0				100pF	680pF							
	X1: 300Vac (r.m.s.), Y2: 250Vac (r.m.s.)	6.0 to 7.0				100pF	680pF							
DE2E3	X1: 300Vac (r.m.s.), Y2: 300Vac (r.m.s.)	6.0 to 15.0				1000pF	10000pF							
	X1: 300Vac (r.m.s.), Y2: 250Vac (r.m.s.)	6.0 to 15.0				1000pF	10000pF							

Continued on the following page. ↗

Ceramic capacitors lead type For Automotive

Leaded MLCC for Automotive



RCE

Temperature Compensating Type

Series	LXW (mm)	Rated Voltage (Vdc)	Capacitance Range (F)												
			0.1p	1p	10p	100p	1000p	10000p	0.1μ	1μ	10μ	100μ	1000μ		
RCE5C	3.6X3.5	100		1.0pF						1500pF					
		50		1.0pF						3900pF					
	4.0X3.5	630			10pF					2200pF					
		250			10pF					10000pF					
		100							1800pF	3300pF					
		50							4700pF	22000pF					
	5.5X4.0	1000			10pF					1000pF					
		630			10pF					4700pF					
		250			10pF					22000pF					
		100							3900pF	10000pF					
RCE7U	4.0X3.5	250			100pF				4700pF						
		1000			10pF				1000pF						
	5.5X4.0	630			10pF				4700pF						
		250							6800pF	10000pF					
	5.5X5.0	1000						1500pF	2200pF						
		630						6800pF	10000pF						
	7.5X5.5	1000						3300pF	4700pF						
		630						15000pF	22000pF						
	7.5X8.0	1000						6800pF	10000pF						
		630						33000pF	47000pF						
7.7X13.0	1000							20000pF							
	630								94000pF						

High Dielectric Constant Type

Series	LXW (mm)	Rated Voltage (Vdc)	Capacitance Range (F)											
			0.1p	1p	10p	100p	1000p	10000p	0.1μ	1μ	10μ	100μ	1000μ	
RCEC7	4.0X3.5	50									1.0μF			
	5.5X4.0	50										4.7μF		
	5.5X5.0	100									1.5μF	2.2μF		
		50										10μF		
	5.5X7.5	100										4.7μF		
RCER7	3.6X3.5	100				220pF			22000pF					
		50				220pF			0.10μF					
		25							0.10μF	0.22μF				
	4.0X3.5	250				1000pF			22000pF					
		100							33000pF	0.33μF				
		50								0.15μF	0.47μF			
		25								0.33μF	1.0μF			
	5.5X4.0	1000				1000pF			10000pF					
		630				1000pF			22000pF					
		250							33000pF	0.10μF				
		100								0.15μF	1.0μF			
		50									0.68μF	2.2μF		
		25									1.5μF	4.7μF		

Continued on the following page. ↗

Ceramic Capacitor, Polymer Aluminum Electrolytic Capacitors

Series	LXW (mm)	Rated Voltage (Vdc)	Capacitance Range (F)											
			0.1p	1p	10p	100p	1000p	10000p	0.1μ	1μ	10μ	100μ	1000μ	
RCER7	5.5X5.0	1000						15000pF	22000pF					
		630						33000pF	47000pF					
		250							0.15μF	0.22μF				
		50								3.3μF	4.7μF			
		25									10μF			
	5.5X7.5	50									10μF			
		25										22μF		
	7.5X5.5	1000						33000pF	47000pF					
		630						68000pF	0.10μF					
		250							0.33μF	0.47μF				
	7.5X7.5	250							0.68μF	1.0μF				
	7.5X8.0	1000						68000pF	0.10μF					
		630							0.15μF	0.22μF				
	7.7X12.5	250									2.2μF			
7.7X13.0	1000								0.22μF					
	630									0.47μF				

150°C Operation Leaded MLCC for Automotive



RHE

Temperature Compensating Type



Series	LXW (mm)	Rated Voltage (Vdc)	Capacitance Range (F)											
			0.1p	1p	10p	100p	1000p	10000p	0.1μ	1μ	10μ	100μ	1000μ	
RHE5G	3.6X3.5	100				100pF	1500pF							
		50				100pF	3900pF							
	4.0X3.5	100					1800pF	3300pF						
		50					4700pF	10000pF						

High Dielectric Constant Type

Series	LXW (mm)	Rated Voltage (Vdc)	Capacitance Range (F)											
			0.1p	1p	10p	100p	1000p	10000p	0.1μ	1μ	10μ	100μ	1000μ	
RHEL8	3.6X3.5	100				220pF	22000pF							
		50				220pF	0.10μF							
		25						0.10μF	0.22μF					
	4.0X3.5	100					33000pF	0.10μF						
		50						0.15μF	0.33μF					
		25						0.33μF	1.0μF					
	5.5X4.0	100						0.15μF	0.22μF					
		50						0.47μF	2.2μF					
		25							1.5μF	4.7μF				
	5.5X5.0	50							3.3μF	4.7μF				
		25									10μF			
	5.5X7.5	50									10μF			
25											22μF			

Continued on the following page. ↗

Ceramic Capacitor, Polymer Aluminum Electrolytic Capacitors

200°C Operation Leaded MLCC for Automotive

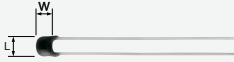

RHS

Temperature Compensating Type



Series	LXW (mm)	Rated Voltage (Vdc)	Capacitance Range (F)													
			0.1p	1p	10p	100p	1000p	10000p	0.1μ	1μ	10μ	100μ	1000μ			
RHS7G	3.9X3.5	100				100pF	1500pF									
	4.2X3.5	100					1800pF	3300pF								
RHS7J		200				100pF	4700pF									
	5.5X4.0	500				100pF	4700pF									
		200					6800pF	10000pF								

High Dielectric Constant Type

Series	LXW (mm)	Rated Voltage (Vdc)	Capacitance Range (F)													
			0.1p	1p	10p	100p	1000p	10000p	0.1μ	1μ	10μ	100μ	1000μ			
RHSQ9	3.9X3.5	100					4700pF	22000pF								
	4.2X3.5	100						33000pF	0.10μF							
	5.5X4.0	100							0.15μF	0.22μF						

Safety Standard Certified Lead Type Disc Ceramic Capacitors for Automotive



DE6



Series	Rated Voltage	D (mm)	Capacitance Range (F)													
			0.1p	1p	10p	100p	1000p	10000p	0.1μ	1μ	10μ	100μ	1000μ			
DE6E3	X1: 440Vac (r.m.s.), Y2: 300Vac (r.m.s.)	7.0 to 12.0					1000pF	4700pF								

Resin Molding SMD Type Ceramic Capacitors

Safety Standard Certified Resin Molding SMD Type Ceramic Capacitors for General Purpose



DK1

Temperature Compensating Type



Series	Rated Voltage	LXW (mm)	Capacitance Range (F)													
			0.1p	1p	10p	100p	1000p	10000p	0.1μ	1μ	10μ	100μ	1000μ			
DK11X	X1: 440Vac (r.m.s.), Y1: 300Vac (r.m.s.)	11.4X6.0				10pF	47pF									
	X1: 440Vac (r.m.s.), Y1: 250Vac (r.m.s.)	11.4X6.0				10pF	47pF									

High Dielectric Constant Type

Series	Rated Voltage	LXW (mm)	Capacitance Range (F)													
			0.1p	1p	10p	100p	1000p	10000p	0.1μ	1μ	10μ	100μ	1000μ			
DK1B3	X1: 440Vac (r.m.s.), Y1: 300Vac (r.m.s.)	11.4X6.0				100pF	680pF									
	X1: 440Vac (r.m.s.), Y1: 250Vac (r.m.s.)	11.4X6.0				100pF	680pF									
DK1E3	X1: 440Vac (r.m.s.), Y1: 300Vac (r.m.s.)	11.4X6.0					1000pF	1500pF								
	X1: 440Vac (r.m.s.), Y1: 250Vac (r.m.s.)	11.4X6.0					1000pF	1500pF								

Continued on the following page. ↗

Polymer Aluminum Electrolytic Capacitors



ECAS

General

Deflecting crack

Low acoustic noise

Effective Cap

Series	LXW (mm)	Rated Voltage (Vdc)	Capacitance Range (F)													
			0.1p	1p	10p	100p	1000p	10000p	0.1μ	1μ	10μ	100μ	1000μ			
ECAS	7.3X4.3	25									10μF	33μF				
		20										33μF	47μF			
		16									6.8μF	68μF				
		10									10μF	150μF				
		6.3									10μF	330μF				
		4										68μF	330μF			
		2.5											330μF	470μF		
		2											100μF	470μF		

Detailed Catalogs

For more details, please refer to our printed catalogs and the PDF catalogs on our website.

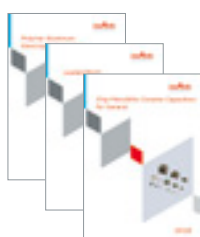

- Chip Multilayer Ceramic Capacitors for General Cat. No. C02E
- Chip Multilayer Ceramic Capacitors for Automotive Cat. No. C03E
- Lead Type Disc Ceramic Capacitors (Safety Standard Certified, DC2k to DC6.3kV)
- Resin Molding SMD Type Ceramic Capacitors (Safety Standard Certified) Cat. No. C85E
- Polymer Aluminum Electrolytic Capacitors Cat. No. C90E
- Leaded MLCC Cat. No. C49E

Single-Layer Microchip Capacitors, Thin Film Circuit Substrates (RUSUB)

Single-Layer Microchip Capacitors, Thin Film Circuit Substrates (RUSUB)

Single-Layer Microchip Capacitors

Very reliable performance and excellent frequency characteristics

Temperature Compensating Type



Capacitance Change (Temperature Range)	Series	Size (mm)	Rated Voltage (Vdc)	Capacitance Range at 25°C (pF)					Operating Temperature Range (°C)
				0.1	1	10	100	1000	
0±30ppm/°C (-25 to 85°C)	CLB0A	0.25X0.25	100	0.1					-55 to 125
	CLB0C	0.35X0.25	100	0.2					-55 to 125
	CLB0D	0.38X0.38	100	0.2	0.4				-55 to 125
	CLB05	0.50X0.50	100	0.3	0.6				-55 to 125
	CLB0E	0.55X0.38	100	0.5	0.6				-55 to 125
	CLB0F	0.64X0.64	100	0.6	1.0				-55 to 125
	CLB0G	0.70X0.50	100	0.7	1.0				-55 to 125
	CLB0H	0.71X0.38	100	0.7	0.8				-55 to 125
	CLB0J	0.76X0.76	100	0.9	1.3				-55 to 125
	CLB09	0.90X0.90	100	1.0	1.8				-55 to 125
	CLB1A	1.00X0.64	100	1.1	1.6				-55 to 125
	CLB1B	1.09X0.76	100	1.5	2.0				-55 to 125
	CLB1C	1.27X1.27	100	2.2	3.6				-55 to 125
	CLB1E	1.49X0.90	100	2.0	2.7				-55 to 125
	CLB1G	1.73X1.27	100	3.9	4.7				-55 to 125
	CLB1H	1.78X1.78	100	3.9	6.8				-55 to 125
	CLB2C	2.19X1.27	100	5.1					-55 to 125
	CLB2E	2.29X2.29	100	6.2	10				-55 to 125
CLB2L	2.95X1.78	100	7.5	10				-55 to 125	
CLB3G	3.71X2.29	100	11	16				-55 to 125	
-750±60ppm/°C (-25 to 85°C)	CLB0A	0.25X0.25	100	0.3	0.7				-55 to 125
	CLB0B	0.30X0.25	100	0.8					-55 to 125
	CLB0C	0.35X0.25	100	0.9					-55 to 125
	CLB0D	0.38X0.38	100	0.9	1.6				-55 to 125
	CLB05	0.50X0.50	100	1.0	2.4				-55 to 125
	CLB0E	0.55X0.38	100	1.8	2.4				-55 to 125
	CLB0F	0.64X0.64	100	2.0	4.3				-55 to 125
	CLB0G	0.70X0.50	100	2.7	3.0				-55 to 125
	CLB0H	0.71X0.38	100	2.7					-55 to 125
	CLB0J	0.76X0.76	100	3.0	6.2				-55 to 125
	CLB09	0.90X0.90	100	3.3	6.8				-55 to 125
	CLB1A	1.00X0.64	100	4.7	6.2				-55 to 125
	CLB1B	1.09X0.76	100	6.8	7.5				-55 to 125
	CLB1C	1.27X1.27	100	7.5	15				-55 to 125
	CLB1E	1.49X0.90	100	7.5	9.1				-55 to 125
	CLB1H	1.78X1.78	100	13	15				-55 to 125
	CLB2E	2.29X2.29	100	20					-55 to 125

All Single Layer Microchip Capacitors are produced after receiving an order.

Single-Layer Microchip Capacitors, Thin Film Circuit Substrates (RUSUB)

High Dielectric Constant Type

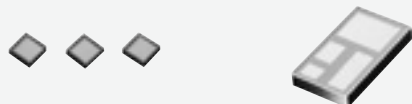

Capacitance Change (Temperature Range)	Series	Size (mm)	Rated Voltage (Vdc)	Capacitance Range at 25°C (pF)					Operating Temperature Range (°C)	
				0.1	1	10	100	1000		
±10% (-25 to 85°C)	CLBOA	0.25X0.25	100			5.6	12			-55 to 125
	CLBOB	0.30X0.25	100			13	15			-55 to 125
	CLBOC	0.35X0.25	100			16	18			-55 to 125
	CLBOD	0.38X0.38	100			18	30			-55 to 125
	CLB05	0.50X0.50	100			22	43			-55 to 125
	CLBOE	0.55X0.38	100			33	43			-55 to 125
	CLBOF	0.64X0.64	100			43	75			-55 to 125
	CLBOG	0.70X0.50	100			47	68			-55 to 125
	CLBOH	0.71X0.38	100			47	56			-55 to 125
	CLBOJ	0.76X0.76	100			68	110			-55 to 125
	CLB09	0.90X0.90	100			68	130			-55 to 125
	CLB1A	1.00X0.64	100			82	120			-55 to 125
	CLB1C	1.27X1.27	100				160	200		-55 to 125
	CLB1E	1.49X0.90	100				150	160		-55 to 125
	CLB1G	1.73X1.27	100					300		-55 to 125
	CLB1H	1.78X1.78	100					300	430	-55 to 125
CLB2E	2.29X2.29	100					470	620	-55 to 125	
+30, -80% (-25 to 85°C)	CLBOA	0.25X0.25	100			27	33			-55 to 125
	CLBOB	0.30X0.25	100			36	39			-55 to 125
	CLBOC	0.35X0.25	100			43	51			-55 to 125
	CLBOD	0.38X0.38	100			62	82			-55 to 125
	CLB05	0.50X0.50	100			75	130			-55 to 125
	CLBOE	0.55X0.38	100			91	120			-55 to 125
	CLBOF	0.64X0.64	100			130	220			-55 to 125
	CLBOG	0.70X0.50	100			150	200			-55 to 125
	CLBOH	0.71X0.38	100			130	150			-55 to 125
	CLBOJ	0.76X0.76	100			200	300			-55 to 125
	CLB09	0.90X0.90	100			200	390			-55 to 125
CLB1A	1.00X0.64	100			240	360			-55 to 125	
+30, -90% (-25 to 85°C)	CLBOA	0.25X0.25	100			36	56			-55 to 125
	CLBOD	0.38X0.38	100			91	150			-55 to 125
	CLB05	0.50X0.50	100			130	220			-55 to 125
	CLBOF	0.64X0.64	100			220	390			-55 to 125
	CLBOJ	0.76X0.76	100			330	560			-55 to 125
CLB09	0.90X0.90	100			390	680			-55 to 125	

All Single Layer Microchip Capacitors are produced after receiving an order.

Thin Film Circuit Substrates (RUSUB)

Customizable capacitors for impedance matching for RF power amplifiers and decoupling for optical communication devices.

■ Features

- Single-layer structure enhances self-resonant frequency, which allows stable operation even at a high frequency range.
- RUSUB technology achieves miniaturization of the device by combining a single-layer capacitor and a thin film resistor. In addition, it contributes to attenuation of unnecessary noise.
- By utilizing Au electrodes, die bonding with AuSn and wire bonding with gold wire are possible.
- A wide selection of substrate materials meets customers' requirements. (Please refer to the following table.)

Function	Dielectric Constant (ϵ_r) *1	Size min. (mm) (LxWxT) *2	Temperature Characteristics of Capacitance (ppm/°C) *3	Through Hole	TaN Resistance	L/S min. (μm) *4	Coefficient of Thermal Expansion (ppm/°C) *1	Temperature Conductivity (ppm/(m.°C)) *1
Impedance Matching	9	0.25X0.25X0.10	-	○	○	30/30 (Au thickness 4 μm)	4.6	200.0
	10	0.25X0.25X0.20	-	○	○		7.0	33.5
	39	0.25X0.25X0.10	0 \pm 30	×	○		6.6	1.9
	90	0.25X0.25X0.10	-330 \pm 120	×	○		9.2	2.3
	150	0.25X0.25X0.10	-750 \pm 120	×	○		11.7	2.0
	250	0.25X0.25X0.10	-750 \pm 600	×	○		12.2	4.0
Decoupling	3000	0.25X0.25X0.10	\pm 10%	×	○	50/50 (Au thickness 8 μm)	10.7	2.5
	10000	0.25X0.25X0.10	+30, -80%	×	×		10.5	1.6
	15000	0.25X0.25X0.10	+30, -90%	×	×		14.0	2.4
	30000	0.25X0.25X0.25	\pm 25%	×	○		11.2	7.35

*1 : Typical value

*2 : L = length, W = width, T = thickness

*3 : Temperature Range: -25 to 85°C, Reference Temperature: 25°C

*4 : L = line, S = space

Single-Layer Microchip Capacitors, Thin Film Circuit Substrates (RUSUB)

Thirteen types of standard products suitable for decoupling are also available.

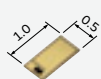

RUCYT101 Series

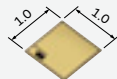

RUCYT201 Series

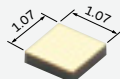

RUCQD Series

(in mm)

Part Number	Size (mm) (LxWxT)	Capacitor			Resistor	
		Capacitance (pF)	Temperature Characteristics of Capacitance (-25 to 85°C)	Rated Voltage (V)	Resistance (Ω)	Temperature Coefficient of Resistance (ppm/°C)
RUCYT101K00009GNTC	1.0X0.5X0.11	100	±10%	100	50±20%	-70±50
RUCYT101K00011GNTC	1.0X0.5X0.11	100			100±20%	
RUCYT101K00012GNTC	1.0X0.5X0.11	100			200±20%	
RUCYT201K00010GNTC	1.0X1.0X0.12	200			50±20%	
RUCYT201K00013GNTC	1.0X1.0X0.12	200			100±20%	
RUCYT201K00014GNTC	1.0X1.0X0.12	200			200±20%	
RUCQD101RCC007GNTC	0.34X0.34X0.25	100	±25%	65	-	-
RUCQD431RCC001GNZB	0.70X0.70X0.25	430				
RUCQD471RCC002GNZB	0.73X0.73X0.25	470				
RUCQD511RCC003GNZB	0.76X0.76X0.25	510				
RUCQD561RCC004GNZB	0.80X0.80X0.25	560				
RUCQD102RCC008GNZB	1.07X1.07X0.25	1000				
RUCQD201ZCC005GNZB	1.10X0.60X0.25	200×4				

*Several samples for impedance matching are also available for your evaluation. Please find the details at the following link: <https://www.murata.com/en-global/products/capacitor/rusub/matching>

Detailed Catalogs

For more details, please refer to our printed catalogs and the PDF catalogs on our website.

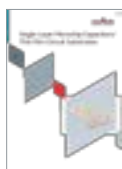

• Single-Layer Microchip Capacitors/Thin Film Circuit Substrates

Cat. No. C01E

Variable Capacitors

Variable capacitors can carry out the variable of the capacitor by adjusting the tuning voltage. They are designed for frequency matching use for HF band (13.56MHz).

LXRW_V Series

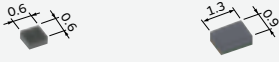

Series	LxW (mm)	Rated Voltage (Vdc)	Capacitance Range (F)												
			0.1p	1p	10p	100p	1000p	10000p	0.1μ	1μ	10μ	100μ	1000μ		
LXRW0Y	0.6X0.6	CSP			33pF	200pF									
LXRW19	1.3X0.9	DFN			33pF	200pF									

Silicon Capacitors

Murata High-Density Silicon Capacitors are based on a MOS Semiconductor technology and utilize a 3D structure that substantially increases their performance and enables compact design. Silicon Capacitors offer small size and low thickness, superior reliability, and stability over high temperatures and high frequencies. They are the ideal choice for all demanding markets, such as Networking (RF Power and Broadband), Medical (Implantable devices), Automotive, or High-Reliability applications. Murata can provide customized Silicon Capacitors or Integrated Passive Devices (IPDs) to optimize your design.

Product Lineup

	Thickness	Standard (150°C)	High temp.	Operating Frequency
Solder Mounting	100μm	LPSC R All		XBSC (100GHz+) UBSC (60GHz+) BBSC (40GHz) ULSC (20GHz) UBDC (60GHz+)
	400μm	HSSC All	HTSC (200°C) XTSC (250°C) H	B p38, 39
Wire-bonding vertical	100μm	WLSC P A B		UWSC (26GHz+) (down to 10pH)
	250μm	WBSC P A B	WTSC (200°C) WXSC (250°C) A P H	B P p40
Wire-bonding /Embedded horizontal	100μm	EMSC All MGSC M		UBEC (60GHz+) BBEC (40GHz) ULEC (20GHz) B p39
	250μm		ETSC (200°C) EXSC (250°C) H ATSC (200°C) A	p38, 41

Target application

- A Automotive
- H High Reliability
- B BroadBand
- M Medical
- All All applications
- P Power Amp for RF
- R RFID

High stability and reliability Si capacitors (HSSC)

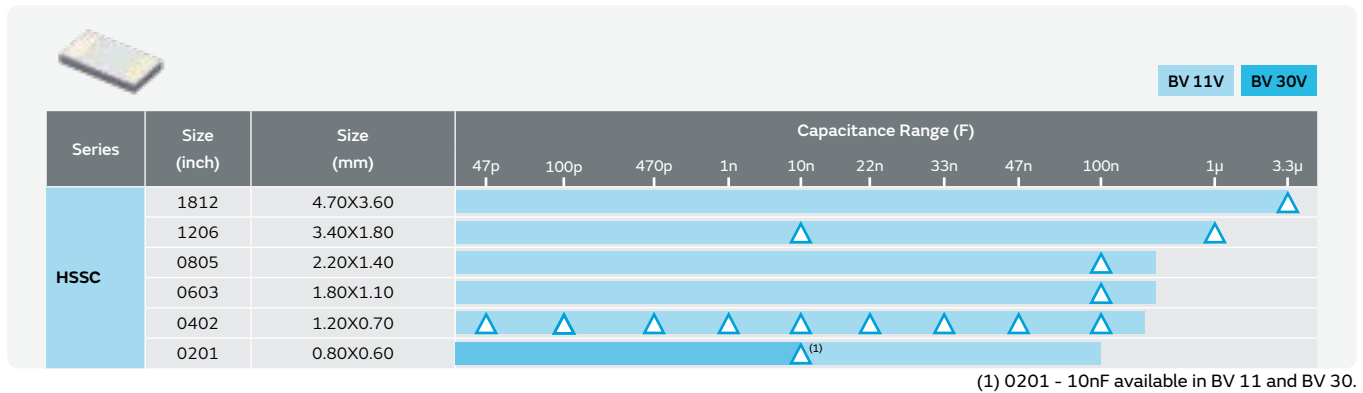

Low-profile Si capacitors down to 100μm (LPSC)

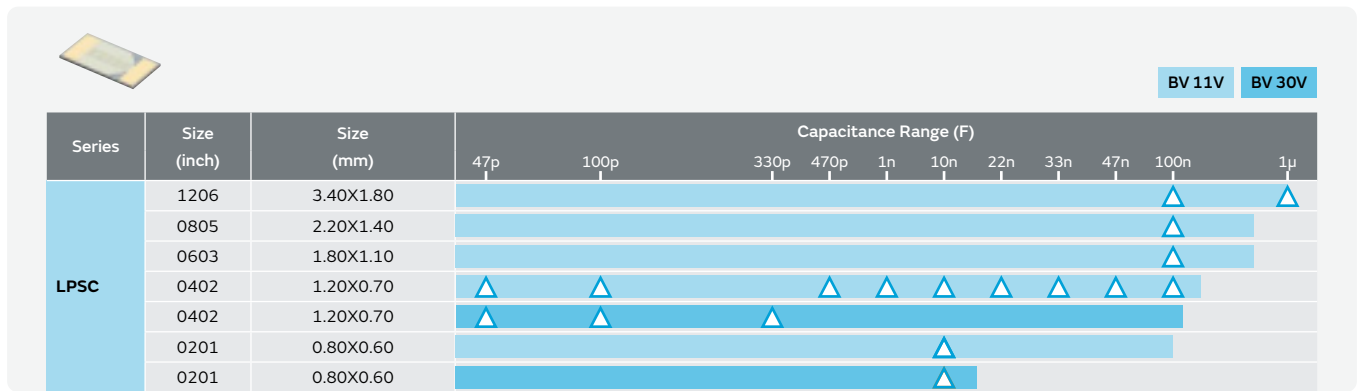

Xtreme temperature Si capacitors up to 250°C (HTSC/XTSC)

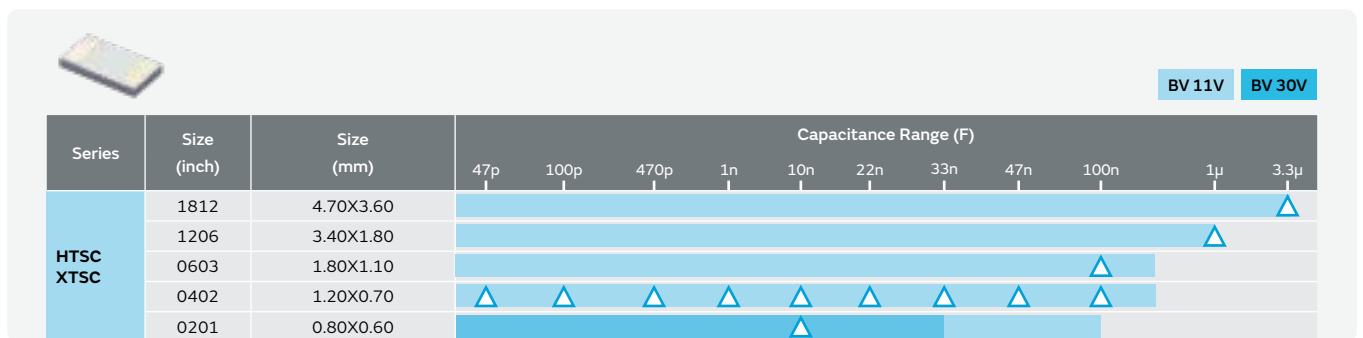

Wire-bondable or embedded low-profile Si capacitors down to 100μm (EMSC)

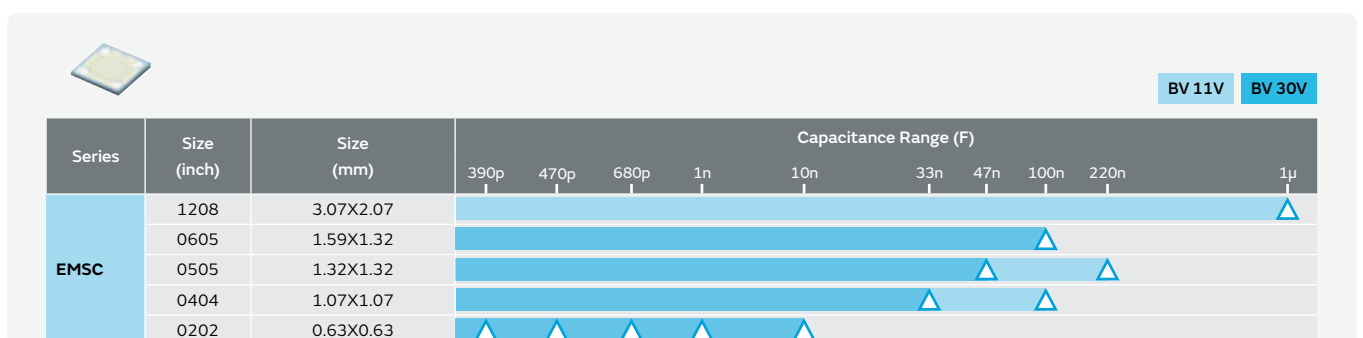

△ Available parts. For other values, contact your Murata sales representative. ▽ Under development.

Silicon Capacitors

Extreme temperature wire-bondable Si capacitors up to 250°C (ETSC/EXSC)

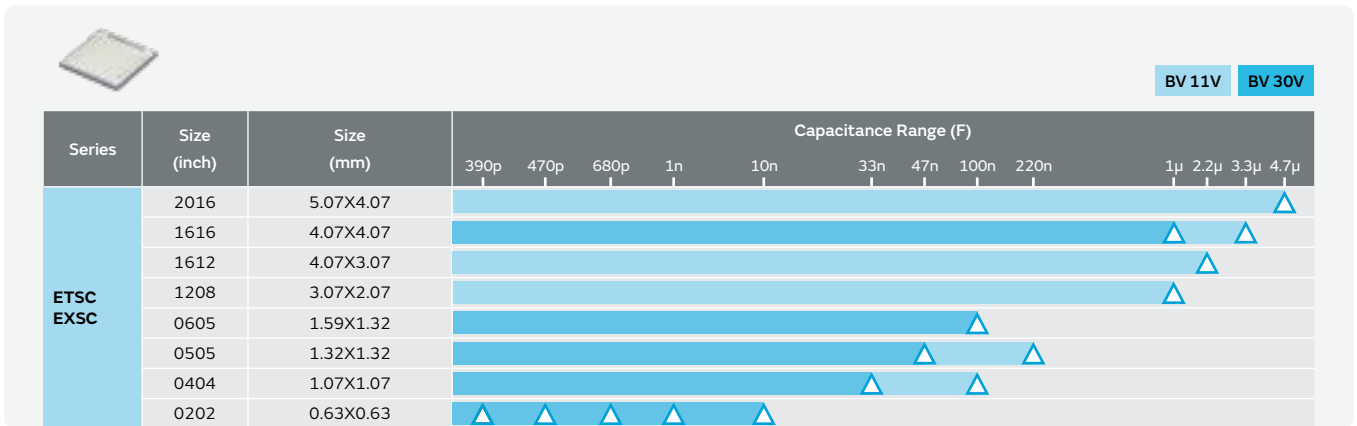

Ultra broadband surface mounted Si capacitor up to 100GHz+ (XBSC)

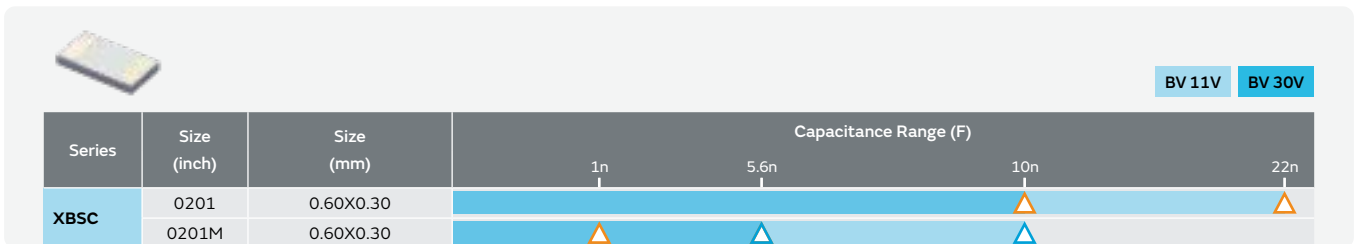

Ultra broadband surface mounted Si capacitors up to 60GHz+ (UBSC)

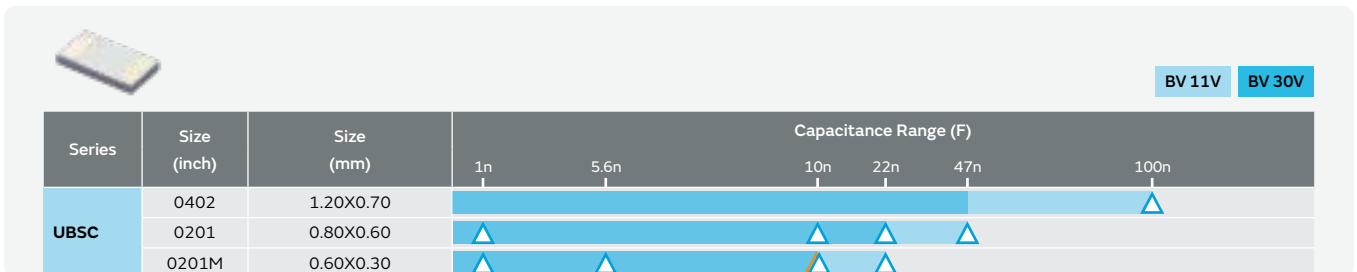

Ultra broadband surface mounted Si capacitors up to 40GHz (BBSC)

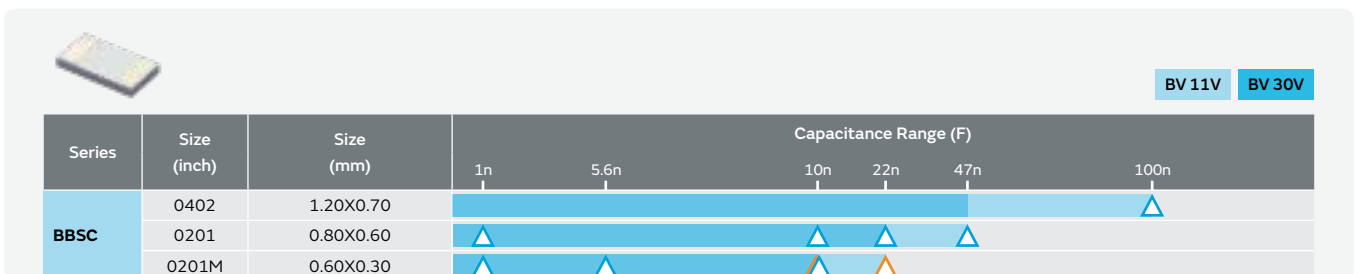

△ Available parts. For other values, contact your Murata sales representative. ▴ Under development.

Ultra broadband surface mounted Si capacitors up to 20GHz (ULSC)

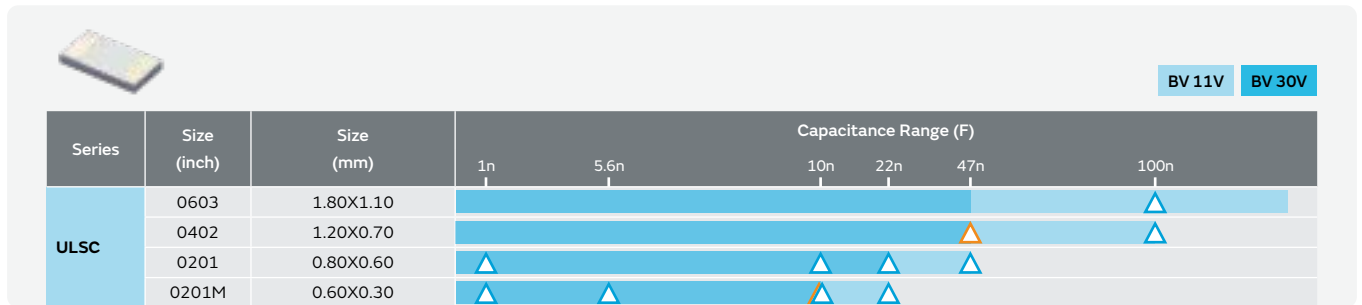

Ultra Broadband surface mounted differential Si capacitors pairs up to 60GHz+ (UBDC)

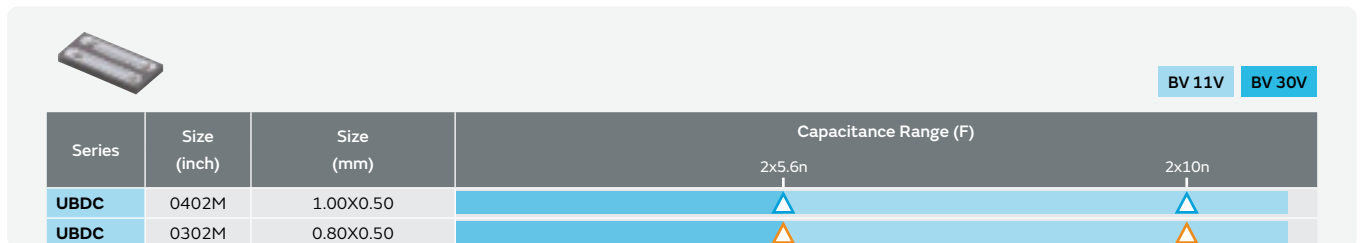

Ultra broadband wire-bondable embedded Si capacitors up to 60GHz+ (UBEC)

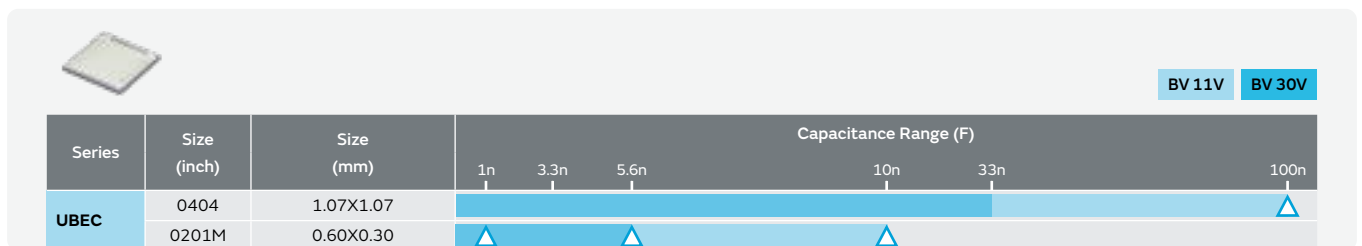

Ultra broadband wire-bondable embedded Si capacitors up to 40/20GHz (BBEC/ULEC)

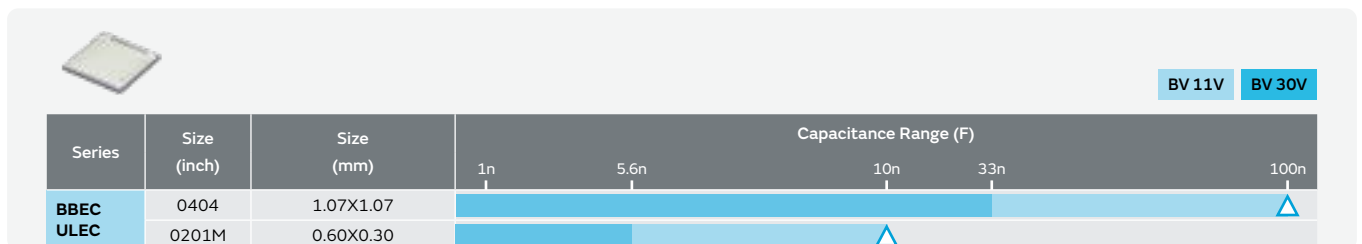

△ Available parts. For other values, contact your Murata sales representative. ▽ Under development.

Silicon Capacitors

Ultra large-band wire-bondable vertical Si capacitors up to 26GHz+ (UWSC)

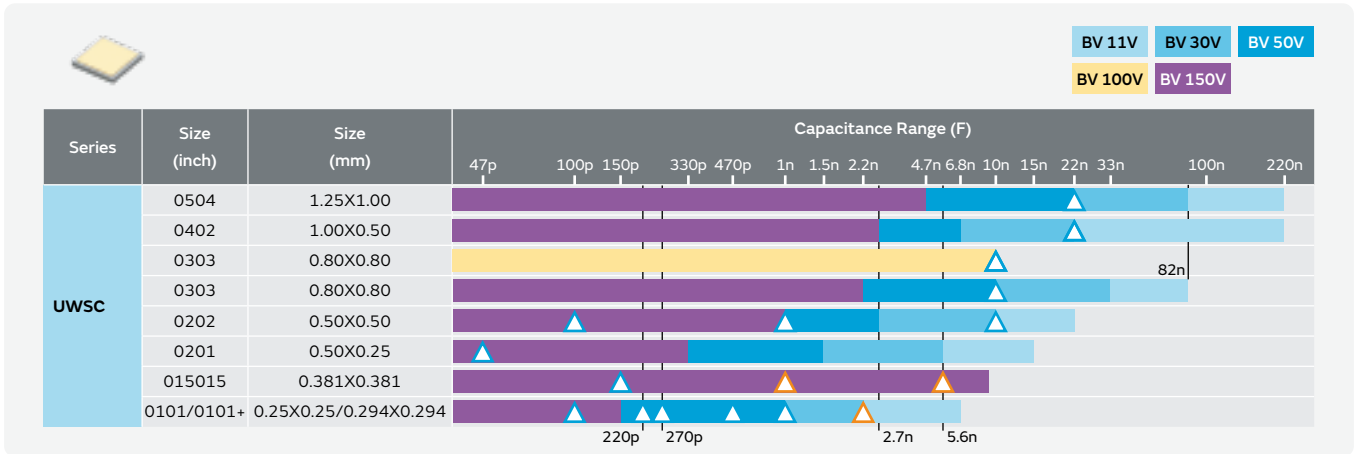

Wire-bondable vertical Si capacitors up to 250°C (WBSC/WTSC/WXSC)

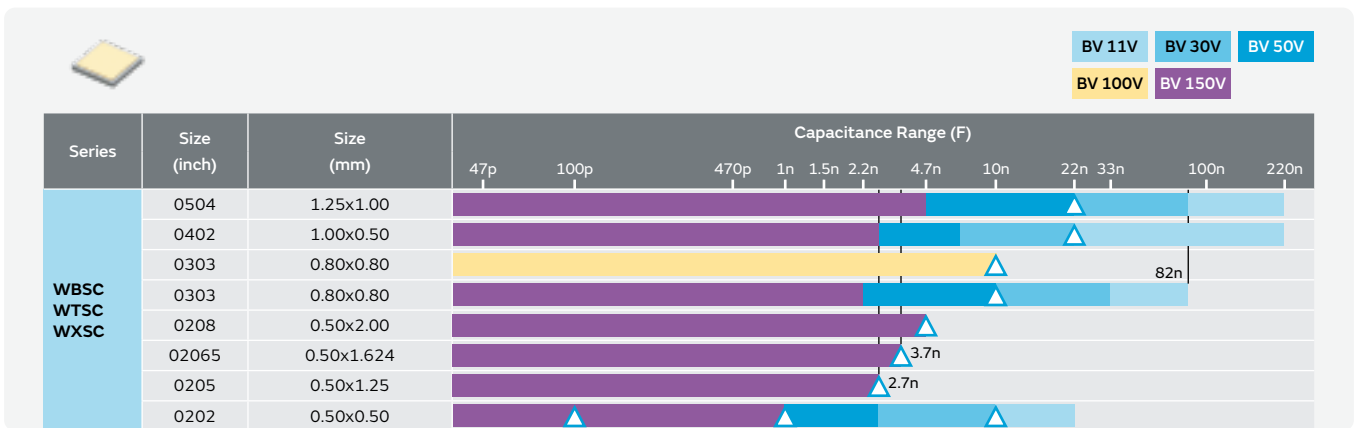

Wire-bondable vertical low-profile Si capacitors down to 100µm (WLSC)

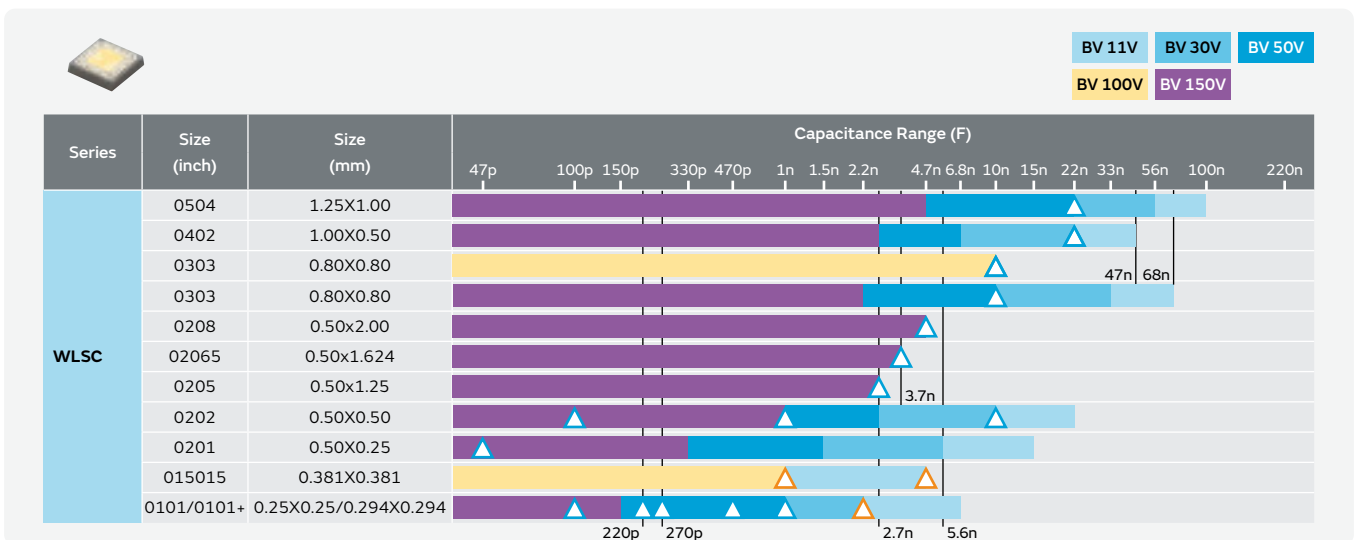

△ Available parts. For other values, contact your Murata sales representative. ▽ Under development.

Automotive high temperature Si capacitors up to 200°C (ATSC)

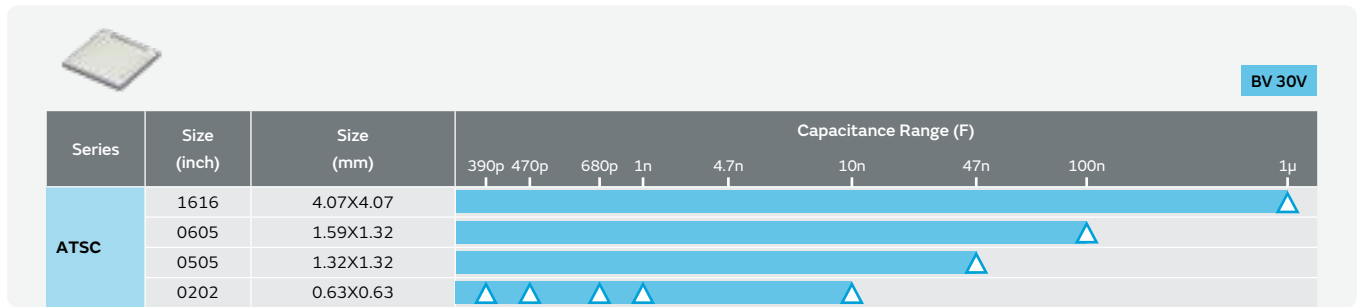

Medical grade Si capacitors (MGSC)

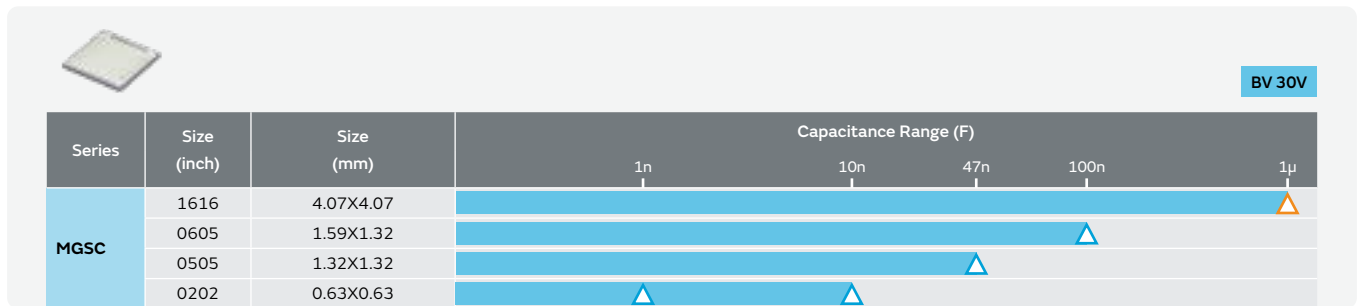

△ Available parts. For other values, contact your Murata sales representative. ▽ Under development.

Film Capacitors

The FH series uses materials with high heat resistance. Therefore, it has a higher allowable ripple current under a higher temperature environment than conventional PP film capacitors.

This feature is more prominent in the high-frequency range. For example, when the ambient temperature is at 105°C, the PP film capacitors would be already at its limit for allowable ripple current, but because of the higher heat resistance of the FH series, the allowable ripple current can be increased drastically.



Specifications

Items	Basic Specifications
Rated Capacitance	10,15,20 μ F
Rated Voltage	500V
Operational Life	125°C/500V 2000h
Biased Humidity	85°C/85%RH/500V 1000h
Temperature Cycling	-40~+125°C/1000cycles

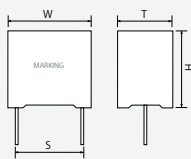

Dimensions

Part Number	Capacitance	Dimensions (mm)			
		W	H	T	S
FHA50Y206KS	20 μ F	33.0	37.0	18.0	30.0
FHA50Y156KS	15 μ F	33.0	35.5	14.5	30.0
FHA50Y106KS	10 μ F				

Noise Suppression Products/ EMI Suppression Filters

Broad lineup of Noise Suppression Products and EMI Suppression Filters

Summary

Using Murata's ceramic processing technology and unique materials, we offer a variety of Noise Suppression Products and EMI Suppression Filters.

Lineup

- EMI (chip and lead type)
- Noise Suppression Products for Automotive
- ESD Protection Devices

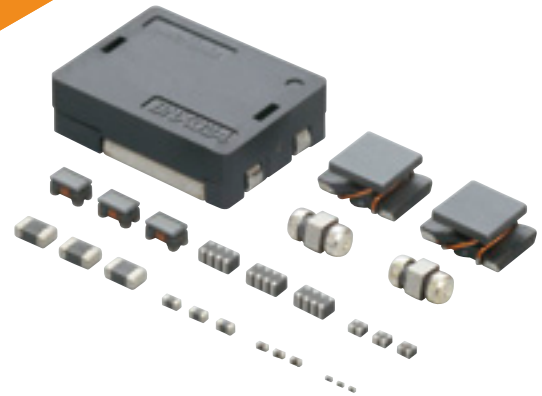

<https://www.murata.com/en-global/products/emc>

Chip Ferrite Bead

		Series	Size Code inch (mm)	Max. Rated Current (mA)	Impedance at 100MHz (Rated Current)		
For General Band Noise	Universal Type [Power Lines/Signal Lines]	BLM02AX	01005 (0402)	750	10Ω to 330Ω (0.15A to 0.75A)		
		BLM03AX	0201 (0603)	1000	10Ω to 1000Ω (0.2A to 1A)		
		BLM15AX	0402 (1005)	1740	10Ω to 1000Ω (0.35A to 1.74A)		
	Signal Lines Type	For General Signal Lines	BLM03AG	0201 (0603)	-	10Ω to 1000Ω	
			BLM15AG	0402 (1005)	-	10Ω to 1000Ω	
			BLM18AG	0603 (1608)	-	120Ω to 1000Ω	
			BLM18TG	0603 (1608)	-	120Ω to 1000Ω	
			BLM21AG	0805 (2012)	-	120Ω to 1000Ω	
			BLA2AA (4 circuits array)	0804 (2010)	-	120Ω to 1000Ω	
			BLA31AG (4 circuits array)	1206 (3216)	-	30Ω to 1000Ω	
			For High Speed Signal Lines	BLM02BX*	01005 (0402)	-	120Ω to 240Ω
				BLM02BB/BC	01005 (0402)	-	10Ω to 100Ω
				BLM03BX	0201 (0603)	-	1000Ω to 1800Ω
		BLM03BB/BC/BD		0201 (0603)	-	10Ω to 600Ω	
		BLM15BA/BB/BC/BD		0402 (1005)	-	5Ω to 1800Ω	
		BLM15BX		0402 (1005)	-	75Ω to 1800Ω	
		BLM18BA/BB/BD		0603 (1608)	-	5Ω to 2500Ω	
		For Digital Interface Lines	BLM21BB/BD	0805 (2012)	-	5Ω to 2700Ω	
			BLA2AB (4 circuits array)	0804 (2010)	-	10Ω to 1000Ω	
			BLA31BD (4 circuits array)	1206 (3216)	-	120Ω to 1000Ω	
			BLM18RK	0603 (1608)	-	120Ω to 1000Ω	
			BLM21RK	0805 (2012)	-	120Ω to 1000Ω	

* The derating of rated current is required for some items according to the operating temperature.

For automotive grade products, please refer to the catalog C51E, "EMI Suppression Filters (for DC)/Chip Inductors for Automotive."

Continued on the following page. ↗



Chip Ferrite Bead





		Series	Size Code inch (mm)	Max. Rated Current (mA)	Impedance at 100MHz (Rated Current)
For General Band Noise	Power Lines Type	BLM02KX*	01005 (0402)	1500	10Ω to 18Ω (1.2A to 1.5A)
		BLM02PX*	01005 (0402)	1100	10Ω to 60Ω (0.5A to 1.1A)
		BLM03PX*	0201 (0603)	1800	22Ω to 120Ω (0.9A to 1.8A)
		BLM03PG	0201 (0603)	900	22Ω to 33Ω (0.75A to 0.9A)
		BLM15KD*	0402 (1005)	3800	20Ω to 120Ω (1.5A to 3.8A)
		BLM15PX*	0402 (1005)	3000	33Ω to 600Ω (0.9A to 3A)
		BLM15PD*	0402 (1005)	2200	30Ω to 120Ω (1.3A to 2.2A)
		BLM15PG	0402 (1005)	1000	10Ω (1A)
		BLM18SN*/SP* (Low DC Resistance Type)	0603 (1608)	8000	22Ω to 1000Ω (1.2A to 8A)
		BLM18SG*/SD* (Low DC Resistance Type)	0603 (1608)	6000	22Ω to 330Ω (1.5A to 6A)
		BLM18KG* (Low DC Resistance Type)	0603 (1608)	6000	26Ω to 1000Ω (1A to 6A)
		BLM18PG*	0603 (1608)	3000	30Ω to 470Ω (1A to 3A)
		BLM21SN*/SP* (Low DC Resistance Type)	0805 (2012)	8500	30Ω to 1000Ω (1.6A to 8.5A)
		BLM21PG*	0805 (2012)	6000	22Ω to 330Ω (1.5A to 6A)
		BLM31SN* (Low DC Resistance Type)	1206 (3216)	12000	50Ω (12A)
		BLM31KN*	1206 (3216)	6000	120Ω to 1000Ω (2A to 6A)
		BLM31PG*	1206 (3216)	6000	33Ω to 600Ω (1.5A to 6A)
BLM41PG*	1806 (4516)	6000	60Ω to 1000Ω (1.5A to 6A)		
For GHz Band Noise	Universal Type [Power Lines/Signal Lines]	BLM03EB*	0201 (0603)	600	25Ω to 50Ω (0.4A to 0.6A)
		BLM15EG*	0402 (1005)	1500	120Ω to 220Ω (0.7A to 1.5A)
		BLM15EX*	0402 (1005)	1800	120Ω to 470Ω (0.95A to 1.8A)
		BLM18EG*	0603 (1608)	2000	100Ω to 600Ω (0.5A to 2A)
		BLM18HE*	0603 (1608)	800	600Ω to 1500Ω (0.5A to 0.8A)
	Signal Lines Type	BLM03HG	0201 (0603)	-	600Ω to 1200Ω
		BLM03HD	0201 (0603)	-	330Ω to 1800Ω
		BLM03HB	0201 (0603)	-	190Ω to 400Ω
		BLM15HG	0402 (1005)	-	600Ω to 1000Ω
		BLM15HD	0402 (1005)	-	600Ω to 1800Ω
		BLM15HB	0402 (1005)	-	120Ω to 220Ω
		BLM18HG	0603 (1608)	-	470Ω to 1000Ω
		BLM18HD	0603 (1608)	-	470Ω to 1000Ω
		BLM18HB	0603 (1608)	-	120Ω to 330Ω
BLM18HK	0603 (1608)	-	330Ω to 1000Ω		
For High-GHz Band Noise	Signal Lines Type	BLM15GG	0402 (1005)	-	220Ω to 470Ω
		BLM15GA	0402 (1005)	-	75Ω
		BLM18GG	0603 (1608)	-	470Ω
	Power Lines Type	BLM18DN*	0603 (1608)	1400	150Ω to 600Ω (0.7A to 1.4A)

		Series	Size Code inch (mm)	Max. Rated Current (A)	Impedance at 100MHz (Rated Current)
For General Band Noise	Large Current Type Power Lines Type	BLT5BPT*	2020 (5050)	11	68Ω (11A)





* The derating of rated current is required for some items according to the operating temperature.
For automotive grade products, please refer to the catalog C51E, "EMI Suppression Filters (for DC)/Chip Inductors for Automotive."



Application Specified Noise Filter

	Series	Size Code inch (mm)	Max. Rated Current (mA)	Impedance at 900MHz	Impedance at 1.7GHz
For Audio Lines	 NFZ03SG_10	0201 (0603)	305	330Ω to 1600Ω	400Ω to 1200Ω
	 NFZ15SG_10	0402 (1005)	500	770Ω to 4600Ω	900Ω to 1800Ω
	 NFZ15SG_11	0402 (1005)	1100	100Ω to 330Ω	160Ω to 540Ω

	Series	Size Code inch (mm)	Max. Rated Current (mA)	Impedance at 100MHz	Impedance at 900MHz
For Audio Lines	 NFZ15SF_10	0402 (1005)	-	1000Ω	-
	 NFZ15SR_10	0402 (1005)	-	200Ω to 500Ω	1500Ω to 3500Ω
	 NFZ18SM_10*	0603 (1608)	-	120Ω to 700Ω	-
	 NFZ2MSM_10	0806 (2016)	-	100Ω to 600Ω	-
	 NFZ32SW_10	1210 (3225)	-	300Ω to 900Ω	-

	Series	Size Code inch (mm)	Max. Rated Current (mA)	Impedance at 10MHz
For Audio Lines	 NFZ2MSD_10*	0806 (2016)	-	15Ω to 130Ω

	Series	Size Code inch (mm)	Max. Rated Current (mA)	Impedance at 1MHz
For LED Lighting Equipments	 NFZ5BBW_LN10*	2020 (5050)	4000	2.9Ω to 140Ω
	 NFZ2HBM_10	1008 (2520)	1200	1.5Ω to 60Ω
	 NFZ32BW_10*	1210 (3225)	2550	3.6Ω to 880Ω
	 NFZ32BW_11*	1210 (3225)	2900	3.3Ω to 150Ω

	Series	Size Code inch (mm)	Max. Rated Current (A)	Impedance at 700MHz
Frequency Specified Noise Filters	 BLF02JD*	01005 (0402)	-	360Ω to 470Ω
	 BLF02GD	01005 (0402)	-	1600Ω
	 BLF03JD*	0201 (0603)	-	420Ω



	Series	Size Code inch (mm)	Max. Rated Current (A)	Impedance at 2.4GHz
Frequency Specified Noise Filters	 BLF02RD*	01005 (0402)	-	330Ω to 470Ω

	Series	Size Code inch (mm)	Max. Rated Current (A)	Impedance at 5GHz
Frequency Specified Noise Filters	 BLF03VK*	0201 (0603)	1.2	60Ω to 220Ω

* The derating of rated current is required for some items according to the operating temperature.
For automotive grade products, please refer to the catalog C51E, "EMI Suppression Filters (for DC)/Chip Inductors for Automotive."



Continued on the following page. ↗

Application Specified Noise Filter, LC Combined Filter

		Series	Size Code inch (mm)	Max. Rated Current (mA)	Impedance at 100MHz (Rated Current)
For General Band Noise	Power Lines Type	 BLE18PS*	0603 (1608)	8000	8.5Ω (8A)
		 BLE18PK*	0603 (1608)	6000	10Ω to 16Ω (5A to 6A)
		 BLE32PN	1210 (3225)	10000	26Ω to 30Ω (10A)

























LC Combined Filter



		Series	Size Code inch (mm)	Max. Rated Current (mA)	Nominal Cut-off Frequency
Signal Lines Type	 NFL18ST	0603 (1608)	-	50MHz to 500MHz	
	 NFL18SP	0603 (1608)	-	150MHz to 500MHz	
	 NFL21SP	0805 (2012)	-	10MHz to 500MHz	
	 NFA18SL (4 circuits array)	0603 (1608)	-	50MHz to 480MHz	
	 NFA18SD (4 circuits array)	0603 (1608)	-	180MHz to 200MHz	
	 NFA21SL (4 circuits array)	0805 (2012)	-	50MHz to 330MHz	
	 NFW31SP	1206 (3216)	-	10MHz to 500MHz	

		Series	Size Code inch (mm)	Max. Rated Current (mA)	Capacitance
Universal Type [Power Lines/Signal Lines]	 NFE31PT	1206 (3216)	6000	22pF to 2200pF	
	 NFE61PT	2706 (6816)	2000	33pF to 4700pF	

* The derating of rated current is required for some items according to the operating temperature.
For automotive grade products, please refer to the catalog C51E, "EMI Suppression Filters (for DC)/Chip Inductors for Automotive."

Common Mode Choke Coil/Common Mode Noise Filter













		Series	Size Code inch (mm)	Max. Rated Current (mA)	Common Mode Impedance at 100MHz	
Signal Lines Type	For Audio Lines	 DLM11GN	0504 (1210)	-	600Ω	
	For Ultra-High-Speed Signal Lines	 NFGONCN (3 Lines)	03025 (0806)	-	25Ω	
		 NFGOQHB	025020 (0605)	-	(5Ω) to (15Ω)	
		 DLMOQSN	025020 (0605)	-	50Ω to 90Ω	
		 DLMOQSB	025020 (0605)	-	12Ω to 35Ω	
		 DLMONSN	03025 (0806)	-	50Ω to 90Ω	
		 DLMONSM	03025 (0806)	-	90Ω	
		 DLMONSB	03025 (0806)	-	12Ω to 28Ω	
		 DLM11SN	0504 (1210)	-	45Ω to 90Ω	
		 DLP11SN	0504 (1210)	-	67Ω to 330Ω	
		 DLP11SA	0504 (1210)	-	35Ω to 90Ω	
		 DLP11RN	0504 (1210)	-	45Ω	
		 DLP11RB	0504 (1210)	-	15Ω to 40Ω	
		 DLP11TB	0504 (1210)	-	80Ω	
		 DLP31SN	1206 (3216)	-	120Ω to 550Ω	
		 DLP1NDN (2 circuits array)	05025 (1506)	-	35Ω to 90Ω	
		 DLP2ADA (2 circuits array)	0804 (2010)	-	35Ω to 90Ω	
		 DLP2ADN (2 circuits array)	0804 (2010)	-	67Ω to 280Ω	
		 DLP31DN (2 circuits array)	1206 (3216)	-	90Ω to 440Ω	
		 DLW21S	0805 (2012)	-	67Ω to 920Ω	
		 DLW21H	0805 (2012)	-	67Ω to 180Ω	
		 DLW31S	1206 (3216)	-	90Ω to 2200Ω	
		Universal Type [Power Lines/Signal Lines]		 DLW44S*	1515 (4040)	3100
			 DLW5AH/DLW5BS*	2014 (5036) / 2020 (5050)	5000	(190Ω) to (4000Ω)
		 DLW5AT*/DLW5BT*	2014 (5036) / 2020 (5050)	6000	(50Ω) to (2700Ω)	

		Series	Size Code inch (mm)	Max. Rated Current (A)	Common Mode Impedance at 10MHz
Large Current Type for Automotive Available		 PLT5BPH*	2020 (5050)	5.6	100Ω to 500Ω
		 PLT10HH*	-	18	45Ω to 1000Ω

		Series	Size Code inch (mm)	Max. Rated Current (mA)	Common Mode Impedance at 100MHz
Large Current Type for Automotive Available		 UCMH0907	3527 (9070)	5000	(700Ω)



* The derating of rated current is required for some items according to the operating temperature.
For automotive grade products, please refer to the catalog C51E, "EMI Suppression Filters (for DC)/Chip Inductors for Automotive."

Block Type EMIFIL

		Series	Height (mm)	Rated Voltage (Vdc)	Rated Current (A)
Power Lines Type	SMD Type	 BNX022*	3.1	50	20
		 BNX023*	3.1	100	20
		 BNX024*	3.5	50	20
		 BNX025*	3.5	25	20
		 BNX026*	3.5	50	20
		 BNX027*	3.5	16	20
		 BNX028*	3.5	16	20
		 BNX029*	3.5	6.3	20
	Lead Type	 BNX002	12.5 max.	50	10
		 BNX003	12.5 max.	150	10
		 BNX005	13.0 max.	50	15
		 BNX012*	8.5 max.	50	15
		 BNX016*	8.5 max.	25	15

* The derating of rated current is required for some items according to the operating temperature.
For automotive grade products, please refer to the catalog C51E, "EMI Suppression Filters (for DC)/Chip Inductors for Automotive."

Noise Suppression Filters (Lead Type), Others

	Series	
Lead Type EMIFIL	 DSS1	
Common Mode Choke Coils	 PLT09H	 PLT10HN*

* The derating of rated current is required for some items according to the operating temperature.

ESD Protection Devices

Support ESD protection for various kinds of electronic devices.

Silicon ESD Protection Devices LXES_T Series

Applying accumulated design technology for excellent ESD suppression performance.

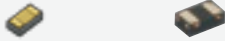

Detailed Catalogs

For more details, please refer to our printed catalogs and the PDF catalogs on our website.

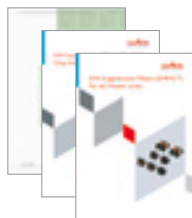

- EMI Suppression Filters (for DC)/Chip Inductors for Automotive Cat. No. C51E
- Noise Suppression by EMIFIL Digital Equipment Application Manual Cat. No. C33E
- Noise Suppression by EMIFIL Application Guide Application Manual Cat. No. C35E
- Application Manual for Power Supply Noise Suppression and Decoupling for Digital ICs Cat. No. C39E

Inductors (Coils)

Broad Lineup of Chip Inductors and Power Inductors

Summary

Murata's chip inductors are optimally designed, making full use of multiple construction techniques, such as the multilayer construction technique, film construction technique, and the wire wound construction technique according to the application. We offer an extensive lineup of inductors for power supplies to high frequency.

In addition, newly adopted metal alloy material has extended the power inductor lineup.

Lineup

- Inductors for Power Lines
- RF Inductors
- General Circuit Inductors
- Variable Inductors



Online design support tool: SimSurfing

You can view inductor characteristics and select appropriate power inductors for DC-DC converters

The screenshot displays the SimSurfing web application. At the top, it says 'Design Support Software "SimSurfing"'. Below this, there are several navigation buttons: 'Multilayer Ceramic Capacitors', 'Three-Terminal Capacitors', 'Lead Type Ceramic Capacitors', 'Resonating SMD Type Ceramic Capacitors', 'Polymer Capacitors', 'RF Inductors', and 'Power Inductors'. A red box highlights 'RF Inductors' and 'Power Inductors'. A red arrow points from 'Power Inductors' to the 'DC-DC Converter Design Support Tool' in the 'Selection Tool' section. Below the Selection Tool, there is a detailed view of the tool's output, which includes a table of inductor specifications and several graphs showing inductor characteristics.

Part Number	Value	Inductance (nH)	DC Resistance (mΩ)	Q Factor	Self-Resonant Frequency (MHz)	Application
0402-0800	80	0.0008	0.0008	100	100	General
0402-0800	100	0.001	0.001	100	100	General
0402-0800	150	0.0015	0.0015	100	100	General
0402-0800	200	0.002	0.002	100	100	General
0402-0800	300	0.003	0.003	100	100	General
0402-0800	400	0.004	0.004	100	100	General
0402-0800	500	0.005	0.005	100	100	General
0402-0800	600	0.006	0.006	100	100	General
0402-0800	700	0.007	0.007	100	100	General
0402-0800	800	0.008	0.008	100	100	General
0402-0800	900	0.009	0.009	100	100	General

<https://ds.murata.co.jp/simsurfing/>

Inductors for Power Lines

Main Type:

- Wound Metal Alloy
- Multilayer Type
- Wound Ferrite Core



Inductors (Coils)

We have an extensive lineup of inductors covering a wide range of sizes from 1.6 mm x 0.8 mm to 12 mm square, which are manufactured using multiple techniques that include metal alloy wire wound construction technique and ferrite multilayer technique. We offer the optimum inductors for a wide range of applications including wearable devices, smartphones, medical applications, industrial electronics, and on board devices.

Structure	Description	Series
Wound Metal Alloy	Supports high current by using metal materials in which magnetic saturation does not occur so easily. This product can be used for a wide range of high current power circuits from smart phones to industrial electronics and automotive device applications.	DFEC/DFES series FSD series
Multilayer Type	The features of this product is its small size and low profile. For example, 2012 or smaller footprint and 0.6mm height. This is ideal for low power circuits, including wearable devices and smartphones.	LQM series
Wound Ferrite Core	A feature of this product is the extensive lineup which supports an inductance of 100 uH or more. It is suitable for step-up power supply circuits in backlights, and choke applications.	LQH series DEM series

Recommended Lineup (General)

List of inductance values

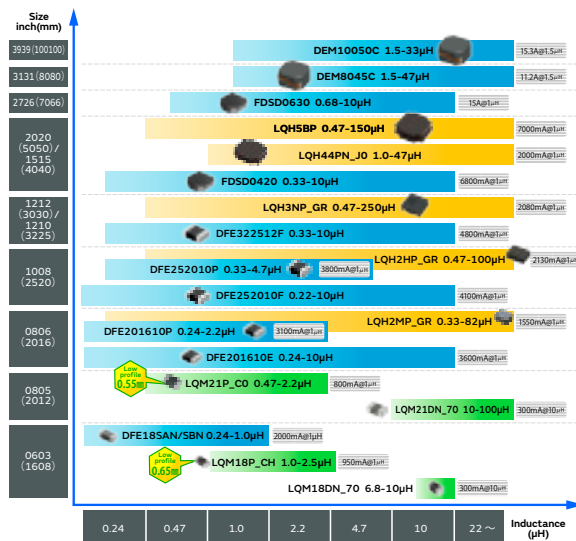

List of rated current values

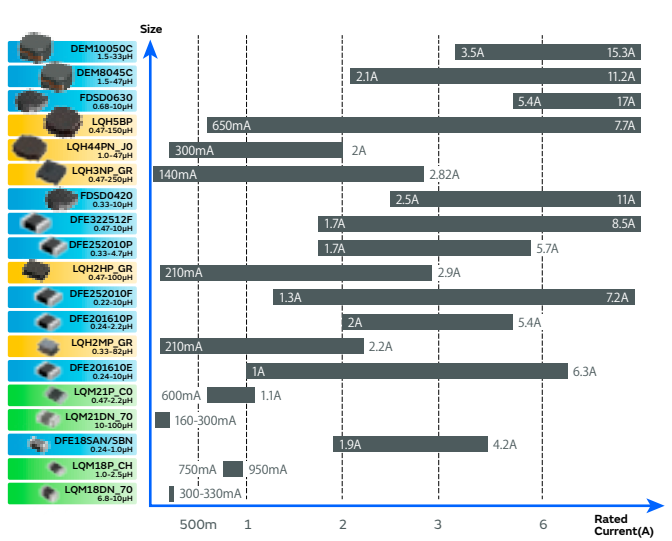

Recommended Lineup (For Automotive)



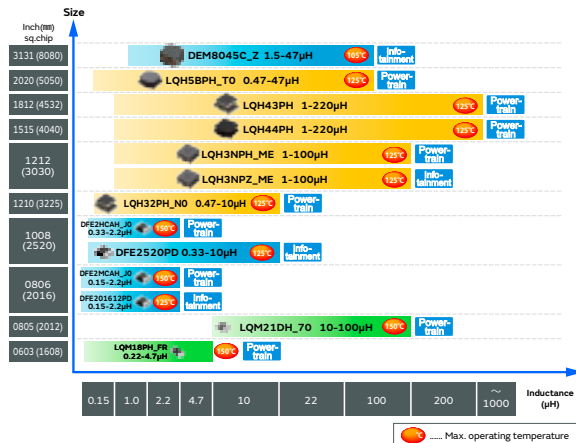



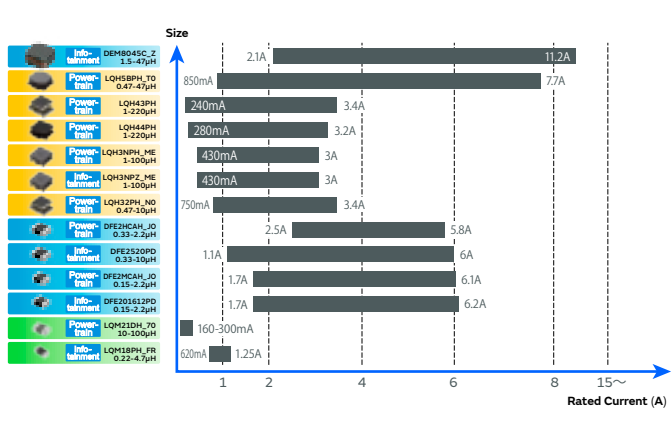





























List of inductance values











List of rated current values



For Power Circuits (For General)







































Structure	Size Code inch (mm)	Short Series Name/View	Series	Thickness (mm/max.)	Inductance Range	Rated Current Range
Wound Metal Alloy	0603 (1608)	DFE18SAN	 DFE18SAN_E0	0.8	240nH to 1µH	2A to 4.2A
			 DFE18SAN_G0	1.0	240nH to 1µH	2.1A to 4.9A
DFE18SBN		 DFE18SBN_E0	0.8	1µH	1.9A	
LQM18DN		 LQM18DN_70	0.95	6.8µH to 10µH	300mA to 330mA	
LQM18PN		 LQM18PN_B0	0.4	1.5µH	600mA	
		 LQM18PN_C0	0.55	470nH to 2.2µH	700mA to 850mA	
		 LQM18PN_D0	0.75	2.5µH	700mA	
		 LQM18PN_DH	0.75	2.2µH	650mA	
		 LQM18PN_F0	0.95	1µH	600mA	
		 LQM18PN_FH	0.95	470nH to 2.2µH	700mA to 1.4A	
	 LQM18PN_FR	0.95	220nH to 4.7µH	620mA to 1.25A		
	 LQM18PN_GH	1.0	1µH to 3.3µH	1.05A		
 LQM18PW_CH	0.65	1µH to 2.5µH	750mA to 950mA			
Wound Metal Alloy	0805 (2012)	DFE2012	 DFE201210U	1.0	240nH to 2.2µH	2A to 6.5A
Multilayer Type		LQM21PN	 LQM21PN_C0	0.55	470nH to 2.2µH	600mA to 1.1A
			 LQM21PN_CA	0.65	2.2µH	1.05A
			 LQM21PN_CH	0.55	470nH to 2.2µH	1.05A to 1.6A
			 LQM21PN_EH	0.8	240nH to 2.2µH	1.1A to 2.8A
			 LQM21PN_G0	1.0	470nH to 3.3µH	800mA to 1.3A
			 LQM21PN_GC	1.0	1µH to 2.2µH	800mA to 900mA
			 LQM21PN_GH	1.0	470nH to 4.7µH	1A to 2.4A
			 LQM21PN_GR	1.0	1µH to 4.7µH	800mA to 1.3A
			 LQM21PN_GS	1.0	2.2µH to 4.7µH	750mA to 950mA
Wound Metal Alloy	0806 (2016)	DFE2016	 DFE201610C	1.0	560nH to 2.2µH	1.5A to 2.8A
			 DFE201610E	1.0	240nH to 10µH	1A to 6.3A
			 DFE201610P	1.0	240nH to 2.2µH	2A to 5.4A
			 DFE201612C	1.2	470nH to 2.2µH	1.6A to 3.4A
			 DFE201612E	1.2	240nH to 4.7µH	1.8A to 6.6A
			 DFE201612P	1.2	240nH to 2.2µH	2.1A to 6.5A
Wound Ferrite Core	0806 (2016)	LQH2MCN	 LQH2MCN_02	0.95	1µH to 82µH	90mA to 485mA
			 LQH2MCN_52	0.7	1µH to 22µH	130mA to 595mA
LQH2MPN		 LQH2MPN_GR	0.95	330nH to 82µH	210mA to 2.2A	
		LQM2MPN	 LQM2MPN_DH	0.7	2.2µH	1.27A
 LQM2MPN_EH			0.8	240nH to 2.2µH	1.1A to 4.1A	
 LQM2MPN_G0			1.0	470nH to 4.7µH	1.1A to 1.6A	
 LQM2MPN_GH			1.0	160nH to 2.2µH	1.3A to 5A	

Continued on the following page. ↗











Structure	Size Code inch (mm)	Short Series Name/View	Series	Thickness (mm/max.)	Inductance Range	Rated Current Range	
Wound Metal Alloy	1008 (2520)		DFE252007F	0.7	470nH to 4.7µH	1.2A to 3.3A	
			DFE252008C	0.8	470nH to 4.7µH	1.1A to 3A	
			DFE252008U	0.8	470nH to 10µH	1A to 4.5A	
			DFE252010C	1.0	470nH to 10µH	1A to 3.5A	
			DFE252010F	1.0	220nH to 10µH	1.7A to 7.2A	
			DFE252010P	1.0	330nH to 4.7µH	1.7A to 5.7A	
			DFE252012C	1.2	470nH to 10µH	1A to 3.8A	
			DFE252012F	1.2	330nH to 10µH	1.4A to 7.6A	
			DFE252012P	1.2	330nH to 4.7µH	2A to 6.6A	
Wound Ferrite Core	1008 (2520)		LQH2HPN_DR	0.6	470nH to 22µH	270mA to 1.67A	
			LQH2HPN_GR	1.0	470nH to 100µH	210mA to 2.9A	
			LQH2HPN_JR	1.2	470nH to 22µH	540mA to 3.5A	
Multilayer Type	1008 (2520)		LQM2HPN_CH	0.55	240nH to 2.2µH	850mA to 2.55A	
			LQM2HPN_E0	0.8	560nH	1.5A	
			LQM2HPN_EH	0.8	240nH to 2.2µH	1.3A to 4.5A	
			LQM2HPN_GO	1.0	470nH to 4.7µH	1.1A to 1.8A	
			LQM2HPN_GC	1.0	1µH to 4.7µH	800mA to 1.5A	
			LQM2HPN_GH	1.0	240nH to 2.2µH	1.5A to 5A	
			LQM2HPN_GS	1.0	2.2µH to 4.7µH	1A to 1.1A	
			LQM2HPN_J0	1.2	1µH to 3.3µH	1A to 1.5A	
			LQM2HPN_JH	1.2	470nH to 2.2µH	1.5A to 3.2A	
Wound Ferrite Core	3mm square		DEM2812C	1.2	470nH to 12µH	760mA to 3.1A	
			DEM2815C	1.5	470nH to 15µH	800mA to 3.9A	
			DEM2818C	1.8	470nH to 12µH	1A to 4.7A	
			DEM3512C	1.2	680nH to 22µH	530mA to 2.5A	
			DEM3518C	1.8	560nH to 22µH	880mA to 3.4A	
			LQH3NPN_GR	1.0	470nH to 250µH	140mA to 2.82A	
			LQH3NPN_JR	1.2	680nH to 47µH	570mA to 2.86A	
			LQH3NPN_ME	1.5	1µH to 100µH	430mA to 3A	
			LQH3NPN_ME	1.5	1µH to 100µH	430mA to 3A	
Multilayer Type	1206 (3216)		LQM31PN	LQM31PN_00	0.95	470nH to 4.7µH	700mA to 1.4A
Wound Metal Alloy	1210 (3225)		DFE322510C	1.0	470nH to 10µH	1A to 3.8A	
			DFE322512C	1.2	470nH to 10µH	1.2A to 4.7A	
			DFE322512F	1.2	330nH to 10µH	1.7A to 8.5A	
Wound Ferrite Core	1210 (3225)		LQH32PB_N0	1.7	470nH to 120µH	200mA to 3.4A	
			LQH32PB_NC	1.7	470nH to 22µH	650mA to 4.4A	
			LQH32PN_N0	1.7	470nH to 120µH	200mA to 3.4A	
			LQH32PN_NC	1.7	470nH to 22µH	650mA to 4.4A	
Multilayer Type	1210 (3225)		LQM32PN_GO	1.0	1µH	1.8A	
			LQM32PN_GC	1.0	1µH	2.2A	

Continued on the following page. ↗

Inductors for Power Lines

Structure	Size Code inch (mm)	Short Series Name/View	Series	Thickness (mm/max.)	Inductance Range	Rated Current Range	
Wound Metal Alloy	4mm square	FDSD04	 FDSD0412	1.2	330nH to 4.7µH	2.5A to 7.5A	
			 FDSD0415	1.5	220nH to 4.7µH	2.9A to 12A	
			 FDSD0420	2.0	330nH to 10µH	2.5A to 11A	
			 FDSD0420W	2.0	15µH to 22µH	1.5A to 1.9A	
Wound Ferrite Core		LQH44PN	 LQH44PN_J0	1.2	1µH to 47µH	380mA to 2A	
			 LQH44PN_P0	1.8	1µH to 22µH	800mA to 2.95A	
			 LQH43P	2.8	1µH to 220µH	240mA to 3.4A	
			 LQH43PN_26	2.8	1µH to 220µH	240mA to 3.4A	
Wound Ferrite Core		5mm square	LQH5BP	 LQH5BPB_T0	2.2	470nH to 22µH	1.4A to 7.7A
				 LQH5BPN_38	4.0	1µH to 150µH	650mA to 7A
				 LQH5BPN_T0	2.2	470nH to 22µH	1.4A to 7.7A
			D52LC/D53LC	 D52LC	2.0	1.2µH to 100µH	260mA to 2.44A
	 D53LC			3.0	1.1µH to 220µH	350mA to 3.87A	
	Wound Metal Alloy		FDSD05	 FDSD0512	1.2	1µH to 6.8µH	2.3A to 6.1A
 FDSD0515		1.5		1µH to 4.7µH	3.2A to 7A		
 FDSD0518		1.8		680nH to 10µH	2.7A to 9A		
Wound Ferrite Core	6 to 9mm square	DG60	 DG6028C	2.8	1µH to 22µH	1.7A to 5.8A	
			 DG6045C	4.5	1µH to 100µH	900mA to 9.5A	
			 DG6050C	5.0	1.2µH to 100µH	1.2A to 9.8A	
		D63	 D63LCB	3.0	1µH to 150µH	440mA to 4.52A	
		DS75LC	 DS75LC	5.0	1µH to 470µH	430mA to 9.2A	
		DEM80	 DEM8030C	3.0	2.2µH to 47µH	1.3A to 6.2A	
			 DEM8040C	4.0	1.5µH to 33µH	2.4A to 10A	
			 DEM8045C	4.5	1.5µH to 47µH	2.1A to 11.2A	
		DG80	 DG8040C	4.0	1µH to 100µH	1.3A to 10.4A	
		Wound Metal Alloy	FCUL05	 FCUL0530	3.0	360nH to 470nH	16A to 18A
 FDSD06	3.0			680nH to 10µH	5.4A to 17A		
FCUL06	 FCUL0624			2.4	220nH to 470nH	17A to 24A	
	 FCUL0630			3.0	120nH to 680nH	15A to 32A	
Wound Ferrite Core	10mm square and over	DEM10050	 DEM10050C	5.0	1.5µH to 33µH	3.5A to 15.3A	
			 DEM10050C_DD	5.0	1.5µH to 33µH	3.5A to 15.3A	
		DS10/DS12	 DS104C2	4.8	1.1µH to 120µH	970mA to 11.7A	
			 DS106C2	6.8	1.2µH to 330µH	690mA to 12A	
			 DS126C2	6.8	1.7µH to 680µH	580mA to 11.8A	
		Wound Metal Alloy	FDA10/FDA12	 FDA1055	5.5	560nH to 5.6µH	8A to 27.7A
 FDA1254	5.4			680nH to 8µH	9.1A to 29.1A		
FCUL10	 FCUL1040	4.0	180nH to 420nH	34A to 53A			
	 FCUL1060	6.0	360nH to 560nH	34A to 41A			









For Choke Circuits (For General)

Structure	Size Code inch (mm)	Short Series Name/View	Series	Thickness (mm/max.)	Inductance Range	Rated Current Range
Wound Ferrite Core	0402 (1005)	LQW15DN 	LQW15DN_00	0.7	10μH to 15μH	100mA to 120mA
	0603 (1608)	LQM18FN 	LQM18FN_00	0.9	1μH to 10μH	50mA to 150mA
Multilayer Type	0805 (2012)	LQM21DN 	LQM21DN_00	1.05	1μH to 47μH	7mA to 60mA
			LQM21DN_70	1.45	10μH to 100μH	160mA to 300mA
		LQM21FN 	LQM21FN_00	1.45	1μH to 47μH	7mA to 220mA
			LQM21FN_80	1.45	4.7μH to 10μH	100mA to 120mA
Wound Ferrite Core	1206 (3216)	LQH31CN 	LQH31CN_03	2.0	120nH to 100μH	80mA to 970mA
	1210 (3225)	LQH32CN 	LQH32CN_23	2.2	1μH to 560μH	60mA to 800mA
			LQH32CN_33	2.2	150nH to 10μH	450mA to 1.45A
		LQH32DN 	LQH32DN_23	2.2	1μH to 560μH	60mA to 800mA
			LQH32DN_53	1.7	1μH to 100μH	100mA to 1A
	4mm square	LQH43CN 	LQH43CN_03	2.8	1μH to 470μH	90mA to 1.08A
			LQH43CN_33	2.8	560nH to 3.9μH	1.6A to 2.95A
	5mm square	LQH55DN 	LQH55DN_03	5.0	120nH to 10mH	50mA to 6A
	6 to 9mm square	LQH66SN 	LQH66SN_03	5.0	270nH to 10mH	50mA to 6A

For Power Circuits (Infotainment)

Structure	Size Code inch (mm)	Short Series Name/View	Series	Thickness (mm/max.)	Inductance Range	Rated Current Range
Multilayer Type	0603 (1608)	LQM18PZ	LQM18PZ_CH	0.6	1µH to 2.5µH	750mA to 950mA
			LQM18PZ_DH	0.75	2.2µH	650mA
			LQM18PZ_FH	0.95	2.2µH	700mA
	0805 (2012)	LQM21PZ	LQM21PZ_C0	0.55	470nH to 2.2µH	600mA to 1.1A
			LQM21PZ_G0	1.0	470nH to 3.3µH	800mA to 1.3A
			LQM21PZ_GC	1.0	1µH to 2.2µH	800mA to 900mA
			LQM21PZ_GR	1.0	1µH to 4.7µH	800mA to 1.3A
Multilayer Type	0806 (2016)	DFE2016	DFE201612P_D	1.2	150nH to 2.2µH	1.7A to 6.2A
			LQH2MPZ	LQH2MPZ_GR	0.95	330nH to 82µH
		LQM2MPZ	LQM2MPZ_G0	1.0	470nH to 4.7µH	1.1A to 1.6A
			LQM2MPZ_JH	1.2	100nH	4A
Wound Ferrite Core		LQH2HPZ	LQH2HPZ_DR	0.6	470nH to 22µH	270mA to 1.67A
			LQH2HPZ_GR	1.0	470nH to 22µH	460mA to 2.9A
			LQH2HPZ_JR	1.2	470nH to 22µH	540mA to 3.5A
Multilayer Type	1008 (2520)	LQM2HPZ	LQM2HPZ_E0	0.8	560nH	1.5A
			LQM2HPZ_G0	1.0	470nH to 4.7µH	1.1A to 1.8A
			LQM2HPZ_GC	1.0	1µH to 4.7µH	800mA to 1.5A
			LQM2HPZ_GS	1.0	2.2µH to 4.7µH	1A to 1.1A
			LQM2HPZ_J0	1.2	1µH to 3.3µH	1A to 1.5A
Wound Metal Alloy		DFE2520	DFE252012P_D	1.2	330nH to 10µH	1.1A to 6A
Wound Ferrite Core	3mm square	LQH3NPZ	LQH3NPZ_GR	1.0	470nH to 47µH	460mA to 2.82A
			LQH3NPZ_JR	1.2	680nH to 47µH	570mA to 2.86A
			LQH3NPZ_ME	1.5	1µH to 100µH	430mA to 3A
Wound Metal Alloy		DFE3225	DFE322520F_D	2.0	1µH to 4.7µH	3.4A to 7.5A
Wound Ferrite Core	1210 (3225)	LQH32PZ	LQH32PZ_N0	1.7	470nH to 120µH	200mA to 3.4A
			LQH32PZ_NC	1.7	470nH to 22µH	650mA to 4.4A
	4mm square	LQH43PZ	LQH43PZ_26	2.8	1µH to 220µH	240mA to 3.4A
	5mm square	LQH5BPZ	LQH5BPZ_T0	2.2	470nH to 22µH	1.4A to 7.7A
	6 to 9mm square	DEM80	DEM8045C_Z	4.5	1.5µH to 47µH	2.1A to 11.2A

For Power Circuits (Powertrain)

Structure	Size Code inch (mm)	Short Series Name/View	Series	Thickness (mm/max.)	Inductance Range	Rated Current Range
Multilayer Type	0603 (1608)	LQM18PH 	LQM18PH_FR	0.95	220nH to 4.7µH	620mA to 1.25A
	0805 (2012)	LQM21PH 	LQM21PH_GO	1.0	0.47µH to 0.54µH	1.3A
			LQM21PH_GC	1.0	1.0µH to 2.2µH	800mA to 1A
Wound Metal Alloy	0806 (2016)	DFE2MCAH 	DFE2MCAH_J0	1.2	0.15µH to 2.2µH	1.7A to 6.1A
	1008 (2520)	DFE2HCAH 	DFE2HCAH_J0	1.2	330nH to 2.2µH	2.5A to 5.8A
Wound Ferrite Core	1212 (3030)	LQH3NPH 	LQH3NPH_ME	1.5	1µH to 100µH	430mA to 3A
	1210 (3225)	LQH32PH 	LQH32PH_N0	1.7	470nH to 10µH	750mA to 3.4A
			LQH32PH_NC	1.7	470nH to 22µH	650mA to 4.4A
	4mm square	LQH44PH 	LQH44PH_PR	1.8	1µH to 220µH	330mA to 4.3A
			LQH43PH 	LQH43PH_26	2.8	1µH to 220µH
	5mm square	LQH5BPH 	LQH5BPH_T0	2.2	0.47µH to 47µH	850mA to 7.7A

For Choke Circuits (Infotainment)

Structure	Size Code inch (mm)	Short Series Name/View	Series	Thickness (mm/max.)	Inductance Range	Rated Current Range
Wound Ferrite Core	1210 (3225)	LQH32D 	LQH32DZ_23	2.2	1µH to 470µH	60mA to 800mA
			LQH32DZ_53	1.7	1µH to 100µH	100mA to 1A

For Choke Circuits (Powertrain)

Structure	Size Code inch (mm)	Short Series Name/View	Series	Thickness (mm/max.)	Inductance Range	Rated Current Range
Multilayer Type	0805 (2012)	LQM21DH 	LQM21DH_70	1.45	10µH to 100µH	160mA to 300mA
Wound Ferrite Core	1210 (3225)	LQH32C 	LQH32CH_23	2.2	1µH to 22µH	250mA to 800mA
			LQH32CH_33	2.2	150nH to 10µH	450mA to 1.45A
			LQH32CH_53	1.7	1µH to 22µH	250mA to 1A
		LQW32F 	LQW32FT_0H	2.5	10µH to 47µH	500mA to 700mA

RF Inductors

Main Type:

- Film Type
- Wire Wound Type
- Multilayer Type

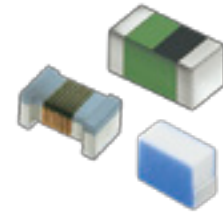

An RF inductor is used for matching applications and choke applications in the RF section which has wireless communication functions. By using three characteristic methods, you can select the optimum series for the intended application. For a smartphone or a module film type LQP series which is compact and also has high Q characteristics is optimum. For an RF inductor of size 1005 mm or more, the high Q wound type LQW series which has a large rated current value is recommended for use in a base station or STB. While the multilayer LQG series has a good balance between cost and performance, it is recommended for a wide range of automotive applications, based on our market achievements over many years. Products that are suitable for choke circuits using magnetic materials, such as the LQW_CN series, LQW_H series and other series are also available for power lines. You can select the optimum series from our lineup, based on either the intended application or the relationship between the size and Q characteristics.

General (0.8×0.4 mm or less)

Lineup list

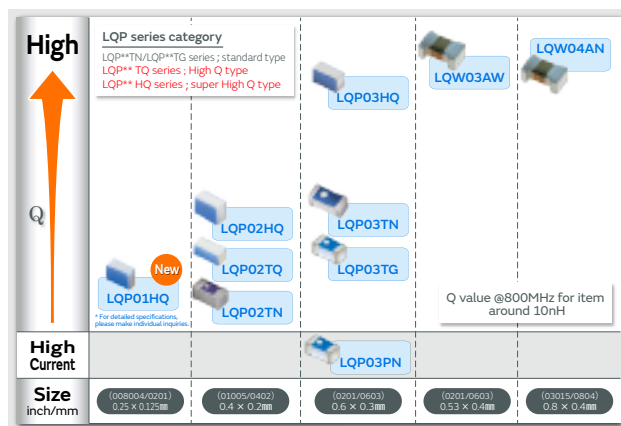

General (1.0×0.5 mm or more)

Lineup list

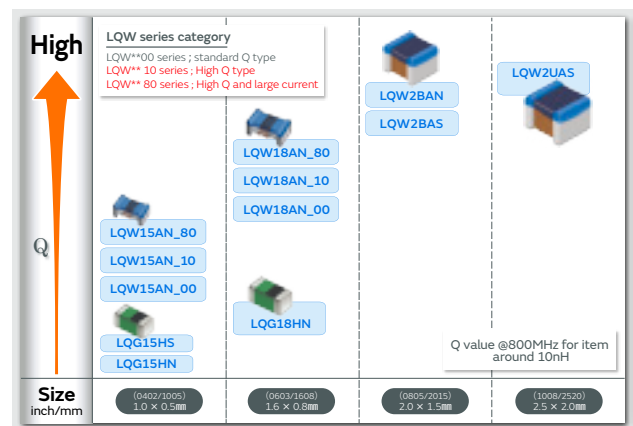





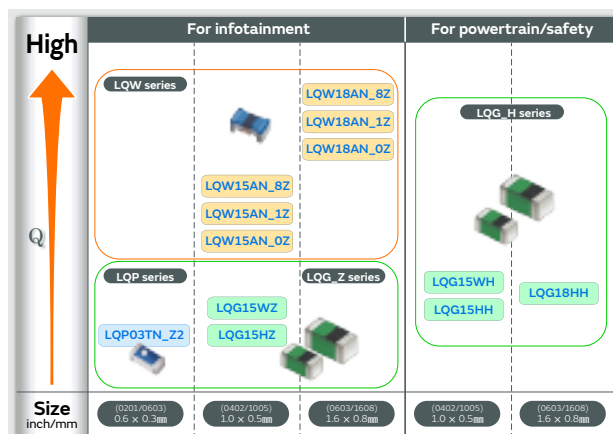







For Automotive



Lineup list



RF Circuits (0.8 x 0.4 mm or less)

Structure	Size Code inch (mm)	Short Series Name/View	Series	Thickness (mm/max.)	Inductance Range	Rated Current Range
Wound non-magnetic type	0201 (0603)	LQW03A	 LQW03AW_00	0.45	1nH to 15.5nH	230mA to 900mA
	03019 (0805)	LQW04A	 LQW04AN_00	0.45	0.8nH to 33nH	140mA to 1.8A
			 LQW04AN_10	0.45	36nH to 56nH	180mA to 200mA
			 LQW04AN_20	0.45	36nH to 56nH	120mA to 155mA
Film type	008004 (0201)	LQP01	 LQP01HQ	0.213	0.3nH to 2.7nH	200mA to 500mA
	01005 (0402)	LQP02	 LQP02HQ_02	0.32	0.2nH to 56nH	100mA to 1A
			 LQP02TQ_02	0.22	0.2nH to 22nH	120mA to 990mA
			 LQP02TN_02	0.22	0.2nH to 39nH	90mA to 320mA
	0201 (0603)	LQP03	 LQP03HQ_02	0.42	0.5nH to 470nH	50mA to 1.1A
			 LQP03TN_02	0.33	0.6nH to 270nH	60mA to 850mA
			 LQP03TG_02	0.33	0.1nH to 120nH	80mA to 850mA
			 LQP03PN_02	0.33	2.2nH to 4.7nH	900mA to 1.4A





RF Circuits (1.0 x 0.5 mm or more)

Structure	Size Code inch (mm)	Short Series Name/View	Series	Thickness (mm/max.)	Inductance Range	Rated Current Range
Wound non-magnetic type	0402 (1005)	LQW15A	 LQW15AN_00	0.6	1.5nH to 120nH	110mA to 1A
			 LQW15AN_10	0.6	1.3nH to 8.4nH	640mA to 1.2A
			 LQW15AN_80	0.6	1.3nH to 75nH	320mA to 3.15A
			 LQW15AW_80	0.66	51nH to 220nH	220mA to 480mA
	0603 (1608)	LQW18A	 LQW18AN_00	1.0	2.2nH to 470nH	75mA to 850mA
			 LQW18AN_10	1.0	2.2nH to 33nH	550mA to 1.4A
			 LQW18AN_80	1.0	2.2nH to 390nH	190mA to 3.2A
			 LQW18AS_00	1.0	1.2nH to 390nH	100mA to 700mA
	0806 (2016)	LQW2B	 LQW18AS_0C	1.0	1.6nH to 390nH	100mA to 700mA
			 LQW2BAN_00	1.52	3.2nH to 200nH	750mA to 3.8A
			 LQW2BAS_00	1.52	2.7nH to 1μH	170mA to 910mA
			 LQW2BHN_03	1.78	3.3nH to 470nH	160mA to 1.32A
	1008 (2520)	LQW2U	 LQW2BHN_13	1.78	2.7nH to 27nH	900mA to 1.9A
			 LQW2UAS_00	2.03	12nH to 4.7μH	260mA to 1A
			 LQW2UAS_0C	2.03	12nH to 8.2μH	170mA to 1A
	1206 (3216)	LQW31H	 LQW31HN_03	2.0	8.8nH to 100nH	230mA to 750mA
Multilayer Type	0402 (1005)	LQG15H	 LQG15HN_02	0.55	1nH to 120nH	150mA to 1A
			 LQG15HS_02	0.55	1nH to 270nH	110mA to 1A
	0603 (1608)	LQG18H	 LQG18HN_00	0.95	1.2nH to 100nH	350mA to 1.1A











For Choke/Tuner Circuits (1.0 x 0.5 mm or more)

Structure	Size Code inch (mm)	Short Series Name/View	Series	Thickness (mm/max.)	Inductance Range	Rated Current Range
Wound Ferrite Core type	0402 (1005)	LQW15C	 LQW15CN_00	0.6	18nH to 200nH	390mA to 1.4A
			 LQW15CN_10	0.6	20nH to 3.3µH	130mA to 2.2A
	0402 (1005)	LQW15D	 LQW15DN_00	0.7	10µH to 15µH	100mA to 120mA
	0603 (1608)	LQW18C	 LQW18CN_00	0.95	4.9nH to 650nH	430mA to 2.6A
	0805 (2012)	LQW21H	 LQW21HN_00	1.0	470nH to 2.2µH	75mA to 160mA
	1206 (3216)	LQH31H	 LQH31HN_03	2.0	54nH to 880nH	180mA to 920mA



For Choke/Tuner Circuits (Infotainment)

Structure	Size Code inch (mm)	Short Series Name/View	Series	Thickness (mm/max.)	Inductance Range	Rated Current Range
Wound Ferrite Core type	0402 (1005)	LQW15C	 LQW15CN_OZ	0.6	18nH to 200nH	390mA to 1.4A
			 LQW15CN_1Z	0.6	20nH to 560nH	300mA to 2.2A
	0603 (1608)	LQW18C	 LQW18CN_OZ	0.95	4.9nH to 650nH	430mA to 2.6A
	1206 (3216)	LQH31H	 LQH31HZ_03	2.0	54nH to 880nH	180mA to 920mA

For RF Circuits (Infotainment)

Structure	Size Code inch (mm)	Short Series Name/View	Series	Thickness (mm/max.)	Inductance Range	Rated Current Range
Wound non-magnetic type	0402 (1005)	LQW15A	 LQW15AN_OZ	0.6	1.5nH to 120nH	110mA to 1A
			 LQW15AN_1Z	0.6	1.3nH to 8.4nH	640mA to 1.2A
			 LQW15AN_8Z	0.6	1.3nH to 75nH	320mA to 3.15A
	0603 (1608)	LQW18A	 LQW18AN_OZ	1.0	2.2nH to 470nH	75mA to 850mA
			 LQW18AN_1Z	1.0	2.2nH to 33nH	550mA to 1.4A
			 LQW18AN_8Z	1.0	2.2nH to 390nH	190mA to 3.2A
			 LQW18AS_OZ	1.0	1.6nH to 390nH	100mA to 700mA
Film type	0201 (0603)	LQP03T	 LQP03TN_Z2	0.33	0.6nH to 120nH	80mA to 850mA
Multilayer Type	0402 (1005)	LQG15H	 LQG15HZ_02	0.55	1nH to 270nH	110mA to 1A
		LQG15W	 LQG15WZ_02	0.6	0.7nH to 150nH	110mA to 1.2A

For RF Circuits (Powertrain)

Structure	Size Code inch (mm)	Short Series Name/View	Series	Thickness (mm/max.)	Inductance Range	Rated Current Range
Multilayer Type	0402 (1005)	LQG15H	 LQG15HH_02	0.55	1nH to 270nH	110mA to 1A
		LQG15W	 LQG15WH_02	0.6	0.7nH to 150nH	110mA to 1.2A
	0603 (1608)	LQG18H	 LQG18HH_00	0.95	1.2nH to 270nH	200mA to 1.1A

LC trap filter

Part number	Impedance (Ω Typ.)			Insertion Loss Characteristic (dB Typ.)			DC Resistance Max.(Ω)	Rated Current (mA)	Self Resonant Frequency (GHz Typ.)
	at 2.40GHz	at 2.44GHz	at 2.50GHz	at 2.40GHz	at 2.44GHz	at 2.50GHz			
LQZ02HQ242A02 	460	600	345	15.0	15.7	13.0	0.55	200	2.44

General Circuit Inductors

Main Type:

- Multilayer Type
- Wire-wound Type
- 2in1 Type





We have an extensive lineup of general purpose inductors for a variety of circuits. You can select an inductor to match your particular application. Wire-wound type LQH_M, LQH_N series are suitable for large inductance, multilayer type LQM_M, LQM_N series are suitable for small size. In addition, we have the 2-in-1 type HEAWS series inductors for digital audio amplifiers.

General Purpose (For General)

Structure	Size Code inch (mm)	Short Series Name/View	Series	Thickness (mm/max.)	Inductance Range	Rated Current Range
Wound Ferrite Core type	0402 (1005)	LQW15CA 	LQW15CA_00	0.66	22nH to 2μH	130mA to 1.3A
	0603 (1608)	LQW18CA 	LQW18CA_00	0.95	32nH to 580nH	450mA to 2.2A
	1206 (3216)	LQH31MN 	LQH31MN_03	2.0	150nH to 100μH	45mA to 250mA
	1210 (3225)	LQH32MN 	LQH32MN_23	2.2	1μH to 560μH	40mA to 445mA
	4mm square	LQH44NN 	LQH44NN_03	4.5	510nH to 470μH	145mA to 4.5A
		LQH43M/N 	LQH43MN_03	2.8	1μH to 1.5mH	40mA to 500mA
		LQH43NN_03	2.8	1μH to 2.4mH	25mA to 500mA	
Multilayer Type	0402 (1005)	LQB15NN 	LQB15NN_10	0.55	220nH to 560nH	300mA to 380mA
	0603 (1608)	LQB18NN 	LQB18NN_10	0.95	220nH to 560nH	300mA to 450mA
		LQM18JN 	LQM18JN_00	0.65	100nH to 160nH	550mA to 650mA
	0805 (2012)	LQM18NN 	LQM18NN_00	0.95	47nH to 2.2μH	15mA to 50mA
		LQM21NN 	LQM21NN_10	1.05	100nH to 4.7μH	30mA to 250mA

General Purpose (For Automotive Infotainment)

Structure	Size Code inch (mm)	Short Series Name/View	Series	Thickness (mm/max.)	Inductance Range	Rated Current Range
Wound Ferrite Core type	1210 (3225)	LQH32NZ 	LQH32NZ_23	2.2	1μH to 470μH	45mA to 445mA
	4mm square	LQH43NZ 	LQH43NZ_03	2.8	1μH to 2.4mH	25mA to 500mA
2in1 Type	10mm square and over	HEAWS 	HEAWS	10.0	3.3μH to 10μH	5A to 8A

General Purpose (For Automotive Powertrain)

Structure	Size Code inch (mm)	Short Series Name/View	Series	Thickness (mm/max.)	Inductance Range	Rated Current Range
Wound Ferrite Core type	1210 (3225)	LQH32NH 	LQH32NH_23	2.2	1µH to 560µH	40mA to 780mA
	4mm square	LQH43NH 	LQH43NH_03	2.8	1µH to 2.2mH	30mA to 1.3A

Variable Inductors

Variable inductor products are coil products that allow the inductance to be easily varied by changing the position of the ferrite core in a threaded structure. The interior is covered by a metal case that is magnetically shielded, while a resin molded structure protects the windings with a high degree of reliability.



5CCEG

6.5×5.9×6.0(H) mm MAX.

Supported inductance range: 0.05 to 2.7µH

Features

- High reliability that conforms to automotive standards
- Operating temperature range: -40°C to +85°C

Applications

- Ideal for use as RF matching transformers for car tuners



FSDVA

5.8×5.8×5.5(H) mm MAX.



Supported inductance range:

0.1 to 52mH(1 to 7 mH for corner sensor applications)



Features

- Resistant to mechanical stress
- Operating temperature range:
Up to 20 mH (-40°C to +105°C)
20 mH or more (-40°C to +85°C)
- High reliability that conforms to automotive standards
- Lead coplanarity guaranteed within 0.1 mm

5CCEG Series

Winding Connection (Bottom View)	Part Number	Test Frequency (MHz)	Resonance Capacitor Range (pF)	Unloaded Q
	#A1313B-0029GGH=P3	100	11.4+3/-3%	72+/-20%
	#A1313B-0030GRG=P3	100	11.4+5/-2%	61+/-20%
	#A1313B-0031GRG=P3	100	11.4+2/-4%	54+/-20%
	#A1313B-0032GGH=P3	100	11.7+3/-3%	72+/-20%

FSDVA Series

Winding Connection (Bottom View)	Part Number	Test Frequency (kHz)	Inductance Range (mH)	Unloaded Q
	N1342JC-0143UG=P3	252	4.4±3%	25 min.
	N1342LE-0144BQE=P3	252	2.5±5%	25 min.

Bias-T Inductor Design Support Tool

To use this tool, go to <https://ds.murata.co.jp/bist/?lcid=en-us>

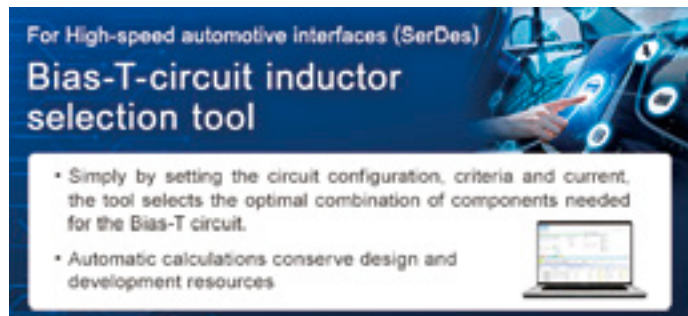

Noise Filter Design Support Tool

To use this tool, go to <https://ds.murata.co.jp/nfst/>

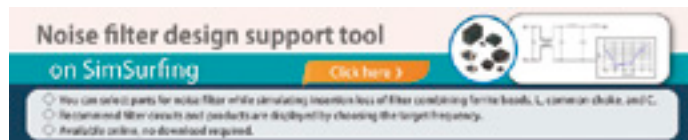

DC-DC Converter Design Support Tool

To use this tool, go to <https://ds.murata.co.jp/mpst/>



Detailed Catalogs

For more details, please refer to our printed catalogs and the PDF catalogs on our website.

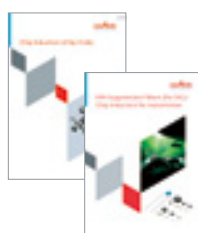

- Chip Inductors (Chip Coils) Cat. No. O05E
- EMI Suppression Filters (for DC)/Chip Inductors for Automotive Cat. No. C51E

Resistors

Full lineup for various applications

Summary

Using Murata's ceramic processing technology and unique materials, we offer a series of resistor products.

Lineup

- High Voltage Resistors

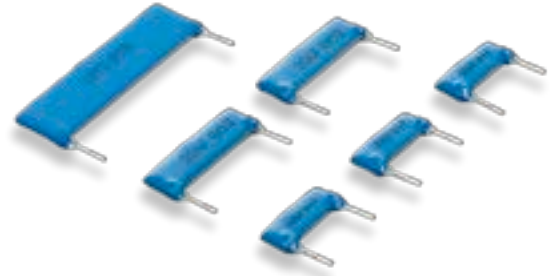

<https://www.murata.com/en-global/products/resistor>

High Voltage Resistors

Featuring thick-film resistors, the Murata MHR series of high-voltage resistors is available in compact and thin SIP packages. Variants with small deviations are also available on request.

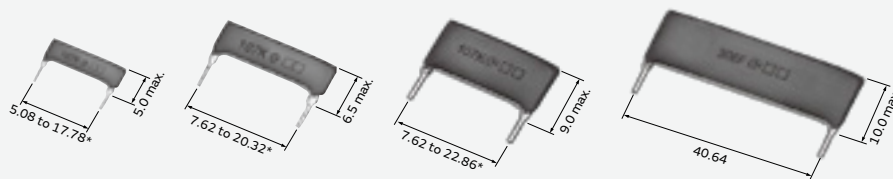

MHR03 Series

MHR04 Series

MHR06 Series

MHR0844 Series

(in mm)

*The terminal pitch is an integral multiple of 2.54mm.

Series	Resistance (min.) (MΩ)	Resistance (max.) (MΩ)	Maximum Operating Voltage (Single Use) (kV)	Maximum Operating Voltage (Molded Use) (kV)	Rated Power (W)
MHR03	1	1000 to 2000	2 to 8	3 to 14	0.3 to 1.0
MHR04	1	1000 to 2000	3.5 to 10	10 to 18	0.6 to 1.7
MHR06	1	1000 to 10000	3.5 to 10	10 to 20	0.8 to 1.6
MHR0844	1	2000	20	35	2.5

Resistance 2 element type is also available.
For resistance value and ratio, please contact us.

Timing Devices

A stable timing source for microprocessors in various electronic devices

Summary

Murata's ceramic processing technology and unique piezoelectric material has led to the development of a range of small and thin ceramic timing devices that offer high oscillation frequency and remarkable oscillation tolerance.

Lineup

- MEMS Resonator ●Crystal Units
- Ceramic Resonators CERALOCK

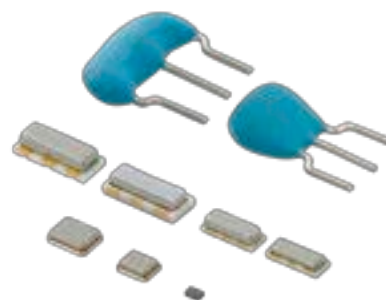

<https://www.murata.com/en-global/products/timingdevice>

IC Part Number - Timing Devices Search

Search for Timing Devices by IC part number or search for IC part number by Timing Devices on our website. It is also possible to search by either oscillating frequency or frequency range.

Part Number	OSC FREQ (MHz)	FREQUENCY TOLERANCE	Q1 (dB)	Q2 (dB)
MEMS1P00000000	10	+/-0.5%	20	20
MEMS1P00000001	10	+/-0.5%	20	20
MEMS1P00000002	10	+/-0.5%	20	20
MEMS1P00000003	10	+/-0.5%	20	20
MEMS1P00000004	10	+/-0.5%	20	20
MEMS1P00000005	10	+/-0.5%	20	20
MEMS1P00000006	10	+/-0.5%	20	20
MEMS1P00000007	10	+/-0.5%	20	20
MEMS1P00000008	10	+/-0.5%	20	20
MEMS1P00000009	10	+/-0.5%	20	20
MEMS1P00000010	10	+/-0.5%	20	20
MEMS1P00000011	10	+/-0.5%	20	20
MEMS1P00000012	10	+/-0.5%	20	20
MEMS1P00000013	10	+/-0.5%	20	20
MEMS1P00000014	10	+/-0.5%	20	20
MEMS1P00000015	10	+/-0.5%	20	20
MEMS1P00000016	10	+/-0.5%	20	20
MEMS1P00000017	10	+/-0.5%	20	20
MEMS1P00000018	10	+/-0.5%	20	20
MEMS1P00000019	10	+/-0.5%	20	20
MEMS1P00000020	10	+/-0.5%	20	20
MEMS1P00000021	10	+/-0.5%	20	20
MEMS1P00000022	10	+/-0.5%	20	20
MEMS1P00000023	10	+/-0.5%	20	20
MEMS1P00000024	10	+/-0.5%	20	20
MEMS1P00000025	10	+/-0.5%	20	20
MEMS1P00000026	10	+/-0.5%	20	20
MEMS1P00000027	10	+/-0.5%	20	20
MEMS1P00000028	10	+/-0.5%	20	20
MEMS1P00000029	10	+/-0.5%	20	20
MEMS1P00000030	10	+/-0.5%	20	20
MEMS1P00000031	10	+/-0.5%	20	20
MEMS1P00000032	10	+/-0.5%	20	20
MEMS1P00000033	10	+/-0.5%	20	20
MEMS1P00000034	10	+/-0.5%	20	20
MEMS1P00000035	10	+/-0.5%	20	20
MEMS1P00000036	10	+/-0.5%	20	20
MEMS1P00000037	10	+/-0.5%	20	20
MEMS1P00000038	10	+/-0.5%	20	20
MEMS1P00000039	10	+/-0.5%	20	20
MEMS1P00000040	10	+/-0.5%	20	20
MEMS1P00000041	10	+/-0.5%	20	20
MEMS1P00000042	10	+/-0.5%	20	20
MEMS1P00000043	10	+/-0.5%	20	20
MEMS1P00000044	10	+/-0.5%	20	20
MEMS1P00000045	10	+/-0.5%	20	20
MEMS1P00000046	10	+/-0.5%	20	20
MEMS1P00000047	10	+/-0.5%	20	20
MEMS1P00000048	10	+/-0.5%	20	20
MEMS1P00000049	10	+/-0.5%	20	20
MEMS1P00000050	10	+/-0.5%	20	20
MEMS1P00000051	10	+/-0.5%	20	20
MEMS1P00000052	10	+/-0.5%	20	20
MEMS1P00000053	10	+/-0.5%	20	20
MEMS1P00000054	10	+/-0.5%	20	20
MEMS1P00000055	10	+/-0.5%	20	20
MEMS1P00000056	10	+/-0.5%	20	20
MEMS1P00000057	10	+/-0.5%	20	20
MEMS1P00000058	10	+/-0.5%	20	20
MEMS1P00000059	10	+/-0.5%	20	20
MEMS1P00000060	10	+/-0.5%	20	20
MEMS1P00000061	10	+/-0.5%	20	20
MEMS1P00000062	10	+/-0.5%	20	20
MEMS1P00000063	10	+/-0.5%	20	20
MEMS1P00000064	10	+/-0.5%	20	20
MEMS1P00000065	10	+/-0.5%	20	20
MEMS1P00000066	10	+/-0.5%	20	20
MEMS1P00000067	10	+/-0.5%	20	20
MEMS1P00000068	10	+/-0.5%	20	20
MEMS1P00000069	10	+/-0.5%	20	20
MEMS1P00000070	10	+/-0.5%	20	20
MEMS1P00000071	10	+/-0.5%	20	20
MEMS1P00000072	10	+/-0.5%	20	20
MEMS1P00000073	10	+/-0.5%	20	20
MEMS1P00000074	10	+/-0.5%	20	20
MEMS1P00000075	10	+/-0.5%	20	20
MEMS1P00000076	10	+/-0.5%	20	20
MEMS1P00000077	10	+/-0.5%	20	20
MEMS1P00000078	10	+/-0.5%	20	20
MEMS1P00000079	10	+/-0.5%	20	20
MEMS1P00000080	10	+/-0.5%	20	20
MEMS1P00000081	10	+/-0.5%	20	20
MEMS1P00000082	10	+/-0.5%	20	20
MEMS1P00000083	10	+/-0.5%	20	20
MEMS1P00000084	10	+/-0.5%	20	20
MEMS1P00000085	10	+/-0.5%	20	20
MEMS1P00000086	10	+/-0.5%	20	20
MEMS1P00000087	10	+/-0.5%	20	20
MEMS1P00000088	10	+/-0.5%	20	20
MEMS1P00000089	10	+/-0.5%	20	20
MEMS1P00000090	10	+/-0.5%	20	20
MEMS1P00000091	10	+/-0.5%	20	20
MEMS1P00000092	10	+/-0.5%	20	20
MEMS1P00000093	10	+/-0.5%	20	20
MEMS1P00000094	10	+/-0.5%	20	20
MEMS1P00000095	10	+/-0.5%	20	20
MEMS1P00000096	10	+/-0.5%	20	20
MEMS1P00000097	10	+/-0.5%	20	20
MEMS1P00000098	10	+/-0.5%	20	20
MEMS1P00000099	10	+/-0.5%	20	20
MEMS1P00000100	10	+/-0.5%	20	20

<https://ds.murata.co.jp/simsurfing/>

Detailed Catalogs

For more details, please refer to our printed catalogs and the PDF catalogs on our website.



- Ceramic Resonators (CERALOCK)
- Ceramic Resonator (CERALOCK) Application Manual
- Crystal Units

Cat. No. P16E
Cat. No. P17E
Cat. No. P79E

MEMS Resonator

The ultra small-sized and highly reliable resonator is realized with Murata's MEMS technology. The small size makes the resonator suitable for a variety of applications such as miniature IoT devices, wireless modules, medical devices, and industrial equipment. The resonator package is silicon based with low form factor which enables embedding with IC in over molded packages.

For Consumer/Industrial

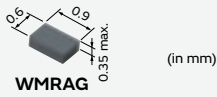

Series	Frequency (kHz)	Frequency Tolerance (ppm)	Operating Temperature Range (°C)
WMRAG	32.768	±20	-40 to 125

Crystal Units

Crystal Units utilize highly accurate frequency-based high-grade quartz crystal elements. We offer a wide lineup of Crystal Units using Murata's proven package technology for small digital devices, automotive, etc.

For Consumer/Industrial

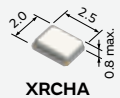
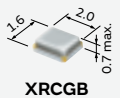

Series	Type	Seal	Frequency (MHz)	Frequency Tolerance (ppm)	Frequency Shift by Temperature (ppm max.)	Operating Temperature Range (°C)
XRCGB-F-S	HCR2016	Resin	24.0000	±8	±12	-30 to 85
XRCGB-F-P	HCR2016	Resin	26.0000 - 40.0000	±10	±10	-30 to 85
XRCGB-F-M	HCR2016	Resin	16.0000 - 32.0000	±20	±20	-30 to 85
XRCGB-F-L	HCR2016	Resin	16.0000 - 50.0000	±30	±40	-30 to 85
XRCGB-F-L	HCR2016	Resin	33.8688 - 50.0000	±45	±40	-30 to 85
XRCHA-F-L	HCR2520	Resin	16.0000 - 20.0000	±100	±50	-30 to 85
XRCHA-F-L	HCR2520	Resin	16.0000 - 20.0000	±100	±100	-30 to 85

For Automotive Applications

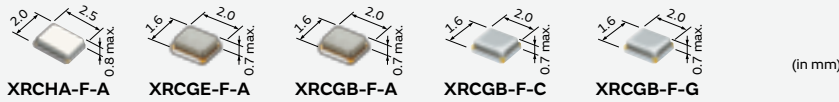

Series	Type	Seal	Frequency (MHz)							Frequency Tolerance (ppm)				Frequency Shift by Temperature (ppm max.)	Operating Temperature Range (°C)	
			0	10	20	30	40	50	60	0	20	40	60			80
XRCHA-F-A	HCR2520	Resin	16.0000		24.0000									±100	±100	-40 to 125
XRCGE-F-A	HCR2016	Resin	20.0000		23.9999									±30	±45	-40 to 125
			24.0000		27.6000									±15	±35	-40 to 125
XRCGB-F-A	HCR2016	Resin	30.0000		40.0000									±30	±45	-40 to 125
			24.0000		29.9999									±30	±35	-40 to 125
XRCGB-F-C	HCR2016	Resin	24.0000		27.6000								±20	±20	-30 to 85	
XRCGB-F-G	HCR2016	Resin	24.0000		48.0000								±30±45	±100	±50	-40 to 85

Ceramic Resonators CERALOCK

Wide product lineup of SMD and lead type versions for automotive and consumer applications.

MHz Chip Type for Automotive (Tight Frequency Tolerance)

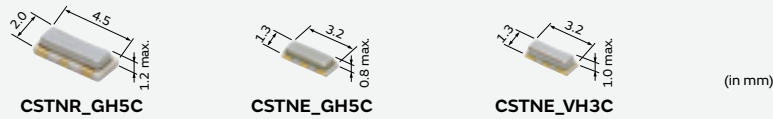

Series	Frequency (MHz)							Frequency Tolerance (%)		Frequency Shift by Temperature (% max.)	Operating Temperature Range (°C)	
	0	10	20	30	40	50	60	70	0			1
CSTNR_GH5C	4.00		7.99							±0.07	±0.13	-40 to 125
CSTNE_GH5C	8.00		13.99							±0.07	±0.13	-40 to 125
CSTNE_VH3C	14.00		20.00							±0.07	±0.13	-40 to 125

MHz Chip Type for Automotive (Standard Frequency Tolerance)

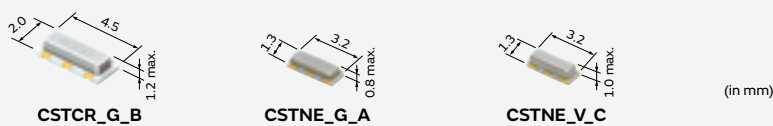

Series	Frequency (MHz)							Frequency Tolerance (%)		Frequency Shift by Temperature (% max.)	Operating Temperature Range (°C)	
	0	10	20	30	40	50	60	70	0			1
CSTCR_G_B	4.00		7.99							±0.5	±0.15	-40 to 125
CSTNE_G_A	8.00		13.99							±0.5	±0.20	-40 to 125
CSTNE_V_C	14.00		20.00							±0.5	±0.15	-40 to 125

MHz Chip Type for Consumer Electronics (Tight Frequency Tolerance)

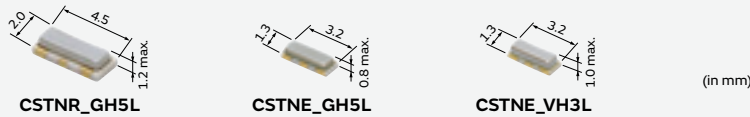

Series	Frequency (MHz)							Frequency Tolerance (%)		Frequency Shift by Temperature (% max.)	Operating Temperature Range (°C)
	0	10	20	30	40	50	60	70	0		
CSTNR_GH5L	4.00	7.99						±0.07		±0.11	-20 to 85
CSTNE_GH5L	8.00		13.99					±0.07		±0.11	-40 to 85
CSTNE_VH3L	14.00		20.00					±0.07		±0.11	-40 to 85

MHz Chip Type for Consumer Electronics (Standard Frequency Tolerance)

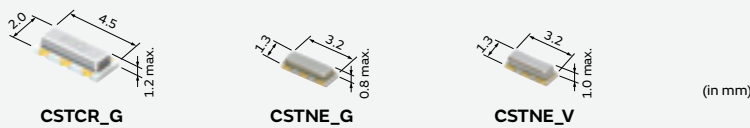

Series	Frequency (MHz)							Frequency Tolerance (%)		Frequency Shift by Temperature (% max.)	Operating Temperature Range (°C)
	0	10	20	30	40	50	60	70	0		
CSTCR_G	4.00	7.99						±0.5		±0.20	-20 to 80
CSTNE_G	8.00		13.99					±0.5		±0.20	-40 to 85
CSTNE_V	14.00		20.00					±0.5		±0.30	-40 to 85

MHz Lead Type for Consumer Electronics (Standard Frequency Tolerance)

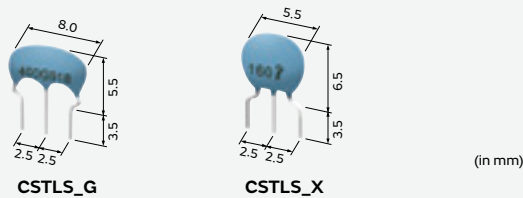

Series	Frequency (MHz)							Frequency Tolerance (%)		Frequency Shift by Temperature (% max.)	Operating Temperature Range (°C)
	0	10	20	30	40	50	60	70	0		
CSTLS_G	3.40	10.00						±0.5		±0.20 (15pF) -0.40/+0.20 (47pF)	-20 to 80
CSTLS_X	16.00		70.00					±0.5		±0.20	-20 to 80

Filters

Broad lineup of Filters for video, audio, RF/Local, Duplexers, and Filters for IF

Summary

Using Murata's ceramic processing technology and unique materials, we offer miniaturized filters with excellent properties for advanced digital audio/visual systems and communication equipment.

Lineup

- Crystal Filters
- SAW Filters for Mobile Communications
- Dielectric Filters GIGAFIL
- Chip Multilayer LC Filters

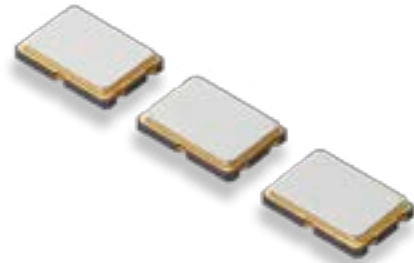

<https://www.murata.com/en-global/products/filter>

Crystal Filters

Our original wafer-thin technology has made it possible to make highly reliable filters in various applications such as radio communication worldwide.

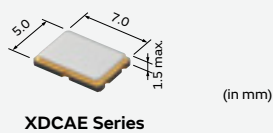
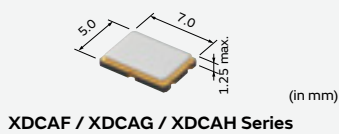

Series	Type	Frequency Range (MHz)	Number of Poles
XDCAF	TM7050F	20 to 80 [Fundamental] 70 to 150 [3rd overtone]	2
XDCAG	TM7050G		4
XDCAH	TM7050H		4
XDCAE	TM7050E		4

*Please be sure to consult with our sales representative or engineer if you require other center frequency.

SAW Filters for Mobile Communications

SAW Duplexers

Low loss, high attenuation performance, small size, highly selective pass band, chip size package



RF Filters

Low loss, high attenuation performance, small size, highly selective pass band, chip size package

Single Filter

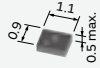

SAFFB Series

(in mm)

Dual Filter

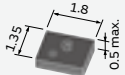

SAWEN Series

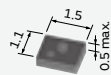

SAWFD Series

(in mm)

SAW Filters and SAW Duplexers may be used only in the following equipment:

Mobile phones, cordless telephones (except automobile telephone), smartphones, tablet PC, PC (including laptop/netPC), game machines, cameras (except for business use and for security), STB, electronic dictionaries, and digital audio instruments. Please contact us for other usages.

Dielectric Filters GIGAFIL

This is a high frequency dielectric filter for Wi-Fi routers, accespoints, for example.

It employs a unique plate construction which enables the filter to be compact and have a low profile.



DFCT Series

RF Filter	Series	Frequency Range (MHz)								Number of Resonators	Input Power Range
		100	1000	2000	3000	4000	5000	6000	7000		
	DFCT			2000					6000	2 to 6	1W*

*Power depends upon specifications.

Chip Multilayer LC Filters

Ultra-small and low-profile filters based on ceramic multilayer technology.

Band Pass Filters

LFB15 Series (0.5, 1.0, 0.4 max.)
LFB18 Series (0.8, 1.6, 0.7 max.)
LFB21 Series (1.25, 2.0, 1.05 max.)
LFB2H Series (2.0, 2.5, 1.0 max.)
LFB31 Series (1.6, 3.2, 1.3 max.)

(in mm)

Low Pass Filters

LFL15 Series (0.5, 1.0, 0.4 max.)
LFL18 Series (0.8, 1.6, 0.7 max.)
LFL21 Series (1.25, 2.0, 1.05 max.)

(in mm)

Filters

Detailed Catalogs

For more details, please refer to our printed catalogs and the PDF catalogs on our website.



- Ceramic Filters (CERAFIL)/Crystal Filters
- Ceramic Filters (CERAFIL) Application Manual

Cat. No. P51E
Cat. No. P11E

RF Components

Broad lineup of RF Components for RF/Local circuits in communications equipment

Summary

To enhance the technical advantages of communication equipment, Murata offers miniaturized, sophisticated components to meet the demands of many applications.

Lineup

- Antennas
- Baluns (Chip Multilayer and Wire Wound/Film type)
- Couplers (Chip Multilayer) ●Chip Multilayer Hybrid Dividers
- Chip Multilayer Diplexers
- Microwave Connectors



Antennas

Antenna Coils

Rx 3D-ANT

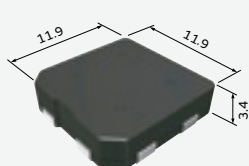

SA3D12 Series

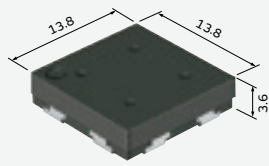

SA3D14 Series

(in mm)

Series		Inductance (mH)	Q (Reference)
SA3D12	X	1.0 to 6.3	20
	Y	1.0 to 6.3	20
	Z	1.0 to 9.0	20
SA3D14	X	1.0 to 6.3	20
	Y	1.0 to 6.3	20
	Z	1.0 to 9.0	20

Baluns

SMD baluns constructed with a copper conductor and ceramic material. Ideal for high-frequency applications. Small-size and low-loss baluns can be customized for balance impedance of 50Ω to 200Ω.

Chip Multilayer Type

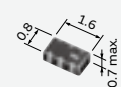

LDB18 Series

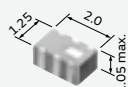

LDB21 Series

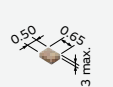

LDM0Q Series

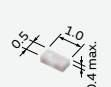

LDM15 Series



LDM18 Series

(in mm)

Film Type

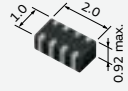

DXP2AB Series

(in mm)

Wire Wound Type

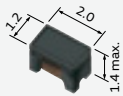

DXW21B Series

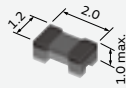

DXW21H Series

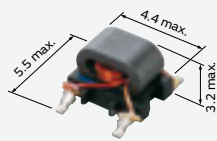

B4F Series

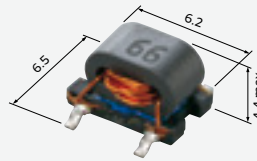

B5F Series

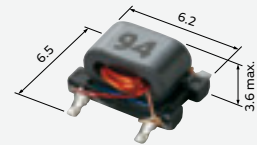

B5FL Series

(in mm)

Couplers

An ultra-small, low-profile directional coupler based on ceramic multilayer technology. This coupler achieves ultra-small size, low insertion loss, and high isolation.

Chip Multilayer Type

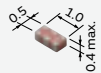

LDC15 Series
LDJ15 Series

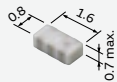

LDC18 Series
LDJ18 Series

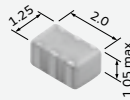

LDC21 Series
LDJ21 Series

(in mm)

*It is available with Integrated LPF for LDC21 Series.

Chip Multilayer Hybrid Dividers

Power divider with a multilayer low pass filter in an ultra-compact package.

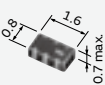

LDD18 Series

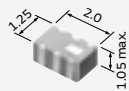

LDD21 Series

(in mm)

Chip Multilayer Diplexers

A diplexer branching low and high band.
Suitable for band-switching for dual-band system.

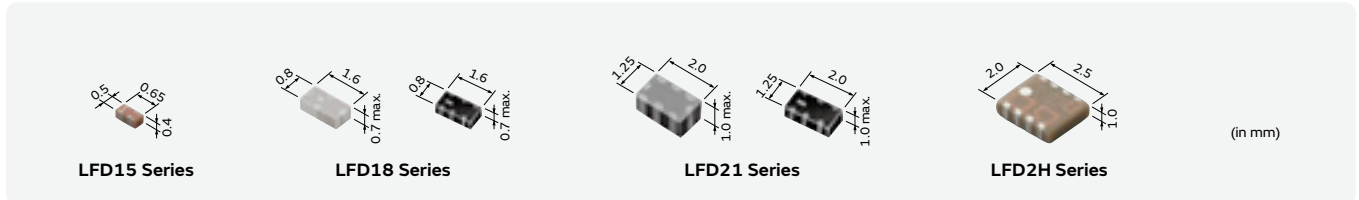

Microwave Connectors

Microwave Coaxial Connectors with Switch

The coaxial connector with switch is very useful for the measurement of characteristics in communication devices such as mobile terminals and microwave circuits.

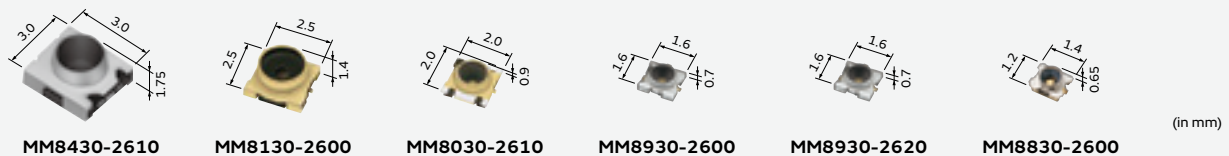

Type	Receptacle Part Number	Frequency Rating (GHz)	Voltage Standing Wave Ratio	Standard Measurement Probe Part Number
SWD	MM8430-2610	up to 6	1.2 max. (DC to 3GHz) 1.3 max. (3GHz to 6GHz)	MM126320 MXHS83QE3000
SWF	MM8130-2600	up to 6	1.2 max. (DC to 3GHz) 1.3 max. (3GHz to 6GHz)	
SWG	MM8030-2610	up to 11	1.2 max. (DC to 3GHz) 1.3 max. (3GHz to 6GHz) 1.5 max. (6GHz to 11GHz)	MM126330 MXHQ87WJ3000
SWH	MM8930-2600	up to 12	1.1 max.(DC to 3GHz) 1.2 max.(3GHz to 6GHz) 1.3 max. (6GHz to 9GHz) 1.6 max. (9GHz to 12GHz)	MM126515 MXHQ87PA3000
SWH-2Way	MM8930-2620	up to 12	1.2 max.(DC to 3GHz) 1.2 max.(3GHz to 6GHz) 1.4 max. (6GHz to 9GHz) 1.6 max. (9GHz to 12GHz)	RF: MM126526 ANT: MM126517 RF: MXHQ87PN3000 ANT: MXHQ87PP3000
SWJ	MM8830-2600	up to 9	1.2 max. (DC to 8GHz) 1.3 max. (8GHz to 9GHz)	MXFQB1PY1000 MXHQ87PK3000

Nominal Impedance: 50Ω ; Rated Voltage: 30Vrms ; Temperature Range: -40 to 85°C

Microwave Multi Line Connectors

Multi line connectors transmit signals from board to board. The connectors can transmit not only digital signals but also RF signals.

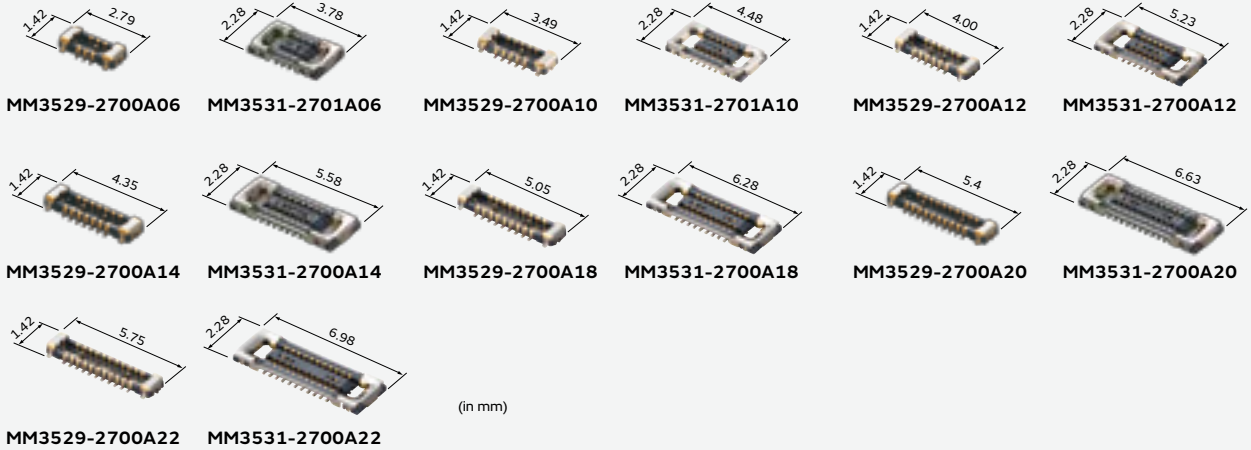

Type	Receptacle Part Number	Plug Receptacle Part Number	Mating Height (mm)	Pitch (mm)	Frequency Rating (GHz)	Voltage Standing Wave Ratio
MLF06	MM3529-2700A06	MM3531-2701A06	0.6 typ	0.35 typ	up to 20	1.2 max. (DC to 3GHz)
MLF10	MM3529-2700A10	MM3531-2701A10				1.2 max. (3GHz to 6GHz)
MLF12	MM3529-2700A12	MM3531-2700A12				1.3 max. (6GHz to 9GHz)
MLF14	MM3529-2700A14	MM3531-2700A14				1.3 max. (9GHz to 12GHz)
MLF18	MM3529-2700A18	MM3531-2700A18				1.35 max. (12GHz to 15GHz)
MLF20	MM3529-2700A20	MM3531-2700A20				1.5 max. (15GHz to 18GHz)
MLF22	MM3529-2700A22	MM3531-2700A22				1.65 max. (18GHz to 20GHz)

Nominal Impedance: 50Ω ; Rated Voltage: 30Vrms ; Temperature Range: -40 to 85°C

Detailed Catalogs

For more details, please refer to our printed catalog and the PDF catalog on our website.



• Microwave Connectors

Cat. No. O30E

Sensors

Summary

Murata pursued sensing functions making full use of MEMS and processing technology, and magnetoresistive elements including ceramic material technology in order to develop highly efficient and highly reliable devices, modules, and systems.

A lineup of various sensors respond to the sensing needs of various applications for automobile, wearable, medical care, and health care.

Lineup

- Infrared Sensors ● Ultrasonic Sensors
- AMR Sensors (Magnetic Sensors) ● TMR Sensors (Magnetic Sensors)
- Accelerometers ● Inclinometers ● Gyro Sensors
- Temperature Sensors (Thermistors)



<https://www.murata.com/en-global/products/sensor>

Sensor Guide (Select by Method/Principle)



Temperature

Thermistors: The resistance changes with the temperature.



Infrared

Pyroelectric infrared sensors: The sensor reacts to the infrared radiation emitted from the human body to output an electric charge.



IRA Series

For more details on Thermistors, please refer to p. 80

Detailed Catalogs

For more details, please refer to our printed catalogs and the PDF catalogs on our website.



- MEMS Sensors & Sensing Elements
- NTC Thermistors
- POSISTOR for Circuit Protection
- NTC/PTC Thermistors for Automotive

- Cat. No. S47E
- Cat. No. R44E
- Cat. No. R90E
- Cat. No. R03E



Distance

Ultrasonic sensors: The sensor sends and receives ultrasonic waves in order to detect distances from the state of the reflected wave.



MA300D1-1
(for Dual Use)



MA40S4R (for Receiver)
MA40S4S (for Transmitter)



MA58MF14-7N
(for Dual Use)



MA40H1S-R
(for Dual Use)



Magnetic/ Open and Shut

Magnetic switches: This switch switches built-in ICs when the magneto-resistive element detects the magnetic proximity.



MR Series

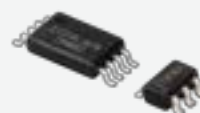

CT Series



Inertial force

Accelerometers: This sensor detects the acceleration from the change of the capacitance that occurs in the 3DMEMS element.



SCA Series

Inclinometers: This sensor detects the gravitational acceleration of the Earth to calculate the angle of gradient.













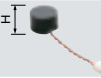

SCA Series
SCL Series

Gyro sensors: This sensor detects the angular velocity from the change in the capacitance that occurs in the 3DMEMS element.



SCC Series
SCR Series

Lineup

Detection	Murata's Sensors			Applications											
	Products	Series or Main Part Number	Dimensions (mm)	AV Equipment					Communications Devices						
				TV	Audio	DVD, CD	Digital Video Camera	Digital Camera	PC	Scanner	Multifunction Machine	Printer	FAX	Electronic Bulletin Board	
Infrared	Pyroelectric Infrared Sensors	IRA Series	 $\varnothing 9.2$ H4.7	●	●	●			●	●	●	●	●	●	
Ultrasonic	Open Structure Type Ultrasonic Sensors	MA40S4R (for Receiver) MA40S4S (for Transmitter)	 $\varnothing 9.9$ H7.1												●
		MA40H1S-R (SMD/for Dual Use)	 5.2X5.2X1.15	●					●		●				
	Drip-proof Type Ultrasonic Sensors	MA58MF14-7N (for Dual Use)	 $\varnothing 14.0$ H9.0												
	High Frequency Type Ultrasonic Sensors	MA300D1-1 (for Dual Use)	 $\varnothing 9.9$ H7.3							●	●	●			
Magnetic	AMR Sensors (Magnetic Sensors)	MR Series	 MRMS201A-001: 2.8X2.9X1.1 MRMS501A-001: 1.45X1.45X0.55			●	●	●	●						
	TMR Sensors (Magnetic Sensors)	CT Series	 CT100: 1.5X1.5X0.45 CT310: 2.0X2.0X0.45												
Acceleration	Accelerometers	SCA Series	 7.6X8.6X3.3												
	Inclinometers	SCA Series SCL Series	 7.6X8.6X3.3									●			
Angle Velocity	Gyro Sensors	SCC Series SCR Series	 12.1X15.0X4.35												
Temperature	NTC Thermistors	Chip Type NC_ Series	 NCP02: 0.4X0.2X0.2 NCP03: 0.6X0.3X0.3 NC_15: 1.0X0.5X0.5 NC_18: 1.6X0.8X0.8	●	●	●	●	●	●	●	●	●	●	●	●
		Lead Type NX Series	 NXF: $\varnothing 1.2$ L25 to 150 NXR: $\varnothing 4.0$ L10 to 40	●	●	●	●	●	●	●	●	●	●	●	●
	PTC Thermistors POSISTOR	Chip Type PR_ Series	 PRF15: 1.0X0.5X0.5 PRF18: 1.6X0.8X0.8 PRF21: 2.0X1.25X0.9	●	●	●	●	●	●	●	●	●	●	●	●

		Applications																				Wearable									
		Home Electronics										Security			Car Electronics			Toy		Others											
		Refrigerator	Electric Rice-cooker	Air Conditioner	Air Purification System	Humidifier	Cleaner	Laundry Machine	Food Fan	Water Heater	Toilet Seats with a Warm-water Shower Feature	Lighting	Security Camera	Security Light	Indoor Security Sensor	Intrusion Detection Sensor	Navigation System	Climate Control	Parking Assist	Radio Control (Attitude Control)	Game Controller	Machine Tool	ATM, CD	Vending Machine	Amusement Machine	Construction Machinery	Farm Machinery	Railroad Equipment	Motor	Murata's Sensors	Products
		●	●	●	●						●	●	●	●	●								●	●	●					Pyroelectric Infrared Sensors	
		●		●		●					●	●	●	●	●								●	●	●					Open Structure Type Ultrasonic Sensors	
		●		●		●					●	●	●	●	●								●	●	●					High Frequency Type Ultrasonic Sensors	
																			●											Drip-proof Type Ultrasonic Sensors	
																							●							High Frequency Type Ultrasonic Sensors	
		●	●	●	●	●	●	●	●	●	●				●							●	●	●	●					AMR Sensors (Magnetic Sensors)	
																											●			TMR Sensors (Magnetic Sensors)	
																						●		●	●	●				Accelerometers	
																						●			●	●				Inclinometers	
																	●					●		●	●	●				Gyro Sensors	
			●	●	●	●	●	●	●	●	●						●	●	●	●	●	●	●		●					NTC Thermistors	
		●	●	●	●	●	●	●	●	●	●	●	●	●	●	●	●	●	●	●	●	●	●	●	●	●				NTC Thermistors	
		●	●	●	●	●	●	●	●	●	●						●	●	●		●			●						PTC Thermistors POSISTOR	

Thermistors

Facilitate your designs and products utilizing our thermal design and thermistor products.

Summary

Murata's semi-conductive ceramics and electrode printing technologies, such as PTC and NTC Thermistors, provide vital protection and sensing within electronic equipment. Simulation software tools are also available for your convenience.

Lineup

- NTC Thermistors for temperature sensor/compensation, and automotive
- PTC Thermistors POSISTOR for overheat sensing, overcurrent protection, and automotive

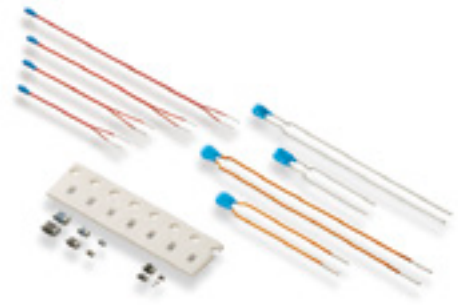

<https://www.murata.com/en-global/products/thermistor>

NTC Thermistors for Temperature Sensor/ Temperature Compensation

Chip Type

Chip NTC Thermistors have Ni barrier terminations, provide excellent solderability, and offer high stability in harsh environments due to their unique inner construction.



Series	Size Code inch (mm)	Resistance (25°C) (Ω)	B-Constant (25-50°C) (K)	Maximum Operating Current for Sensor (25°C) (mA)	Maximum Voltage (V)	Typical Dissipation Constant (25°C) (mW/°C)	Operating Temperature Range (°C)
NCP02	01005 (0402)	10k to 470k	3380 to 4250	0.015 to 0.100	5	1	-40 to 125
NCP03	0201 (0603)	1.0k to 470k	3380 to 4485	0.015 to 0.316	5	1	-40 to 125
NCP15	0402 (1005)	220 to 470k	3380 to 4500	0.015 to 0.674	5	1	-40 to 125
NCU15	0402 (1005)	10k to 470k	3380 to 4500	0.032 to 0.100	5	1	-40 to 125
NCP18	0603 (1608)	220 to 470k	3380 to 4500	0.015 to 0.674	5	1	-40 to 125
NCU18	0605 (1608)	10k to 470k	3380 to 4500	0.015 to 0.100	5	1	-40 to 125

Maximum Operating Current for Sensor raises the Thermistor's temperature by 0.1°C.
There are also items for automotive applications in the NCP/NCU Series.

Detailed Catalogs

For more details, please refer to our printed catalogs and the PDF catalogs on our website.

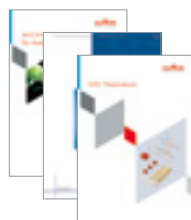

- NTC Thermistors Cat. No. R44E
- POSISTOR for Circuit Protection Cat. No. R90E
- NTC/PTC Thermistors for Automotive Cat. No. R03E

Thermo String Type

Small flexible lead type NTC Thermistors with a small head and a thin lead wire.

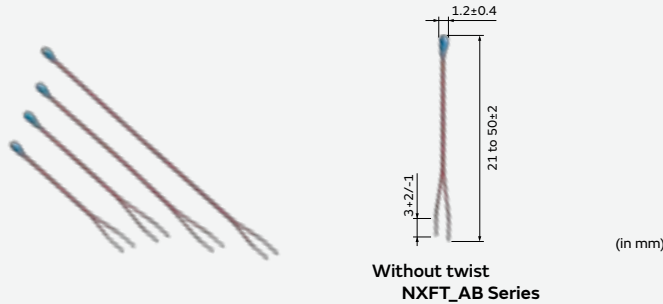

Series	Resistance (25°C) (Ω)	B-Constant (25-50°C) (K)	Maximum Operating Current for Sensor (25°C) (mA)	Thermal Time Constant (25°C) (s)	Full Length (mm)	Operating Temperature Range (°C)
NXFT15_AB_ (Nickel Cooper wire type)	3k to 100k	3380 to 4250	0.024 to 0.14	3	21 to 50	-40 to 125

Maximum Operating Current for Sensor raises the Thermistor's temperature by 0.1°C.
There are also items for automotive applications in the NXF Series.

Lead Type

This product is a thermistor for normal temperature level sensors having self-subsistence due to strong lead strength based on chip NTC.

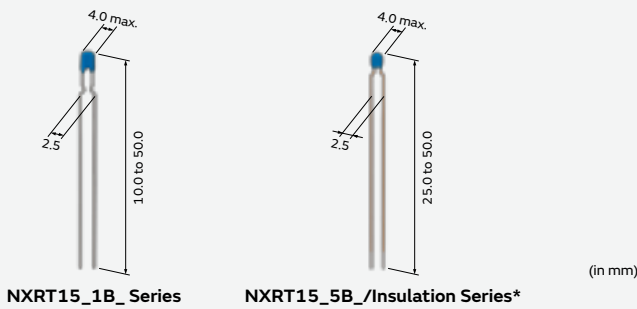

Series	Resistance (25°C) (Ω)	B-Constant (25-50°C) (K)	Maximum Operating Current for Sensor (25°C) (mA)	Thermal Time Constant (25°C) (s)	Full Length (mm)	Operating Temperature Range (°C)
NXRT15_1B_	2k to 100k	3380 to 4250	0.04 to 0.27	4	10 to 50	-40 to 125
NXRT15_5B_ (Insulation*)	2k to 100k	3380 to 4250	0.05 to 0.36	4	25 to 50	-40 to 125

Maximum Operating Current for Sensor raises the Thermistor's temperature by 0.1°C.
There are also items for automotive applications in the NXR Series.

*Insulation: Lead wire insulation type.

PTC Thermistors POSISTOR for Overheat Sensing

Chip Type

For overheat sensing for power transistors, power diodes, and power ICs in hybrid circuits.



Series	Sensing Temperature Range (°C)										Sensing Temperature Tolerance (°C)	Maximum Voltage (V)	Size Code inch (mm)
	60	70	80	90	100	110	120	130	140	150			
PRF15	●	●	●	●	●	●	●	●	●	●	±3/±5	32	0402 (1005)
PRF18	●	●	●	●	●	●	●	●	●	●	±3/±5	32	0603 (1608)
PRF21			●	●	●	●	●	●	●	●	±5	32	0805 (2012)

There are also items for automotive applications in the PRF Series.

PTC Thermistors POSISTOR for Overcurrent Protection

Chip Type

Overcurrent Protection device with resettable function suitable for current-limiting resistors.



Series	Maximum Voltage (V)	Hold Current (60°C) (mA)	Trip Current (-20°C) (mA)	Maximum Current (mA)	Resistance (Ω)	Size Code inch (mm)
PRG03	13	8	46	93	180	0201 (0603)

Series	Maximum Voltage (V)	Hold Current (60°C) (mA)	Trip Current (-10°C) (mA)	Maximum Current (A)	Resistance (25°C) (Ω)	Size Code inch (mm)
PRG15	6 to 30	17 to 88	65 to 318	0.6 to 3.5	2.2 to 68	0402 (1005)
PRG18	6 to 30	7 to 220	25 to 850	0.06 to 7.5	1.0 to 470	0603 (1608)
PRG21	6 to 32	30 to 500	110 to 2000	0.59 to 37	0.2 to 42	0805 (2012)

Maximum Current shows typical transformer capacities that can be used. There are also items for automotive applications in the PRG Series.

Power Devices

Eco-friendly and high-quality power devices

Summary

To meet consumer needs Murata offers power supply products and energy devices that can be used with a variety of equipment, such as video equipment, household information appliances, and communication/transfer equipment. Murata provides standard and customized products using highly reliable. Murata makes components utilizing advanced design and high-density packaging technology.

Lineup

- DC-DC Converters
- Ballast Power Supplies
- Power supplies for LED lighting



<https://www.murata.com/en-global/products/power>

DC-DC Converters

DC-DC converters are vital to the demands of electronic equipment.

Murata offers DC-DC converters that set the standard for miniaturization, low-profile, high-efficiency, power-saving and low-noise power supplies. Murata also provides standard products and customized products, ultra-low-profile products, and products for FPGAs.

Non-isolated Type



MYMGK00504ERSR
MYMGK1R804ERSR



MYMGK00506ERSR
MYMGK1R806FRSR

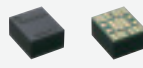

MYMGK1R820ERSR
MYMGK1R820FRSR



MYSYGK1R830FRSR
MYSYGK4R030ERSR



MYLSM00502ERPL



MYSYGK02506BRSR



MYMGA5R04RELA5RA

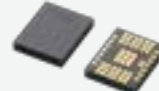

MYMGC series



OKL-T/20 series
OKL2-T/20 series



OKL-T/12 series
OKL2-T/12 series



OKL-T/3 series
OKL2-T/3 series



OKL-T/6 series
OKL2-T/6 series



MYSSM02406BEPL



MYUSP3R303FMP



MYMGM1R816ELA5RA
MYMGM1R824ELA5RA

Part number	Output Current (A)	Input Voltage (V)	Output Voltage (V)	Efficiency (%)	I2C or PMBus	Package	Size (mm)		
							W	L	T
MYLSM00502ERPL	2.5	4.5 to 17	1 to 5.25	88	Not available	SMD	7.9	7.9	2.3
MYMGK1R804FRSR	4	4.5 to 8	0.7 to 1.8	93	Not available	SMD	7.5	9.0	5.0
MYMGK00504ERSR	4	8 to 15	0.7 to 5	96.1	Not available	SMD	7.5	9.0	5.0
MYMGK1R806FRSR	6	4.5 to 8	0.7 to 1.8	90.4	Not available	SMD	7.5	9.0	5.0
MYMGK00506ERSR	6	8 to 15	0.7 to 5	95.4	Not available	SMD	7.5	9.0	5.0
MYMGK1R812FRSR	12	4.5 to 8	0.7 to 1.8	92	Not available	SMD	9.0	10.5	5.6
MYMGK1R812ERSR	12	8 to 15	0.7 to 1.8	90.4	Not available	SMD	9.0	10.5	5.6
MYMGM1R816ELA5RA	16	7.5 to 15	0.7 to 1.8	91.8	PMBus	SMD	9.0	10.5	5.0

These are just a few examples of our large assortment of power products.

Continued on the following page. ↗

DC-DC Converters

Part number	Output Current (A)	Input Voltage (V)	Output Voltage (V)	Efficiency (%)	I2C or PMBus	Package	Size (mm)		
							W	L	T
MYMGK1R820FRSR	20	4.5 to 8	0.7 to 1.8	89.2	Not available	SMD	9.0	10.5	5.6
MYMGK1R820ERSR	20	8 to 15	0.7 to 1.8	87.8	Not available	SMD	9.0	10.5	5.6
MYMG1R824ELA5RA	24	7.5 to 15	0.7 to 1.8	89.2	PMBus	SMD	9.0	10.5	5.0
MYSYGK1R830FRSR	30	4.5 to 15	0.7 to 1.8	89.7	Not available	SMD	14.0	11.0	8.3
MYSYGK4R030ERSR	30	4.5 to 15	0.7 to 4	94.4	Not available	SMD	14.0	11.0	8.3
MYSYGK02506BRSR	6	13.5 to 42	5 to 25	98	Not available	SMD	14.7	16.3	7.5
MYMGA5R04RELA5RA	4	8.0 to 16.0	3.3 to 5	94	Not available	SMD	9.0	10.5	5.5
MYMGC0R88RFLF2RV	8	3.3 to 5.5	0.85	81	I2C	SMD	11.9	15.0	2.4
MYMGC1R83BFPF2RV (Quad output)	3.2 0.5 0.5 1.5 2.5	3.3 to 5.5	0.85 0.85 1.2 1.8 1.2	81	I2C	SMD	11.9	15.0	2.4
MYMGC3R32EFPF2RV (Quad output)	1 2 1.5	4.3 to 5.5	1.8 3.3 2.5	91	I2C	SMD	11.9	15.0	2.4
OKL-T/3-W12	3	4.5 to 14	0.591 to 5.5	93	Not available	SMD	12.2	12.2	6.2
OKL-T/6-W12	6	4.5 to 14	0.591 to 5.5	93	Not available	SMD	12.2	12.2	7.2
OKL2-T/12-W12	12	4.5 to 14	0.69 to 5.5	95	Not available	SMD	20.32	11.43	8.55
OKL2-T/20-W12	20	4.5 to 14	0.69 to 5.5	94	Not available	SMD	33.02	13.46	8.7
MYSSM01206BEPL	6	17 to 40	5 to 12	95	Not available	SMD	30.2	20.9	8.3
MYSSM02406BEPL	6	30.5 to 40	12 to 24	98	Not available	SMD	30.2	20.9	8.3
MYSDM1R512EENL (Dual output)	13 1.2	10.2 to 15.8	0.9 to 1.25 0.9 to 1.5	81	Not available	SMD	30.2	20.9	7.0
MYSTM3R32EEEPL (Triple output)	1.5 1.5 2.5	10.2 to 15.8	1.8 1.23 to 1.8 3.3	84	Not available	SMD	30.2	20.9	7.0
MYUSP3R303FMP	3	3 to 5.5	0.7 to 3.3	94	Not available	SMD	11.0	8.5	5.6

These are just a few examples of our large assortment of power products.

Isolated DC-DC Converter for PoE



MYBSP0055AABFT
MYBSP0122BABFT



MYBSP0055AABF
MYBSP0122BABF



MYBSP00502ABF
MYBSP01201ABF



MYBTA00512ABT



MYBSC0128CAZT



MYBSS054R6EBF

Part number	Output Power (W)	Input Voltage (V)	Output Voltage (V)	Efficiency (%)	PoE controller	Package	Size (mm)		
							W	L	T
MYBSP00502ABF	10	37 to 57	5	80	Available	SMD	26.0	14.8	6.2
MYBSP01201ABF	12	37 to 57	12	84	Available	SMD	26.0	14.8	6.2
MYBSP0055AABF	25.5	42.5 to 57	5	90.5	Available	SMD	35.5	22.4	10.55
MYBSP0122BABF	25.5	42.5 to 57	12	92.5	Available	SMD	35.5	22.4	10.55
MYBSP0055AABFT	25.5	37 to 57	5	90.5	Available	SMD	35.5	22.4	10.55
MYBSP0122BABFT	25.5	37 to 57	12	92.5	Available	SMD	35.5	22.4	10.55

Continued on the following page. ↗

DC-DC Converters, Ballast Power Supplies, Power supplies for LED lighting

Part number	Output Power (W)	Input Voltage (V)	Output Voltage (V)	Efficiency (%)	PoE controller	Package	Size (mm)		
							W	L	T
MYBTA00512ABT	60	36 to 75	5	92	Not available	SMD	23.36	19.05	12.7
MYBSC0128CAZT	100	36 to 75	12	92.5	Not available	Insert	33.0	23.2	9.32
MYBSS054R6EBF	30	10.8 to 27	54	90	Not available	SMD	35.5	22.4	8.9

Isolated Type

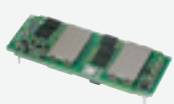

MYBEA01212AZT



MYBEA01212AZTB
MYBEA01210CZTB



MYBEA01210CZT



MYBEB01212AZTB



MYBSC0128CAZT



MYBTA00512ABT

Part number	Output Power (W)	Input Voltage (V)	Output Voltage (V)	Efficiency (%)	Footprint (Brick)	Package	Size (mm)		
							W	L	T
MYBEA01212AZT	140	36 to 75	12	92.5	1/8	Insert	58.4	22.8	8.46
MYBEA01212AZTB	140	36 to 75	12	92.5	1/8	Insert	58.4	22.8	11.3
MYBEA01210CZT	120	18 to 36	12	93	1/8	Insert	58.4	22.8	8.46
MYBEA01210CZTB	120	18 to 36	12	93	1/8	Insert	58.4	22.8	11.3
MYBEB01212AZTB	100	36 to 75	12	91.5	1/8	Insert	58	22.8	12.2
MYBTA00512ABT	60	36 to 75	5	92	1/32	SMD	23.36	19.05	12.7
MYBSC0128CAZT	100	36 to 75	12	92.5	1/16	Insert	33.0	23.2	9.32

These are just a few examples of our large assortment of power products.

Ballast Power Supplies

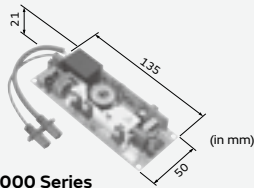

MPL3000 Series

Series	Applications	Input Voltage V_{in}	Output Power	Other Specification
MPL3000	Projector	320 to 420V DC	550W	For extra-high pressure mercury lamp

For more details on our products, please contact us.

Power supplies for LED lighting



LED Lighting

Type	Input Voltage	Output Voltage	Output Current (Max)	Number of Outputs	Safety Standard	Dimming
MPA1948	90 to 267V AC	30 to 50V	300 to 720mA	1ch	PSE, EN61347-1, EN61347-2-13	DALI, PWM
MPA1954	90 to 267V AC	30 to 56V	270 to 600mA	1ch	PSE, EN61347-1, EN61347-2-13	-
MPA1960	90 to 267V AC	30 to 60V	1000 to 1400mA	1ch	PSE	DALI, PWM
MPA1968	90 to 267V AC	30 to 50V	750 to 1050mA	1ch	PSE	DALI, PWM
MPL0039	45.6 to 50.4V DC	8 to 40V	450 to 900mA	2ch	-	Radio control
MPL0076DD	90 to 267V AC	10 to 50V	350 to 720mA	1ch	PSE	DALI

For more details on our products, please contact us.

For Ionizer Modules, please refer to p. 102.

Batteries

Battery solutions for energy storage systems and various small devices

Summary

Murata offers battery solutions for a wide range of applications from IoT & wearable devices to energy storage systems for enterprise and household use.

Lineup

- Laminated Type Lithium Ion Secondary Batteries
- Cylindrical Type Lithium Ion Secondary Batteries
- Small Lithium ion secondary batteries
- FORTELION 24V Battery Module
- FORTELION Battery System ● Micro Batteries



Laminated Type Lithium Ion Secondary Batteries

Laminated type lithium ion secondary battery has laminate film for packaging. These batteries are known for their excellent safety, thinner form factors, and size flexibility.



Standard Long Life

Model Name	Nominal Voltage (V)	Minimum Capacity (mAh)	Thickness (mm)	Width (mm)	Height (mm)	Weight (g)	Charging Voltage (V)	Chemical System (LCO, NCM, NCA)
US253450A10S	3.7	425	2.53	34	50.5	8.7	4.2	LCO
US373651A10S	3.7	765	3.63	36	51.2	14.2	4.2	LCO
US394549A10S	3.7	1,045	3.87	44.1	48.2	18.9	4.2	LCO
US634038A10S	3.7	1,110	6.3	39.32	37.85	19.6	4.2	LCO
US354775A10S	3.7	1,420	3.5	47	75	27	4.2	LCO
US454261A8TS	3.7	1,530	4.6	42	61.5	26.8	4.2	LCO
US525354A10S	3.7	1,830	5.25	53.15	54.3	33.8	4.2	LCO
US505456A10S	3.7	1,880	5.05	53.5	56.4	34.5	4.2	LCO
US374981K6S	3.7	1,950	3.65	49	81	33.9	4.2	LCO
US673864K6S	3.7	2,010	6.65	38	64	36.5	4.2	LCO
US2764A0K6S	3.7	2,040	2.65	64.1	99.5	37.9	4.2	LCO
US595676K5S	3.7	3,020	5.85	55.9	75.5	55.5	4.2	LCO
US486588K5S	3.7	3,360	4.8	65	88	62	4.2	LCO
US616484K6S	3.7	4,040	6.1	64	84	74.4	4.2	LCO
US31A0B8A10S	3.7	4,750	3.03	99.5	118	91.5	4.2	LCO
US666588K6S	3.7	4,800	6.55	65	88	88.4	4.2	LCO

Continued on the following page. ↗

High Voltage High Capacity

Model Name	Nominal Voltage (V)	Minimum Capacity (mAh)	Thickness (mm)	Width (mm)	Height (mm)	Weight (g)	Charging Voltage (V)	Chemical System (LCO, NCM, NCA)
US476483BH9	3.83	4,010	4.63	63.9	82.45	58.3	4.4	LCO
US426487CH9P	3.85	3,920	4.12	63.48	86.2	51.9	4.43	LCO
US525775CH9P	3.85	3,720	5.1	56.53	74.3	48.5	4.43	LCO
US2980F9H2	3.8	4,670	2.81	79.8	159	87	4.35	LCO
US275361H5	3.8	1,040	2.65	53	60.5	18.1	4.35	LCO
US4032B3BH5	3.8	1,900	3.92	31.9	113	33	4.35	LCO
US325991H5	3.8	2,410	3.18	58.7	90.5	40.4	4.35	LCO
US456067H5	3.8	2,590	4.45	59.73	66.92	42.8	4.35	LCO
US395189BH7	3.8	2,630	3.83	50.78	88.45	40.9	4.35	LCO
US414499BH7	3.8	2,630	4.02	43.08	98.95	41	4.35	LCO
US415085BH7	3.8	2,690	4.1	49.78	84.64	41.7	4.35	LCO
US455676H5	3.8	2,710	4.41	55.3	76	43.4	4.35	LCO
US395292H5	3.8	2,790	3.89	52	91.5	43.8	4.35	LCO
US515569H5	3.8	2,790	5.09	54.16	68.7	44.4	4.35	LCO
US495473BH7	3.8	2,980	4.9	53.78	72.6	46.9	4.35	LCO
US445977H5	3.8	3,000	4.31	58.3	76.8	46.9	4.35	LCO
US416775H5	3.8	3,010	4.08	66.5	74.2	48.5	4.35	LCO
US436177H5	3.8	3,020	4.21	60.9	76.7	46.3	4.35	LCO
US525077BH7P	3.8	3,120	5.17	49.28	76.45	48	4.35	LCO
US396479H5	3.8	3,050	3.9	63	78.7	46.7	4.35	LCO
US504588H5	3.8	3,050	4.91	43.8	88	46.1	4.35	LCO
US366685BH7	3.8	3,090	3.57	65.2	84.9	47.2	4.35	LCO
US495577BH7	3.8	3,130	4.81	54.78	76.35	49.1	4.35	LCO
US446770H7	3.8	3,170	4.4	66.55	69.1	52.8	4.35	LCO
US396283BH7	3.8	3,160	3.84	61.8	82.8	47.2	4.35	LCO
US416189H2	3.8	3,200	4.12	60.9	89	52.4	4.35	LCO
US269099H5	3.8	3,310	2.57	89.9	99	55.3	4.35	LCO
US526367BH7	3.8	3,325	5.17	62.68	66.65	55.4	4.35	LCO
US496178H5	3.8	3,400	4.83	60.9	77.85	55.6	4.35	LCO
US386587BH7	3.8	3,485	3.75	64.95	86.96	51.5	4.35	LCO
US289490BH7	3.8	3,510	2.8	94	90	56.2	4.35	LCO
US456386H5	3.8	3,540	4.5	62.2	85.02	61	4.35	LCO
US485490H5K	3.8	3,570	4.8	54	90	56.4	4.35	LCO
US406787BH7	3.8	3,720	3.98	66.4	86.5	55	4.35	LCO
US446484BH7	3.8	3,720	4.32	63.6	83.4	56.7	4.35	LCO
US486588H3K	3.8	3,760	4.8	65	88	63	4.35	LCO
US508168H5K	3.8	4,110	5	81	67.6	66.9	4.35	LCO
US3978A4H5K	3.8	4,720	3.9	77.4	103.5	78	4.35	LCO
US25A2F2H3	3.8	5,180	2.5	102.15	151.8	86.2	4.35	LCO

Continued on the following page. ↗

Laminated Type Lithium Ion Secondary Batteries

Small Cell Wearable



Model Name	Nominal Voltage (V)	Minimum Capacity (mAh)	Thickness (mm)	Width (mm)	Height (mm)	Weight (g)	Charging Voltage (V)	Chemical System (LCO, NCM, NCA)
US491222A10S	3.7	81	4.9	11.8	22	2.1	4.2	LCO
US80285A10S	3.7	121	7.63	7.93	28.5	2.6	4.2	LCO
US501424A10S	3.7	126	5.05	13.8	24	3	4.2	LCO
US321741A10S	3.7	180	3.2	16.5	40.5	4.2	4.2	LCO
US302135H5	3.8	215	3	20.2	35	4.2	4.35	LCO
US322830A10S	3.7	235	3.22	28	30	5	4.2	LCO
US552131A10S	3.7	320	5.5	21.11	30.75	6.5	4.2	LCO
US97500A10S	3.7	392	9.6	9.9	50	7.8	4.2	LCO

Camera & Game

Model Name	Nominal Voltage (V)	Minimum Capacity (mAh)	Thickness (mm)	Width (mm)	Height (mm)	Weight (g)	Charging Voltage (V)	Chemical System (LCO, NCM, NCA)
US773038A12	3.7	1,030	7.62	29.3	37.7	17.5	4.2	LCO
US533144N2S	3.6	880	5.3	30.2	43.9	14.7	4.2	NCA
US783038E1S	3.65	960	7.77	29.4	37.35	17	4.2	NCM
US613143N2Y	3.6	1,080	6.1	30.9	43	17.9	4.2	NCA
US523350N2Y	3.6	1,185	5.2	33	50	19.6	4.2	NCA

Cylindrical Type Lithium Ion Secondary Batteries

Cylindrical type lithium ion batteries are packaged in metal cans. These batteries can be used at high rate and maintain high capacity.

Model	Nominal Capacity (mAh)	Positive Electrode Material	Negative Electrode Material	Nominal (Rated) Voltage (V)	Weight (g)	Diameter (mm)	Height (mm)	Continuous Max Discharge Current (A)	Features
US1450FT1 (Under development)	530	LFP	Gr	3.2	17.6	φ 14	49	5	life, safety, small
US18650VTC4	2,100	NCM	Gr	3.6	45	φ 18	65	30	power
US18650VTC4A	2,100	NCM	Gr	3.7	46.8	φ 18	65	35	power
US18650VTC5	2,600	NCA	Gr	3.6	44.3	φ 18	65	30	power
US18650VTC5A	2,600	NCA	Gr, SiO	3.6	47.1	φ 18	65	35	power
US18650VTC5D	2,800	NCA	Gr, SiO	3.6	46.7	φ 18	65	35	power
US18650VTC6	3,120	NCA	Gr, SiO	3.6	46.6	φ 18	65	30	power
US18650VC7	3,500	NCA	Gr, SiO	3.6	47.2	φ 18	65	8	runtime
US18650FTC1	1,100	LFP	Gr	3.2	38.8	φ 18	65	20	life, safety
US18650FTC2 (Under development)	1,450	LFP	Gr	3.2	40	φ 18	65	20	life, safety
US21700VTC6A	4,100	NCA	Gr, SiO	3.6	67.5	φ 21	70	40	power
US26650FTC1A	3,000	LFP	Gr	3.2	84	φ 26	66	25	life, safety

Small Lithium ion Secondary Batteries

Murata's Small Lithium ion secondary batteries (CT04120) are rechargeable batteries which can be charged-discharged at high rate, used safely.



Part Number	Nominal Voltage	Charge Voltage	Cut-off Voltage	Nominal Capacity	Max. Discharge Current	ESR@ 1kHz	Operating Temperature Range	Size
BACT04120P003V01	2.3V	2.7V	1.8V	3mAh	30mA (10C)	1000mΩ	-20°C to 70°C	φ 4mm×12mm

FORTELION 24V Battery Module



Murata's FORTELION 24V Battery Module is built with olivine-type lithium ion iron phosphate secondary batteries (FORTELION), which are known for their longevity, safety, and fast-charging capability.

Murata's FORTELION 24V Battery Module is capable of monitoring each Battery Module's Voltage, Current, Temperature & Capacity Value through CAN communication.

It is possible to customize voltage and capacity in order to meet the requirements of wide range of applications including Robot, AGV, E-Cart, Forklift, etc.

Separate type

Items	Specifications
Model Name	LIPY032WWPCSY6(Battery Module) LIA1020WWPACSY6(BMU)
System configuration	Battery Module+BMU
Nominal Voltage / Capacity (per module)	25.6V / 24Ah / 614Wh
Max Discharge Current	50A / 40A / 30A (5sec / 25sec / cont.)
Max Charge Current	24A (1C)
Module Max Configuration	2s10p
Battery Communication I/F	CAN Bus (Murata original format)
Dust and Water proof	Not supported
Safety regulation	IEC62133 CE (EMC, RoHS)
Dimension (module)	259(L) x 71(W) x 245(H) (mm)
Weight (module)	7.3kg (Module)

All-in-one type

Items	Specifications
Model Name	LIPY041WWPCSY6
System configuration	All-in-one (BMU function is included)
Nominal Voltage / Capacity (one module)	25.6V / 21Ah / 537Wh
Max Discharge Current	100A / 80A / 60A (5sec / 25sec / cont.)
Max Charge Current	42A (2C)
Module Max Configuration	2s10p
Battery Communication I/F	CAN Bus, U-art (Murata original format)
Dust and Water proof	IP54 rating
Safety regulation	IEC/UL62133, IEC62619 UL2271 (Light EV battery) CE (EMC, RoHS)
Dimension	195(L) x 132(W) x 180(H) (mm)
Weight	6.5kg

FORTELION Battery System

Possible to customize capacity in order to meet wide usage

FORTELION High Output Battery Module

This energy storage module utilizes FORTELION olivine type lithium iron phosphate lithium ion secondary batteries. A high-input, high-output energy storage module capable of 200A continuous discharge (6C equivalent) and 100A continuous charge (3C equivalent), it is ideal for applications requiring high input and high output, such as countermeasures to deal with momentary voltage drops during natural disasters, backup systems, and stabilization of renewable energy sources.



(Excluding terminal)
MPRMH1701
26kg

Model Name	Rated Capacity	Nominal Voltage	Maximum Discharge Current	Maximum Charge Current	Operating Temperature Range	Safety Standard
MPRMH1701	1.75kWh	51.2V	200A	100A	-20 to 50°C	UL1973

FORTELION 2.1kWh Battery Module



(Excluding terminal)
IJ1101M
27kg

Model Name	Nominal Capacity	Rated Capacity	Nominal Voltage	Maximum Discharge Current	Charge Voltage	Maximum Charge Current	Safety Standard
IJ1101M	2.1kWh (42.0Ah)	2.0kWh (39.5Ah)	51.2V	50A	56.0V	40A	UL 1973 FCC Part 15 Class B

Storage Temperature: -20 to 45°C (Recommended room temperature)
 Operating Ambient Temperature: Discharge: -20 to 40°C (Discharge current ≤ 50.0A)
 40 to 50°C (Discharge current ≤ 40.0A)
 Charge: 10 to 45°C (Charge current ≤ 40.0A)
 0 to 10°C (Charge current ≤ 12.0A)

Batteries

Battery Management Unit (BMU)



(Excluding terminal)
IJ5101C
12kg

*use for Japan market



(Excluding terminal)
IJ8101C
14kg

(in mm)

Model Name	Operating Voltage	Operating Current	Communication Interface	Configuration	Safety Standard
IJ5101C	60 to 420V	0 to 100A	RS232C/RS485C	Series: to 7 series Mix Combination: to 6 series and to 2 parallels Maximum module connections: 32 modules	-
IJ8101C	300 to 1000V	0 to 100A	RS232C/RS485C	Series: to 16 series Mix Combination: to 16 series and to 2 parallels	UL 1973 FCC Part 15 Class B *It is certificated along with IJ1101M. *UL 1973 is certified for maximum of 90 A.

Storage Temperature: -20 to 65°C (Recommended room temperature)

Operating Ambient Temperature: -20 to 50°C (Recommended room temperature)

BMU-HUB



(Excluding terminal)
IJ1101K
3.4kg

(in mm)

Model Name	Operating Voltage	Purpose	Configuration	Safety Standard
IJ1101K	DC12V, DC24 to 60V	Interface unit to connect IJ8101C for utility	Parallel: to 64BMU Maximum module connections: 64X32=2048 modules (maximum 4.3MWh)	EU EMC Directive FCC Part 15 Class B

Storage Temperature: -20 to 65°C (Storage and use at room temperature is recommended)

Operating Ambient Temperature: -20 to 60°C (Storage and use at room temperature is recommended)

Cable

Model Name	Type	Specification
IJT-102F	Communication Cable 20cm	RS485
IJT-103F	Communication Cable 30cm	RS485
IJT-115F	Communication Cable 150cm	RS485
IJT-130F	Communication Cable 300cm	RS485
IJD-103F/R	Thicker Power Cable 30cm (red)	AWG4
IJD-103F/B	Thicker Power Cable 30cm (black)	AWG4
IJD-110F/R	Thicker Power Cable 100cm (red)	AWG4
IJD-110F/B	Thicker Power Cable 100cm (black)	AWG4

Coin Manganese Dioxide Lithium Batteries

Coin manganese dioxide lithium batteries are small-sized primary batteries for various applications such as TPMS (Tire Pressure Monitoring System) or smart entry systems for automobile, IoT devices, and backup power source for memory.



Standard

A lineup of 11 models is offered from small size and thin models to high-capacity models.

Model	Electrical Characteristics			Dimensions			Operating Temperature Range (°C)
	Nominal Voltage (V)	Nominal Capacity (mAh)	Standard Discharge Current (mA)	Diameter (mm)	Height (mm)	Weight (g)	
CR1216	3	30	0.1	12.5	1.6	0.67	-30 to 70
CR1220	3	40	0.1	12.5	2.0	0.77	-30 to 70
CR1616	3	60	0.1	16.0	1.6	1.1	-30 to 70
CR1620	3	80	0.1	16.0	2.0	1.3	-30 to 70
CR1632	3	140	0.2	16.0	3.2	1.9	-30 to 70
CR2016	3	90	0.1	20.0	1.6	1.8	-30 to 70
CR2025	3	160	0.2	20.0	2.5	2.6	-30 to 70
CR2032	3	220	0.2	20.0	3.2	3.1	-30 to 70
CR2430	3	300	0.2	24.5	3.0	4.4	-30 to 70
CR2450	3	610	0.2	24.5	5.0	6.5	-30 to 70

Nominal capacity indicates duration until discharge voltage drops down to 2.0V when discharged at nominal discharge current at 23°C. Data is not guaranteed, and is provided for reference purposes only.

Heat-resistant

Ideal for devices used in severe operating temperature environments including automobiles and FA, etc.

Model	Electrical Characteristics			Dimensions			Operating Temperature Range (°C)
	Nominal Voltage (V)	Nominal Capacity (mAh)	Recommended Continuous Discharge Current (mA)	Diameter (mm)	Height (mm)	Weight (g)	
CR2032W	3	210	≤1	20.0	3.2	3.1	-40 to 125
CR2050W	3	345	≤1	20.0	5.0	4.2	-40 to 125
CR2450W	3	550	≤1	24.5	5.0	6.7	-40 to 125
CR2477W	3	1000	≤1	24.5	7.7	11	-40 to 125

Data is not guaranteed, and is provided for reference purposes only.

Continued on the following page. ↗

Extended Temperature

Designed for automotive devices and outdoor IoT systems, including smart meters and FA control systems. Recommended as an alternative smaller and thinner solution to conventional cylindrical lithium batteries.

Model	Electrical Characteristics				Dimensions			Operating Temperature Range (°C)
	Nominal Voltage (V)	Nominal Capacity (mAh)	Recommended Continuous Discharge Current (mA)	Maximum pulse discharge current*1 (mA)	Diameter (mm)	Height (mm)	Weight (g)	
CR2032X	3.0	220	≤1	30	20.0	3.2	3.0	-40 to 85
CR2450X	3.0	600	≤1	30	24.5	5.0	6.2	-40 to 85
CR2477X	3.0	1000	≤1	30	24.5	7.7	9.5	-40 to 85
CR3677X	3.0	2000	≤1	80	36.5	7.7	20	-40 to 85

*1 Current for maintaining minimum 2V voltage with pulsed discharge of 3 seconds and 50% nominal capacity discharged (ambient temperature 23°C). Data is not guaranteed, and is provided for reference purposes only.

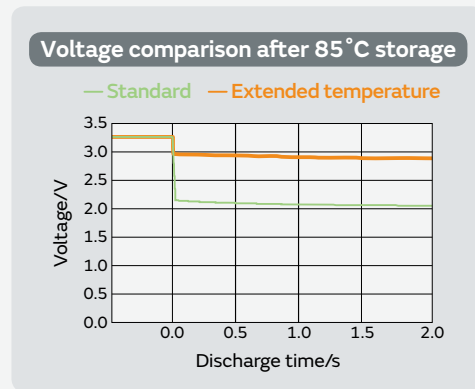
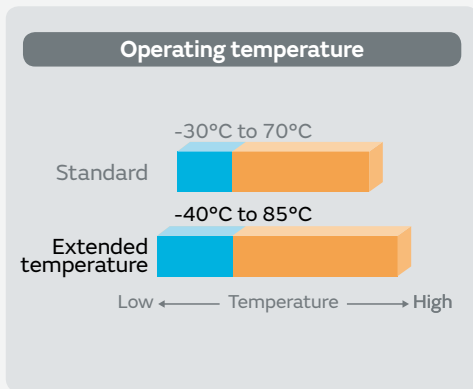

High Drain

Ideal for tracking devices for logistics and asset management by adopting Low Power Wide Area (LPWA) networks such as LoRa and SIGFOX as well as for outdoor infrastructures, FA control systems, and environment monitoring sensors.





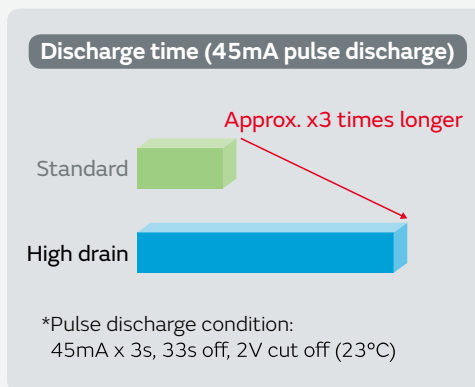
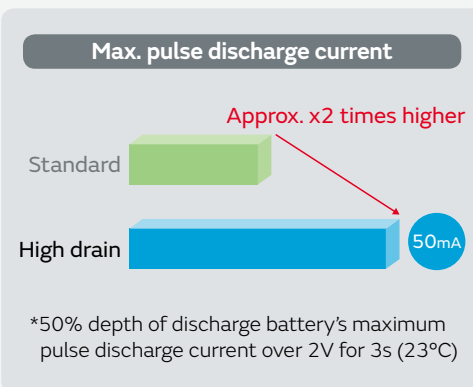



























Model	Electrical Characteristics				Dimensions			Operating Temperature Range (°C)
	Nominal Voltage (V)	Nominal Capacity (mAh)	Recommended Continuous Discharge Current (mA)	Maximum pulse discharge current*1 (mA)	Diameter (mm)	Height (mm)	Weight (g)	
CR2032R	3.0	200	≤3	50	20.0	3.2	3.0	-30 to 70
CR2450R	3.0	500	≤3	50	24.5	5.0	6.2	-30 to 70

*1 Current for maintaining minimum 2V voltage with pulsed discharge of 3 seconds and 50% nominal capacity discharged (ambient temperature 23°C). Data is not guaranteed, and is provided for reference purposes only.



Continued on the following page. ↗

Tab-welder

Mounting Direction		H		V	M	
						
Tab Specification	Shape	E		O	E	P
	Width of Negative Tab Tip (mm)	0.75	0.75	1.8	0.75	2.0
	Width of Positive Tab Tip (mm)	0.75X2	0.75X2	2.8	0.75X2	2.0
	Pitch (mm)	17.8	20.5	20.5	N/A	N/A
Standard	CR2032	CR2032-HE8 	CR2032-HE1 	CR2032-HO6 	CR2032-VE3 	
	CR2430	CR2430-HE1 	CR2430-HE2 	CR2430-HO1 	CR2430-VE1 	
	CR2450	CR2450-HE5 	CR2450-HE6 	CR2450-HO5 	CR2450-VE6 	
Extended Temperature	CR2032X		CR2032X-HE1 	CR2032X-HO6 		
	CR2450X		CR2450X-HE6 	CR2450X-HO5 		
	CR2477X		CR2477X-HE2 	CR2477X-HO4 		
Heat-resistant	CR2032W		CR2032W-HE1 	CR2032W-HO6 		
	CR2050W					CR2050W-MP6 
	CR2450W		CR2450W-HE6 	CR2450W-HO5 		CR2450W-MP1 
	CR2477W		CR2477W-HE2 	CR2477W-HO4 		
High Drain	CR2032R		CR2032R-HE1 	CR2032R-HO6 		
	CR2450R		CR2450R-HE6 	CR2450R-HO5 		

For tab shapes or specifications not included in the above list, please consult your sales representative.

Silver Oxide Batteries & Alkaline Manganese Batteries

Standard Silver Oxide Batteries

Silver oxide batteries are small-sized primary batteries with high capacity and stable discharge characteristics. They are suitable for medical devices and precision instruments. All models are 100% made in Japan, and environmentally friendly (0% mercury).



Model	Electrical Characteristics		Dimensions			Operating Temperature Range (°C)
	Nominal Voltage (V)	Nominal Capacity (mAh)	Diameter (mm)	Height (mm)	Weight (g)	
SR621	1.55	20	6.8	2.15	0.32	-10 to 60
SR626	1.55	28	6.8	2.60	0.40	-10 to 60
SR721	1.55	29	7.9	2.10	0.42	-10 to 60
SR726	1.55	35	7.9	2.60	0.50	-10 to 60
SR41	1.55	45	7.9	3.60	0.65	-10 to 60
SR48	1.55	75	7.9	5.40	1.2	-10 to 60
SR920	1.55	40	9.5	2.05	0.59	-10 to 60
SR927	1.55	60	9.5	2.70	0.79	-10 to 60
SR936	1.55	75	9.5	3.60	1.1	-10 to 60
SR1120	1.55	60	11.6	2.05	0.92	-10 to 60
SR1130	1.55	85	11.6	3.05	1.4	-10 to 60
SR43	1.55	110	11.6	4.20	1.8	-10 to 60

Data is not guaranteed, and is provided for reference purposes only. Please contact us for other models.

Standard Alkaline Manganese Batteries

Alkaline manganese batteries are small-sized primary batteries with high performance. They are suitable for various applications such as toys, medical devices and health appliances. All models are 100% made in Japan, and environmentally friendly (0% mercury).



Model	Electrical Characteristics		Dimensions			Operating Temperature Range (°C)
	Nominal Voltage (V)	Nominal Capacity (mAh)	Diameter (mm)	Height (mm)	Weight (g)	
LR41	1.5	45	7.9	3.60	0.57	-10 to 60
LR1130	1.5	70	11.6	3.05	1.2	-10 to 60
LR43	1.5	110	11.6	4.20	1.6	-10 to 60
LR44	1.5	120	11.6	5.40	2.0	-10 to 60

Data is not guaranteed, and is provided for reference purposes only. Please contact us for other models.

High Drain Silver Oxide Batteries (SR) & Alkaline Manganese Batteries (LR)

High drain SR/LR batteries are ideal for high-performance medical devices that require large current loads for communication, lighting, camera, mechanical driving, etc.

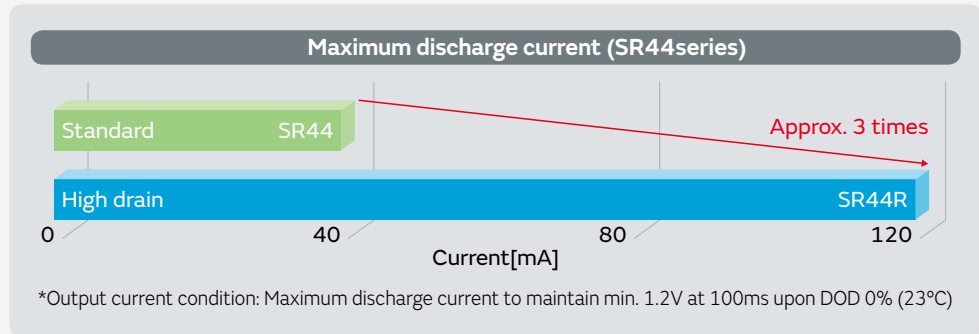

Model	Electrical Characteristics		Dimensions			Operating Temperature Range (°C)
	Nominal Voltage (V)	Nominal Capacity (mAh)	Diameter (mm)	Height (mm)	Weight (g)	
SR927R (Under development)	1.55	45	9.5	2.7	0.7	-10 to 60
SR44R	1.55	150	11.6	5.4	2.2	-10 to 60
LR44R	1.50	150	11.6	5.4	2.0	-10 to 60

Data is not guaranteed, and is provided for reference purposes only.

Sound Components (Buzzer)

Piezoelectric ceramic materials that expand and shrink by applying voltage are used in piezoelectric sound components.

Summary

Using Murata's unique ceramic material, we offer a variety of piezoelectric sound components.

Lineup

- SMD Piezoelectric Sounders
- Pin Type Piezoelectric Sounders
- Piezoelectric Buzzers
- Piezoelectric Diaphragms



<https://www.murata.com/en-global/products/sound>

SMD Piezoelectric Sounders

Low power consumption, lightweight.

Optimized for small devices such as blood glucose meters, clinical thermometers, photoflashes for cameras, and portable terminals.

Applicable for automotive usage based on our design and manufacturing technology.



Applications	Mounting Type	Drive Type	Main Part Number	Sound Pressure Level (typ.)	Measurement Condition of Sound Pressure Level
For Automotive	Surface Mounting Type	External Drive	PKMCS1818E20A0-R1	100dB	12Vo-p, 2.0kHz, square wave, 10cm
			PKLCS1212E20A0-R1	76dB	±1.5Vo-p, 2.0kHz, square wave, 10cm
			PKLCS1212E24A0-R1	80dB	±1.5Vo-p, 2.4kHz, square wave, 10cm
			PKLCS1212E40A1-R1	84dB	±1.5Vo-p, 4.0kHz, square wave, 10cm
For Consumer			PKLCS1212E2000-R1	76dB	±1.5Vo-p, 2.0kHz, square wave, 10cm
			PKLCS1212E2400-R1	80dB	±1.5Vo-p, 2.4kHz, square wave, 10cm
			PKLCS1212E4001-R1	84dB	±1.5Vo-p, 4.0kHz, square wave, 10cm
			PKMCS0909E4000-R1	72dB	±1.5Vo-p, 4.0kHz, square wave, 10cm
			PKMCS0909E48H0-R1	75dB	±2.5Vo-p, 4.8kHz, square wave, 10cm

Detailed Catalogs

For more details, please refer to our printed catalogs and the PDF catalogs on our website.



• Piezoelectric Sound Components

Cat. No. P37E

Pin Type Piezoelectric Sounders

Low power consumption, lightweight.

These products are optimized for operation confirmation sounds and warning sounds in household appliances such as air conditioners, washers, and refrigerators.

(in mm)

Packaging	Mounting Type	Drive Type	Main Part Number	Sound Pressure Level (typ.)	Measurement Condition of Sound Pressure Level
Taping	Pin Type	External Drive	PKM13EPYH4000-A0	78dB	±1.5Vo-p, 4.0kHz, square wave, 10cm
Bulk			PKM13EPYH4002-B0	78dB	±1.5Vo-p, 4.0kHz, square wave, 10cm
			PKM17EPP-2002-B0	79dB	3.0Vo-p, 2.0kHz, square wave, 10cm
			PKM22EPPH2001-B0	79dB	±1.5Vo-p, 2.0kHz, square wave, 10cm
			PKM22EPPH4007-B0	92dB	±1.5Vo-p, 4.0kHz, square wave, 10cm

Piezoelectric Buzzers

This is a unified piezoelectric sounder connected to a built-in self-drive circuit, and it easily generates sound with only a DC power supply.

Suitable for gas detector alarms/burglar alarms/home-electronic appliances.

(in mm)

Mounting Type	Drive Type	Main Part Number	Sound Pressure Level (min.)	Measurement Condition of Sound Pressure Level
Pin Type	Self Drive	PKB24SPCH3601-B0	90dB	12Vdc, 10cm

Piezoelectric Diaphragms

Low power consumption, lightweight.

Suitable for clocks/calculators/digital cameras/burglar alarms, and various alarms.

Drive Type	Main Part Number	Plate Size (øD)
External Drive	7BB-12-9	ø12.0mm
	7BB-15-6	ø15.0mm
	7BB-20-6	ø20.0mm
	7BB-27-4	ø27.0mm

□: Indicates Metal Plate Diameter and Resonant Frequency Type.

Wireless Communication Modules

Available for a wide range of applications such as automotive, mobile computing devices, and household appliances.

Wi-Fi Modules/ Bluetooth® · Wi-Fi Combo Modules



■ Features

Compact, highly efficient, and flexible custom-made correspondence

■ Applications

Mobile phones, automotive, tablet PC, POS, HT, electric equipment, smart grid, etc.

Bluetooth® Modules/ Bluetooth® Low Energy Modules



■ Features

Compact, highly efficient, and flexible custom-made correspondence

■ Applications

Mobile phones, automotive, PMP, POS, HT, healthcare, wireless remote control, etc.

Low Power Wide Area Network (LPWAN) Wireless Module



■ Features

LPWA Wireless Technology-Low-Power consumption, wide area coverage, enables IoT applications. Compact, high efficient, support various communication standards.

■ Applications

Positioning Tracking, Smart Houses, Agriculture, Healthcare/Medical, Industrial, Logistics, Utilities (Water, Gas Metering), etc.

Microblowers

Tiny air blowers/pumps without a motor

Features

The structure is designed to operate as a blower and pump by applying the ultrasonic vibrations of the ceramic as the drive source. This is achieved in an extremely compact, thin, and silent device with a high flow rate.

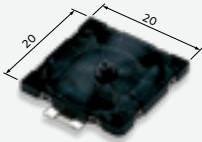

MZB1001T02

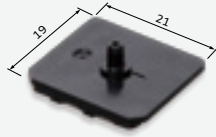

MZB3004T04

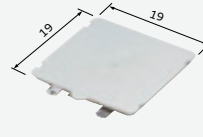

MZB3005T06

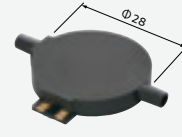

MZB4001T05

(in mm)

Part Number	MZB1001T02	MZB3004T04	MZB3005T06	MZB4001T05
Size	20(W) x 20(L) x 1.85(H) (Nozzle Height 1.6)	21(W) x 19(L) x 3.4(H) (Nozzle Height 4.5)	19(W) x 19(L) x 2.3(H)	Φ28 x 5(H) (Each Nozzle Length 6.5)
Flow rate (@0kPa)	1.2L/min (@21Vdc)	0.2L/min (@18Vdc)	0.2L/min (@18Vdc)	1.3L/min (@28Vdc)
Pressure (@0L/min)	2.5kPa (@21Vdc)	60kPa (@19.5Vdc)	60kPa (@19.5Vdc)	-20kPa (@28Vdc)
Resonance frequency	26kHz	23kHz	23kHz	21kHz
Input Voltage (*1)	11.5Vdc to 21Vdc	8Vdc to 19.5Vdc (*2)	8Vdc to 19.5Vdc (*2)	20Vdc to 28Vdc
Operating Temperature range	0°C to 70°C	0°C to 45°C (*3)(*4)	0°C to 45°C (*3)(*4)	5°C to 50°C (*3)(*5)

*The above value shows typical characteristics.

(*1) A drive circuit is required for the operation. Driving circuits are not common. The voltage is the voltage applied to them.

(*2) Only when the back pressure condition is 10kPa or more; it can be driven with a voltage of 18Vdc or more.

(*3) When operated continuously, sufficient performance may not be demonstrated due to the generation of heat.

(*4) Please use in environments where the temperature of the metal surface (marking surface) is 60°C or less.

(*5) Please use in environments where the temperature of the resin surface is 60°C or less.

- The microblower cannot be used for automobile applications (including accessories). Please refrain from use for automobile applications.
- If the microblower is used for medical applications, Murata requires a special contract to cover the use in the medical application to be agreed upon before the start of mass production.
- Please contact us for other details.

Application Examples

Aroma diffuser, gas/breath suction equipment, blood pressure measuring, breast pump, liquid transfer equipment by air pressure

Ionizer Modules: Ionissimo

High-concentration ion, compact design, ozone control

Ionissimo is an ionizer module with unprecedented compactness and high efficiency, capable of generating a large number of ions owing to Murata's own high-voltage technology and structural design. The ion generator is connected to the driving power supply for modularization and ease of incorporating into equipment.

MHM Series

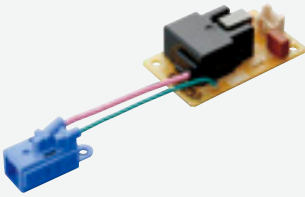

Features

- A large number of ions will be created by the original structure.
- Compact equipment may be designed due to small ionizer element and driving power supply.
- Ozone amounts may be optimized for specific applications by controlling the generation of ozone without changing the number of ions.

Applications

Air conditioner, air purifier, static eliminator, vacuum cleaner, etc.

Items	MHM305 Type	MHM314 Type	MHM306 Type	MHM400 Type	MHM402 Type	MHM403 Type
Input Voltage (VDC)	12.0 (10.8 to 13.2)	12.0 (10.8 to 13.2)	12.0 (10.8 to 13.2)	12.0 (10.8 to 13.2)	-	-
Input Voltage (VAC)	-	-	-	-	220/240 (210 to 250)	100 (85 to 110)
Power (W typ.)	0.4	0.9	0.6	0.6	0.4	-
Ion Polarity	Negative	Negative	Negative	Positive	Negative	Positive & Negative
Initial value of Ion amount (pcs/cc typ.) (*1)	5,000,000	8,000,000	5,000,000	5,000,000	4,000,000	-
Initial value of Ozone amount (mg/H)	<0.15	<0.15	0.6 typ.	<0.15	0.4 typ.	-
Operating Temp. (°C)	-10 to 50	-10 to 50	-10 to 50	-10 to 50	-10 to 50	-10 to 50
Operating Humidity (%RH) (*2)	20 to 80	20 to 80	20 to 80	20 to 80	20 to 80	20 to 80

(*1) Measuring distance : 20cm

(*2) No dew deposit

View a demonstration video of Ionissimo Ionizer Modules on our website.

Ozonizer Modules: Ionissimo

By using low-temperature co-fired ceramic substrate (LTCC) for the discharger ozone will be generated stably.

MHM Series

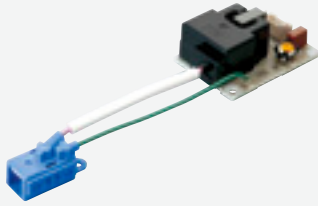

■ Features

- Stable ozone generation.
- MHM501 type can be used under high humidity conditions.
- Small size

■ Applications

Refrigerator, vacuum cleaner, dishwasher, clothes washer, etc.

Items	MHM500 Type	MHM501 Type	MHM502 Type	MHM503 Type
Input Voltage (VDC)	12.0 (10.8 to 13.2)	12.0 (10.8 to 13.2)	12.0 (10.8 to 13.2)	12.0 (10.8 to 13.2)
Power (W) (*1)	2.0	2.4	4.6	1.5
Ozone Level (mg/H typ.) (*1)	3.5 typ.	3 typ.	45 typ.	2 typ.
Max Duty (%)	30	30	100 (*3)	10 (*4)
Operating Temp. (°C)	-10 to 50	-10 to 50	5 to 60	-10 to 50
Operating Temp (%RH) (*2) High-voltage power supply area	20 to 80	20 to 80	20 to 80	20 to 80
Operating Humidity (%RH) (*2) Ozone generator area	20 to 80	20 to 95	20 to 90	20 to 95
Ozone generator area Supports high humidity	-	○	○	○

(*1) measurement result at Duty: 100%

(*2) No dew deposit

(*3) 100% Operation Only



(*4) The duty can be up to 15%.at Ta: 45°C

View a demonstration video of Ionissimo Ozonizer Modules on our website.

RFID Devices





RFID for transferring identification data by wireless communication. The state-of-the-art technology allows IC tags to be attached to places where traditional barcode and QR code technology could suffer from aging. Murata offers a comprehensive range of items required to introduce RFID, from IC tags to high-quality antennas, reader/writers, and software applications. With the complete kits from Murata, RFID is seamlessly and reliably implemented.

HF band RFID tag

Part number	LXMS33HCNG-134	LXMS33HCNK-171
Application	Small product management	
Appearance		
RFID standard	ISO15693 NFC Forum Type5	ISO14443 TypeA NFC Forum Type2
Frequency	13.56MHz	
IC	NXP ICODE SLIX	NXP NTAG210
UID memory	64bit	
NDEF memory	896bit	384bit
Size(L x W x H)	3.2 x 3.2 x 0.7 mm	3.2 x 3.2 x 0.75 mm
Read range*	20mm	15mm

*Reference

UHF band RFID tag

Part number	LXMSJZNCMD-217	LXMSJZNCMF-210	LXMS21ACMF-218	LXMS21ACMD-220	LXTBKZMCMG-010
Application	Small product management		Electronic equipment management		Metal product management
Appearance					
RFID standard	ISO18000-63 and EPC Global Gen2v2				
Frequency	865-928MHz				865-928MHz
IC	Impinj Monza 4QT	Impinj Monza R6	Impinj Monza R6	Impinj Monza 4QT	Impinj Monza R6P
UID memory	128bit	96bit	96bit	128bit	128bit
NDEF memory	512bit	NA	NA	512bit	32bit
Size(L x W x H)	1.2 x 1.2 x 0.55 mm		2.0 x 1.2 x 0.5 mm		6 x 2.0 x 2.3mm
Read range*	10mm		9m	7m	1.5m

*Reference

Note: Monza is a registered trademark of USA-based Impinj, Inc. in the United States and/or in other countries.

Note: ICODE and NTAG are registered trademarks of USA-based NXP Semiconductors N.V. in the United States and/or in other countries.

Femtet, CAE Software

User-Friendly Simulation Software Tailored for a Wide Range of Engineering Challenges

Femtet is a Multiphysics CAE software with multiple functionalities developed by Murata Manufacturing Co, Ltd.

Features

Femtet

Femtet is simulation software based on the finite element method. Its easy operation and comprehensive functionality make stress-free analysis environment possible.

Eight Solvers and Multiphysics

Solves eight major physical phenomena and multiphysics.

Efficient Designing

Capable of batch processing and parametric analysis that are essential for tuning and optimization of design.

VBA macro function is available to realize optimum design.

Comprehensive Functionalities

Equipped with comprehensive modules needed for modeling (CAD), meshing, simulations, and results display, it supports cost-effective simulation activities.

Database Management

Manages databases of materials, boundary conditions, body attributes, and models.

The database can be shared and used among a group of users.

CAD Translator

Lets you use the CAD data on hand right away by supporting various kinds of CAD formats to import and export.

Examples

Mechanical Stress



Thermal Conductivity

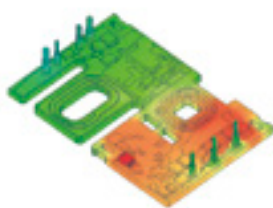

Electromagnetic Waves

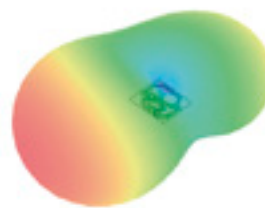

Magnetic Fields

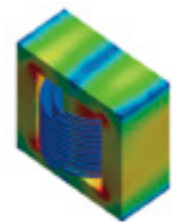

Fluid

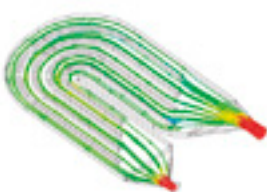

Electric Fields

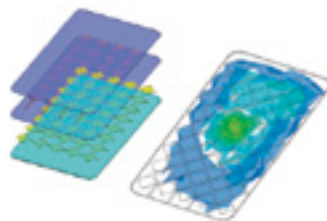

Piezoelectricity



Acoustic Waves

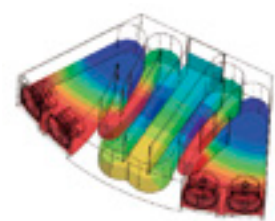

Others

Memo

Application Guides



Baseband unit (BBU) DU / CU

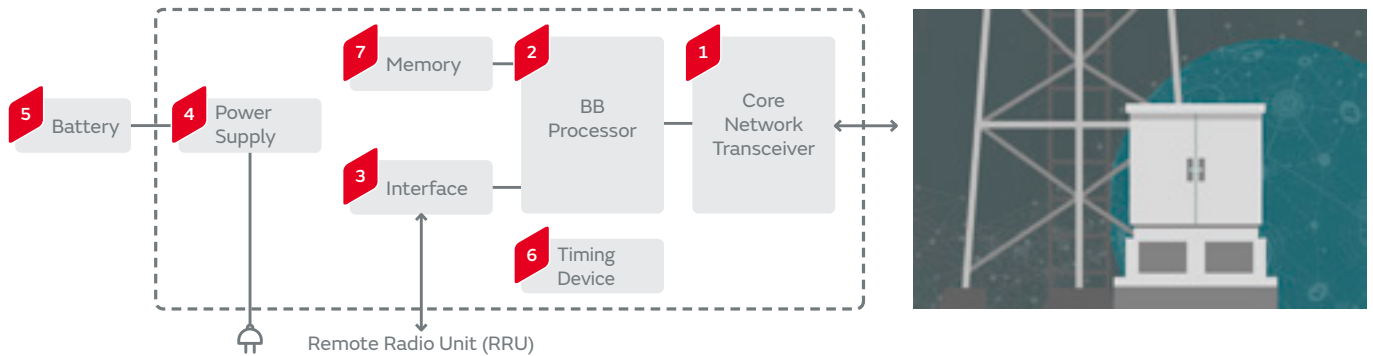

1 Core Network Transceiver

Wire Bonding Mount Multilayer
Microchip Capacitors for General Purpose
GMA Series



Wire Bonding/AuSn Soldering Mount Chip Multilayer
Ceramic Capacitors for General Purpose
GMD Series



Single-Layer
Microchip Capacitors
CLB Series



Thin Film Circuit Substrates (RUSUB)
RU Series



2 BB Processor

Chip Ferrite Beads
BLM Series



Chip Ferrite Beads
BLE Series



3 Terminals Low ESL Chip Multilayer
Ceramic Capacitors for General Purpose
NFM Series



Thermistors
NCU Series



3 Interface

Low ESL Chip Multilayer Ceramic
Capacitors for General Purpose
LLL/LLA/LLM Series













Silicon ESD Protection Devices
LXES**T Series





Chip Common Mode Choke Coils/
Common Mode Noise Filters
DLW/NFG/DLM Series



4 Power Supply

<p>Isolated DC-DC Converters MYB Series</p> 	<p>Non-Isolated DC-DC Converters MYMGK/MYSGK/OKL/MYLSM Series</p> 	<p>Isolated DC-DC Converters DSE/DAE/DCE/DSQ/DAQ/DCQ series</p> 	<p>AC-DC Converter 1U Frond End D1U Series</p> 
<p>Metal Terminal Type Multilayer Ceramic Capacitors for General Purpose KRM Series</p> 	<p>Polymer Aluminum Electrolytic Capacitors ECAS Series</p> 	<p>Thermistors PRF/NCU Series</p> 	<p>Chip Inductors (Chip Coils) LQM/LQH/DFE Series</p> 
<p>Isolated DC-DC Converters for PoE+PD MYBSP Series</p> 	<p>Safety Standard Certified Resin Molding SMD Type Ceramic Capacitors for General Purpose DK1 Series</p> 	<p>Safety Standard Certified Lead Type Disc Ceramic Capacitors for General Purpose DE1/DE2 Series</p> 	

5 Battery

<p>FORTELION High Output Battery Module MPRMH1701</p> 	<p>FORTELION 2.1kWh Battery Module System IJ1101M/IJ8101C/IJ1101k</p> 	<p>Cylindrical Type Lithium Ion Secondary Batteries</p> 
---	---	---

6 Timing Device

Crystal Units
XRC Series



7 Memory

Chip Ferrite Beads
BLM Series



General Purpose

Chip Multilayer Ceramic Capacitors for General Purpose	GRM Series	High Frequency Filter Circuit/Coupling/Decoupling/For Step-up
High Q Chip Multilayer Ceramic Capacitors for General Purpose	GQM / GJM Series	High Frequency Filter Circuit
Soft Termination Chip Multilayer Ceramic Capacitors for General Purpose	GRJ Series	Coupling/Decoupling/For Step-up
3 Terminals Low ESL Chip Multilayer Ceramic Capacitors for General Purpose	NFM Series	Noise Suppression/Decoupling
Polymer Aluminum Electrolytic Capacitors	ECAS Series	Smoothing /Transient Backup
Chip Inductors (Chip Coils)	LQW/LQP/LQG Series	High Frequency Circuit-Impedance Matching /Resonance
Chip Inductors (Chip Coils)	LQM/LQH/DFE Series	Voltage Conversion
Chip Ferrite Beads	BLM/NFZ Series	Noise Suppression
Feed Through Chip EMI Filters	NFE Series	Noise Suppression
Chip Common Mode Choke Coils/Common Mode Noise Filters	DLW/DLM Series	Noise Suppression
Piezoelectric Sounders	PKLCS/PKMCS Series	Sound Component
Coin Manganese Dioxide Lithium Batteries	Standard Type	Battery Backup

Remote radio unit (RRU) mmWave band

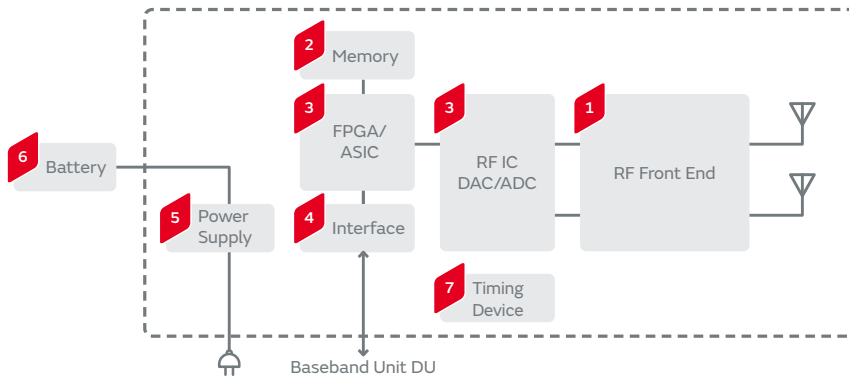

1 RF Front End

Silicon ESD Protection Devices
LXES**T Series



Thermistors
NCU Series



Chip Inductors (Chip Coils)
LQW/LQP/LQG Series



Silicon Capacitors



2 Memory

Chip Ferrite Beads
BLM Series



3 RF IC/DAC/ADC, FPGA/ASIC

Chip Ferrite Beads
BLM Series



3 Terminals Low ESL Chip Multilayer
Ceramic Capacitors for General Purpose
NFM Series



Chip Ferrite Beads
BLE Series



Thermistors
NCU Series



4 Interface

Low ESL Chip Multilayer Ceramic
Capacitors for General Purpose
LLL/LLA/LLM Series



Silicon ESD Protection Devices
LXES**T Series



Chip Common Mode Choke Coils/
Common Mode Noise Filters
DLW/NFG/DLM Series



5 Power Supply

Isolated DC-DC Converters
MYB Series



Non-Isolated DC-DC Converters
MYMGK/MYSGK/OKL/MYLSM Series



Isolated DC-DC Converters
DSE/DAE/DCE/DSQ/
DAQ/DCQ series



Metal Terminal Type Multilayer
Ceramic Capacitors for General Purpose
KRM Series



Polymer Aluminum
Electrolytic Capacitors
ECAS Series



Thermistors
PRF/NCU Series



6 Battery

FORTELION High Output Battery Module
MPRMH1701



FORTELION 2.1kWh Battery Module System
IJ1101M/IJ8101C/IJ1101k



Cylindrical Type Lithium Ion Secondary Batteries



7 Timing Device

Crystal Units
XRC Series



General Purpose

Chip Multilayer Ceramic Capacitors for General Purpose	GRM Series	High Frequency Filter Circuit/Coupling/Decoupling/For Step-up
High Q Chip Multilayer Ceramic Capacitors for General Purpose	GQM / GJM Series	High Frequency Filter Circuit
Soft Termination Chip Multilayer Ceramic Capacitors for General Purpose	GRJ Series	Coupling/Decoupling/For Step-up
3 Terminals Low ESL Chip Multilayer Ceramic Capacitors for General Purpose	NFM Series	Noise Suppression/Decoupling
Polymer Aluminum Electrolytic Capacitors	ECAS Series	Smoothing /Transient Backup
Chip Inductors (Chip Coils)	LQW/LQP/LQG Series	High Frequency Circuit-Impedance Matching /Resonance
Chip Inductors (Chip Coils)	LQM/LQH/DFE Series	Voltage Conversion
Chip Ferrite Beads	BLM/NFZ Series	Noise Suppression
Feed Through Chip EMI Filters	NFE Series	Noise Suppression
Chip Common Mode Choke Coils/Common Mode Noise Filters	DLW/DLM Series	Noise Suppression
Piezoelectric Sounders	PKLCS/PKMCS Series	Sound Component
Coin Manganese Dioxide Lithium Batteries	Standard Type	Battery Backup

Remote radio unit (RRU) less than sub-6GHz band

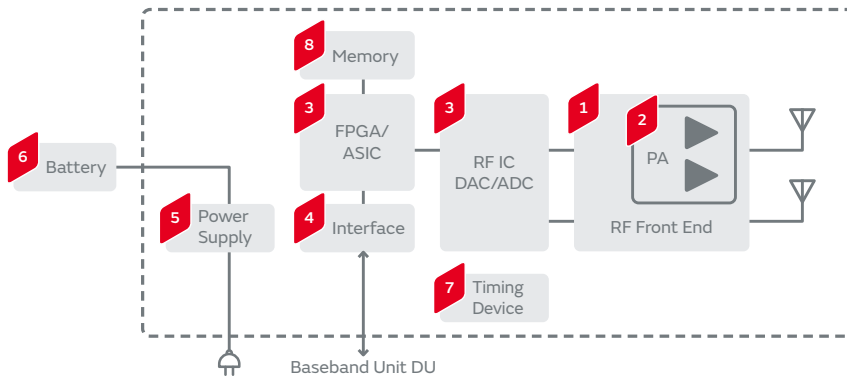

1 RF Front End

Chip Multilayer Diplexers

LFD Series



Chip Multilayer LC Filters

LF Series



Chip Multilayer Hybrid Baluns

LDB/LDM Series



Chip Multilayer Hybrid Couplers

LDC/LDJ Series



SAW Filters

SAF Series



SAW Duplexers

SAY Series



Chip Inductors (Chip Coils)

LQW/LQP/LQG Series



Thermistors

NCU Series



2 PA

Chip Inductors (Chip Coils)

LQW/LQP/LQG Series



Silicon Capacitors



Single-Layer
Microchip Capacitors

CLB Series



Thin Film Circuit
Substrates (RUSUB)

RU Series



High Q Chip Multilayer Ceramic Capacitors
for General Purpose

GQM/GJM Series



Thermistors

NCU Series



3 RF IC/DAC/ADC, FPGA/ASIC

Chip Ferrite Beads

BLM Series



3 Terminals Low ESL
Chip Multilayer Ceramic Capacitors
for General Purpose

NFM Series



Thermistors

NCU Series



Chip Ferrite Beads

BLE Series



4 Interface

Low ESL Chip Multilayer Ceramic Capacitors for General Purpose
LLL/LLA/LLM Series



Silicon ESD Protection Devices
LXES**T Series



Chip Common Mode Choke Coils/
Common Mode Noise Filters
DLW/NFG/DLM Series



5 Power Supply

Isolated DC-DC Converters
MYB Series



Non-Isolated DC-DC Converters
MYMGK/MYSGK/OKL/MYLSM Series



Metal Terminal Type Multilayer
Ceramic Capacitors for General Purpose
KRM Series



Polymer Aluminum
Electrolytic Capacitors
ECAS Series



Chip Inductors (Chip Coils)
FCUL/FDSD Series



Chip Inductors (Chip Coils)
LQM/LQH/DFE Series



Thermistors
PRF/NCU Series



6 Battery

FORTELION High Output Battery Module
MPRMH1701



FORTELION 2.1kWh Battery Module System
IJ1101M/IJ8101C/IJ1101k



Cylindrical Type Lithium Ion Secondary Batteries



7 Timing Device

Crystal Units
XRC Series



8 Memory

Chip Ferrite Beads
BLM Series



General Purpose

Chip Multilayer Ceramic Capacitors for General Purpose	GRM Series	High Frequency Filter Circuit/Coupling/Decoupling/For Step-up
High Q Chip Multilayer Ceramic Capacitors for General Purpose	GQM / GJM Series	High Frequency Filter Circuit
Soft Termination Chip Multilayer Ceramic Capacitors for General Purpose	GRJ Series	Coupling/Decoupling/For Step-up
3 Terminals Low ESL Chip Multilayer Ceramic Capacitors for General Purpose	NFM Series	Noise Suppression/Decoupling
Polymer Aluminum Electrolytic Capacitors	ECAS Series	Smoothing /Transient Backup
Chip Inductors (Chip Coils)	LQW/LQP/LQG Series	High Frequency Circuit-Impedance Matching /Resonance
Chip Inductors (Chip Coils)	LQM/LQH/DFE Series	Voltage Conversion
Chip Ferrite Beads	BLM/NFZ Series	Noise Suppression
Feed Through Chip EMI Filters	NFE Series	Noise Suppression
Chip Common Mode Choke Coils/Common Mode Noise Filters	DLW/DLM Series	Noise Suppression
Piezoelectric Sounders	PKLCS/PKMCS Series	Sound Component
Coin Manganese Dioxide Lithium Batteries	Standard Type	Battery Backup

CPE (FWA device)

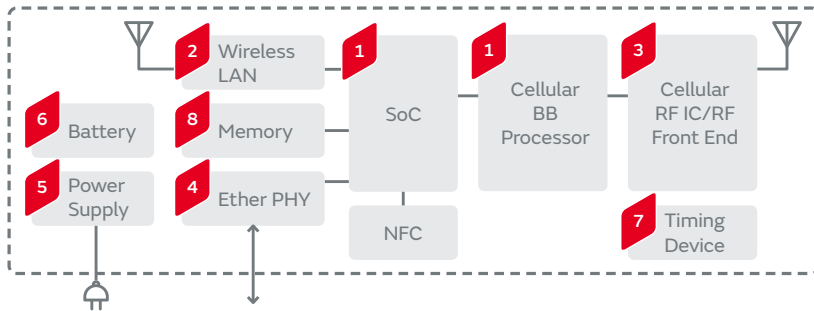

1 SoC/Cellular BB Processor

Thermistors
NCP/NCU Series



2 Wireless LAN

Wi-Fi Modules



SAW Filters
SAF Series



Chip Multilayer LC Filters
LF Series



Chip Multilayer Hybrid Baluns
LDB/LDM Series



Chip Multilayer Diplexers
LFD Series



Chip Multilayer Hybrid Couplers
LDC/LDJ Series



Microwave Coaxial
Connectors with Switch



Microwave Multi Line
Connectors



3 Cellular RF IC/RF Front End

Chip Multilayer Diplexers
LFD Series



SAW Duplexers
SAY Series



SAW Filters
SAF Series



Chip Multilayer LC Filters
LF Series



Chip Multilayer Hybrid Baluns
LDB/LDM Series



Chip Multilayer Hybrid Dividers
LDD Series



Chip Multilayer Hybrid Couplers
LDC/LDJ Series



Microwave Coaxial
Connectors with Switch



Microwave Multi Line
Connectors



4 Ether PHY

Low ESL Chip Multilayer Ceramic
Capacitors for General Purpose
LLL/LLA/LLM Series









Chip Common Mode Choke Coils/
Common Mode Noise Filters
DLW/NFG/DLM Series



Silicon ESD Protection Devices
LXES**T Series



5 Power Supply

<p>Low Acoustic Noise Chip Multilayer Ceramic Capacitors on Interposer Board for General Purpose ZRB Series</p> 	<p>Metal Terminal Type Multilayer Ceramic Capacitors for General Purpose KRM Series</p> 	<p>Polymer Aluminum Electrolytic Capacitors ECAS Series</p> 	<p>Chip Inductors (Chip Coils) FCUL/FDSD Series</p> 
<p>Chip Inductors (Chip Coils) LQM/LQH/DFE Series</p> 	<p>Thermistors NCP/NCU/PRF Series</p> 	<p>Isolated DC-DC Converters for PoE+PD MYBSP Series</p> 	

6 Battery

Thermistors
NCP/NCU/PRF Series



7 Timing Device

Crystal Units
XRC Series



8 Memory

Chip Ferrite Beads
BLM Series



General Purpose	Chip Multilayer Ceramic Capacitors for General Purpose	GRM Series	High Frequency Filter Circuit/Coupling/Decoupling/For Step-up
	High Q Chip Multilayer Ceramic Capacitors for General Purpose	GQM / GJM Series	High Frequency Filter Circuit
	Soft Termination Chip Multilayer Ceramic Capacitors for General Purpose	GRJ Series	Coupling/Decoupling/For Step-up
	3 Terminals Low ESL Chip Multilayer Ceramic Capacitors for General Purpose	NFM Series	Noise Suppression/Decoupling
	Polymer Aluminum Electrolytic Capacitors	ECAS Series	Smoothing /Transient Backup
	Chip Inductors (Chip Coils)	LQW/LQP/LQG Series	High Frequency Circuit-Impedance Matching /Resonance
	Chip Inductors (Chip Coils)	LQM/LQH/DFE Series	Voltage Conversion
	Chip Ferrite Beads	BLM/NFZ Series	Noise Suppression
	Feed Through Chip EMI Filters	NFE Series	Noise Suppression
	Chip Common Mode Choke Coils/Common Mode Noise Filters	DLW/DLM Series	Noise Suppression
	Piezoelectric Sounders	PKLCS/PKMCS Series	Sound Component
	Coin Manganese Dioxide Lithium Batteries	Standard Type	Battery Backup

OLT (Optical line terminal)

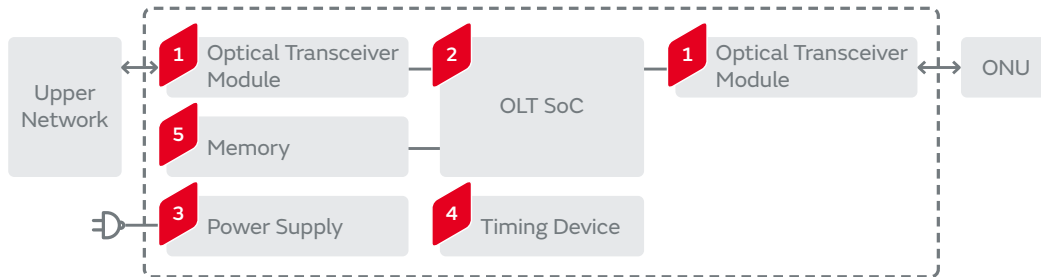
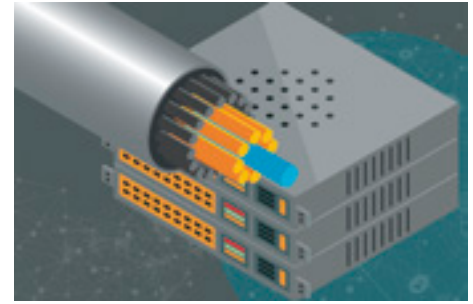

1 Optical Transceiver Module

Wire Bonding Mount Multilayer Microchip Capacitors for General Purpose
GMA Series



Thin Film Circuit Substrates (RUSUB)
RU Series



Wire Bonding/AuSn Soldering Mount Chip Multilayer Ceramic Capacitors for General Purpose
GMD Series



Silicon Capacitors



Chip Inductors (Chip Coils)
LQW/LQP/LQG Series



Single-Layer Microchip Capacitors
CLB Series



Chip Inductors (Chip Coils)
LQM/LQH/DFE Series



2 OLT SoC

Thermistors
NCP/NCU Series



Chip Ferrite Beads
BLM Series



4 Timing Device

Crystal Units
XRC Series



5 Memory

Chip Ferrite Beads
BLM Series



3 Power Supply

Isolated DC-DC Converters
MYB Series



Polymer Aluminum Electrolytic Capacitors
ECAS Series



Non-Isolated DC-DC Converters
MYMGK/MYSGK/OKL/MYLSM Series



Thermistors
NCP/NCU/PRF Series



Isolated DC-DC Converters for PoE+PD
MYBSP Series



Silicon ESD Protection Devices
LXES**T Series



General Purpose

Chip Multilayer Ceramic Capacitors for General Purpose	GRM Series	High Frequency Filter Circuit/Coupling/Decoupling/For Step-up
High Q Chip Multilayer Ceramic Capacitors for General Purpose	GQM / GJM Series	High Frequency Filter Circuit
Soft Termination Chip Multilayer Ceramic Capacitors for General Purpose	GRJ Series	Coupling/Decoupling/For Step-up
3 Terminals Low ESL Chip Multilayer Ceramic Capacitors for General Purpose	NFM Series	Noise Suppression/Decoupling
Polymer Aluminum Electrolytic Capacitors	ECAS Series	Smoothing /Transient Backup
Chip Inductors (Chip Coils)	LQW/LQP/LQG Series	High Frequency Circuit-Impedance Matching /Resonance
Chip Inductors (Chip Coils)	LQM/LQH/DFE Series	Voltage Conversion
Chip Ferrite Beads	BLM/NFZ Series	Noise Suppression
Feed Through Chip EMI Filters	NFE Series	Noise Suppression
Chip Common Mode Choke Coils/Common Mode Noise Filters	DLW/DLM Series	Noise Suppression
Piezoelectric Sounders	PKLCS/PKMCS Series	Sound Component
Coin Manganese Dioxide Lithium Batteries	Standard Type	Battery Backup

ONU (Optical network units)

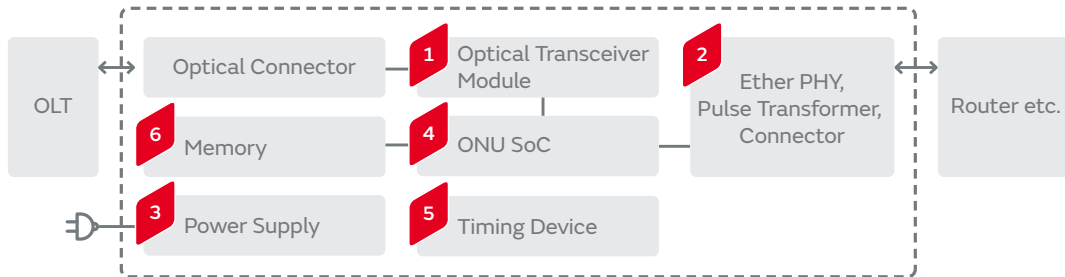
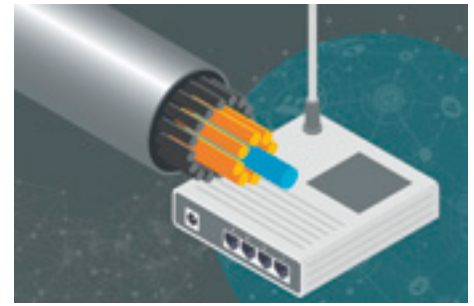

1 Optical Transceiver Module

Wire Bonding Mount Multilayer Microchip Capacitors for General Purpose GMA Series	Wire Bonding/AuSn Soldering Mount Chip Multilayer Ceramic Capacitors for General Purpose GMD Series
Single-Layer Microchip Capacitors CLB Series	Thin Film Circuit Substrates (RUSUB) RU Series
Thermistors NCP/NCU Series	Chip Inductors (Chip Coils) LQW/LQP/LQG Series
	Chip Inductors (Chip Coils) LQM/LQH/DFE Series
	Silicon Capacitors

2 Ether PHY, Pulse Transformer, Connector

Low ESL Chip Multilayer Ceramic Capacitors for General Purpose LLL/LLA/LLM Series	Chip Common Mode Choke Coils/ Common Mode Noise Filters DLW/NFG/DLM Series	Silicon ESD Protection Devices LXES**T Series
--	--	--

3 Power Supply

Isolated DC-DC Converters MYB Series	Non-Isolated DC-DC Converters MYMGK/MYSGK/ OKL/MYLSM Series
Isolated DC-DC Converters for PoE+PD MYBSP Series	Polymer Aluminum Electrolytic Capacitors ECAS Series
Thermistors NCP/NCU/PRF Series	Silicon ESD Protection Devices LXES**T Series

4 ONU SoC

Thermistors NCP/NCU Series	Chip Ferrite Beads BLM Series
-------------------------------	----------------------------------

5 Timing Device

Crystal Units XRC Series

6 Memory

Chip Ferrite Beads BLM Series

General Purpose	Chip Multilayer Ceramic Capacitors for General Purpose	GRM Series	High Frequency Filter Circuit/Coupling/Decoupling/For Step-up
	High Q Chip Multilayer Ceramic Capacitors for General Purpose	GQM / GJM Series	High Frequency Filter Circuit
	Soft Termination Chip Multilayer Ceramic Capacitors for General Purpose	GRJ Series	Coupling/Decoupling/For Step-up
	3 Terminals Low ESL Chip Multilayer Ceramic Capacitors for General Purpose	NFM Series	Noise Suppression/Decoupling
	Polymer Aluminum Electrolytic Capacitors	ECAS Series	Smoothing /Transient Backup
	Chip Inductors (Chip Coils)	LQW/LQP/LQG Series	High Frequency Circuit-Impedance Matching /Resonance
	Chip Inductors (Chip Coils)	LQM/LQH/DFE Series	Voltage Conversion
	Chip Ferrite Beads	BLM/NFZ Series	Noise Suppression
	Feed Through Chip EMI Filters	NFE Series	Noise Suppression
	Chip Common Mode Choke Coils/Common Mode Noise Filters	DLW/DLM Series	Noise Suppression
	Piezoelectric Sounders	PKLCS/PKMCS Series	Sound Component
	Coin Manganese Dioxide Lithium Batteries	Standard Type	Battery Backup

Core router

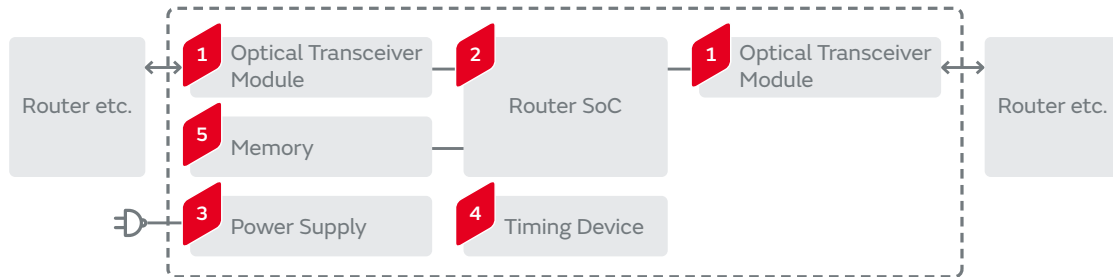

1 Optical Transceiver Module

<p>Wire Bonding Mount Multilayer Microchip Capacitors for General Purpose GMA Series</p>	<p>Wire Bonding/AuSn Soldering Mount Chip Multilayer Ceramic Capacitors for General Purpose GMD Series</p>	<p>Single-Layer Microchip Capacitors CLB Series</p>
<p>Thin Film Circuit Substrates (RUSUB) RU Series</p>	<p>Silicon Capacitors</p>	<p>Chip Inductors (Chip Coils) LQW/LQP/LQG Series</p>
		<p>Chip Inductors (Chip Coils) LQM/LQH/DFE Series</p>

2 Router SoC

<p>Chip Ferrite Beads BLM Series</p>	<p>Thermistors NCP/NCU Series</p>
--	---------------------------------------

4 Timing Device

<p>Crystal Units XRC Series</p>

5 Memory

<p>Chip Ferrite Beads BLM Series</p>
--

3 Power Supply

<p>Isolated DC-DC Converters MYB Series</p>	<p>Non-Isolated DC-DC Converters MYMGK/MYSGK/OKL/MYLSM Series</p>	<p>Isolated DC-DC Converters for PoE+PD MYBSP Series</p>
<p>Polymer Aluminum Electrolytic Capacitors ECAS Series</p>	<p>Thermistors NCP/NCU/PRF Series</p>	<p>Silicon ESD Protection Devices LXES**T Series</p>

General Purpose	Chip Multilayer Ceramic Capacitors for General Purpose	GRM Series	High Frequency Filter Circuit/Coupling/Decoupling/For Step-up
	High Q Chip Multilayer Ceramic Capacitors for General Purpose	GQM / GJM Series	High Frequency Filter Circuit
	Soft Termination Chip Multilayer Ceramic Capacitors for General Purpose	GRJ Series	Coupling/Decoupling/For Step-up
	3 Terminals Low ESL Chip Multilayer Ceramic Capacitors for General Purpose	NFM Series	Noise Suppression/Decoupling
	Polymer Aluminum Electrolytic Capacitors	ECAS Series	Smoothing /Transient Backup
	Chip Inductors (Chip Coils)	LQW/LQP/LQG Series	High Frequency Circuit-Impedance Matching /Resonance
	Chip Inductors (Chip Coils)	LQM/LQH/DFE Series	Voltage Conversion
	Chip Ferrite Beads	BLM/NFZ Series	Noise Suppression
	Feed Through Chip EMI Filters	NFE Series	Noise Suppression
	Chip Common Mode Choke Coils/Common Mode Noise Filters	DLW/DLM Series	Noise Suppression
	Piezoelectric Sounders	PKLCS/PKMCS Series	Sound Component
	Coin Manganese Dioxide Lithium Batteries	Standard Type	Battery Backup

Home router

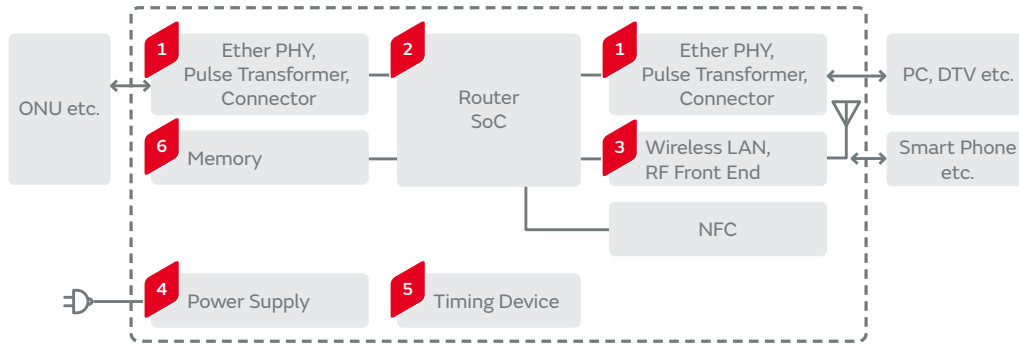

1 Ether PHY, Pulse Transformer, Connector

- Low ESL Chip Multilayer Ceramic Capacitors for General Purpose LLL/LLA/LLM Series
- Chip Common Mode Choke Coils/ Common Mode Noise Filters DLW/NFG/DLM Series
- Silicon ESD Protection Devices LXES**T Series
- Silicon Capacitors

2 Router SoC

- Chip Ferrite Beads BLM Series
- Thermistors NCP/NCU Series

3 Wireless LAN, RF Front End

- Microwave Coaxial Connectors with Switch
- Chip Multilayer Diplexers LFD Series
- Chip Multilayer Hybrid Couplers LDC/LDJ Series
- Chip Multilayer LC Filters LF Series
- Chip Multilayer Hybrid Baluns LDB/LDM Series

4 Power Supply

- Isolated DC-DC Converters MYB Series
- Non-Isolated DC-DC Converters MYMGK/MYSGK/OKL/MYLSM Series
- Isolated DC-DC Converters for PoE+PD MYBSP Series
- Polymer Aluminum Electrolytic Capacitors ECAS Series
- Thermistors NCP/NCU/PRF Series
- Silicon ESD Protection Devices LXES**T Series
- Chip Inductors (Chip Coils) LQM/LQH/DFE Series

5 Timing Device

- Crystal Units XRC Series

6 Memory

- Chip Ferrite Beads BLM Series

General Purpose

Chip Multilayer Ceramic Capacitors for General Purpose	GRM Series	High Frequency Filter Circuit/Coupling/Decoupling/For Step-up
High Q Chip Multilayer Ceramic Capacitors for General Purpose	GQM / GJM Series	High Frequency Filter Circuit
Soft Termination Chip Multilayer Ceramic Capacitors for General Purpose	GRJ Series	Coupling/Decoupling/For Step-up
3 Terminals Low ESL Chip Multilayer Ceramic Capacitors for General Purpose	NFM Series	Noise Suppression/Decoupling
Polymer Aluminum Electrolytic Capacitors	ECAS Series	Smoothing /Transient Backup
Chip Inductors (Chip Coils)	LQW/LQP/LQG Series	High Frequency Circuit-Impedance Matching /Resonance
Chip Inductors (Chip Coils)	LQM/LQH/DFE Series	Voltage Conversion
Chip Ferrite Beads	BLM/NFZ Series	Noise Suppression
Feed Through Chip EMI Filters	NFE Series	Noise Suppression
Chip Common Mode Choke Coils/Common Mode Noise Filters	DLW/DLM Series	Noise Suppression
Piezoelectric Sounders	PKLCS/PKMCS Series	Sound Component
Coin Manganese Dioxide Lithium Batteries	Standard Type	Battery Backup

Switch

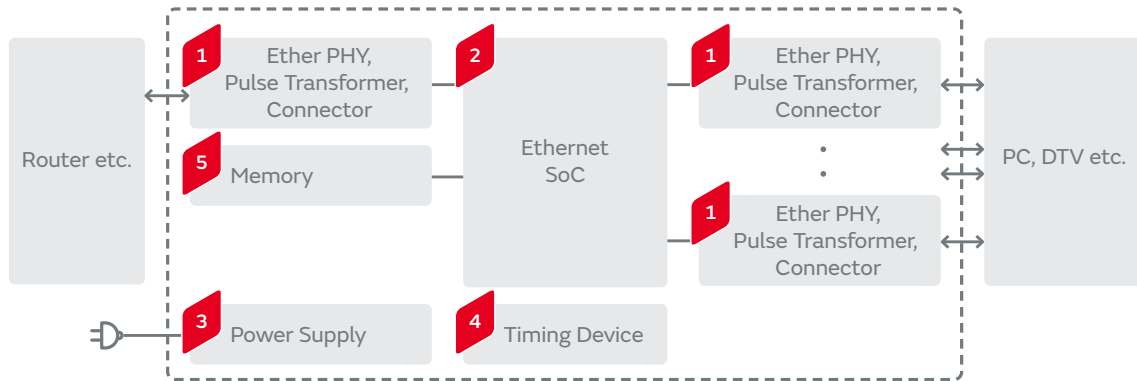

1 Ether PHY, Pulse Transformer, Connector

- Low ESL Chip Multilayer Ceramic Capacitors for General Purpose LLL/LLA/LLM Series
- Chip Common Mode Choke Coils/Common Mode Noise Filters DLW/NFG/DLM Series
- Silicon ESD Protection Devices LXES**T Series
- Silicon Capacitors

2 Ethernet SoC

- Chip Ferrite Beads BLM Series
- Thermistors NCP/NCU Series

3 Power Supply

- Isolated DC-DC Converters MYB Series
- Isolated DC-DC Converters for PoE+PD MYBSP Series
- Polymer Aluminum Electrolytic Capacitors ECAS Series
- Thermistors NCP/NCU/PRF Series
- Silicon ESD Protection Devices LXES**T Series
- Chip Inductors (Chip Coils) LQM/LQH/DFE Series
- Non-Isolated DC-DC Converters MYMGK Series
- Non-Isolated DC-DC Converters MYMGM Series
- Non-Isolated DC-DC Converters MYTN Series

4 Timing Device

- Crystal Units XRC Series

5 Memory

- Chip Ferrite Beads BLM Series

Chip Multilayer Ceramic Capacitors for General Purpose	GRM Series	High Frequency Filter Circuit/Coupling/Decoupling/For Step-up
High Q Chip Multilayer Ceramic Capacitors for General Purpose	GQM / GJM Series	High Frequency Filter Circuit
Soft Termination Chip Multilayer Ceramic Capacitors for General Purpose	GRJ Series	Coupling/Decoupling/For Step-up
3 Terminals Low ESL Chip Multilayer Ceramic Capacitors for General Purpose	NFM Series	Noise Suppression/Decoupling
Polymer Aluminum Electrolytic Capacitors	ECAS Series	Smoothing /Transient Backup
Chip Inductors (Chip Coils)	LQW/LQP/LQG Series	High Frequency Circuit-Impedance Matching /Resonance
Chip Inductors (Chip Coils)	LQM/LQH/DFE Series	Voltage Conversion
Chip Ferrite Beads	BLM/NFZ Series	Noise Suppression
Feed Through Chip EMI Filters	NFE Series	Noise Suppression
Chip Common Mode Choke Coils/Common Mode Noise Filters	DLW/DLM Series	Noise Suppression
Piezoelectric Sounders	PKLCS/PKMCS Series	Sound Component
Coin Manganese Dioxide Lithium Batteries	Standard Type	Battery Backup

Server

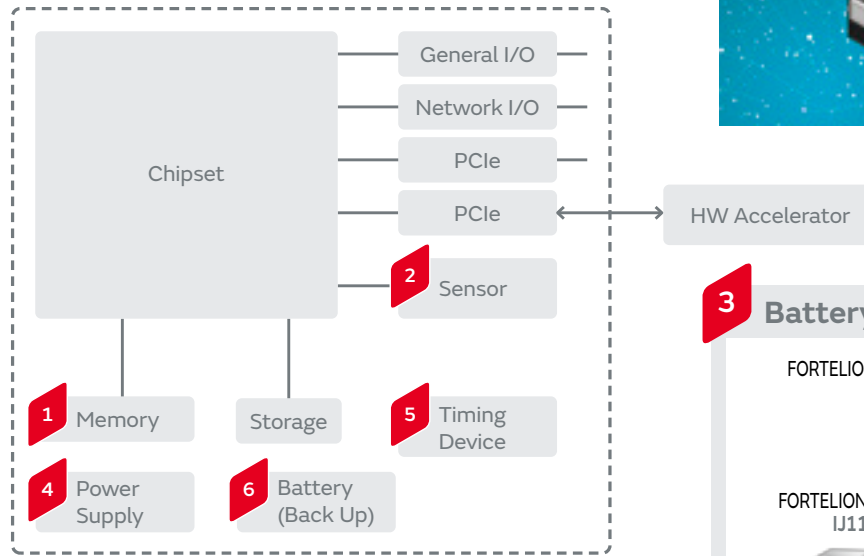

3 Battery (Back Up)

1 Memory

6 Battery (Back Up)

Storage

5 Timing Device

Power Supply

3 Battery (Back up)

FORTELION High Output Battery Module
MPRMH1701



FORTELION 2.1kWh Battery Module System
IJ1101M/IJ8101C/IJ1101k



Cylindrical Type Lithium Ion
Secondary Batteries



1 Memory

Chip Ferrite Beads
BLM Series



2 Sensor

Thermistors
NCU/PRF/NXF/NXR Series



4 Power Supply

Polymer Aluminum Electrolytic Capacitors ECAS Series	Non-Isolated DC-DC Converters MYMGK Series	Non-Isolated DC-DC Converters MYMGM Series	Non-Isolated DC-DC Converters MYTN Series	Isolated DC-DC Converters DRE/RBS/DRQ Series
AC-DC Converter 1U Front End D1U Series	Silicon ESD Protection Devices LXES**T Series	Chip Inductors (Chip Coils) FCUL/FDA Series	Thermistors PRF/NCU Series	

*Centralized power supply systems
<https://www.murata.com/en-global/products/power/open-compute>

5 Timing Device

MEMS Resonators
WMRAG Series



Crystal Units
XRC Series



6 Battery (Back up)

Coin Manganese Dioxide Lithium Batteries
Heat-resistant Type/
Extended Temperature Type



Cylindrical Type Lithium Ion
Secondary Batteries



General Purpose

Chip Multilayer Ceramic Capacitors for General Purpose	GRM Series	High Frequency Filter Circuit/Coupling/Decoupling/For Step-up
High Q Chip Multilayer Ceramic Capacitors for General Purpose	GQM / GJM Series	High Frequency Filter Circuit
Soft Termination Chip Multilayer Ceramic Capacitors for General Purpose	GRJ Series	Coupling/Decoupling/For Step-up
3 Terminals Low ESL Chip Multilayer Ceramic Capacitors for General Purpose	NFM Series	Noise Suppression/Decoupling
Polymer Aluminum Electrolytic Capacitors	ECAS Series	Smoothing /Transient Backup
Chip Inductors (Chip Coils)	LQW/LQP/LQG Series	High Frequency Circuit-Impedance Matching /Resonance
Chip Inductors (Chip Coils)	LQM/LQH/DFE Series	Voltage Conversion
Chip Ferrite Beads	BLM/NFZ Series	Noise Suppression
Feed Through Chip EMI Filters	NFE Series	Noise Suppression
Chip Common Mode Choke Coils/Common Mode Noise Filters	DLW/DLM Series	Noise Suppression
Piezoelectric Sounders	PKLCS/PKMCS Series	Sound Component
Coin Manganese Dioxide Lithium Batteries	Standard Type	Battery Backup

Network switch

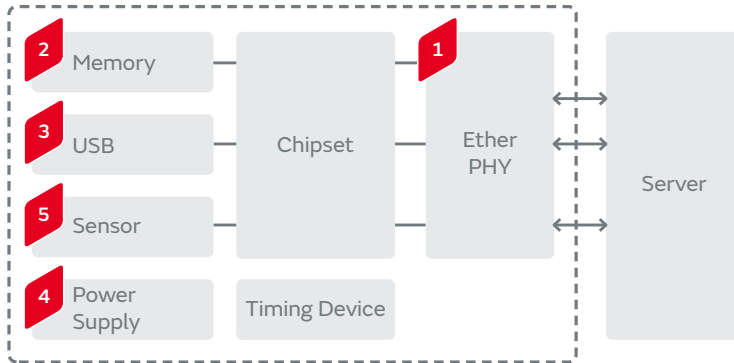
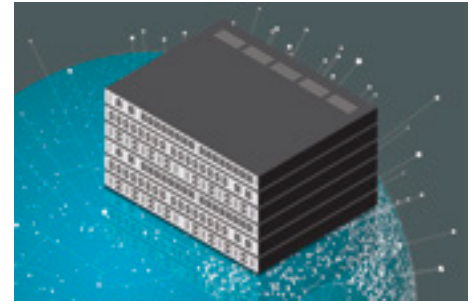

1 Ether PHY

Low ESL Chip Multilayer Ceramic Capacitors for General Purpose
LLL/LLA/LLM Series



Chip Common Mode Choke Coils/
Common Mode Noise Filters
DLW/NFG/DLM Series



Silicon ESD Protection Devices
LXES**T Series



Silicon Capacitors



2 Memory

Chip Ferrite Beads
BLM Series



3 USB

Chip Common Mode
Choke Coils/
Common Mode Noise Filters
DLW/NFG/DLM Series



4 Power Supply

Isolated
DC-DC Converters
MYB Series



Non-Isolated DC-DC Converters
MYMGK Series



Non-Isolated DC-DC Converters
MYMGM Series



Non-Isolated DC-DC Converters
MYTN Series



Isolated DC-DC Converters
DRE/RBS/DRQ Series



AC-DC Converter 1U Front End
D1U Series



Isolated DC-DC Converters for PoE+PD
MYBSP Series



5 Sensor

Thermistors
NCU/PRF/NXF/NXR Series



Polymer Aluminum Electrolytic Capacitors
ECAS Series



Thermistors
PRF/NCU Series



Silicon ESD Protection Devices
LXES**T Series



General Purpose

Chip Multilayer Ceramic Capacitors for General Purpose	GRM Series	High Frequency Filter Circuit/Coupling/Decoupling/For Step-up
High Q Chip Multilayer Ceramic Capacitors for General Purpose	GQM / GJM Series	High Frequency Filter Circuit
Soft Termination Chip Multilayer Ceramic Capacitors for General Purpose	GRJ Series	Coupling/Decoupling/For Step-up
3 Terminals Low ESL Chip Multilayer Ceramic Capacitors for General Purpose	NFM Series	Noise Suppression/Decoupling
Polymer Aluminum Electrolytic Capacitors	ECAS Series	Smoothing /Transient Backup
Chip Inductors (Chip Coils)	LQW/LQP/LQG Series	High Frequency Circuit-Impedance Matching /Resonance
Chip Inductors (Chip Coils)	LQM/LQH/DFE Series	Voltage Conversion
Chip Ferrite Beads	BLM/NFZ Series	Noise Suppression
Feed Through Chip EMI Filters	NFE Series	Noise Suppression
Chip Common Mode Choke Coils/Common Mode Noise Filters	DLW/DLM Series	Noise Suppression
Piezoelectric Sounders	PKLCS/PKMCS Series	Sound Component
Coin Manganese Dioxide Lithium Batteries	Standard Type	Battery Backup

DCIM (Data center infrastructure management)

1 Environmental Monitoring

- Air Conditioner
- Security
- Controller
- Gateway

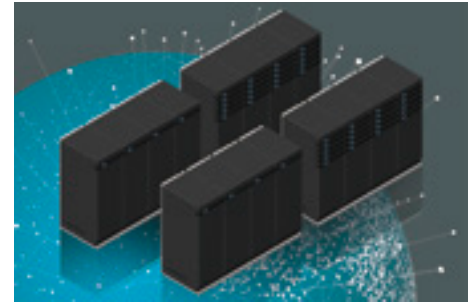

1 Environmental Monitoring

<p>Wi-Fi Modules</p>	<p>LPWA Modules</p>	<p>Magnetic Sensors (TMR Sensors) CT Series</p>	<p>Thermistors NCU Series</p>
----------------------	---------------------	---	-----------------------------------

General Purpose	Chip Multilayer Ceramic Capacitors for General Purpose	GRM Series	High Frequency Filter Circuit/Coupling/Decoupling/For Step-up
	High Q Chip Multilayer Ceramic Capacitors for General Purpose	GQM / GJM Series	High Frequency Filter Circuit
	Soft Termination Chip Multilayer Ceramic Capacitors for General Purpose	GRJ Series	Coupling/Decoupling/For Step-up
	3 Terminals Low ESL Chip Multilayer Ceramic Capacitors for General Purpose	NFM Series	Noise Suppression/Decoupling
	Polymer Aluminum Electrolytic Capacitors	ECAS Series	Smoothing /Transient Backup
	Chip Inductors (Chip Coils)	LQW/LQP/LQG Series	High Frequency Circuit-Impedance Matching /Resonance
	Chip Inductors (Chip Coils)	LQM/LQH/DFE Series	Voltage Conversion
	Chip Ferrite Beads	BLM/NFZ Series	Noise Suppression
	Feed Through Chip EMI Filters	NFE Series	Noise Suppression
	Chip Common Mode Choke Coils/Common Mode Noise Filters	DLW/DLM Series	Noise Suppression
	Piezoelectric Sounders	PKLCS/PKMCS Series	Sound Component
	Coin Manganese Dioxide Lithium Batteries	Standard Type	Battery Backup

Hardware accelerator

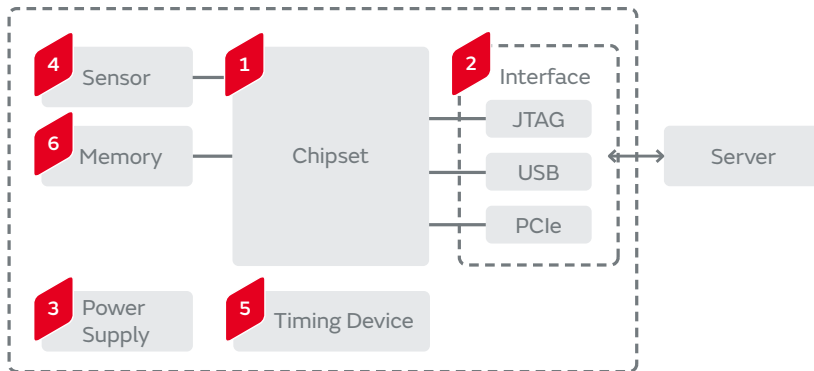

1 Chipset

3 Terminals Low ESL Chip Multilayer Ceramic Capacitors for General Purpose
NFM Series



Low ESL Chip Multilayer Ceramic Capacitors for General Purpose
LLL/LLA/LLM Series



2 Interface

Chip Common Mode Choke Coils/
Common Mode Noise Filters
DLW/NFG/DLM Series



3 Power Supply

Polymer Aluminum Electrolytic Capacitors
ECAS Series



Low ESL Chip Multilayer Ceramic Capacitors for General Purpose
LLL/LLA/LLM Series



Chip Inductors (Chip Coils)
LQM/LQH/DFE Series



Large-current Common Mode Choke Coils
PLT10/PLT5B/DLW5A/DLW5B/UCMH Series



Thermistors
PRF/NCU Series



Non-Isolated DC-DC Converters
MYMGK Series



Non-Isolated DC-DC Converters
MYMGK Series



Non-Isolated DC-DC Converters
MYTN Series



4 Sensor

Thermistors
NCU/PRF/NXF/NXR Series



5 Timing Device

MEMS Resonators
WMRAG Series



Crystal Units
XRC Series



6 Memory

Chip Ferrite Beads
BLM Series



General Purpose

Chip Multilayer Ceramic Capacitors for General Purpose	GRM Series	High Frequency Filter Circuit/Coupling/Decoupling/For Step-up
High Q Chip Multilayer Ceramic Capacitors for General Purpose	GQM / GJM Series	High Frequency Filter Circuit
Soft Termination Chip Multilayer Ceramic Capacitors for General Purpose	GRJ Series	Coupling/Decoupling/For Step-up
3 Terminals Low ESL Chip Multilayer Ceramic Capacitors for General Purpose	NFM Series	Noise Suppression/Decoupling
Polymer Aluminum Electrolytic Capacitors	ECAS Series	Smoothing /Transient Backup
Chip Inductors (Chip Coils)	LQM/LQP/LQG Series	High Frequency Circuit-Impedance Matching /Resonance
Chip Inductors (Chip Coils)	LQM/LQH/DFE Series	Voltage Conversion
Chip Ferrite Beads	BLM/NFZ Series	Noise Suppression
Feed Through Chip EMI Filters	NFE Series	Noise Suppression
Chip Common Mode Choke Coils/Common Mode Noise Filters	DLW/DLM Series	Noise Suppression
Piezoelectric Sounders	PKLCS/PKMCS Series	Sound Component
Coin Manganese Dioxide Lithium Batteries	Standard Type	Battery Backup

Storage system

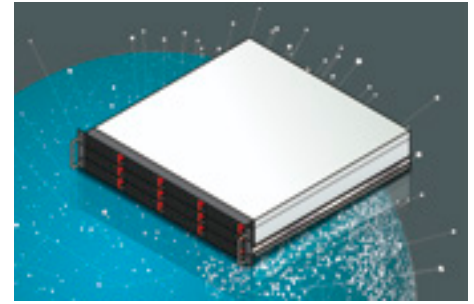

1 Interface

Low ESL Chip Multilayer Ceramic Capacitors for General Purpose
LLL/LLA/LLM Series



Chip Common Mode Choke Coils/
Common Mode Noise Filters
DLW/NFG/DLM Series



Silicon ESD Protection Devices
LXES**T Series

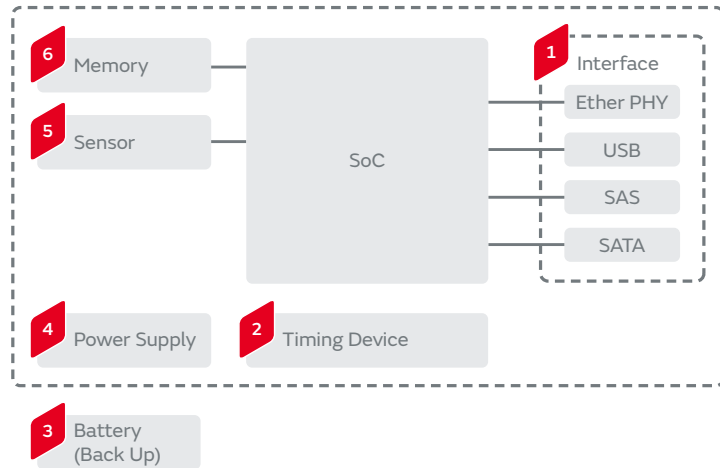

2 Timing Device

Crystal Units
XRC Series



3 Battery (Back up)

FORTELION High Output Battery Module
MPRMH1701



FORTELION 2.1kWh Battery Module System
IJ1101M/IJ8101C/IJ1101k



Cylindrical Type Lithium Ion
Secondary Batteries



4 Power Supply

Polymer Aluminum Electrolytic Capacitors
ECAS Series



Low ESL Chip Multilayer Ceramic
Capacitors for General Purpose
LLL/LLA/LLM Series



Chip Inductors (Chip Coils)
LQM/LQH/DFE Series



Thermistors
PRF/NCU Series



Isolated DC-DC Converters
DRE/RBS/DRQ Series



AC-DC Converter
1U Front End
D1U Series



Silicon ESD Protection Devices
LXES**T Series



5 Sensor

Thermistors
NCU/PRF/NXF/NXR Series



6 Memory

Chip Ferrite Beads
BLM Series



General Purpose

Chip Multilayer Ceramic Capacitors for General Purpose	GRM Series	High Frequency Filter Circuit/Coupling/Decoupling/For Step-up
High Q Chip Multilayer Ceramic Capacitors for General Purpose	GQM / GJM Series	High Frequency Filter Circuit
Soft Termination Chip Multilayer Ceramic Capacitors for General Purpose	GRJ Series	Coupling/Decoupling/For Step-up
3 Terminals Low ESL Chip Multilayer Ceramic Capacitors for General Purpose	NFM Series	Noise Suppression/Decoupling
Polymer Aluminum Electrolytic Capacitors	ECAS Series	Smoothing /Transient Backup
Chip Inductors (Chip Coils)	LQW/LQP/LQG Series	High Frequency Circuit-Impedance Matching /Resonance
Chip Inductors (Chip Coils)	LQM/LQH/DFE Series	Voltage Conversion
Chip Ferrite Beads	BLM/NFZ Series	Noise Suppression
Feed Through Chip EMI Filters	NFE Series	Noise Suppression
Chip Common Mode Choke Coils/Common Mode Noise Filters	DLW/DLM Series	Noise Suppression
Piezoelectric Sounders	PKLCS/PKMCS Series	Sound Component
Coin Manganese Dioxide Lithium Batteries	Standard Type	Battery Backup

PLC (Programmable logic controller)

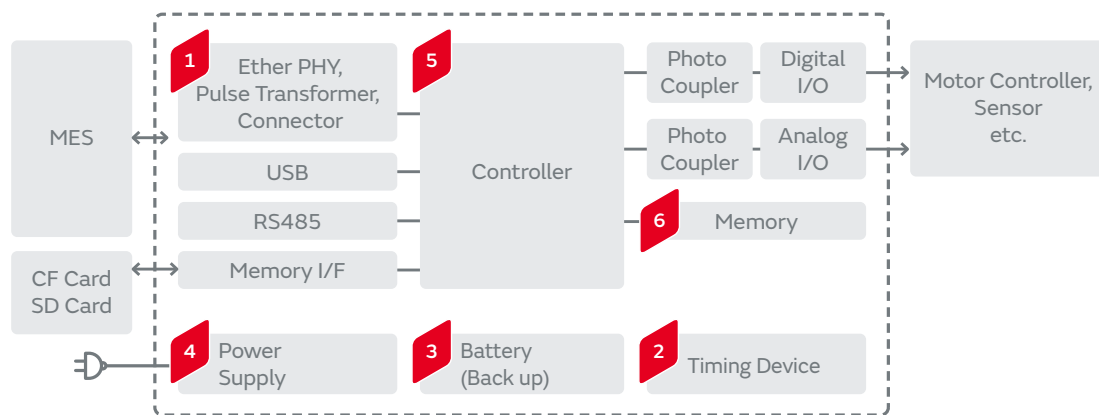
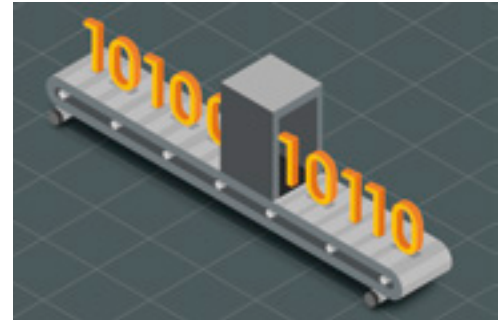

1 Ether PHY, Pulse Transformer, Connector

- Low ESL Chip Multilayer Ceramic Capacitors for General Purpose LLL/LLA/LLM Series
- Chip Common Mode Choke Coils/ Common Mode Noise Filters DLW/NFG/DLM Series
- Silicon ESD Protection Devices LXES**T Series

3 Battery (Back Up)

- Coin Manganese Dioxide Lithium Batteries
- Heat-resistant Type/ Extended Temperature Type

2 Timing Device

- Crystal Units XRC Series
- Ceramic Resonators CERALOCK CST Series
- MEMS Resonators WMRAG Series

4 Power Supply

- Isolated DC-DC Converters MYB Series
- Non-Isolated DC-DC Converters MYMGK/MYSGK/OKL/MYLSM Series
- Isolated DC-DC Converters for PoE+PD MYBSP Series
- Polymer Aluminum Electrolytic Capacitors ECAS Series
- Thermistors NCP/NCU/PRF Series
- Silicon ESD Protection Devices LXES**T Series
- Chip Inductors (Chip Coils) LQM/LQH/DFE Series

5 Controller

Chip Ferrite Beads
BLM Series



Thermistors
NCP/NCU Series



6 Memory

Chip Ferrite Beads
BLM Series



General Purpose

Chip Multilayer Ceramic Capacitors for General Purpose	GRM Series	High Frequency Filter Circuit/Coupling/Decoupling/For Step-up
High Q Chip Multilayer Ceramic Capacitors for General Purpose	GQM / GJM Series	High Frequency Filter Circuit
Soft Termination Chip Multilayer Ceramic Capacitors for General Purpose	GRJ Series	Coupling/Decoupling/For Step-up
3 Terminals Low ESL Chip Multilayer Ceramic Capacitors for General Purpose	NFM Series	Noise Suppression/Decoupling
Polymer Aluminum Electrolytic Capacitors	ECAS Series	Smoothing /Transient Backup
Chip Inductors (Chip Coils)	LQW/LQP/LQG Series	High Frequency Circuit-Impedance Matching /Resonance
Chip Inductors (Chip Coils)	LQM/LQH/DFE Series	Voltage Conversion
Chip Ferrite Beads	BLM/NFZ Series	Noise Suppression
Feed Through Chip EMI Filters	NFE Series	Noise Suppression
Chip Common Mode Choke Coils/Common Mode Noise Filters	DLW/DLM Series	Noise Suppression
Piezoelectric Sounders	PKLCS/PKMCS Series	Sound Component
Coin Manganese Dioxide Lithium Batteries	Standard Type	Battery Backup

AGV (Automatic guided vehicle)



1 Timing Device

Crystal Units
XRC Series



MEMS Resonators
WMRAG Series



2 Wireless LAN Module

Microwave Coaxial
Connectors with Switch



Chip Multilayer Diplexers
LFD Series



Chip Multilayer
Hybrid Couplers
LDC/LDJ Series



Chip Multilayer LC Filters
LF Series



Chip Multilayer
Hybrid Baluns
LDB/LDM Series



5 Traceability

RFID Tag
LXMS/LXTB Series

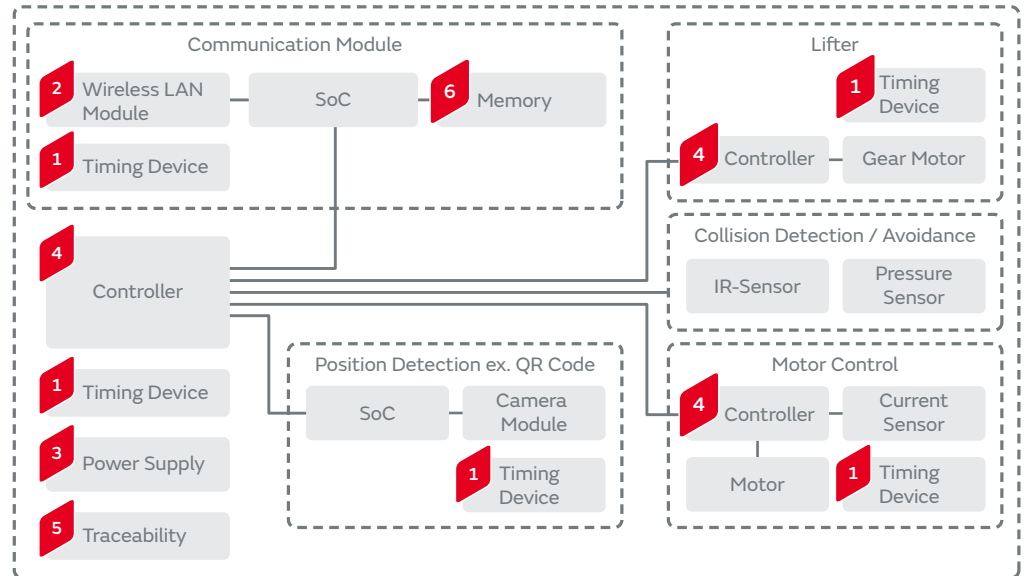

3 Power Supply

Isolated DC-DC Converters
MYB Series



Non-Isolated DC-DC Converters
MYMGK/MYSGK/
OKL/MYLSM Series



Isolated DC-DC Converters
for PoE+PD
MYBSP Series



Polymer Aluminum
Electrolytic Capacitors
ECAS Series



Thermistors
NCP/NCU/PRF Series



Silicon ESD Protection Devices
LXES**T Series



Chip Inductors (Chip Coils)
LQM/LQH/DFE Series



FORTELION 24V
Battery Module



FORTELION High Output
Battery Module
MPRMH1701



FORTELION 2.1kWh Battery Module System
IJ1101M/IJ8101C/IJ1101k



Cylindrical Type Lithium Ion
Secondary Batteries



4 Controller

Chip Ferrite Beads
BLM Series



Thermistors
NCP/NCU Series



6 Memory

Chip Ferrite Beads
BLM Series



Chip Multilayer Ceramic Capacitors for General Purpose	GRM Series	High Frequency Filter Circuit/Coupling/Decoupling/For Step-up
High Q Chip Multilayer Ceramic Capacitors for General Purpose	GQM / GJM Series	High Frequency Filter Circuit
Soft Termination Chip Multilayer Ceramic Capacitors for General Purpose	GRJ Series	Coupling/Decoupling/For Step-up
3 Terminals Low ESL Chip Multilayer Ceramic Capacitors for General Purpose	NFM Series	Noise Suppression/Decoupling
Polymer Aluminum Electrolytic Capacitors	ECAS Series	Smoothing /Transient Backup
Chip Inductors (Chip Coils)	LQW/LQP/LQG Series	High Frequency Circuit-Impedance Matching /Resonance
Chip Inductors (Chip Coils)	LQM/LQH/DFE Series	Voltage Conversion
Chip Ferrite Beads	BLM/NFZ Series	Noise Suppression
Feed Through Chip EMI Filters	NFE Series	Noise Suppression
Chip Common Mode Choke Coils/Common Mode Noise Filters	DLW/DLM Series	Noise Suppression
Piezoelectric Sounders	PKLCS/PKMCS Series	Sound Component
Coin Manganese Dioxide Lithium Batteries	Standard Type	Battery Backup

Lighting

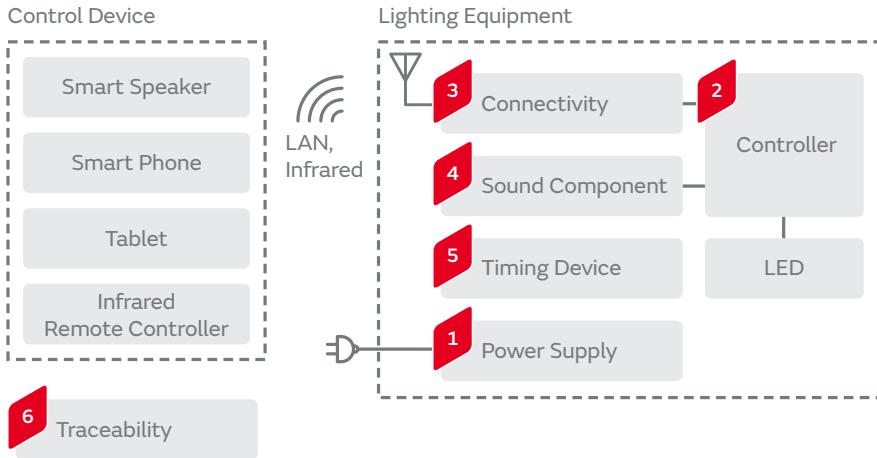

1 Power Supply

Ballast for LED Lighting



2 Controller

Chip Multilayer Ceramic Capacitors for General Purpose GR/GA Series



Safety Standard Certified Resin Molding SMD Type Ceramic Capacitors for General Purpose DK1 Series



Safety Standard Certified Lead Type Disc Ceramic Capacitors for General Purpose DE1/DE2 Series



Thermistors NCP/PRF/PRG Series



3 Connectivity

Wi-Fi Modules



LPWA Modules



Microwave Coaxial Connectors with Switch



4 Sound Component

Piezoelectric Sounders PKLCS/PKMCS Series



5 Timing Device

Crystal Units XRC Series



MEMS Resonators WMRAG Series



Ceramic Resonators CERALOCK CST Series



6 Traceability

RFID Tag LXMS/LXTB Series



General Purpose	Chip Multilayer Ceramic Capacitors for General Purpose	GRM Series	High Frequency Filter Circuit/Coupling/Decoupling/For Step-up
	High Q Chip Multilayer Ceramic Capacitors for General Purpose	GQM / GJM Series	High Frequency Filter Circuit
	Soft Termination Chip Multilayer Ceramic Capacitors for General Purpose	GRJ Series	Coupling/Decoupling/For Step-up
	3 Terminals Low ESL Chip Multilayer Ceramic Capacitors for General Purpose	NFM Series	Noise Suppression/Decoupling
	Polymer Aluminum Electrolytic Capacitors	ECAS Series	Smoothing /Transient Backup
	Chip Inductors (Chip Coils)	LQW/LQP/LQG Series	High Frequency Circuit-Impedance Matching /Resonance
	Chip Inductors (Chip Coils)	LQM/LQH/DFE Series	Voltage Conversion
	Chip Ferrite Beads	BLM/NFZ Series	Noise Suppression
	Feed Through Chip EMI Filters	NFE Series	Noise Suppression
	Chip Common Mode Choke Coils/Common Mode Noise Filters	DLW/DLM Series	Noise Suppression
	Piezoelectric Sounders	PKLCS/PKMCS Series	Sound Component
	Coin Manganese Dioxide Lithium Batteries	Standard Type	Battery Backup

Thermostat

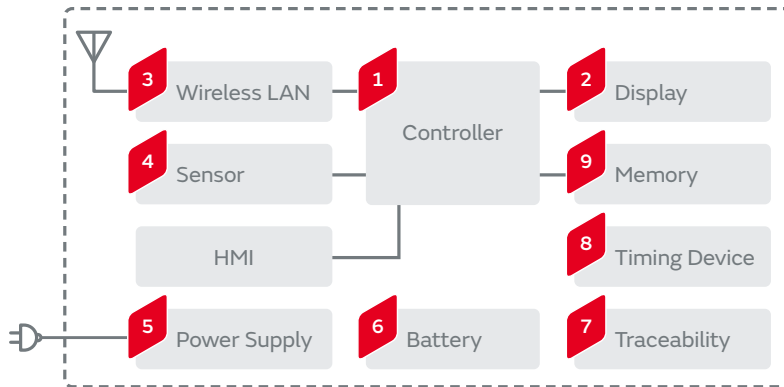

1 Controller

Low ESL Chip Multilayer Ceramic Capacitors for General Purpose LLL/LLA/LLM Series



Thermistors NCP/PRF Series



3 Wireless LAN

Bluetooth® Modules



LPWA Modules



Wi-Fi Modules



Chip Inductors (Chip Coils) LQM/LQH/LQB Series



Microwave Coaxial Connectors with Switch



2 Display

Metal Terminal Type Multilayer Ceramic Capacitors for General Purpose KRM Series



Polymer Aluminum Electrolytic Capacitors ECAS Series



Piezoelectric Sounders PKMCS/PKLCs/PKM Series



Thermistors NCP/PRF Series



4 Sensor

Thermistors NCP/PRF/PRG Series



5 Power Supply

Chip Multilayer Ceramic Capacitors for General Purpose GR/GA Series



Safety Standard Certified Resin Molding SMD Type Ceramic Capacitors for General Purpose DK1 Series



Safety Standard Certified Lead Type Disc Ceramic Capacitors for General Purpose DE1/DE2 Series



Thermistors NCP/PRF/PRG Series



Polymer Aluminum Electrolytic Capacitors ECAS Series



6

Battery

Thermistors
NCP/PRF/PRG Series



Laminated Type
Lithium Ion Secondary Batteries



7

Traceability

RFID Tag
LXMS/LXTB Series



8

Timing Device

Crystal Units
XRC Series



MEMS Resonators
WMRAG Series



Ceramic Resonators CERALOCK
CST Series



9

Memory

Chip Ferrite Beads
BLM Series



General Purpose

Chip Multilayer Ceramic Capacitors for General Purpose	GRM Series	High Frequency Filter Circuit/Coupling/Decoupling/For Step-up
High Q Chip Multilayer Ceramic Capacitors for General Purpose	GQM / GJM Series	High Frequency Filter Circuit
Soft Termination Chip Multilayer Ceramic Capacitors for General Purpose	GRJ Series	Coupling/Decoupling/For Step-up
3 Terminals Low ESL Chip Multilayer Ceramic Capacitors for General Purpose	NFM Series	Noise Suppression/Decoupling
Polymer Aluminum Electrolytic Capacitors	ECAS Series	Smoothing /Transient Backup
Chip Inductors (Chip Coils)	LQW/LQP/LQG Series	High Frequency Circuit-Impedance Matching /Resonance
Chip Inductors (Chip Coils)	LQM/LQH/DFE Series	Voltage Conversion
Chip Ferrite Beads	BLM/NFZ Series	Noise Suppression
Feed Through Chip EMI Filters	NFE Series	Noise Suppression
Chip Common Mode Choke Coils/Common Mode Noise Filters	DLW/DLM Series	Noise Suppression
Piezoelectric Sounders	PKLCS/PKMCS Series	Sound Component
Coin Manganese Dioxide Lithium Batteries	Standard Type	Battery Backup

Security camera

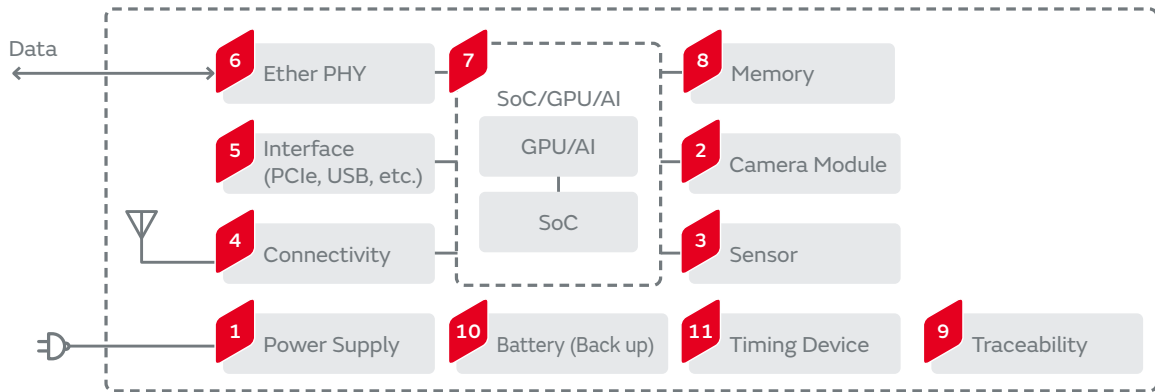

1 Power Supply

Metal Terminal Type Multilayer Ceramic Capacitors for General Purpose KRM Series 	Polymer Aluminum Electrolytic Capacitors ECAS Series
Power Inductors LQH/DFE Series 	Thermistors NCP/NCU/PRF Series
Isolated DC-DC Converters for PoE+PD MYBSP Series 	Laminated Type Lithium Ion Secondary Batteries
	Silicon ESD Protection Devices LXES**T Series

2 Camera Module

Chip Ferrite Beads BLM Series 	Thermistors NCP/NCU Series
--------------------------------------	-----------------------------------

3 Sensor

Pyroelectric Infrared Sensors IRA-S Series 	Ultrasonic Sensors MA40 Series
Low Acoustic Noise Chip Multilayer Ceramic Capacitors on Interposer Board for General Purpose ZRB Series 	Thermistors NCP/NCU Series

4 Connectivity

Wi-Fi Modules 	Chip Inductors (Chip Coils) LQW/LQP/LQG Series
Chip Multilayer LC Filters LF Series 	Chip Multilayer Diplexers LFD Series
Chip Multilayer Hybrid Couplers LDC/LDJ Series 	Chip Multilayer Hybrid Baluns LDB/LDM Series
	LPWA Modules

5 Interface (PCIe, USB, etc.)

- Low ESL Chip Multilayer Ceramic Capacitors for General Purpose LLL/LLA/LLM Series
- Silicon ESD Protection Devices LXES**T Series
- Chip Common Mode Choke Coils/ Common Mode Noise Filters DLW/NFG/DLM Series

6 Ether PHY

- Low ESL Chip Multilayer Ceramic Capacitors for General Purpose LLL/LLA/LLM Series
- Silicon ESD Protection Devices LXES**T Series
- Chip Common Mode Choke Coils/ Common Mode Noise Filters DLW/NFG/DLM Series

7 SoC/GPU/AI

- 3 Terminals Low ESL Chip Multilayer Ceramic Capacitors for General Purpose NFM Series
- Thermistors NCP/NCU Series

8 Memory

- Chip Ferrite Beads BLM Series

9 Traceability

- RFID Tag LXMS/LXTB Series

10 Battery (Back Up)

- Coin Manganese Dioxide Lithium Batteries Standard Type/Heat-resistant Type

11 Timing Device

- MEMS Resonators WMRAG Series
- Crystal Units XRC Series
- Ceramic Resonators CERALOCK CST Series

General Purpose	Chip Multilayer Ceramic Capacitors for General Purpose	GRM Series	High Frequency Filter Circuit/Coupling/Decoupling/For Step-up
	High Q Chip Multilayer Ceramic Capacitors for General Purpose	GQM / GJM Series	High Frequency Filter Circuit
	Soft Termination Chip Multilayer Ceramic Capacitors for General Purpose	GRJ Series	Coupling/Decoupling/For Step-up
	3 Terminals Low ESL Chip Multilayer Ceramic Capacitors for General Purpose	NFM Series	Noise Suppression/Decoupling
	Polymer Aluminum Electrolytic Capacitors	ECAS Series	Smoothing /Transient Backup
	Chip Inductors (Chip Coils)	LQW/LQP/LQG Series	High Frequency Circuit-Impedance Matching /Resonance
	Chip Inductors (Chip Coils)	LQM/LQH/DFE Series	Voltage Conversion
	Chip Ferrite Beads	BLM/NFZ Series	Noise Suppression
	Feed Through Chip EMI Filters	NFE Series	Noise Suppression
	Chip Common Mode Choke Coils/Common Mode Noise Filters	DLW/DLM Series	Noise Suppression
	Piezoelectric Sounders	PKLCS/PKMCS Series	Sound Component
	Coin Manganese Dioxide Lithium Batteries	Standard Type	Battery Backup

HEMS (Home energy management system)

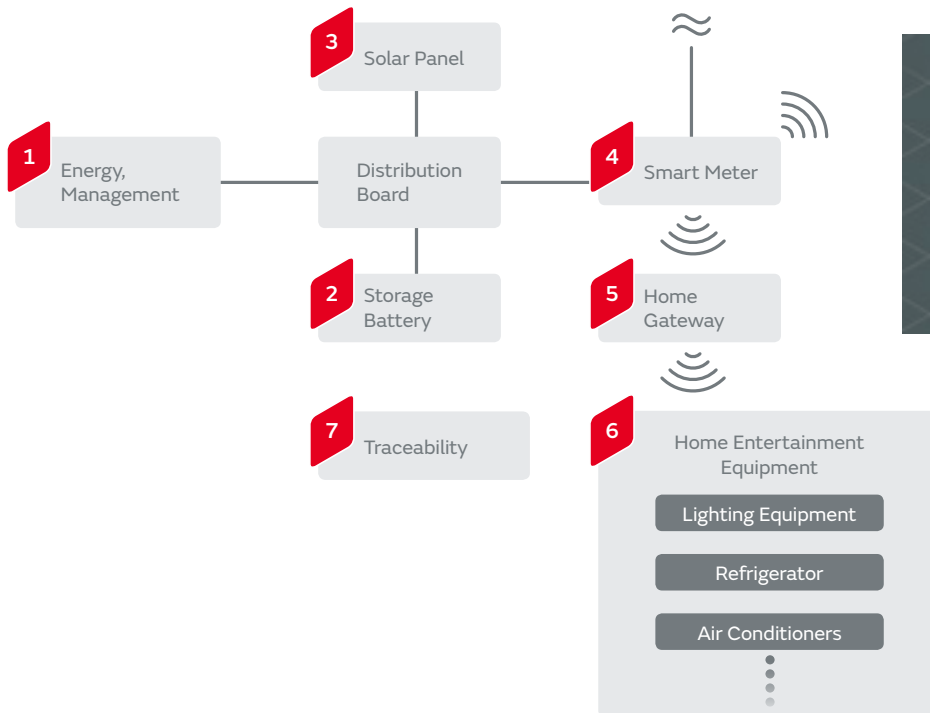

1 Energy, Management

Crystal Units
XRC Series

2 Storage Battery

<p>Thermistors PRF/PRG/NCU Series</p>	<p>Isolated DC-DC Converters MYB Series</p>
<p>Non-Isolated DC-DC Converters MYMGK/MYSGK/OKL/MYLSM Series</p>	<p>Chip Multilayer Ceramic Capacitors for General Purpose GR/GA Series</p>
<p>Safety Standard Certified Resin Molding SMD Type Ceramic Capacitors for General Purpose DK1 Series</p>	<p>Safety Standard Certified Lead Type Disc Ceramic Capacitors for General Purpose DE1/DE2 Series</p>
<p>FORTELION 2.1kWh Battery Module System IJ1101M/IJ8101C/IJ1101k</p>	<p>Cylindrical Type Lithium Ion Secondary Batteries</p>















3 Solar Panel

Isolated DC-DC Converters
MYB Series





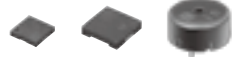

Non-Isolated DC-DC Converters
MYMGK/MYSGK/OKL/MYLSM Series

Chip Multilayer Ceramic Capacitors for General Purpose
GR/GA Series









4 Smart Meter

<p>Chip Multilayer LC Filters LF Series</p> 	<p>Chip Multilayer Hybrid Baluns LDB/LDM Series</p> 	<p>Wi-Fi Modules</p> 	<p>LPWA Modules</p> 	<p>Isolated DC-DC Converters MYB Series</p> 
<p>Non-Isolated DC-DC Converters MYMGK/MYSGK/OKL/MYLSM Series</p> 	<p>Isolated DC-DC Converters for PoE + PD MYBSP Series</p> 	<p>Chip Multilayer Ceramic Capacitors for Ethernet LAN and Primary - Secondary Coupling of DC-DC Converters GR4 Series</p> 		
<p>MEMS Resonators WMRAG Series</p> 	<p>Safety Standard Certified Resin Molding SMD Type Ceramic Capacitors for General Purpose DK1 Series</p> 	<p>Safety Standard Certified Lead Type Disc Ceramic Capacitors for General Purpose DE1/DE2 Series</p> 	<p>Ceramic Resonators CERALOCK CST Series</p> 	
<p>Crystal Units XRC Series</p> 	<p>Piezoelectric Sounders PKMCS/PKLCS/PKM Series</p> 	<p>Coin Manganese Dioxide Lithium Batteries Heat-resistant Type/Extended Temperature Type</p> 	<p>Microwave Coaxial Connectors with Switch</p> 	

5 Home Gateway

<p>Wi-Fi Modules</p> 	<p>Bluetooth® Modules</p> 	<p>LPWA Modules</p> 	<p>Microwave Coaxial Connectors with Switch</p> 
<p>Isolated DC-DC Converters for PoE + PD MYBSP Series</p> 	<p>Crystal Units XRC Series</p> 	<p>MEMS Resonators WMRAG Series</p> 	

6 Home Entertainment Equipment

<p>Bluetooth® Modules</p> 	<p>Wi-Fi Modules</p> 	<p>LPWA Modules</p> 
<p>Ultrasonic Sensors MA40 Series</p> 	<p>Magnetic Sensors (AMR Sensors) MR Series</p> 	
<p>Isolated DC-DC Converters MYB Series</p> 	<p>Non-Isolated DC-DC Converters MYMGK/MYSGK/OKL/MYLSM Series</p> 	
<p>Crystal Units XRC Series</p> 	<p>MEMS Resonators WMRAG Series</p> 	

7 Traceability

RFID Tag
LXMS/LXTB Series



General Purpose	Chip Multilayer Ceramic Capacitors for General Purpose	GRM Series	High Frequency Filter Circuit/Coupling/Decoupling/For Step-up
	High Q Chip Multilayer Ceramic Capacitors for General Purpose	GQM / GJM Series	High Frequency Filter Circuit
	Soft Termination Chip Multilayer Ceramic Capacitors for General Purpose	GRJ Series	Coupling/Decoupling/For Step-up
	3 Terminals Low ESL Chip Multilayer Ceramic Capacitors for General Purpose	NFM Series	Noise Suppression/Decoupling
	Polymer Aluminum Electrolytic Capacitors	ECAS Series	Smoothing /Transient Backup
	Chip Inductors (Chip Coils)	LQW/LQP/LQG Series	High Frequency Circuit-Impedance Matching /Resonance
	Chip Inductors (Chip Coils)	LQM/LQH/DFE Series	Voltage Conversion
	Chip Ferrite Beads	BLM/NFZ Series	Noise Suppression
	Feed Through Chip EMI Filters	NFE Series	Noise Suppression
	Chip Common Mode Choke Coils/Common Mode Noise Filters	DLW/DLM Series	Noise Suppression
	Piezoelectric Sounders	PKLCS/PKMCS Series	Sound Component
	Coin Manganese Dioxide Lithium Batteries	Standard Type	Battery Backup

Entrance and exit management system

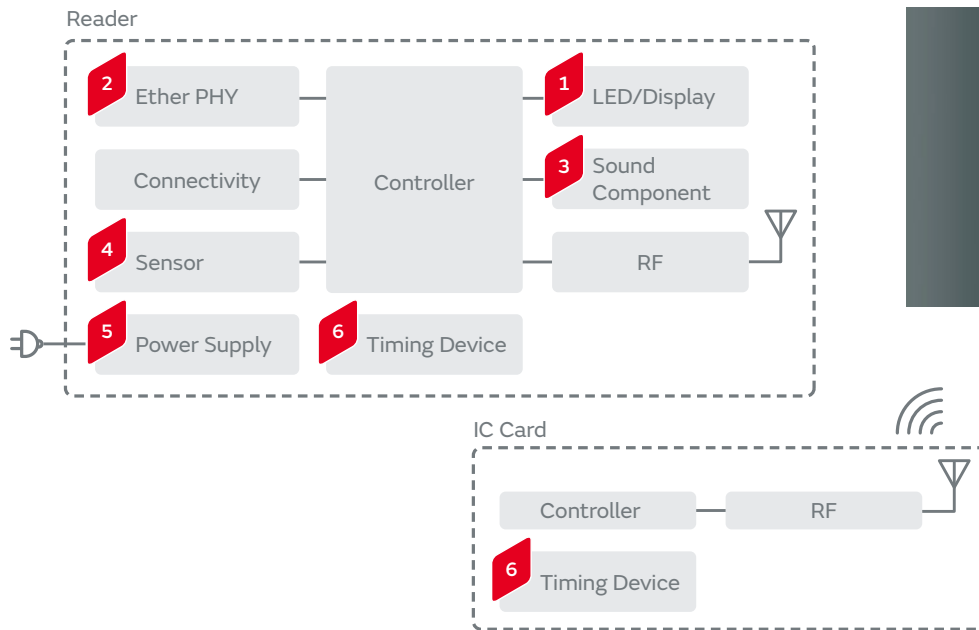

1 LED/Display

- Silicon ESD Protection Devices LXES**T Series
- Thermistors NCP/PRF Series

2 Ether PHY

- Silicon ESD Protection Devices LXES**T Series
- Thermistors PRG Series

3 Sound Component

- Piezoelectric Sounders PKMCS/PKLCS/PKM Series

4 Sensor

- Ultrasonic Sensors MA40 Series
- Magnetic Sensors (AMR Sensors) MR Series
- Pyroelectric Infrared Sensors IRA-S Series

5 Power Supply

Polymer Aluminum Electrolytic Capacitors ECAS Series



Metal Terminal Type Multilayer Ceramic Capacitors for General Purpose KRM Series



Non-Isolated DC-DC Converters MYMGK/MYSGK/OKL/MYLS M Series



Isolated DC-DC Converters for PoE + PD MYBSP Series



Thermistors NCP/PRF Series



Chip Multilayer Ceramic Capacitors for General Purpose GR/GA Series



Safety Standard Certified Resin Molding SMD Type Ceramic Capacitors for General Purpose DK1 Series



Safety Standard Certified Lead Type Disc Ceramic Capacitors for General Purpose DE1/DE2 Series



6 Timing Device

Crystal Units XRC Series



Ceramic Resonators CERALOCK CST Series



General Purpose

Chip Multilayer Ceramic Capacitors for General Purpose	GRM Series	High Frequency Filter Circuit/Coupling/Decoupling/For Step-up
High Q Chip Multilayer Ceramic Capacitors for General Purpose	GQM / GJM Series	High Frequency Filter Circuit
Soft Termination Chip Multilayer Ceramic Capacitors for General Purpose	GRJ Series	Coupling/Decoupling/For Step-up
3 Terminals Low ESL Chip Multilayer Ceramic Capacitors for General Purpose	NFM Series	Noise Suppression/Decoupling
Polymer Aluminum Electrolytic Capacitors	ECAS Series	Smoothing /Transient Backup
Chip Inductors (Chip Coils)	LQW/LQP/LQG Series	High Frequency Circuit-Impedance Matching /Resonance
Chip Inductors (Chip Coils)	LQM/LQH/DFE Series	Voltage Conversion
Chip Ferrite Beads	BLM/NFZ Series	Noise Suppression
Feed Through Chip EMI Filters	NFE Series	Noise Suppression
Chip Common Mode Choke Coils/Common Mode Noise Filters	DLW/DLM Series	Noise Suppression
Piezoelectric Sounders	PKLCS/PKMCS Series	Sound Component
Coin Manganese Dioxide Lithium Batteries	Standard Type	Battery Backup

Human detection

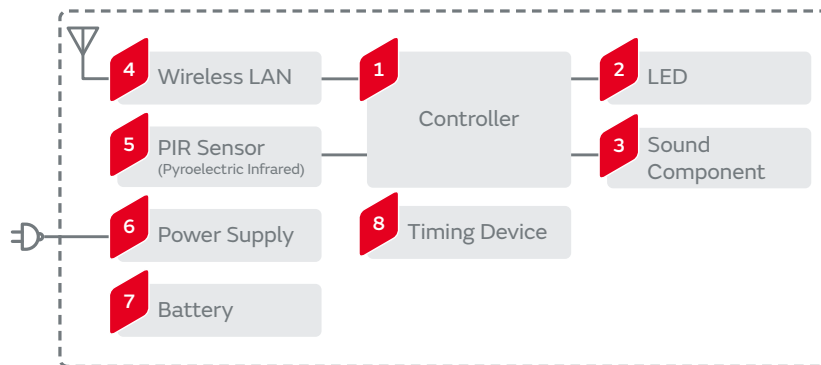

1 Controller

Low ESL Chip Multilayer Ceramic Capacitors for General Purpose
LLL/LLA/LLM Series



Thermistors
NCP/PRF Series



2 LED

Chip Multilayer Ceramic Capacitors for General Purpose
GR/GA Series



Safety Standard Certified Resin Molding SMD Type Ceramic Capacitors for General Purpose
DK1 Series



Safety Standard Certified Lead Type Disc Ceramic Capacitors for General Purpose
DE1/DE2 Series



Thermistors
NCP/PRF/PRG Series



3 Sound Component

Piezoelectric Sounders
PKMCS/PKLCS/PKM Series



4 Wireless LAN

Wi-Fi Modules



Chip Inductors (Chip Coils)
LQW/LQP/LQG Series



5 PIR Sensor (Pyroelectric Infrared)

Pyroelectric Infrared Sensors
IRA-S Series





Ultrasonic Sensors
MA40 Series





6 Power Supply

Chip Multilayer Ceramic Capacitors for General Purpose GR/GA Series 

Safety Standard Certified Resin Molding SMD Type Ceramic Capacitors for General Purpose DK1 Series 

Safety Standard Certified Lead Type Disc Ceramic Capacitors for General Purpose DE1/DE2 Series 

Chip Common Mode Choke Coils/ Common Mode Noise Filters DLW/DLM Series 

Thermistors NCP/PRF/PRG Series 

Polymer Aluminum Electrolytic Capacitors ECAS Series 

Isolated DC-DC Converters for PoE + PD MYBSP Series 

7 Battery

Coin Manganese Dioxide Lithium Batteries Standard Type 

Thermistors NCP/PRF/PRG Series 

8 Timing Device

Crystal Units XRC Series 

Ceramic Resonators CERALOCK CST Series 

General Purpose	Chip Multilayer Ceramic Capacitors for General Purpose	GRM Series	High Frequency Filter Circuit/Coupling/Decoupling/For Step-up
	High Q Chip Multilayer Ceramic Capacitors for General Purpose	GQM / GJM Series	High Frequency Filter Circuit
	Soft Termination Chip Multilayer Ceramic Capacitors for General Purpose	GRJ Series	Coupling/Decoupling/For Step-up
	3 Terminals Low ESL Chip Multilayer Ceramic Capacitors for General Purpose	NFM Series	Noise Suppression/Decoupling
	Polymer Aluminum Electrolytic Capacitors	ECAS Series	Smoothing /Transient Backup
	Chip Inductors (Chip Coils)	LQW/LQP/LQG Series	High Frequency Circuit-Impedance Matching /Resonance
	Chip Inductors (Chip Coils)	LQM/LQH/DFE Series	Voltage Conversion
	Chip Ferrite Beads	BLM/NFZ Series	Noise Suppression
	Feed Through Chip EMI Filters	NFE Series	Noise Suppression
	Chip Common Mode Choke Coils/Common Mode Noise Filters	DLW/DLM Series	Noise Suppression
	Piezoelectric Sounders	PKLCS/PKMCS Series	Sound Component
	Coin Manganese Dioxide Lithium Batteries	Standard Type	Battery Backup

Smart meter

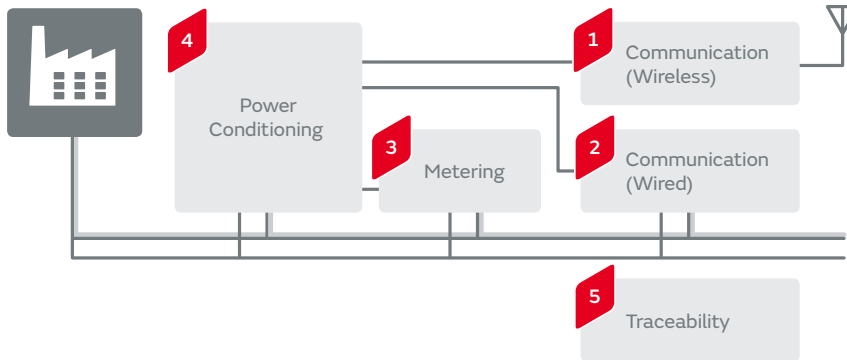

1 Communication (Wireless)

<p>Wi-Fi Modules</p>	<p>LPWA Modules</p>	<p>Chip Multilayer LC Filters LF Series</p>	<p>Chip Multilayer Hybrid Baluns LDB/LDM Series</p>	<p>Microwave Coaxial Connectors with Switch</p>
<p>Thermistors NCP/PRF/PRG/NCU Series</p>	<p>Crystal Units XRC Series</p>	<p>Chip Inductors (Chip Coils) LQW/LQP/LQG Series</p>	<p>MEMS Resonators WMRAG Series</p>	

2 Communication (Wired)

<p>Chip Multilayer Ceramic Capacitors for General Purpose GR/GA Series</p>	<p>Safety Standard Certified Resin Molding SMD Type Ceramic Capacitors for General Purpose DK1 Series</p>
<p>Safety Standard Certified Lead Type Disc Ceramic Capacitors for General Purpose DE1/DE2 Series</p>	<p>Leaded MLCC for General Purpose RDE Series</p>
<p>Thermistors NCP/PRF/PRG/NCU Series</p>	<p>Ceramic Resonators CERALOCK CST Series</p>
<p>Crystal Units XRC Series</p>	<p>Silicon ESD Protection Devices LXES**T Series</p>

3 Metering

<p>Chip Common Mode Choke Coils/ Common Mode Noise Filters DLW/DLM Series</p>	<p>Thermistors NCP/PRF/PRG/NCU Series</p>
<p>Ceramic Resonators CERALOCK CST Series</p>	<p>Crystal Units XRC Series</p>
<p>Piezoelectric Sounders PKMCS/PKLCs/PKM Series</p>	<p>Magnetic Sensors (AMR Sensors) MR Series</p>
<p>MEMS Resonators WMRAG Series</p>	

4 Power Conditioning

Non-Isolated DC-DC Converters
MYMGK/MYSGK/
OKL/MYSLM Series



Isolated DC-DC Converters
for PoE + PD
MYBSP Series



Chip Multilayer
Ceramic Capacitors
for General Purpose
GR/GA Series



Safety Standard Certified Resin
Molding SMD Type Ceramic
Capacitors for General Purpose
DK1 Series



Safety Standard Certified Lead Type Disc
Ceramic Capacitors for General Purpose
DE1/DE2 Series



Leaded MLCC
for General Purpose
RDE Series



Power Inductors
LQH Series



Thermistors
NCP/PRF/PRG/NCU Series



Polymer Aluminum
Electrolytic Capacitors
ECAS Series



Coin Manganese Dioxide Lithium Batteries
Heat-resistant Type/Extended Temperature Type



5 Traceability

RFID Tag
LXMS/LXTB Series



General Purpose

Chip Multilayer Ceramic Capacitors for General Purpose	GRM Series	High Frequency Filter Circuit/Coupling/Decoupling/For Step-up
High Q Chip Multilayer Ceramic Capacitors for General Purpose	GQM / GJM Series	High Frequency Filter Circuit
Soft Termination Chip Multilayer Ceramic Capacitors for General Purpose	GRJ Series	Coupling/Decoupling/For Step-up
3 Terminals Low ESL Chip Multilayer Ceramic Capacitors for General Purpose	NFM Series	Noise Suppression/Decoupling
Polymer Aluminum Electrolytic Capacitors	ECAS Series	Smoothing /Transient Backup
Chip Inductors (Chip Coils)	LQW/LQP/LQG Series	High Frequency Circuit-Impedance Matching /Resonance
Chip Inductors (Chip Coils)	LQM/LQH/DFE Series	Voltage Conversion
Chip Ferrite Beads	BLM/NFZ Series	Noise Suppression
Feed Through Chip EMI Filters	NFE Series	Noise Suppression
Chip Common Mode Choke Coils/Common Mode Noise Filters	DLW/DLM Series	Noise Suppression
Piezoelectric Sounders	PKLCS/PKMCS Series	Sound Component
Coin Manganese Dioxide Lithium Batteries	Standard Type	Battery Backup

Blood pressure monitor

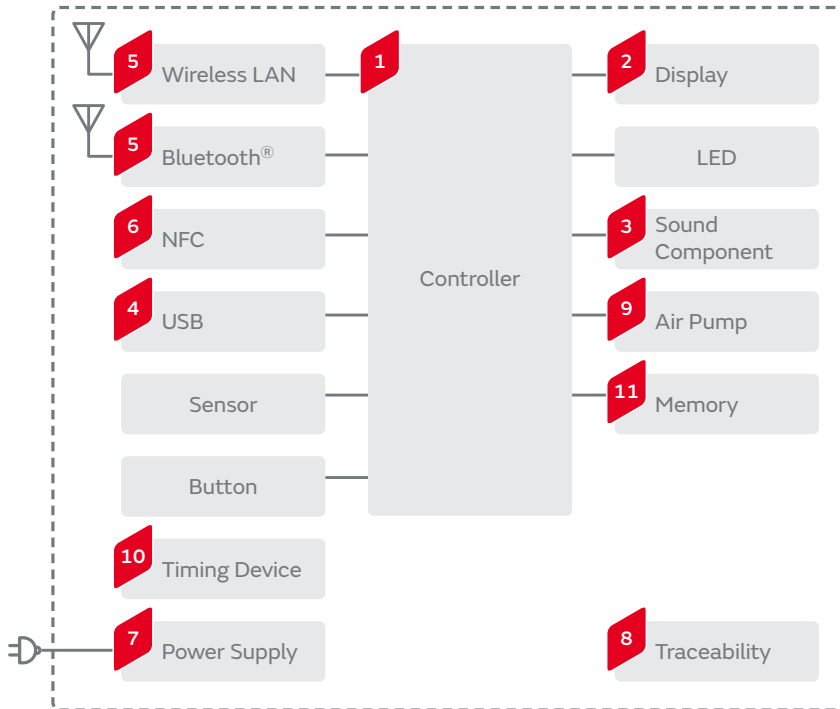

1 Controller

Chip Ferrite Beads BLM Series	Thermistors NCP Series	Thermistors NCP/NXR Series

2 Display

3 Terminals Low ESL Chip Multilayer Ceramic Capacitors for General Purpose NFM Series	Chip Ferrite Beads BLM Series	Thermistors NCP Series

3 Sound Component

Piezoelectric Sounders PKMCS/PKLCs/PKM Series

4 USB

Silicon ESD Protection Devices LXES**T Series	Thermistors PRG Series

6 NFC

Chip Ferrite Beads BLM Series	Chip Inductors (Chip Coils) LQW18C/LQM18J Series

5 Wireless LAN, Bluetooth®

Silicon ESD Protection Devices LXES**T Series	Bluetooth® Smart Modules LBCA/LBMA Series	Wi-Fi Modules	Thermistors PRG Series

7 Power Supply

Thermistors
NCP Series



Thermistors
PRF/PRG Series



Coin Manganese Dioxide
Lithium Batteries
Standard Type



Polymer Aluminum
Electrolytic Capacitors
ECAS Series



8 Traceability

RFID Tag
LXMS/LXTB Series



9 Air Pump

Microblowers

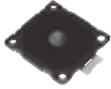

10 Timing Device

MEMS Resonators
WMRAG Series



Crystal Units
XRC Series



Ceramic Resonators
CERALOCK
CST Series



11 Memory

Chip Ferrite Beads
BLM Series



General Purpose

Chip Multilayer Ceramic Capacitors for General Purpose	GRM Series	High Frequency Filter Circuit/Coupling/Decoupling/For Step-up
High Q Chip Multilayer Ceramic Capacitors for General Purpose	GQM / GJM Series	High Frequency Filter Circuit
Soft Termination Chip Multilayer Ceramic Capacitors for General Purpose	GRJ Series	Coupling/Decoupling/For Step-up
3 Terminals Low ESL Chip Multilayer Ceramic Capacitors for General Purpose	NFM Series	Noise Suppression/Decoupling
Polymer Aluminum Electrolytic Capacitors	ECAS Series	Smoothing /Transient Backup
Chip Inductors (Chip Coils)	LQW/LQP/LQG Series	High Frequency Circuit-Impedance Matching /Resonance
Chip Inductors (Chip Coils)	LQM/LQH/DFE Series	Voltage Conversion
Chip Ferrite Beads	BLM/NFZ Series	Noise Suppression
Feed Through Chip EMI Filters	NFE Series	Noise Suppression
Chip Common Mode Choke Coils/Common Mode Noise Filters	DLW/DLM Series	Noise Suppression
Piezoelectric Sounders	PKLCS/PKMCS Series	Sound Component
Coin Manganese Dioxide Lithium Batteries	Standard Type	Battery Backup

Thermometer

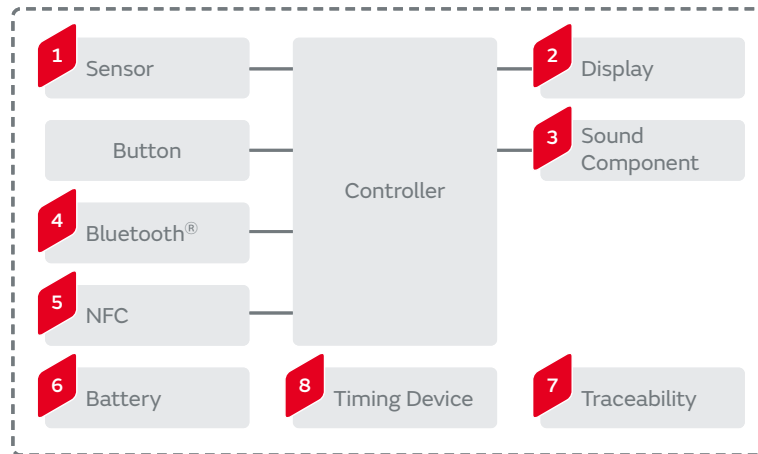

1 Sensor Thermistors NXF Series 	2 Display Thermistors NCP Series 	3 Sound Component Piezoelectric Sounders PKLCS/PKMCS Series 	4 Bluetooth® Bluetooth® Smart Modules LBCA/LBMA Series
5 NFC Chip Ferrite Beads BLM Series 		6 Battery Coin Manganese Dioxide Lithium Batteries Standard Type 	
7 Traceability RFID Tag LXMS/LXTB Series 		8 Timing Device Crystal Units XRC Series 	
		Ceramic Resonators CERALOCK CST Series 	

Chip Multilayer Ceramic Capacitors for General Purpose	GRM Series	High Frequency Filter Circuit/Coupling/Decoupling/For Step-up
High Q Chip Multilayer Ceramic Capacitors for General Purpose	GQM / GJM Series	High Frequency Filter Circuit
Soft Termination Chip Multilayer Ceramic Capacitors for General Purpose	GRJ Series	Coupling/Decoupling/For Step-up
3 Terminals Low ESL Chip Multilayer Ceramic Capacitors for General Purpose	NFM Series	Noise Suppression/Decoupling
Polymer Aluminum Electrolytic Capacitors	ECAS Series	Smoothing /Transient Backup
Chip Inductors (Chip Coils)	LQW/LQP/LQG Series	High Frequency Circuit-Impedance Matching /Resonance
Chip Inductors (Chip Coils)	LQM/LQH/DFE Series	Voltage Conversion
Chip Ferrite Beads	BLM/NFZ Series	Noise Suppression
Feed Through Chip EMI Filters	NFE Series	Noise Suppression
Chip Common Mode Choke Coils/Common Mode Noise Filters	DLW/DLM Series	Noise Suppression
Piezoelectric Sounders	PKLCS/PKMCS Series	Sound Component
Coin Manganese Dioxide Lithium Batteries	Standard Type	Battery Backup

Hearing aid

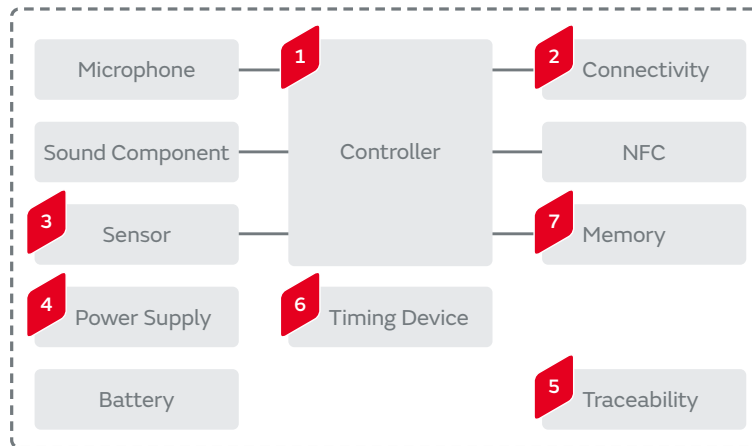
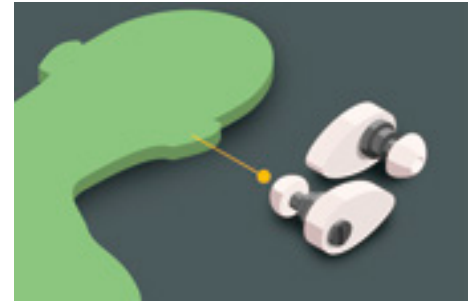

1 Controller

Thermistors
NCP Series



2 Connectivity

Bluetooth® Modules



Wi-Fi Modules



Thermistors
NCP Series



Chip Multilayer LC Filters
LF Series



3 Sensor

Thermistors
NCP Series



4 Power Supply

Thermistors
NCP Series



5 Traceability

RFID Tag
LXMS/LXTB Series



6 Timing Device

MEMS Resonators
WMRAG Series



Crystal Units
XRC Series



7 Memory

Chip Ferrite Beads
BLM Series



General Purpose

Chip Multilayer Ceramic Capacitors for General Purpose	GRM Series	High Frequency Filter Circuit/Coupling/Decoupling/For Step-up
High Q Chip Multilayer Ceramic Capacitors for General Purpose	GQM / GJM Series	High Frequency Filter Circuit
Soft Termination Chip Multilayer Ceramic Capacitors for General Purpose	GRJ Series	Coupling/Decoupling/For Step-up
3 Terminals Low ESL Chip Multilayer Ceramic Capacitors for General Purpose	NFM Series	Noise Suppression/Decoupling
Polymer Aluminum Electrolytic Capacitors	ECAS Series	Smoothing /Transient Backup
Chip Inductors (Chip Coils)	LQW/LQP/LQG Series	High Frequency Circuit-Impedance Matching /Resonance
Chip Inductors (Chip Coils)	LQM/LQH/DFE Series	Voltage Conversion
Chip Ferrite Beads	BLM/NFZ Series	Noise Suppression
Feed Through Chip EMI Filters	NFE Series	Noise Suppression
Chip Common Mode Choke Coils/Common Mode Noise Filters	DLW/DLM Series	Noise Suppression
Piezoelectric Sounders	PKLCS/PKMCS Series	Sound Component
Coin Manganese Dioxide Lithium Batteries	Standard Type	Battery Backup

Blood glucose meter

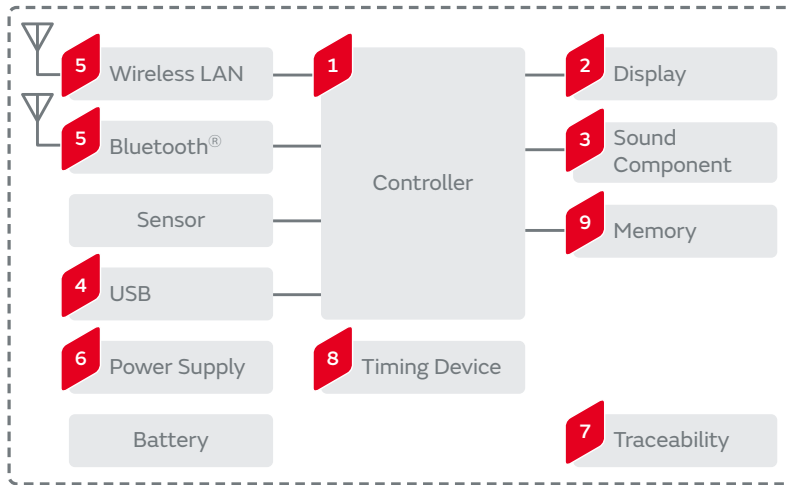

3 Sound Component

Piezoelectric Sounders
PKLCS/PKMCS Series

4 USB

Thermistors
PRG Series

Silicon ESD Protection Devices
LXES**T Series

1 Controller

Chip Ferrite Beads
BLM Series

Thermistors
NCP Series

2 Display

3 Terminals Low ESL Chip
Multilayer Ceramic Capacitors
for General Purpose
NFM Series

Chip Ferrite Beads
BLM Series

5 Wireless LAN, Bluetooth®

Bluetooth® Smart Modules
LBCA/LBMA Series

Wi-Fi Modules

Thermistors
NCP Series

6 Power Supply

Coin Manganese Dioxide
Lithium Batteries
Standard Type

Thermistors
NCP Series

Polymer Aluminum
Electrolytic Capacitors
ECAS Series

7 Traceability

RFID Tag
LXMS/LXTB Series

8 Timing Device

MEMS Resonators
WMRAG Series

Crystal Units
XRC Series

Ceramic Resonators CERALOCK
CST Series

9 Memory

Chip Ferrite Beads
BLM Series

General Purpose

Chip Multilayer Ceramic Capacitors for General Purpose	GRM Series	High Frequency Filter Circuit/Coupling/Decoupling/For Step-up
High Q Chip Multilayer Ceramic Capacitors for General Purpose	GQM / GJM Series	High Frequency Filter Circuit
Soft Termination Chip Multilayer Ceramic Capacitors for General Purpose	GRJ Series	Coupling/Decoupling/For Step-up
3 Terminals Low ESL Chip Multilayer Ceramic Capacitors for General Purpose	NFM Series	Noise Suppression/Decoupling
Polymer Aluminum Electrolytic Capacitors	ECAS Series	Smoothing /Transient Backup
Chip Inductors (Chip Coils)	LQW/LQP/LQG Series	High Frequency Circuit-Impedance Matching /Resonance
Chip Inductors (Chip Coils)	LQM/LQH/DFE Series	Voltage Conversion
Chip Ferrite Beads	BLM/NFZ Series	Noise Suppression
Feed Through Chip EMI Filters	NFE Series	Noise Suppression
Chip Common Mode Choke Coils/Common Mode Noise Filters	DLW/DLM Series	Noise Suppression
Piezoelectric Sounders	PKLCS/PKMCS Series	Sound Component
Coin Manganese Dioxide Lithium Batteries	Standard Type	Battery Backup

Insulin pump



1 Sensor

Thermistors
NCP Series



2 Display

3 Terminals Low ESL
Chip Multilayer
Ceramic Capacitors
for General Purpose
NFM Series



Chip Ferrite Beads
BLM Series



3 Controller

Thermistors
NCP Series



4 Connectivity

Bluetooth® Smart Modules
LBCA/LBMA Series



Wi-Fi Modules



Thermistors
NCP Series



5 Power Supply

Thermistors
NCP Series



6 Battery

Alkaline Manganese
Batteries



7 Traceability

RFID Tag
LXMS/LXTB Series



8 Sound Component

Piezoelectric Sounders
PKLCS/PKMCS Series



9 Timing Device

MEMS Resonators
WMRAG Series



Crystal Units
XRC Series



Ceramic Resonators
CERALOCK
CST Series



10 Memory

Chip Ferrite Beads
BLM Series

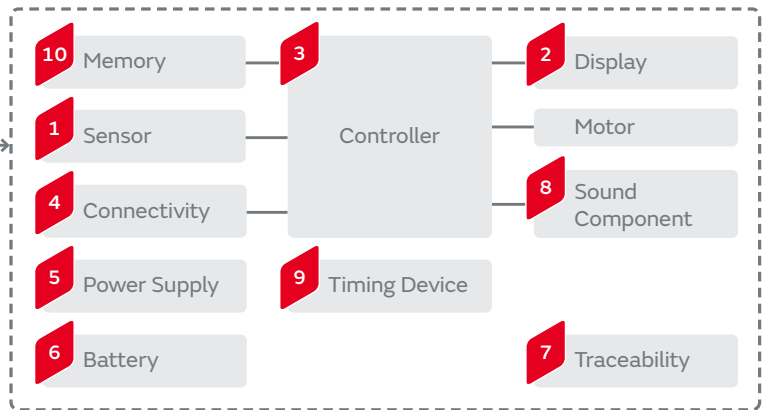
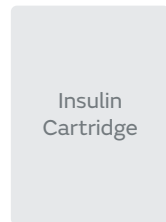

General Purpose

Chip Multilayer Ceramic Capacitors for General Purpose	GRM Series	High Frequency Filter Circuit/Coupling/Decoupling/For Step-up
High Q Chip Multilayer Ceramic Capacitors for General Purpose	GQM / GJM Series	High Frequency Filter Circuit
Soft Termination Chip Multilayer Ceramic Capacitors for General Purpose	GRJ Series	Coupling/Decoupling/For Step-up
3 Terminals Low ESL Chip Multilayer Ceramic Capacitors for General Purpose	NFM Series	Noise Suppression/Decoupling
Polymer Aluminum Electrolytic Capacitors	ECAS Series	Smoothing /Transient Backup
Chip Inductors (Chip Coils)	LQW/LQP/LQG Series	High Frequency Circuit-Impedance Matching /Resonance
Chip Inductors (Chip Coils)	LQM/LQH/DFE Series	Voltage Conversion
Chip Ferrite Beads	BLM/NFZ Series	Noise Suppression
Feed Through Chip EMI Filters	NFE Series	Noise Suppression
Chip Common Mode Choke Coils/Common Mode Noise Filters	DLW/DLM Series	Noise Suppression
Piezoelectric Sounders	PKLCS/PKMCS Series	Sound Component
Coin Manganese Dioxide Lithium Batteries	Standard Type	Battery Backup

Skin patch

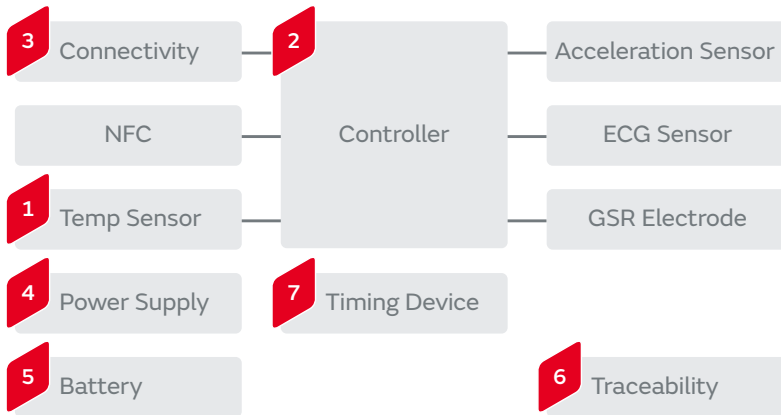

1 Temp Sensor Thermistors NCP/NXF Series 	2 Controller Thermistors NCP Series 	3 Connectivity Bluetooth® Smart Modules LBCA/LBMA Series Wi-Fi Modules Thermistors NCP Series 		
4 Power Supply Thermistors NCP Series 	5 Battery Coin Manganese Dioxide Lithium Batteries Standard Type 	6 Traceability RFID Tag LXMS/LXTB Series 	7 Timing Device MEMS Resonators WMRAG Series Crystal Units XRC Series 	

General Purpose	Chip Multilayer Ceramic Capacitors for General Purpose	GRM Series	High Frequency Filter Circuit/Coupling/Decoupling/For Step-up
	High Q Chip Multilayer Ceramic Capacitors for General Purpose	GQM / GJM Series	High Frequency Filter Circuit
	Soft Termination Chip Multilayer Ceramic Capacitors for General Purpose	GRJ Series	Coupling/Decoupling/For Step-up
	3 Terminals Low ESL Chip Multilayer Ceramic Capacitors for General Purpose	NFM Series	Noise Suppression/Decoupling
	Polymer Aluminum Electrolytic Capacitors	ECAS Series	Smoothing /Transient Backup
	Chip Inductors (Chip Coils)	LQW/LQP/LQG Series	High Frequency Circuit-Impedance Matching /Resonance
	Chip Inductors (Chip Coils)	LQM/LQH/DFE Series	Voltage Conversion
	Chip Ferrite Beads	BLM/NFZ Series	Noise Suppression
	Feed Through Chip EMI Filters	NFE Series	Noise Suppression
	Chip Common Mode Choke Coils/Common Mode Noise Filters	DLW/DLM Series	Noise Suppression
	Piezoelectric Sounders	PKLCS/PKMCS Series	Sound Component
	Coin Manganese Dioxide Lithium Batteries	Standard Type	Battery Backup

Diagnostic imaging apparatus

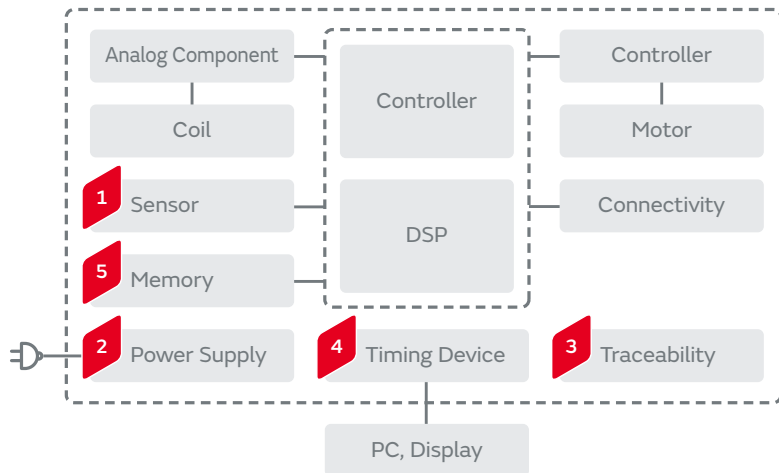

1 Sensor

Thermistors
NCP/PRF Series



3 Traceability

RFID Tag
LXMS/LXTB Series



2 Power Supply

Isolated DC-DC Converters
MYB Series



Non-Isolated DC-DC Converters
MYMGK/MYSGK/
OKL/MYLSM Series



Metal Terminal Type
Multilayer Ceramic Capacitors
for General Purpose
KRM Series



Polymer Aluminum
Electrolytic Capacitors
ECAS Series



Chip Multilayer Ceramic Capacitors
for General Purpose
GR/GA Series



Safety Standard Certified Resin Molding SMD Type Ceramic
Capacitors for General Purpose
DK1 Series



Safety Standard Certified Lead Type
Disc Ceramic Capacitors for General Purpose
DE1/DE2 Series

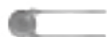

Thermistors
NCP/PRF Series



High Voltage Resistors
MHR Series



4 Timing Device

Crystal Units
XRC Series



Ceramic Resonators CERALOCK
CST Series



5 Memory

Chip Ferrite Beads
BLM Series



General Purpose

Chip Multilayer Ceramic Capacitors for General Purpose	GRM Series	High Frequency Filter Circuit/Coupling/Decoupling/For Step-up
High Q Chip Multilayer Ceramic Capacitors for General Purpose	GQM / GJM Series	High Frequency Filter Circuit
Soft Termination Chip Multilayer Ceramic Capacitors for General Purpose	GRJ Series	Coupling/Decoupling/For Step-up
3 Terminals Low ESL Chip Multilayer Ceramic Capacitors for General Purpose	NFM Series	Noise Suppression/Decoupling
Polymer Aluminum Electrolytic Capacitors	ECAS Series	Smoothing /Transient Backup
Chip Inductors (Chip Coils)	LQW/LQP/LQG Series	High Frequency Circuit-Impedance Matching /Resonance
Chip Inductors (Chip Coils)	LQM/LQH/DFE Series	Voltage Conversion
Chip Ferrite Beads	BLM/NFZ Series	Noise Suppression
Feed Through Chip EMI Filters	NFE Series	Noise Suppression
Chip Common Mode Choke Coils/Common Mode Noise Filters	DLW/DLM Series	Noise Suppression
Piezoelectric Sounders	PKLCS/PKMCS Series	Sound Component
Coin Manganese Dioxide Lithium Batteries	Standard Type	Battery Backup

Smart phone

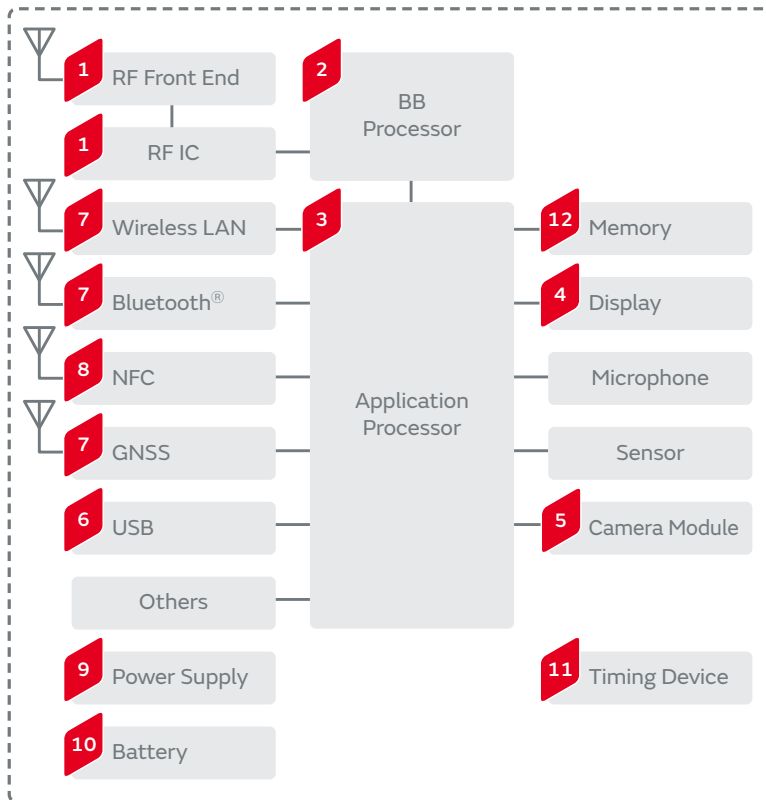

1 RF Front End, RF IC

SAW Duplexers SAY Series 	SAW Filters SAF Series
Chip Multilayer LC Filters LF Series 	Chip Multilayer Diplexers LFD Series
Chip Multilayer Hybrid Baluns LDB/LDM Series 	Chip Multilayer Hybrid Dividers LDD Series
Chip Multilayer Hybrid Couplers LDC/LDJ Series 	Microwave Coaxial Connectors with Switch
Microwave Multi Line Connectors 	Chip Inductors (Chip Coils) LQW/LQP Series
Band-Selectable Phase Adjustment Device (B-SPADE) 	Thermistors NCP/PRF Series

2 BB Processor

3 Terminals Low ESL Chip
Multilayer Ceramic Capacitors
for General Purpose
NFM Series

Chip Common Mode Choke Coils/
Common Mode Noise Filters
DLW/DLM Series

Frequency Specified Noise Filters
BLF Series

Chip LC Trap Filters
LQZ02HQ Series

Thermistors
NCP/PRF Series

3 Application Processor

Chip Ferrite Beads
BLM Series

3 Terminals Low ESL Chip
Multilayer Ceramic Capacitors
for General Purpose
NFM Series

Thermistors
NCP/PRF Series

4 Display

EMI Suppression Filters EMIFIL
NFA Series

Chip Common Mode Choke Coils/
Common Mode Noise Filters
DLW/DLM Series

Silicon ESD
Protection Devices
LXES**T Series

Thermistors
NCP/PRF Series

5 Camera Module

Chip Multilayer Ceramic Capacitors
for Camera Flash Circuit Only
GR7 Series

Chip Ferrite Beads
BLM Series

Silicon ESD Protection Devices
LXES**T Series

Thermistors
NCP/PRF Series

6 USB

Chip Common Mode Choke Coils/
Common Mode Noise Filters
DLW/NFG/DLM Series



Chip Ferrite Beads
BLM Series



Silicon ESD
Protection Devices
LXES**T Series



Thermistors
NCP/PRF Series



7 Wireless LAN, Bluetooth®, GNSS

Chip Multilayer Diplexers
LFD Series



Chip Multilayer Hybrid Couplers
LDC/LDJ Series



Bluetooth® Modules



Wi-Fi Modules



Bluetooth® - Wi-Fi
Combo Modules



SAW Filters
SAF Series



Chip Multilayer LC Filters
LF Series



Chip Multilayer Hybrid Baluns
LDB/LDM Series



Microwave Coaxial
Connectors with Switch



Microwave Multi Line
Connectors



Thermistors
NCP/PRF Series



8 NFC

Chip Ferrite Beads
BLM Series



Chip Inductors (Chip Coils)
LQW18C/LQM18J Series



Variable Capacitors
LXRW Series



9 Power Supply

Low Acoustic Noise Chip Multilayer
Ceramic Capacitors on Interposer
Board for General Purpose
ZRB Series



Metal Terminal Type
Multilayer Ceramic Capacitors
for General Purpose
KRM Series



Thermistors
NCP/PRF Series



Chip Multilayer
Ceramic Capacitors
for General Purpose
GR/GA Series



Safety Standard Certified Resin
Molding SMD Type Ceramic
Capacitors for General Purpose
DK1 Series



Safety Standard Certified Lead Type Disc
Ceramic Capacitors for General Purpose
DE1/DE2 Series



Chip Inductors (Chip Coils)
LQM/LQH/DFE Series



10 Battery

Thermistors
NCP/PRF/PRG Series



11 Timing Device

MEMS Resonators
WMRAG Series



Crystal Units
XRC Series



12 Memory

Chip Ferrite Beads
BLM Series



General Purpose

Chip Multilayer Ceramic Capacitors for General Purpose	GRM Series	High Frequency Filter Circuit/Coupling/Decoupling/For Step-up
High Q Chip Multilayer Ceramic Capacitors for General Purpose	GQM / GJM Series	High Frequency Filter Circuit
Soft Termination Chip Multilayer Ceramic Capacitors for General Purpose	GRJ Series	Coupling/Decoupling/For Step-up
3 Terminals Low ESL Chip Multilayer Ceramic Capacitors for General Purpose	NFM Series	Noise Suppression/Decoupling
Polymer Aluminum Electrolytic Capacitors	ECAS Series	Smoothing /Transient Backup
Chip Inductors (Chip Coils)	LQW/LQP/LQG Series	High Frequency Circuit-Impedance Matching /Resonance
Chip Inductors (Chip Coils)	LQM/LQH/DFE Series	Voltage Conversion
Chip Ferrite Beads	BLM/NFZ Series	Noise Suppression
Feed Through Chip EMI Filters	NFE Series	Noise Suppression
Chip Common Mode Choke Coils/Common Mode Noise Filters	DLW/DLM Series	Noise Suppression
Piezoelectric Sounders	PKLCS/PKMCS Series	Sound Component
Coin Manganese Dioxide Lithium Batteries	Standard Type	Battery Backup

Smart watch / health tracker

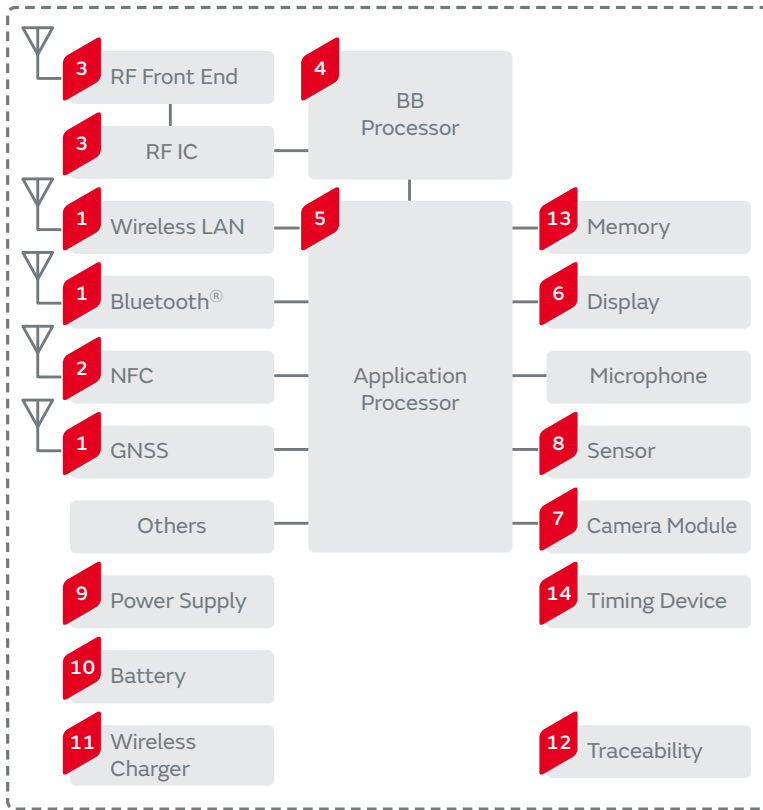

1 Wireless LAN, Bluetooth®, GNSS

Chip Common Mode Choke Coils/ Common Mode Noise Filters DLW/NFG/DLM Series	Silicon ESD Protection Devices LXES**T Series	Thermistors NCP/PRF Series	Bluetooth® Modules	Wi-Fi Modules	Bluetooth® - Wi-Fi Combo Modules	SAW Filters SAF Series
Chip Multilayer LC Filters LF Series	Chip Multilayer Hybrid Baluns LDB/LDM Series	Chip Multilayer Diplexers LFD Series	Chip Multilayer Hybrid Couplers LDC/LDJ Series	Microwave Coaxial Connectors with Switch	Microwave Multi Line Connectors	

2 NFC

Chip Inductors (Chip Coils)
LQW18C/LQM18J Series

Variable Capacitors
LXRW Series

3 RF Front End, RF IC

Chip Multilayer Diplexers LFD Series	SAW Duplexers SAY Series	SAW Filters SAF Series	Chip Multilayer LC Filters LF Series
Chip Multilayer Hybrid Baluns LDB/LDM Series	Chip Multilayer Hybrid Dividers LDD Series	Chip Multilayer Hybrid Couplers LDC/LDJ Series	
Microwave Coaxial Connectors with Switch	Microwave Multi Line Connectors	Band-Selectable Phase Adjustment Device (B-SPADE)	Thermistors NCP/PRF Series

4 BB Processor

Thermistors
NCP/PRF Series



5 Application Processor

Thermistors
NCP/PRF Series



6 Display

Silicon ESD Protection Devices
LXES**T Series



Thermistors
NCP/PRF Series



Piezoelectric Sounders
PKLCS/PKMCS Series



7 Camera Module

Chip Multilayer Ceramic Capacitors
for Camera Flash Circuit Only
GR7 Series



Silicon ESD Protection Devices
LXES**T Series



Thermistors
NCP/PRF Series



8 Sensor

Thermistors
NCP/PRF Series



9 Power Supply

Low Acoustic Noise
Chip Multilayer Ceramic Capacitors
on Interposer Board
for General Purpose
ZRB Series



Metal Terminal Type
Multilayer Ceramic Capacitors
for General Purpose
KRM Series



Thermistors
NCP Series



10 Battery

Coin Manganese Dioxide Lithium Batteries
Standard Type



Laminated Type
Lithium Ion Secondary Batteries



Thermistors
NCP/PRF/PRG Series



11 Wireless Charger

LW Reversed Low ESL Chip
Multilayer Ceramic Capacitors
for General Purpose
LLL Series



Thermistors
NCP/PRF Series



12 Traceability

RFID Tag
LXMS/LXTB Series



13 Memory

Chip Ferrite Beads
BLM Series



14 Timing Device

MEMS Resonators
WMRAG Series



Crystal Units
XRC Series



Ceramic Resonators CERALOCK
CST Series



General Purpose

Chip Multilayer Ceramic Capacitors for General Purpose

High Q Chip Multilayer Ceramic Capacitors for General Purpose

Soft Termination Chip Multilayer Ceramic Capacitors for General Purpose

3 Terminals Low ESL Chip Multilayer Ceramic Capacitors for General Purpose

Polymer Aluminum Electrolytic Capacitors

Chip Inductors (Chip Coils)

Chip Inductors (Chip Coils)

Chip Ferrite Beads

Feed Through Chip EMI Filters

Chip Common Mode Choke Coils/Common Mode Noise Filters

Piezoelectric Sounders

Coin Manganese Dioxide Lithium Batteries

GRM Series

GQM / GJM Series

GRJ Series

NFM Series

ECAS Series

LQW/LQP/LQG Series

LQM/LQH/DFE Series

BLM/NFZ Series

NFE Series

DLW/DLM Series

PKLCS/PKMCS Series

Standard Type

High Frequency Filter Circuit/Coupling/Decoupling/For Step-up

High Frequency Filter Circuit

Coupling/Decoupling/For Step-up

Noise Suppression/Decoupling

Smoothing /Transient Backup

High Frequency Circuit-Impedance Matching /Resonance

Voltage Conversion

Noise Suppression

Noise Suppression

Noise Suppression

Sound Component

Battery Backup

AR / VR



AR/VR Device

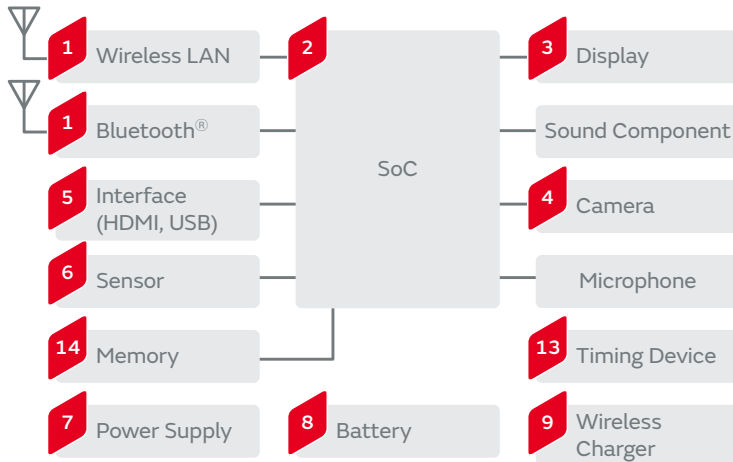

VR Controller

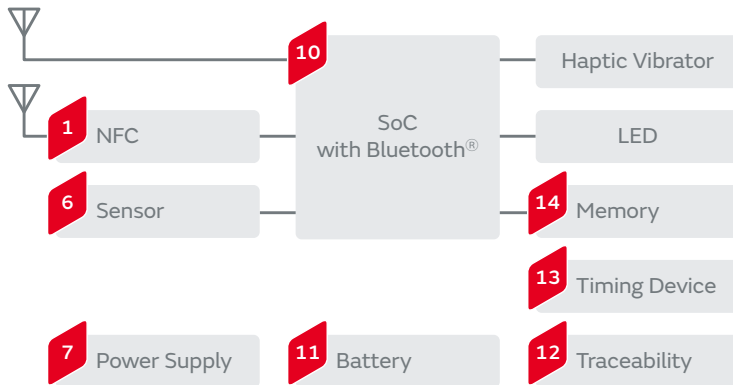

1 Wireless LAN, Bluetooth®, NFC

Bluetooth® Modules	Wi-Fi Modules	Bluetooth® - Wi-Fi Combo Modules

2 SoC

--	--

3 Display

--	--

4 Camera

5 Interface (HDMI, USB)

--	--	--

6 Sensor

--

7 Power Supply

--	--	--	--

8 Battery

Laminated Type Lithium Ion Secondary Batteries



9 Wireless Charger

LW Reversed Low ESL Chip Multilayer Ceramic Capacitors for General Purpose LLL Series



Thermistors NCP/PRF Series



10 SoC with Bluetooth®

RF Inductors LQP02HQ/LQW15AN Series



Microwave Coaxial Connectors with Switch



Microwave Multi Line Connectors



Chip Multilayer LC Filters LF Series



Chip Multilayer Hybrid Baluns LDB/LDM Series



Chip Multilayer Diplexers LFD Series



Chip Multilayer Hybrid Couplers LDC/LDJ Series



Chip LC Trap Filters LQZ02HQ Series



Frequency Specified Noise Filters BLF02RD Series



11 Battery

Coin Manganese Dioxide Lithium Batteries Standard Type



Thermistors NCP/PRF/PRG Series



12 Traceability

RFID Tag LXMS/LXTB Series



13 Timing Device

MEMS Resonators WMRAG Series



Crystal Units XRC Series



Ceramic Resonators CERALOCK CST Series



14 Memory

Chip Ferrite Beads BLM Series



General Purpose	Chip Multilayer Ceramic Capacitors for General Purpose	GRM Series	High Frequency Filter Circuit/Coupling/Decoupling/For Step-up
	High Q Chip Multilayer Ceramic Capacitors for General Purpose	GQM / GJM Series	High Frequency Filter Circuit
	Soft Termination Chip Multilayer Ceramic Capacitors for General Purpose	GRJ Series	Coupling/Decoupling/For Step-up
	3 Terminals Low ESL Chip Multilayer Ceramic Capacitors for General Purpose	NFM Series	Noise Suppression/Decoupling
	Polymer Aluminum Electrolytic Capacitors	ECAS Series	Smoothing /Transient Backup
	Chip Inductors (Chip Coils)	LQW/LQP/LQG Series	High Frequency Circuit-Impedance Matching /Resonance
	Chip Inductors (Chip Coils)	LQM/LQH/DFE Series	Voltage Conversion
	Chip Ferrite Beads	BLM/NFZ Series	Noise Suppression
	Feed Through Chip EMI Filters	NFE Series	Noise Suppression
	Chip Common Mode Choke Coils/Common Mode Noise Filters	DLW/DLM Series	Noise Suppression
	Piezoelectric Sounders	PKLCS/PKMCS Series	Sound Component
	Coin Manganese Dioxide Lithium Batteries	Standard Type	Battery Backup

True wireless stereo (non-medical use)

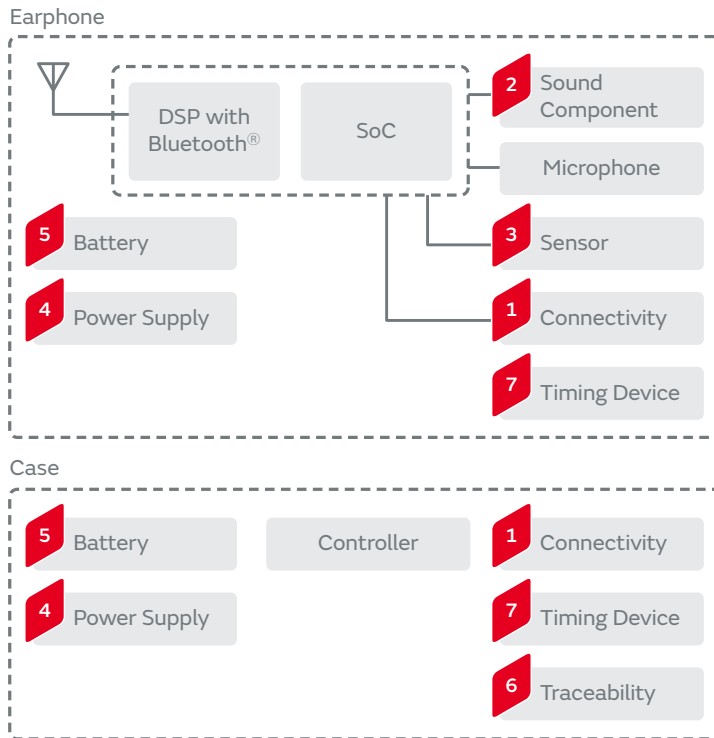

1 Connectivity

RF Inductors
LQP02HQ/LQW15AN Series



Chip Multilayer Hybrid Baluns
LDB/LDM Series



Chip LC Trap Filters
LQZ02HQ Series



Microwave Coaxial
Connectors with Switch



Chip Multilayer Diplexers
LFD Series



Frequency Specified Noise Filters
BLF02RD Series



Chip Multilayer LC Filters
LF Series



Chip Multilayer Hybrid Couplers
LDC/LDJ Series



2 Sound Component

Chip LC Trap Filters
LQZ02HQ Series



Frequency Specified Noise Filters
BLF02 Series



3 Sensor

Thermistors
NCP03 Series



4 Power Supply

Power Inductors
DFE18SAN Series



5 Battery

Thermistors
NCP03 Series



6 Traceability

RFID Tag
LXMS/LXTB Series



7 Timing Device

MEMS Resonators
WMRAG Series



Crystal Units
XRC Series



General Purpose

Chip Multilayer Ceramic Capacitors for General Purpose	GRM Series	High Frequency Filter Circuit/Coupling/Decoupling/For Step-up
High Q Chip Multilayer Ceramic Capacitors for General Purpose	GQM / GJM Series	High Frequency Filter Circuit
Soft Termination Chip Multilayer Ceramic Capacitors for General Purpose	GRJ Series	Coupling/Decoupling/For Step-up
3 Terminals Low ESL Chip Multilayer Ceramic Capacitors for General Purpose	NFM Series	Noise Suppression/Decoupling
Polymer Aluminum Electrolytic Capacitors	ECAS Series	Smoothing /Transient Backup
Chip Inductors (Chip Coils)	LQW/LQP/LQG Series	High Frequency Circuit-Impedance Matching /Resonance
Chip Inductors (Chip Coils)	LQM/LQH/DFE Series	Voltage Conversion
Chip Ferrite Beads	BLM/NFZ Series	Noise Suppression
Feed Through Chip EMI Filters	NFE Series	Noise Suppression
Chip Common Mode Choke Coils/Common Mode Noise Filters	DLW/DLM Series	Noise Suppression
Piezoelectric Sounders	PKLCS/PKMCS Series	Sound Component
Coin Manganese Dioxide Lithium Batteries	Standard Type	Battery Backup

PC

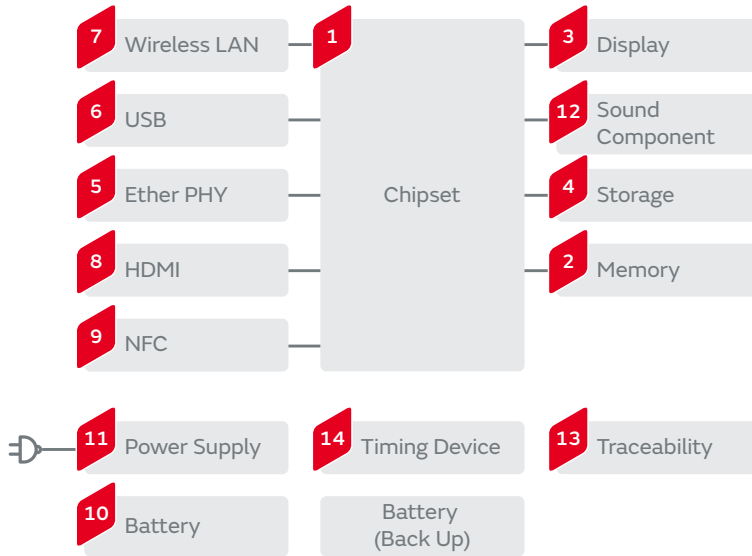

1 Chipset

- Low ESL Chip Multilayer Ceramic Capacitors for General Purpose LLL/LLA/LLM Series
- Chip Ferrite Beads BLM Series
- 3 Terminals Low ESL Chip Multilayer Ceramic Capacitors for General Purpose NFM Series
- Thermistors NCP/PRF Series

2 Memory

- Chip Ferrite Beads BLM Series

3 Display

- Metal Terminal Type Multilayer Ceramic Capacitors for General Purpose KRM Series
- Polymer Aluminum Electrolytic Capacitors ECAS Series
- Thermistors PRF/PRG Series
- Ultrasonic Sensors MA40 Series

4 Storage

- Thermistors NCP Series
- Polymer Aluminum Electrolytic Capacitors ECAS Series
- Actuators
- Thermistors NCP/PRF Series

5 Ether PHY

- Silicon ESD Protection Devices LXES**T Series
- Thermistors NCP/PRF Series
- Chip Common Mode Choke Coils/ Common Mode Noise Filters DLW/NFG/DLM Series

6 USB

- Polymer Aluminum Electrolytic Capacitors ECAS Series
- Chip Ferrite Beads BLM Series
- Thermistors PRG Series
- Silicon ESD Protection Devices LXES**T Series

7 Wireless LAN

- Bluetooth® Modules
- Wi-Fi Modules
- Bluetooth® - Wi-Fi Combo Modules
- SAW Filters SAF Series
- Chip Multilayer LC Filters LF Series
- Chip Multilayer Hybrid Baluns LDB/LDM Series
- Chip Multilayer Diplexers LFD Series
- Chip Multilayer Hybrid Couplers LDC/LDJ Series
- Microwave Coaxial Connectors with Switch
- Microwave Multi Line Connectors

8 HDMI

Silicon ESD Protection Devices
LXES**T Series



Thermistors
PRG Series



9 NFC

Chip Ferrite Beads
BLM Series



Chip Inductors (Chip Coils)
LQW18C/LQM18J Series



Variable Capacitors
LXRW Series



10 Battery

Thermistors
NXR/PRF/PRG Series



Laminated Type
Lithium Ion Secondary Batteries



11 Power Supply

Non-Isolated DC-DC Converters
MYMGK/MYSGK/
OKL/MYLSM Series



Power Inductors
LQH Series



Chip Multilayer Ceramic Capacitors for Ethernet LAN
and Primary-secondary Coupling of DC-DC converters
GR4 Series



Metal Terminal Type Multilayer
Ceramic Capacitors
for General Purpose
KRM Series



Polymer Aluminum
Electrolytic Capacitors
ECAS Series



Low Acoustic Noise Chip Multilayer
Ceramic Capacitors on Interposer
Board for General Purpose
ZRB Series



Thermistors
NCP/PRF Series



Chip Multilayer Ceramic
Capacitors for General Purpose
GR/GA Series



Safety Standard Certified
Resin Molding SMD Type
Ceramic Capacitors for General Purpose
DK1 Series



Safety Standard Certified
Lead Type Disc Ceramic Capacitors
for General Purpose
DE1/DE2 Series



12 Sound Component

Silicon ESD
Protection Devices
LXES**T Series



Ultrasonic Sensors
MA40 Series



13 Traceability

RFID Tag
LXMS/LXTB Series



14 Timing Device

MEMS Resonators
WMRAG Series



Crystal Units
XRC Series



Ceramic Resonators
CERALOCK
CST Series



General Purpose

Chip Multilayer Ceramic Capacitors for General Purpose	GRM Series	High Frequency Filter Circuit/Coupling/Decoupling/For Step-up
High Q Chip Multilayer Ceramic Capacitors for General Purpose	GQM / GJM Series	High Frequency Filter Circuit
Soft Termination Chip Multilayer Ceramic Capacitors for General Purpose	GRJ Series	Coupling/Decoupling/For Step-up
3 Terminals Low ESL Chip Multilayer Ceramic Capacitors for General Purpose	NFM Series	Noise Suppression/Decoupling
Polymer Aluminum Electrolytic Capacitors	ECAS Series	Smoothing /Transient Backup
Chip Inductors (Chip Coils)	LQW/LQP/LQG Series	High Frequency Circuit-Impedance Matching /Resonance
Chip Inductors (Chip Coils)	LQM/LQH/DFE Series	Voltage Conversion
Chip Ferrite Beads	BLM/NFZ Series	Noise Suppression
Feed Through Chip EMI Filters	NFE Series	Noise Suppression
Chip Common Mode Choke Coils/Common Mode Noise Filters	DLW/DLM Series	Noise Suppression
Piezoelectric Sounders	PKLCS/PKMCS Series	Sound Component
Coin Manganese Dioxide Lithium Batteries	Standard Type	Battery Backup

Tablet PC

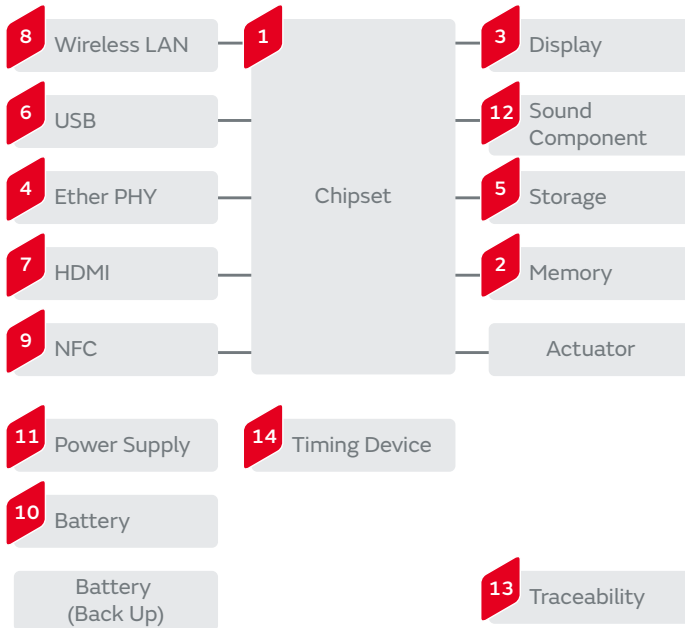

<p>1 Chipset</p> <ul style="list-style-type: none"> Low ESL Chip Multilayer Ceramic Capacitors for General Purpose LLL/LLA/LLM Series Chip Ferrite Beads BLM Series 3 Terminals Low ESL Chip Multilayer Ceramic Capacitors for General Purpose NFM Series Thermistors NCP/PRF Series 	<p>2 Memory</p> <ul style="list-style-type: none"> Chip Ferrite Beads BLM Series
<p>3 Display</p> <ul style="list-style-type: none"> Metal Terminal Type Multilayer Ceramic Capacitors for General Purpose KRM Series Polymer Aluminum Electrolytic Capacitors ECAS Series Power Inductors LQH Series Thermistors PRF/PRG Series 	<p>4 Ether PHY</p> <ul style="list-style-type: none"> Chip Common Mode Choke Coils/ Common Mode Noise Filters DLW/NFG/DLM Series Silicon ESD Protection Devices LXES**T Series Thermistors NCP/PRF Series
<p>5 Storage</p> <ul style="list-style-type: none"> Polymer Aluminum Electrolytic Capacitors ECAS Series Actuators Thermistors NCP/PRF Series 	
<p>6 USB</p> <ul style="list-style-type: none"> Polymer Aluminum Electrolytic Capacitors ECAS Series Chip Common Mode Choke Coils/ Common Mode Noise Filters DLW/NFG/DLM Series Silicon ESD Protection Devices LXES**T Series Thermistors PRG Series 	<p>7 HDMI</p> <ul style="list-style-type: none"> Silicon ESD Protection Devices LXES**T Series Thermistors PRG Series

8 Wireless LAN

Bluetooth® Modules



SAW Filters
SAF Series



Chip Multilayer Diplexers
LFD Series



Microwave Multi Line
Connectors



Wi-Fi Modules



Chip Multilayer LC Filters
LF Series



Chip Multilayer Hybrid Couplers
LDC/LDJ Series



Bluetooth® - Wi-Fi Combo Modules



Chip Multilayer Hybrid Baluns
LDB/LDM Series



Microwave Coaxial
Connectors with Switch



9 NFC

Chip Ferrite Beads
BLM Series



Chip Inductors (Chip Coils)
LQW18C/LQM18J Series



Variable Capacitors
LXRW Series



10 Battery

Thermistors
NXR/PRF/PRG Series



Laminated Type Lithium Ion
Secondary Batteries



11 Power Supply

Metal Terminal Type Multilayer
Ceramic Capacitors for General Purpose
KRM Series



Polymer Aluminum
Electrolytic Capacitors
ECAS Series



Low Acoustic Noise Chip Multilayer Ceramic Capacitors
on Interposer Board for General Purpose
ZRB Series



Chip Multilayer Ceramic Capacitors
for General Purpose
GR/GA Series



Safety Standard Certified Resin Molding SMD Type
Ceramic Capacitors for General Purpose
DK1 Series



Safety Standard Certified Lead Type
Disc Ceramic Capacitors for General Purpose
DE1/DE2 Series



Thermistors
NCP/PRF Series



12 Sound Component

Silicon ESD Protection Devices
LXES**T Series



13 Traceability

RFID Tag
LXMS/LXTB Series



14 Timing Device

MEMS Resonators
WMRAG Series



Crystal Units
XRC Series



Ceramic Resonators CERALOCK
CST Series



General Purpose

Chip Multilayer Ceramic Capacitors for General Purpose	GRM Series	High Frequency Filter Circuit/Coupling/Decoupling/For Step-up
High Q Chip Multilayer Ceramic Capacitors for General Purpose	GQM / GJM Series	High Frequency Filter Circuit
Soft Termination Chip Multilayer Ceramic Capacitors for General Purpose	GRJ Series	Coupling/Decoupling/For Step-up
3 Terminals Low ESL Chip Multilayer Ceramic Capacitors for General Purpose	NFM Series	Noise Suppression/Decoupling
Polymer Aluminum Electrolytic Capacitors	ECAS Series	Smoothing /Transient Backup
Chip Inductors (Chip Coils)	LQW/LQP/LQG Series	High Frequency Circuit-Impedance Matching /Resonance
Chip Inductors (Chip Coils)	LQM/LQH/DFE Series	Voltage Conversion
Chip Ferrite Beads	BLM/NFZ Series	Noise Suppression
Feed Through Chip EMI Filters	NFE Series	Noise Suppression
Chip Common Mode Choke Coils/Common Mode Noise Filters	DLW/DLM Series	Noise Suppression
Piezoelectric Sounders	PKLCS/PKMCS Series	Sound Component
Coin Manganese Dioxide Lithium Batteries	Standard Type	Battery Backup

AI speaker

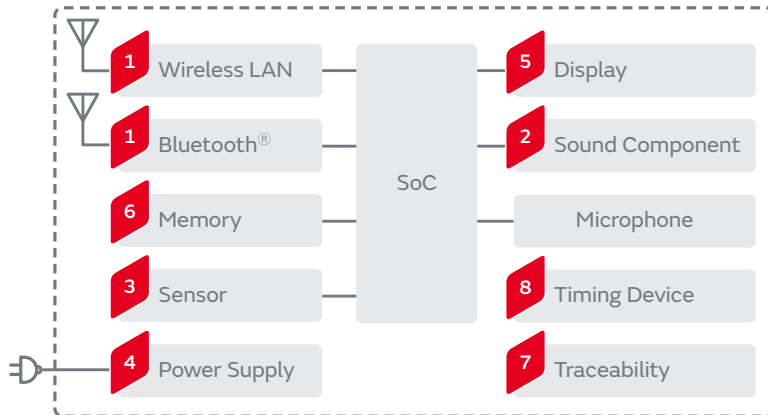

1 Wireless LAN, Bluetooth®

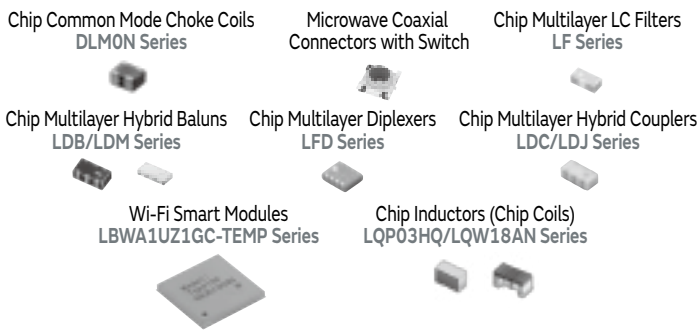

2 Sound Component



3 Sensor

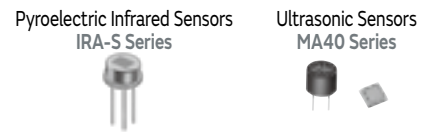

4 Power Supply



5 Display



6 Memory



7 Traceability



8 Timing Device

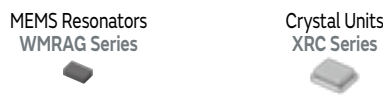

Chip Multilayer Ceramic Capacitors for General Purpose	GRM Series	High Frequency Filter Circuit/Coupling/Decoupling/For Step-up
High Q Chip Multilayer Ceramic Capacitors for General Purpose	GQM / GJM Series	High Frequency Filter Circuit
Soft Termination Chip Multilayer Ceramic Capacitors for General Purpose	GRJ Series	Coupling/Decoupling/For Step-up
3 Terminals Low ESL Chip Multilayer Ceramic Capacitors for General Purpose	NFM Series	Noise Suppression/Decoupling
Polymer Aluminum Electrolytic Capacitors	ECAS Series	Smoothing /Transient Backup
Chip Inductors (Chip Coils)	LQW/LQP/LQG Series	High Frequency Circuit-Impedance Matching /Resonance
Chip Inductors (Chip Coils)	LQM/LQH/DFE Series	Voltage Conversion
Chip Ferrite Beads	BLM/NFZ Series	Noise Suppression
Feed Through Chip EMI Filters	NFE Series	Noise Suppression
Chip Common Mode Choke Coils/Common Mode Noise Filters	DLW/DLM Series	Noise Suppression
Piezoelectric Sounders	PKLCS/PKMCS Series	Sound Component
Coin Manganese Dioxide Lithium Batteries	Standard Type	Battery Backup

Vacuum cleaner

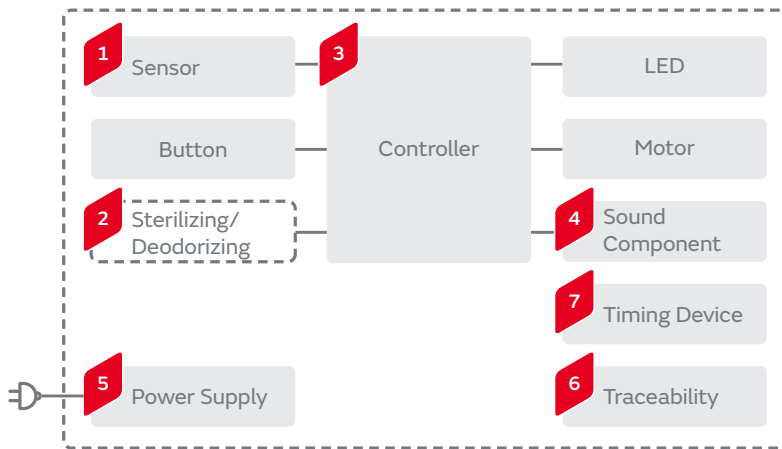

1 Sensor



2 Sterilizing/Deodorizing



3 Controller

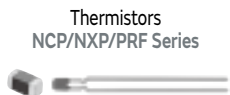

5 Power Supply

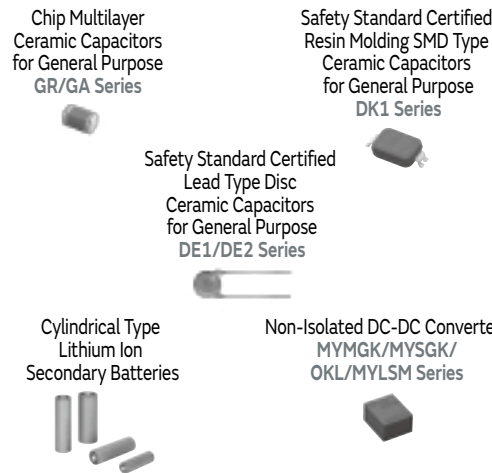

6 Traceability



4 Sound Component



7 Timing Device



General Purpose

Chip Multilayer Ceramic Capacitors for General Purpose	GRM Series	High Frequency Filter Circuit/Coupling/Decoupling/For Step-up
High Q Chip Multilayer Ceramic Capacitors for General Purpose	GQM / GJM Series	High Frequency Filter Circuit
Soft Termination Chip Multilayer Ceramic Capacitors for General Purpose	GRJ Series	Coupling/Decoupling/For Step-up
3 Terminals Low ESL Chip Multilayer Ceramic Capacitors for General Purpose	NFM Series	Noise Suppression/Decoupling
Polymer Aluminum Electrolytic Capacitors	ECAS Series	Smoothing /Transient Backup
Chip Inductors (Chip Coils)	LQW/LQP/LQG Series	High Frequency Circuit-Impedance Matching /Resonance
Chip Inductors (Chip Coils)	LQM/LQH/DFE Series	Voltage Conversion
Chip Ferrite Beads	BLM/NFZ Series	Noise Suppression
Feed Through Chip EMI Filters	NFE Series	Noise Suppression
Chip Common Mode Choke Coils/Common Mode Noise Filters	DLW/DLM Series	Noise Suppression
Piezoelectric Sounders	PKLCS/PKMCS Series	Sound Component
Coin Manganese Dioxide Lithium Batteries	Standard Type	Battery Backup

Air conditioner

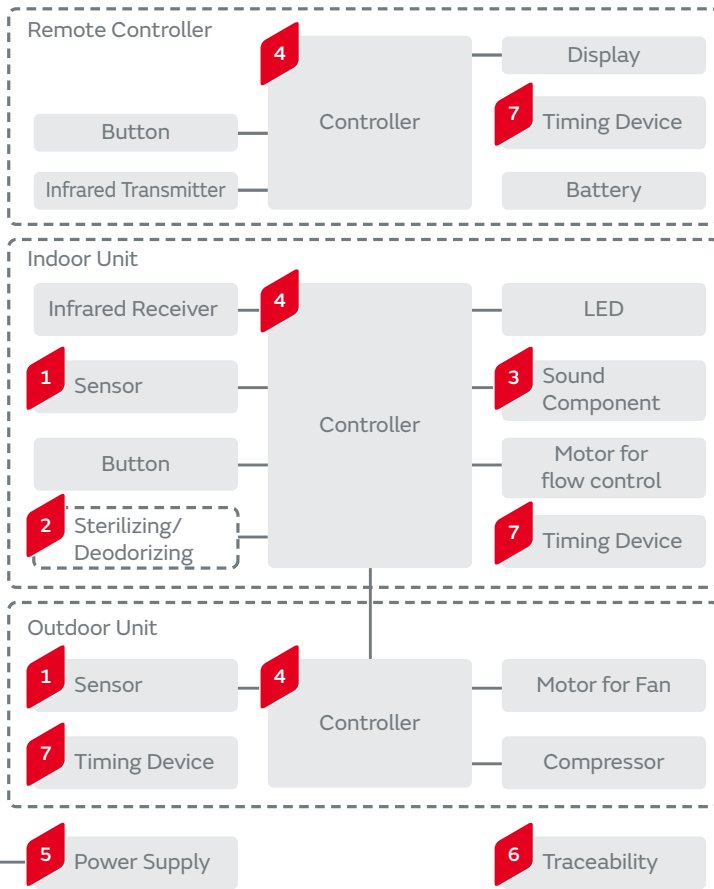
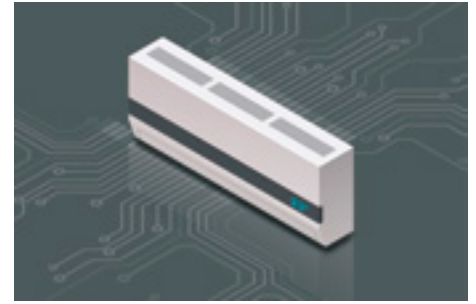

1 Sensor

<p>Ultrasonic Sensors MA40 Series</p>	<p>Thermistors NCP/NXR/PRF Series</p>
<p>Magnetic Sensors (AMR Sensors) MR Series</p>	<p>Pyroelectric Infrared Sensors IRA-S Series</p>

2 Sterilizing/Deodorizing

<p>Ionizer Modules Ionissimo MHM300 Series</p>	<p>Ozonizer Modules Ionissimo MHM500 Series</p>	<p>High Voltage Resistors MHR Series</p>
---	--	---

3 Sound Component

Piezoelectric Sounders
PKMCS/PK LCS/PKM Series

4 Controller

Thermistors
NCP/NXR/PRF Series

5 Power Supply

Chip Multilayer Ceramic Capacitors for General Purpose
GR/GA Series



Safety Standard Certified Resin Molding SMD Type Ceramic Capacitors for General Purpose
DK1 Series



Safety Standard Certified Lead Type Disc Ceramic Capacitors for General Purpose
DE1/DE2 Series



Non-Isolated DC-DC Converters
MYMGK/MYSGK/
OKL/MYLSM Series



6 Traceability

RFID Tag
LXMS/LXTB Series



7 Timing Device

Crystal Units
XRC Series



Ceramic Resonators CERALOCK
CST Series



General Purpose

Chip Multilayer Ceramic Capacitors for General Purpose	GRM Series	High Frequency Filter Circuit/Coupling/Decoupling/For Step-up
High Q Chip Multilayer Ceramic Capacitors for General Purpose	GQM / GJM Series	High Frequency Filter Circuit
Soft Termination Chip Multilayer Ceramic Capacitors for General Purpose	GRJ Series	Coupling/Decoupling/For Step-up
3 Terminals Low ESL Chip Multilayer Ceramic Capacitors for General Purpose	NFM Series	Noise Suppression/Decoupling
Polymer Aluminum Electrolytic Capacitors	ECAS Series	Smoothing /Transient Backup
Chip Inductors (Chip Coils)	LQW/LQP/LQG Series	High Frequency Circuit-Impedance Matching /Resonance
Chip Inductors (Chip Coils)	LQM/LQH/DFE Series	Voltage Conversion
Chip Ferrite Beads	BLM/NFZ Series	Noise Suppression
Feed Through Chip EMI Filters	NFE Series	Noise Suppression
Chip Common Mode Choke Coils/Common Mode Noise Filters	DLW/DLM Series	Noise Suppression
Piezoelectric Sounders	PKLCS/PKMCS Series	Sound Component
Coin Manganese Dioxide Lithium Batteries	Standard Type	Battery Backup

Washing machine

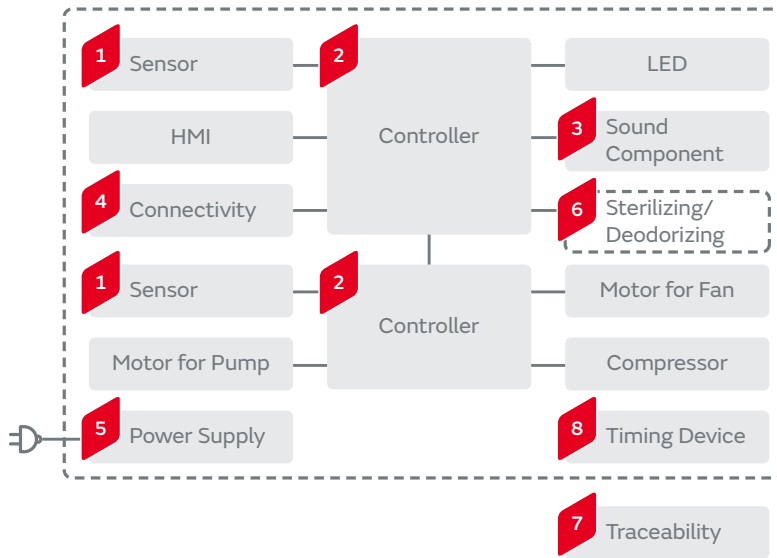

1 Sensor

Thermistors
NCP/NXR/PRF Series

Magnetic Sensors
(AMR Sensors)
MR Series

2 Controller

Thermistors
NCP/NXR/PRF Series

3 Sound Component

Piezoelectric Sounders
PKMCS/PKLS/PKM Series

4 Connectivity

Bluetooth®
Modules

Wi-Fi
Modules

LPWA
Modules

Microwave Coaxial
Connectors with Switch

5 Power Supply

Chip Multilayer
Ceramic Capacitors
for General Purpose
GR/GA Series

Safety Standard Certified
Resin Molding SMD Type
Ceramic Capacitors
for General Purpose
DK1 Series

Safety Standard Certified Lead
Type Disc Ceramic Capacitors
for General Purpose
DE1/DE2 Series

Non-Isolated DC-DC Converters
MYMGK/MYSGK/
OKL/MYLSM Series

6 Sterilizing/Deodorizing

Ozonizer Modules
Ionissimo
MHM500 Series

High Voltage
Resistors
MHR Series

7 Traceability

RFID Tag
LXMS/LXTB Series

8 Timing Device

Crystal Units
XRC Series

Ceramic Resonators CERALOCK
CST Series

General Purpose	Chip Multilayer Ceramic Capacitors for General Purpose	GRM Series	High Frequency Filter Circuit/Coupling/Decoupling/For Step-up
	High Q Chip Multilayer Ceramic Capacitors for General Purpose	GQM / GJM Series	High Frequency Filter Circuit
	Soft Termination Chip Multilayer Ceramic Capacitors for General Purpose	GRJ Series	Coupling/Decoupling/For Step-up
	3 Terminals Low ESL Chip Multilayer Ceramic Capacitors for General Purpose	NFM Series	Noise Suppression/Decoupling
	Polymer Aluminum Electrolytic Capacitors	ECAS Series	Smoothing /Transient Backup
	Chip Inductors (Chip Coils)	LQW/LQP/LQG Series	High Frequency Circuit-Impedance Matching /Resonance
	Chip Inductors (Chip Coils)	LQM/LQH/DFE Series	Voltage Conversion
	Chip Ferrite Beads	BLM/NFZ Series	Noise Suppression
	Feed Through Chip EMI Filters	NFE Series	Noise Suppression
	Chip Common Mode Choke Coils/Common Mode Noise Filters	DLW/DLM Series	Noise Suppression
	Piezoelectric Sounders	PKLCS/PKMCS Series	Sound Component
	Coin Manganese Dioxide Lithium Batteries	Standard Type	Battery Backup

Refrigerator



1 Sensor

- Thermistors
NCP/NXR/PRF Series
- Magnetic Sensors (AMR Sensors)
MR Series
- Pyroelectric Infrared Sensors
IRA-S Series
- Ultrasonic Sensors
MA40 Series

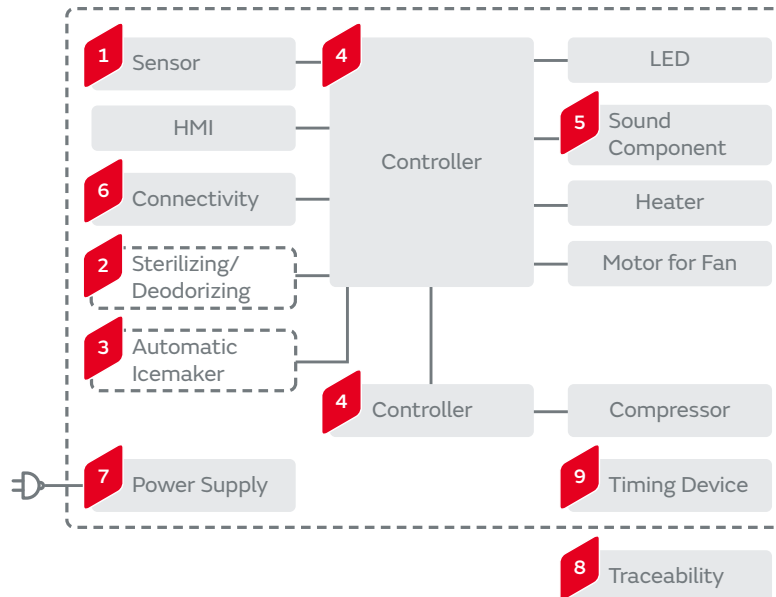

2 Sterilizing/Deodorizing

- Ozonizer Modules
Ionissimo
MHM500 Series
- High Voltage Resistors
MHR Series
- Microblowers

3 Automatic Icemaker

- Microblowers

4 Controller

- Thermistors
NCP/NXR/PRF Series

5 Sound Component

- Piezoelectric Sounders
PKMCS/PKLCs/PKM Series

6 Connectivity

- Bluetooth® Modules
- Wi-Fi Modules
- LPWA Modules
- Microwave Coaxial Connectors with Switch

7 Power Supply

- Chip Multilayer Ceramic Capacitors for General Purpose
GR/GA Series
- Safety Standard Certified Resin Molding SMD Type Ceramic Capacitors for General Purpose
DK1 Series
- Safety Standard Certified Lead Type Disc Ceramic Capacitors for General Purpose
DE1/DE2 Series
- Non-Isolated DC-DC Converters
MYMGK/MYSGK/OKL/MYLSM Series

8 Traceability

- RFID Tag
LXMS/LXTB Series

9 Timing Device

- Crystal Units
XRC Series
- Ceramic Resonators
CERALOCK
CST Series

General Purpose	Chip Multilayer Ceramic Capacitors for General Purpose	GRM Series	High Frequency Filter Circuit/Coupling/Decoupling/For Step-up
	High Q Chip Multilayer Ceramic Capacitors for General Purpose	GQM / GJM Series	High Frequency Filter Circuit
	Soft Termination Chip Multilayer Ceramic Capacitors for General Purpose	GRJ Series	Coupling/Decoupling/For Step-up
	3 Terminals Low ESL Chip Multilayer Ceramic Capacitors for General Purpose	NFM Series	Noise Suppression/Decoupling
	Polymer Aluminum Electrolytic Capacitors	ECAS Series	Smoothing /Transient Backup
	Chip Inductors (Chip Coils)	LQW/LQP/LQG Series	High Frequency Circuit-Impedance Matching /Resonance
	Chip Inductors (Chip Coils)	LQM/LQH/DFE Series	Voltage Conversion
	Chip Ferrite Beads	BLM/NFZ Series	Noise Suppression
	Feed Through Chip EMI Filters	NFE Series	Noise Suppression
	Chip Common Mode Choke Coils/Common Mode Noise Filters	DLW/DLM Series	Noise Suppression
	Piezoelectric Sounders	PKLCS/PKMCS Series	Sound Component
	Coin Manganese Dioxide Lithium Batteries	Standard Type	Battery Backup

Air purifier

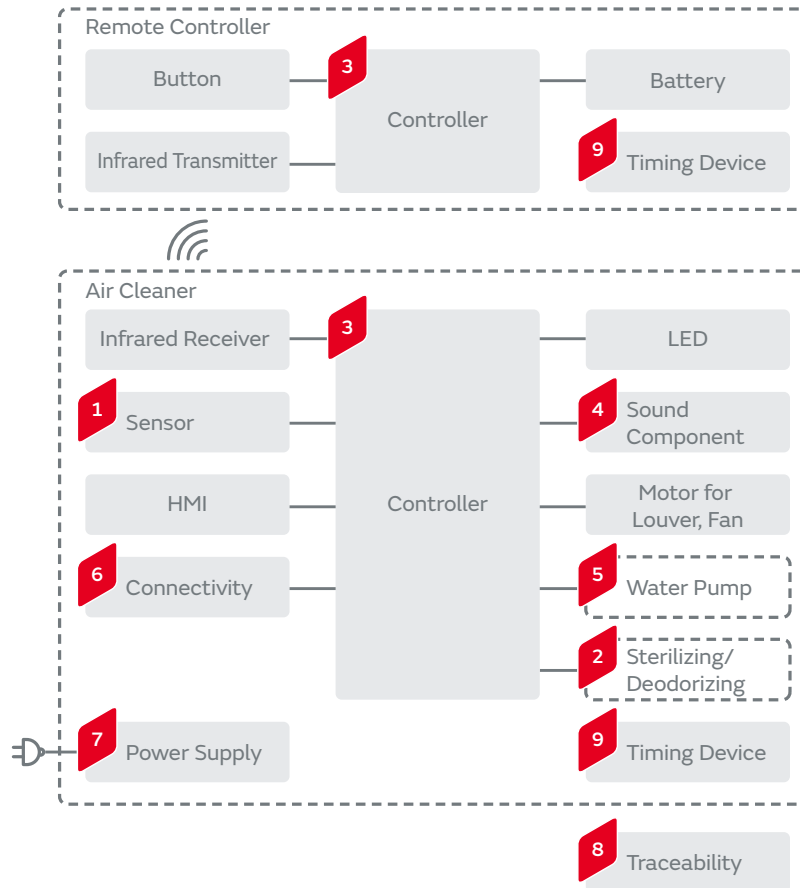

1 Sensor

<p>Ultrasonic Sensors MA40 Series</p>	<p>Thermistors NCP/NXR/PRF Series</p>	<p>Magnetic Sensors (AMR Sensors) MR Series</p>	<p>Pyroelectric Infrared Sensors IRA-S Series</p>
---	---	---	---

3 Controller

<p>Thermistors NCP/NXR/PRF Series</p>

2 Sterilizing/Deodorizing

<p>Ionizer Modules Ionissimo MHM300 Series</p>	<p>Ozonizer Modules Ionissimo MHM500 Series</p>	<p>High Voltage Resistors MHR Series</p>
--	---	--

4 Sound Component

<p>Piezoelectric Sounders PKMCS/PKLCs/PKM Series</p>
--

5 Water Pump



6 Connectivity



7 Power Supply



8 Traceability



9 Timing Device



General Purpose

Chip Multilayer Ceramic Capacitors for General Purpose	GRM Series	High Frequency Filter Circuit/Coupling/Decoupling/For Step-up
High Q Chip Multilayer Ceramic Capacitors for General Purpose	GQM / GJM Series	High Frequency Filter Circuit
Soft Termination Chip Multilayer Ceramic Capacitors for General Purpose	GRJ Series	Coupling/Decoupling/For Step-up
3 Terminals Low ESL Chip Multilayer Ceramic Capacitors for General Purpose	NFM Series	Noise Suppression/Decoupling
Polymer Aluminum Electrolytic Capacitors	ECAS Series	Smoothing /Transient Backup
Chip Inductors (Chip Coils)	LQW/LQP/LQG Series	High Frequency Circuit-Impedance Matching /Resonance
Chip Inductors (Chip Coils)	LQM/LQH/DFE Series	Voltage Conversion
Chip Ferrite Beads	BLM/NFZ Series	Noise Suppression
Feed Through Chip EMI Filters	NFE Series	Noise Suppression
Chip Common Mode Choke Coils/Common Mode Noise Filters	DLW/DLM Series	Noise Suppression
Piezoelectric Sounders	PKLCS/PKMCS Series	Sound Component
Coin Manganese Dioxide Lithium Batteries	Standard Type	Battery Backup

Microwave oven

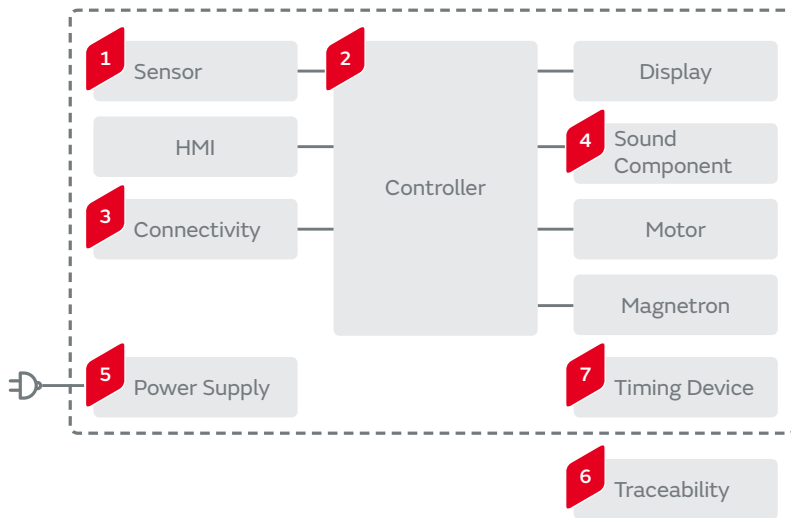

1 Sensor

Thermistors
NCP/NXR/PRF Series

Magnetic Sensors
(AMR Sensors)
MR Series

2 Controller

Thermistors
NCP/NXR/PRF Series

3 Connectivity

Bluetooth®
Modules

Wi-Fi
Modules

LPWA
Modules

Microwave Coaxial
Connectors with
Switch

4 Sound Component

Piezoelectric Sounders
PKMCS/PKLCs/PKM Series

5 Power Supply

Chip Multilayer
Ceramic Capacitors
for General Purpose
GR/GA Series

Safety Standard Certified Resin
Molding SMD Type Ceramic
Capacitors for General Purpose
DK1 Series

Safety Standard Certified Lead
Type Disc Ceramic Capacitors
for General Purpose
DE1/DE2 Series

Non-Isolated DC-DC Converters
MYMGK/MYSGK/
OKL/MYLSM Series

6 Traceability

RFID Tag
LXMS/LXTB Series

7 Timing Device

Crystal Units
XRC Series

Ceramic Resonators CERALOCK
CST Series

General Purpose	Chip Multilayer Ceramic Capacitors for General Purpose	GRM Series	High Frequency Filter Circuit/Coupling/Decoupling/For Step-up
	High Q Chip Multilayer Ceramic Capacitors for General Purpose	GQM / GJM Series	High Frequency Filter Circuit
	Soft Termination Chip Multilayer Ceramic Capacitors for General Purpose	GRJ Series	Coupling/Decoupling/For Step-up
	3 Terminals Low ESL Chip Multilayer Ceramic Capacitors for General Purpose	NFM Series	Noise Suppression/Decoupling
	Polymer Aluminum Electrolytic Capacitors	ECAS Series	Smoothing /Transient Backup
	Chip Inductors (Chip Coils)	LQW/LQP/LQG Series	High Frequency Circuit-Impedance Matching /Resonance
	Chip Inductors (Chip Coils)	LQM/LQH/DFE Series	Voltage Conversion
	Chip Ferrite Beads	BLM/NFZ Series	Noise Suppression
	Feed Through Chip EMI Filters	NFE Series	Noise Suppression
	Chip Common Mode Choke Coils/Common Mode Noise Filters	DLW/DLM Series	Noise Suppression
	Piezoelectric Sounders	PKLCS/PKMCS Series	Sound Component
	Coin Manganese Dioxide Lithium Batteries	Standard Type	Battery Backup

IH rice cooker

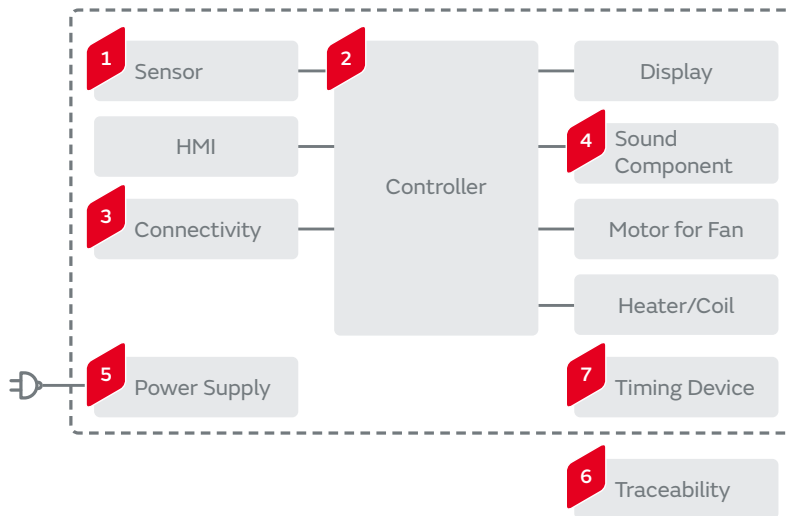

1 Sensor

Thermistors
NCP/NXR/PRF Series

Magnetic Sensors
(AMR Sensors)
MR Series

2 Controller

Thermistors
NCP/NXR/PRF Series

3 Connectivity

Bluetooth®
Modules

Wi-Fi
Modules

LPWA
Modules

Microwave Coaxial
Connectors with Switch

4 Sound Component

Piezoelectric Sounders
PKMCS/PKLCs/PKM Series

5 Power Supply

Chip Multilayer
Ceramic Capacitors
for General Purpose
GR/GA Series

Safety Standard Certified Resin
Molding SMD Type Ceramic
Capacitors for General Purpose
DK1 Series

Safety Standard Certified
Lead Type Disc Ceramic
Capacitors for General Purpose
DE1/DE2 Series

Non-Isolated
DC-DC Converters
MYMGK/MYSGK/
OKL/MYLSM Series

6 Traceability

RFID Tag
LXMS/LXTB Series

7 Timing Device

MEMS Resonators
WMRAG Series

Crystal Units
XRC Series

Ceramic Resonators CERALOCK
CST Series

General Purpose	Chip Multilayer Ceramic Capacitors for General Purpose	GRM Series	High Frequency Filter Circuit/Coupling/Decoupling/For Step-up
	High Q Chip Multilayer Ceramic Capacitors for General Purpose	GQM / GJM Series	High Frequency Filter Circuit
	Soft Termination Chip Multilayer Ceramic Capacitors for General Purpose	GRJ Series	Coupling/Decoupling/For Step-up
	3 Terminals Low ESL Chip Multilayer Ceramic Capacitors for General Purpose	NFM Series	Noise Suppression/Decoupling
	Polymer Aluminum Electrolytic Capacitors	ECAS Series	Smoothing /Transient Backup
	Chip Inductors (Chip Coils)	LQW/LQP/LQG Series	High Frequency Circuit-Impedance Matching /Resonance
	Chip Inductors (Chip Coils)	LQM/LQH/DFE Series	Voltage Conversion
	Chip Ferrite Beads	BLM/NFZ Series	Noise Suppression
	Feed Through Chip EMI Filters	NFE Series	Noise Suppression
	Chip Common Mode Choke Coils/Common Mode Noise Filters	DLW/DLM Series	Noise Suppression
	Piezoelectric Sounders	PKLCS/PKMCS Series	Sound Component
	Coin Manganese Dioxide Lithium Batteries	Standard Type	Battery Backup

Electrified

1

Inverter

2

BMS (Battery management system)

3

OBC (On board charger)

4

DC-DC converter

5

Engine ECU

1 Inverter

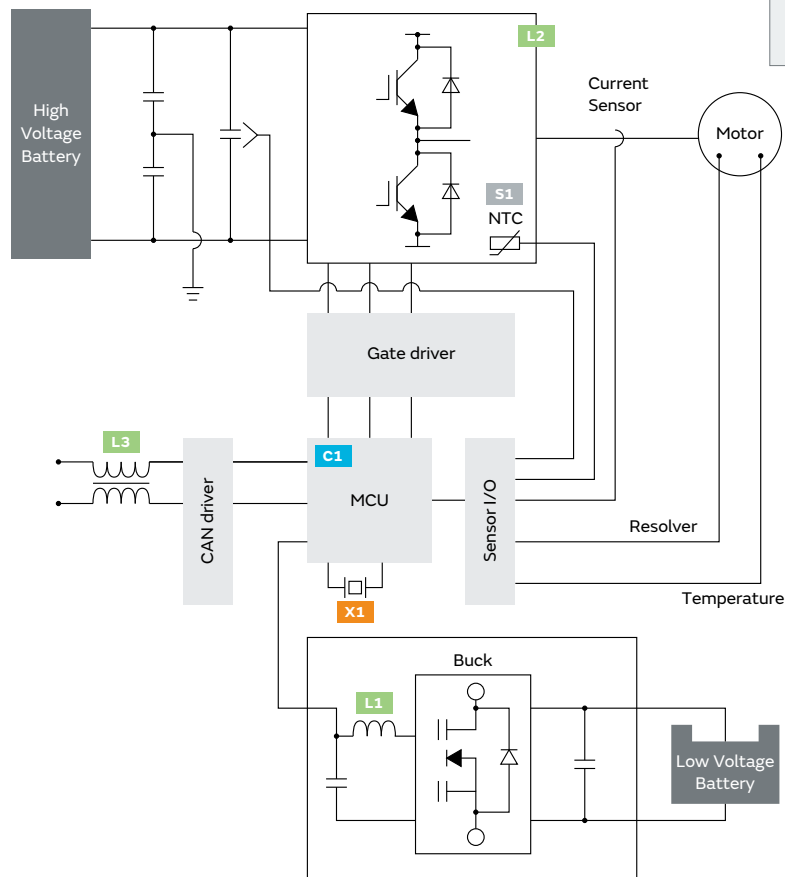
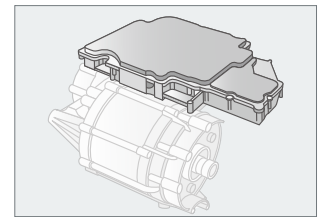

MCU	
C1	Chip Multilayer Ceramic Capacitors for Automotive GCM Series

DC-DC	
L1	Power Inductors LQH/DFE Series

IGBT	
L2	Chip Ferrite Beads BLM Series
S1	Thermistors NCU Series

CAN	
L3	Chip Common Mode Choke Coils DLW32SH Series
L3	Chip Common Mode Choke Coils DLW43SH Series

Timing Device	
X1	Ceramic Resonators CERALOCK CST Series

2 BMS (Battery management system)

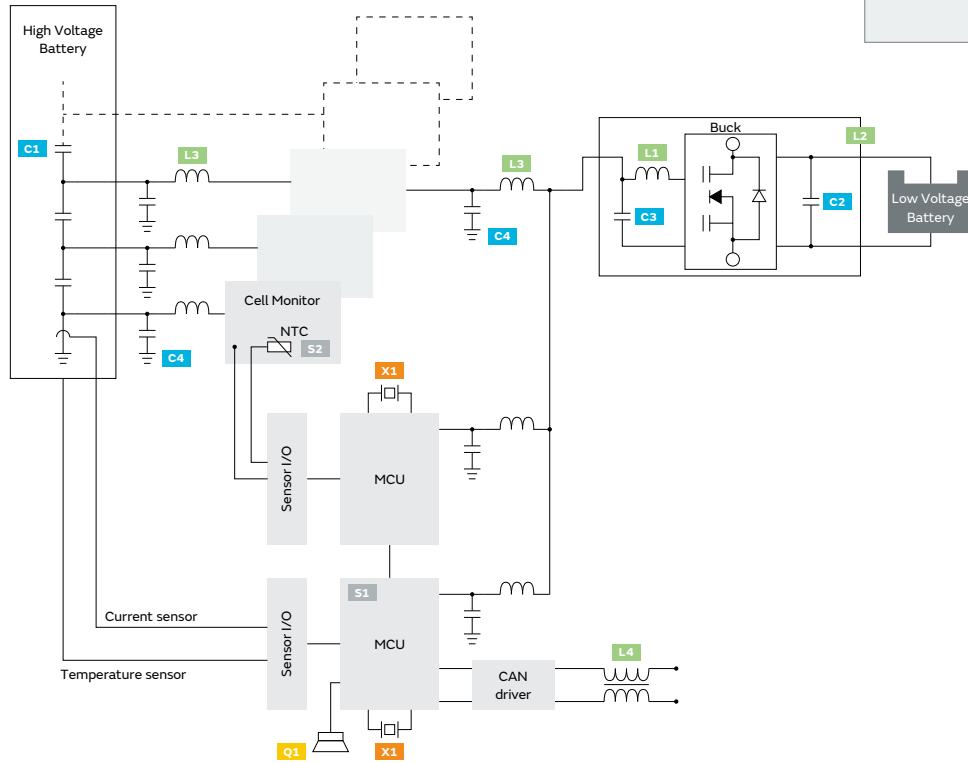
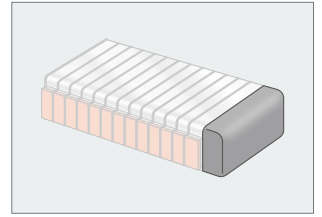

MCU	
S1	Thermistors NCU Series
Q1	Piezoelectric Sounders PKLCS/PKMCS Series

Cell Monitor	
C4	Chip Multilayer Ceramic Capacitors for Automotive GCM Series
C4	Soft Termination Chip Multilayer Ceramic Capacitors for Automotive GCJ Series
C4	Metal Terminal Type Multilayer Ceramic Capacitors for Automotive KCM Series
L3	Chip Ferrite Beads BLM Series
S2	Thermistors NCU Series

Battery	
C1	Chip Multilayer Ceramic Capacitors for Automotive GCM Series
C1	Soft Termination Chip Multilayer Ceramic Capacitors for Automotive GCJ Series
C1	Metal Terminal Type Multilayer Ceramic Capacitors for Automotive KCM Series

DC-DC	
C2	Soft Termination Chip Multilayer Ceramic Capacitors for Automotive GCJ Series
C2	Metal Terminal Type Multilayer Ceramic Capacitors for Automotive KCM Series
C3	Chip Multilayer Ceramic Capacitors for Automotive GCM Series
C2	MLSC Design Chip Multilayer Ceramic Capacitors for Automotive GCD Series

DC-DC	
C3	Soft Termination MLSC Design Chip Multilayer Ceramic Capacitors for Automotive GCE Series
L1	Power Inductors LQH/DFE Series
L2	Large-current Common Mode Choke Coils PLT10HH/PLT5BP Series
L2	Chip Common Mode Choke Coils DLW Series

CAN	
L4	Chip Common Mode Choke Coils DLW32SH Series
L4	Chip Common Mode Choke Coils DLW43SH Series

Timing Device	
X1	Ceramic Resonators CERALOCK CST Series

3 OBC (On board charger)

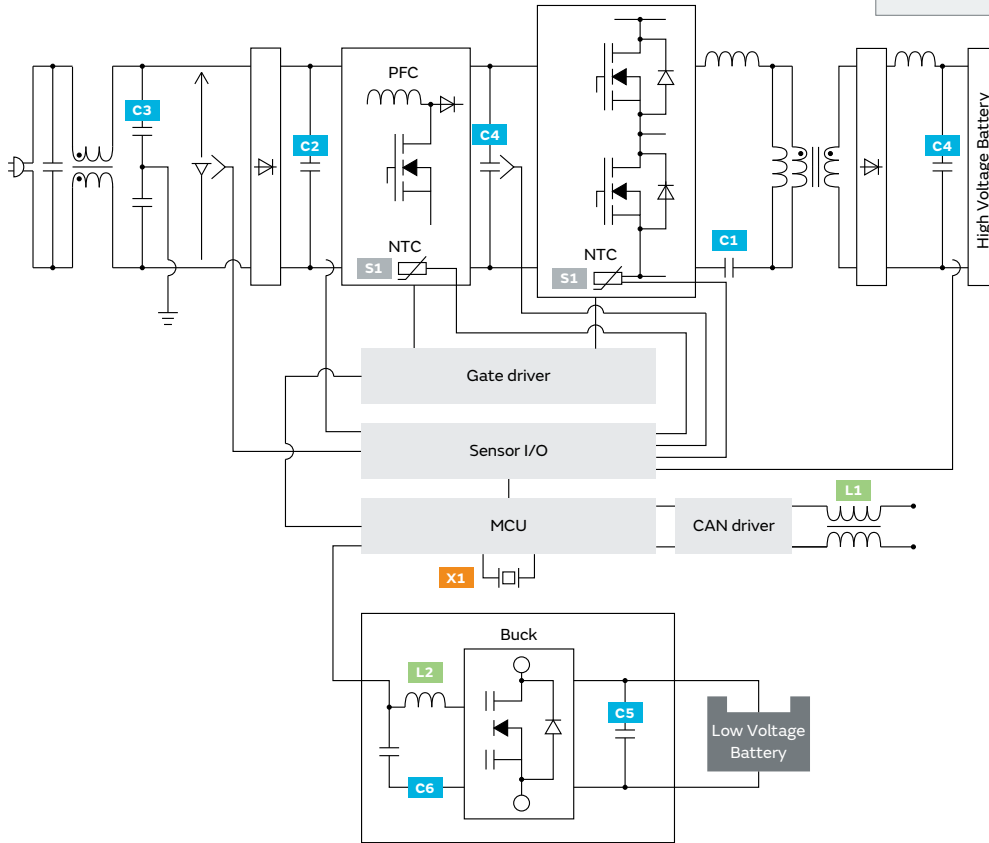
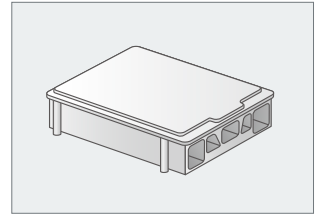

Filter	
C1	Chip Multilayer Ceramic Capacitors for Automotive GCM Series
C1	Metal Terminal Type Multilayer Ceramic Capacitors for Automotive KCM Series
C2	High Effective Capacitance & High Allowable Ripple Current Metal Terminal Type Multilayer Ceramic Capacitors for Automotive KC3 Series

AC-DC	
C3	Metal Terminal Type Multilayer Ceramic Capacitors for Automotive KCM Series
C3	Safety Standard Certified Metal Terminal Type Multilayer Ceramic Capacitors for Automotive KCA Series
C3	Safety Standard Certified Lead Type Disc Ceramic Capacitors for Automotive DE6 Series

Smoothing	
C4	High Temperature Film Capacitors for Automotive FH Series
C4	High Effective Capacitance & High Allowable Ripple Current Metal Terminal Type Multilayer Ceramic Capacitors for Automotive KC3 Series

DC-DC	
C5	Soft Termination Chip Multilayer Ceramic Capacitors for Automotive GCJ Series
C5	Metal Terminal Type Multilayer Ceramic Capacitors for Automotive KCM Series
L2	Power Inductors LQH/DFE Series
C6	Chip Multilayer Ceramic Capacitors for Automotive GCM Series

CAN	
L1	Chip Common Mode Choke Coils DLW32SH Series
L1	Chip Common Mode Choke Coils DLW43SH Series

PFC	
S1	Thermistors NCU Series

Timing Device	
X1	Ceramic Resonators CERALOCK CST Series

4 DC-DC converter

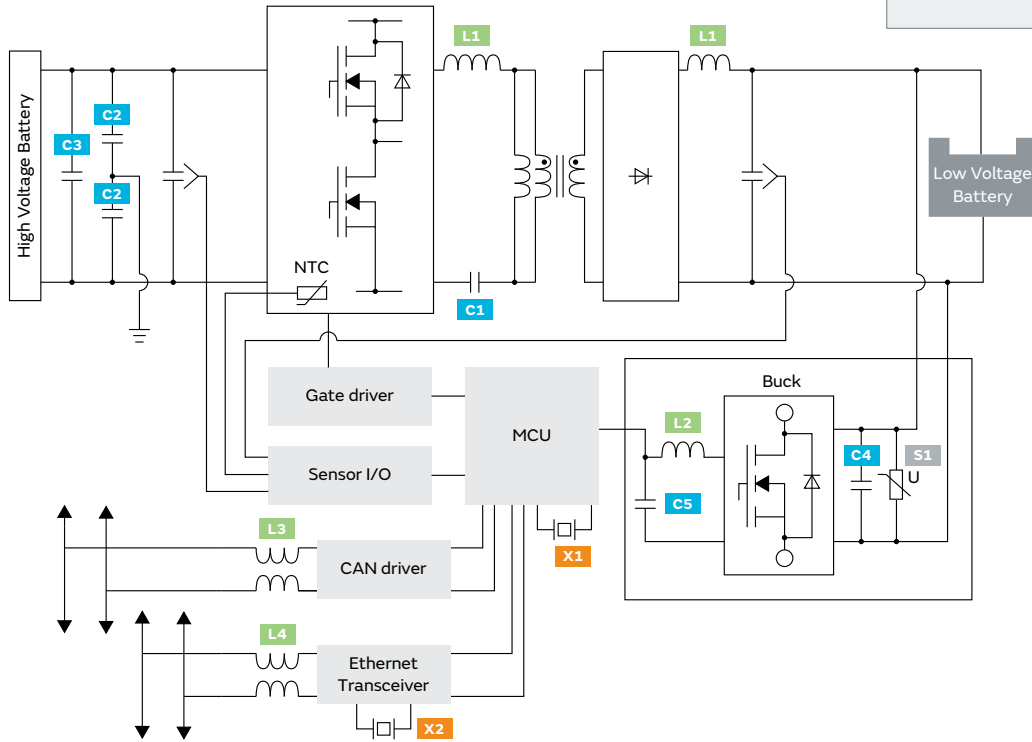
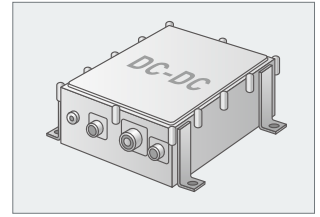

Power line	
C1	High Effective Capacitance & High Allowable Ripple Current Metal Terminal Type Multilayer Ceramic Capacitors for Automotive KC3 Series
C3	High Temperature Film Capacitors for Automotive FH Series
C3	Safety Standard Certified Metal Terminal Type Multilayer Ceramic Capacitors for Automotive KCA Series
C2	Safety Standard Certified Lead Type Disc Ceramic Capacitors for Automotive DE6 Series
L1	Chip Ferrite Beads BLM Series
L1	Power Inductors LQH/DFE Series

MCU/Sub MCU	
X1	Ceramic Resonators CERALOCK CST Series
X1	Crystal Units XRC Series

CAN	
L3	Chip Common Mode Choke Coils DLW32SH Series
L3	Chip Common Mode Choke Coils DLW43SH Series

Ethernet	
L4	Chip Common Mode Choke Coils DLW32MH Series
L4	Chip Common Mode Choke Coils DLW43MH Series
X2	Crystal Units XRC Series

DC-DC	
C4	Soft Termination MLSC Design Chip Multilayer Ceramic Capacitors for Automotive GCE Series
C4	MLSC Design Chip Multilayer Ceramic Capacitors for Automotive GCD Series
C4	Soft Termination Chip Multilayer Ceramic Capacitors for Automotive GCJ Series
C4	Metal Terminal Type Multilayer Ceramic Capacitors for Automotive KCM Series
C5	Chip Multilayer Ceramic Capacitors for Automotive GCM Series
S1	Thermistors NCU Series
L2	Power Inductors LQH/DFE Series

5 Engine ECU

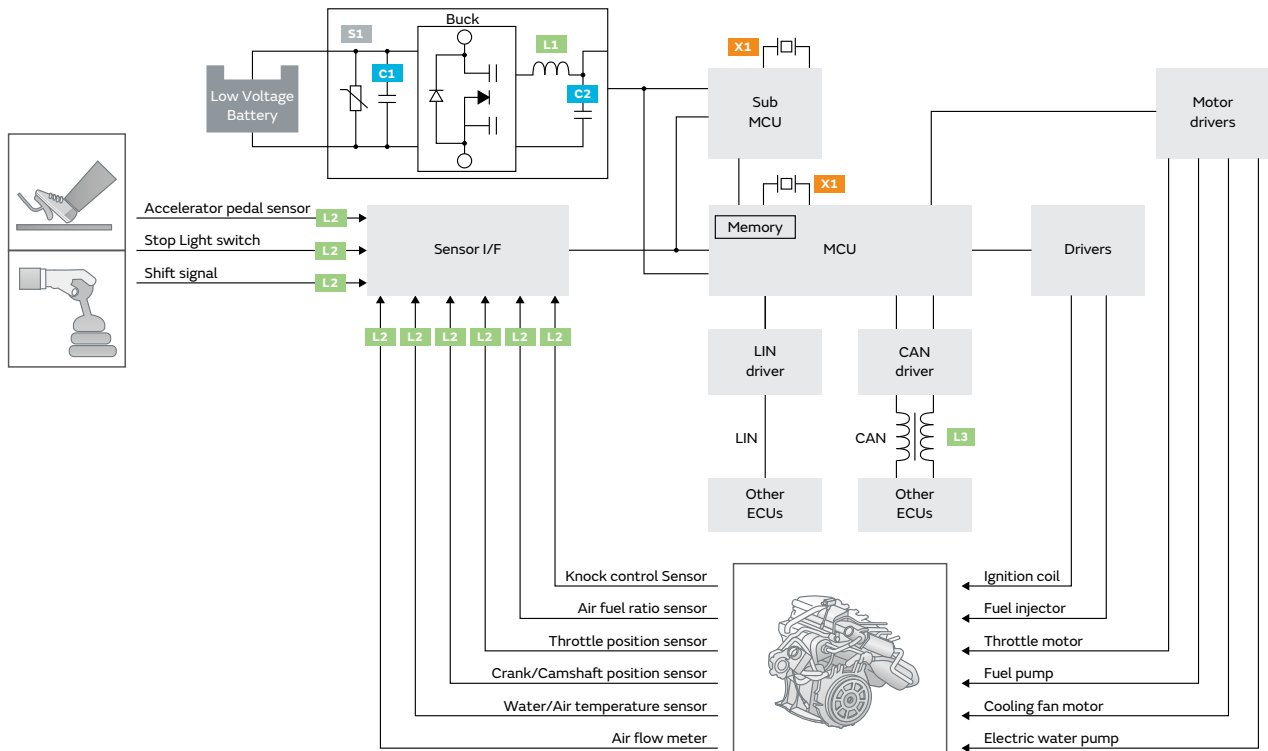
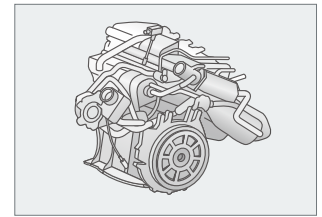

DC-DC	
C1	MLSC Design Chip Multilayer Ceramic Capacitors for Automotive GCD Series
C1	Soft Termination MLSC Design Chip Multilayer Ceramic Capacitors for Automotive GCE Series
C1	Soft Termination Chip Multilayer Ceramic Capacitors for Automotive GCJ Series
C1	Metal Terminal Type Multilayer Ceramic Capacitors for Automotive KCM Series
L1	Chip Ferrite Beads BLM Series
L1	Power Inductors LQH/DFE Series

DC-DC	
C2	Chip Multilayer Ceramic Capacitors for Automotive GCM Series
S1	Thermistors NCU Series

Signal Line	
L2	Chip Ferrite Beads BLM Series

MCU/Sub MCU	
X1	Ceramic Resonators CERALOCK CST Series
X1	Crystal Units XRC Series

CAN	
L3	Chip Common Mode Choke Coils DLW32SH Series
L3	Chip Common Mode Choke Coils DLW43SH Series

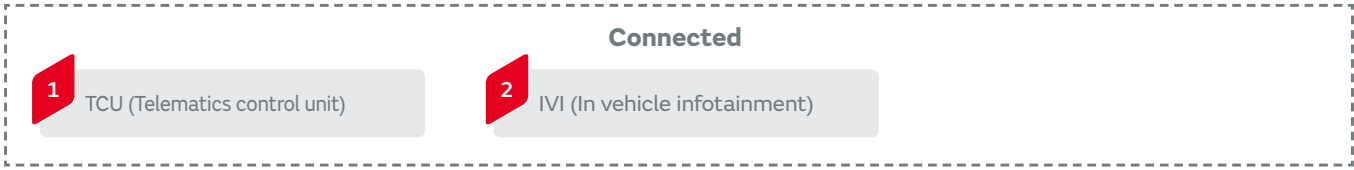

1 TCU (Telematics control unit)

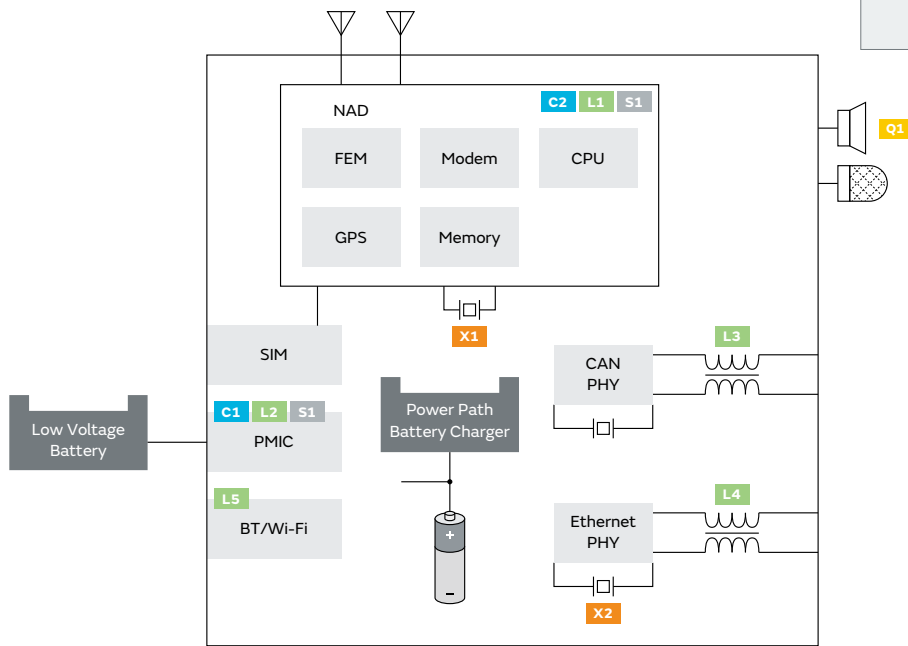
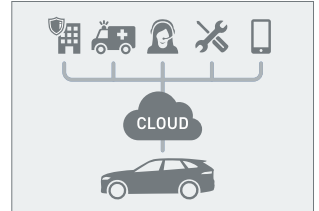

PMIC	
C1	Soft Termination Chip Multilayer Ceramic Capacitors for Automotive GCJ Series
C1	Metal Terminal Type Multilayer Ceramic Capacitors for Automotive KCM Series
C1	Chip Multilayer Ceramic Capacitors for Automotive GCM Series
C1	AEC-Q200 Compliant 3 Terminals Low ESL Chip Multilayer Ceramic Capacitors for Infotainment NFM Series
L2	Chip Inductors (Chip Coils) LQM/LQH/DFE Series
L2	Chip Ferrite Beads BLM Series
S1	Thermistors NCU Series

BT/Wi-Fi	
L5	Chip Inductors (Chip Coils) LQW/LQP/LQG Series

NAD	
C2	AEC-Q200 Compliant 3 Terminals Low ESL Chip Multilayer Ceramic Capacitors for Infotainment NFM Series
C2	Chip Multilayer Ceramic Capacitors for Automotive GCM Series
L1	Chip Inductors (Chip Coils) LQW/LQP/LQG Series
S1	Thermistors NCU Series
Q1	Piezoelectric Sounders PKLCS/PKMCS Series

CAN	
L3	Chip Common Mode Choke Coils DLW32SH Series
L3	Chip Common Mode Choke Coils DLW43SH Series

Ethernet	
L4	Chip Common Mode Choke Coils DLW32MH Series
L4	Chip Common Mode Choke Coils DLW43MH Series

Timing Device	
X1	Ceramic Resonators CERALOCK CST Series
X2	Crystal Units XRC Series

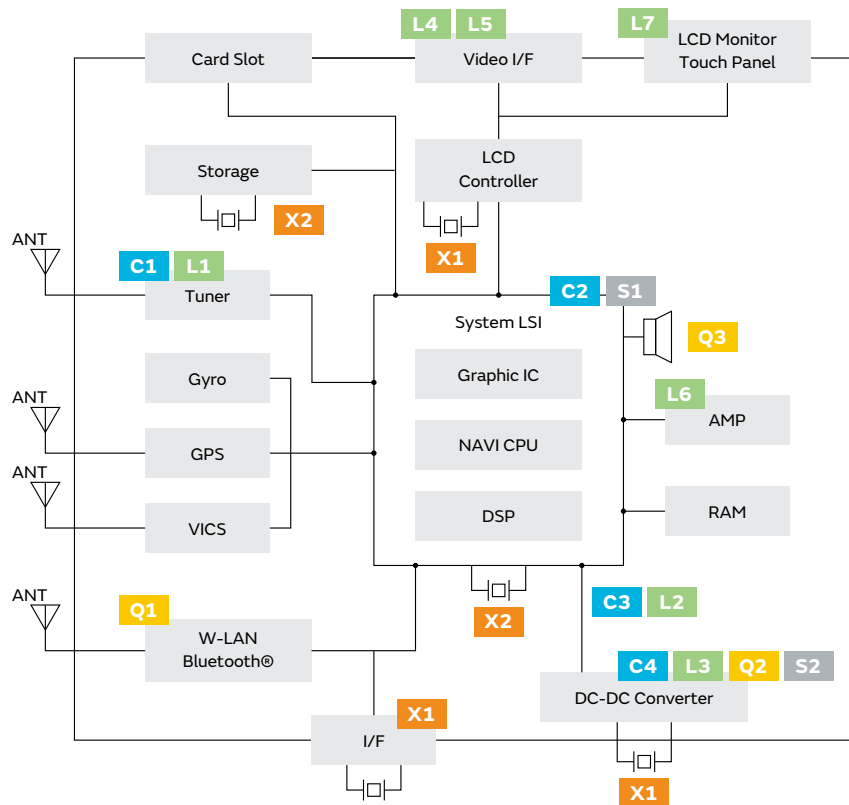
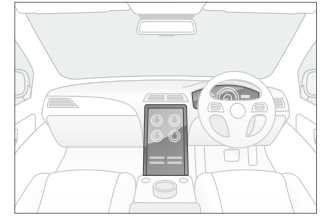

2 IVI (In vehicle infotainment)



Tuner	
C1	High Q Chip Multilayer Ceramic Capacitors for Automotive GCQ Series
L1	Chip Inductors (Chip Coils) LQW/LQP/LQG Series
L1	Variable inductors 5CCEG Series



Video I/F	
L4	Chip Common Mode Choke Coils DLW21SZ Series
L4	Chip Inductors (Chip Coils) LQW18C/LQM18J Series
L4	Chip Inductors (Chip Coils) LQW32FT Series
L4	Chip Inductors (Chip Coils) LQH Series
L5	Chip Common Mode Choke Coils DLW32MH Series
L5	Chip Common Mode Choke Coils DLW43MH Series

System LSI	
C2	AEC-Q200 Compliant 3 Terminals Low ESL Chip Multilayer Ceramic Capacitors for Infotainment NFM Series
C2	AEC-Q200 Compliant Chip Multilayer Ceramic Capacitors for Infotainment GRT Series
S1	Thermistors NCU Series
Q1	Piezoelectric Sounders PKLCS/PKMCS Series

AMP	
L6	Power Inductors LQH/DEM/DFE Series 
L6	Large-current Common Mode Choke Coils PLT10/PLT5B/DLW5A/ DLW5B/UCMH Series 

DC-DC Converter	
C4	AEC-Q200 Compliant Chip Multilayer Ceramic Capacitors for Infotainment GRT Series 
C4	AEC-Q200 Compliant 3 Terminals Low ESL Chip Multilayer Ceramic Capacitors for Infotainment NFM Series 
C4	Polymer Aluminum Electrolytic Capacitors ECAS Series 
L3	Large-current Common Mode Choke Coils PLT10/PLT5B/DLW5A/ DLW5B/UCMH Series 
L3	Chip Ferrite Beads BLM Series 
S2	Thermistors NCU Series 
Q2	Non-Isolated DC-DC Converters MYMGK/MYSGK/OKL/ MYLSM Series 

Secondary	
C3	AEC-Q200 Compliant 3 Terminals Low ESL Chip Multilayer Ceramic Capacitors for Infotainment NFM Series 
C3	AEC-Q200 Compliant Chip Multilayer Ceramic Capacitors for Infotainment GRT Series 
C3	Polymer Aluminum Electrolytic Capacitors ECAS Series 
L2	Chip Inductors (Chip Coils) LQM/LQH/DFE Series 
L2	Chip Ferrite Beads BLM Series 

Timing Device	
X1	Ceramic Resonators CERALOCK CST Series 
X2	Crystal Units XRC Series 

Connectivity	
Q3	Bluetooth® - Wi-Fi Combo Modules 

LCD Monitor Touch Panel	
L7	LC combined filters NFL Series 

AD & ADAS

- 1 ADAS (Advanced driver assist system)
- 2 IPA (Intelligent parking assist)
- 3 Lidar
- 4 Radar
- 5 Front camera



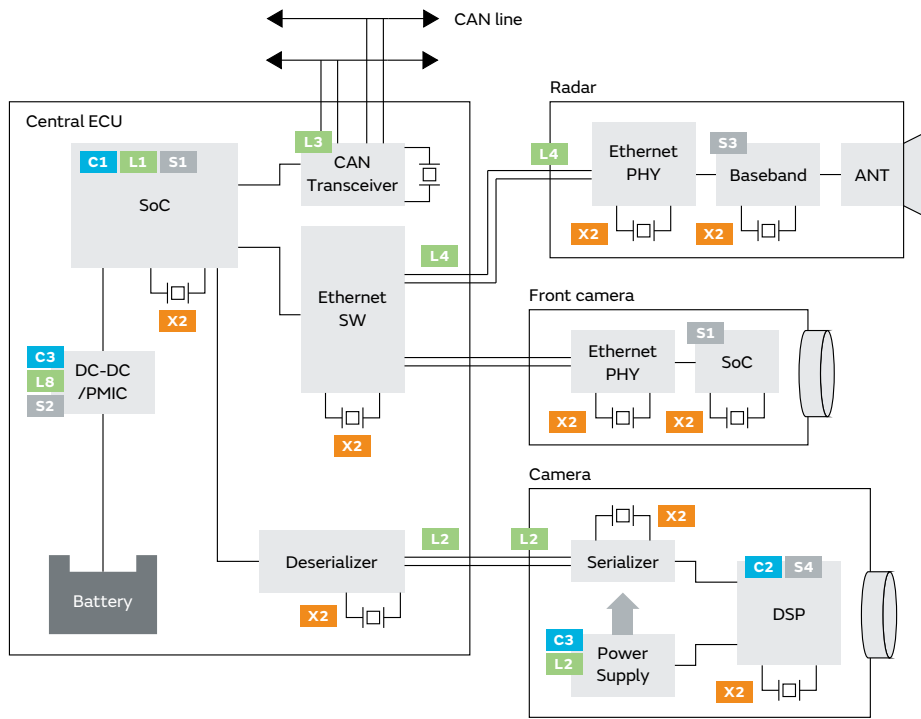
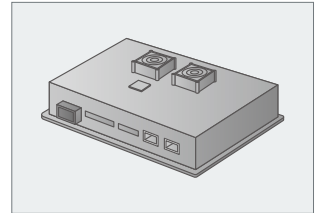





1 ADAS (Advanced driver assist system)





SoC	
C1	3 Terminals Low ESL Chip Multilayer Ceramic Capacitors for Automotive NFM Series
C1	Chip Multilayer Ceramic Capacitors for Automotive GCM Series
L1	Chip Ferrite Beads BLM Series
S1	Thermistors NCU Series

DC-DC/PMIC	
C3	Soft Termination Chip Multilayer Ceramic Capacitors for Automotive GCJ Series
C3	Metal Terminal Type Multilayer Ceramic Capacitors for Automotive KCM Series
C3	Chip Multilayer Ceramic Capacitors for Automotive GCM Series
C3	3 Terminals Low ESL Chip Multilayer Ceramic Capacitors for Automotive NFM Series





DC-DC/PMIC	
L8	Power Inductors LQH/DFE Series
S2	Thermistors NCU Series



Power Supply		
C3	Soft Termination Chip Multilayer Ceramic Capacitors for Automotive GCJ Series	
C3	Metal Terminal Type Multilayer Ceramic Capacitors for Automotive KCM Series	
C3	Chip Multilayer Ceramic Capacitors for Automotive GCM Series	
C3	3 Terminals Low ESL Chip Multilayer Ceramic Capacitors for Automotive NFM Series	
L2	Chip Ferrite Beads BLM Series	
L2	Chip Inductors (Chip Coils) LQW18C/LQM18J Series	
L2	Chip Inductors (Chip Coils) LQW32FT Series	
L2	Chip Inductors (Chip Coils) LQH Series	



Baseband		
S3	Thermistors NCU Series	

Timing Device		
X1	Ceramic Resonators CERALOCK CST Series	
X2	Crystal Units XRC Series	

DSP		
C2	AEC-Q200 Compliant Chip Multilayer Ceramic Capacitors for Infotainment GRT Series	
C2	3 Terminals Low ESL Chip Multilayer Ceramic Capacitors for Automotive NFM Series	
S4	Thermistors NCU Series	

SerDes		
L2	Chip Ferrite Beads BLM Series	
L2	Chip Inductors (Chip Coils) LQW18C/LQM18J Series	
L2	Chip Inductors (Chip Coils) LQW32FT Series	
L2	Chip Inductors (Chip Coils) LQH Series	

CAN Transceiver		
L3	Chip Common Mode Choke Coils DLW32SH Series	
L3	Chip Common Mode Choke Coils DLW43SH Series	

Ethernet		
L4	Chip Common Mode Choke Coils DLW32MH Series	
L4	Chip Common Mode Choke Coils DLW43MH Series	

2 IPA (Intelligent parking assist)

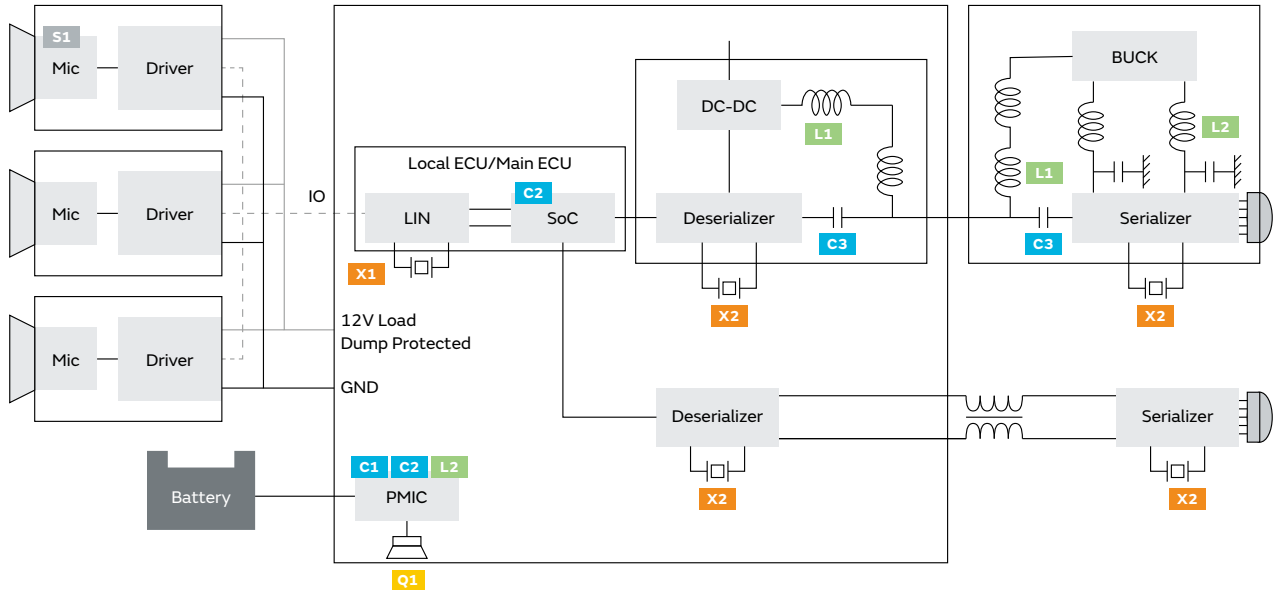
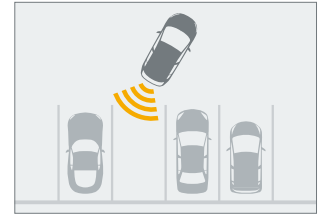

Mic	
S1	Ultrasonic Sensors MA58 Series

PMIC	
C1	Soft Termination Chip Multilayer Ceramic Capacitors for Automotive GCJ Series
C1	Metal Terminal Type Multilayer Ceramic Capacitors for Automotive KCM Series
C1	Chip Multilayer Ceramic Capacitors for Automotive GCM Series
C2	3 Terminals Low ESL Chip Multilayer Ceramic Capacitors for Automotive NFM Series
L2	Chip Inductors (Chip Coils) LQM/LQH/DFE Series
Q1	Piezoelectric Sounders PKLCS/PKMCS Series

SoC	
C2	3 Terminals Low ESL Chip Multilayer Ceramic Capacitors for Automotive NFM Series
C2	Chip Multilayer Ceramic Capacitors for Automotive GCM Series

PoC	
C3	Chip Multilayer Ceramic Capacitors for Automotive GCM Series
L1	Chip Ferrite Beads BLM Series
L1	Chip Inductors (Chip Coils) LQW18C/LQM18J Series
L1	Chip Inductors (Chip Coils) LQW32FT Series
L1	Chip Inductors (Chip Coils) LQH Series

DC-DC	
L2	Chip Inductors (Chip Coils) LQM/LQH/DFE Series

Timing Device	
X1	Ceramic Resonators CERALOCK CST Series
X2	Crystal Units XRC Series

3 Lidar

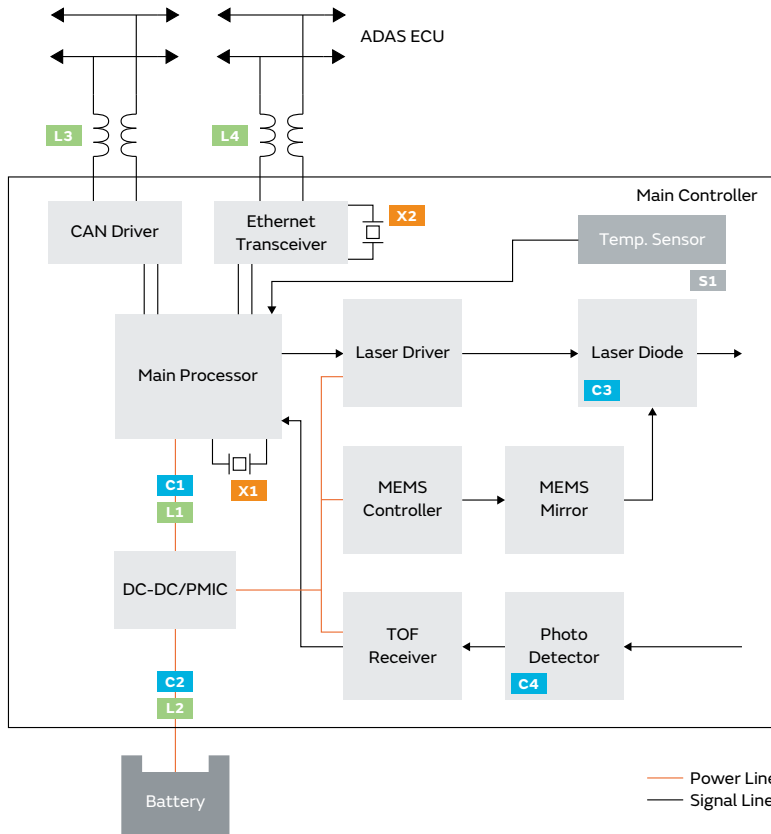
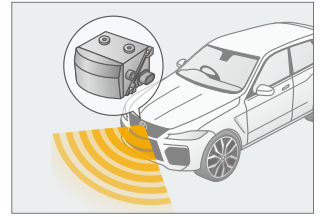

Battery Line

L2	Chip Common Mode Choke Coils DLW Series	
L2	Chip Ferrite Beads BLM Series	

Temperature Control

S1	Thermistors NCU Series	
----	---------------------------	--

Gate Driver

C3	3 Terminals Low ESL Chip Multilayer Ceramic Capacitors for Automotive NFM Series	
C3	Silicon Capacitors	

APD Bias Cap.

C4	Chip Multilayer Ceramic Capacitors for Automotive GCM Series	
C4	Soft Termination Chip Multilayer Ceramic Capacitors for Automotive GCJ Series	

CAN

L3	Chip Common Mode Choke Coils DLW32SH Series	
L3	Chip Common Mode Choke Coils DLW43SH Series	

Ethernet

L4	Chip Common Mode Choke Coils DLW32MH Series	
L4	Chip Common Mode Choke Coils DLW43MH Series	
X2	Crystal Units XRC Series	

Main Processor

X1	Ceramic Resonators CERALOCK CST Series	
X1	Crystal Units XRC Series	

DC-DC/PMIC

C1	3 Terminals Low ESL Chip Multilayer Ceramic Capacitors for Automotive NFM Series	
C1	Chip Multilayer Ceramic Capacitors for Automotive GCM Series	
L1	Chip Inductors (Chip Coils) LQM/LQH/DFE Series	

Battery Line

C2	MLSC Design Chip Multilayer Ceramic Capacitors for Automotive GCD Series	
C2	Soft Termination MLSC Design Chip Multilayer Ceramic Capacitors for Automotive GCE Series	
C2	Soft Termination Chip Multilayer Ceramic Capacitors for Automotive GCJ Series	
C2	Metal Terminal Type Multilayer Ceramic Capacitors for Automotive KCM Series	
C2	Chip Multilayer Ceramic Capacitors for Automotive GCM Series	
L2	Large-current Common Mode Choke Coils PLT10HH/PLT5BP Series	

4 Radar

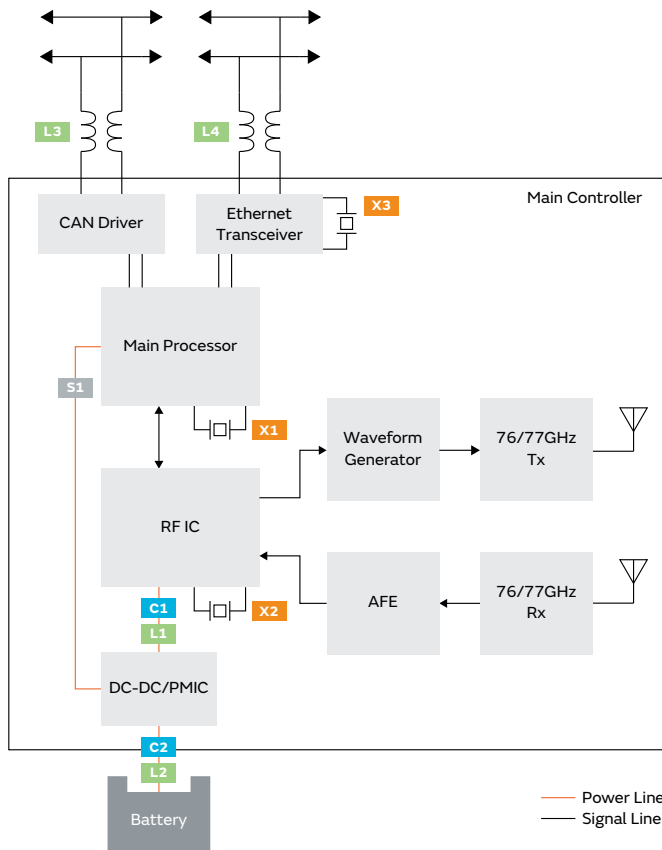
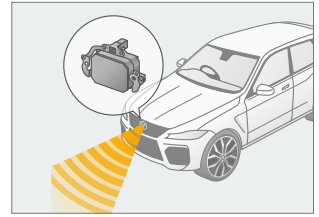

Battery Line		
L2	Chip Common Mode Choke Coils DLW Series	
L2	Chip Ferrite Beads BLM Series	

Temperature Control		
S1	Thermistors NCU Series	

RFIC		
X2	Crystal Units XRC Series	

CAN		
L3	Chip Common Mode Choke Coils DLW32SH Series	
L3	Chip Common Mode Choke Coils DLW43SH Series	

Ethernet		
L3	Chip Common Mode Choke Coils DLW32MH Series	
L3	Chip Common Mode Choke Coils DLW43MH Series	
X3	Crystal Units XRC Series	

Main Processor		
X1	Ceramic Resonators CERALOCK CST Series	
X1	Crystal Units XRC Series	

DC-DC/PMIC		
C1	3 Terminals Low ESL Chip Multilayer Ceramic Capacitors for Automotive NFM Series	
C1	Chip Multilayer Ceramic Capacitors for Automotive GCM Series	
L1	Chip Inductors (Chip Coils) LQM/LQH/DFE Series	

Battery Line		
C2	MLSC Design Chip Multilayer Ceramic Capacitors for Automotive GCD Series	
C2	Soft Termination MLSC Design Chip Multilayer Ceramic Capacitors for Automotive GCE Series	
C2	Soft Termination Chip Multilayer Ceramic Capacitors for Automotive GCJ Series	
C2	Metal Terminal Type Multilayer Ceramic Capacitors for Automotive KCM Series	
C2	Chip Multilayer Ceramic Capacitors for Automotive GCM Series	
L2	Large-current Common Mode Choke Coils PLT10HH/PLT5BP Series	

5 Front camera

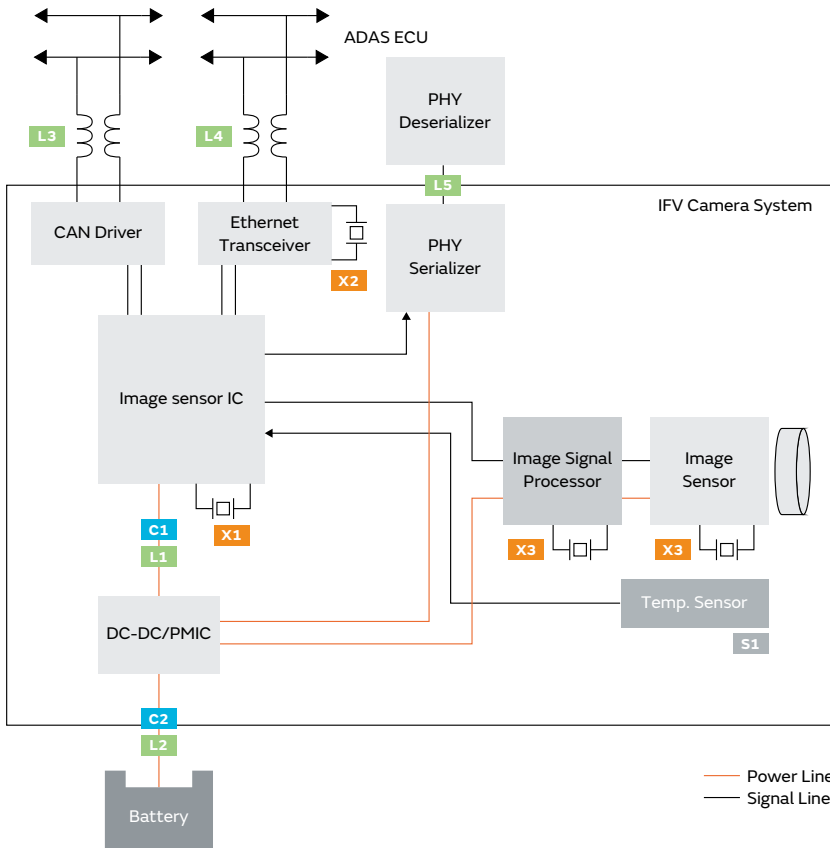
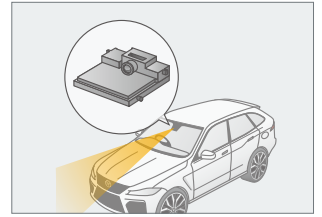

Image sensor IC	
X1	Crystal Units XRC Series

DC-DC/PMIC	
C1	3 Terminals Low ESL Chip Multilayer Ceramic Capacitors for Automotive NFM Series
C1	Chip Multilayer Ceramic Capacitors for Automotive GCM Series
L1	Chip Inductors (Chip Coils) LQM/LQH/DFE Series

Battery Line	
C2	MLSC Design Chip Multilayer Ceramic Capacitors for Automotive GCD Series
C2	Soft Termination MLSC Design Chip Multilayer Ceramic Capacitors for Automotive GCE Series
C2	Soft Termination Chip Multilayer Ceramic Capacitors for Automotive GCJ Series
C2	Metal Terminal Type Multilayer Ceramic Capacitors for Automotive KCM Series
C2	Chip Multilayer Ceramic Capacitors for Automotive GCM Series

Battery Line	
L2	Large-current Common Mode Choke Coils PLT10HH/PLT5BP Series
L2	Chip Common Mode Choke Coils DLW Series
L2	Chip Ferrite Beads BLM Series

Power over Coax	
L5	Chip Inductors (Chip Coils) LQW Series

Temperature Control	
S1	Thermistors NCU Series

Image Sensor/ISP	
X3	Crystal Units XRC Series

CAN	
L3	Chip Common Mode Choke Coils DLW32SH Series
L3	Chip Common Mode Choke Coils DLW43SH Series

Ethernet	
L4	Chip Common Mode Choke Coils DLW32MH Series
L4	Chip Common Mode Choke Coils DLW43MH Series
X2	Crystal Units XRC Series

Other

1 Automotive lighting

2 EPS (Electric power steering)

3 PKE / TPMS

4 Gateway / in-vehicle LAN

1 Automotive lighting

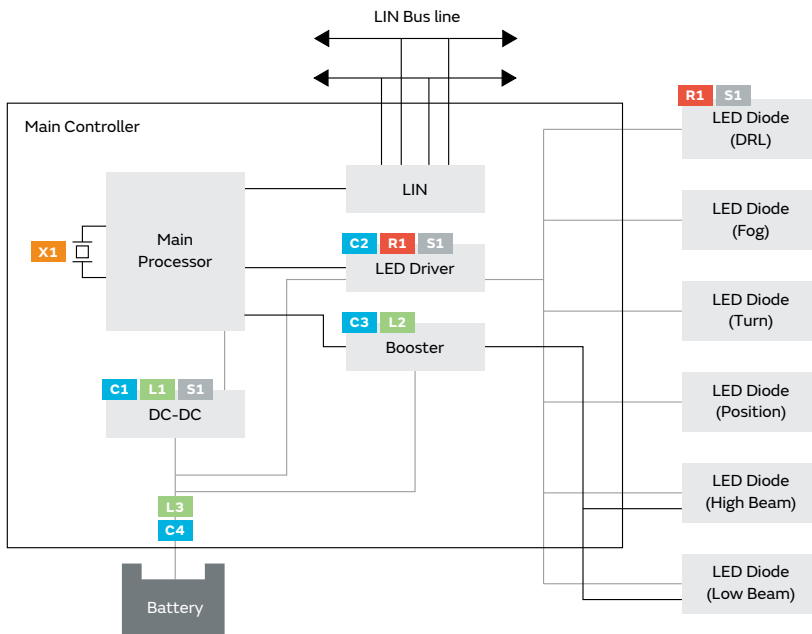
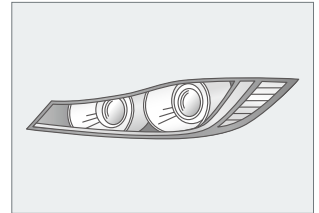

Booster	
C3	Chip Multilayer Ceramic Capacitors for Automotive GCM Series
L2	Power Inductors LQH Series

LED Diode (DRL)	
R1	Thermistors PRF/PRG Series
S1	Thermistors NCU Series

Primary	
C4	Metal Terminal Type Multilayer Ceramic Capacitors for Automotive KCM Series
L3	Chip Ferrite Beads BLM Series
L3	Large-current Common Mode Choke Coils PLT10HH/PLT5BP Series
L3	Chip Common Mode Choke Coils DLW Series

Timing Device	
X1	Ceramic Resonators CERALOCK CST Series

DC-DC	
C1	Soft Termination Chip Multilayer Ceramic Capacitors for Automotive GCJ Series
C1	Metal Terminal Type Multilayer Ceramic Capacitors for Automotive KCM Series
C1	Chip Multilayer Ceramic Capacitors for Automotive GCM Series
L1	Power Inductors LQH Series
S1	Thermistors NCU Series

LED Driver	
C2	Chip Multilayer Ceramic Capacitors for Automotive GCM Series
C2	Metal Terminal Type Multilayer Ceramic Capacitors for Automotive KCM Series
R1	Thermistors PRF/PRG Series
S1	Thermistors NCU Series

2 EPS (Electric power steering)

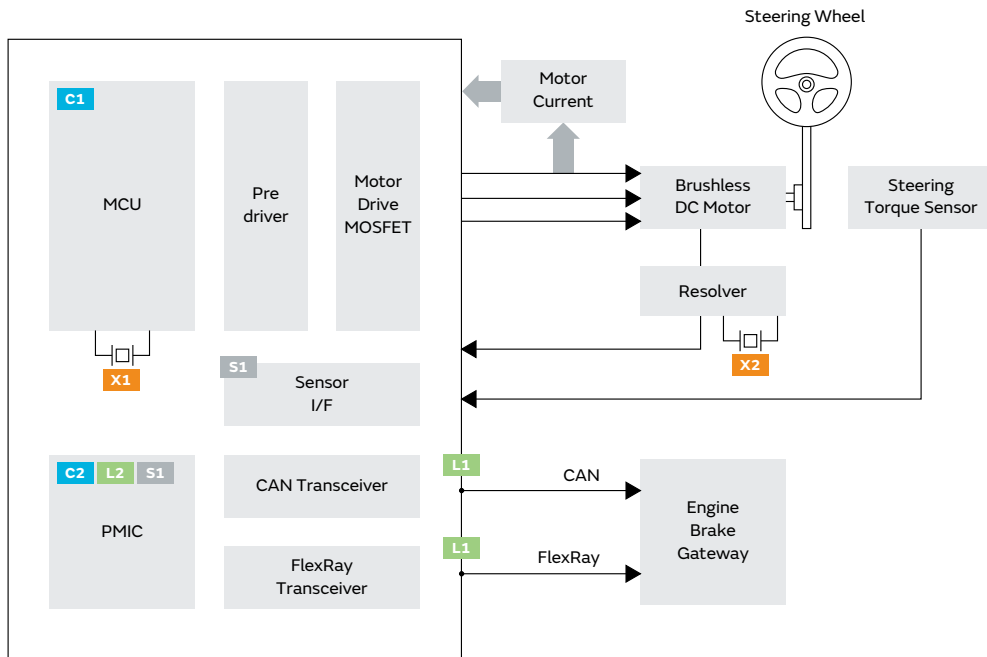
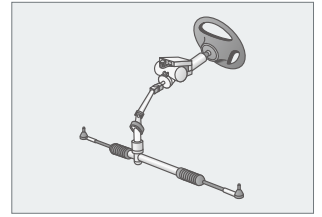

MCU

C1 Chip Multilayer Ceramic Capacitors for Automotive GCM Series

Timing Device

X1 Ceramic Resonators CERALOCK CST Series

X1 Crystal Units XRC Series

X2 Ceramic Resonators CERALOCK CST Series

PMIC

C2 Soft Termination Chip Multilayer Ceramic Capacitors for Automotive GCJ Series

C2 Metal Terminal Type Multilayer Ceramic Capacitors for Automotive KCM Series

C2 Chip Multilayer Ceramic Capacitors for Automotive GCM Series

L2 Chip Ferrite Beads BLM Series

S1 Thermistors NCU Series

PHY

L1 Chip Common Mode Choke Coils DLW32SH Series

L1 Chip Common Mode Choke Coils DLW43SH Series

Sensor I/F

S1 Thermistors NCU Series

3 PKE / TPMS

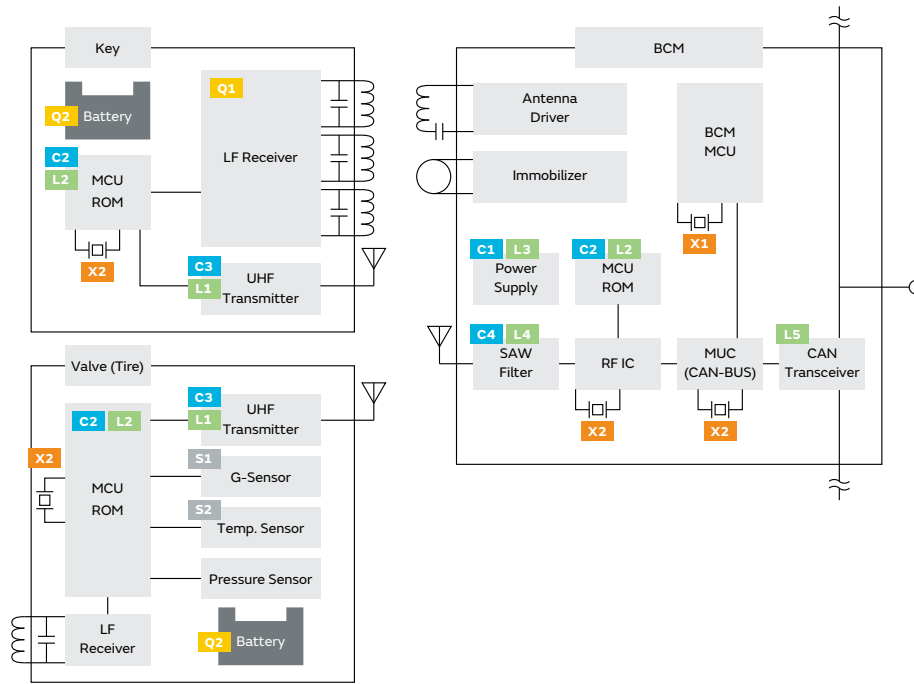
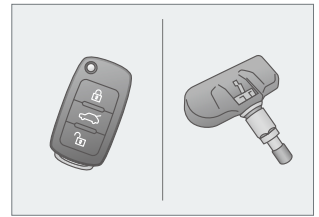

LF Receiver

Q1 Antenna Coil
SA3D12/SA3D14 Series

UHF Transmitter

C3 High Q Chip Multilayer Ceramic Capacitors for Automotive GCQ Series

L1 Chip Inductors (Chip Coils)
LQW/LQP/LQG/LQB Series

MCU ROM

L2 Chip Inductors (Chip Coils)
LQW/LQP/LQG/LQB Series

C2 Chip Multilayer Ceramic Capacitors for Automotive GCM Series

G-Sensor

S1 Chip Multilayer Ceramic Capacitors for Automotive GCM Series

Temp. Sensor

S2 Thermistors
NCU Series

Power Supply

C1 Soft Termination Chip Multilayer Ceramic Capacitors for Automotive GCJ Series

C1 Metal Terminal Type Multilayer Ceramic Capacitors for Automotive KCM Series

C1 Chip Multilayer Ceramic Capacitors for Automotive GCM Series

L3 Chip Inductors (Chip Coils)
LQM/LQH/DFE Series

L3 Chip Ferrite Beads
BLM Series

SAW Filter

C4 High Q Chip Multilayer Ceramic Capacitors for Automotive GCQ Series

L4 Chip Inductors (Chip Coils)
LQW/LQP/LQG/LQB Series

CAN Transceiver

L5 Chip Common Mode Choke Coils
DLW32SH Series

L5 Chip Common Mode Choke Coils
DLW43SH Series

Timing Device

X1 Ceramic Resonators
CERALOCK
CST Series

X2 Crystal Units
XRC Series

Battery

Q2 Coin Manganese Dioxide Lithium Batteries
Heat-resistant Type/
Extended Temperature Type

4 Gateway / in-vehicle LAN

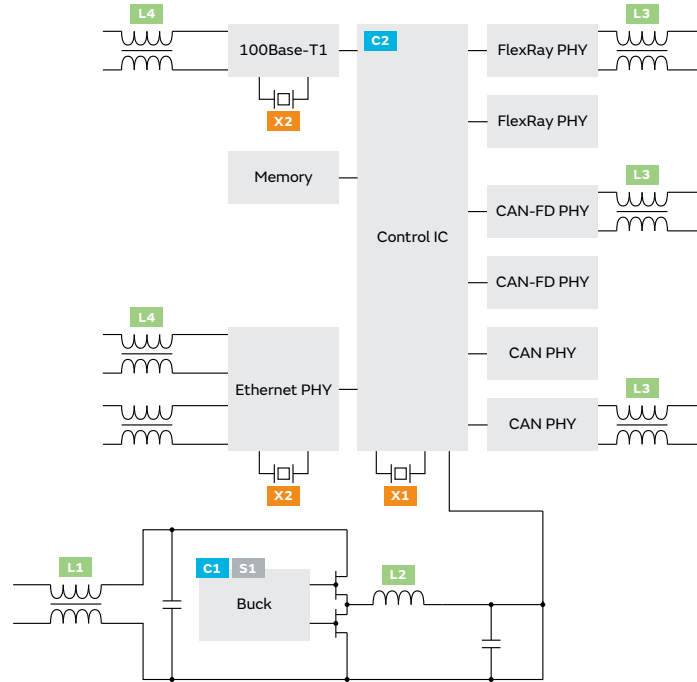
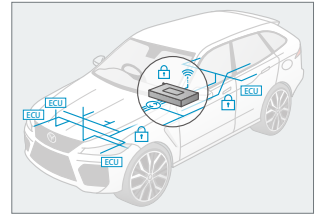

DC-DC	
C1	Soft Termination Chip Multilayer Ceramic Capacitors for Automotive GCJ Series
C1	Metal Terminal Type Multilayer Ceramic Capacitors for Automotive KCM Series
C1	Chip Multilayer Ceramic Capacitors for Automotive GCM Series
L1	Large-current Common Mode Choke Coils PLT10HH/PLT5BP Series
L1	Chip Common Mode Choke Coils DLW Series
L2	Chip Inductors (Chip Coils) LQM/LQH/DFE Series
S1	Thermistors NCU Series

Control IC	
C2	Chip Multilayer Ceramic Capacitors for Automotive GCM Series
C2	3 Terminals Low ESL Chip Multilayer Ceramic Capacitors for Automotive NFM Series

Timing Device	
X1	Ceramic Resonators CERALOCK CST Series
X2	Crystal Units XRC Series

FlexRay/CAN/CAN-FD	
L3	Chip Common Mode Choke Coils DLW32SH Series
L3	Chip Common Mode Choke Coils DLW43SH Series

OBC/Ethernet	
L4	Chip Common Mode Choke Coils DLW32MH Series
L4	Chip Common Mode Choke Coils DLW43MH Series

Motorcycle

E-Motorcycle

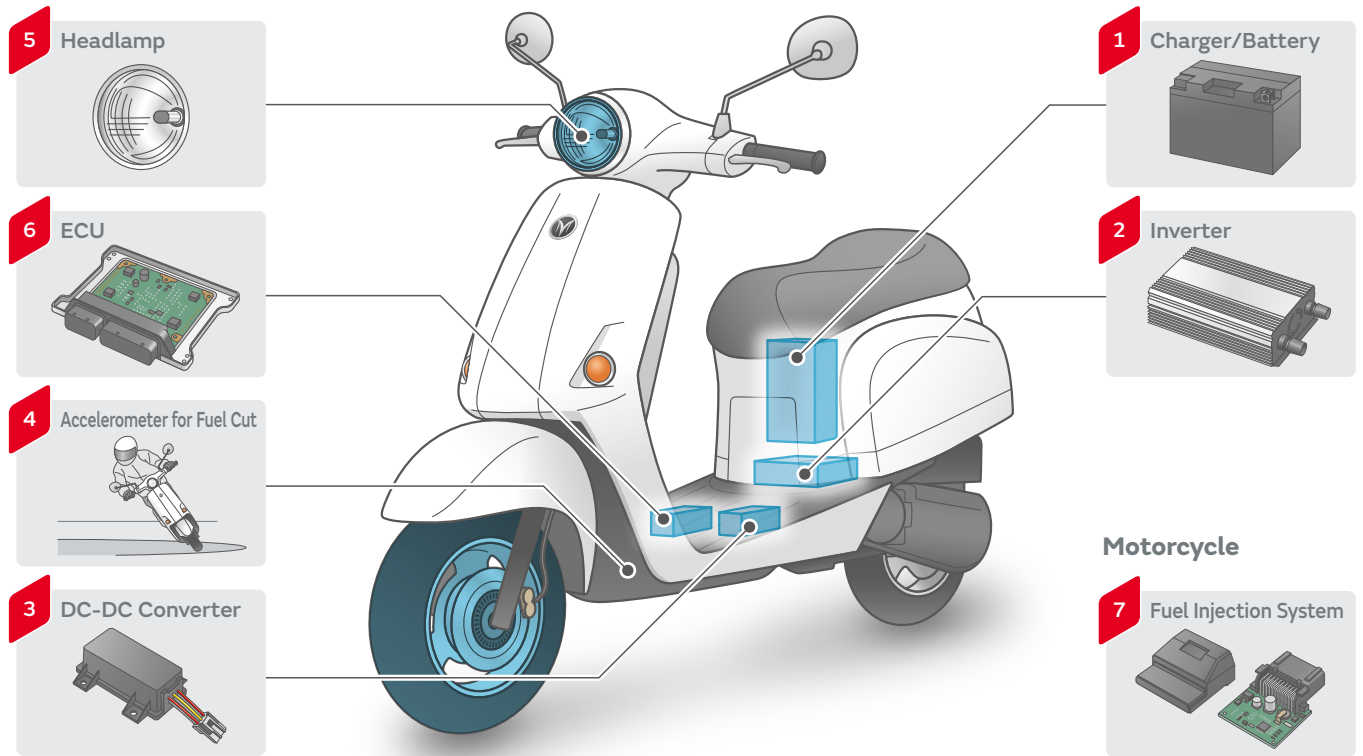













1 Charger/Battery

<p>Metal Terminal Type Multilayer Ceramic Capacitors for Automotive KCM Series</p>	<p>Chip Multilayer Ceramic Capacitors for Automotive GCM Series</p>	<p>Soft Termination Chip Multilayer Ceramic Capacitors for Automotive GCJ Series</p>	<p>Safety Standard Certified Lead Type Disc Ceramic Capacitors for Automotive DE6 Series</p>	<p>Ceramic Resonators CERALOCK CST Series</p>
<p>Crystal Units XRC Series</p>	<p>Large-current Common Mode Choke Coils PLT10HH/PLT5BP Series</p>	<p>Thermistors PRF/NCU Series</p>	<p>High Reliability Chip Ferrite Beads BLM_SH1/BH1/TH1/JH1 Series</p>	



2 Inverter

<p>Chip Multilayer Ceramic Capacitors for Automotive GCM Series</p>	<p>Soft Termination Chip Multilayer Ceramic Capacitors for Automotive GCJ Series</p>	<p>AgPd Termination Conductive Glue Mounting Chip Multilayer Ceramic Capacitors for Automotive GCG Series</p>	<p>Ni Plating + Pd Plating Termination Conductive Glue Mounting Chip Multilayer Ceramic Capacitors for Automotive GCB Series</p>	<p>Crystal Units XRC Series</p>
<p>150°C/ 200°C Operation Leaded MLCC for Automotive RH Series</p>	<p>Large-current Common Mode Choke Coils PLT10HH/PLT5BP Series</p>	<p>Ceramic Resonators CERALOCK CST Series</p>	<p>High Reliability Chip Ferrite Beads BLM_SH1/BH1/TH1/JH1 Series</p>	<p>Thermistors PRF/NCU Series</p>







3 DC-DC converter

<p>Non-Isolated DC-DC Converters MYPMA Series</p> 	<p>Metal Terminal Type Multilayer Ceramic Capacitors for Automotive KCM Series</p> 	<p>Soft Termination Chip Multilayer Ceramic Capacitors for Automotive GCJ Series</p> 	<p>Chip Multilayer Ceramic Capacitors for Automotive GCM Series</p> 	<p>AgPd Termination Conductive Glue Mounting Chip Multilayer Ceramic Capacitors for Automotive GCG Series</p> 
<p>Ni Plating + Pd Plating Termination Conductive Glue Mounting Chip Multilayer Ceramic Capacitors for Automotive GCB Series</p> 	<p>Ceramic Resonators CERALOCK CST Series</p> 	<p>High Reliability Chip Ferrite Beads BLM_SH1/BH1/TH1/JH1 Series</p> 	<p>Thermistors PRF/NCU Series</p> 	<p>Large-current Common Mode Choke Coils PLT10HH/PLT5BP Series</p> 
				<p>Crystal Units XRC Series</p> 
				<p>Chip Inductors (Chip Coils) LQM/LQH/DFE Series</p> 





4 Accelerometer for Fuel Cut

<p>Accelerometers SCA Series</p> 	<p>Gyro Sensors SCC Series</p> 	<p>Chip Multilayer Ceramic Capacitors for Automotive GCM Series</p> 	<p>Ceramic Resonators CERALOCK CST Series</p> 	<p>Metal Terminal Type Multilayer Ceramic Capacitors for Automotive KCM Series</p> 	<p>Soft Termination Chip Multilayer Ceramic Capacitors for Automotive GCJ Series</p> 
<p>AgPd Termination Conductive Glue Mounting Chip Multilayer Ceramic Capacitors for Automotive GCG Series</p> 	<p>Ni Plating + Pd Plating Termination Conductive Glue Mounting Chip Multilayer Ceramic Capacitors for Automotive GCB Series</p> 	<p>Crystal Units XRC Series</p> 	<p>Thermistors NCU Series</p> 	<p>High Reliability Chip Ferrite Beads BLM_SH1/BH1/TH1/JH1 Series</p> 	









5 Headlamp

<p>Chip Multilayer Ceramic Capacitors for Automotive GCM Series</p> 	<p>Ceramic Resonators CERALOCK CST Series</p> 	<p>Soft Termination Chip Multilayer Ceramic Capacitors for Automotive GCJ Series</p> 
<p>Crystal Units XRC Series</p> 	<p>High Reliability Chip Ferrite Beads BLM_SH1/BH1/TH1/JH1 Series</p> 	<p>Thermistors NCU/PRG Series</p> 

6 ECU

<p>Chip Ferrite Beads BLM Series</p> 	<p>Power Inductor LQH/DFE Series</p> 	<p>Thermistors PRF/NCU Series</p> 
<p>Ceramic Resonators CERALOCK CST Series</p> 	<p>Crystal Units XRC Series</p> 	

7 Fuel Injection ECU

<p>Metal Terminal Type Multilayer Ceramic Capacitors for Automotive KCM Series</p> 	<p>Chip Multilayer Ceramic Capacitors for Automotive GCM Series</p> 	<p>Soft Termination Chip Multilayer Ceramic Capacitors for Automotive GCJ Series</p> 	<p>Ceramic Resonators CERALOCK CST Series</p> 	<p>Ni Plating + Pd Plating Termination Conductive Glue Mounting Chip Multilayer Ceramic Capacitors for Automotive GCB Series</p> 
<p>AgPd Termination Conductive Glue Mounting Chip Multilayer Ceramic Capacitors for Automotive GCG Series</p> 	<p>Thermistors NXF/NXR Series</p> 	<p>High Reliability Chip Ferrite Beads BLM_SH1/BH1/TH1/JH1 Series</p> 	<p>Crystal Units XRC Series</p> 	

General Purpose

General Purpose

AEC-Q 200 Compliant Chip Multilayer Ceramic Capacitors for Infotainment	GRT Series	Coupling/Decoupling					125°C
Chip Multilayer Ceramic Capacitors for Automotive	GCM Series	Coupling/Decoupling				125°C	150°C
Soft Termination Chip Multilayer Ceramic Capacitors for Automotive	GCJ Series	Coupling/Decoupling/For Step-up				125°C	150°C
High Q Chip Multilayer Ceramic Capacitors for Automotive	GCQ Series	High Frequency Filter Circuit					125°C
MLSC Design Chip Multilayer Ceramic Capacitors for Automotive	GCD Series	Coupling/Decoupling/For Step-up					125°C
Soft Termination MLSC Design Chip Multilayer Ceramic Capacitors for Automotive	GCE Series	Coupling/Decoupling/For Step-up					125°C
3 Terminals Low ESL Chip Multilayer Ceramic Capacitors for Automotive	NFM Series	Noise Suppression/Decoupling					125°C
AgPd Termination Conductive Glue Mounting Chip Multilayer Ceramic Capacitors for Automotive	GCG Series	Coupling/Decoupling/For Step-up				125°C	150°C
Leaded MLCC for Automotive	RCE Series	Noise Suppression/Decoupling					125°C
150°C/200°C Operation Leaded MLCC for Automotive	RH Series	Noise Suppression/Decoupling	125°C	150°C	175°C	200°C	
Polymer Aluminum Electrolytic Capacitors	ECAS Series	Smoothing /Transient Backup				105°C	125°C
Chip Ferrite Beads	BLM Series	Noise Suppression	125°C	150°C	175°C		
Chip Ferrite Beads	NFZ Series	Noise Suppression				105°C	125°C
EMI Suppression Filters EMIFIL	NFL Series	Noise Suppression					125°C
EMI Suppression Filters EMIFIL	NFE Series	Noise Suppression					125°C
Chip Inductors (Chip Coils)	LQM/LQH/DFE Series	Voltage Conversion	85°C	105°C	125°C	150°C	
Chip Inductors (Chip Coils)	LQW Series	Matching/High Frequency Choke					125°C
Piezoelectric Sounders	PKLCS/PKMCS Series	Sound Component					125°C

Memo

SimSurfing

The best partner
for your circuit
design



SimSurfing is a web application which allows circuit designers to see our components' characteristics data, and to select the one that best suits the requirement.

- View and download data**
You can see various characteristics graphs for our products with easy operation, or download data files including s-parameter, spice models, etc.
- Simulate circuit conditions**
Simsurfing includes advanced equivalent circuit models which show the characteristics data close to actual measurement (for some components including MLCC & RF inductors).
- Compare characteristics**
Easily compare characteristics data on the same graph.

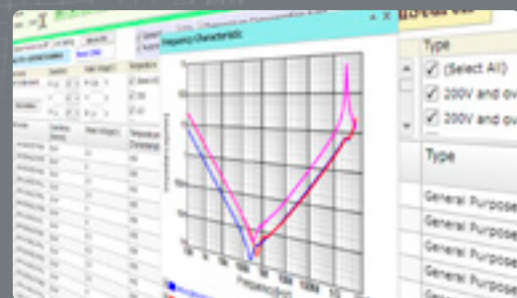
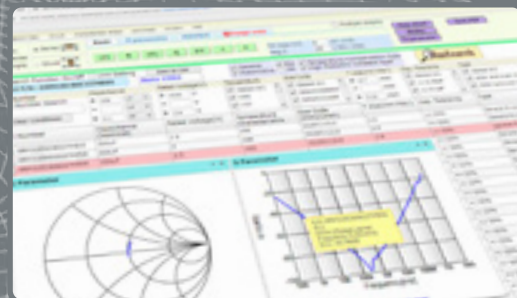

For more information about SimSurfing visit
www.murata.com/tool/simsurfing
or visit the SimSurfing site directly at
ds.murata.co.jp/simsurfing/?lcid=en-us

muRata

INNOVATOR IN ELECTRONICS

K70E.pdf

Jan.6,2021

Index

B	B4F Baluns.....	73	G	GJ4 Low Distortion Chip Multilayer Ceramic Capacitors for General Purpose.....	13	M	MHM Ozonizer Modules Ionissimo.....	103	
	B5F Baluns.....	73		GJM High Q Chip Multilayer Ceramic Capacitors for General Purpose ($\leq 100\text{Vdc}$).....	9		MHR High Voltage Resistors.....	64	
	BLA Chip Ferrite Bead.....	43		GMA Wire Bonding Mount Multilayer Microchip Capacitors for General Purpose.....	14		MM Microwave Connectors.....	74	
	BLE Application Specified Noise Filter.....	46		GMD Wire Bonding/AuSn Soldering Mount Chip Multilayer Ceramic Capacitors for General Purpose.....	15		MP FORTELION Battery System.....	91	
	BLF Frequency Specified Filter.....	45		GQM High Q Chip Multilayer Ceramic Capacitors for General Purpose ($> 100\text{Vdc}$).....	10		MPA Power supplies for LED lighting.....	85	
	BLM Chip Ferrite Bead.....	43		GR3 High Effective Capacitance & High Ripple Current Chip Multilayer Ceramic Capacitors for General Purpose.....	8		MPL Ballast Power Supplies, Power supplies for LED lighting.....	85	
	BLT Chip Ferrite Bead.....	44		GR4 Chip Multilayer Ceramic Capacitors for Ethernet LAN and primary-secondary coupling of DC-DC converters.....	9		MR AMR Sensors (Magnetic Sensors).....	78	
	BN Block Type EMIFIL.....	48		GR4 Chip Multilayer Ceramic Capacitors for Splitter Circuit of G-Fast, xDSL.....	9		MY DC-DC Converters.....	83	
C	CL Single-Layer Microchip Capacitors.....	32		GRJ Soft Termination Chip Multilayer Ceramic Capacitors for General Purpose.....	8	N	MZB Microblowers.....	101	
	CR Coin Manganese Dioxide Lithium Batteries.....	93		GRM Chip Multilayer Ceramic Capacitors for General Purpose.....	6		NC NTC Thermistors.....	78, 80	
	CS Ceramic Resonators CERALOCK.....	67		GRT AEC-Q200 Compliant Chip Multilayer Ceramic Capacitors for Infotainment.....	15		NF Application Specified Noise Filter, LC Combined Filter, Common Mode Noise Filter.....	45, 46, 47	
	CT TMR Sensors (Magnetic Sensors).....	78		H	HEAWS Inductors (Coils).....	61	NFM 3 Terminals Low ESL Chip Multilayer Ceramic Capacitors for General Purpose.....	12	
	CT Small Lithium ion Secondary Batteries.....	89		I	IJ FORTELION Battery System.....	91	NFM 3 Terminals Low ESL Chip Multilayer Ceramic Capacitors for Infotainment.....	17	
D	D5 Inductors (Coils).....	54		IR Pyroelectric Infrared Sensors.....	78		NFM 3 Terminals Low ESL Chip Multilayer Ceramic Capacitors for Automotive.....	20	
	D6 Inductors (Coils).....	54		K	KC3 High Effective Capacitance & High Allowable Ripple Current Metal Terminal Type Multilayer Ceramic Capacitors for Automotive.....	21	NX NTC Thermistors.....	78, 81	
	DE1 Safety Standard Certified Lead Type Disc Ceramic Capacitors for General Purpose / IEC60384-14 Class X1/Y1.....	26			KCA Safety Standard Certified Metal Terminal Type Multilayer Ceramic Capacitors for Automotive.....	21	O	OK DC-DC Converters.....	84
	DE2 Safety Standard Certified Lead Type Disc Ceramic Capacitors for General Purpose / IEC60384-14 Class X1/Y2.....	27			KCM Metal Terminal Type Multilayer Ceramic Capacitors for Automotive.....	21	P	PKB Piezoelectric Buzzers.....	99
	DE6 Safety Standard Certified Lead Type Disc Ceramic Capacitors for Automotive.....	30			KR3 High Effective Capacitance & High Allowable Ripple Current Metal Terminal Type Multilayer Ceramic Capacitors for General Purpose.....	14		PKL Piezoelectric Sounders.....	98
	DEM Inductors (Coils).....	53			KRM Metal Terminal Type Multilayer Ceramic Capacitors for General Purpose.....	14		PKM Piezoelectric Sounders.....	98, 99
	DF Dielectric Filters GIGAFIL.....	70		L	LDB Baluns.....	72		PLT Common Mode Choke Coil.....	47, 49
	DFE Inductors (Coils).....	52			LDC Couplers.....	73		PR PTC Thermistors POSISTOR.....	78, 82
	DG Inductors (Coils).....	54			LDD Chip Multilayer Hybrid Dividers.....	73	R	RCE Leaded MLCC for Automotive.....	28
	DK1 Safety Standard Certified Resin Molding SMD Type Ceramic Capacitors for General Purpose.....	30			LDJ Couplers.....	73		RDE Leaded MLCC for General Purpose.....	24
	DL Common Mode Choke Coil.....	47			LDM Baluns.....	72		RHE 150°C Operation Leaded MLCC for Automotive.....	29
	DS Noise Suppression Filters (Lead Type).....	49			LFB Chip Multilayer LC Filters.....	71		RHS 200°C Operation Leaded MLCC for Automotive.....	30
	DS1 Inductors (Coils).....	54			LFD Chip Multilayer Diplexers.....	74		RU Thin Film Circuit Substrates (RUSUB).....	34
	DS7 Inductors (Coils).....	54			LFL Chip Multilayer LC Filters.....	71	S	SA3 Antenna Coils.....	72
	DXP Baluns.....	73			LFI FORTELION 24V Battery Module.....	90		SAF SAW Filters for Mobile Communications.....	70
	DXW Baluns.....	73			LLA 8 Terminals Low ESL Chip Multilayer Ceramic Capacitors for General Purpose.....	12		SAW SAW Filters for Mobile Communications.....	70
E	ECAS Polymer Aluminum Electrolytic Capacitors.....	31			LLL LW Reversed Low ESL Chip Multilayer Ceramic Capacitors for General Purpose.....	11		SAY SAW Filters for Mobile Communications.....	69
F	FC Inductors (Coils).....	54			LLM 10 Terminals Low ESL Chip Multilayer Ceramic Capacitors for General Purpose.....	12		SCA Accelerometers.....	78
	FD Inductors (Coils).....	54			LLR LW Reversed Controlled ESR Low ESL Chip Multilayer Ceramic Capacitors for General Purpose.....	12		SCA Inclinometers.....	78
	FHA Film Capacitors.....	42			LQ Inductors (Coils).....	52, 59, 61		SCC Gyro Sensors.....	78
	FSDVA Inductors (Coils).....	62			LR Standard Alkaline Manganese Batteries, High Drain Alkaline Manganese Batteries.....	97		SCR Inclinometers.....	78
G	GA2 Based on the Electrical Appliance and Material Safety Law of Japan Chip Multilayer Ceramic Capacitors for General Purpose.....	10			LXMS RFID tag.....	104		SCR Gyro Sensors.....	78
	GA3 Safety Standard Certified Chip Multilayer Ceramic Capacitors for General Purpose.....	10			LXRW Variable Capacitors.....	36		SR Standard Silver Oxide Batteries, High Drain Silver Oxide Batteries.....	96, 97
	GC3 High Effective Capacitance & High Ripple Current Chip Multilayer Ceramic Capacitors for Automotive.....	18			LXTB RFID tag.....	104	U	UCMH Common Mode Choke Coil.....	47
	GCB Ni Plating + Pd Plating termination Conductive Glue Mounting Chip Multilayer Ceramic Capacitors for Automotive.....	22			M	MA Ultrasonic Sensors.....	78	US Laminated Type Lithium Ion Secondary Batteries.....	86
	GCD MLSC Design Chip Multilayer Ceramic Capacitors for Automotive.....	20			MHM Ionizer Modules Ionissimo.....	102	US Cylindrical Type Lithium Ion Secondary Batteries.....	89	
	GCE Soft Termination MLSC Design Chip Multilayer Ceramic Capacitors for Automotive.....	20					WM MEMS Resonator.....	66	
	GCG AgPd Termination Conductive Glue Mounting Chip Multilayer Ceramic Capacitors for Automotive.....	22					X	XD Crystal Filters.....	69
	GCH Chip Multilayer Ceramic Capacitors for Implantable Medical devices (Non Life support circuit).....	23						XR Crystal Units.....	66
	GCI Soft Termination Chip Multilayer Ceramic Capacitors for Automotive.....	19					Z	ZRA Low Acoustic Noise Chip Multilayer Ceramic Capacitors on Interposer Board for General Purpose.....	13
	GCM Chip Multilayer Ceramic Capacitors for Automotive.....	17						ZRB Low Acoustic Noise Chip Multilayer Ceramic Capacitors on Interposer Board for General Purpose.....	13
	GCQ High Q Chip Multilayer Ceramic Capacitors for Automotive.....	20						5CCEG Inductors (Coils).....	62
								7B Piezoelectric Diaphragms.....	99
								935* Silicon Capacitors.....	36
								939* Silicon Capacitors.....	36

Global Locations

For details please visit www.murata.com



⚠ Note

1 Export Control

For customers outside Japan

Murata requests customers to ensure that no Murata products are used or sold, through any channels, for use in the design, development, production, utilization, maintenance or operation of, or otherwise contribution to Weapons of Mass Destruction (nuclear, chemical or biological weapons or missiles), conventional weapons, or items specially designed for them.

For customers in Japan:

For products which are controlled items subject to the "Foreign Exchange and Foreign Trade Law" of Japan, the export license specified by the law is required for export.

2 Please contact our sales representatives or product engineers before using the products in this catalog for the applications listed below, which require especially high reliability for the prevention of defects which might directly damage a third party's life, body or property, or when one of our products is intended for use in applications other than those specified in this catalog.

- ① Aircraft equipment
- ② Aerospace equipment
- ③ Undersea equipment
- ④ Power plant equipment
- ⑤ Medical equipment
- ⑥ Transportation equipment (vehicles, trains, ships, etc.)
- ⑦ Traffic signal equipment
- ⑧ Disaster prevention / crime prevention equipment
- ⑨ Data-processing equipment
- ⑩ Application of similar complexity and/or reliability requirements to the applications listed above

3 Product specifications in this catalog are as of September 2020. They are subject to change or our products in it may be discontinued without advance notice. Please check with our sales representatives or product engineers before ordering. If there are any questions, please contact our sales representatives or product engineers.

4 Please read rating and ⚠CAUTION (for storage, operating, rating, soldering, mounting and handling) in this catalog to prevent smoking and/or burning, etc.

5 This catalog has only typical specifications. Therefore, please approve our product specifications or transact the approval sheet for product specifications before ordering.

6 Please note that unless otherwise specified, we shall assume no responsibility whatsoever for any conflict or dispute that may occur in connection with the effect of our and/or a third party's intellectual property rights and other related rights in consideration of your use of our products and/or information described or contained in our catalogs. In this connection, no representation shall be made to the effect that any third parties are authorized to use the rights mentioned above under licenses without our consent.

7 No ozone depleting substances (ODS) under the Montreal Protocol are used in our manufacturing process.

Murata Manufacturing Co., Ltd.

www.murata.com

muRata
INNOVATOR IN ELECTRONICS

X-ON Electronics

Largest Supplier of Electrical and Electronic Components

Click to view similar products for [RF Cable Assemblies](#) category:

Click to view products by [Murata](#) manufacturer:

Other Similar products are found below :

[73-6352-10](#) [73-6353-3](#) [73-6364-6](#) [R285001001](#) [R288940004](#) [145111-05-12.00](#) [1661-C-24](#) [1801171170914KE](#) [24P104C24J1-012](#)
[24P104C24P1-006](#) [24P104C24P1-018](#) [24P204C24J1-003](#) [172-2150-EX](#) [1800920920914PJ](#) [FCB-3030-ALT](#) [21117-046](#) [21117-050](#) [PCX-24-](#)
[50](#) [24P103C24P2-003](#) [25P203C25P2-003](#) [PTWY-24-78](#) [R284008001](#) [R285001021](#) [R285426000](#) [R288940003](#) [R288940008](#) [RF179-74BJ3-](#)
[77RP1-0305](#) [4814-BB-24](#) [5260-72](#) [JT2N1-CL1-1F](#) [DLP-COAX1](#) [4814-K-48](#) [115101-09-06.00](#) [MXHT83QE3000](#) [CCNTN2-MM-LL335-26](#)
[73-6351-25](#) [73-6352-3](#) [73-6353-25](#) [1800920920610PJ](#) [GD0BQ0BQ024.0](#) [1-3636-600-5210](#) [TL8A-11SMA-11SMA-01500-51](#)
[R284C0351060](#) [R288940009](#) [R284C0351028](#) [R288940002](#) [9702-1SL-1](#) [PT82NSMA](#) [73-6353-10](#) [R285020301W](#)